

Fisher-Price®

Kick & Drive Gym™



Infant Gym



Toddler Driver

Product Number: 73739

Please keep this instruction sheet for future reference,
as it contains important information.

Adult assembly is required.

Tool required for assembly and battery installation:

Phillips screwdriver (not included).

Requires three "C" (LR14) alkaline batteries for operation (not included).

Product features and decorations may vary from the pictures above.

**Brilliant
BASICS**

Discover what's possible™... www.fisher-price.com

Download from Www.Somanuals.com. All Manuals Search And Download.



WARNING

To prevent entanglement injury, **NEVER** place gym in a crib or playpen. **NEVER** add strings, ties or other products to this item.



CAUTION

This product contains small parts in its unassembled state. Adult assembly is required.

Parts



Windshield

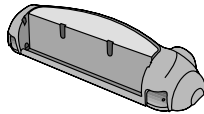

Bumper

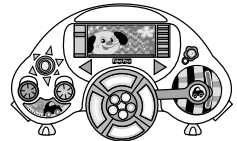

Dash Board



3 Rings

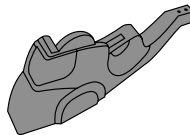

2 Bases



2 Arms



Mirror



2 Keys



Kickplate

FASTENERS SHOWN ACTUAL SIZE

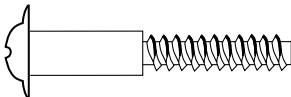

#8 x 1³/₈" Washer Head Screw - 2

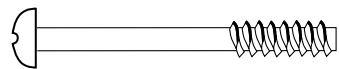

#8 x 1⁹/₁₆" Screw - 8

Battery Installation

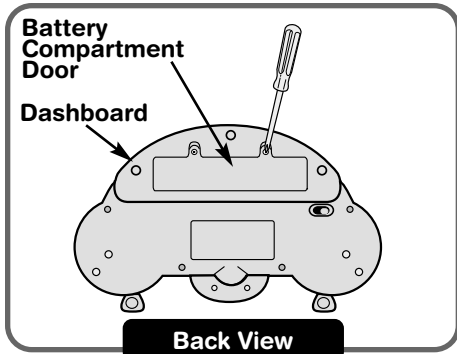

- Locate the battery compartment door on the back of the dashboard.
- Loosen the screws in the battery compartment door with a Phillips screwdriver. Remove the battery compartment door.
- Insert three "C" (LR14) **alkaline** batteries, as indicated inside the battery compartment.
- Close the battery compartment door and tighten the screws with a Phillips screwdriver. Do not over-tighten.

Hint: When lights or sounds from this toy become faint or stop, it's time for an adult to change the batteries!

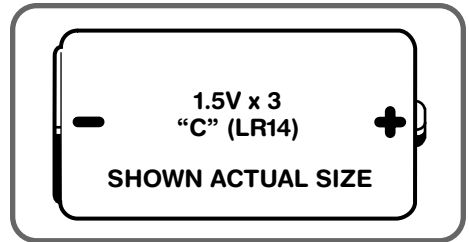

Battery Safety Information

- Batteries may leak fluids that can cause a chemical burn injury or ruin your toy. To avoid battery leakage:
- Do not mix old and new batteries or batteries of different types: alkaline, standard (carbon-zinc) or rechargeable (nickel-cadmium).
- Insert batteries as indicated inside the battery compartment.
- Remove batteries during long periods of non-use. Always remove exhausted batteries from the toy. Dispose of batteries safely. Do not dispose of batteries in a fire. The batteries may explode or leak.
- Never short-circuit the battery terminals.
- Use only batteries of the same or equivalent type, as recommended.
- Do not charge non-rechargeable batteries.
- Remove rechargeable batteries from the toy before charging.
- If removable, rechargeable batteries are used, they are only to be charged under adult supervision.

Assembly

1

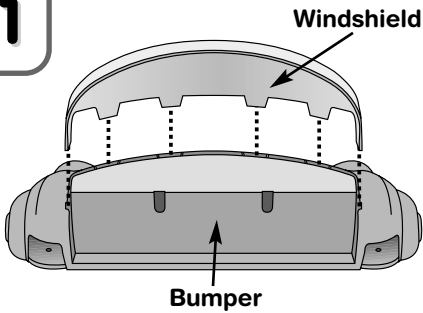

- Fit the tabs on the bottom of the windshield into the slots on the bumper.
- Push down on the windshield to "snap" it into place.

2

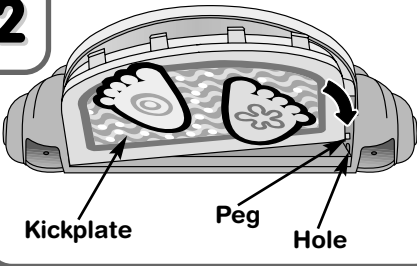

- Position the kickplate so that the decorated side faces you.
- Fit one of the pegs on the bottom of the kickplate into one of the holes near the base of the bumper.
- Bend the kickplate slightly to fit the other peg into the corresponding hole on the other end of the bumper.

3

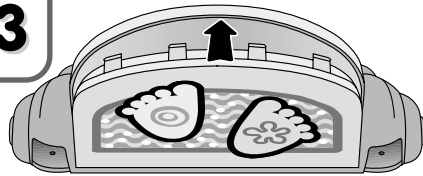

- Push the tabs on the kickplate into the slots on the windshield and "snap" the two together.

4

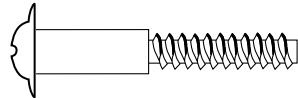
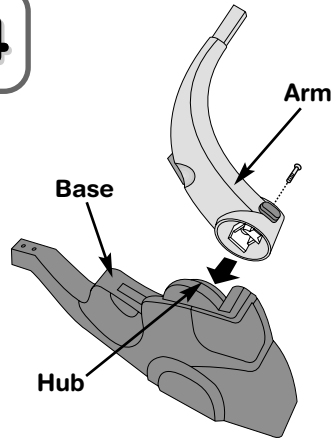

#8 x 1³/₈" Washer Head Screw
Shown Actual Size

- Fit an arm to the hub on a base as shown.
- Insert the #8 x 1³/₈" washer head screw through the hole in the arm and into the base. Tighten the screw with a Phillips screwdriver. Do not over-tighten.
- Repeat this procedure to attach the other arm and base.

5

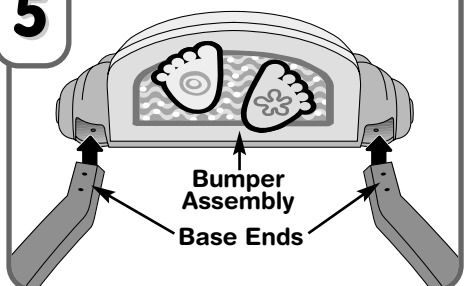

- Insert the ends of each base into the square slots in the bumper assembly as shown.

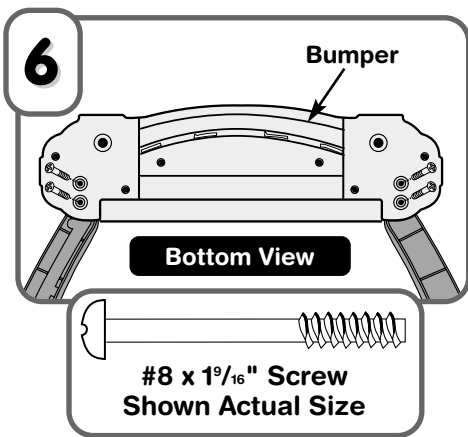

- Turn the bumper over, so that the bottom is facing you.
- Be sure the screw holes in the base and bumper assembly are aligned.
- Insert four **#8 x 1⁹/₁₆"** screws through the holes in the bumper assembly and into the base. Tighten the screws with a Phillips screwdriver. Do not over-tighten.

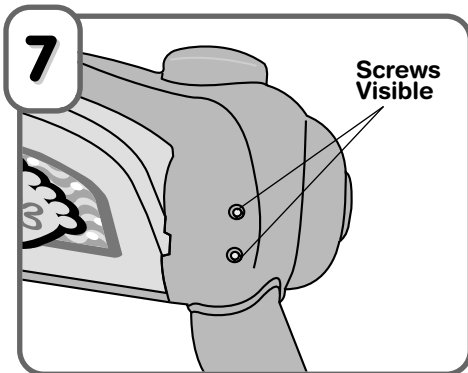

- Look into the two holes on each end of the bumper. If the screws were inserted properly in this step, they should be visible in the holes.
- If the screws are not visible, remove the four screws. Repeat step 6 making sure the end of the base is fully inserted into the bumper assembly with no gaps between the two parts.

Hint: You may feel some resistance. Press firmly.

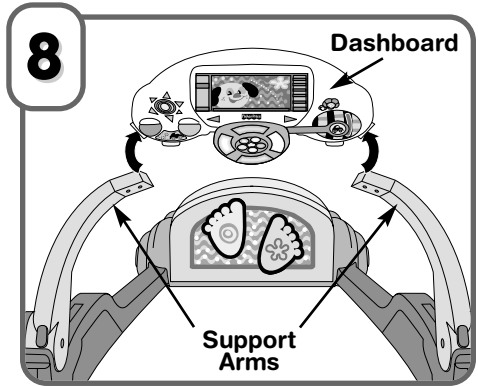

- Fit the ends of the arms into the holes in the bottom of the dashboard.

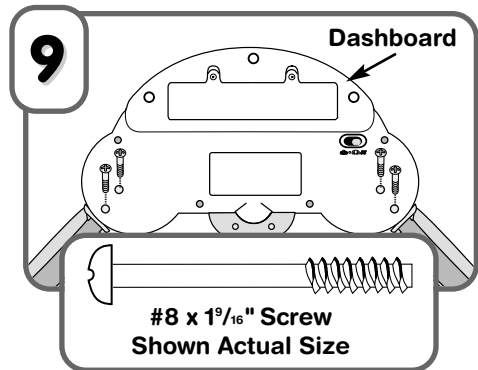

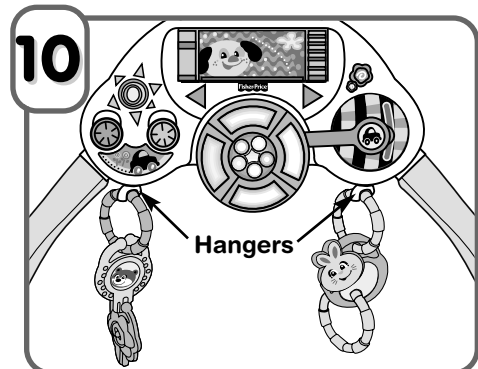

- From the back of the dashboard, insert four **#8 x 1⁹/₁₆"** screws through the holes in the dashboard and into the arms. Tighten the screws with a Phillips screwdriver. Do not over-tighten.



- Fit a ring into the hole in the mirror.
- Clip a ring to each of the hangers.
- Attach a ring or key to the ring or mirror.

Hint: Adjust the height of these toys, as baby grows.

Infant Gym

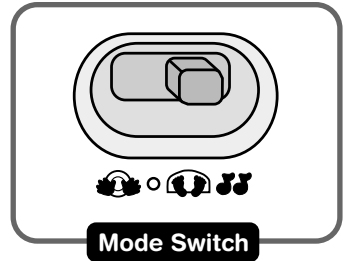
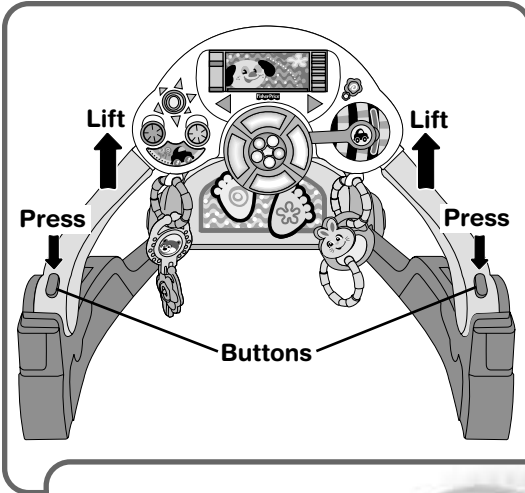

- To convert to **Infant Gym** mode, press the button on each support arm and, at the same time, lift the arch until it "clicks" into position.
- Slide the mode switch to  gym mode.
- When your baby kicks the toy, turns the steering wheel or hits the dangling toys, your child hears a fun song and sees blinking lights and a spinning roller.
- Slide the mode switch to  long-play gym mode. Enjoy the same features as in gym mode but with longer music and lights.
- Slide the mode switch to  to turn the power off.

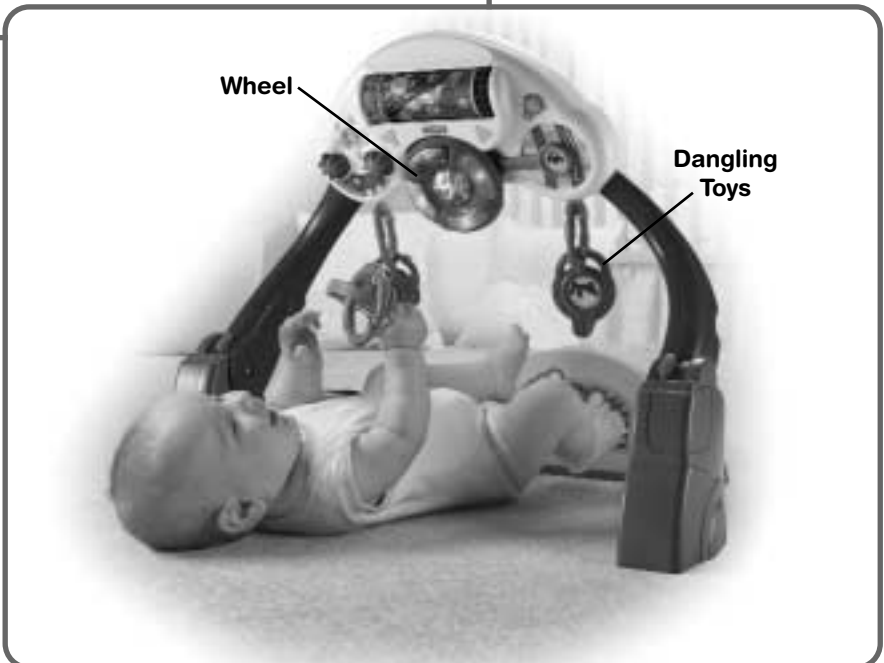

Hint: If your child is not actively playing with this toy, it turns off automatically after a few minutes (sleep mode).



Toddler Driver

- To convert to **Toddler Driver** mode, press the button on each support arm and, at the same time, push the arch down until it "clicks" into position.
- Slide the mode switch to  driver mode.
- When your toddler kicks the toy, turns the steering wheel or grabs the dangling toys, your child hears driving sound effects, a song and sees blinking lights and a spinning roller.
- Slide the mode switch to  to turn power off.

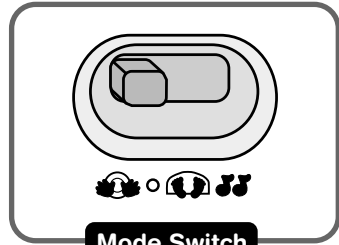
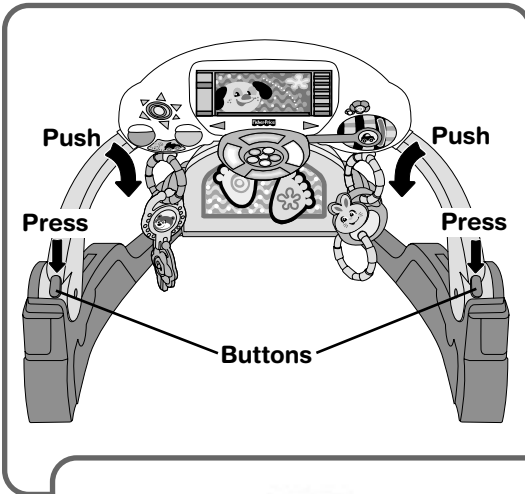

Hint: If your child is not actively playing with this toy, it turns off automatically after a few minutes (sleep mode).



Care

- Periodically check all screws and tighten as required. Periodically check plastic parts for cracks and broken pieces.
- Wipe all parts of this toy with a clean cloth dampened with a mild soap and water solution. Do not immerse this toy.
- This toy has no consumer serviceable parts. Do not take this toy apart.

FCC Note (United States Only)

Note: This equipment has been tested and found to comply with the limits for a Class B digital device, pursuant to Part 15 of the FCC Rules. These limits are designed to provide reasonable protection against harmful interference in a residential installation. This equipment generates, uses and can radiate radio frequency energy and, if not installed and used in accordance with the instructions, may cause harmful interference to radio communications. However, there is no guarantee that interference will not occur in a particular installation. If this equipment does cause harmful interference to radio or television reception, which can be determined by turning the equipment off and on, the user is encouraged to try to correct the interference by one or more of the following measures:

- Reorient or relocate the receiving antenna.
- Increase the separation between the equipment and receiver.
- Consult the dealer or an experienced radio/TV technician for help.

Note: Changes or modifications not expressly approved by the manufacturer responsible for compliance could void the user's authority to operate the equipment.

Consumer Information

Questions? We'd like to hear from you!

Call Fisher-Price® Consumer Relations, toll-free at **1-800-432-5437**, 8 AM - 6 PM EST Monday through Friday. Hearing-impaired consumers using TTY/TDD equipment, please call 1-800-382-7470. Or, write to: Fisher-Price® Consumer Relations, 636 Girard Avenue, East Aurora, New York 14052.

For other countries, outside the United States:

Canada: call **1-800-567-7724**, or write to: Mattel Canada Inc, 6155 Freemont Blvd., Mississauga, Ontario L5R 3W2.

Great Britain: telephone 01628 500302.

Australia: Mattel Australia Pty. Ltd., 658 Church Street, Locked Bag #870, Richmond, Victoria 3121 Australia. Consumer Advisory Service 1300 135 312.

New Zealand: 16-18 William Pickering Drive, Albany 1331, Auckland.

Asia: Mattel East Asia Ltd, Room 1106, South Tower, World Finance Centre, Harbour City, Tsimshatsui, HK, China.

Free Manuals Download Website

<http://myh66.com>

<http://usermanuals.us>

<http://www.somanuals.com>

<http://www.4manuals.cc>

<http://www.manual-lib.com>

<http://www.404manual.com>

<http://www.luxmanual.com>

<http://aubethermostatmanual.com>

Golf course search by state

<http://golfingnear.com>

Email search by domain

<http://emailbydomain.com>

Auto manuals search

<http://auto.somanuals.com>

TV manuals search

<http://tv.somanuals.com>