

**Fisher-Price®**

# Swing 'n Meals™

It's a swing. It's a two-position high chair.

Use it as a traditional swing to soothe and entertain baby with head-to-toe swinging motion and then convert it to a high chair!



**Swing**



**High Chair**

Product features and decorations may vary from the photos above.

**Model Number: 79739**

Please keep this instruction sheet for future reference, as it contains important information.

Read all instructions BEFORE assembly and USE of product.

Adult assembly is required.

Tool needed for assembly: Phillips Screwdriver (not included).

Requires three "D" (LR20) **alkaline** batteries for swing operation (not included).

Maximum weight limit for swing use: 25 lbs. (11.35 kg)

**IMPORTANT!** The maximum weight limit for use as a swing is 25 lbs.  
If your child weighs less than 25 lbs., but is really active and appears to be able to climb out of the swing, immediately discontinue its use.

[www.fisher-price.com](http://www.fisher-price.com)

## Warnings

### **WARNING**

#### **Swing**

- To prevent falls when using the swing, never use with an active child who may be able to climb out of the seat.
- Never leave child unattended.
- To prevent serious injury or death from falls or sliding out, always use the restraint system. Never rely on the tray to restrain child.

#### **High Chair**

##### **Prevent serious injury or death from falls or sliding out.**

- The child should be secured in the high chair at all times by the restraining system. The restraint belts must be adjusted to fit your child snugly. The tray is not designed to hold the child in the chair.
- Always keep child in view while in the high chair.
- Never leave child unattended.
- It is recommended that the product is used as a high chair only by children capable of sitting upright unassisted.

## Consumer Information

Occasionally a consumer may experience a problem with one of our products. If this should happen please call us, toll-free, rather than return this product to the store. Usually we can solve the problem on the telephone or by sending you replacement parts. Please call Fisher-Price® Consumer Relations, toll-free at **1-800-432-KIDS**, 8 AM - 6 PM EST Monday through Friday. Hearing-impaired consumers using TTY/TDD equipment, please call 1-800-382-7470.

Or, write to: Fisher-Price® Consumer Relations, 636 Girard Avenue, East Aurora, New York 14052.

# Parts

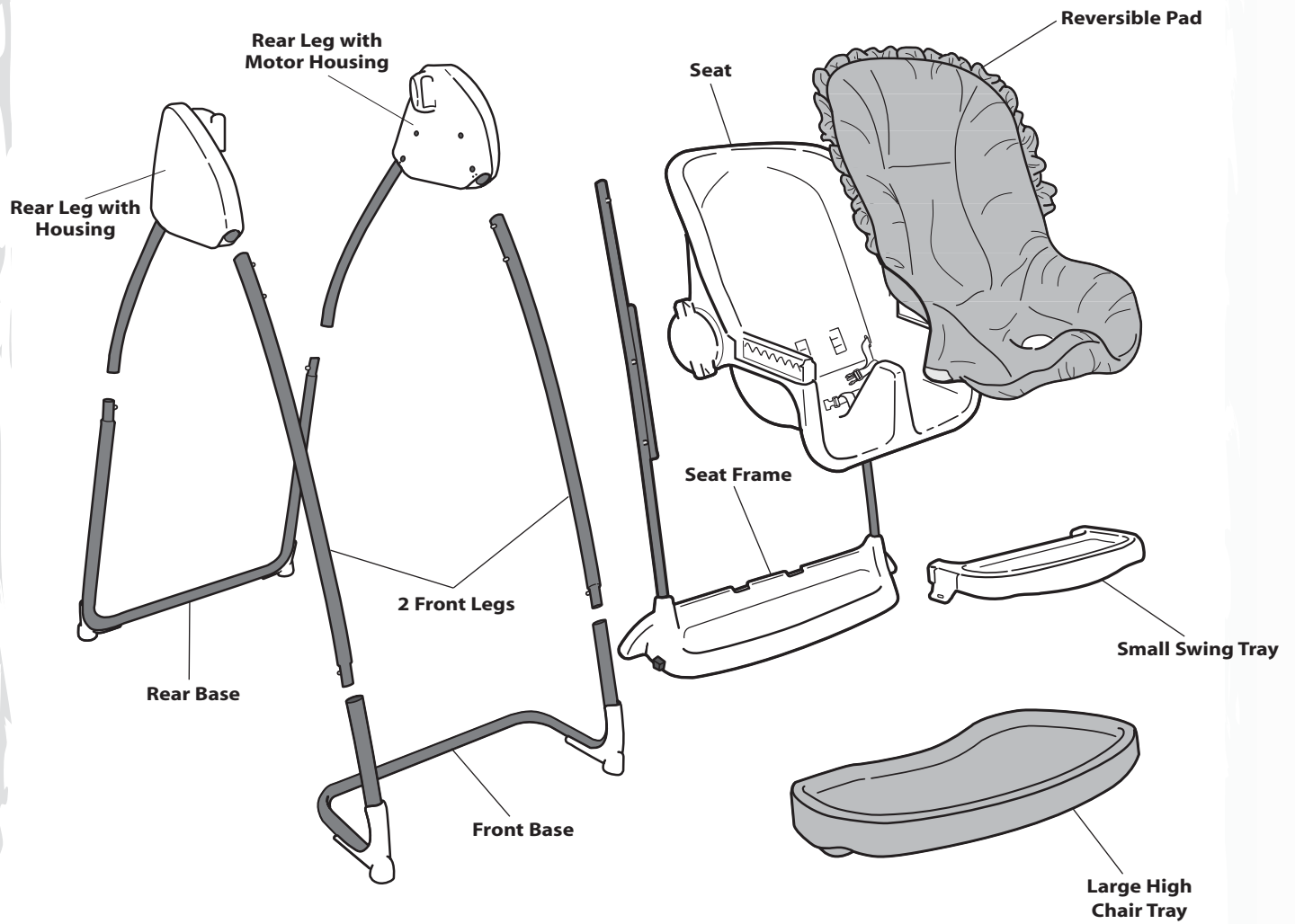

**⚠ CAUTION**  
This package contains small parts in its unassembled state.  
Adult assembly is required.

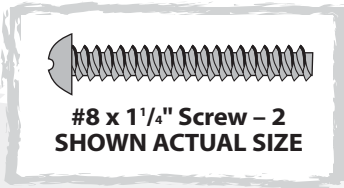

# Assembly

**IMPORTANT!** Before assembly, inspect this product for damaged hardware, loose joints, missing parts or sharp edges. DO NOT use if any parts are missing or broken. Contact Fisher-Price® for replacement parts and instructions if needed. Never substitute parts.

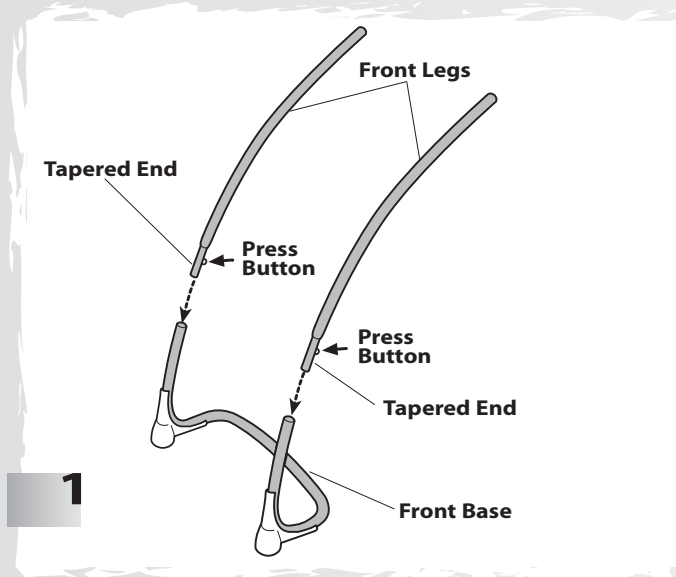

- Place the front base on a flat surface.
- Position a front leg so that the tapered end is downward, as shown.
- While pressing the button on one of the front legs, insert it into the front base. Push down on the front leg until the button **“snaps”** into the hole in the front base.
- Repeat this procedure to assemble the other front leg to the front base.

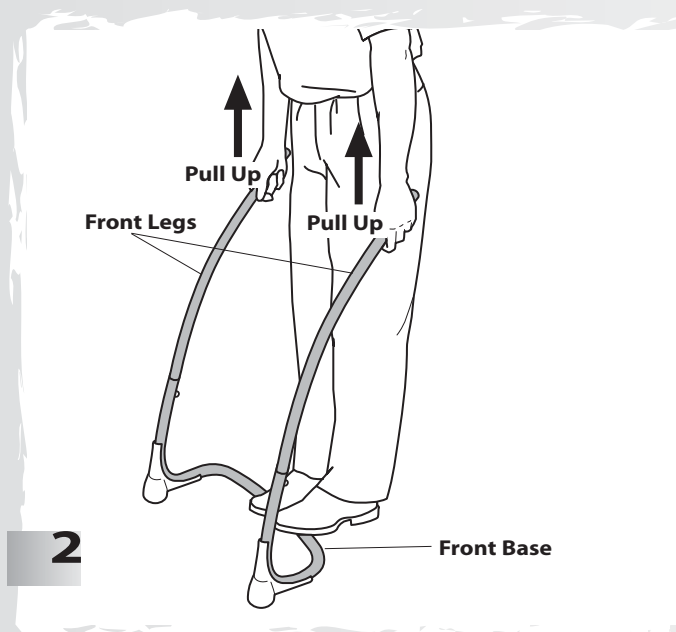

- While standing on the front base, pull the front legs up. The front legs should **remain secured** to the front base. If you can remove the front legs, you have not assembled them correctly to the front base. Reread and repeat assembly step 1.

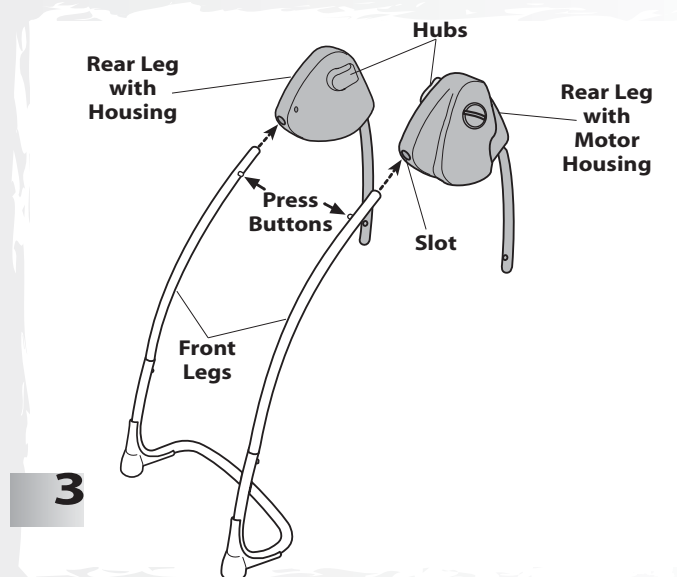

- Position the rear leg with housing so that the hub is inward.
- While pressing the upper button on front leg, insert it into the rear leg with housing slot, as shown. Push the front leg until the button **“snaps”** into the hole in the rear leg with housing.
- Repeat this procedure to assemble the rear leg with motor housing to the other front leg.
- Pull the front legs down to be sure they are secure in the housings. If you can remove them, you have not assembled them correctly. Please re-read and repeat this assembly step.

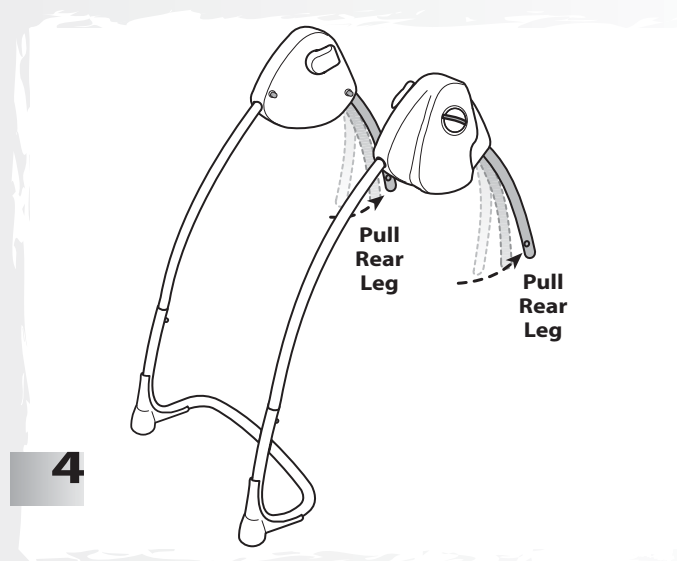

- Pull both rear legs out until they **“snap”** into place.

# Assembly

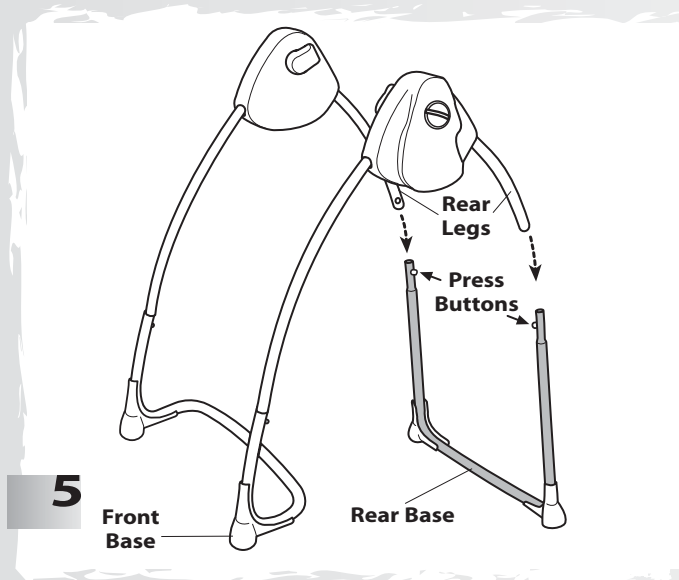

- 5**
- Place the rear base on a flat surface, as shown.
  - While pressing the buttons on each side of the rear base, fit the rear legs onto the rear base. Push the rear legs down until the buttons on the rear base “snap” into the holes in each rear leg.

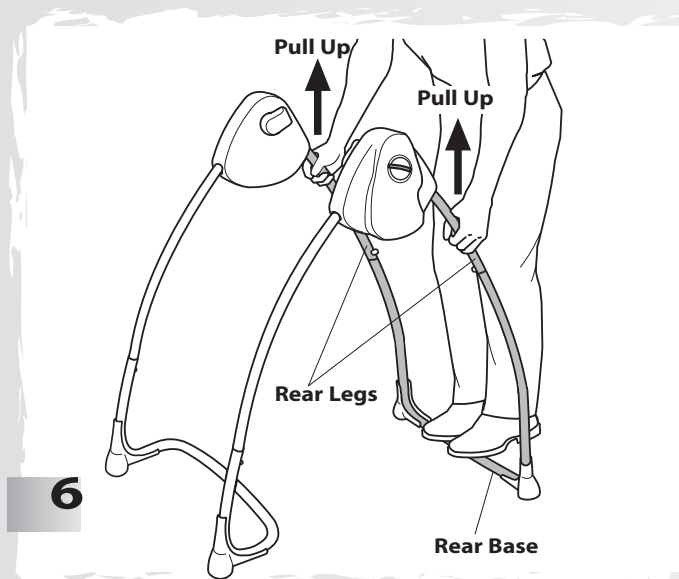

- 6**
- While standing on the rear base, pull the rear legs up. They should remain secured to the rear base. If you can remove the rear legs, you have not assembled them correctly to the rear base. Re-read and repeat assembly step 5.
  - Set the frame assembly aside for Assembly step 8.

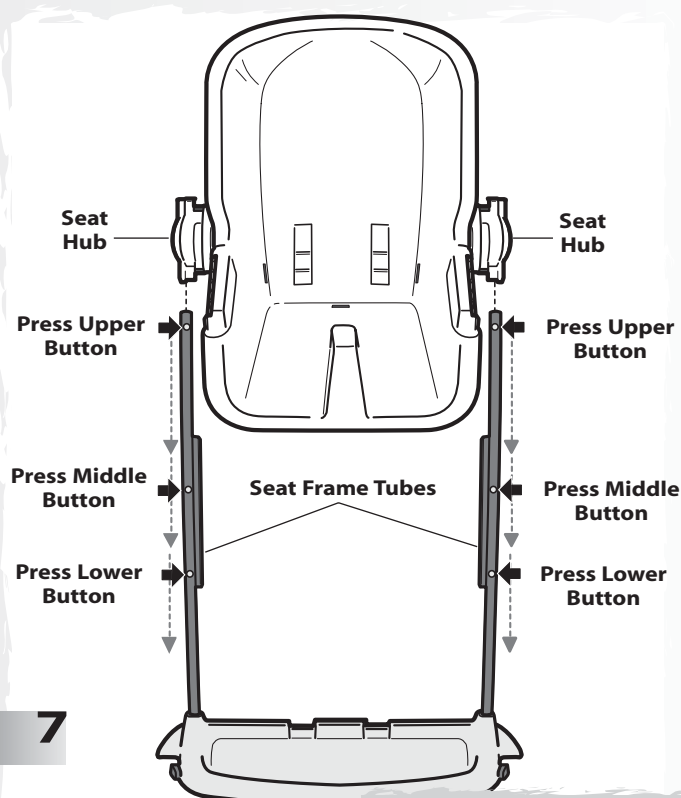

- 7**
- Position the seat frame on a flat surface.
  - Fit the hole in the seat hubs onto the seat frame tubes.
  - Press the upper buttons on the seat frame tubes and slide the seat down.
  - Press the middle buttons on the seat frame tubes and slide the seat down.
  - Press the lower buttons on the seat frame tubes and slide the seat down.
  - The seat should be touching the footrest.

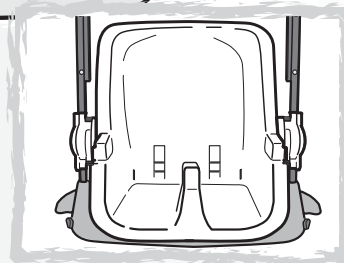

# Assembly

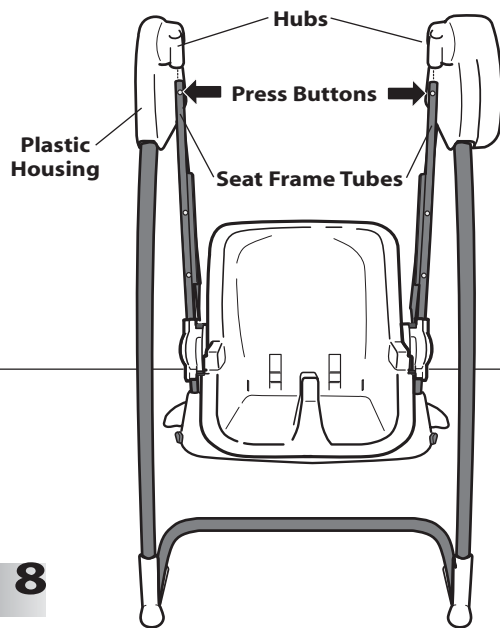

**8**

- Position the frame assembly so that the curved, front base is towards you.
- Fit the seat frame tubes into the hubs on the frame assembly.
- Press the upper buttons on the seat frame tubes and insert them into the hubs on the frame assembly until they "snap" into place. **Make sure you hear a "snap" on both sides.**

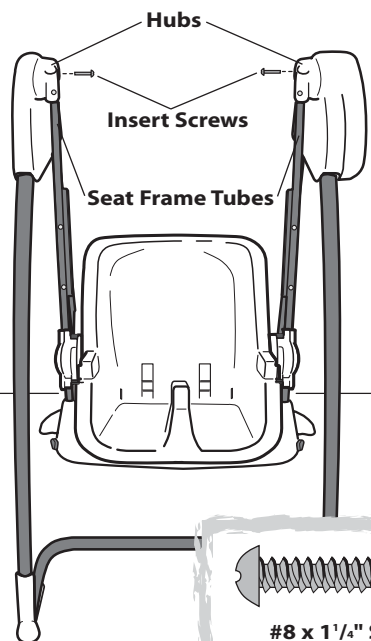

**9**



**#8 x 1 1/4" Screw – 2  
Shown Actual Size**

- Insert a screw into each hub and each seat frame tube.
- Tighten the screws with a Phillips screwdriver. Do not over-tighten.

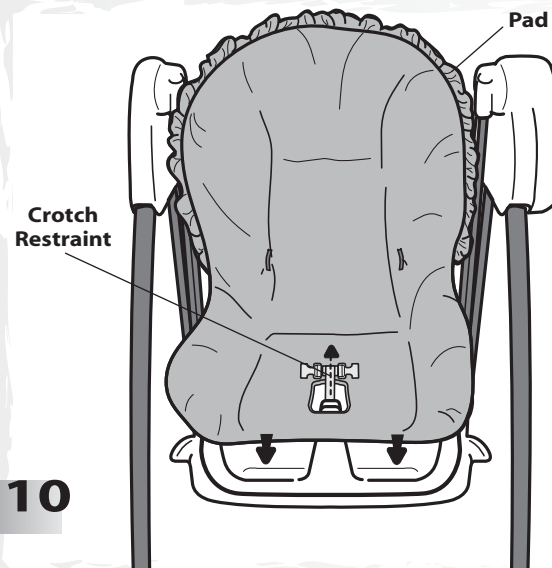

**10**

- Decide which side of the reversible pad you will use. One side of the pad has a soft, cotton material with ruffle (for swing use); the other side is a wipeable vinyl material (for high chair use).
- Fit the pocket on the back of the reversible pad onto the seat back.
- Insert the crotch restraint through the large rectangular opening in the pad.

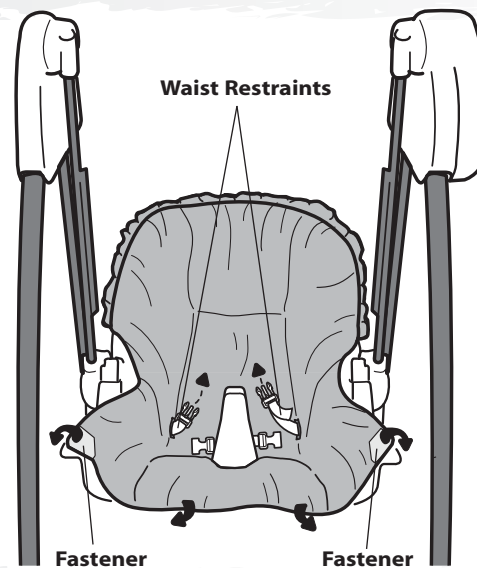

**11**

- Fit the waist restraints through the smaller slots in the reversible pad.
- Fasten the fasteners on the sides of the reversible pad to the back of the seat.
- Fit the bottom edge of the reversible pad around the bottom edge of the seat.

**Assembly is now complete.**

**IMPORTANT! Before first-time use, please read and understand how to install batteries, setup, use, store and care for Swing 'n Meals™.**

## Battery Installation

**Hint:** We recommend using **alkaline** batteries for longer battery life.

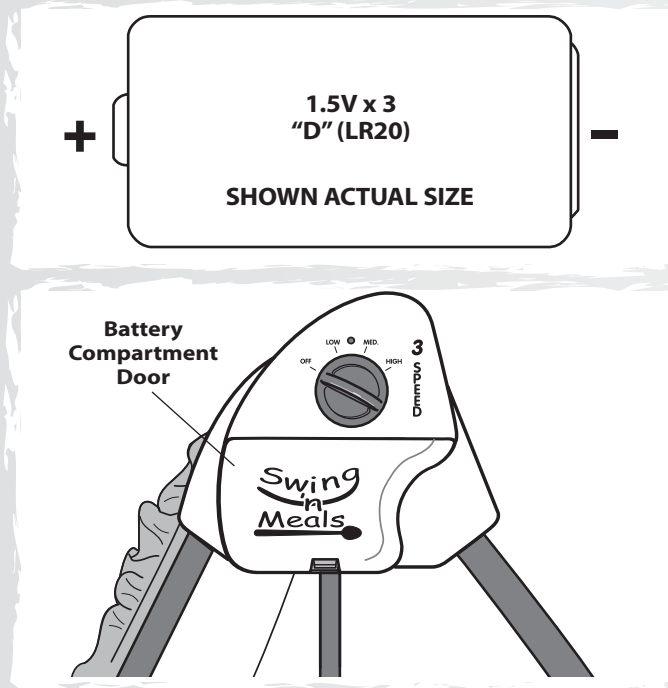

- Locate the battery compartment on the plastic housing.
- Using a coin, press the tab on the battery compartment door and remove it.
- Insert three, new "D" (LR20) **alkaline** batteries as shown in the battery compartment.
- Replace the battery compartment door.

**Hint:** When swinging motion becomes noticeably slower, remove the batteries and replace them with three, new "D" (LR20) **alkaline** batteries.

## Battery Tips

- Do not mix old and new batteries.
- Do not mix different types of batteries: alkaline, standard (carbon-zinc) or rechargeable (nickel-cadmium).
- Remove the batteries during long periods of non-use. Always remove exhausted batteries from the product. Battery leakage and corrosion can damage this product. Dispose of exhausted batteries properly.
- Do not dispose of batteries in a fire. The batteries may explode or leak.
- Never short circuit the battery terminals.
- Non-rechargeable batteries are not to be recharged.
- Only batteries of the same or equivalent type as recommended in the Battery Installation instructions are to be used.
- If removable rechargeable batteries are used, they are only to be charged under adult supervision.
- Rechargeable batteries are to be removed from the toy before they are charged.
- If you use a battery charger, it should be examined regularly for damage to the cord, plug, enclosure and other parts. Do not use a damaged battery charger until it has been properly repaired.



## Swing and High Chair Use

**IMPORTANT!** Before each use, inspect this product for damaged hardware, loose joints, missing parts or sharp edges. DO NOT use if any parts are missing or broken. Contact Fisher-Price® for replacement parts and instructions if needed. Never substitute parts.





## High Chair Setup and Use

### WARNING

**Prevent serious injury or death from falls or sliding out.**

- The child should be secured in the high chair at all times by the restraining system. The restraint belts must be adjusted to fit your child snugly. The tray is not designed to hold the child in the chair.
- Always keep child in view while in the high chair.
- Never leave child unattended.
- It is recommended that the product is used as a high chair only by children capable of sitting upright unassisted.

### Converting from Swing to High Chair

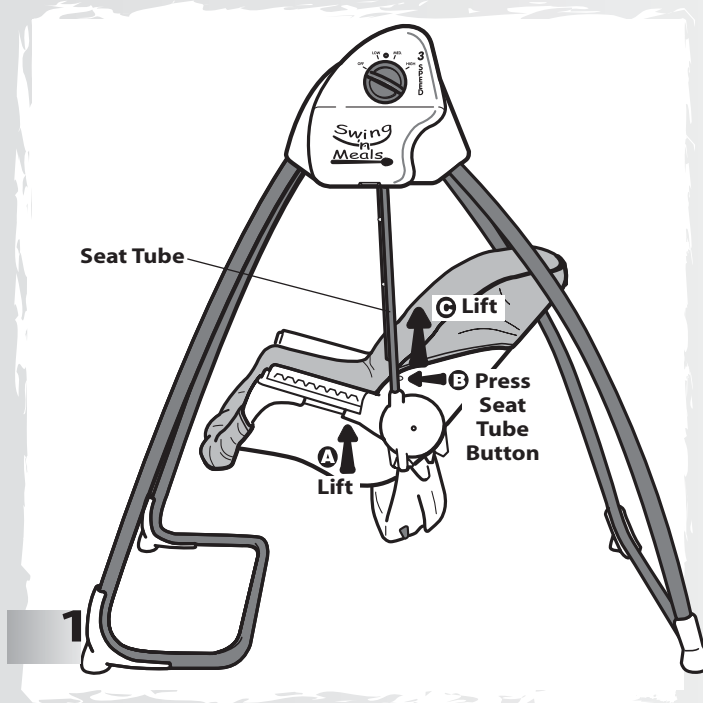

- Lift the seat **A** and then press the buttons on the back side of the seat tubes to release the seat **B**.
- Lift the seat again **C**.

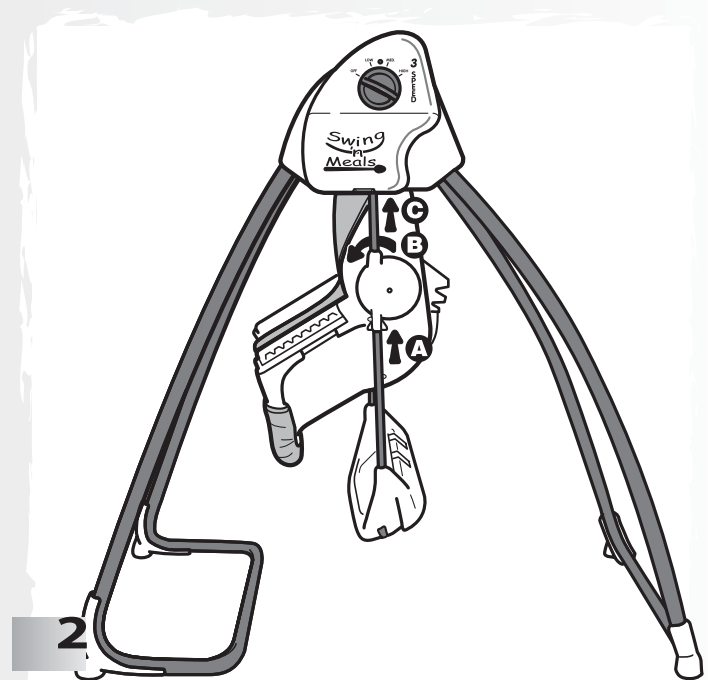

- Continue to lift the seat **A** until it rotates forward **B**. The notches in the hubs will align with the plastic ridge on the seat frame tubes.
- Again, lift **C** the seat until it "snaps" into place. The seat is now in the **lower** high chair position.

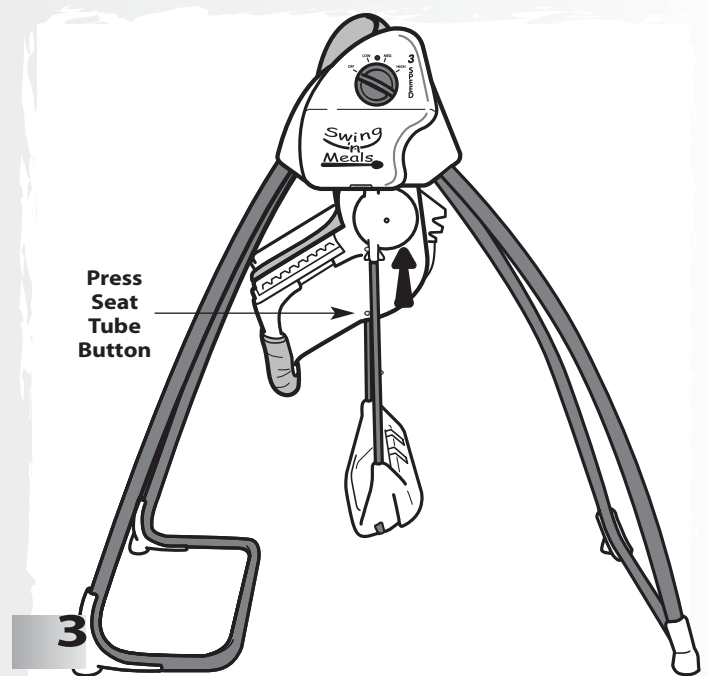

- For the **upper** high chair position, simply press the buttons on the front side of the seat frame tubes and lift the seat until it "snaps" into place.

## High Chair Setup and Use

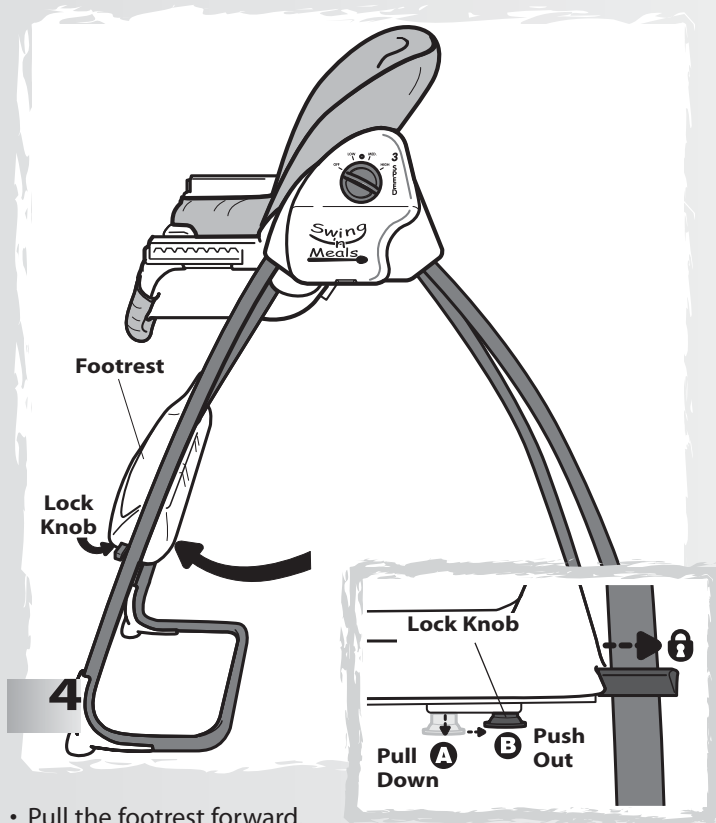

- Pull the footrest forward.
- Locate the lock knobs on each end of the footrest.
- Pull the lock knobs down **A** and then slide them out **B**. The lock symbol **B** should be visible on both lock tab. The footrest locks for high chair use.
- Check to be sure the seat is secure for high chair use:
  - Push the seat bottom down with your hand. The seat should not move.
  - Push the footrest back. The footrest should not move.

**Swing 'n Meals™ is now ready for high chair use.**

### Restraint Use

#### **WARNING**

The child should be secured in the product at all times by the restraining system. The restraint belts must be adjusted to fit your child snugly. The tray is not designed to hold the child in the chair.

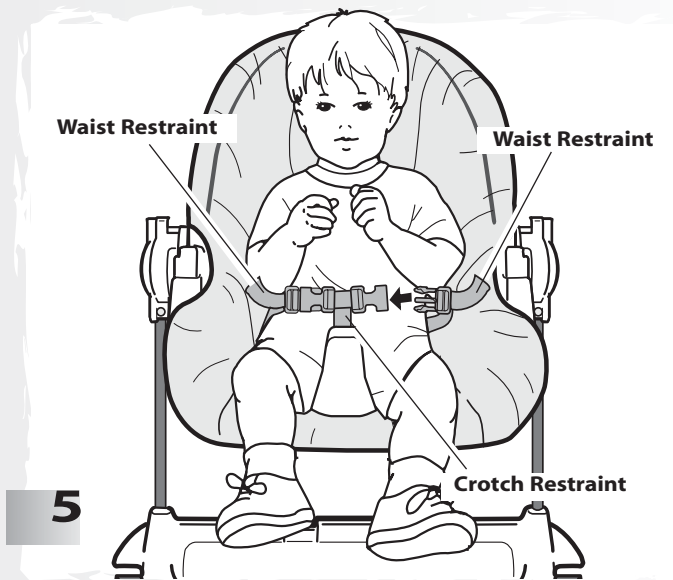

**5**

**Hint:** Choose which side of the reversible pad you would like to use. Refer to assembly steps 10 and 11 (on page 6) to attach the pad.

- Place your child in the seat.
- Pull the crotch restraint up between your child's legs and fasten both waist restraints to the crotch restraint. **Make sure you hear a "snap" on both sides.**

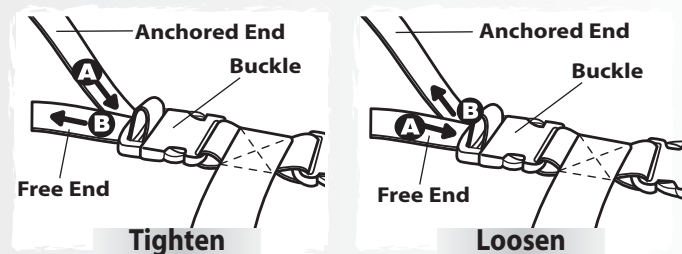

#### To tighten the waist restraints:

- Feed the anchored end of the waist restraint up through the buckle to form a loop **A**.
- Pull the free end of the waist restraint **B**.
- Repeat this procedure to tighten the other waist restraint.

#### To loosen the waist restraints:

- Feed the free end of the waist restraint up through the buckle to form a loop **A**.
- Enlarge the loop by pulling on the end of the loop toward the buckle.
- Pull the anchored end of the waist restraint to shorten the free end of the waist belt **B**.
- Repeat this procedure to loosen the other waist restraint.

# High Chair Setup and Use

## High Chair Tray Use

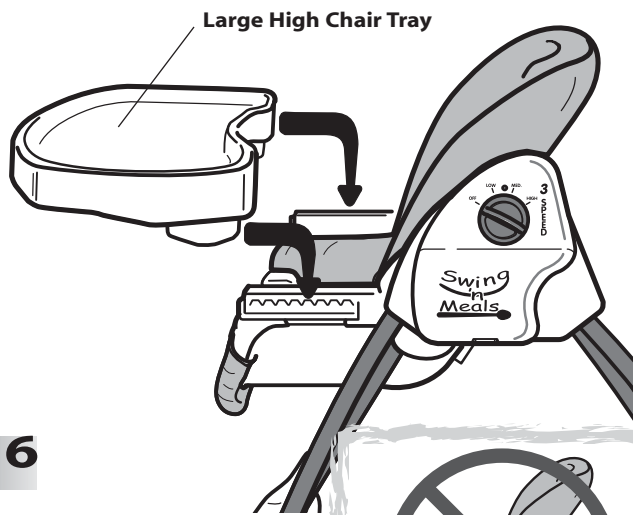

6

- Fit the large high chair tray onto the seat armrests.
- **DO NOT** use the small swing tray when using this product as a high chair.

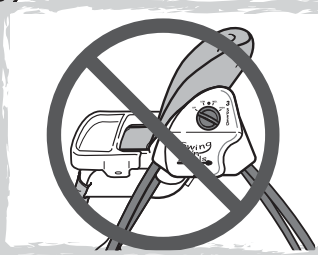

**Hint:** Before use, thoroughly wash all parts (the tray) that may contact food.

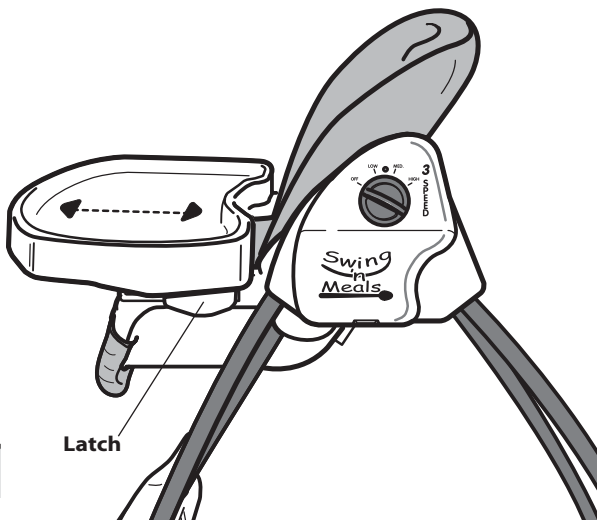

7

- The tray is adjustable to several positions.
- Press the latches on the underside of the tray and move the tray forward or backward. Release the latches to lock the tray in place.

## Booster Seat



1

**Hint:** Remove the tray for use as a booster seat at a table.

## Swing Setup and Use

### WARNING

- To prevent falls when using the swing, never use with an active child who may be able to climb out of the seat.
- Never leave child unattended.
- To prevent serious injury or death from falls or sliding out, always use the restraint system. Never rely on the tray to restrain child.

### Converting from High Chair to Swing

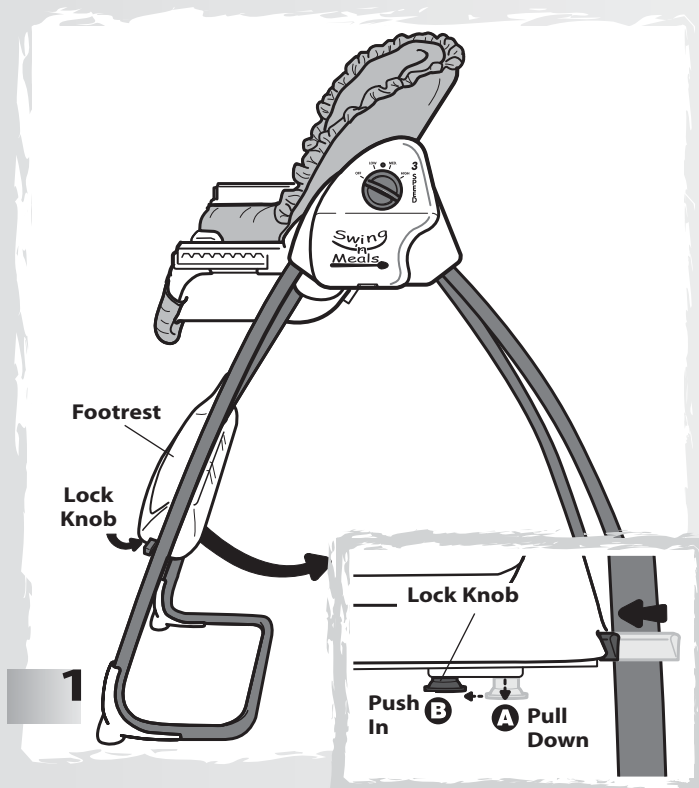

- Locate the lock knobs on each end of the footrest.
- Pull the lock knobs down **A** and then slide them inward **B**. The footrest unlocks for swing use.

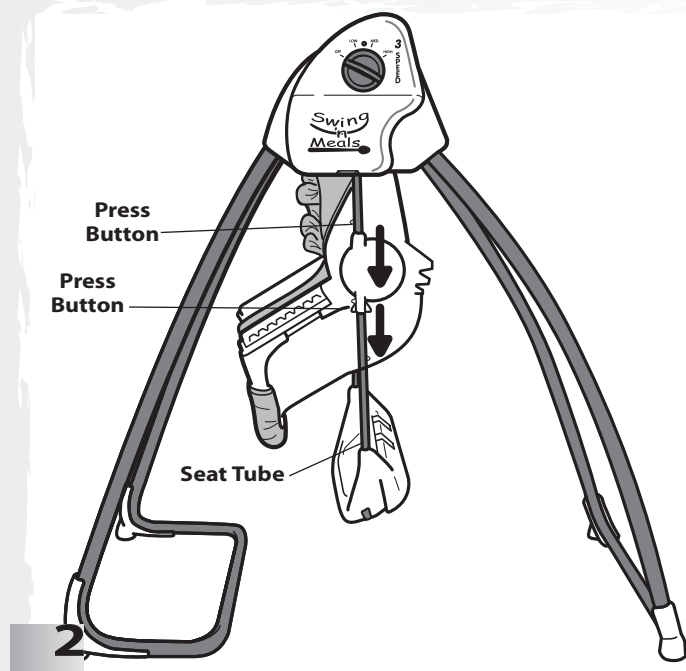

- Press the buttons on the front side of the seat tubes and pull the seat down to completely lower the seat.

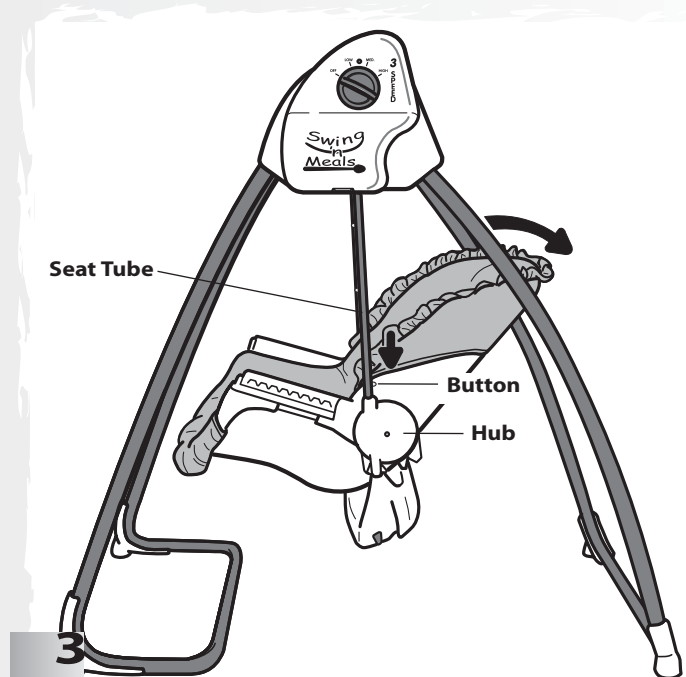

- Tilt the seat back and pull the seat down so that the seat hubs pass over the buttons on the back side of the seat tubes. **You should hear a "snap"!**
- Check to be sure the seat is secure for swing use. Push the seat bottom down with your hand. The seat should not move down.

**Swing 'n Meals™ is now ready for swing use.**

# Swing Setup and Use

## Restraint Use

### WARNING

To prevent serious injury or death from falls or sliding out, always use the restraint system. Never rely on the tray to restrain child.

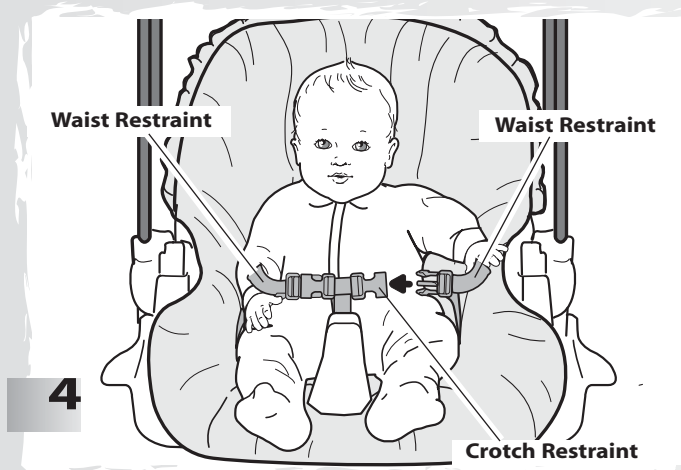

**Hint:** Choose which side of the reversible pad you would like to use. Refer to assembly steps 10 and 11 (on page 6) to attach the pad.

- Place your child in the seat.
- Pull the crotch restraint up between your child's legs and fasten both waist restraints to the crotch restraint. **Make sure you hear a "snap" on both sides.**

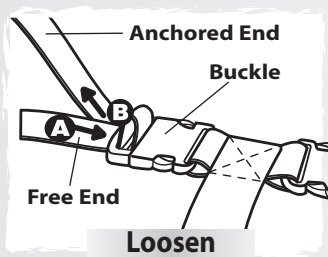
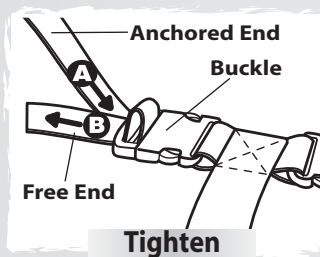

#### To tighten the waist restraints:

- Feed the anchored end of the waist restraint up through the buckle to form a loop **A**.
- Pull the free end of the waist restraint **B**.
- Repeat this procedure to tighten the other waist restraint.

#### To loosen the waist restraints:

- Feed the free end of the waist restraint up through the buckle to form a loop **A**.
- Enlarge the loop by pulling on the end of the loop toward the buckle.
- Pull the anchored end of the waist restraint to shorten the free end of the waist restraint **B**.
- Repeat this procedure to loosen the other waist restraint.

## Swing Tray Use

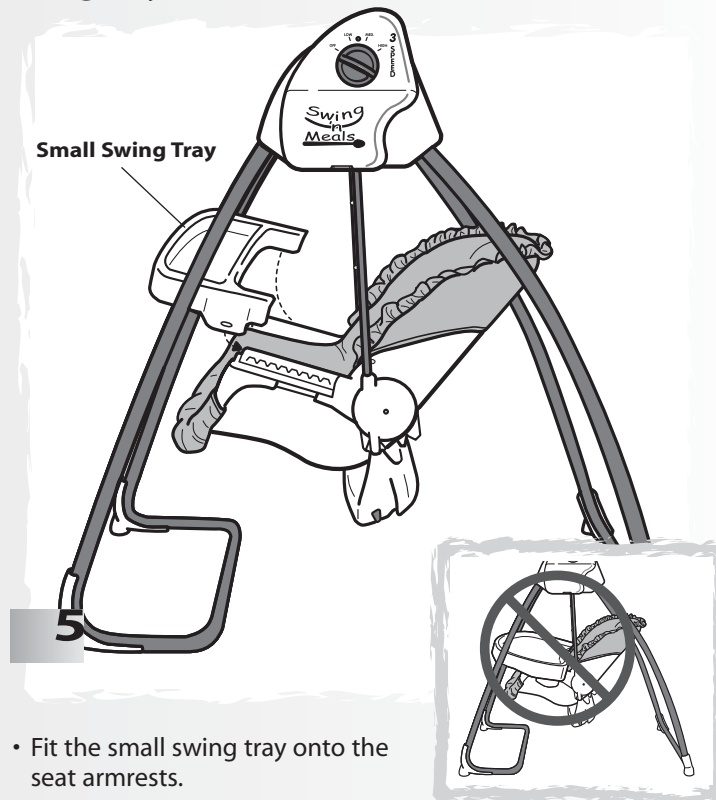

- Fit the small swing tray onto the seat armrests.
- **DO NOT** use the large high chair tray when using this product as a swing.

## Swing Use

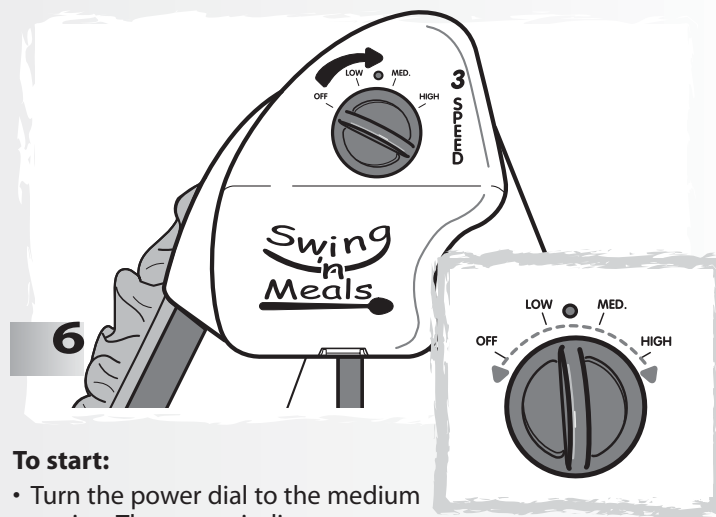

#### To start:

- Turn the power dial to the medium setting. The power indicator will light.
- Give the seat a light push to start the swinging motion. Adjust the power dial to the desired swing motion setting: low, medium or high.

#### Hints:

- As with most battery-powered swings, a heavier child will reduce the amount of swinging motion on all settings. In most cases, the low setting works best for a smaller child while the high setting works best for a larger child.
- If the low setting provides too much swinging motion for your child, try placing one end of a blanket underneath your child and let the other end of the blanket drape down while swinging.

## Swing Setup and Use

### Seat Positions

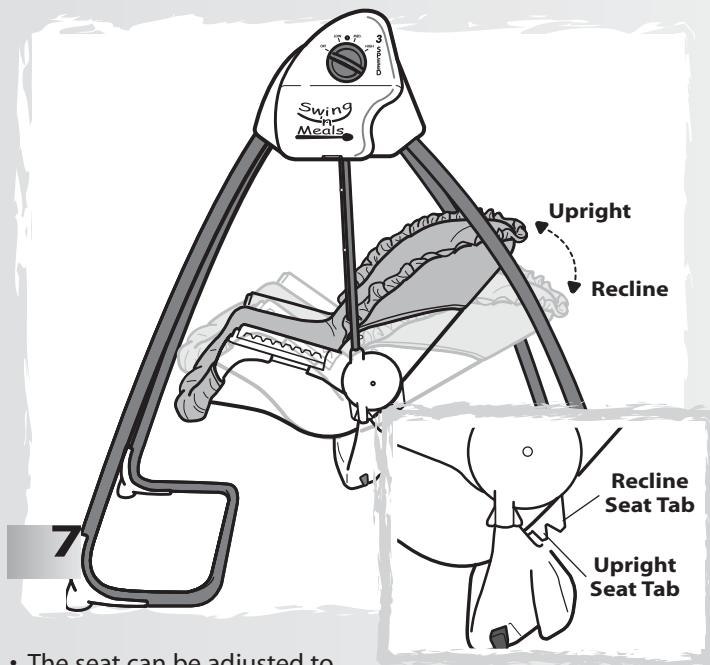

- The seat can be adjusted to an upright or recline position.

#### Upright

- Lift the seat up slightly and rotate the seat forward, so that the seat tabs rest in the footrest notches.

#### Recline

- Lift the seat up slightly and rotate the seat back, so that the seat tabs rest in the footrest notches.
- **Again, check to be sure the seat is secure for swing use:** Push down on the seat bottom with your hand. The seat should not move down.

## Care

- Remove the trays from the seat.
- Unbuckle the restraint system.
- Unfasten the fasteners on the seat pad from the sides of the seat.
- Remove the pad from the seat.
- Machine wash the pad separately in cold water on the gentle cycle. Do not use bleach. Tumble dry separately on low heat and remove promptly.
- The frame and trays may be wiped clean using a mild cleaning solution and a damp cloth.
- Replace the pad on the seat (see assembly steps 10 - 11, page 6.)
- Periodically check the product for loose fasteners or broken parts and tighten as needed.

For other countries, outside the United States:

**Canada:** call 1-800-567-7724, or write to: Mattel Canada Inc., 6155 Freemont Blvd., Mississauga, Ontario L5R 3W2.

**Great Britain:** telephone 01628 500303.

**Australia:** Mattel Australia Pty. Ltd., 658 Church Street, Locked Bag #870, Richmond, Victoria 3121 Australia. Consumer Advisory Service 1300 135 312.

**New Zealand:** 16-18 William Pickering Drive, Albany 1331, Auckland.

Fisher-Price, Inc., a subsidiary of Mattel, Inc., East Aurora, NY 14052 U.S.A.

©2001 Mattel, Inc. All Rights Reserved. © and ™ designate U.S. trademarks of Mattel, Inc.

## Storage

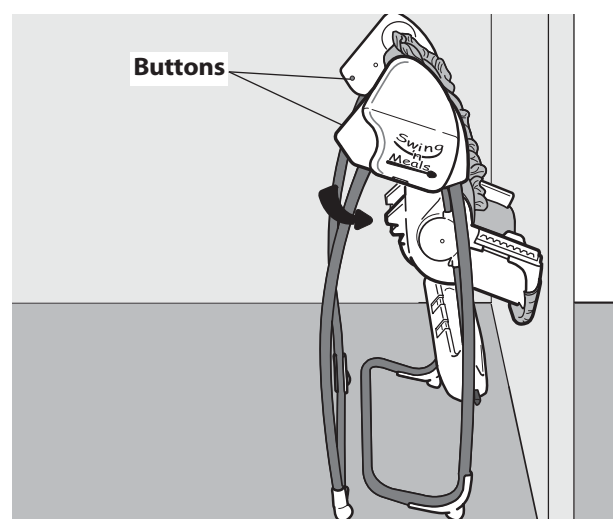

- Press the buttons on the back of the plastic housing and rotate the back legs in. Stand the frame against a wall for storage.

## One (1) Year Limited Warranty

Fisher-Price, Inc., 636 Girard Avenue, East Aurora, New York 14052 warrants Swing 'n Meals™ is free from all defects in material and workmanship when used under normal conditions for a period of one (1) year from the date of purchase.

Should the product fail to perform properly, we will repair or replace it at our option, free of charge. Purchaser is responsible for shipping the product to Consumer Relations at the address indicated above and for all associated freight and insurance cost. Fisher-Price, Inc. will bear the cost of shipping the repaired or replaced item to you. This warranty is void if the owner repairs or modifies the product. This warranty excludes any liability other than that expressly stated above including but not limited to any incidental or consequential damages.

**SOME STATES DO NOT ALLOW THE EXCLUSION OR LIMITATION OF INCIDENTAL OR CONSEQUENTIAL DAMAGES, SO THE ABOVE LIMITATION OR EXCLUSION MAY NOT APPLY TO YOU.**

**THIS WARRANTY GIVES YOU SPECIFIC LEGAL RIGHTS, AND YOU MAY ALSO HAVE OTHER RIGHTS WHICH MAY VARY FROM STATE TO STATE.**

Printed in China  
79739b-0920

## Free Manuals Download Website

<http://myh66.com>

<http://usermanuals.us>

<http://www.somanuals.com>

<http://www.4manuals.cc>

<http://www.manual-lib.com>

<http://www.404manual.com>

<http://www.luxmanual.com>

<http://aubethermostatmanual.com>

Golf course search by state

<http://golfingnear.com>

Email search by domain

<http://emailbydomain.com>

Auto manuals search

<http://auto.somanuals.com>

TV manuals search

<http://tv.somanuals.com>