

Fisher-Price®

73458
Instructions

Starry Night Mobile

with Remote
Control

Please keep this instruction sheet for future reference, as it contains important information.

Adult assembly is required.

Requires four "D" (LR20) **alkaline** batteries for the mobile and two "AA" (LR6) **alkaline** batteries for the remote. (Batteries not included.)

Tool required for battery installation:
Phillips screwdriver (not included).



www.fisher-price.com

Download from Www.Somanuals.com. All Manuals Search And Download.

Parts

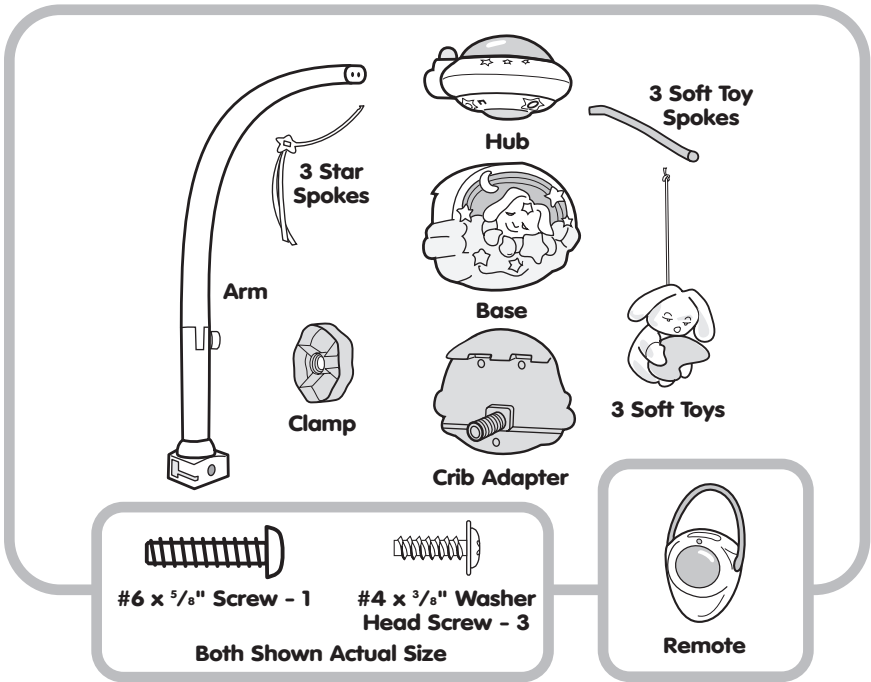

IMPORTANT!

WARNING

- Possible entanglement injury, keep out of baby's reach.
- Remove mobile from crib or playpen when baby begins to push up on hands and knees.





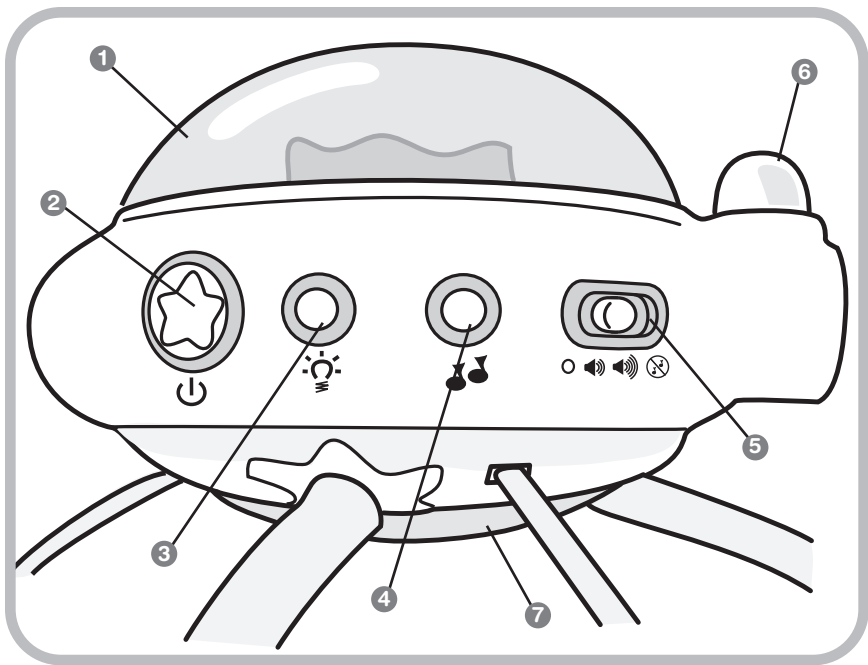

CAUTION

This toy contains small parts in its unassembled state.
Adult assembly is required.

- A crib mobile is intended for visual stimulation and not to be grasped by a child.
- When used on a dresser top, keep out of baby's reach.
- Always attach all provided fasteners (clamp) tightly to a crib or playpen according to the instructions. Check frequently.
- Do not add additional strings or straps to attach to a crib or playpen.

Mobile Features



- 1 Star Dome** – Projects starry images onto baby's ceiling.
- 2 Start Button**  – Starts or restarts music and soothing lights.
- 3 Light Select Button**  – Choose star dome light, night light, both lights or no lights.
- 4 Song Select Button**  – Press to choose from different five songs.
- 5 Power/Volume Switch** - Choose high volume  , low volume  , no sound  or power off .
- 6 Receiver Dome** – Accepts signal from the remote. Dome needs to be turned so it aligns with the transmitter window on the remote
- 7 Night Light** – Features softly glowing colors.

Remote Features

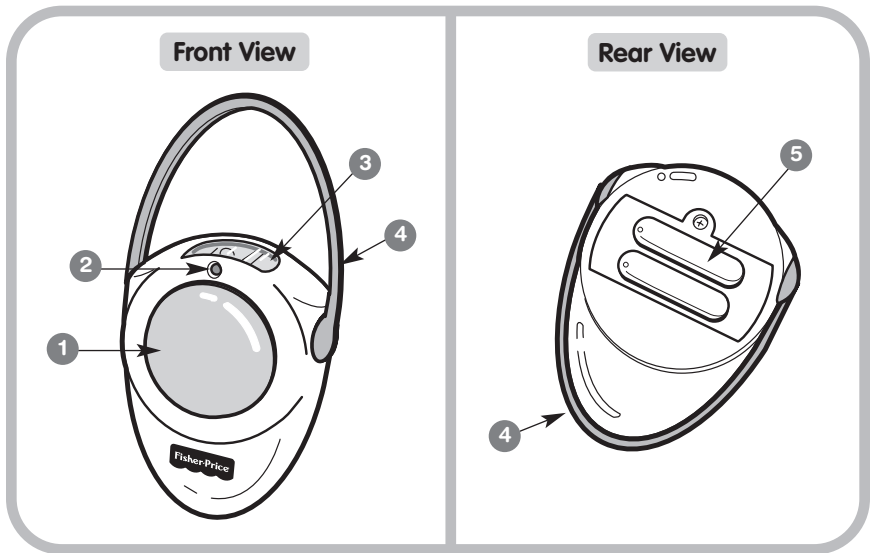

- 1 **Button** - Press to activate the mobile once the mobile has been turned ON.
- 2 **LED Signal Indicator** - Lights when the button is pressed to let you know the remote has transmitted a signal to the transmitter.
- 3 **Transmitter Window** - Remote transmits a signal to the receiver dome on the mobile.
- 4 **Handle** - Flips up so you can hang the remote on a door knob. Snaps around bottom of the remote when not in use.
- 5 **Battery Compartment** - Insert two "AA" **alkaline** batteries. Please refer to Battery Installation on page 6. For longer battery life, use **alkaline** batteries only.

Battery Installation

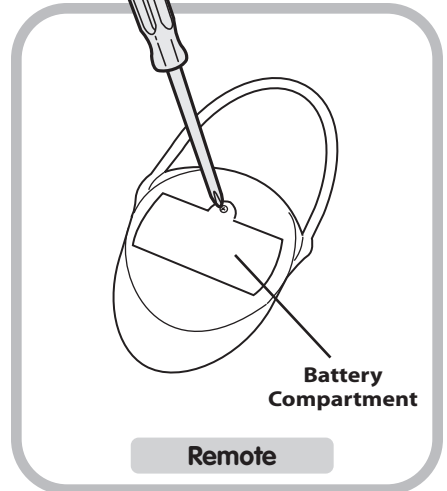
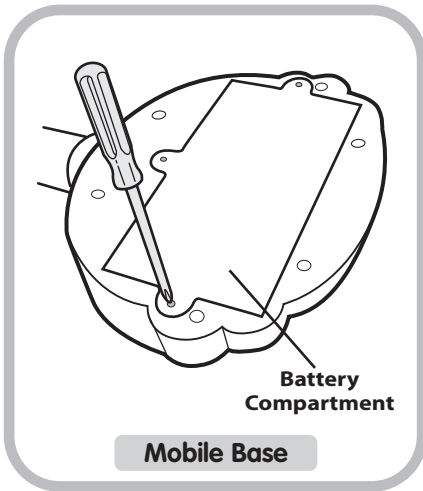

- Locate the battery compartment door on the back of the mobile base.
- Loosen the screws in the battery compartment door with a Phillips screwdriver. Remove the battery compartment door.

Hint: If the crib adapter is attached to the base, loosen the screws in the crib adapter and remove it first.

- Insert four "D" (LR20) **alkaline** batteries, as indicated inside the battery compartment.

Hint: We recommend using **alkaline** batteries for longer battery life.

- Replace the battery compartment door and tighten the screws with a Phillips screwdriver. Do not over-tighten.

IMPORTANT! Under normal use conditions, the batteries in the mobile will require replacement more often than the batteries in the remote. When sounds or light become faint or movement of the mobile is sluggish, it's time for an adult to replace the batteries in the mobile base.

- Locate the battery compartment door on the back of the remote.
- Loosen the screw in the battery compartment door with a Phillips screwdriver. Remove the battery compartment door.

- Insert two "AA" (LR6) **alkaline** batteries, as indicated inside the battery compartment.

Hint: We recommend using **alkaline** batteries for longer battery life.

- Replace the battery compartment door and tighten the screw with a Phillips screwdriver. Do not over-tighten.

IMPORTANT! If the mobile does not respond to the remote, it does not mean that the battery power in the remote is low. Replace the batteries in the remote if the LED signal indicator on the remote is dim when the button is pressed. If the LED signal indicator does not light after installing new batteries in the remote, check the orientation of the batteries in the battery compartment to make sure they are properly installed.

Battery Safety Information

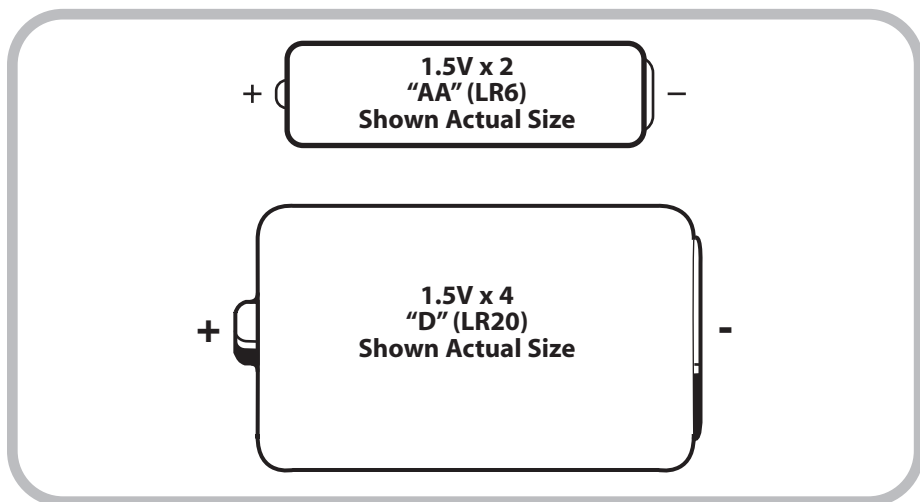

Batteries may leak fluids that can cause a chemical burn injury or ruin your toy. To avoid battery leakage:

- Do not mix old and new batteries or batteries of different types: alkaline, standard (carbon-zinc) or rechargeable (nickel-cadmium).
- Insert batteries as indicated inside the battery compartment.
- Remove batteries during long periods of non-use. Always remove exhausted batteries from the toy. Dispose of batteries safely. Do not dispose of batteries in a fire. The batteries may explode or leak.
- Never short-circuit the battery terminals.
- Use only batteries of the same or equivalent type, as recommended.
- Do not charge non-rechargeable batteries.
- Remove rechargeable batteries from the toy before charging.
- If removable, rechargeable batteries are used, they are only to be charged under adult supervision.

Assembly

1

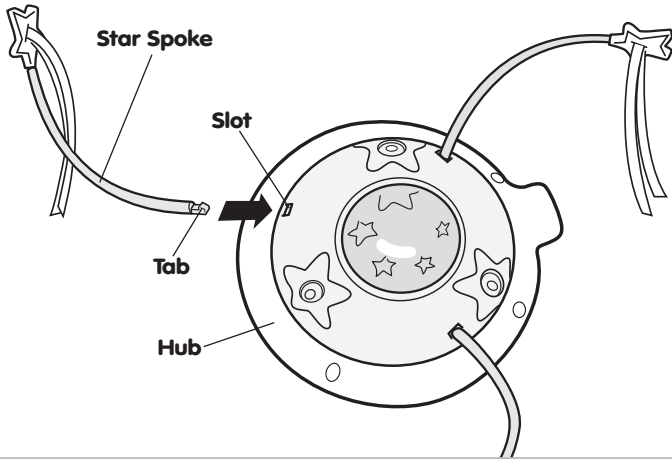

- Locate the three star spokes.
- Insert and **“snap”** the tabs on the ends of the star spokes into the slots in the hub, as shown.

2

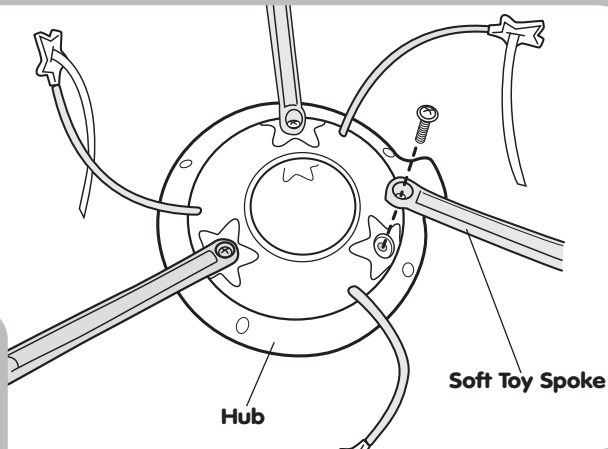

- Locate the three soft toy spokes.
- Place the end of the spoke with the larger hole onto the matching hole on the hub, as shown.
- Insert a #4 x 3/8" screw through the spoke and into the hub. Tighten the screw with a Phillips screwdriver. Do not over-tighten.
- Repeat this procedure to attach the other two soft toy spokes.

Assembly

3

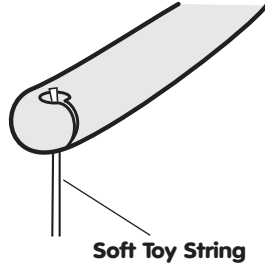
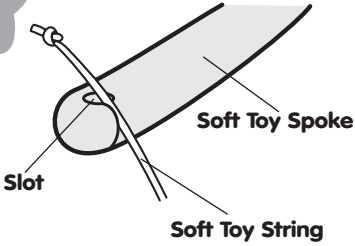

- Fit a soft toy string through the slot in the end of a soft toy spoke.
- Pull down gently on the soft toy to secure the string in the soft toy spoke.
- Repeat this procedure to attach the remaining soft toys to the other two soft toy spokes.

4

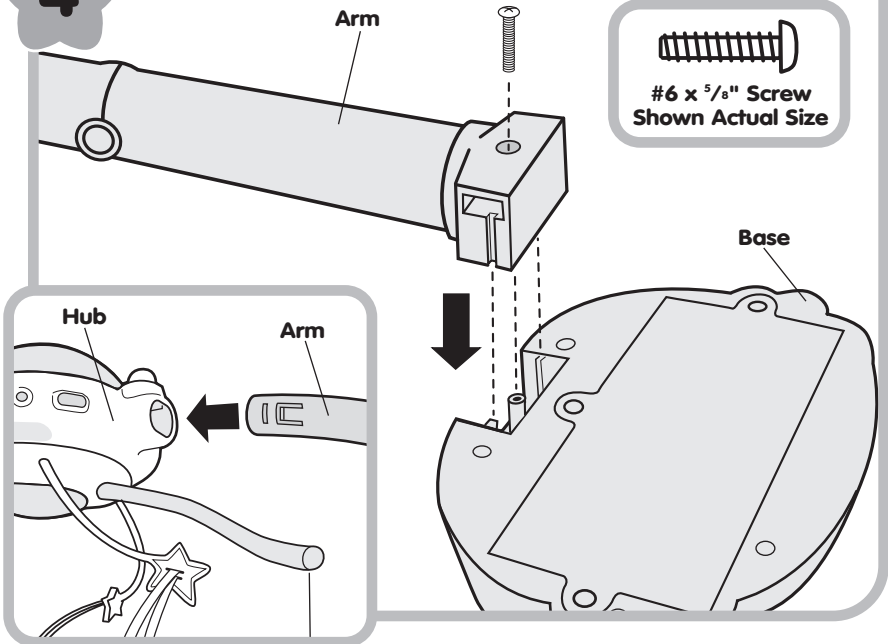

- Insert and **"snap"** the arm into the hole in the side of the hub.
- Fit the arm into the slot in the base, as shown.
- Insert the #6 x $\frac{5}{8}$ " screw through the arm and into the base. Tighten the screw with a Phillips screwdriver. Do not over-tighten.

Crib Use

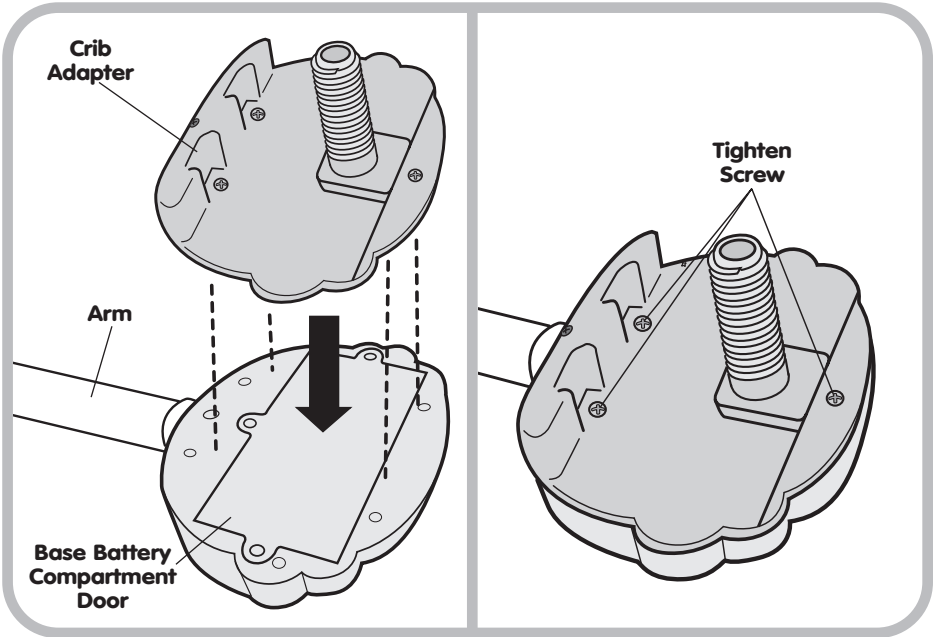

- Position the base so that the battery compartment door is facing you.
- Fit the crib adapter onto the base.
- Tighten the screws in the crib adapter using a Phillips screwdriver. Do not over-tighten.

Crib Use

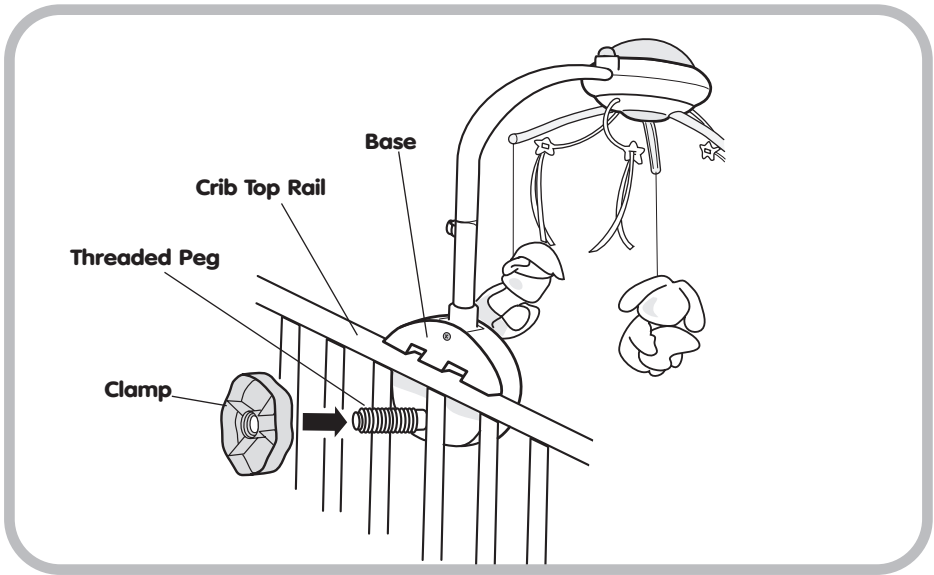

- Fit the mobile base on to the crib top rail so that the threaded peg extends outside of the crib.
- Fit the clamp onto the threaded peg and turn the clamp clockwise to secure the base to the crib rail. Do not over-tighten the clamp.

Use

IMPORTANT!

- In the unlikely event that use of the remote interferes with normal use of other remote controlled equipment, such as televisions and stereos, or use of other electric or battery powered appliances interfere with operation of the mobile, do not use both appliances at the same time.
- For best performance between the mobile and the remote, avoid using the remote in areas of bright light. In bright natural or artificial light, you may notice loss of range. Move the mobile or otherwise reduce the amount of light to improve performance.

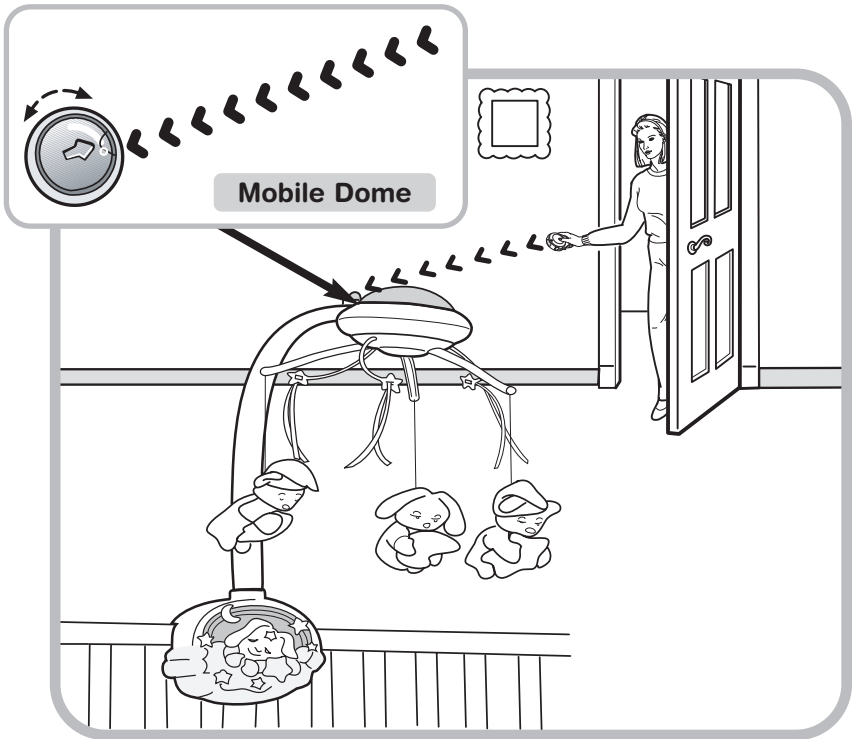



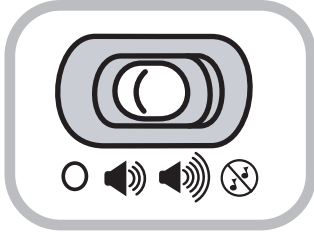

- When using the remote, make sure that the arrow on the mobile's dome is pointing towards the transmitter window on the remote. **For best results, the path between the transmitter window on the remote and the dome on the mobile are in a direct line and free of obstacles. Rotate the mobile dome so that the arrow points to the area from which you're most likely to use the remote.** For example, if you'll most often be using the remote from the doorway of the nursery, make sure that the arrow on the mobile dome is pointing towards the doorway and that the path between the mobile dome and the doorway is free from obstructions.

Use



Power/Volume Switch

- The switch has four positions: off ; on with low volume ; on with high volume ; or no sound  (lights only).
- Slide the power/volume switch to the off position  when not in use.

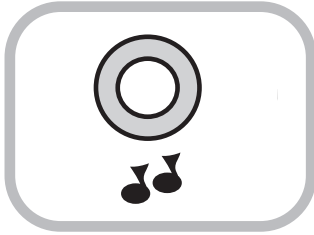

Song Select Button

- Press the button to choose from five different songs.
- Each time you press the song select button, the mobile switches to the next selection until it returns back again to the first.

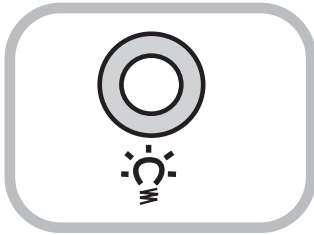

Light Select Button

- Press the button to choose from different light modes:
 - Light the star dome and project starry images on baby's ceiling.
 - Light the night light with soft glowing colors.
 - Light both the star dome and night light.
 - Turn lights off.
- Each time you press the light select button, the mobile switches to the next mode until it returns back again to the first.

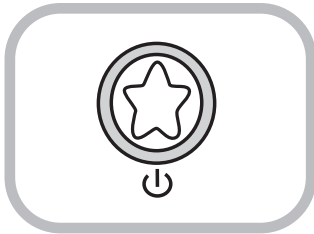

Start Button

- Press the start button to activate music and lights.
- The mobile will play for approximately five minutes.
- To restart the mobile, press the start button again.

Dresser-top Use

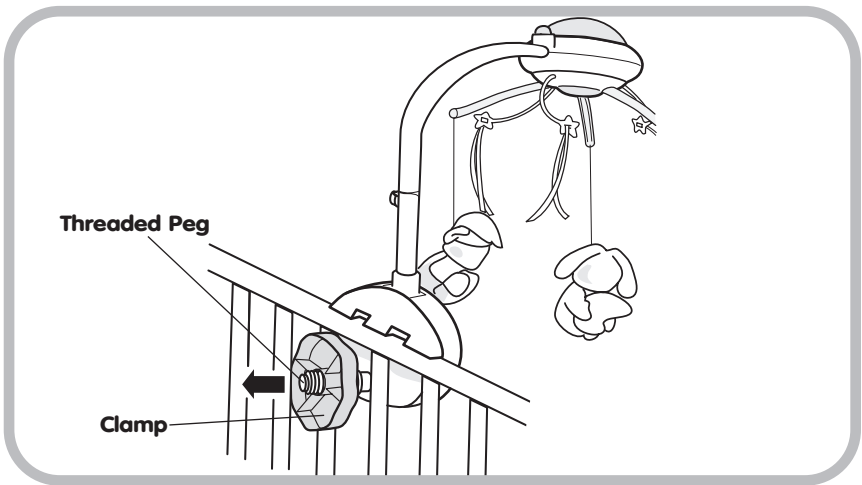

- Loosen and remove the clamp from the threaded peg.
- Remove the mobile from the crib.

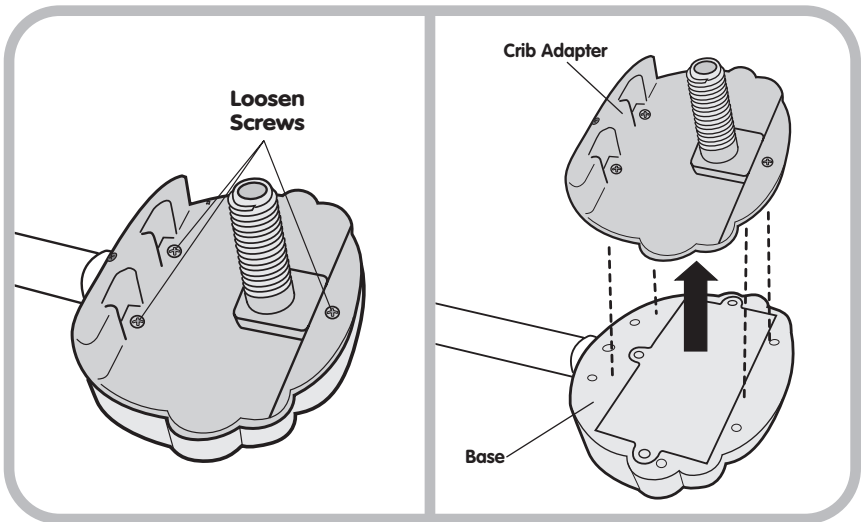

- Loosen the screws in the crib adapter using a Phillips screwdriver.
- Lift and remove the crib adapter.
- Store the crib adapter in a safe place for future crib use.

Dresser-top Use

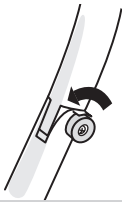
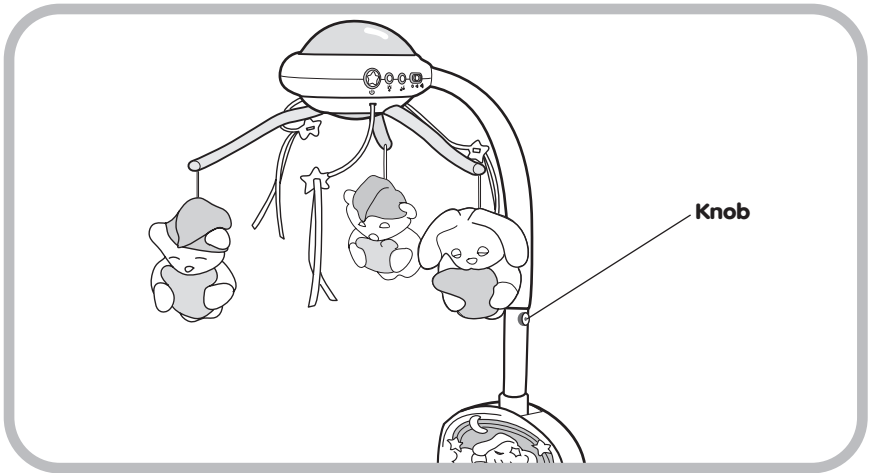

Loosen Knob

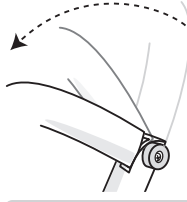

Rotate Arm



Tighten Knob

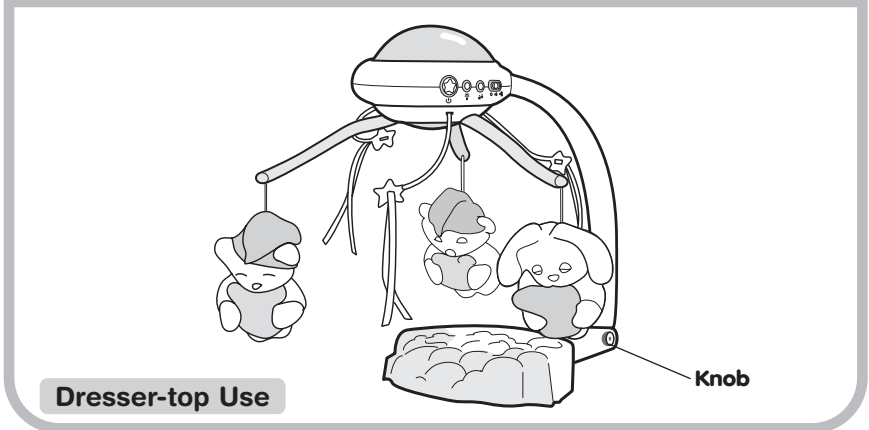

- Locate the knob on the arm.
- Turn the knob counter-clockwise to loosen the arm.
- Rotate the arm down as shown.
- Turn the knob clockwise to tighten the arm snugly.
- Place the mobile on a dresser top out of reach of baby.

Care

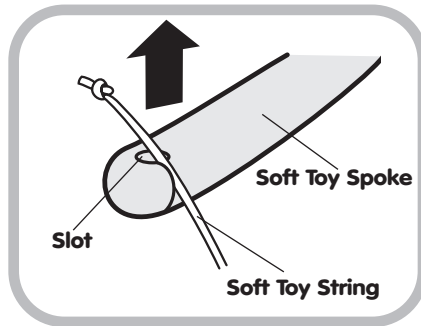

Soft Toys

- To remove a soft toy, grasp its string and press the knot up through the opening in the spoke.
- Slide the string through the slot in the spoke.
- Place the soft toys in a pillowcase. Wash them on a gentle cycle in cold water. Tumble dry the toys on low heat. Do not use bleach.

Mobile

- Wipe the mobile with a clean cloth dampened with a mild soap and water solution.
- Do not immerse the mobile.

FCC Note (United States Only)

Note: This equipment has been tested and found to comply with the limits for a Class B digital device, pursuant to Part 15 of the FCC Rules. These limits are designed to provide reasonable protection against harmful interference in a residential installation. This equipment generates, uses and can radiate radio frequency energy and, if not installed and used in accordance with the instructions, may cause harmful interference to radio communications. However, there is no guarantee that interference will not occur in a particular installation. If this equipment does cause harmful interference to radio or television reception, which can be determined by turning the equipment off and on, the user is encouraged to try to correct the interference by one or more of the following measures:

- Reorient or relocate the receiving antenna.
- Increase the separation between the equipment and receiver.
- Consult the dealer or an experienced radio/TV technician for help.

Note: Changes or modifications not expressly approved by the manufacturer responsible for compliance could void the user's authority to operate the equipment.

Consumer Information

Questions? We'd like to hear from you!

Call Fisher-Price® Consumer Relations, toll-free at **1-800-432-5437**, 8 AM - 6 PM EST Monday through Friday. Hearing-impaired consumers using TTY/TDD equipment, please call 1-800-382-7470. Or, visit us on line at www.service.mattel.com.

Write to us at:

Fisher-Price® Consumer Relations
636 Girard Avenue
East Aurora, New York 14052.

For countries outside the United States:

CANADA: Questions? 1-800-432-5437. Mattel Canada Inc., 6155 Freemont Blvd., Mississauga, Ontario L5R 3W2; www.service.mattel.com.

GREAT BRITAIN: [Mattel UK Ltd, Vanwall Business Park, Maidenhead SL6 4UB.](http://www.service.mattel.com)
[Helpline: 01628 500302.](http://www.service.mattel.com)

AUSTRALIA: Mattel Australia Pty. Ltd., 658 Church Street, Locked Bag #870, Richmond, Victoria 3121 Australia. Consumer Advisory Service 1300 135 312.

NEW ZEALAND: 16-18 William Pickering Drive, Albany 1331, Auckland.

ASIA: Mattel East Asia Ltd, Room 1106, South Tower, World Finance Centre, Harbour City, Tsimshatsui, HK, China.

Free Manuals Download Website

<http://myh66.com>

<http://usermanuals.us>

<http://www.somanuals.com>

<http://www.4manuals.cc>

<http://www.manual-lib.com>

<http://www.404manual.com>

<http://www.luxmanual.com>

<http://aubethermostatmanual.com>

Golf course search by state

<http://golfingnear.com>

Email search by domain

<http://emailbydomain.com>

Auto manuals search

<http://auto.somanuals.com>

TV manuals search

<http://tv.somanuals.com>