

Fisher-Price®



Animal Sounds Zoo



Product Number: 77949

Please keep this instruction sheet for future reference,
as it contains important information.

Requires three "AA" **alkaline** batteries (not included).

Adult assembly is required for battery installation.

Tool required for battery installation:
Phillips screwdriver (not included).

www.fisher-price.com

Battery Replacement

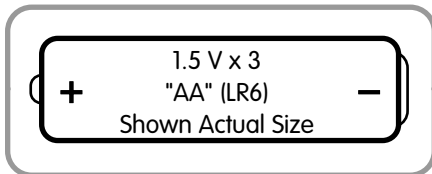
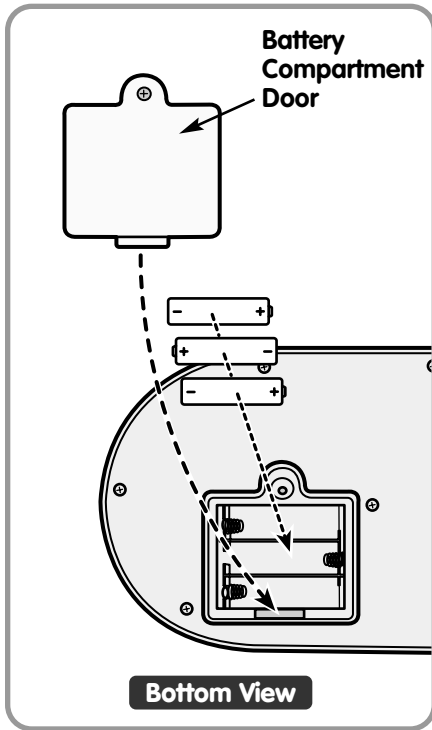

- Locate the battery compartment on the bottom of the toy.
- Loosen the screw in the battery compartment door with a Phillips screwdriver. Remove the battery compartment door.
- Insert three "AA" (LR6) alkaline batteries, as indicated inside the battery compartment.

Hint: We recommend using alkaline batteries for longer life.

- Replace the battery compartment door and tighten the screw with a Phillips screwdriver. Do not over-tighten.

- When sounds from this toy become faint or stop, it's time for an adult to change the batteries!

Battery Tips

- Do not mix old and new batteries.
- Do not mix different types of batteries: alkaline, standard (carbon-zinc) or rechargeable (nickel-cadmium).
- Remove the batteries during long periods of non-use. Always remove exhausted batteries from the toy. Battery leakage and corrosion can damage this toy. Dispose of batteries safely.
- Do not dispose of batteries in a fire. The batteries may explode or leak.
- Never short circuit the battery terminals.
- Non-rechargeable batteries are not to be recharged.
- Only batteries of the same or equivalent type as recommended in the "Battery Replacement" instructions are to be used.
- If removable rechargeable batteries are used, they are only to be charged under adult supervision.
- Rechargeable batteries are to be removed from the toy before they are charged.
- If you use a battery charger, it should be examined regularly for damage to the cord, plug, enclosure and other parts. Do not use a damaged battery charger until it has been properly repaired.

Fun Zoo Animal Sounds

Press down on the footprint in each animal's area to hear that animal's sound!

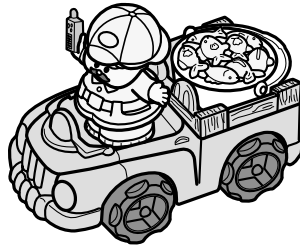
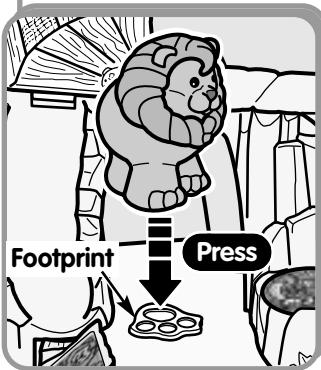
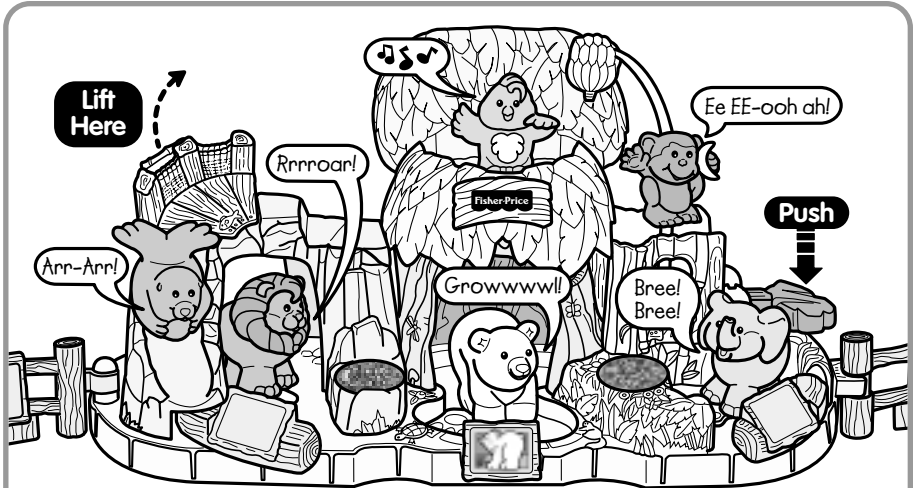

Hint: If your child is not actively playing with this toy, it turns off automatically (sleep mode).

Attaching the Fence

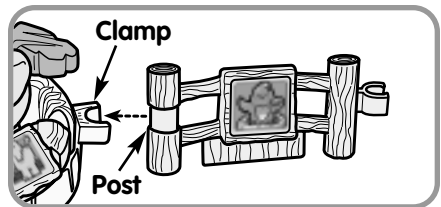
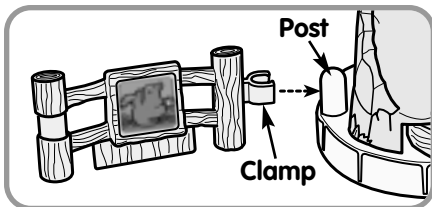

- Push the clamp on the end of one fence onto the post on the zoo and **"snap"** the two parts together.
- Push the post on the end of the other fence into the clamp on the zoo and **"snap"** the two parts together.

Care

- Wipe this toy with a clean cloth dampened with a mild soap and water solution. Do not immerse this toy.
- This toy has no consumer serviceable parts. Do not take this toy apart.

FCC Note (United States Only)

Note: This equipment has been tested and found to comply with the limits for a Class B digital device, pursuant to Part 15 of the FCC Rules. These limits are designed to provide reasonable protection against harmful interference in a residential installation. This equipment generates, uses and can radiate radio frequency energy and, if not installed and used in accordance with the instructions, may cause harmful interference to radio communications. However, there is no guarantee that interference will not occur in a particular installation. If this equipment does cause harmful interference to radio or television reception, which can be determined by turning the equipment off and on, the user is encouraged to try to correct the interference by one or more of the following measures:

- Reorient or relocate the receiving antenna.
- Increase the separation between the equipment and receiver.
- Consult the dealer or an experienced radio/TV technician for help.

CAUTION: Changes or modifications not expressly approved by the manufacturer responsible for compliance could void the user's authority to operate the equipment.

Consumer Information

Questions? We'd like to hear from you!

Call Fisher-Price® Consumer Relations, toll-free at
1-800-432-KIDS,
8 AM - 6 PM EST Monday through Friday. Hearing-impaired consumers using TTY/TDD equipment, please call 1-800-382-7470.

Or, write to:

Fisher-Price® Consumer Relations
636 Girard Avenue
East Aurora, New York 14052

For other countries, outside the United States:

Canada: call **1-800-567-7724**, or write to: Mattel Canada Inc, 6155 Freemont Blvd., Mississauga, Ontario L5R 3W2.

Great Britain: telephone 01628 500303.

Australia: Mattel Australia Pty. Ltd., 658 Church Street, Locked Bag #870, Richmond, Victoria 3121 Australia. Consumer Advisory Service 1300 135 312.

New Zealand: 16-18 William Pickering Drive, Albany 1331, Auckland.

Fisher-Price, Inc., a subsidiary of Mattel, Inc., East Aurora, NY 14052 U.S.A.

©2001 Mattel, Inc. All Rights Reserved.
© and ™ designate U.S. trademarks of Mattel, Inc.

Printed in China
77949pr-0920

Free Manuals Download Website

<http://myh66.com>

<http://usermanuals.us>

<http://www.somanuals.com>

<http://www.4manuals.cc>

<http://www.manual-lib.com>

<http://www.404manual.com>

<http://www.luxmanual.com>

<http://aubethermostatmanual.com>

Golf course search by state

<http://golfingnear.com>

Email search by domain

<http://emailbydomain.com>

Auto manuals search

<http://auto.somanuals.com>

TV manuals search

<http://tv.somanuals.com>