



Actual product may vary from the photos.

Please keep this instruction sheet for future reference,  
as it contains important information.

Requires six "AA" (LR6) **alkaline** batteries  
(not included) for car operation.

Adult assembly is required.

Tool required for battery installation:  
Phillips screwdriver (not included).

This product is not recommended for use  
on loose dirt or wet surfaces.

# Assembly

Each track piece has a number on the bottom. Simply match the numbers and fit the pieces together! For best performance, we suggest assembling the track on a hard, flat surface.

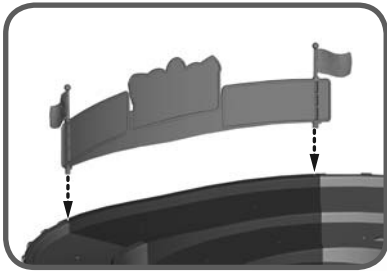

Fit the billboard posts into the sockets in the track.

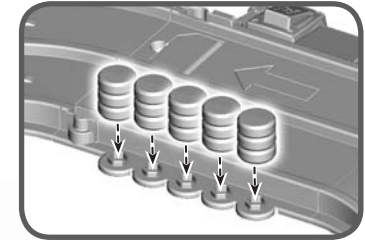

Fit the barrels into the sockets on the start track.

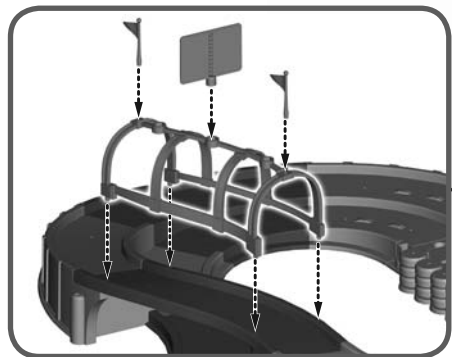
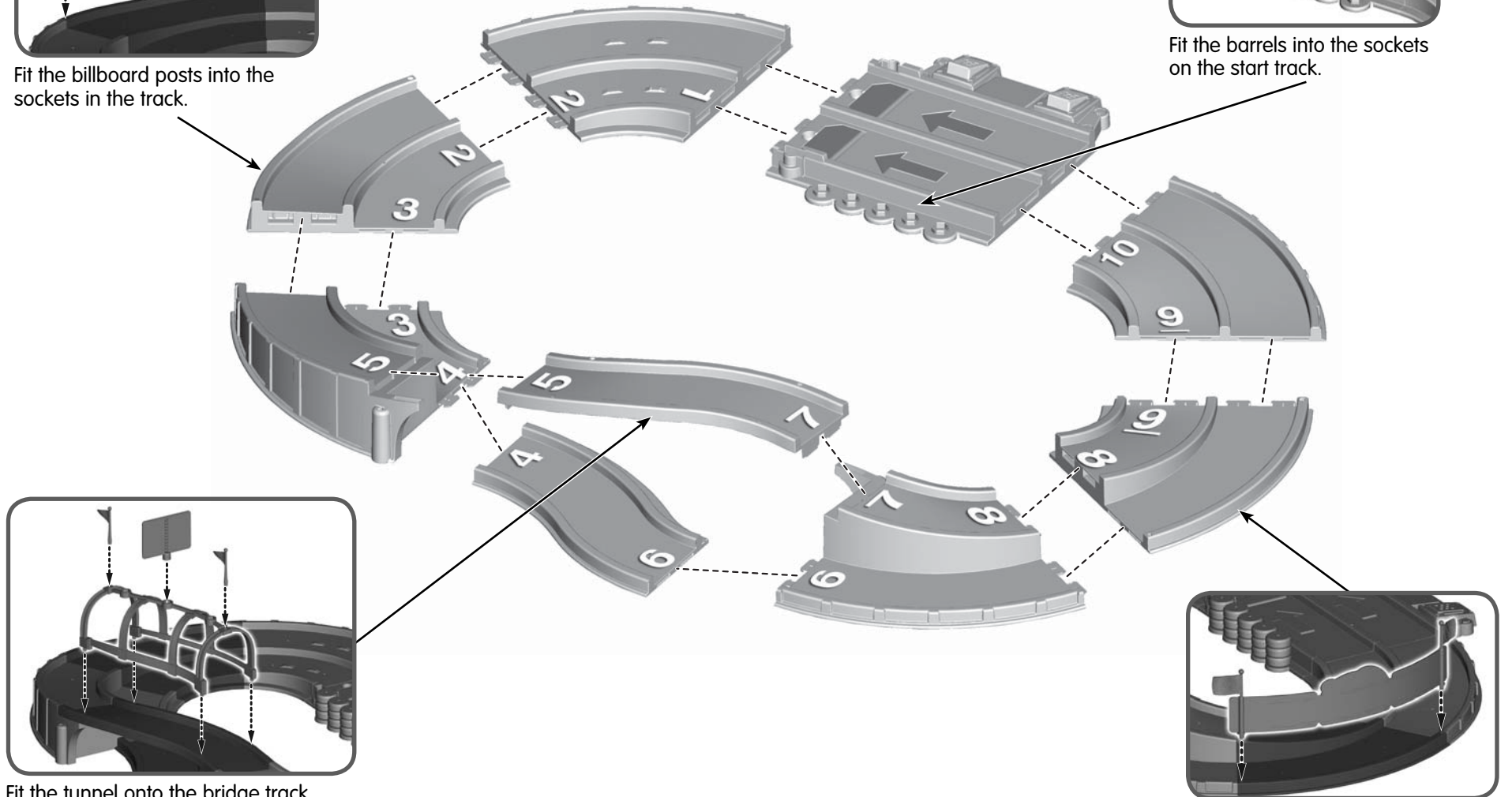

Fit the tunnel onto the bridge track. Fit the flags into the small sockets and the sign into the large sockets in the top of the tunnel.

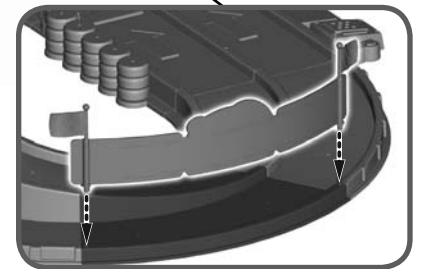

Fit the billboard posts into the sockets in the track.

# Consumer Information



**CONSUMER ASSISTANCE**  
1-800-432-5437 (US & Canada)  
1300 135 312 (Australia)

**service.fisher-price.com**

---

Fisher-Price, Inc., 636 Girard Avenue, East Aurora, NY 14052.  
Hearing-impaired consumers: 1-800-382-7470.

---

Outside the United States:

Canada: Mattel Canada Inc., 6155 Freemont Blvd.,  
Mississauga, Ontario L5R 3W2; [www.service.mattel.com](http://www.service.mattel.com).

Great Britain: Mattel UK Ltd, Vanwall Business Park,  
Maidenhead SL6 4UB. Helpline: 01628 500303.  
[www.service.mattel.com/uk](http://www.service.mattel.com/uk)

Mattel Europa, B.V., Gondel 1, 1186 MJ Amstelveen, Nederland.

Australia: Mattel Australia Pty. Ltd., 658 Church Street,  
Locked Bag #870, Richmond, Victoria 3121 Australia.

New Zealand: 16-18 William Pickering Drive,  
Albany 1331, Auckland.

## FCC Statement (United States Only)

This equipment has been tested and found to comply with the limits for a Class B digital device, pursuant to Part 15 of the FCC Rules. These limits are designed to provide reasonable protection against harmful interference in a residential installation. This equipment generates, uses and can radiate radio frequency energy and, if not installed and used in accordance with the instructions, may cause harmful interference to radio communications. However, there is no guarantee that interference will not occur in a particular installation. If this equipment does cause harmful interference to radio or television reception, which can be determined by turning the equipment off and on, the user is encouraged to try to correct the interference by one or more of the following measures:

- Reorient or relocate the receiving antenna.
- Increase the separation between the equipment and receiver.
- Consult the dealer or an experienced radio/TV technician for help.

Note: Changes or modifications not expressly approved by the manufacturer responsible for compliance could void the user's authority to operate the equipment.

This device complies with Part 15 of the FCC Rules.

Operation is subject to the following two conditions: (1) this device may not cause harmful interference and (2) this device must accept any interference received, including interference that may cause undesired operation.

## Care

- Wipe this toy with a clean cloth dampened with a mild soap and water solution. Do not immerse this toy.
- This toy has no consumer serviceable parts. Do not take this toy apart.

## ICES-003

- This Class B digital apparatus complies with Canadian ICES-003.
- Operation is subject to the following two conditions: (1) this device may not cause harmful interference and (2) this device must accept any interference received, including interference that may cause undesired operation.

## NMB-003

- Cet appareil numérique de la classe B est conforme à la norme NMB-003 du Canada.
- L'utilisation de ce dispositif est autorisée seulement aux conditions suivantes : (1) il ne doit pas produire de brouillage et (2) l'utilisateur du dispositif doit être prêt à accepter tout brouillage radioélectrique reçu, même si ce brouillage est susceptible de compromettre le fonctionnement du dispositif.

©Disney/Pixar

[www.disney.com/toystory](http://www.disney.com/toystory)

Fisher Price, Inc., a subsidiary of Mattel, Inc., East Aurora, NY 14052 U.S.A.

©2010 Mattel, Inc. All Rights Reserved. ® and ™ designate U.S. trademarks of Mattel, Inc., unless otherwise indicated.

## Battery Installation

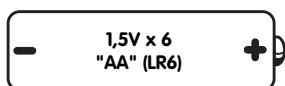

- Locate the battery compartment door on the bottom of each car.
- Loosen the screw in the battery compartment door with a Phillips screwdriver. Remove the battery compartment door.
- Insert three "AA" (LR6) **alkaline** batteries.

**Hint:** We recommend using **alkaline** batteries for longer battery life.

- Replace the battery compartment door and tighten the screw with a Phillips screwdriver. Do not over-tighten.
- If the toy begins to operate erratically, you may need to reset the electronics. Slide the power switch off and then back on.
- When sounds or motions from the car become faint or stop, it's time for an adult to change the batteries!



- Protect the environment by not disposing of this product with household waste (2002/96/EC). Check your local authority for recycling advice and facilities (Europe only).

## Battery Safety Information

In exceptional circumstances, batteries may leak fluids that can cause a chemical burn injury or ruin your product. To avoid battery leakage:

- Do not mix old and new batteries or batteries of different types: alkaline, standard (carbon-zinc) or rechargeable (nickel-cadmium).
- Insert batteries as indicated inside the battery compartment.
- Remove batteries during long periods of non-use. Always remove exhausted batteries from the product. Dispose of batteries safely. Do not dispose of this product in a fire. The batteries inside may explode or leak.
- Never short-circuit the battery terminals.
- Use only batteries of the same or equivalent type as recommended.
- Do not charge non-rechargeable batteries.
- Remove rechargeable batteries from the product before charging.
- If removable, rechargeable batteries are used, they are only to be charged under adult supervision.

# Race to Win!



- Slide the power switch on the bottom of each car ON ●.



- Shake a car to start the "engine" and the sound effects.
- Hint:** For maximum distance, shake the car 7 or 8 times. Shaking more than this does not increase the distance it will travel.

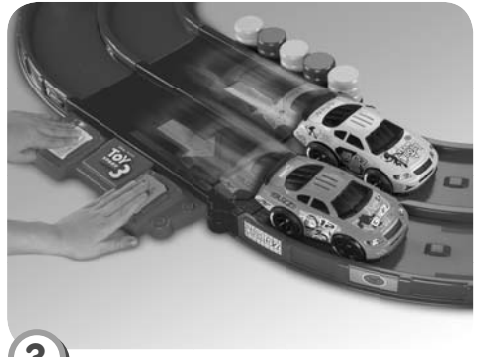

- Lift the both starting gates on the track.
- Set the cars on the arrows behind the starting line.
- When both cars are ready, press the pedal and you're off.

**Hint:** After shaking a car, place it anywhere on the track and watch it go. Fun sound effects and lights add to the excitement!

- When your car stops, pick it up, shake it and set it down again to rejoin the race.
- When you're finished playing, slide the power switch on each car OFF ○.

**Hint:** You can also race your cars on any smooth, flat surface. Shake the car, set it down and let it go.

## Free Manuals Download Website

<http://myh66.com>

<http://usermanuals.us>

<http://www.somanuals.com>

<http://www.4manuals.cc>

<http://www.manual-lib.com>

<http://www.404manual.com>

<http://www.luxmanual.com>

<http://aubethermostatmanual.com>

Golf course search by state

<http://golfingnear.com>

Email search by domain

<http://emailbydomain.com>

Auto manuals search

<http://auto.somanuals.com>

TV manuals search

<http://tv.somanuals.com>