

Barbie™

**B8776
Instructions**



Please keep this instruction sheet for future reference, as it contains important information.

Adult assembly is required.

Tools required for assembly: Phillips Screwdriver, Hammer and Scrap Block of Wood (not included).

If you have any questions about this product, or are missing a part, please call us toll-free at **1-800-432-5437, rather than return this product to the store.**

We are available between 8 AM - 6 PM EST Monday through Friday.

Hearing-impaired consumers using TTY/TTD equipment, please call **1-800-382-7470**.
Or write to: Fisher-Price® Consumer Relations, 636 Girard Avenue, East Aurora, N.Y. 14052.

Age: 2-5 years

Weight limit: 55 lbs (25 kg).

Fisher-Price®

www.fisher-price.com

Tough Trike

Download from www.Somanuals.com. All Manuals Search And Download.

Parts

WARNING

To avoid serious injury:

- Adult supervision is required.
- Never use near cars and other motor vehicles, near streets, steps, sloped drive-ways, hills, roadways, alleys, swimming pool areas or other bodies of water.
- Always wear shoes or sneakers.
- Never allow more than one rider.

CAUTION

This product contains small parts in its unassembled state. Adult assembly is required.

IMPORTANT!

- Please save all packaging material until assembly is complete to ensure that no parts are discarded.
- Please wipe each part with a clean, dry cloth before assembly.

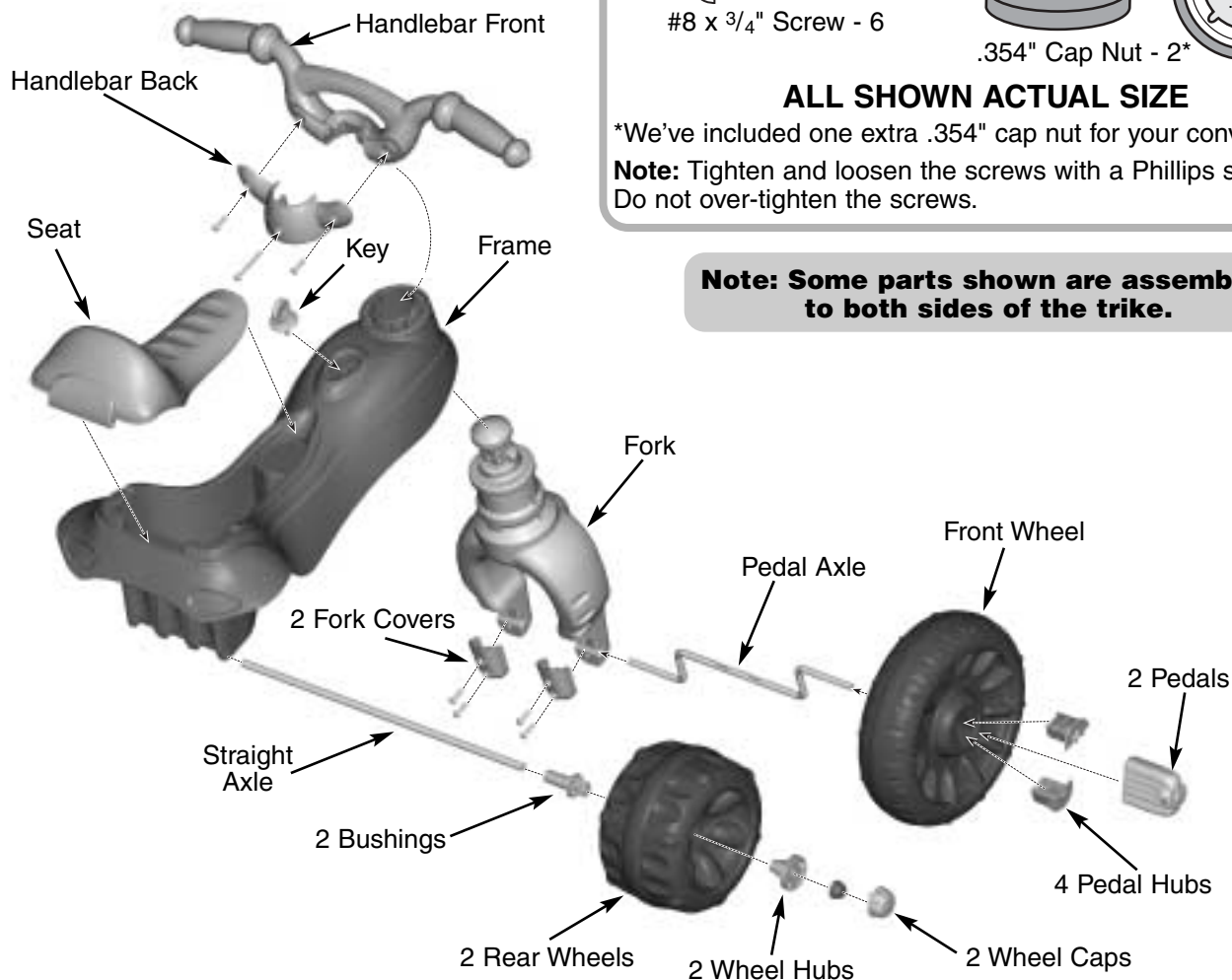

#8 x 2 1/4" Screw - 1



#8 x 3/4" Screw - 6



.354" Cap Nut - 2*

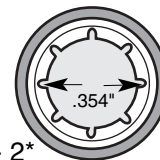

ALL SHOWN ACTUAL SIZE

*We've included one extra .354" cap nut for your convenience.

Note: Tighten and loosen the screws with a Phillips screwdriver. Do not over-tighten the screws.

Note: Some parts shown are assembled to both sides of the trike.

Part not shown: Label Sheet

Assembly

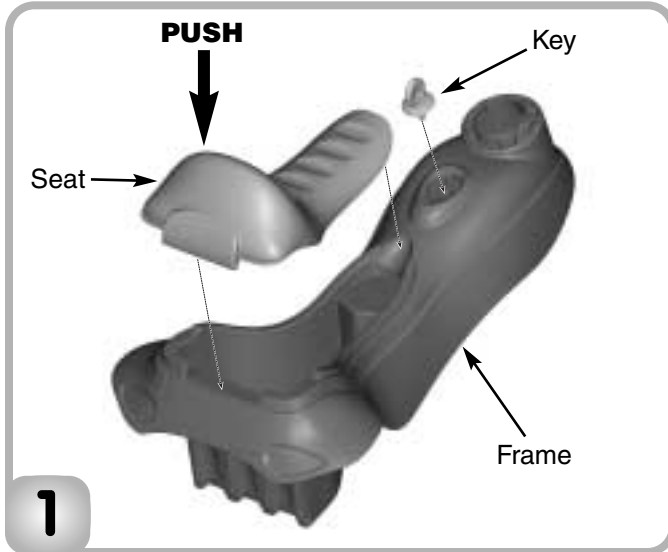

- Fit the seat onto the frame.
 - Push firmly near the back end of the seat to "**snap**" it into place.
 - Insert and "**snap**" the key into the frame.
- Hint:** You may need to tap the key with a hammer to secure it in place.

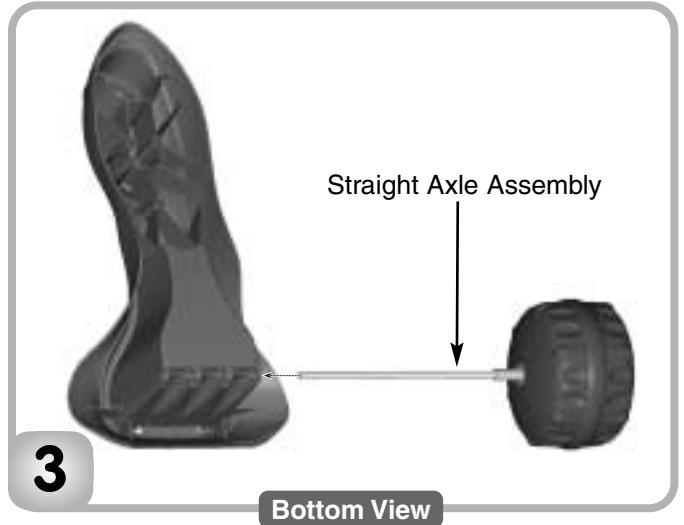

- Turn the frame upside down.
- Insert the straight axle assembly through the holes in the rear of the frame.

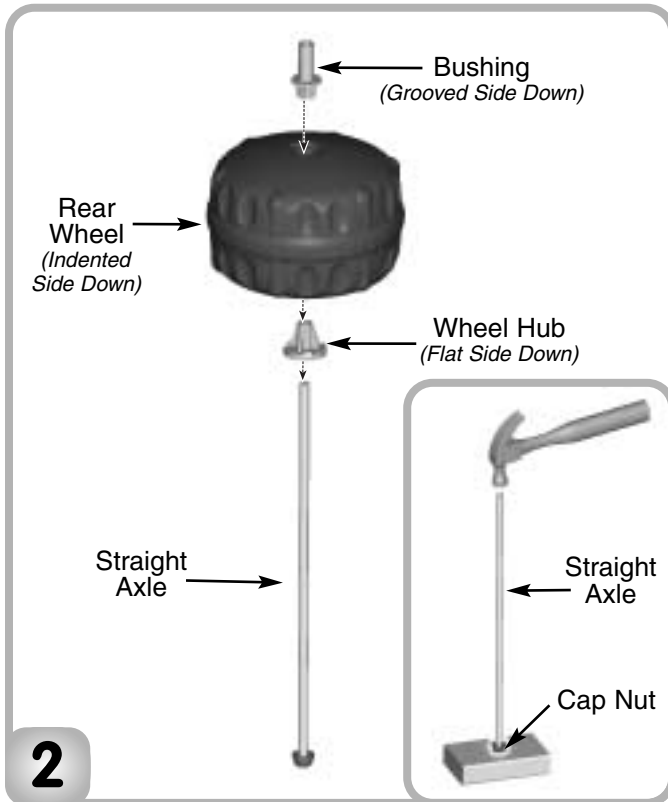

- Place one end of the straight axle into the cap nut. Tap the end of the straight axle with a hammer. **Make sure the cap nut is securely attached to the straight axle.**
- Slide a wheel hub, *flat side down*, onto the straight axle.
- Slide a rear wheel, *indented side down*, onto the straight axle.
- Slide a bushing, *grooved side down*, onto the straight axle.

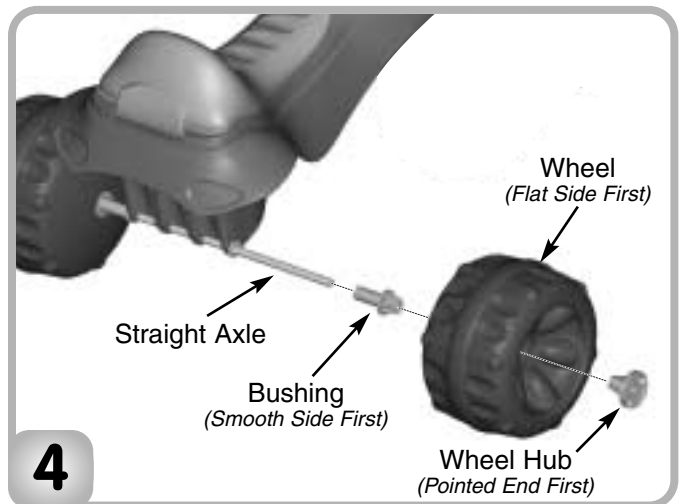

- Turn the assembly upright.
- Slide a bushing, *smooth side first*, onto the end of the straight axle.
- Slide a wheel, *flat side first*, onto the end of the straight axle.
- Slide a wheel hub, *pointed end first*, onto the end of the straight axle.

Assembly



5

- Fit the cap nut on the end of the straight axle.
- Tap the cap nut with a hammer. **Gently pull the rear wheel to be sure the cap nut is securely attached to the straight axle.**

Hint: You may need the help of another adult to hold the other end of the straight axle in place.



6

- Fit the tabs on the wheel cap into the slots in the wheel hub. Push to "**snap**" the wheel cap in place.
- Repeat this procedure to attach the other wheel cap to the other wheel hub.

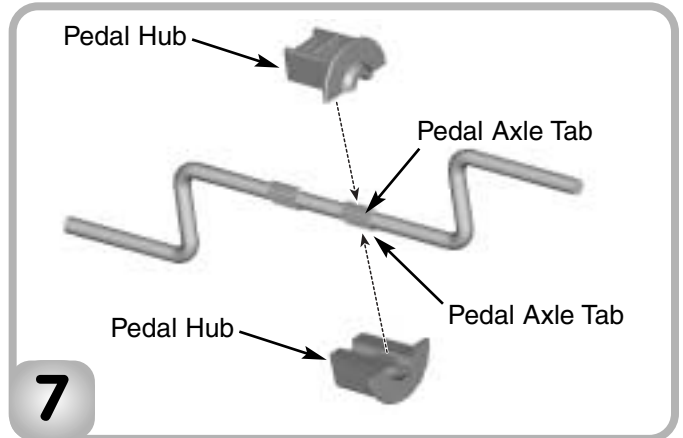

7

- Fit two pedal hubs onto the pedal axle tabs. Make sure the tabs fit into the slot in each pedal hub.

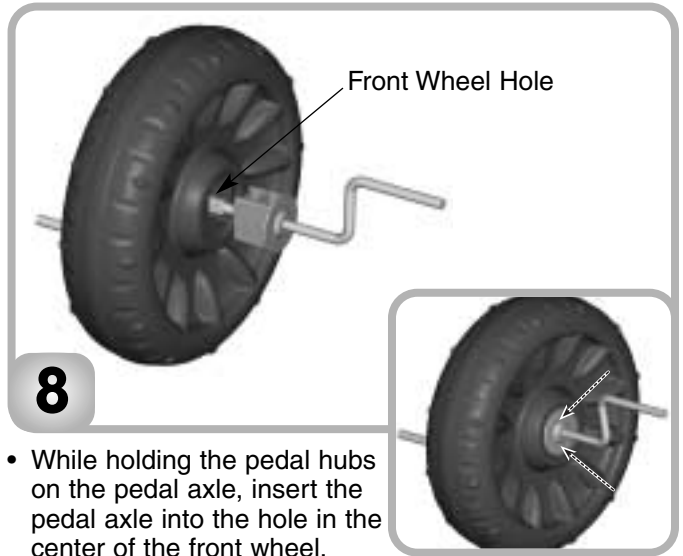

8

- While holding the pedal hubs on the pedal axle, insert the pedal axle into the hole in the center of the front wheel.
- Press the pedal hubs into the center of the front wheel until they are flush with the surface of the front wheel.

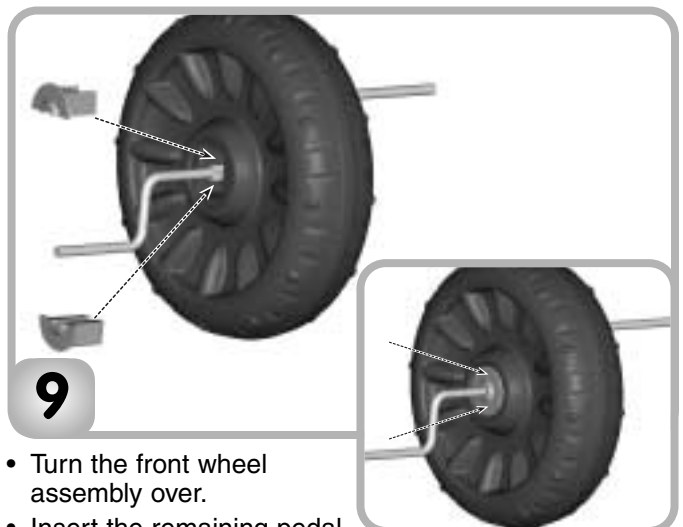

9

- Turn the front wheel assembly over.
- Insert the remaining pedal hubs on top of and below the pedal axle and into the hole in the center of the front wheel.
- Press the pedal hubs until they are flush with the surface of the front wheel.

Assembly

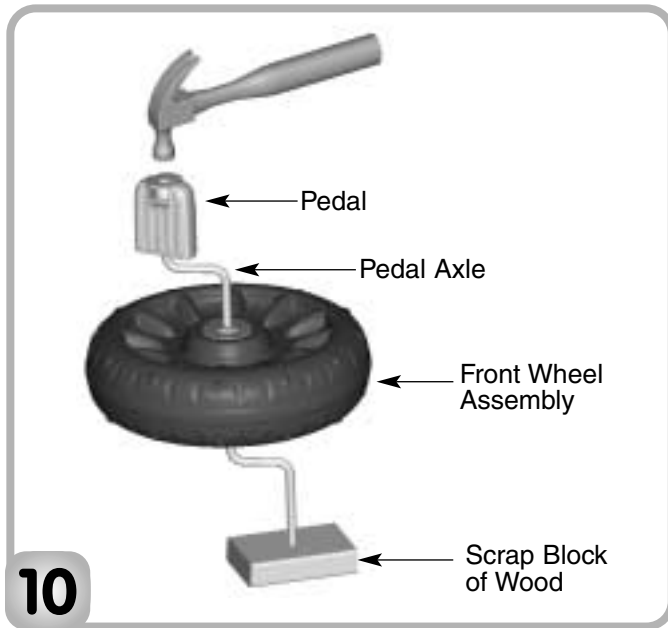

- 10

 - Place a scrap block of wood under the front wheel assembly.
 - Fit a pedal on the pedal axle. Tap the pedal with a hammer until it is secure.
 - Pull the pedal up to be sure it is secure. If you can remove it, you have not secured it properly. Tap it with the hammer again.
 - Repeat this procedure to attach the other pedal to the other end of the pedal axle.

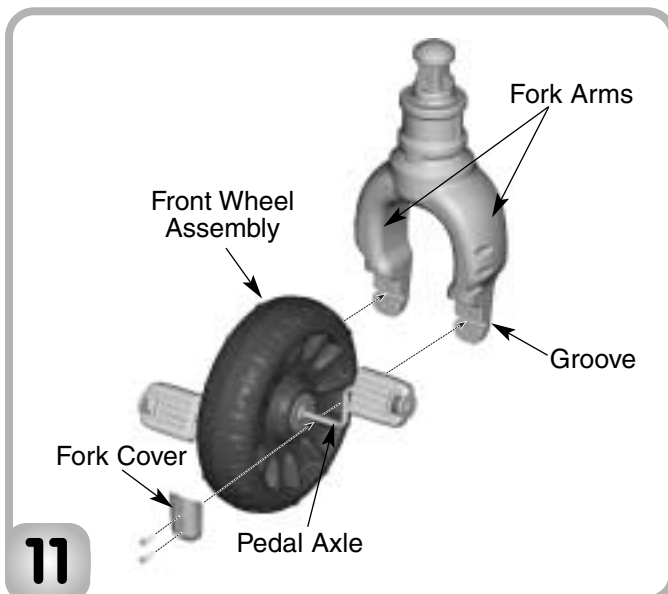

- 11

 - Place the front wheel assembly between the fork arms. Make sure the pedal axle fits into the groove at the bottom of each fork arm.
 - Place a fork cover over the pedal axle on one fork arm.
 - Insert two #8 x $\frac{3}{4}$ " screws into the fork cover and tighten.
 - Repeat this procedure to attach the other fork cover to the other fork arm.

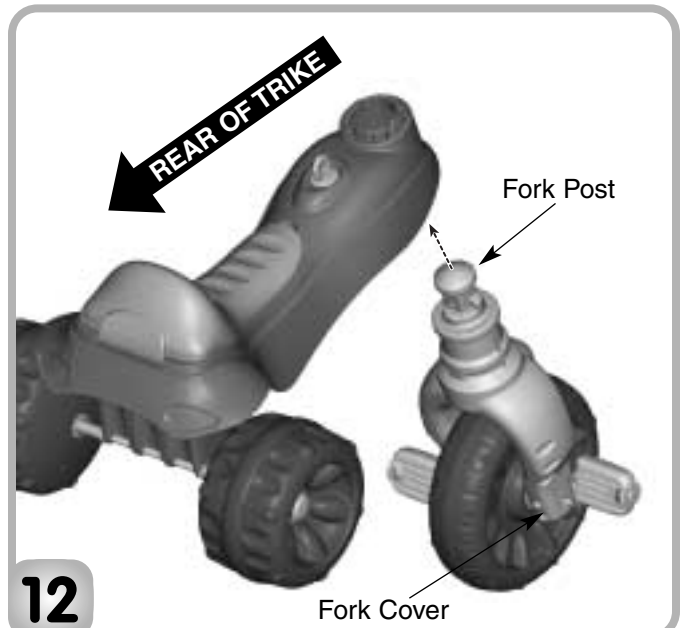

- 12

 - Insert the fork post up through the hole in the neck of the frame. Make sure the fork is positioned so that the fork covers face the rear wheels.

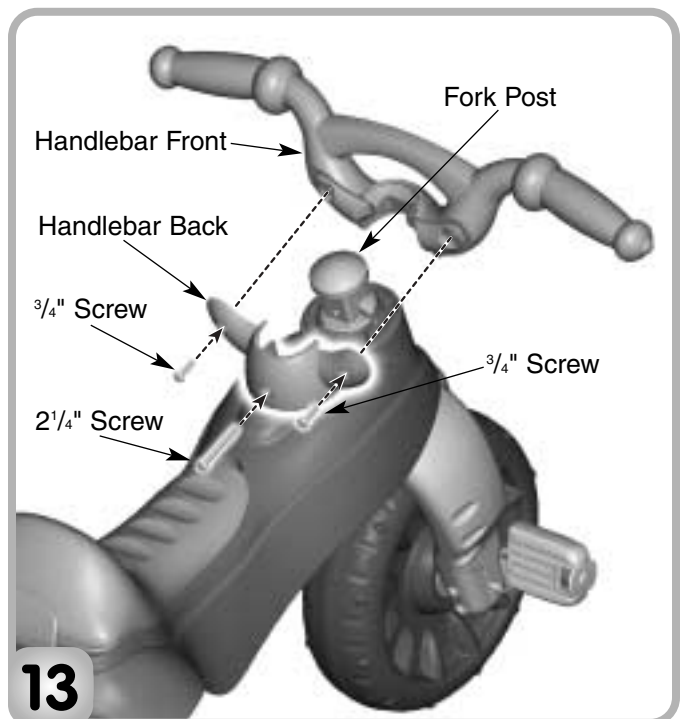

- 13

 - Fit the handlebar front to the fork post.
 - Hint: The handlebar front is designed to assemble to the fork post one way.*
 - Fit the handlebar back to the fork post and handlebar front. Hold them together firmly.
 - First, insert the remaining #8 x $\frac{3}{4}$ " screws through the outer holes in the handlebar back and tighten.
 - Then, insert the #8 x $2\frac{1}{4}$ " screw through the center hole in the handlebar back and tighten.

Label Decoration

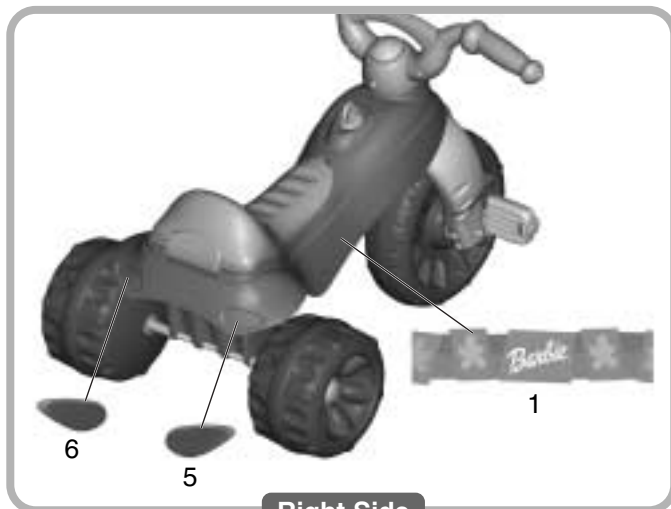

Right Side

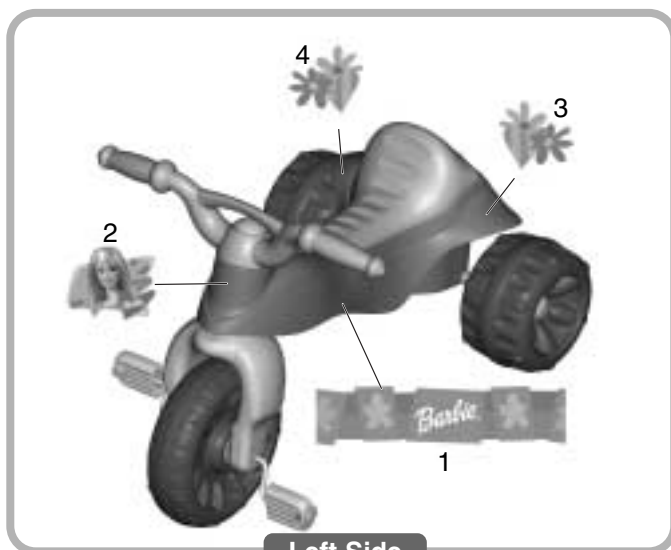

Left Side

Care

- Periodically, check the plastic parts and if broken or cracked, dispose of them properly.
- Periodically, check all fasteners regularly to be sure they are tight. If the fasteners are not tight, tighten them as necessary.
- To clean, use a mild soap and water solution and a clean cloth. Rinse clean with water to remove soap residue.

IMPORTANT! It is a good practice to start training children very young regarding the importance of helmet use. When children are older and riding bicycles and faster vehicles, it is important that they use a helmet each and every time they ride. For this reason, even while riding a tricycle, it is a good idea to familiarize your child with helmet use, so that it becomes a habit for life. Choose a helmet that complies with requirements of the applicable certifying agency for bicycle helmets.

For other countries outside the United States:

Canada: call 1-800-567-7724, or write to: Mattel Canada Inc., 6155 Freemont Blvd., Mississauga, Ontario L5R 3W2.

Great Britain: telephone 01628 500302.

Australia: Mattel Australia Pty. Ltd., 658 Church Street, Locked Bag #870, Richmond, Victoria 3121 Australia. Consumer Advisory Service 1300 135 312.

New Zealand: 16-18 William Pickering Drive, Albany 1331, Auckland.

Asia: Mattel East Asia Ltd, Room 1106, South Tower, World Finance Centre, Harbour City, Tsimshatsui, HK, China.

Proper label application will help to keep the labels looking their best!

- Wash your hands before applying the labels.
- Make sure the areas where the labels will be applied are clean and dry. Wipe your vehicle with a clean, soft, dry cloth to remove any dust or oils.
- For best results, avoid applying a label more than once.
- Apply the labels as shown in the illustration above.
- After applying a label, rub the label firmly with a cloth to make sure the label is adhered to your vehicle.

Assembly is complete.

BARBIE is a U.S. trademark of Mattel, Inc.

Fisher-Price, Inc., a subsidiary of Mattel, Inc., East Aurora, NY 14052 U.S.A.
©2003 Mattel, Inc. All Rights Reserved. ® and ™ designate U.S. trademarks of Mattel, Inc.

Download from www.Somanuals.com. All Manuals Search And Download.

Free Manuals Download Website

<http://myh66.com>

<http://usermanuals.us>

<http://www.somanuals.com>

<http://www.4manuals.cc>

<http://www.manual-lib.com>

<http://www.404manual.com>

<http://www.luxmanual.com>

<http://aubethermostatmanual.com>

Golf course search by state

<http://golfingnear.com>

Email search by domain

<http://emailbydomain.com>

Auto manuals search

<http://auto.somanuals.com>

TV manuals search

<http://tv.somanuals.com>