



www.fisher-price.com

N6021



Please keep this instruction sheet for future reference,  
as it contains important information.

Adult assembly is required.

Tools required for assembly: Phillips Screwdriver,  
Hammer and Scrap Block of Wood (not included).

Age: 2-5 years

Weight limit: 55 lbs (25 kg).

# Consumer Information



## WARNING

### To avoid serious injury:

- Adult supervision is required.
- Never use near cars and other motor vehicles, near streets, steps, sloped driveways, hills, roadways, alleys, swimming pool areas or other bodies of water.
- Always wear shoes or sneakers.
- Never allow more than one rider.



## CAUTION

This product contains small parts in its unassembled state. Adult assembly is required.

### IMPORTANT!

- Please save all packaging material until assembly is complete to ensure that no parts are discarded.
- Please wipe each part with a clean, dry cloth before assembly.

## Parts

Note: Some parts shown are assembled to both sides of the trike.

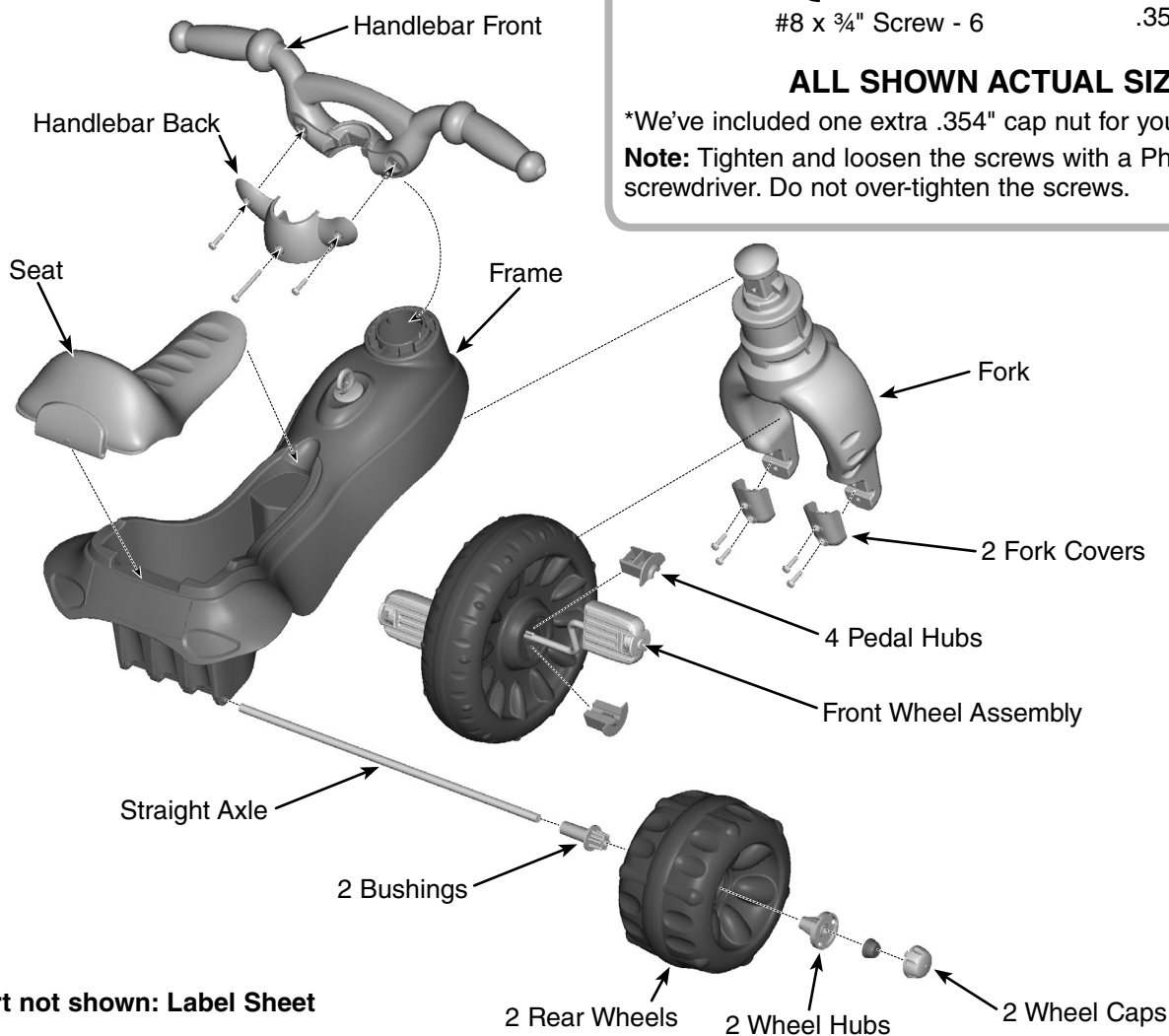

Part not shown: Label Sheet



#8 x 2 1/4" Screw - 1



#8 x 3/4" Screw - 6

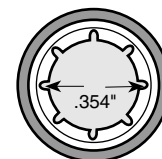

.354" Cap Nut - 2\*

### ALL SHOWN ACTUAL SIZE

\*We've included one extra .354" cap nut for your convenience.

Note: Tighten and loosen the screws with a Phillips screwdriver. Do not over-tighten the screws.

# Assembly

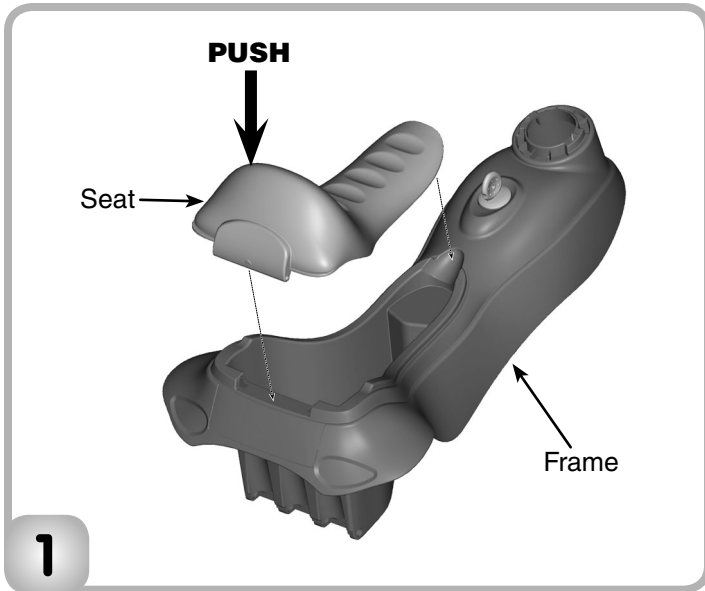

- Fit the seat onto the frame.
- Push firmly near the back end of the seat to "snap" it into place.

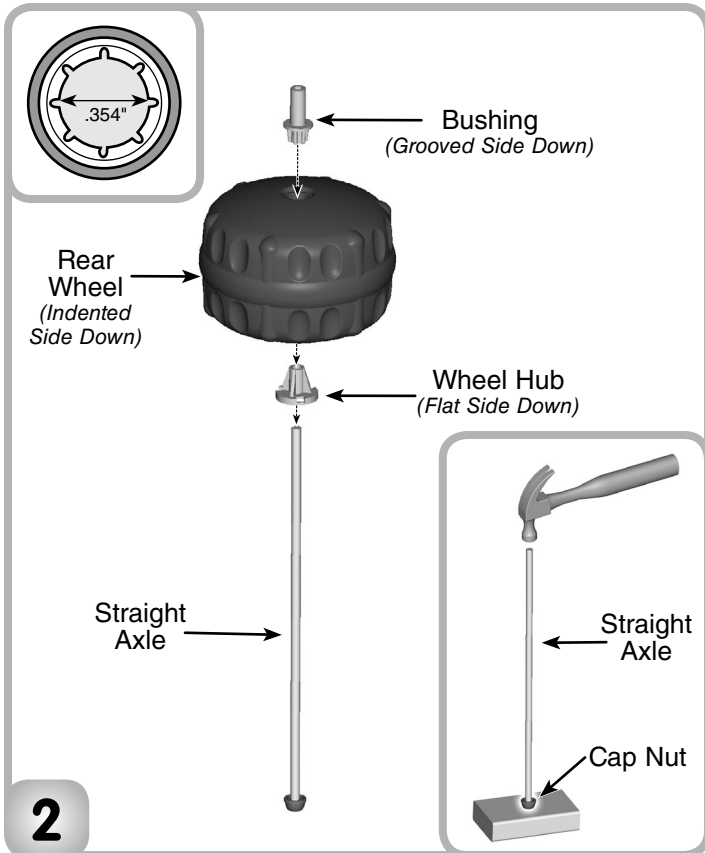

- Place one end of the straight axle into the cap nut. Tap the end of the straight axle with a hammer. **Make sure the cap nut is securely attached to the straight axle.**
- Slide a wheel hub, *flat side down*, onto the straight axle.
- Slide a rear wheel, *indented side down*, onto the straight axle.
- Slide a bushing, *grooved side down*, onto the straight axle.

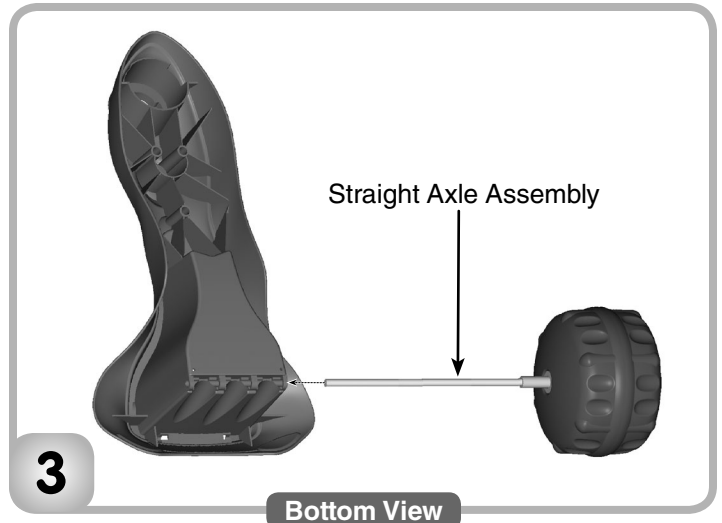

- Turn the frame upside down.
- Insert the straight axle assembly through the holes in the rear of the frame.

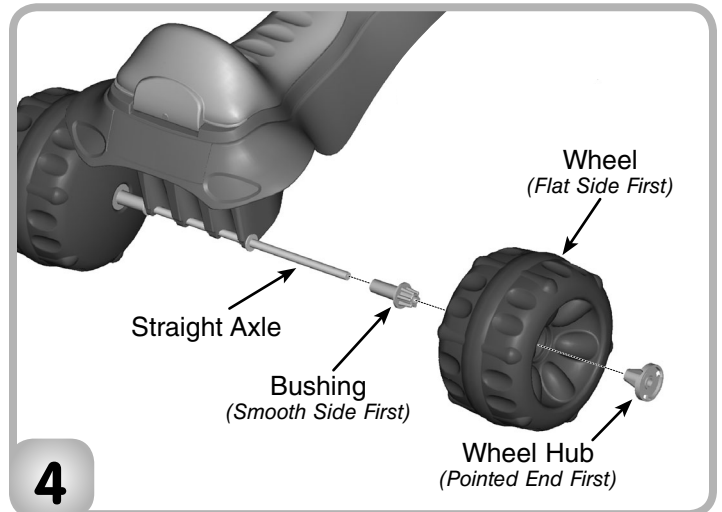

- Turn the assembly upright.
- Slide a bushing, *smooth side first*, onto the end of the straight axle.
- Slide a wheel, *flat side first*, onto the end of the straight axle.
- Slide a wheel hub, *pointed end first*, onto the end of the straight axle.

# Assembly

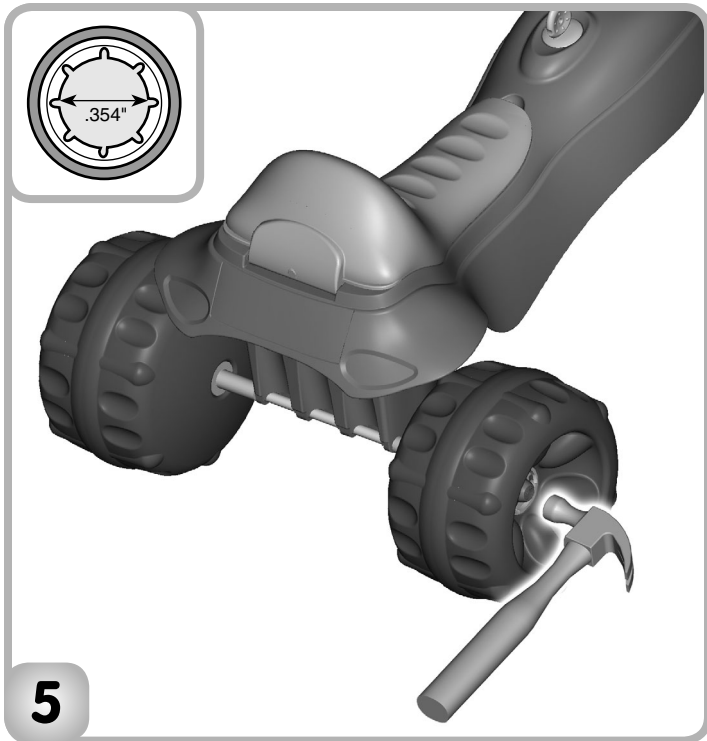

5

- Fit the cap nut on the end of the straight axle.
- Tap the cap nut with a hammer. **Gently pull the rear wheel to be sure the cap nut is securely attached to the straight axle.**

*Hint:* You may need the help of another adult to hold the other end of the straight axle in place.

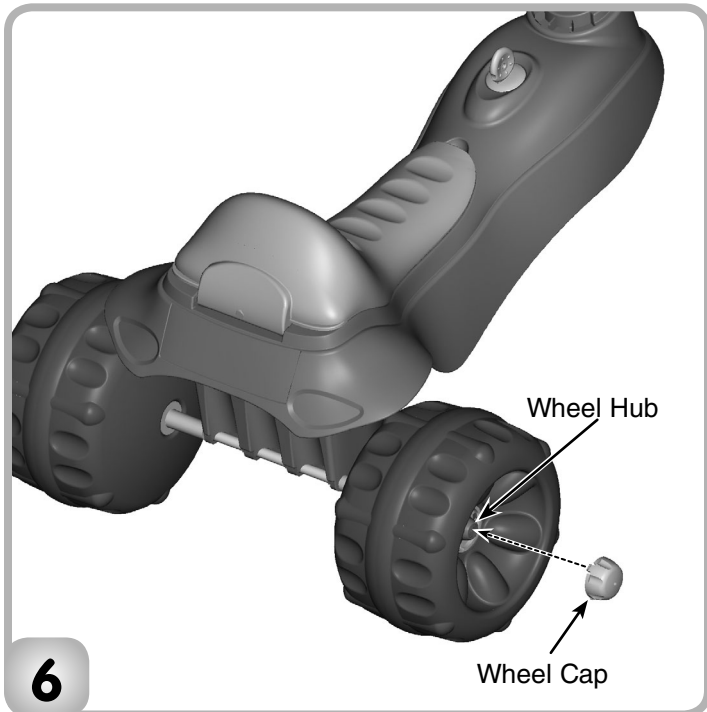

6

- Fit the tabs on the wheel cap into the slots in the wheel hub. Push to "**snap**" the wheel cap in place.
- Repeat this procedure to attach the other wheel cap to the other wheel hub.

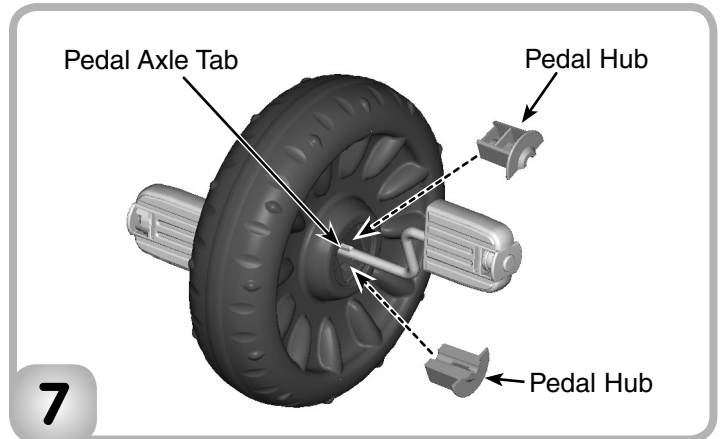

7

- Fit two pedal hubs onto the pedal axle tabs. Make sure the tabs fit into the slot in each pedal hub.
- While holding the pedal hubs on the pedal axle, insert the pedal axle into the hole in the center of the front wheel.
- Press the pedal hubs into the center of the front wheel until they are flush with the surface of the front wheel.
- Repeat this procedure on the other side with the other two pedal hubs.

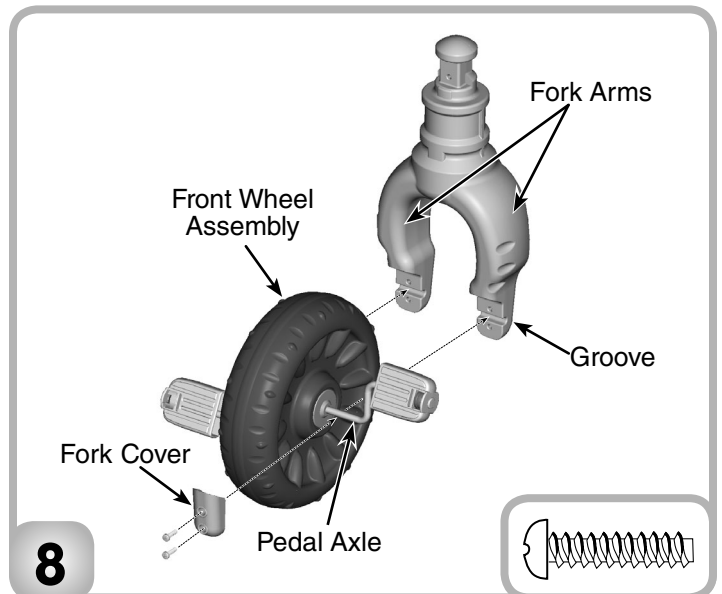

8

- Place the front wheel assembly between the fork arms. Make sure the pedal axle fits into the groove at the bottom of each fork arm.
- Place a fork cover over the pedal axle on one fork arm.
- Insert two #8 x 3/4" screws into the fork cover and tighten.
- Repeat this procedure to attach the other fork cover to the other fork arm.

## Label Decoration

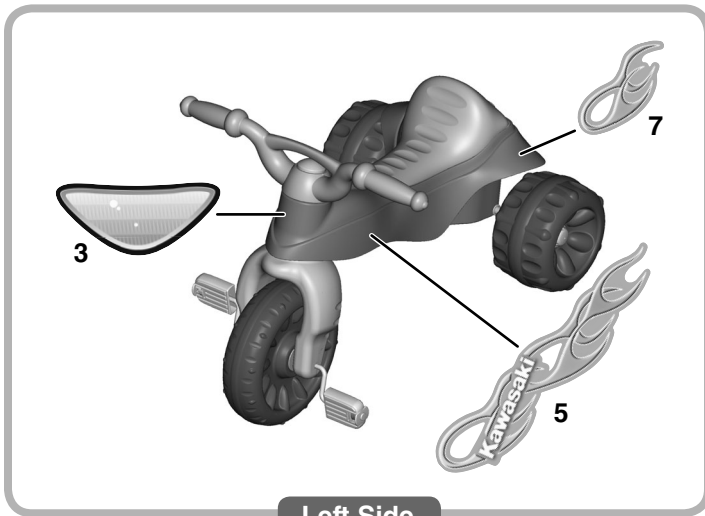
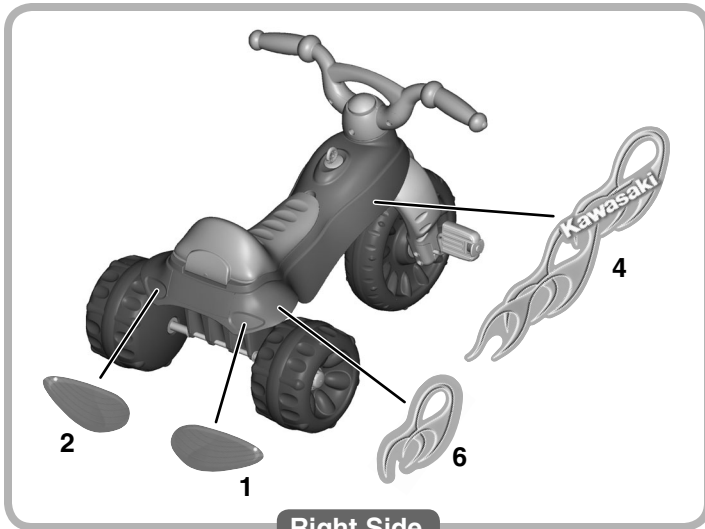

- Wipe the vehicle with a clean, dry cloth to remove any oils before applying labels.
- Apply labels exactly as shown in the illustrations. For best results, avoid repositioning the label after it has been applied.
- Starting at the center of a label rub firmly with a dry cloth, and smooth towards the outer edges to remove air bubbles.

## Consumer Information

- Periodically, check the plastic parts and if broken or cracked, dispose of them properly.
- Periodically, check all fasteners regularly to be sure they are tight. If the fasteners are not tight, tighten them as necessary.
- To clean, use a mild soap and water solution and a clean cloth. Rinse clean with water to remove soap residue.

**IMPORTANT!** It is a good practice to start training children very young regarding the importance of helmet use. When children are older and riding bicycles and faster vehicles, it is important that they use a helmet each and every time they ride. For this reason, even while riding a tricycle, it is a good idea to familiarize your child with helmet use, so that it becomes a habit for life. Choose a helmet that complies with requirements of the applicable certifying agency for bicycle helmets.

### CONSUMER ASSISTANCE

1-800-432-5437 (US & Canada)  
1300 135 312 (Australia)

## service.fisher-price.com

Fisher-Price, Inc., 636 Girard Avenue, East Aurora, NY 14052.  
Hearing-impaired consumers: 1-800-382-7470.

Outside the United States:

Canada: Mattel Canada Inc., 6155 Freemont Blvd.,  
Mississauga, Ontario L5R 3W2; [www.service.mattel.com](http://www.service.mattel.com).

Great Britain: Mattel UK Ltd, Vanwall Business Park,  
Maidenhead SL6 4UB. Helpline: 01628 500303.  
[www.service.mattel.com/uk](http://www.service.mattel.com/uk)

Mattel Europa, B.V., Gondel 1, 1186 MJ Amstelveen, Nederland.

Australia: Mattel Australia Pty. Ltd., 658 Church Street,  
Locked Bag #870, Richmond, Victoria 3121 Australia.

New Zealand: 16-18 William Pickering Drive,  
Albany 1331, Auckland.

Kawasaki trademarks used under license to Fisher-Price, Inc.

Fisher-Price, Inc., a subsidiary of Mattel, Inc., East Aurora, NY 14052 U.S.A.

©2010 Mattel, Inc. All Rights Reserved. ® and ™ designate U.S. trademarks of Mattel, Inc., unless otherwise indicated.

# Assembly

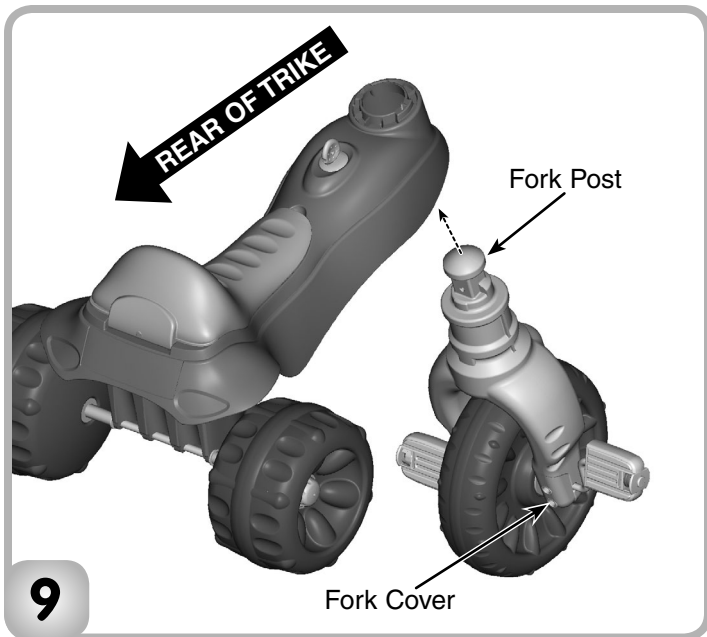

- Insert the fork post up through the hole in the neck of the frame. Make sure the fork is positioned so that the fork covers face the rear wheels.

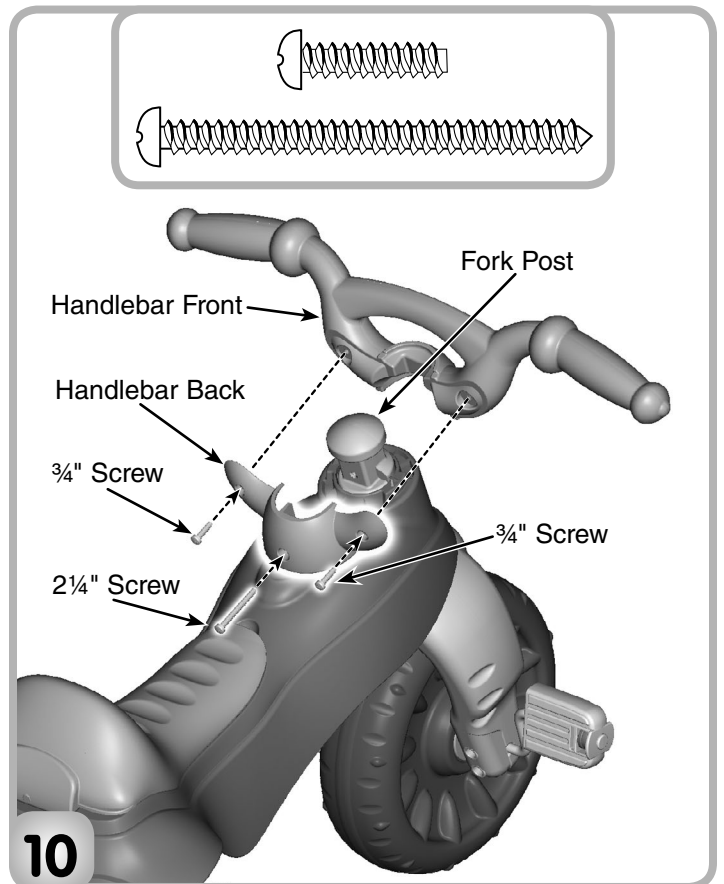

- Fit the handlebar front to the fork post.  
**Hint:** The handlebar front is designed to assemble to the fork post one way.
- Fit the handlebar back to the fork post and handlebar front. Hold them together firmly.
- First, insert the remaining #8 x 3/4" screws through the outer holes in the handlebar back and tighten.
- Then, insert the #8 x 2 1/4" screw through the center hole in the handlebar back and tighten.

## Free Manuals Download Website

<http://myh66.com>

<http://usermanuals.us>

<http://www.somanuals.com>

<http://www.4manuals.cc>

<http://www.manual-lib.com>

<http://www.404manual.com>

<http://www.luxmanual.com>

<http://aubethermostatmanual.com>

Golf course search by state

<http://golfingnear.com>

Email search by domain

<http://emailbydomain.com>

Auto manuals search

<http://auto.somanuals.com>

TV manuals search

<http://tv.somanuals.com>