



Fisher-Price®

Safe Embrace® Convertible Car Seat

Owner's Manual

Download from www.Somanuals.com All Manuals Search And Download.

Model 7701

Table of Contents

Message to Parents	2
WARNINGS	3
For Your Information	6
All About Your Car Seat	7
Selecting a Vehicle Seating Location for Your Car Seat	9
What Kind of Vehicle Belt System Do You Have?	11
NEVER USE These Vehicle Belt Systems	12
ONLY USE These Vehicle Belt Systems	13

Rear-Facing Position

Birth to 1 Year (6-30 lbs.)..... 14

Setup	
5-Point Harness	16
Seat Position - Recline	21
Installing Your Car Seat in a Vehicle	22
Restraining Your Child	31

Forward-Facing Position

1 Year and Up (22-40 lbs.)..... 36

Tether Anchor Installation	38
Setup	
5-Point Harness	44
Seat Position - Upright	49
Installing Your Car Seat in a Vehicle	50
Restraining Your Child	58

Consumer Information	65
Aircraft Use	66
Registering Your Car Seat	67
Cleaning and Washing	68

Message to Parents



Thank you for choosing the Fisher-Price® Safe Embrace® Convertible Car Seat. Before you use this car seat, please take time to read and understand this manual completely. It includes important step-by-step instructions on how to properly install this car seat and restrain your child. **DO NOT** allow others to use this car seat until they understand these instructions. **Your child's safety depends on you!**

The Safe Embrace® Convertible Car Seat has more ways to keep your child safe than any other car seat. For example, the Safe Embrace® Convertible Car Seat and this manual are color-coded for easy setup, installation and use – follow **blue for birth to 1 year (6-30 lbs.) rear-facing** and **burgundy for 1 year and up (22-40 lbs.) forward-facing**. We've also equipped the Safe Embrace® Convertible Car Seat with a tether strap for use in the forward-facing position. Child restraint industry experts agree that the use of a tether strap with a forward-facing car seat significantly reduces the risk of head injuries in a sudden stop or crash.



WARNING

Proper installation and use depends on you! If you do not follow the instructions in this manual and the labels on the car seat, paying particular attention to the warning statements, your child could be at risk of striking the vehicle's interior during a sudden stop or crash, resulting in serious injury or death.



ALWAYS secure this car seat with your vehicle belt system exactly as described in this manual. Refer also to your vehicle owner's manual for specific information on your vehicle belt system and specific instructions on how to install a car seat in your vehicle.



NEVER install the car seat in the rear-facing position in a vehicle seating location equipped with an airbag. The airbag impact can cause severe head injury or death. If your vehicle is equipped with a front passenger side airbag, please refer to your vehicle owner's manual for child restraint installation instructions.



NEVER install and restrain a child less than 1 year of age in this car seat facing the front of the vehicle. You must install the car seat in the rear-facing position to avoid serious neck injuries in a sudden stop or crash.



WARNING



ALWAYS use the tether strap in the forward-facing position. Your child's safety is significantly enhanced in the event of a crash if the tether strap is used. The tether strap significantly reduces forward motion of your child's head during a crash, greatly reducing the likelihood of head injury.



NEVER use the chest clip with a child whose shoulder height is below the middle blue shoulder strap slots. The chest clip could pose a strangulation hazard to small infants.



NEVER use the upper burgundy shoulder strap slots with a child in the rear-facing position. The shoulder straps will not be snug against your child and your child will not be properly restrained. Use the lower or middle blue shoulder strap slots when using the car seat rear-facing.



NEVER use the lower or middle blue shoulder strap slots with a child in the forward-facing position. The shoulder straps could fall off your child's shoulders and your child will not be properly restrained. Use the upper burgundy shoulder strap slots when using the car seat forward-facing.



NEVER allow the shoulder straps to be loose around your child. If the shoulder straps are not snug against your child, your child will not be properly restrained.



WARNING



NEVER dress your child in clothing that interferes with positioning the crotch strap between your child's legs. If the crotch strap is not positioned between your child's legs, your child could eject from the car seat in a crash.



NEVER leave an unsecured car seat in your vehicle. If left unsecured, the car seat could injure other occupants in a sudden stop or crash.



NEVER use the car seat after it is involved in an accident. An accident can cause damage to the car seat that you cannot see.

For Your Information

- Please read this entire manual carefully before using this car seat. Keep this manual in the pocket on the car seat for easy reference.
- This child restraint system conforms to all applicable Federal Motor Vehicle Safety Standards and is certified for use in motor vehicles and aircraft.
- The rear-facing position is the safest position from birth to 1 year old (6-30 lbs., 3-14 kg). If your child is less than 1 year old, **DO NOT** use this car seat in the forward-facing position.
- The American Academy of Pediatrics recommends that infants be restrained in a rear-facing car seat until they are at least 1 year of age **and** 20 lbs. to reduce the risk of cervical spine injury in the event of a crash. Since an infant's head size is very large relative to body size and the neck is still developing strength, a rear-facing car seat is safer because it better supports an infant's head and back in the event of a frontal crash.
- The forward-facing position is for children 1 year and up that range in size from 22-40 lbs. (10-18 kg) and up to 40" (102 cm) tall.
- If your child weighs 22-40 lbs. but cannot sit upright unassisted, please contact your physician to determine how best to use a car seat.
- Complete the registration card attached to the car seat and mail it in today!
- If your vehicle was manufactured **in or after 1985**, Fisher-Price® recommends that you contact your vehicle dealer to obtain a tether anchor kit that is specifically designed for your vehicle. Most vehicle manufacturers supply these kits free of charge.
- If your vehicle was manufactured **before 1985**, or a tether anchor kit is not available for your particular vehicle, use the universal tether anchor kit provided with your Safe Embrace® Convertible Car Seat.

This car seat will ke

Tether Strap Attachment

Additional belt anchoring car seat directly to your vehicle's frame, reducing forward motion in an accident and significantly reducing the potential for injury.

Energy Absorbing Foam

Surrounds your child with an extra layer of protection.

Color-Coded Installation

Makes it easier to route and position belts correctly; follow blue for rear-facing position and burgundy for forward-facing position.

Steel Frame Construction

Adds greater strength than car seats with all plastic frames.

Five-Point Harness

A safer way to restrain your child in an accident, with wider belts that more gently distribute the force of a crash.

Built-in Locking Clips

Make it easier and more convenient to firmly secure the car seat.

Safer Fit In Your Vehicle

Contoured base and vehicle belt routes designed for a more secure fit in virtually all vehicles.

Keep your child safer.



The safety features of this Fisher-Price® car seat will reduce the risk of injury to your child in an accident; however, no car seat can prevent serious injury or death in all accidents.

Selecting a Vehicle Seating Location for Your Car Seat

IMPORTANT!

- Accident statistics show that children are **safer when properly secured in rear vehicle seating locations than in front seating locations.**
- When installing this car seat in your vehicle for forward-facing use, only use the front seat when no acceptable rear seating location is available. If the front seating location is equipped with an airbag, but must be used to install this car seat in the forward-facing position, adjust the vehicle seat as far back from the dashboard as possible. Please refer to your vehicle owner's manual regarding front seat, forward-facing child restraint use.



WARNING

NEVER install the car seat in the rear-facing position in a vehicle seating location equipped with an airbag. The airbag impact can cause severe head injury or death. If your vehicle is equipped with a front passenger side airbag, please refer to your vehicle owner's manual for child restraint installation instructions.



Selecting a Vehicle Seating Location for Your Car Seat

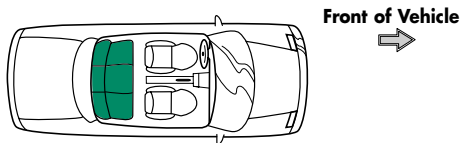

The rear seating locations are **ALWAYS** preferred.

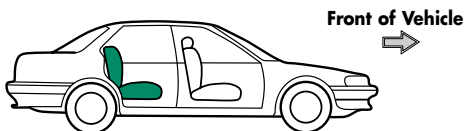

ALWAYS use vehicle seats that face the front of the vehicle.

NEVER use vehicle seats that face the side of the vehicle.

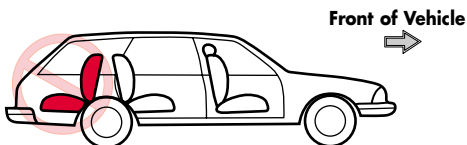
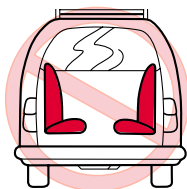

NEVER use vehicle seats that face the rear of the vehicle.

What Kind of Vehicle Belt System Do You Have?



WARNING

ALWAYS secure this car seat with your vehicle belt system exactly as described in this manual. Refer also to your vehicle owner's manual for specific information on your vehicle belt system and specific instructions on how to install a car seat in your vehicle.

There are many different types of vehicle belt systems. Some vehicle belt systems can never be used to install this car seat. Check to determine which type of vehicle belt system or systems you have. Many vehicles have more than one type of vehicle belt system. For example, you may find lap only belts in the center seating location and lap and shoulder belts in the side seating locations. If you are not sure which type of vehicle belt system you have, contact your vehicle dealer or manufacturer.

The illustrations on the next two pages show vehicle belt systems that you can use and can never use to install the car seat. If you do not have a seating location with an acceptable vehicle belt system, **DO NOT** use the car seat. Contact your vehicle manufacturer. The vehicle manufacturer may be able to install a vehicle belt system that will be able to secure the car seat properly. **NEVER** alter your vehicle belt system yourself.

IMPORTANT!

Some vehicles are equipped with an emergency locking retractor (ELR) lap belt system. An ELR lap belt system requires the use of a heavy duty locking clip to install child restraints. **NEVER** use the built-in locking clip on this car seat **in place** of a heavy duty locking clip. Refer to your vehicle owner's manual for specific information.

NEVER USE These Vehicle Belt Systems



NEVER USE

Door Mounted Lap and Shoulder Belt

Explanation

The lap and shoulder belt system is attached to the vehicle's door and moves when the door is opened. You will not be able to keep the car seat secure.



NEVER USE

Motorized Shoulder Belt

Explanation

The shoulder belt moves along a track when the door is opened or when the vehicle is started. You will not be able to keep the car seat secure.

ONLY USE These Vehicle Belt Systems

USE

Manual Lap Belt

Explanation

The lap belt is tightened by pulling on its free end.

USE

Automatic Locking Retractor Lap Belt

Explanation

The lap belt slack retracts automatically and locks. It can be further tightened by pushing the belt in near the retractor.

USE

Lap and Shoulder Belt with Sliding Latch Plate

Explanation

Pull on the shoulder portion of the belt to tighten. The shoulder belt retracts automatically.

USE

Lap and Shoulder Belt with Locking Latch Plate

Explanation

Pull on the shoulder portion of the belt to tighten.

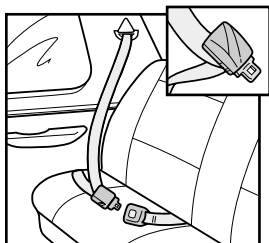
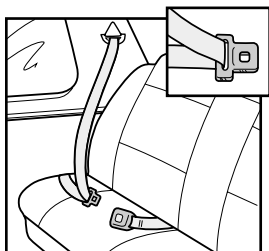
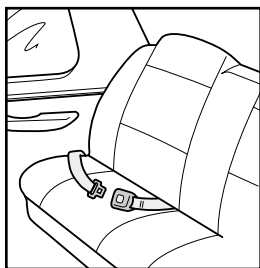
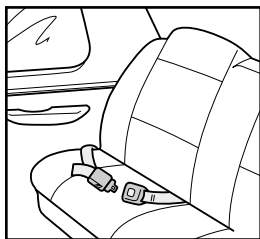

Rear-Facing Position

Birth to 1 Year (6-30 lbs.)

Your Safe Embrace® Convertible Car Seat is color-coded for easy setup, installation and use. Use blue areas on the car seat for the rear-facing position.



Rear-Facing Position Birth to 1 Year (6-30 lbs.)

REAR-FACING POSITION BIRTH TO 1 YEAR (6-30 LBS.)

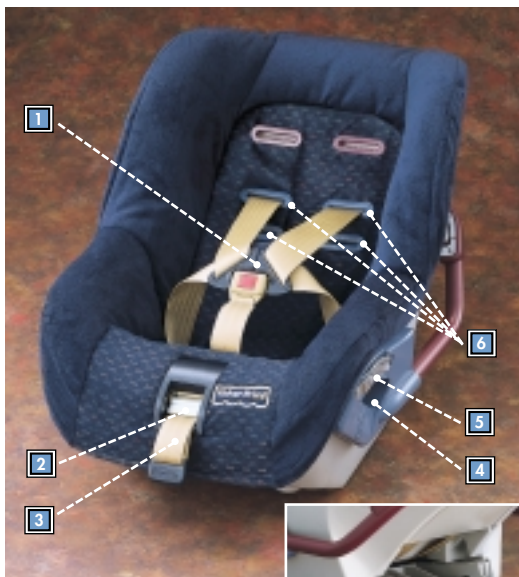

- 1** 5-Point Harness
– Shoulder Straps*
– Lap Straps
– Crotch Strap
with Buckle

- 2** Harness
Release Lever

- 3** Harness
Adjustment Strap

- 4** Rear-Facing Position
Vehicle Belt
Path Opening

- 5** Rear-Facing
Position
Locking Clip

- 6** Rear-Facing
Blue Shoulder
Strap Slots

- 7** Seat Position
Adjuster
– Recline for
Rear-Facing
Position

*When purchased, the car seat is factory assembled for rear-facing use with the shoulder straps in the lower blue shoulder strap slots.

Setup 5-Point Harness

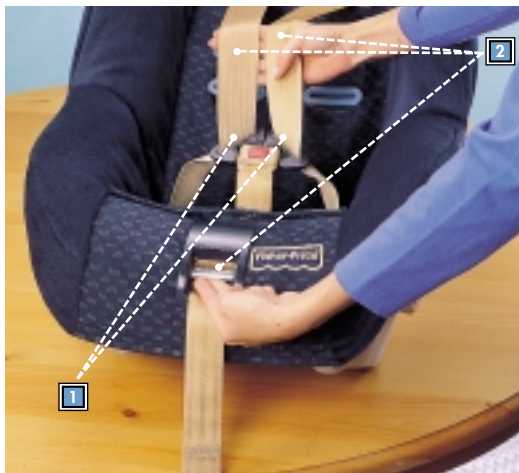

- 1** Make sure both shoulder straps are inserted into the buckle.
- 2** Lift the harness release lever and pull the shoulder straps out as far as you can on the front of the car seat.



WARNING

NEVER use the upper burgundy shoulder strap slots with a child in the rear-facing position. The shoulder straps will not be snug against your child and your child will not be properly restrained. Use the lower or middle blue shoulder strap slots when using the car seat rear-facing.

REAR-FACING POSITION BIRTH TO 1 YEAR (6 - 30 LBS.)

Setup 5-Point Harness



- 3** Open the connector bar cover on the back of the car seat.
- 4** Pull the connector bar up.
- 5** Remove each shoulder strap from each end of the connector bar, as shown.

Setup 5-Point Harness

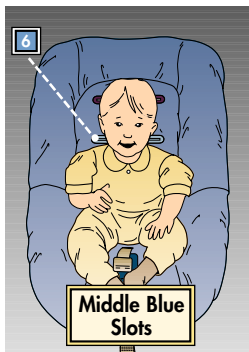
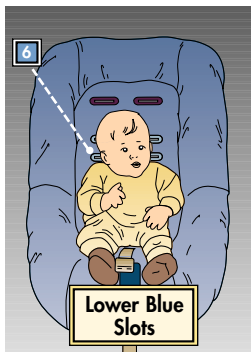

- 6 Place your child in the car seat to select the appropriate lower or middle blue shoulder strap slots.

If your child's shoulders are above the lower blue shoulder strap slots, use the middle blue shoulder strap slots.

REAR-FACING POSITION BIRTH TO 1 YEAR (6 - 30 LBS.)

Setup 5-Point Harness



- 7** Remove the shoulder straps from the shoulder strap slots (and the chest clip if previously used) on the front of the car seat. Re-insert the shoulder straps through either the lower or middle blue shoulder strap slots. **Make sure the shoulder straps are not twisted.**

HINT The chest clip can be used in the rear-facing position **only** if your child's shoulders are **at or above the middle blue shoulder strap slots**. Please refer to page 46 to assemble the chest clip to the shoulder straps.

IMPORTANT!

If you are converting the car seat from forward-facing use to rear-facing use, **REPOSITION THE SHOULDER STRAPS IN THE LOWER OR MIDDLE BLUE SHOULDER STRAP SLOTS.**

Setup 5-Point Harness

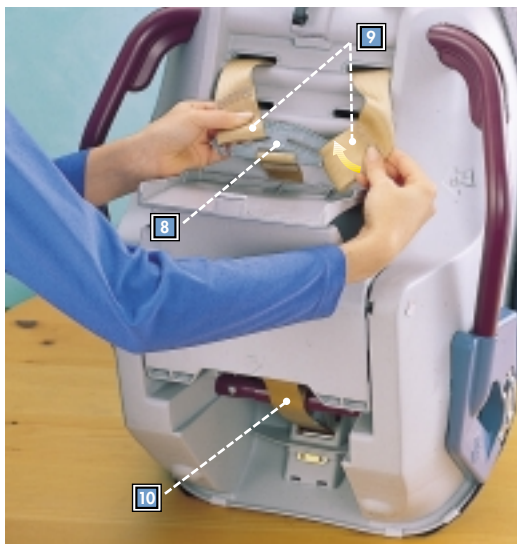

- 8** Pull the connector bar up on the back of the car seat.
- 9** Re-attach the shoulder straps to the connector bar. **Make sure the shoulder straps are not twisted.**
- 10** **Make sure the connector bar strap is not twisted.**

REAR-FACING POSITION BIRTH TO 1 YEAR (6 - 30 LBS.)

Setup Seat Position – Recline

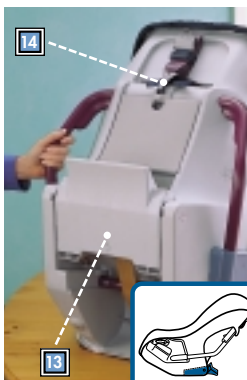
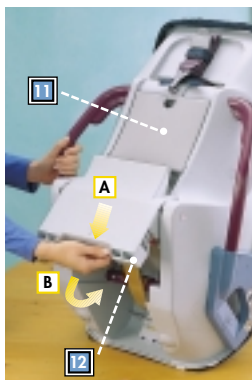

**REAR-FACING
RECLINE**

- 11** Close the connector bar cover.

HINT

It is easier to close the connector bar cover if you pull the shoulder straps out as far as you can on the front of the car seat.

- 12** Pull the seat position adjuster down **A**. Rotate the seat position adjuster toward the bottom of the car seat **B**.

- 13** Make sure the seat position adjuster is flat against the bottom of the car seat.

- 14** **DO NOT** use the tether strap to install the car seat rear-facing. Store the tether strap by folding it and fastening it to the back of the car seat. Store the tether anchor and hardware in a safe place until you're ready to use this car seat in the forward-facing position with a child 1 year and up (22-40 lbs.).

HINT

If the chest clip is not used, store it (buckled together) with this manual in the pocket on the side of the car seat.

Installing Your Car Seat in a Vehicle



WARNING



ALWAYS secure this car seat with your vehicle belt system exactly as described in this manual. Refer also to your vehicle owner's manual for specific information on your vehicle belt system and specific instructions on how to install a car seat in your vehicle.



NEVER install the car seat in the rear-facing position in a vehicle seating location equipped with an airbag. The airbag impact can cause severe head injury or death. If your vehicle is equipped with a front passenger side airbag, please refer to your vehicle owner's manual for child restraint installation instructions.



NEVER install and restrain a child less than 1 year of age in this car seat facing the front of the vehicle. You must install the car seat in the rear-facing position to avoid serious neck injuries in a sudden stop or crash.



NEVER use the chest clip with a child whose shoulder height is below the middle blue shoulder strap slots. The chest clip could pose a strangulation hazard to small infants.

REAR-FACING POSITION BIRTH TO 1 YEAR (6 - 30 LBS.)

Installing Your Car Seat in a Vehicle

REAR-FACING POSITION BIRTH TO 1 YEAR (6 - 30 LBS.)

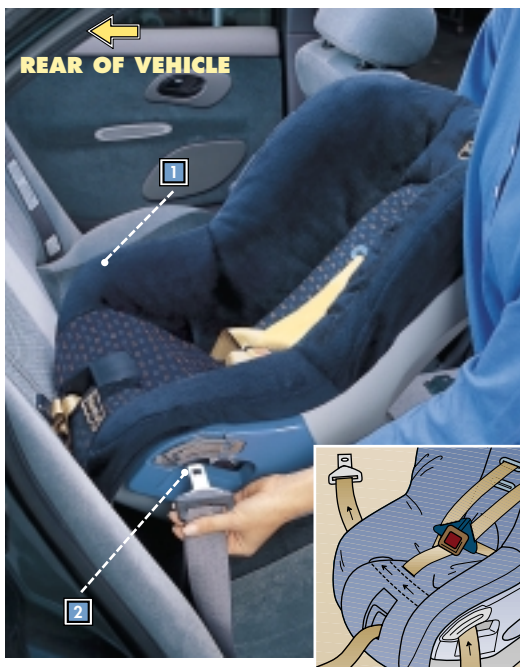

- 1 Once you have selected an acceptable seating location, place the car seat on the vehicle seat facing the **rear** of the vehicle.
- 2 Insert the vehicle belt through the blue vehicle belt opening in the side of the car seat.

HINT Routing your vehicle belt underneath the pad (see inset) will help keep it clean.

Installing Your Car Seat in a Vehicle



- 3 Route the vehicle belt out through the blue vehicle belt opening in the other side of the car seat.
- 4 Buckle the vehicle belt.

REAR-FACING POSITION BIRTH TO 1 YEAR (6 - 30 LBS.)

Installing Your Car Seat in a Vehicle



- 5A** **For a lap and shoulder belt system:** With the vehicle belt buckled, pull the shoulder belt just until the back of the car seat begins to rise.

Installing Your Car Seat in a Vehicle



- 5B For a manual lap belt system:**
With the vehicle belt buckled, pull the free end of the vehicle belt just until the back of the car seat begins to rise.

HINT Some vehicle belt systems have labels with instructions for use with car seats. Read the instructions on your vehicle's belt or refer to your vehicle owner's manual for specific instructions on how to tighten your vehicle belt system.

REAR-FACING POSITION BIRTH TO 1 YEAR (6 - 30 LBS.)

Installing Your Car Seat in a Vehicle



- 6 After tightening the vehicle belt system, make sure the base of the car seat is **flat** on the vehicle seat. If the car seat is sloped toward the vehicle seat back, your child will be too upright, allowing your child's head to droop forward.

Installing Your Car Seat in a Vehicle



- 7 If the base of the car seat is not flat on the vehicle seat, try inserting a rolled bath towel between the vehicle seat and the foot of the car seat. This will raise the foot of the car seat so that the base is **flat** on the vehicle seat.

REAR-FACING POSITION BIRTH TO 1 YEAR (6 - 30 LBS.)

Installing Your Car Seat in a Vehicle



- 8** If you are using a vehicle seating location equipped with a shoulder belt, you must use **only one** rear-facing position locking clip on the car seat to prevent the vehicle belt system from loosening during use. With the vehicle belt system tight, fit the **shoulder belt** into the rear-facing position locking clip on the side of the car seat.

IMPORTANT!

Your car seat is equipped with two rear-facing position locking clips (one on each side of the car seat). Use **only one** rear-facing position locking clip to install the car seat. Use the rear-facing position locking clip closest to where the vehicle shoulder belt is attached to the vehicle.

Installing Your Car Seat in a Vehicle



CORRECT

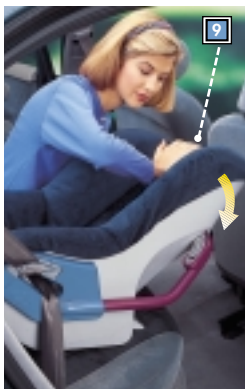

INCORRECT 

- 9** Test your installation by pushing on the top of the car seat. The car seat should **NOT** easily rotate down.

Regularly check to ensure your car seat installation is secure.

IMPORTANT!

If, after following the instructions "Installing Your Car Seat in a Vehicle", pages 22-30, steps 1-9, you cannot firmly install the car seat, choose a different vehicle seating location to install the car seat.

REAR-FACING POSITION BIRTH TO 1 YEAR (6 - 30 LBS.)

Restraining Your Child



- 1** Lift the harness release lever and pull the shoulder straps out to loosen the 5-point harness.
- 2** Press the button on the buckle and remove the shoulder straps from the buckle.

HINT

The metal and plastic parts of the car seat may become very hot when exposed to the sun. When not in use, cover the car seat with a blanket if it will be exposed to the sun for prolonged periods of time.

Before placing your child in the car seat, remove the blanket and check to be sure the metal and plastic parts are not too hot.

Restraining Your Child

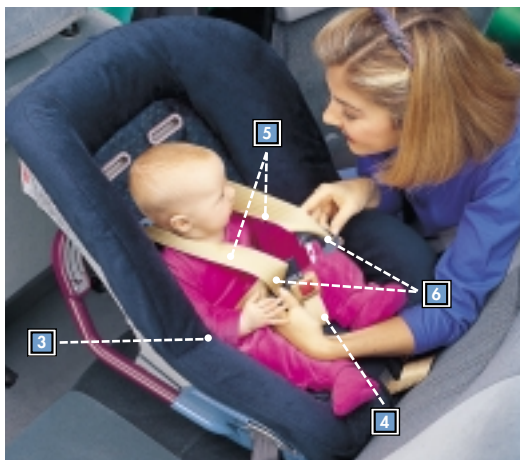

- 3** Place your child in the car seat. Make sure your child's lower back is against the car seat back. This will allow you to position the 5-point harness around your child properly.
- 4** Position the crotch strap between your child's legs.
- 5** Position the shoulder straps over your child's shoulders. **Make sure the shoulder straps are not twisted.**
- 6** Insert each of the shoulder straps into the buckle. **You should hear a "click" on each side of the buckle.**

REAR-FACING POSITION BIRTH TO 1 YEAR (6 - 30 LBS.)

Restraining Your Child

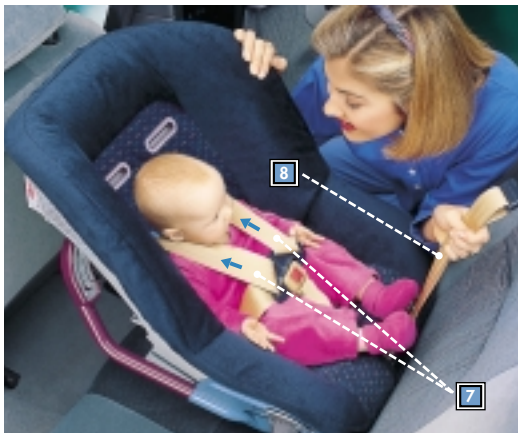

- 7** Pull the shoulder straps up to tighten the lap straps.
- 8** Pull the harness adjustment strap to tighten the 5-point harness.



WARNING

NEVER dress your child in clothing that interferes with positioning the crotch strap between your child's legs. If the crotch strap is not positioned between your child's legs, your child could eject from the car seat in a crash.

Restraining Your Child

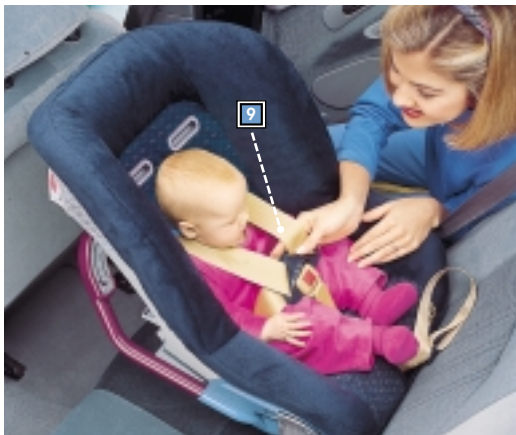

- 9** Check to be sure the shoulder straps are locked into the buckle and securing your child properly. Pull the shoulder straps up and away from your child firmly. The shoulder straps should remain locked in the buckle and should not pull more than one inch (two fingers) away from your child's chest. If the shoulder straps are too loose or unbuckle, please re-read the instructions on pages 32-34, and repeat steps 3-9.



WARNING

NEVER allow the shoulder straps to be loose around your child. If the shoulder straps are not snug against your child, your child will not be properly restrained.

REAR-FACING POSITION BIRTH TO 1 YEAR (6 - 30 LBS.)

Restraining Your Child



10 To remove your child from the car seat:

Press the button on the buckle and remove the shoulder straps from the buckle. Slide the shoulder straps off your child's shoulders and remove your child from the car seat. Insert both shoulder straps into the buckle.

Forward-Facing Position

1 Year and Up (22-40 lbs.)

Your Safe Embrace® Convertible Car Seat is color-coded for easy setup, installation and use. Use burgundy areas on the car seat for the forward-facing position.



Forward-Facing Position 1 Year and Up (22-40 lbs.)



- | | |
|---|--|
| <p>1 5-Point Harness
– Shoulder Straps*
– Lap Straps
– Crotch Strap
with Buckle</p> <p>2 Forward-Facing
Burgundy Shoulder
Strap Slots</p> <p>3 Tether Strap
– Tether Anchor Kit
(bolt, washer, lock
washer, nut shown
on pages 41-43)</p> <p>4 Forward-Facing
Position Locking Clip</p> | <p>5 Forward-Facing
Position Vehicle
Belt Path</p> <p>6 Seat Position
Adjuster
– Upright for
Forward-Facing
Position</p> <p>7 Harness
Adjustment Strap</p> <p>8 Harness
Release Lever</p> <p>9 Chest Clip</p> |
|---|--|

*When purchased, the car seat is factory assembled for rear-facing use with the shoulder straps in the lower blue shoulder strap slots.

Tether Anchor Installation

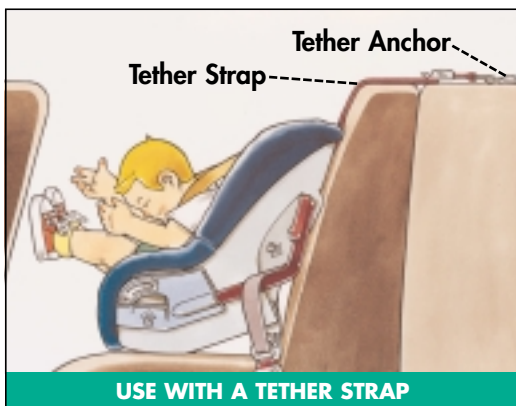

The most common life-threatening injuries that children sustain in vehicle accidents are head injuries. Even when a child is restrained in a properly installed forward-facing car seat, that child is susceptible to head injuries in vehicle collisions if the head moves forward enough to contact the vehicle interior. An effective way to reduce a child's forward motion is by the use of an additional top restraint known as a tether strap. Tether straps are highly effective in improving child safety in a vehicle.

Your Safe Embrace® Convertible Car Seat is equipped with a tether strap and tether anchor. The tether anchor must be installed in your vehicle. When the tether strap is fastened to the tether anchor in your vehicle, it will reduce the amount of forward motion your child experiences in an accident.

Fisher-Price® urges you to take the time to install a tether anchor in your vehicle. Your child's safety depends on you!

FORWARD-FACING POSITION 1 YEAR AND UP (22 - 40 LBS.)

Tether Anchor Installation

FORWARD-FACING POSITION 1 YEAR AND UP (22 - 40 LBS.)



- If your vehicle was manufactured **in or after 1985**, Fisher-Price® recommends that you contact your vehicle dealer to obtain a tether anchor kit that is specifically designed for your vehicle. Most vehicle manufacturers supply these kits free of charge. When requesting a tether anchor kit, be sure to specify the vehicle seating location in which you intend to install the car seat. To determine the seating location that provides a tight fit for your car seat, pre-install the car seat in your vehicle. Follow the instructions, "Installing Your Car Seat in a Vehicle", pages 51-57, steps 1-5 and 9.
- If your vehicle was manufactured **before 1985** or a tether anchor kit is not available for your particular vehicle, use the universal tether anchor kit provided with your Safe Embrace® Convertible Car Seat. Follow the instructions, "Tether Anchor Installation", pages 40-43, steps 1-7 to install the tether anchor.

HINT

Refer to your vehicle owner's manual for information on tether straps. Look for "tether" or "top strap" in the seat belt/restraint section.

Tether Anchor Installation

- 1** Choose an acceptable vehicle seating location for your car seat. Follow the instructions, "Selecting a Vehicle Seating Location for Your Car Seat", pages 9 and 10, for general information on choosing a vehicle seating location. To determine the seating location that provides a tight fit for your car seat, pre-install the car seat in your vehicle. Follow the instructions, "Installing Your Car Seat in a Vehicle", pages 51-57, steps 1-5 and 9.
- 2** You also need to choose an acceptable location for the tether anchor. Make sure the location is:
 - through solid metal,
 - 1¹/₄" away from any edge or large hole (speaker holes, defroster vent holes, etc.),
 - clear of wires, fuel or brake lines, fuel tank and spare tire,
 - accessible to allow the attachment of a washer and nut,
 - **NOT** a removable panel, luggage cover, spare tire cover or any screw-on panel.
- 3** Determine which type of vehicle you have: 2-door or 4-door car (see page 41); van, station wagon, hatchback, sport utility vehicle (see page 42); or pick-up truck (see page 43).
Note: Installation of the tether anchor may require two adults.

IMPORTANT!

- Use the tether strap only when using your car seat in the forward-facing position (22-40 lbs.).
- Use the tether strap **in addition** to your vehicle belt system to install your car seat in your vehicle.

Tether Anchor Installation 2-Door and 4-Door Car

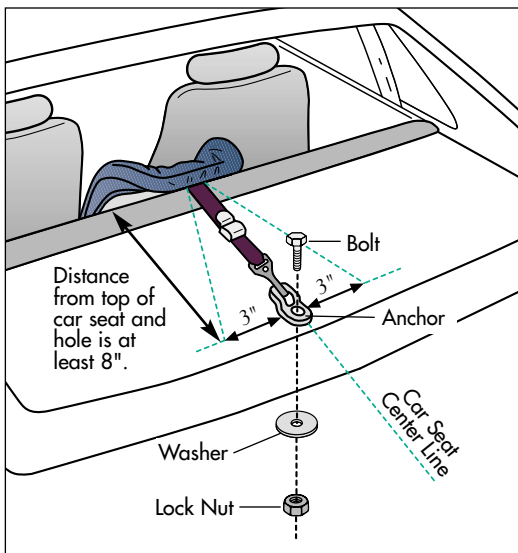

- 4A** If a pre-drilled hole does not exist, you will have to drill a $\frac{5}{16}$ " hole. (Be sure to wear appropriate eye protection when drilling.) Make sure the hole is at least 8" away from the top and no more than 3" from the center line of the Safe Embrace® Convertible Car Seat.
- 5A** Insert the bolt through the anchor.
- 6A** Insert the end of the bolt into the hole inside your vehicle.
- 7A** Open the trunk of your vehicle and attach the washer and lock nut to the end of the bolt. While holding the bolt tight with a wrench, tighten the lock nut securely with another wrench.

Tether Anchor Installation Van, Hatchback, Station Wagon, Sport Utility Vehicle

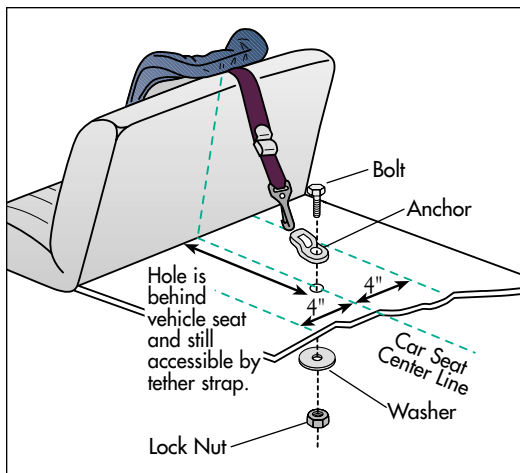

- 4B** If a pre-drilled hole does not exist, you will have to drill a $\frac{5}{16}$ " hole. (Be sure to wear appropriate eye protection when drilling.) Make sure the hole is behind the vehicle seat and still accessible by the tether strap; and no more than 4" from the center line of the Safe Embrace® Convertible Car Seat.
- 5B** Insert the bolt through the anchor.
- 6B** Insert the end of the bolt into the hole inside your vehicle.
- 7B** From the outside or underside of your vehicle, attach the washer and lock nut to the end of the bolt. While holding the bolt tight with a wrench, tighten the lock nut securely with another wrench. If the drilled hole is on the floor of your vehicle, use a silicone caulk to seal out water and exhaust fumes.

Tether Anchor Installation Pick-Up Truck

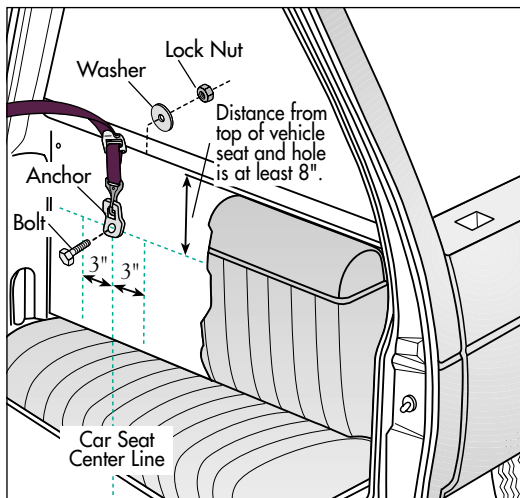

- 4C** If a pre-drilled hole does not exist, you will have to drill a $\frac{5}{16}$ " hole. (Be sure to wear appropriate eye protection when drilling.) Make sure the hole is at least 8" from the top of the vehicle seat and no more than 3" from the center line of the Safe Embrace® Convertible Car Seat.
- 5C** Insert the bolt through the anchor.
- 6C** Insert the end of the bolt into the hole inside your vehicle.
- 7C** From the outside of your vehicle, attach the washer and lock nut to the end of the bolt. While holding the bolt tight with a wrench, tighten the lock nut securely with another wrench. Use a silicone caulk around the drilled hole to seal out water and exhaust fumes.

Setup 5-Point Harness

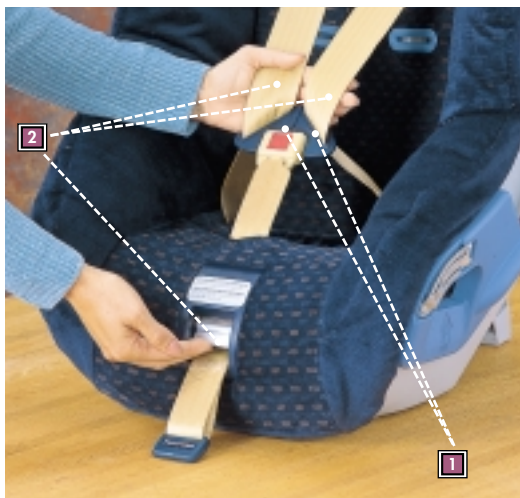

- 1** Make sure both shoulder straps are inserted into the buckle.
- 2** Lift the harness release lever and pull the shoulder straps out as far as you can on the front of the car seat.



WARNING

NEVER use the lower or middle blue shoulder strap slots with a child in the forward-facing position. The shoulder straps could fall off your child's shoulders and your child will not be properly restrained. Use the upper burgundy shoulder strap slots when using the car seat forward-facing.

FORWARD-FACING POSITION 1 YEAR AND UP (22 - 40 LBS.)

Setup 5-Point Harness

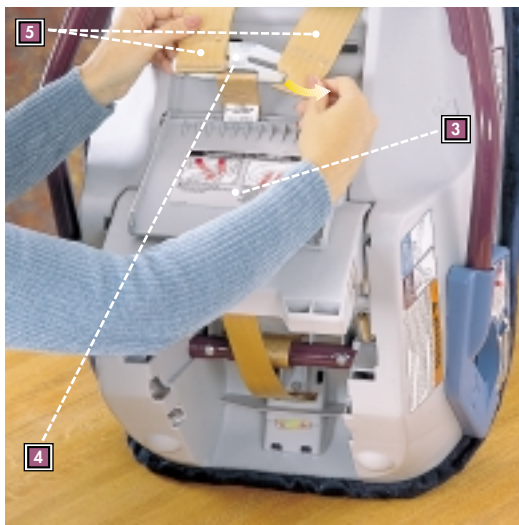

- 3 Open the connector bar cover on the back of the car seat.
- 4 Pull the connector bar up.
- 5 Remove each shoulder strap from each end of the connector bar, as shown. Remove the shoulder straps from the front of the car seat.

FORWARD-FACING POSITION 1 YEAR AND UP (22 - 40 LBS.)

Setup 5-Point Harness

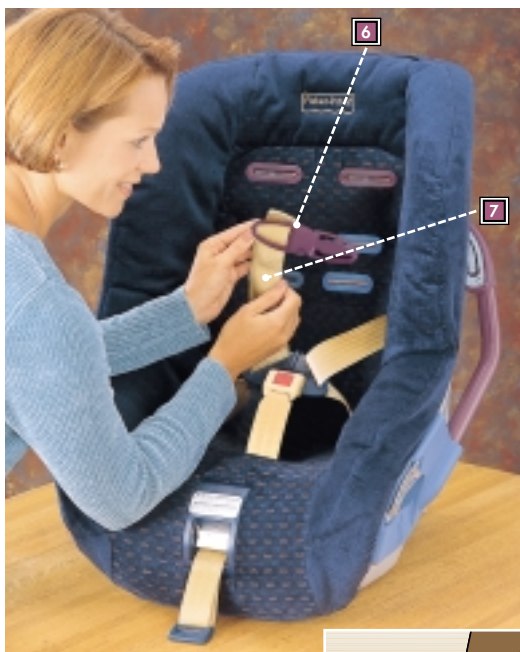

- 6** Position the chest clip pieces so that the buckle and tongue face each other. Fasten the chest clip.

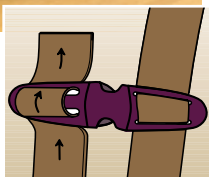

- 7** Thread a shoulder strap through one side of the chest clip, as shown. Make sure the shoulder strap is not twisted. Repeat this procedure to thread the other shoulder strap through the other side of the chest clip.

FORWARD-FACING POSITION 1 YEAR AND UP (22 - 40 LBS.)

Setup 5-Point Harness



- 8** Re-insert the shoulder straps into the upper burgundy shoulder strap slots.
Unfasten the chest clip.

IMPORTANT!

If you are converting the car seat from rear-facing use to forward-facing use, **REPOSITION THE SHOULDER STRAPS IN THE UPPER BURGUNDY SHOULDER STRAP SLOTS AND ATTACH THE CHEST CLIP.**

The chest clip is intended to be used only if your child's shoulders are at or above the middle blue shoulder strap slots.

FORWARD-FACING POSITION 1 YEAR AND UP (22 - 40 LBS.)

Setup 5-Point Harness

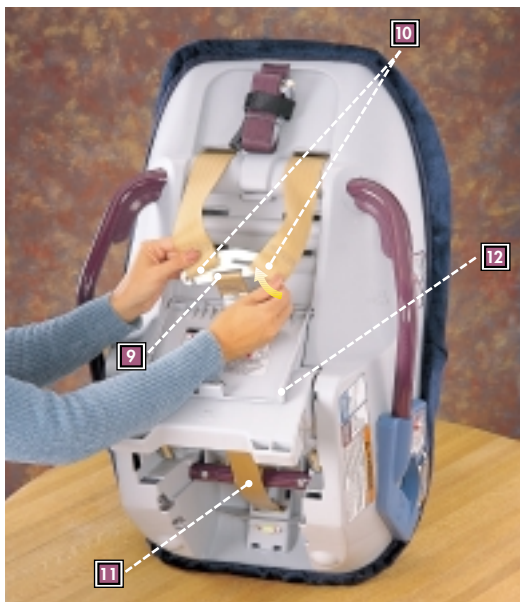

- 9** Pull the connector bar up on the back of the car seat.
- 10** Re-attach the shoulder straps to the connector bar. **Make sure the shoulder straps are not twisted.**
- 11** **Make sure the connector bar strap is not twisted.**
- 12** Close the connector bar cover.

HINT

It is easier to close the connector bar cover if you pull the shoulder straps out as far as you can on the front of the car seat.

FORWARD-FACING POSITION 1 YEAR AND UP (22 - 40 LBS.)

Setup Seat-Position - Upright

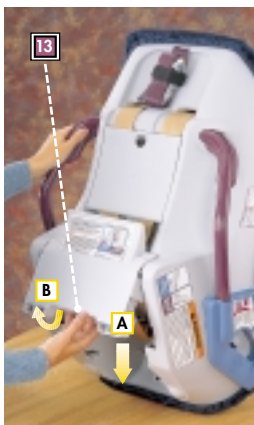

- 13** Pull the seat position adjuster down **A**. Rotate the seat position adjuster toward you **B**.
- 14** Make sure the seat position adjuster is in the upright position.



FORWARD-FACING POSITION 1 YEAR AND UP (22 - 40 LBS.)

Installing Your Car Seat in a Vehicle



WARNING



ALWAYS secure this car seat with your vehicle belt system exactly as described in this manual. Refer also to your vehicle owner's manual for specific information on your vehicle belt system and specific instructions on how to install a car seat in your vehicle.



ALWAYS use the tether strap in the forward-facing position. Your child's safety is significantly enhanced in the event of a crash if the tether strap is used. The tether strap significantly reduces forward motion of your child's head during a crash, greatly reducing the likelihood of head injury.

IMPORTANT!

When installing this car seat in your vehicle, only use the front seat when no acceptable rear seating location is available. If the front seating location is equipped with an airbag but must be used to install this car seat in the forward-facing position, adjust the vehicle seat as far back from the dashboard as possible. Consult your vehicle owner's manual regarding front seat, forward-facing child restraint use.

FORWARD-FACING POSITION 1 YEAR AND UP (22 - 40 LBS.)

Installing Your Car Seat in a Vehicle



- 1** Once you have selected an acceptable seating location and have installed the tether anchor, place the car seat on the vehicle seat facing the **front** of the vehicle.
- 2** Route the vehicle belt over the bend in the burgundy tube, against the connector bar cover on the back of the car seat and then over the bend in the burgundy tube on the opposite side of the car seat.

FORWARD-FACING POSITION 1 YEAR AND UP (22 - 40 LBS.)

Installing Your Car Seat in a Vehicle

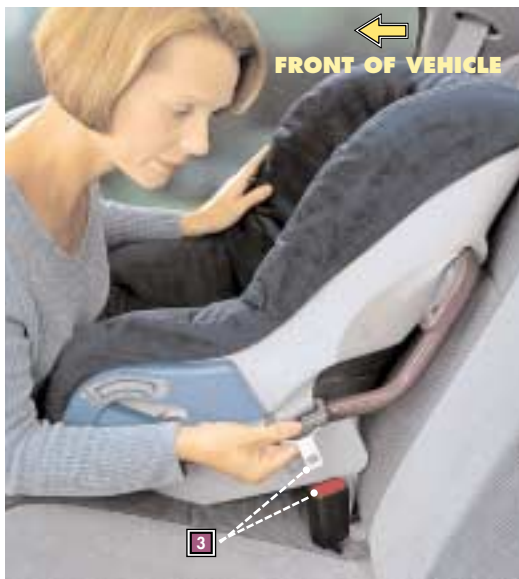

3 Buckle the vehicle belt.

FORWARD-FACING POSITION 1 YEAR AND UP (22 - 40 LBS.)

Installing Your Car Seat in a Vehicle

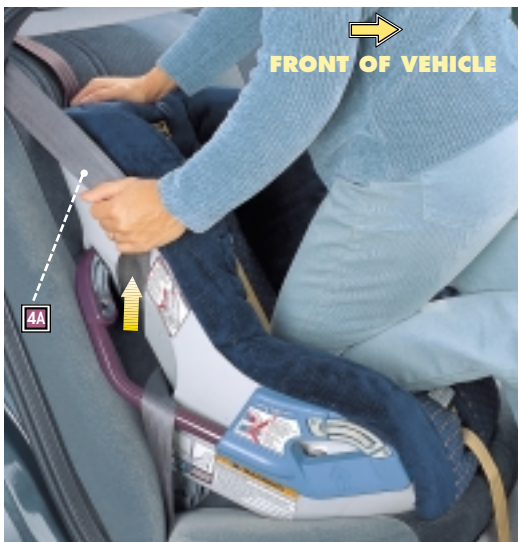

- 4A** **For a lap and shoulder belt system:**
With the vehicle belt buckled, push down on the car seat with your knee and pull the shoulder belt for the tightest possible fit.

Installing Your Car Seat in a Vehicle

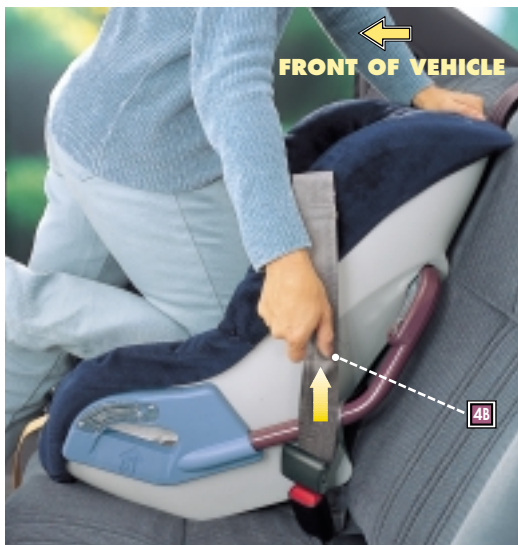

4B For a manual lap belt system:

With the vehicle belt buckled, push down on the car seat with your knee and pull the free end of the vehicle belt for the tightest possible fit.

HINT

Some vehicle belt systems have labels with instructions for use with car seats. Read the instructions on your vehicle's belt or refer to your vehicle owner's manual for specific instructions on how to tighten your vehicle belt system.

FORWARD-FACING POSITION 1 YEAR AND UP (22 - 40 LBS.)

Installing Your Car Seat in a Vehicle



- 5** If you are using a vehicle seating location equipped with a shoulder belt, you must use **only one** forward-facing position locking clip on the car seat to prevent the vehicle belt system from loosening during use. With the vehicle belt system tight, fit the **shoulder belt** into the forward-facing position locking clip on the burgundy tube.

IMPORTANT!

Your car seat is equipped with two forward-facing position locking clips (one on each side of the seat). Use **only one** forward-facing position locking clip to install the car seat. Use the forward-facing position locking clip closest to where the vehicle shoulder belt is attached to the vehicle.

FORWARD-FACING POSITION 1 YEAR AND UP (22 - 40 LBS.)

Installing Your Car Seat in a Vehicle

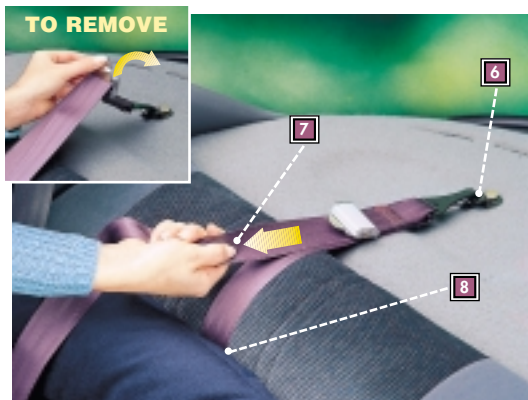

- 6 Attach the tether strap hook to the tether anchor.
- 7 Pull the free end of the tether strap to tighten.
- 8 Fold or roll the excess tether strap and tuck it between the car seat and the vehicle seat.

Note: To remove the tether strap from the tether anchor, lift the tab on the adjuster to loosen the tether strap. Remove the tether strap hook from the tether anchor.

FORWARD-FACING POSITION 1 YEAR AND UP (22 - 40 LBS.)

Installing Your Car Seat in a Vehicle



CORRECT



INCORRECT



- 9** Test your installation of the car seat by rocking the car seat forward and backward. You should **NOT** be able to pull the back of the car seat away from the vehicle seat more than one inch. Regularly check to ensure your car seat installation is secure.

IMPORTANT!

If, after following the instructions, "Installing Your Car Seat in a Vehicle", pages 50-57, steps 1-9, you cannot tightly install the car seat, choose a different vehicle seating location to install the car seat.

Restraining Your Child



- 1** Lift the harness release lever and pull the shoulder straps out to loosen the 5-point harness.
- 2** Press the button on the buckle and remove the shoulder straps from the buckle.

HINT

The metal and plastic parts of the car seat may become very hot when exposed to the sun. When not in use, cover the car seat with a blanket if it will be exposed to the sun for prolonged periods of time. Before placing your child in the car seat, remove the blanket and check to be sure the metal and plastic parts are not too hot.

FORWARD-FACING POSITION 1 YEAR AND UP (22 - 40 LBS.)

Restraining Your Child

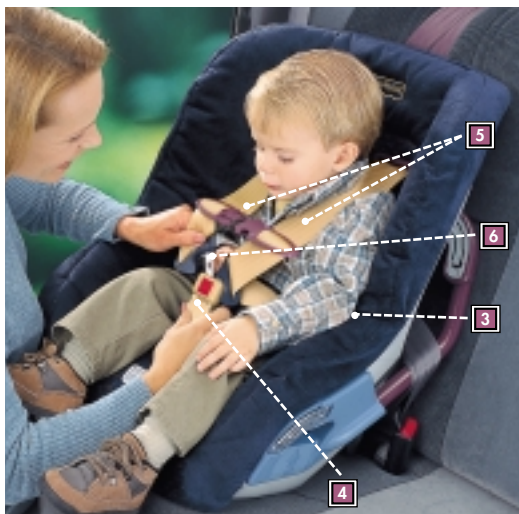

- 3** Place your child in the car seat. Make sure your child's lower back is against the car seat back. This will allow you to position the 5-point harness around your child properly.
- 4** Position the crotch strap between your child's legs.
- 5** Position the shoulder straps over your child's shoulders. **Make sure the shoulder straps are not twisted.**
- 6** Insert each of the shoulder straps into the buckle. **You should hear a "click" on each side of the buckle.**

FORWARD-FACING POSITION 1 YEAR AND UP (22 - 40 LBS.)

Restraining Your Child



- 7** Pull the shoulder straps up to tighten the lap straps.
- 8** Pull the harness adjustment strap to tighten the 5-point harness.



WARNING

NEVER dress your child in clothing that interferes with positioning the crotch strap between your child's legs. If the crotch strap is not positioned between your child's legs, your child could eject from the car seat in a crash.

FORWARD-FACING POSITION 1 YEAR AND UP (22 - 40 LBS.)

Restraining Your Child



- 9 Buckle the chest clip.

FORWARD-FACING POSITION 1 YEAR AND UP (22 - 40 LBS.)

Restraining Your Child



- 10** Position the chest clip so that it is in line with your child's armpits.

FORWARD-FACING POSITION 1 YEAR AND UP (22 - 40 LBS.)

Restraining Your Child



- 11** Check to be sure the shoulder straps are locked into the buckle and securing your child properly. Pull the shoulder straps up and away from your child firmly. The shoulder straps should remain locked in the buckle and should not pull more than one inch (two fingers) away from your child's chest. If the shoulder straps are too loose or unbuckle, please re-read the instructions, "Restraining Your Child", pages 58-63, and repeat steps 3-11.



WARNING

NEVER allow the shoulder straps to be loose around your child. If the shoulder straps are not snug against your child, your child will not be properly restrained.

Restraining Your Child



12 To remove your child from the car seat:

Unbuckle the chest clip.

Press the button on the buckle and remove the shoulder straps from the buckle. Slide the shoulder straps off your child's shoulders and remove your child from the car seat. Insert both shoulder straps into the buckle.

FORWARD-FACING POSITION 1 YEAR AND UP (22 - 40 LBS.)

Consumer Information

- If you have any questions about installation or proper use, or would like to order replacement parts for the Safe Embrace® Convertible Car Seat, please call Fisher-Price® Consumer Affairs toll-free at **1-800-432-KIDS**, between 8 AM and 5 PM EST, Monday through Friday. Hearing-impaired consumers using TTY/TDD equipment, please call 1-800-382-7470. Or write to:

Fisher-Price® Consumer Affairs
636 Girard Avenue
East Aurora, New York 14052

- If you would like to request an additional Fisher-Price® universal tether anchor kit free of charge, please call **1-800-432-KIDS**.
- Fisher-Price® recommends that child restraints be replaced after eight years to provide the best assurance that the child restraint: is in reliable working condition; is well-suited for use in constantly changing automobile interior designs; and is reasonably current in relation to Federal regulations. When you replace your car seat for any reason, make sure that it can no longer be used by another child by disposing of it properly.

Aircraft Use

You can install this car seat in aircraft seats that face forward. Before bringing the car seat on board:

- Notify the airline of your intent to bring this car seat on board. The airline may have restrictions regarding its use.
- The width of this car seat is 18". You may need to lift the armrest out of the way to provide added room for the car seat. Check with the airline to be sure this car seat will fit in the aircraft seat.

Install the car seat in aircraft seats that face forward and follow the instructions of the flight attendant regarding placement of the car seat. For specific instructions, please see pages 14-35 for rear-facing use and pages 36-64 for forward-facing use.

Register Your Safe Embrace® Convertible Car Seat



Child restraints could be recalled for safety reasons. You must register this restraint to be reached in a recall.

Send your name, address, and the restraint's model number and manufacturing date (located on the back of the seat back) to: Fisher-Price, Inc., 636 Girard Avenue, East Aurora, New York 14052, or call 1-800-432-KIDS. For recall information, call the U.S. Government's Auto Safety Hotline at 1-800-424-9393 (202-366-0123 in the Washington D.C. area).

Cleaning and Washing

- 1 From the front of the car seat, lift the harness release lever and pull the shoulder straps out as far as you can.
- 2 From the back of the car seat, open the connector bar cover.
- 3 Pull the connector bar out and up.
- 4 Remove each shoulder strap from each end of the connector bar.
- 5 From the front of the car seat, pull the shoulder straps out to remove them.
- 6 Lift the edges of the car seat pad from the car seat shell. Feed the crotch and lap belts through the slots in the car seat pad. Remove the car seat pad.
- 7 Machine wash the car seat pad in cold water and mild detergent and tumble dry on low heat. Do not use bleach.

Cleaning and Washing

- 8** To clean the car seat shell and 5-point harness, use a mild cleaning agent and damp cloth. Rinse with clean water to remove soap residue.
- 9** Clean the inside of the buckle with a mild soap and water solution. Run warm water into the buckle to remove residue. **DO NOT** use detergents. **DO NOT** lubricate the buckle.
- 10** Replace the car seat pad onto the car seat shell and feed the crotch and lap belts through the slots in the bottom of the car seat pad.
- 11** Insert each of the shoulder straps into the buckle.
- 12** Insert the shoulder straps through the appropriate shoulder strap slots, checking to be sure they are not twisted and are in the proper slots for either rear-facing (beginning on page 18 or forward-facing (beginning on page 46).
- 13** Connect the shoulder straps to the connector bar and close the connector bar cover.



✓ Safe Check

Rear-Facing (Birth - 1 Year)

✓ SHOULDER STRAPS

...inserted in lower or middle blue slots

✓ ADJUST

...seat position adjuster to recline

...car seat rear-facing

✓ FASTEN

...vehicle belt system after properly routing it through both blue belt path openings

...5-point harness and adjust it to fit child snugly

✓ EVALUATE

...to be sure car seat is **not** installed in a vehicle seating location equipped with an airbag

...installation to be sure car seat is in appropriate seating location and is a firm fit in vehicle

...to be sure 5-point harness is snug against child

Forward-Facing (1 Year and Older)

✓ SHOULDER STRAPS

...inserted in upper burgundy slots

✓ ADJUST

...seat position adjuster to upright

...car seat forward-facing

✓ FASTEN

...vehicle belt system after properly routing it over both burgundy belt path metal tubes

...tether strap to tether anchor

...5-point harness and adjust it to fit child snugly

✓ EVALUATE

...installation to be sure car seat is in appropriate seating location and is a tight fit in vehicle

...to be sure 5-point harness is snug against child

Fisher-Price

1-800-432-KIDS

Fisher-Price, Inc., a subsidiary of Mattel, Inc., East Aurora, New York 14052, U.S.A.

©1999 Mattel, Inc. All Rights Reserved.

® and ™ designate U.S. trademarks of Mattel, Inc.

Download from www.Somanuals.com. All Manuals Search And Download.

Free Manuals Download Website

<http://myh66.com>

<http://usermanuals.us>

<http://www.somanuals.com>

<http://www.4manuals.cc>

<http://www.manual-lib.com>

<http://www.404manual.com>

<http://www.luxmanual.com>

<http://aubethermostatmanual.com>

Golf course search by state

<http://golfingnear.com>

Email search by domain

<http://emailbydomain.com>

Auto manuals search

<http://auto.somanuals.com>

TV manuals search

<http://tv.somanuals.com>