



**Infant Rocker Seat -
Recline Position**



**Toddler Rocker -
Upright Position**

**IMPORTANT!
KEEP FOR FUTURE
REFERENCE.**



WARNING

To prevent serious injury or death:

- **Fall Hazard** - Never use this product on an elevated surface, since child's movement may cause the product to slide or tip over. Use only on a floor.
- **Suffocation Hazard** - Never use on a soft surface (bed, sofa, cushion) since the product can tip over and cause suffocation in soft surfaces.
- Never leave child unattended.
- Never use as a carrier or lift while child is seated.
- This product is not intended to replace a cot or bed for prolonged periods of sleep.
- Use the upright position (toddler mode) only when child has developed enough upper body control to sit without leaning forward.
- Always use the restraint system until child is able to climb in and out of the product unassisted.
- Do not use reclined position (infant mode) once child can sit unaided.
- Never use toy bar as a handle.

- Please read these instructions before assembly and use of this product.
- Adult assembly is required. Tool needed for assembly: Phillips screwdriver (not included).
- Requires one "D" (LR20) **alkaline** battery (not included) for soother operation.
- Product features and decorations may vary from photographs.
- Use the recline position (infant mode) until child is able to sit unaided (approximately 9 kg/20 lbs).
- This product does not replace a cot or bed. Should the child need to sleep, place the child in a suitable cot or bed.
- Use the upright position (toddler mode) only when child has developed enough upper body control to sit without leaning forward (maximum 18 kg/40lbs).

- The pad is machine washable. Wash the pad separately in cold water on the gentle cycle. Do not use bleach. Tumble dry separately on low heat and remove promptly.
- The frame, toy bar and toys may be wiped clean using a mild cleaning solution and a damp cloth. Do not use bleach. Do not use harsh or abrasive cleaners. Rinse clean with water to remove residue. Do not immerse the frame, toy bar and toys.

To remove the pad:

- Unfasten the waist belts. Pull them down through the slots in the seat pad.
- Unbuckle the straps on the front edge of the pad.

To replace the pad, refer to Assembly steps 8-10.



service.fisher-price.com

Great Britain: Vanwall Business Park, Maidenhead SL6 4UB.
Helpline: 01628 500303. www.service.mattel.com/uk.

Australia: Mattel Australia Pty. Ltd., 658 Church Street, Locked Bag #870, Richmond, Victoria 3121 Australia.
Consumer Advisory Service 1300 135 312.

New Zealand: 16-18 William Pickering Drive, Albany 1331, Auckland.

Asia: Mattel East Asia Ltd, Room 1106, South Tower, World Finance Centre, Harbour City, Tsimshatsui, HK, China.

Malaysia: Diimport & Diedarkan Oleh: Mattel SEA Ptd Ltd. (993532-P) Lot 13.5, 13th Floor, Menara Lien Hoe, Persiaran Tropicana Golf Country Resort, 47410 PJ. Tel: +603-3341 9052.

Mattel Europa, B.V., Gondel 1, 1186 MJ Amstelveen, Nederland.

Parts

IMPORTANT! Please remove all parts from the package and identify them before assembly. Some parts may be packed in the pad.

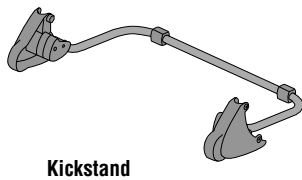
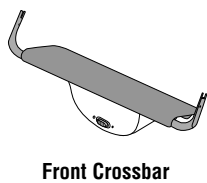
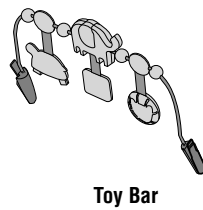
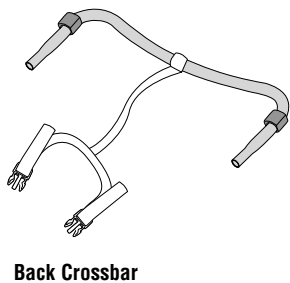
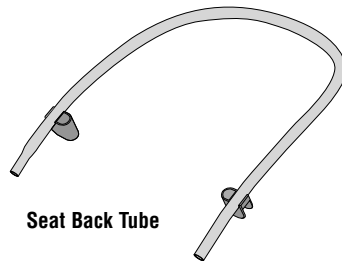
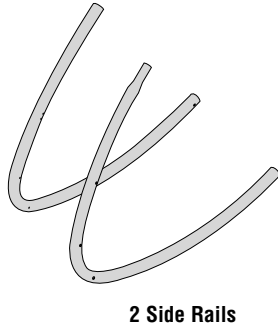
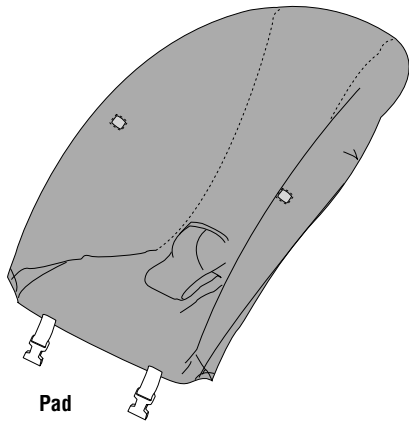

Note: Tighten or loosen all screws with a Phillips screwdriver. Do not over-tighten the screws.

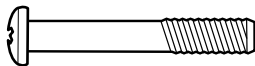

M5 x 30 mm Screw – 6

Shown Actual Size

Assembly



CAUTION

This package contains small parts in its unassembled state. Adult assembly is required.

IMPORTANT! Before assembly and each use, inspect this product for damaged hardware, loose joints, missing parts or sharp edges. DO NOT use if any parts are missing or broken. Contact Fisher-Price® for replacement parts and instructions if needed. Never substitute parts.

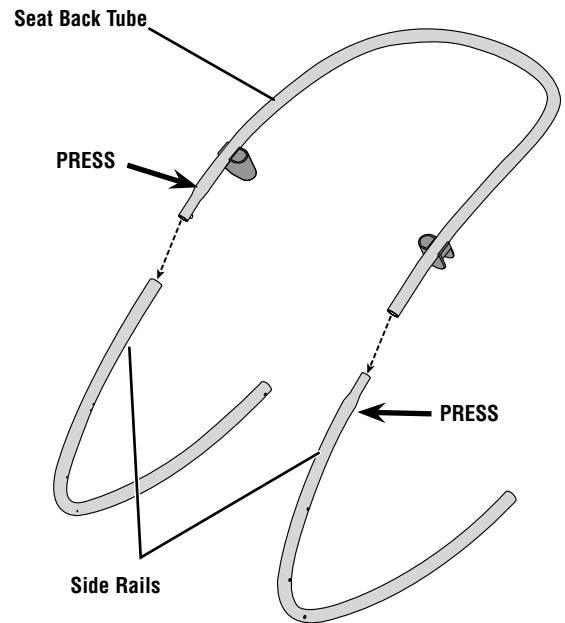

1

- Fit the ends of the seat back tube to the ends of each side rail.
Hint: The seat back tube is designed to fit one way. If it does not seem to fit, turn it around and try again.
- While pressing the button on the end of the seat back tube/side rail, continue to insert until the buttons “click” into place.
Make sure you hear a “click” on each side.
- Pull the seat back tube to be sure it is secure on the side rails.

Assembly

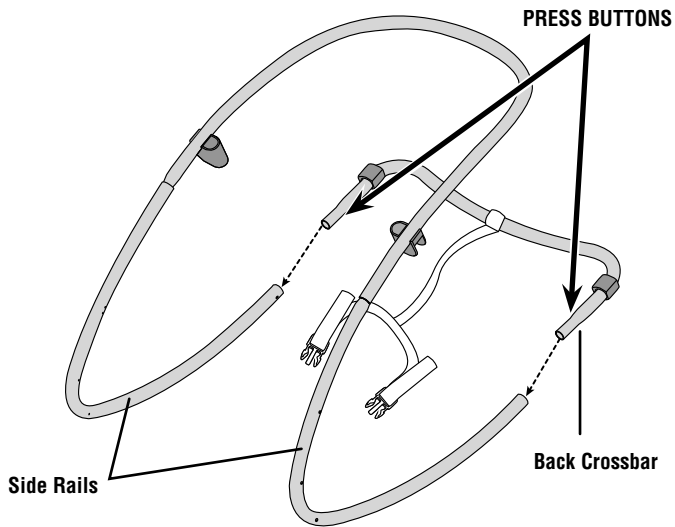

2

- While pressing the buttons on the ends of the back crossbar, insert into the ends of the side rails. Push the back crossbar until the buttons "click" into place. **Make sure you hear a "click" on each side.**

Hint: The back crossbar is designed to fit the ends of the side rails one way.

- Pull the back crossbar to be sure it's secure to the side rails.

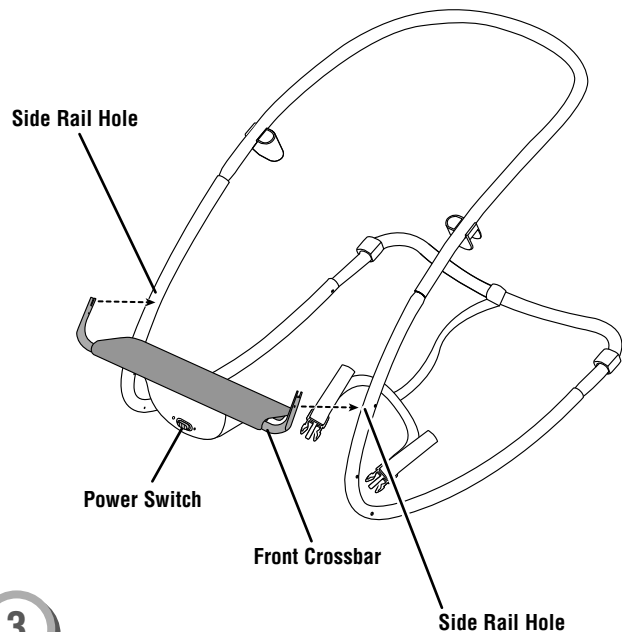

3

- Position the front crossbar so that the vibration unit power switch is down.
- Fit the front crossbar tabs to the small hole in each side rail. Hold the front crossbar in place and proceed to steps 4 and 5 to fasten.

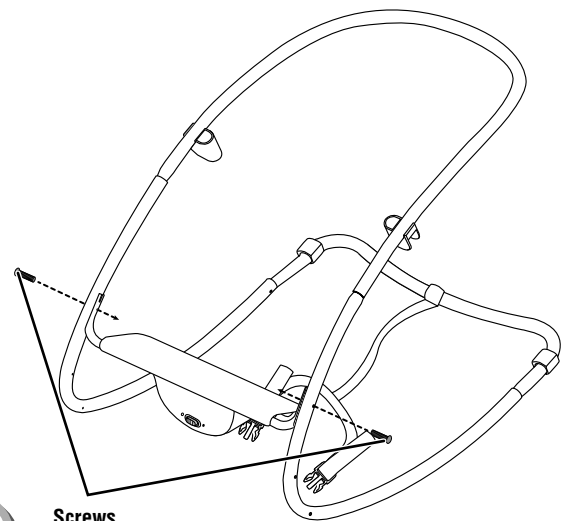

4

- Insert a screw through the outside hole in each side rail and into the ends of the front crossbar.

IMPORTANT! Please follow the next assembly step (step 5) carefully to completely secure the front crossbar to the side rails.

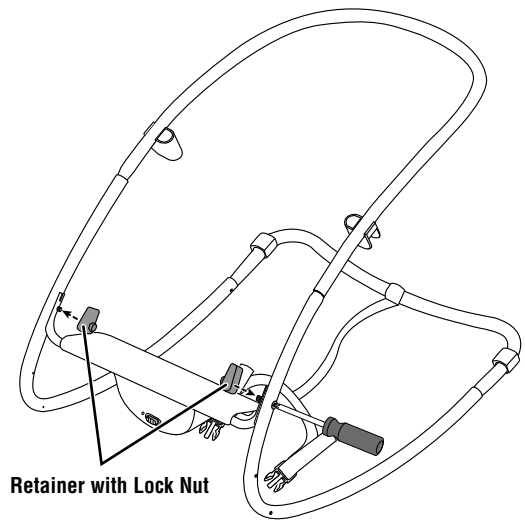

5

- Fit a retainer with lock nut onto the end of the screw and to the inside of a side rail. Tighten the screw.

Hint: A lock nut has been factory assembled to the retainer. During shipment, the lock nut may have fallen out of the retainer. If it has, please fit it into the hexagonal hole in the retainer so that the rounded side of the lock nut faces out.

- Repeat this procedure to fasten the screw in the other side rail, using the remaining retainer with lock nut.

Assembly

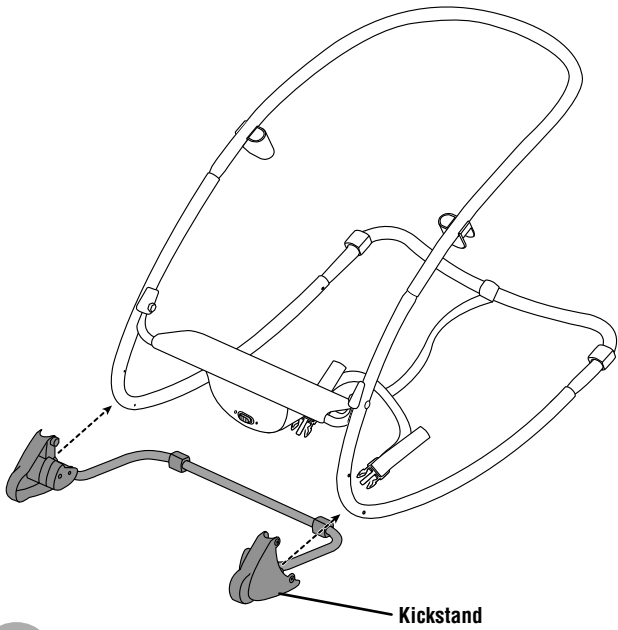

6

- Fit the kickstand onto the assembly, as shown.

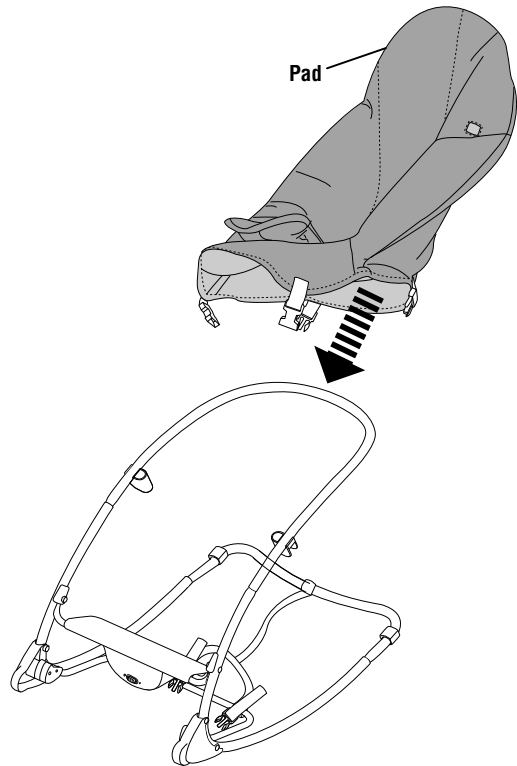

8

- Fit the pad pocket onto the seat back tube.

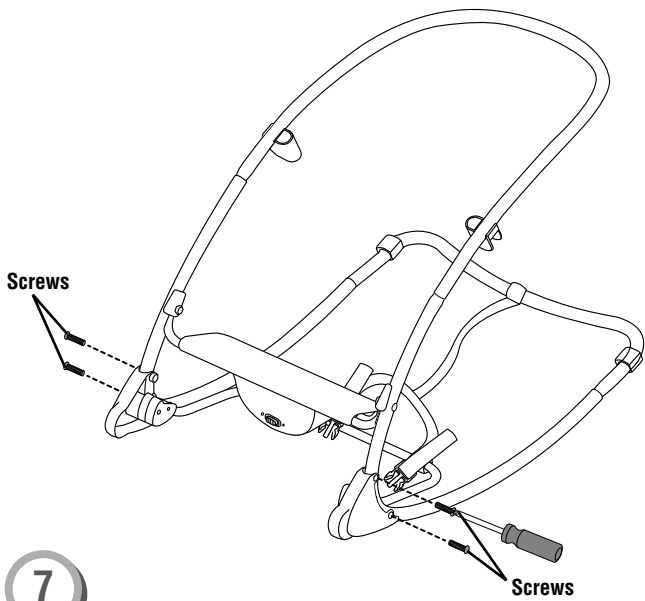

7

- Insert four screws into the kickstand and tighten.

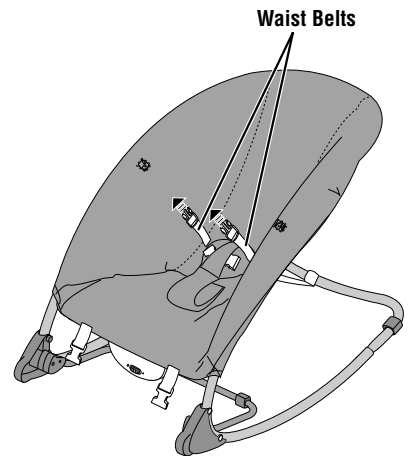

9

- Insert the waist belts through slots in the back of the pad.
- Press the fastener on the waist belts and pad together.

Assembly

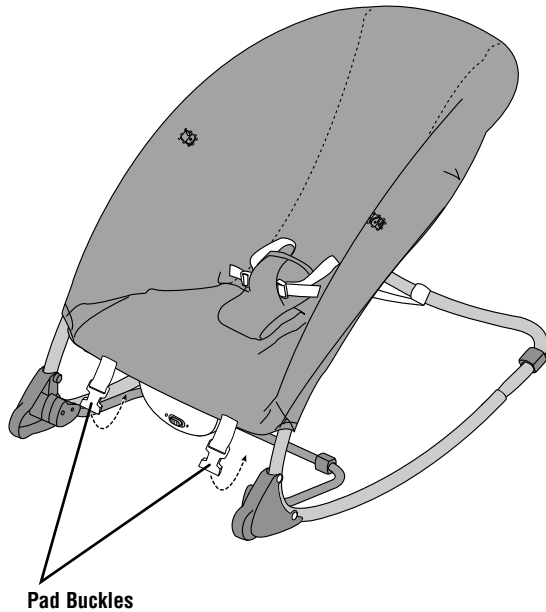

Pad Buckles

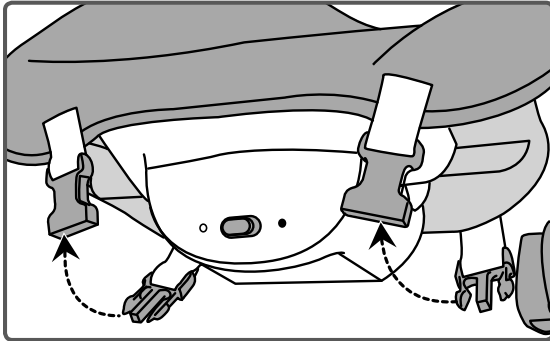

10

- Fasten both buckles on the front edge of the pad around the front crossbar. **Make sure you hear a "click" for each buckle.**

Battery Installation

*Hint: We recommend using an **alkaline** battery for longer battery life.*

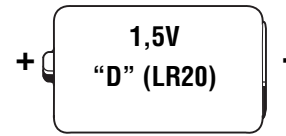

- Protect the environment by not disposing of this product with household waste (2002/96/EC). Check your local authority for recycling advice and facilities (Europe only).

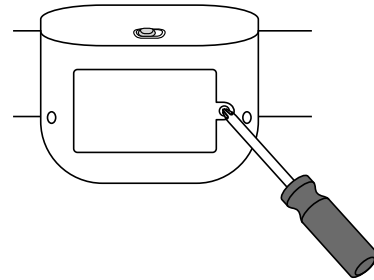

- Locate the battery compartment on the bottom of the vibrations unit.
- Loosen the screw in the battery compartment door. Lift to remove the battery compartment door.
- Insert one "D" (LR20) **alkaline** battery.
- Replace the battery compartment door and tighten the screw.
- If this product begins to operate erratically, you may need to reset the electronics. Slide the power switch off and then back on.

IMPORTANT! Low battery power causes this product to operate erratically: no vibrations and the product may not turn off. Remove and discard the battery and replace with a new "D"(LR20) **alkaline** battery.

Battery Safety Information

In exceptional circumstances, batteries may leak fluids that can cause a chemical burn injury or ruin your product. To avoid battery leakage:

- Do not mix old and new batteries or batteries of different types (alkaline, standard (carbon-zinc) or rechargeable (nickel-cadmium)).
- Insert batteries as indicated inside the battery compartment.
- Remove batteries during long periods of non-use. Always remove exhausted batteries from the product. Dispose of batteries safely. Do not dispose of this product in a fire. The batteries inside may explode or leak.
- Never short-circuit the battery terminals.
- Use only batteries of the same or equivalent type as recommended.
- Do not charge non-rechargeable batteries.
- Remove rechargeable batteries from the product before charging.
- If removeable, rechargeable batteries are used, they are only to be charged under adult supervision.



WARNING

To prevent serious injury or death:

- **Fall Hazard** - Never use this product on an elevated surface, since child's movement may cause the product to slide or tip over. Use only on a floor.
- **Suffocation Hazard** - Never use on a soft surface (bed, sofa, cushion) since the product can tip over and cause suffocation in soft surfaces.
- Never leave child unattended.
- Never use as a carrier or lift while child is seated.
- This product is not intended to replace a cot or bed for prolonged periods of sleep.
- Use the upright position (toddler mode) only when child has developed enough upper body control to sit without leaning forward.
- Always use the restraint system until child is able to climb in and out of the product unassisted.
- Do not use reclined position (infant mode) once child can sit unaided.
- Never use toy bar as a handle.

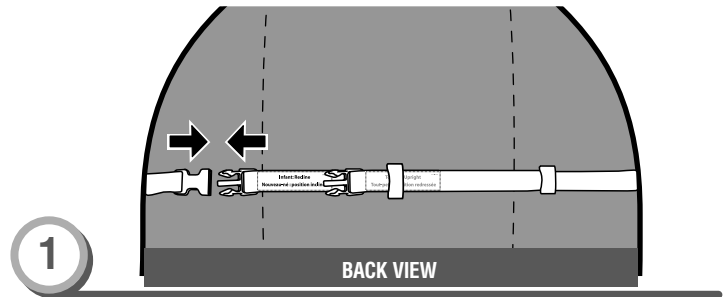

1 Seat Position

- Fasten the straps on the back of the pad for the **Infant-Recline Position**.

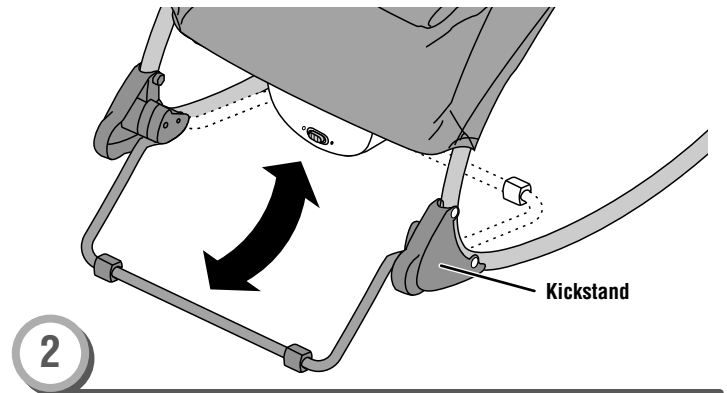

2 Kickstand

- Rotate the kickstand out for a stationary feeding seat.
- Push down on the seat bottom to be sure the kickstand is in position.

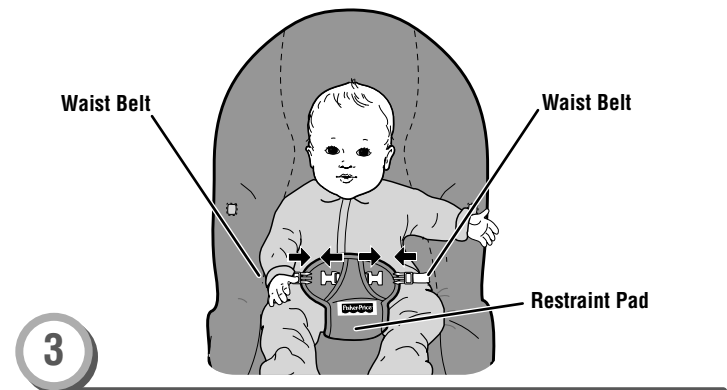

3 Restraint System

- Place your child in the seat. Position the restraint pad between your child's legs.
- Fasten the waist belts to each side of the restraint pad. **Make sure you hear a "click" on both sides.**
- Tighten each waist belt so that the restraint system is snug against your child. Please refer to the next section for instructions to tighten the waist belts.
- Check to be sure the restraint system is securely attached by pulling it away from your child. The restraint system should remain attached.

Infant - Recline

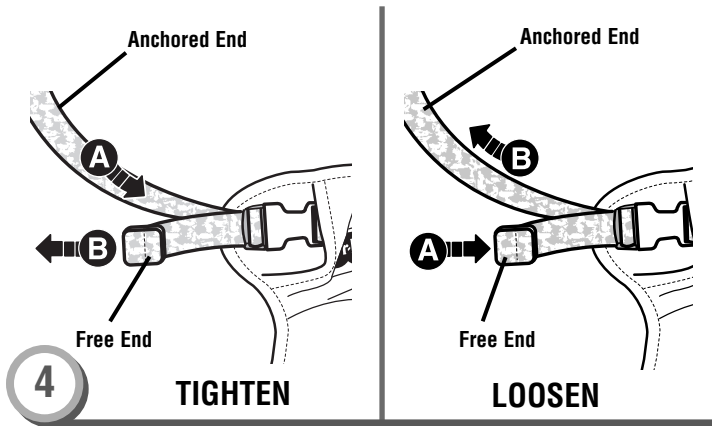

To tighten the belts:

- Feed the anchored end of the restraint belt up through the buckle to form a loop **A**. Pull the free end of the restraint belt **B**.

To loosen the belts:

- Feed the free end of the restraint belt up through the buckle to form a loop **A**. Enlarge the loop by pulling on the end of the loop toward the buckle. Pull the anchored end of the restraint belt to shorten the free end of the restraint belt **B**.

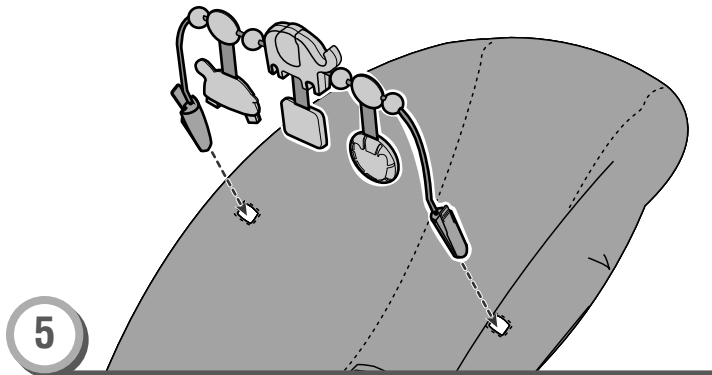

Toy Bar

- Fit the plugs on each end of the toy bar into the sockets in each side rail.
- Use the toy bar only in infant mode.
- To remove the toy bar, press the tabs on the toy bar plugs and lift.

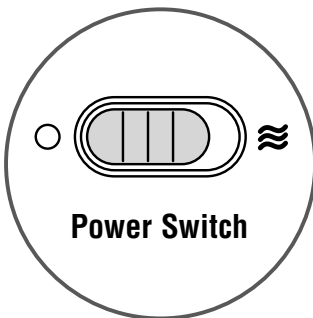

6

- Slide the power switch to the on position \approx for calming vibrations. Slide the power switch to the off position \circ to turn vibrations off.

Toddler - Upright

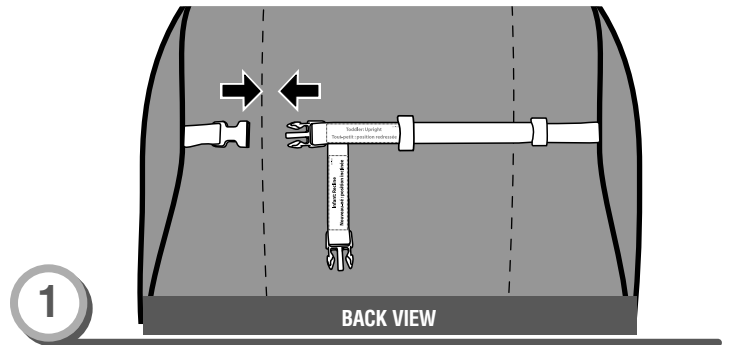

Seat Position

- Fasten the straps on the back of the pad for the Toddler-Upright Position.

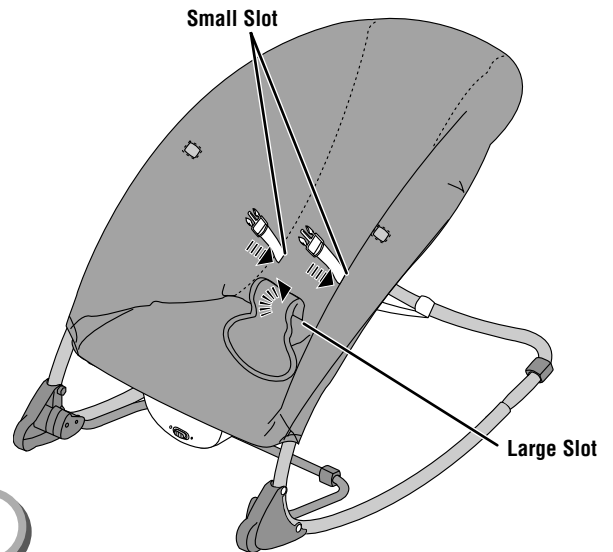

- Insert the waist restraint belts back through the small slots in the pad.
- Insert the restraint pad down through the large slot in the pad.

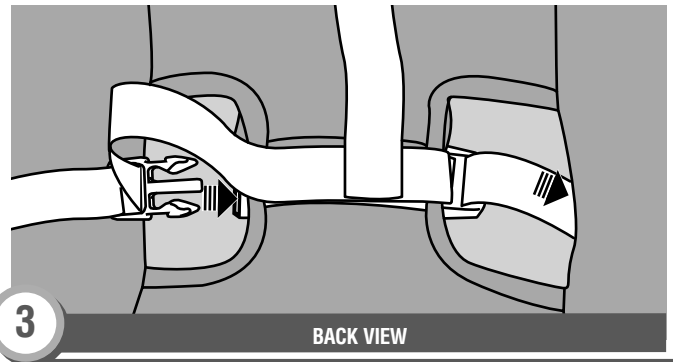

- From the back of the pad, buckle the waist belts to the restraint pad. Tuck the free ends of the waist belts into the openings in the pad.

Free Manuals Download Website

<http://myh66.com>

<http://usermanuals.us>

<http://www.somanuals.com>

<http://www.4manuals.cc>

<http://www.manual-lib.com>

<http://www.404manual.com>

<http://www.luxmanual.com>

<http://aubethermostatmanual.com>

Golf course search by state

<http://golfingnear.com>

Email search by domain

<http://emailbydomain.com>

Auto manuals search

<http://auto.somanuals.com>

TV manuals search

<http://tv.somanuals.com>