

Show & Tell **Projector** *with remote control*



Product Number: B3001

Please keep this instruction sheet for future reference,
as it contains important information.

Projector requires four "D" (LR20) **alkaline** batteries (not included).

Requires one KRP 113 Krypton light bulb (included).

Remote controller requires two (LR44) button cell batteries (included).

Adult assembly is required for battery installation and bulb replacement.

Tool required for battery installation and bulb replacement:
Phillips screwdriver (not included).

Fisher-Price®

www.fisher-price.com

Battery Installation – Projector

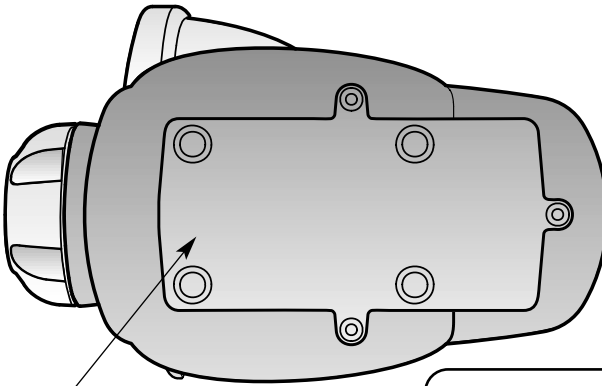

Battery Compartment Door

- Locate the battery compartment on the bottom of the projector.
- Loosen the screws in the battery compartment door with a Phillips screwdriver. Remove the battery compartment door.
- Insert four "D" (LR20) **alkaline** batteries.

Hint: We recommend using **alkaline** batteries for longer life.

- Replace the battery compartment door and tighten the screws with a Phillips screwdriver. Do not over-tighten.

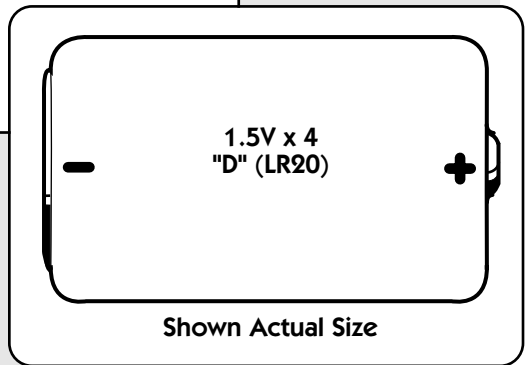

Battery Replacement – Remote Controller

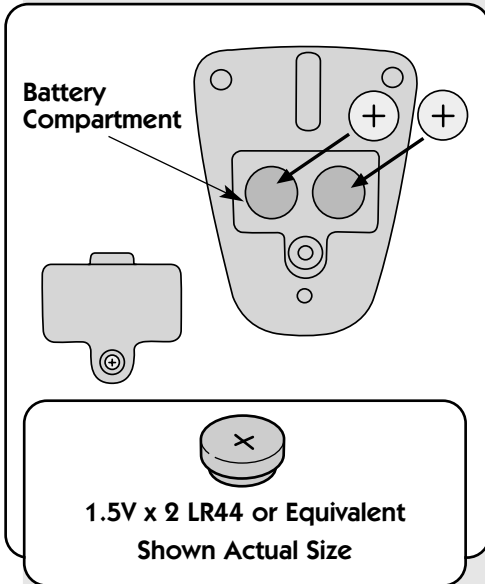

- Locate the battery compartment on the side of the remote controller.
- Loosen the screw in the battery compartment door with a Phillips screwdriver. Remove the battery compartment door.
- Insert two button cell (LR44) **alkaline** batteries.

Hint: We recommend using **alkaline** batteries for longer life.

- Replace the battery compartment door and tighten the screw with a Phillips screwdriver. Do not over-tighten.

Battery Safety Information

Batteries may leak fluids that can cause a chemical burn injury or ruin your toy. To avoid battery leakage:

- Do not mix old and new batteries or batteries of different types: alkaline, standard (carbon-zinc) or rechargeable (nickel-cadmium).
- Insert batteries as indicated either inside or outside the battery compartment.
- Remove batteries during long periods of non-use. Always remove exhausted batteries from the toy. Dispose of batteries safely. Do not dispose of batteries in a fire. The batteries may explode or leak.
- Never short-circuit the battery terminals.
- Use only batteries of the same or equivalent type, as recommended.
- Do not charge non-rechargeable batteries.
- Remove rechargeable batteries from the toy before charging.
- If removable, rechargeable batteries are used, they are only to be charged under adult supervision.

Light Bulb Replacement

CAUTION

To prevent burns from hot bulb, let bulb cool for several minutes before replacing.

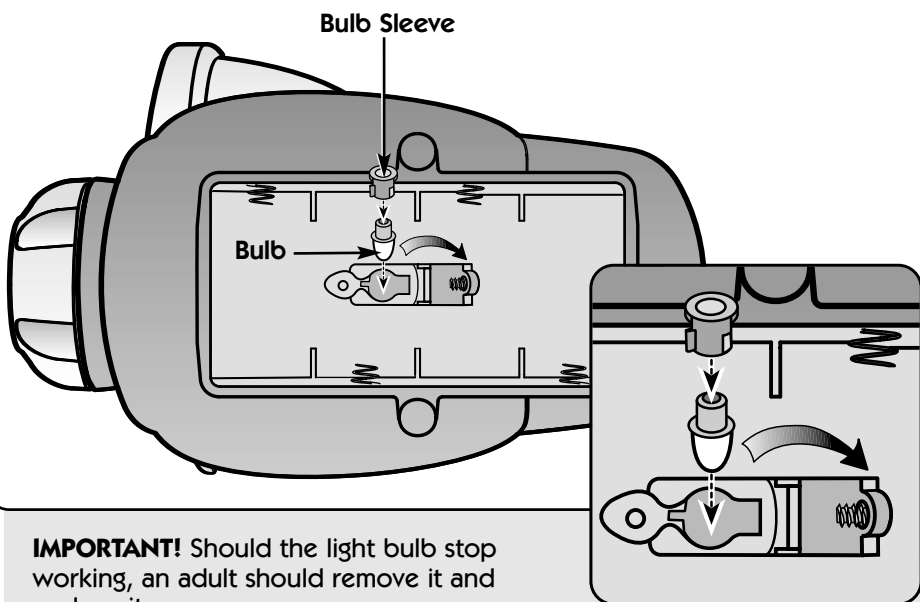

IMPORTANT! Should the light bulb stop working, an adult should remove it and replace it.

- Loosen the screws in the battery compartment with a Phillips screwdriver and remove the door.
- Remove the batteries.
- Loosen the screw in the bulb compartment door with a Phillips screwdriver and open the door.
- Remove the bulb sleeve from the bulb compartment.
- Pull to remove the light bulb. Beware of cracked or broken glass.
- Insert a new, KRP113 Krypton bulb (or equivalent) into the bulb sleeve.
- Place the bulb sleeve back in the bulb compartment.
- Close the bulb compartment door and tighten the screw with a Phillips screwdriver. Do not over-tighten.
- Replace the four size "D" (LR20) **alkaline** batteries as indicated inside the battery compartment.
- Replace the battery compartment door and tighten the screws with a Phillips screwdriver. Do not over-tighten.

Put On A Show Tonight!

Power Switch

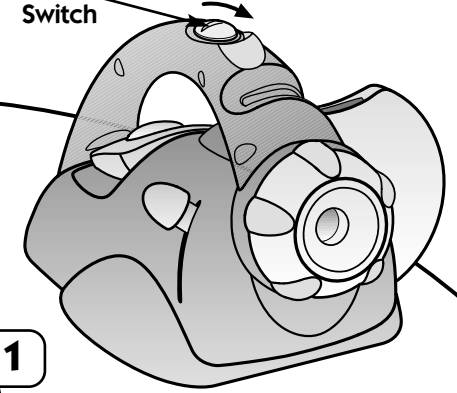

- Slide the power switch forward to turn the projector on.

3

Advance Lever

Focus Ring

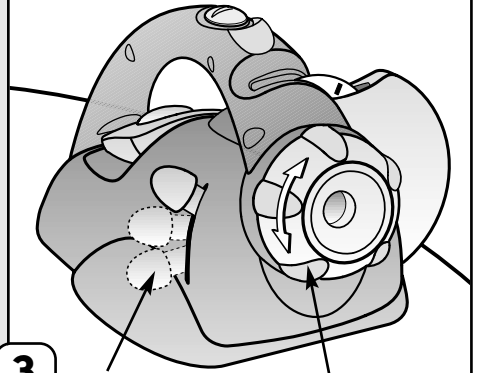

- Press the advance lever once to align the reel.
- Turn the focus ring until the image is sharp.

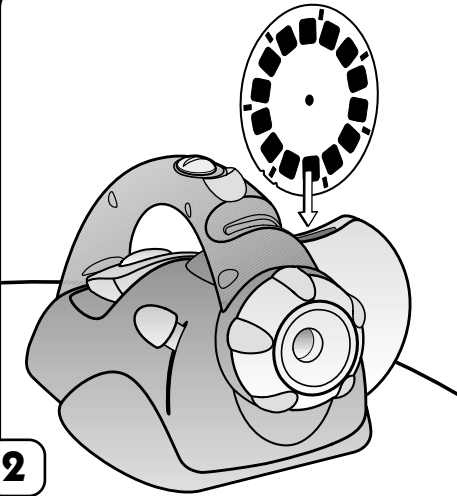

- Insert any View-Master® reel into the slot near the projector lens. Be sure to push the reel all the way in.
- To remove the reel, simply pull the reel straight up.

Remote Controller

4

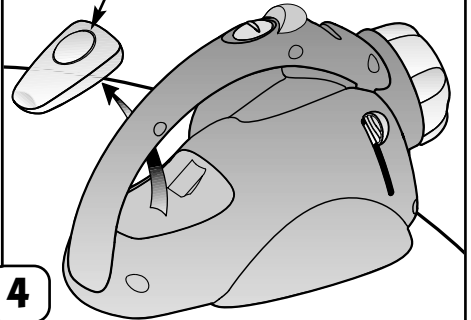

- Remove the remote controller from under the handle.

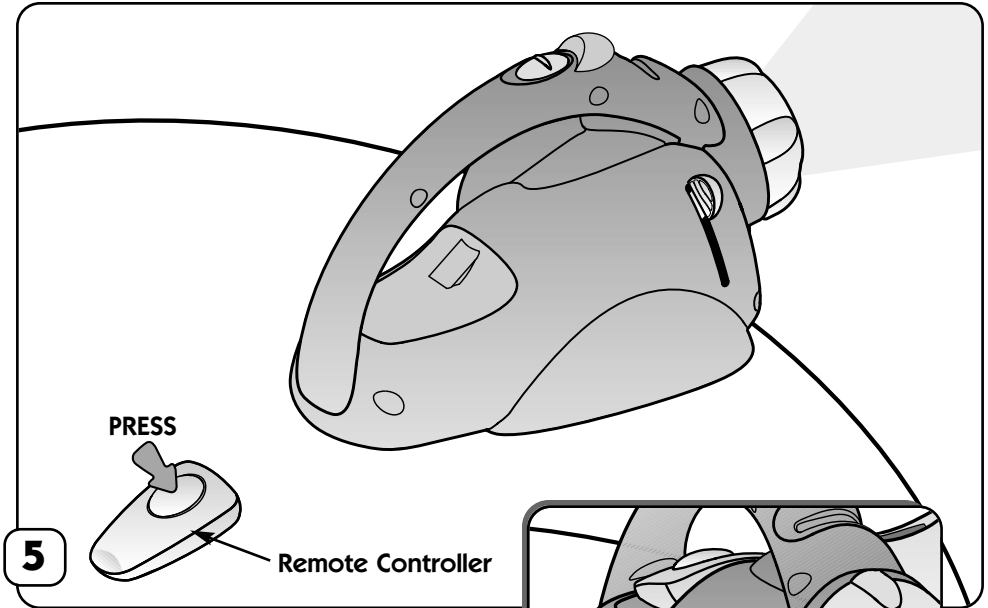

5

PRESS



Remote Controller

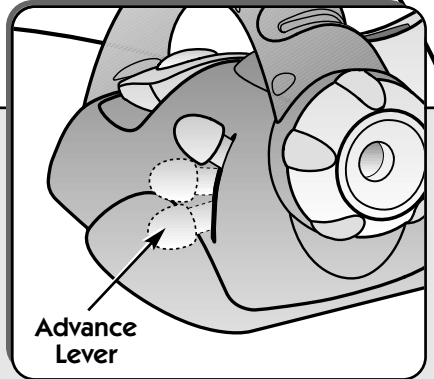

Advance
Lever

- Point the remote controller at the projector and press the button to advance to the next frame.

Hints:

- The remote controller works best when you have a clear path between the remote controller and the projector with no obstructions.
- The maximum range of the remote controller is about 10 feet. If you find the range of your remote controller is greatly reduced, battery power in the remote controller may be weak. Replace both batteries in the remote controller with fresh, new **alkaline** batteries.

- You can also change pictures by pushing the advance lever on the projector.
- If you do not advance the reel for a few minutes, the projector shuts off automatically. Press the advance lever **on the projector** to turn it on again.
- It is normal for the projector to be warm to the touch after extended periods of use.
- After the show, snap the remote controller back under the handle for storage.

Fun Tips

- For the steadiest picture show, place the projector on a hard flat surface.
- Make sure the room is completely dark for the best possible image.
- You can turn the projector into a flashlight by simply removing the reel.

Care

- Wipe this toy with a clean cloth dampened with a mild soap and water solution. Do not immerse this toy.
- This toy has no consumer serviceable parts. Do not take this toy apart.
- Do not drop this toy on a hard surface.

FCC Note (United States Only)

Note: This equipment has been tested and found to comply with the limits for a Class B digital device, pursuant to Part 15 of the FCC Rules. These limits are designed to provide reasonable protection against harmful interference in a residential installation. This equipment generates, uses and can radiate radio frequency energy and, if not installed and used in accordance with the instructions, may cause harmful interference to radio communications. However, there is no guarantee that interference will not occur in a particular installation. If this equipment does cause harmful interference to radio or television reception, which can be determined by turning the equipment off and on, the user is encouraged to try to correct the interference by one or more of the following measures:

- Reorient or relocate the receiving antenna.
- Increase the separation between the equipment and receiver.
- Consult the dealer or an experienced radio/TV technician for help.

Note: Changes or modifications not expressly approved by the manufacturer responsible for compliance could void the user's authority to operate the equipment.

Questions? We'd like to hear from you!

Call Fisher-Price® Consumer Relations, toll-free at
1-800-432-5437, 8 AM - 6 PM EST Monday through Friday.
Hearing-impaired consumers using TTY/TDD equipment, please
call 1-800-382-7470. Or, write to: Fisher-Price® Consumer
Relations, 636 Girard Avenue, East Aurora, New York 14052.

For countries outside the United States:

CANADA

Questions? 1-800-567-7724, Mattel Canada Inc., 6155 Freemont Blvd., Mississauga,
Ontario L5R 3W2.

GREAT BRITAIN

Mattel UK Ltd, Vanwall Business Park, Maidenhead SL6 4UB. Helpline: 01628 500302.

AUSTRALIA

Australia: Mattel Australia Pty. Ltd., 658 Church Street, Locked Bag #870, Richmond,
Victoria 3121 Australia. Consumer Advisory Service 1300 135 312.

NEW ZEALAND

16-18 William Pickering Drive, Albany 1331, Auckland.

ASIA

Mattel East Asia Ltd, Room 1106, South Tower, World Finance Centre, Harbour City, Tsimshatsui, HK, China.

Fisher-Price, Inc., a subsidiary of Mattel, Inc., East Aurora, NY 14052 U.S.A.

© 2003 Mattel, Inc. All Rights Reserved. © and ™ designate U.S. trademarks of Mattel, Inc.

View-Master® and View-Master Logo are U.S. trademarks of Mattel, Inc.

www.view-master.com

Free Manuals Download Website

<http://myh66.com>

<http://usermanuals.us>

<http://www.somanuals.com>

<http://www.4manuals.cc>

<http://www.manual-lib.com>

<http://www.404manual.com>

<http://www.luxmanual.com>

<http://aubethermostatmanual.com>

Golf course search by state

<http://golfingnear.com>

Email search by domain

<http://emailbydomain.com>

Auto manuals search

<http://auto.somanuals.com>

TV manuals search

<http://tv.somanuals.com>