

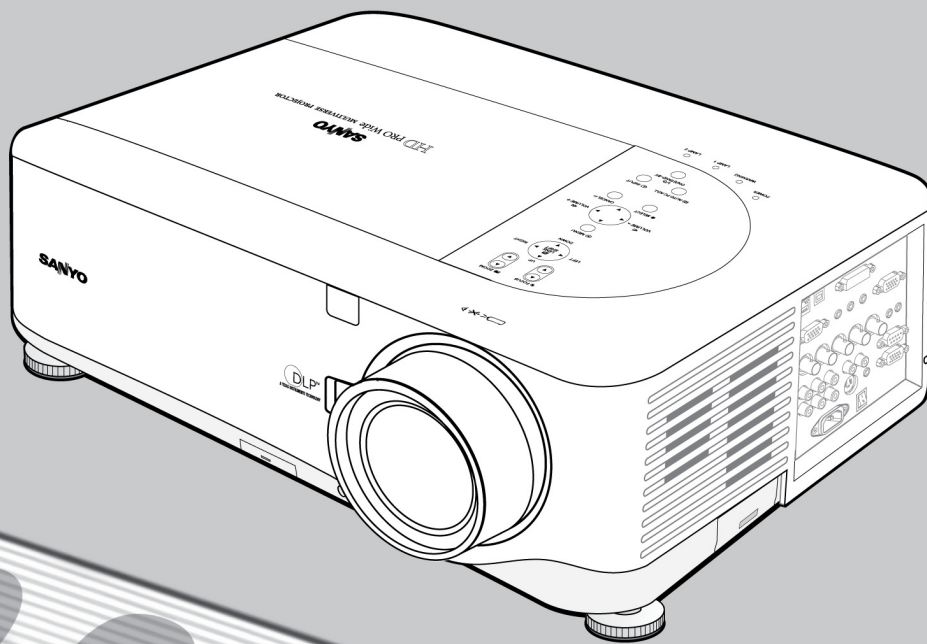

Multimedia Projector

MODEL PDG-DWT50L
PDG-DWT50KL



* Projection lens is optional.

PROJECTOR

User's Manual



- DLP is a registered trademark of Texas Instruments. BrilliantColor and DynamicBlack are trademarks of Texas Instruments.
- IBM is a trademark or registered trademark of International Business Machines Corporation.
- Macintosh, Mac OS X and PowerBook are trademarks of Apple, Inc., registered in the U.S. and other countries.
- Windows, Windows 98, Windows Me, Windows XP or Windows 2000 are trademarks or registered trademarks of Microsoft Corporation.
- Trademark PJLink is a trademark applied for trademark rights in Japan, the United States of America and other countries and areas.
- Other product and company names mentioned in this user's manual may be the trademarks or registered trademarks of their respective holders.

Notes

- (1) The contents of this user's manual may not be reprinted in part or whole without permission.
- (2) The contents of this user's manual are subject to change without notice.
- (3) The On-Screen Menu and figures in this manual may differ slightly from the product.
- (4) Great care has been taken in the preparation of this user's manual; however, should you notice any questionable points, errors or omissions, please contact us.
- (5) Notwithstanding article (3), SANYO will not be responsible for any claims on loss of profit or other matters deemed to result from using the Projector.





To the Owner

Before installing and operating the projector, read this manual thoroughly.

The projector provides many convenient features and functions. Operating the projector properly enables you to manage those features and maintains it in good condition for many years to come.

Improper operation may result in not only shortening the product life, but also malfunctions, fire hazard, or other accidents.

If your projector seems to operate improperly, read this manual again, check operations and cable connections and try the solutions in the "Troubleshooting" section in the back of this booklet. If the problem still persists, contact the dealer where you purchased the projector or the service center.

	CAUTION RISK OF ELECTRIC SHOCK DO NOT OPEN	
CAUTION: TO REDUCE THE RISK OF ELECTRIC SHOCK, DO NOT REMOVE COVER (OR BACK). NO USER-SERVICEABLE PARTS INSIDE EXCEPT LAMP REPLACEMENT. REFER SERVICING TO QUALIFIED SERVICE PERSONNEL.		
	THIS SYMBOL INDICATES THAT DANGEROUS VOLTAGE CONSTITUTING A RISK OF ELECTRIC SHOCK IS PRESENT WITHIN THIS UNIT.	
	THIS SYMBOL INDICATES THAT THERE ARE IMPORTANT OPERATING AND MAINTENANCE INSTRUCTIONS IN THE USER'S MANUAL WITH THIS UNIT.	

NOTE: This symbol and recycle system are applied only to EU countries and not applied to the countries in the other area of the world.



Your SANYO product is designed and manufactured with high quality materials and components which can be recycled and reused.

This symbol means that electrical and electronic equipment, at their end-of-life, should be disposed of separately from your household waste.

Please dispose of this equipment at your local community waste collection/recycling center.

In the European Union there are separate collection systems for used electrical and electronic products.

Please help us to conserve the environment we live in!

READ AND KEEP THIS USER'S MANUAL FOR LATER USE.



Safety Precaution

WARNING:

TO REDUCE THE RISK OF FIRE OR ELECTRIC SHOCK, DO NOT EXPOSE THIS APPLIANCE TO RAIN OR MOISTURE.

- This projector produces intense light from the projection lens. Do not stare directly into the lens as much as possible, otherwise eye damage could result. Be especially careful that children do not stare directly into the beam.
- Install the projector in a proper position. Otherwise it may result in fire hazard.
- Allowing the proper amount of space on the top, sides, and rear of the projector cabinet is critical for proper air circulation and cooling of the unit. The dimension shown here indicates the minimum space required.
If the projector is to be built into a compartment or similarly enclosed, these minimum distances must be maintained.
- Do not cover the ventilation slot on the projector. Heat build-up can reduce the service life of your projector, and can also be dangerous.

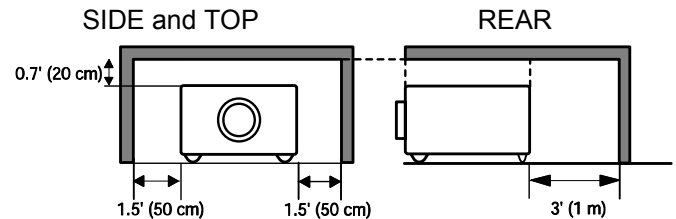

- If the projector is unused for an extended time, unplug the projector from the power outlet.



CAUTION ON HANGING FROM THE CEILING

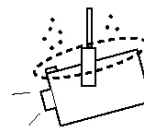

When hanging the projector from the ceiling, clean air intake vents, filters, or top of the projector periodically with a vacuum cleaner. If you leave the projector unclean for a long time, the cooling fans can be clogged with dust, and it may cause a breakdown.

DO NOT SET THE PROJECTOR IN GREASY, WET, OR CONDITIONS SUCH AS IN A KITCHEN TO PREVENT A BREAKDOWN. IF THE PROJECTOR COMES IN CONTACT WITH OIL OR CHEMICALS, IT MAY BECOME DETERIORATED.

WARNING:

Not for use in a computer room as defined in the Standard for the Protection of Electronic Computer/Data Processing Equipment, ANSI/NFPA 75.

Ne peut être utilisé dans une salle d'ordinateurs telle que définie dans la norme ANSI/NFPA 75 Standard for Protection of Electronic Computer/Data Processing Equipment.

Safety Instructions

All the safety and operating instructions should be read before the product is operated.

Read all of the instructions given here and retain them for later use. Unplug this projector from AC power supply before cleaning. Do not use liquid or aerosol cleaners. Use a damp cloth for cleaning.

Follow all warnings and instructions marked on the projector.

For added protection to the projector during a lightning storm, or when it is left unattended and unused for long periods of time, unplug it from the wall outlet. This will prevent damage due to lightning and power line surges.

Do not expose this unit to rain or use near water... for example, in a wet basement, near a swimming pool, etc...

Do not use attachments not recommended by the manufacturer as they may cause hazards.

Do not place this projector on an unstable cart, stand, or table. The projector may fall, causing serious injury to a child or adult, and serious damage to the projector. Use only with a cart or stand recommended by the manufacturer, or sold with the projector. Wall or shelf mounting should follow the manufacturer's instructions, and should use a mounting kit approved by the manufacturers.

An appliance and cart combination should be moved with care. Quick stops, excessive force, and uneven surfaces may cause the appliance and cart combination to overturn.



Slots and openings in the back and bottom of the cabinet are provided for ventilation, to ensure reliable operation of the equipment and to protect it from overheating.

The openings should never be covered with cloth or other materials, and the bottom opening should not be blocked by placing the projector on a bed, sofa, rug, or other similar surface. This projector should never be placed near or over a radiator or heat register.

This projector should not be placed in a built-in installation such as a bookcase unless proper ventilation is provided.

Never push objects of any kind into this projector through cabinet slots as they may touch dangerous voltage points or short out parts that could result in a fire or electric shock. Never spill liquid of any kind on the projector.

Do not install the projector near the ventilation duct of air-conditioning equipment.

This projector should be operated only from the type of power source indicated on the marking label. If you are not sure of the type of power supplied, consult your authorized dealer or local power company.

Do not overload wall outlets and extension cords as this can result in fire or electric shock. Do not allow anything to rest on the power cord. Do not locate this projector where the cord may be damaged by persons walking on it.

Do not attempt to service this projector yourself as opening or removing covers may expose you to dangerous voltage or other hazards. Refer all servicing to qualified service personnel.

Unplug this projector from wall outlet and refer servicing to qualified service personnel under the following conditions:

- When the power cord or plug is damaged or frayed.
- If liquid has been spilled into the projector.
- If the projector has been exposed to rain or water.
- If the projector does not operate normally by following the operating instructions. Adjust only those controls that are covered by the operating instructions as improper adjustment of other controls may result in damage and will often require extensive work by a qualified technician to restore the projector to normal operation.
- If the projector has been dropped or the cabinet has been damaged.
- When the projector exhibits a distinct change in performance-this indicates a need for service.

When replacement parts are required, be sure the service technician has used replacement parts specified by the manufacturer that have the same characteristics as the original part. Unauthorized substitutions may result in fire, electric shock, or injury to persons.

Upon completion of any service or repairs to this projector, ask the service technician to perform routine safety checks to determine that the projector is in safe operating condition.



Voor de klanten in Nederland

Bij dit produkt zijn batterijen geleverd.

Wanneer deze leeg zijn, moet u ze niet weggooien maar inleveren als KCA.

Important Information

Air Circulation

Openings in the cabinet are provided for ventilation. To ensure reliable operation of the product and to protect it from overheating, these openings must not be blocked or covered.



CAUTION

Hot air is from the exhaust vent. When using or installing the projector, the following precautions should be taken.

- Do not put any flammable objects or spray cans near the projector, hot air is exhausted from the air vents.
- Keep the exhaust vent at least 3 feet (1 m) away from any objects.
- Do not touch peripheral parts in the exhaust vents, especially screws and metallic parts. These areas will become hot while the projector is used.
- Do not put anything on the cabinet. Objects put on the cabinet will not only get damaged but may also cause a fire hazard.

Cooling fans are provided to cool down the projector. The fans' running speed is changed according to the temperature inside the projector.

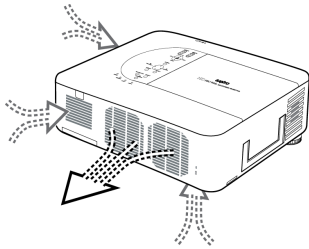

Installing the Projector in Proper Position

Install the projector properly. Improper installation may reduce the lamp lifetime and cause a fire hazard.

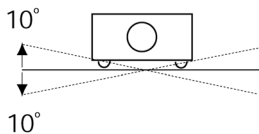

Do not tilt the projector more than 10 degrees above and below.



NO UPWARD

Do not point the projector up to project an image.



NO DOWNWARD

Do not point the projector down to project an image.

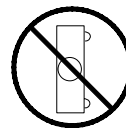

NO SIDEWAYS

Do not put the projector on either side to project an image.

IMPORTANT! Clean the Filter Regularly!!

The projector uses a lamp which generates significant heat. The cooling fans and air vents are provided to dissipate the heat by drawing air into the housing and the filter is located in the intake vents to prevent dust from getting inside of the projector.

In order to care for the projector appropriately, regular cleaning is required. Remove any dirt or dust that has accumulated on the projector and on or in the filter.

When the "Please clean filter" message is displayed, stop using the projector immediately and clean or replace the filter.

Blocking the air vents and leaving the projector uncleaned for a long time may not only damage the projector and may require costly repairs but may also cause accidents or fire.

For maintenance of the filter, refer to "Option" on page 83 and "Replacing the Filters" on pages 97 – 98.

Damages to the projector caused by using an un-cleaned filter or improper maintenance will void the warranty on the projector.

Compliance

Federal Communications Commission Notice

This equipment has been tested and found to comply with the limits for a Class B digital device, pursuant to Part 15 of the FCC Rules. These limits are designed to provide reasonable protection against harmful interference in a residential installation. This equipment generates, uses, and can radiate radio frequency energy and, if not installed and used in accordance with the instructions, may cause harmful interference to radio communications. However, there is no guarantee that interference will not occur in a particular installation. If this equipment does cause harmful interference to radio or television reception, which can be determined by turning the equipment off and on, the user is encouraged to try to correct the interference by one or more of the following measures:

- Reorient or relocate the receiving antenna. Increase the separation between the equipment and receiver.
- Connect the equipment into an outlet on a circuit different from that to which the receiver is connected.
- Consult the dealer or an experienced radio/TV technician for help.

Use of shielded cable is required to comply with class B limits in Subpart B of Part 15 of FCC Rules.

Do not make any changes or modifications to the equipment unless otherwise specified in the instructions. If such changes or modifications should be made, you could be required to stop operation of the equipment.

Model Number(s) : PDG-DWT50L
Trade Name : Sanyo
Responsible party : SANYO FISHER COMPANY
Address : 21605 Plummer Street, Chatsworth, California 91311 U.S.A.
Telephone No. : (818)998-7322

AC Power Cord Requirement

The AC Power Cord supplied with this projector meets the requirement for use in the country you purchased it.

AC Power Cord for the United States and Canada:

AC Power Cord used in the United States and Canada is listed by the Underwriters Laboratories (UL) and certified by the Canadian Standard Association (CSA).

AC Power Cord has a grounding-type AC line plug. This is a safety feature to be sure that the plug will fit into the power outlet. Do not try to defeat this safety feature. Should you be unable to insert the plug into the outlet, contact your electrician.

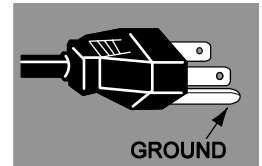

AC Power Cord for the United Kingdom:

This cord is already fitted with a modularized plug incorporating a fuse, the value of which is indicated on the pin face of the plug. Should the fuse need to be replaced, an ASTA approved BS 1362 fuse must be used of the same rating, marked thus . If the fuse cover is detachable, never use the plug with the cover omitted. If a replacement fuse cover is required, ensure it is of the same color as that visible on the pin face of the plug (i.e. red or orange). Fuse covers are available from the Parts Department indicated in your User Instructions. If the plug supplied is not suitable for your socket outlet, it should be cut off and destroyed. The end of the flexible cord should be suitably prepared and the correct plug fitted.

WARNING: A PLUG WITH BARED FLEXIBLE CORD IS HAZARDOUS IF ENGAGED IN A LIVE SOCKET OUTLET.

The Wires in this mains lead are colored in accordance with the following code:

Green-and-yellow Earth
Blue Neutral
Brown Live

As the colors of the wires in the mains lead of this apparatus may not correspond with the colored markings identifying the terminals in your plug proceed as follows:

The wire which is colored green-and-yellow must be connected to the terminal in the plug which is marked by the letter E or by the safety earth symbol  or colored green or green-and-yellow.

The wire which is colored blue must be connected to the terminal which is marked with the letter N or colored black. The wire which is colored brown must be connected to the terminal which is marked with the letter L or colored red.

WARNING: THIS APPARATUS MUST BE EARTHED.

THE SOCKET-OUTLET SHOULD BE INSTALLED NEAR THE EQUIPMENT AND EASILY ACCESSIBLE.

Table of Contents

1. INTRODUCTION	1
❶ WHAT'S IN THE BOX?	1
❷ INTRODUCTION TO THE PROJECTOR.....	2
<i>Features you'll enjoy:</i>	2
❸ PART NAMES OF THE PROJECTOR	3
<i>Front-right view</i>	3
<i>Top view</i>	4
<i>Bottom view</i>	5
❹ TOP FEATURES	6
<i>Lens Controls</i>	6
<i>OSD Controls and Status LEDs</i>	7
❺ TERMINAL PANEL FEATURES	9
❻ PART NAMES OF THE REMOTE CONTROL	11
<i>Battery Installation</i>	13
<i>Operating Range for Wireless Remote Control</i>	14
<i>Remote Control Precautions</i>	14
<i>Remote Control Codes</i>	14
<i>Using the Remote Control in Wired Operation</i>	15
<i>Carrying the Projector</i>	16
2. INSTALLATION AND CONNECTIONS	17
❶ SETTING UP THE SCREEN AND THE PROJECTOR	17
❷ SELECTING A LOCATION.....	18
❸ INSTALLING OR REMOVING THE OPTIONAL LENS	19
<i>Removing the Existing Lens From the Projector</i>	19
<i>Installing the New Lens</i>	20
<i>Installing the New Lens Using the anti-theft screw</i>	21
❹ THROW DISTANCE AND SCREEN SIZE	22
❺ INSTALLING THE OPTIONAL COLOR WHEEL	24
❻ MAKING CONNECTIONS.....	26
<i>Connecting Your PC or Macintosh Computer</i>	26
<i>Connecting an External Monitor</i>	28
<i>Connecting Your DVD Player with Component Output</i>	29
<i>Connecting Your VCR or Laser Disc Player</i>	30
❼ CONNECTING THE SUPPLIED POWER CABLE	31
<i>NOTE ON THE POWER CORD</i>	31
3. PROJECTING AN IMAGE (BASIC OPERATION)	32
❶ TURNING ON THE PROJECTOR.....	32
<i>Note on Startup Screen (Menu Language Select screen)</i>	33
❷ SELECTING AN INPUT SOURCE	34
❸ ADJUSTING THE PICTURE POSITION AND PICTURE SIZE.....	35
<i>Adjusting Picture Position Manually</i>	35
<i>Lens Shift Adjustable Range</i>	36
<i>From the Remote Control Unit</i>	37
<i>Adjusting the Projector Level</i>	38
❹ OPTIMIZING AN RGB IMAGE AUTOMATICALLY	39
<i>Adjusting the Image Using AUTO PC ADJ</i>	39
❺ ADJUSTING VOLUME UP AND DOWN	40
❻ TURNING OFF THE PROJECTOR	41
<i>About Direct Power Off</i>	42
<i>After Use</i>	42
4. CONVENIENT FEATURES	43
❶ TURNING OFF THE IMAGE AND SOUND	43
❷ FREEZING A PICTURE.....	43
❸ ADJUSTING THE FOCUS/ZOOM MANUALLY.....	44

<i>Adjusting by Using the OSD Control Panel</i>	44
④ CHANGING LAMP MODE.....	45
<i>Changing Lamp Mode by Using the Projector's OSD Control Panel</i>	45
<i>Changing Lamp Mode by Using the Remote Control</i>	46
⑤ GETTING INFORMATION.....	47
⑥ ADJUSTING POSITION/TOTAL DOTS/FINE SYNC.....	48
<i>Adjusting Position/Total Dots/Fine Sync by using the OSD Control Panel</i>	48
<i>Correcting Keystone by Using the Remote Control</i>	49
⑦ PREVENTING THE UNAUTHORIZED USE OF THE PROJECTOR.....	51
<i>Locking the Projector</i>	51
<i>Unlocking the Projector</i>	53
⑧ USING THE PHYSICAL LOCK.....	54
<i>Using the Kensington Lock</i>	54
<i>Using the Security Chain Lock</i>	54
5. USING ON-SCREEN DISPLAY.....	55
① USING THE MENUS.....	55
<i>Navigating the OSD</i>	55
② MENU TREE.....	57
③ MENU ELEMENTS.....	59
④ SOURCE MENU DESCRIPTIONS AND FUNCTIONS.....	60
⑤ ADJUST MENU DESCRIPTIONS AND FUNCTIONS.....	61
<i>Image menu</i>	61
<i>Image options menu</i>	62
<i>Video menu</i>	64
⑥ DETAIL SETTINGS MENU DESCRIPTIONS AND FUNCTIONS.....	67
<i>Basic</i>	67
<i>White balance</i>	69
<i>Color correction</i>	70
⑦ SETTING MENU DESCRIPTIONS AND FUNCTIONS.....	71
<i>Basic</i>	71
<i>Installation</i>	75
<i>Network setting</i>	82
<i>Option</i>	83
⑧ INFORMATION MENU DESCRIPTIONS AND FUNCTIONS.....	89
<i>Usage time</i>	89
<i>Input</i>	90
<i>Network</i>	91
<i>Version</i>	92
⑨ RESET MENU DESCRIPTIONS AND FUNCTIONS.....	93
6. MAINTENANCE.....	94
① CLEANING THE PROJECTOR.....	94
<i>Cleaning the Cabinet</i>	94
<i>Cleaning the Lens</i>	94
<i>Cleaning the Filters</i>	95
② REPLACING CONSUMABLE PARTS.....	97
<i>Replacing the Filters</i>	97
<i>Replacing the Lamps</i>	99
<i>Resetting the Lamp Time Counter</i>	101
<i>Ordering a Replacement Lamp</i>	101
7. APPENDIX.....	102
① TROUBLESHOOTING.....	102
<i>Indicator Messages</i>	102
<i>Common Problems and Solutions</i>	104
<i>Tips for Troubleshooting</i>	104
② IMAGE PROBLEMS.....	105

Table of Contents

<i>Lamp Problems</i>	105
<i>Remote Control Problems</i>	106
<i>Audio Problems</i>	106
③ HAVING THE PROJECTOR SERVICED	106
8. SPECIFICATIONS	107
① PROJECTOR SPECIFICATIONS	107
<i>Optical Specifications</i>	107
<i>Electrical Specifications</i>	108
<i>Mechanical Specifications</i>	109
<i>Environmental Considerations</i>	109
<i>Regulations</i>	109
<i>Optional Parts</i>	110
② CABINET DIMENSIONS	111
③ PIN ASSIGNMENTS OF MINI D-SUB 15 PIN INPUT CONNECTOR	112
④ COMPATIBLE INPUT SIGNAL LIST	113
⑤ PC CONTROL CODES AND CABLE CONNECTIONS	115
<i>Functional Execution Command Table</i>	115
<i>Status Read Command Table</i>	116
⑥ SCREEN TRIGGER	117
⑦ OPERATION USING HTTP BROWSER	118
<i>Overview</i>	118
<i>Preparation Before Use</i>	118
<i>Handling of the Address for Operation by Using a Browser</i>	118
<i>Configuring Network Settings</i>	119
<i>Structure of the HTTP Server</i>	121
⑧ 15 PIN GPIO CONTROL	123
9. TROUBLESHOOTING CHECK LIST	124

1. Introduction

❶ What's in the Box?

Carefully unpack the projector and check that the following items are included:

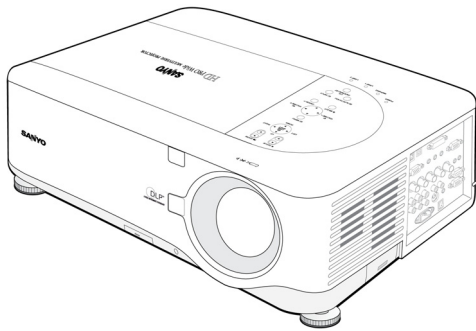

PDG-DWT50L Projector

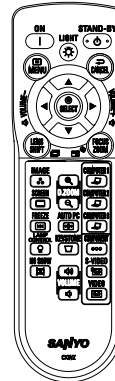

Remote Control
(with Two AA alkaline batteries)

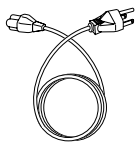

Power Cable
(3.6m/11.8 ft.)
→ **For North America, Europe and the UK**



Remote Cable
(10m/33ft)

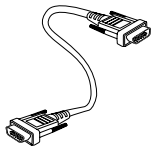

VGA Cable

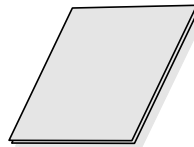

Quick Start Guide

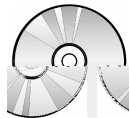

CD-ROM
(This User's manual)



Lens Hole Cap
(Installed)



- Anti-Theft Screw for lens x 1
- Security Sticker



Contact your dealer immediately if any items are missing, appear damaged, or if the unit does not work.

CAUTION



Avoid using the projector in dusty environments.

1. Introduction

② Introduction to the Projector

Features you'll enjoy:

DLP projector with high resolution

The combination of BrilliantColor™ and a six-segment color wheel (optional) offer a more true color reproduction.

Installation Flexibility

This projector has many useful functions such as powered lens shifting, ceiling and rear projection, variety of extensive optional powered lens with bayonet mount with release button, etc.

Multiple Interface Terminals

The projector has several interface terminals that can support various types of equipment and signals.

Dual Lamp Control System

The two-lamp control system offers high brightness, maintained lamp life and energy savings along with redundancy. The lamp control function offers brightness of the lamp can be selected. The power management function also reduces power consumption and maintains lamp life.

Simple Computer System Setting

The projector has the Multi-scan system to conform to almost all computer output signals quickly. Up to UXGA resolution can be accepted.

Security Function

The Security function helps you to ensure security of the projector. With the Key lock function, you can lock the operation on the top control. PIN code lock functions prevent unauthorized use of the projector.

Multilanguage Menu Display

Operation menu is available in 8 languages: English, German, French, Italian, Spanish, Swedish, Chinese, and Japanese.

Multi-use Remote Control

Use the remote control as wired or wireless. Eight remote control codes are available.

3W + 3W Stereo Speaker

Built in 3W x 2 speakers are provided.

Helpful Maintenance Functions

The lamp and filter maintenance functions provide for better and proper maintenance of the projector. Easy maintenance cover is provided for lamp and color wheel replacement.

Direct Power Off and On Start

The Direct Power Off function allows the projector to be turned off (even when projecting an image) using a power strip equipped with a switch and a breaker. The On Start function allows the projector to be turned on by supplied AC power.

Note:

Before using Direct Power Off, be sure to allow at least 20 minutes immediately after turning on the projector and starting to display an image. Also, the power cord can be removed immediately after turning off the projector. On Start manual may differ slightly from the product.

On Start eliminates the need to always use the POWER (ON/STANDBY) button on the remote control or projector cabinet.

3 Part Names of the Projector

Front-right view

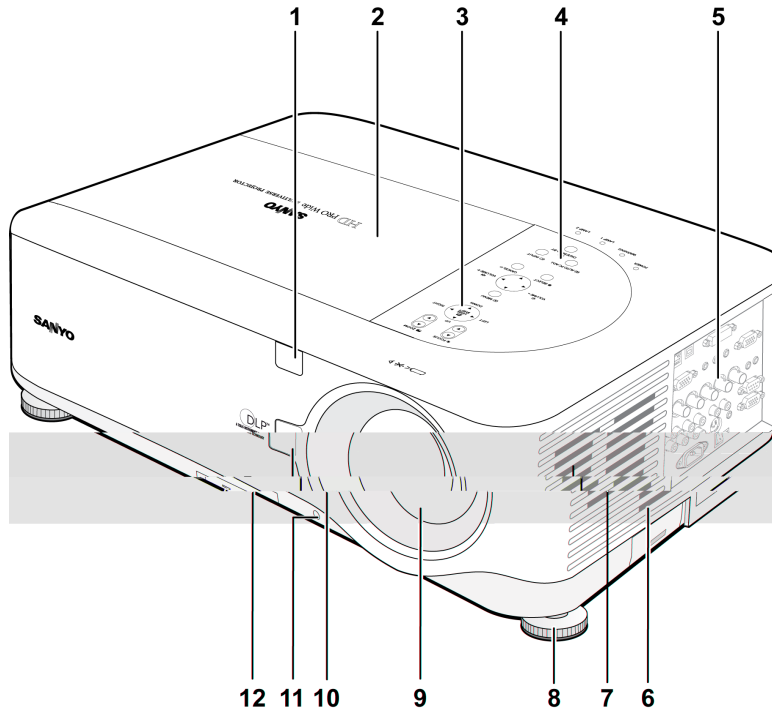

ITEM	LABEL	DESCRIPTION	SEE PAGE:
1.	IR receiver	Receiver for IR signal from remote control	11
2.	Lamp cover	Remove cover to replace lamp or color wheel	99
3.	Lens control panel	See Lens Controls	6
4.	OSD control panel	See OSD Controls and Status LEDs	7
5.	I/O connector panel	Connect various input devices	9
6.	Intake vent	Lamp cooling vent – do not obstruct	—
7.	Speakers	Built-in stereo speakers	—
8.	Height adjuster	Adjusts level of projector	5
9.	Lens	Remove lens cap before use	—
10.	Lens release button	Press the release button before removing the lens	—
11.	Anti-Theft screw	Prevent theft of the lens	—
12.	Intake vent and front filter	Keeps the front fan free of dust – clean regularly for optimum performance – do not obstruct	95

Important:

Grill openings on the projector allow for good air circulation, which keeps the projector lamp cool. Do not obstruct any of the grill openings.

1. Introduction

Top view

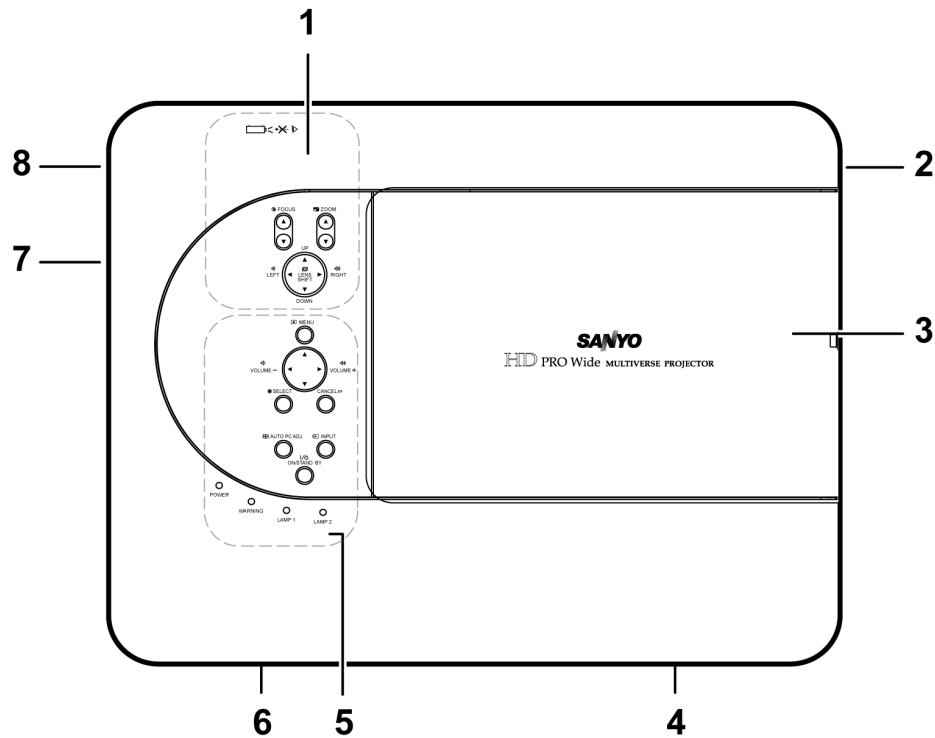

ITEM	LABEL	DESCRIPTION	SEE PAGE:
1.	Lens control panel	See Lens Controls	6
2.	Right-hand speaker	Right-hand speaker	—
3.	Lamp cover	Remove cover to replace lamp or color wheel	99
4.	Exhaust vent	Exhaust vent – do not obstruct	—
5.	OSD control panel	See OSD Controls and Status LEDS	7
6.	Rear intake vent	Rear cooling intake – do not obstruct	—
7.	Left intake vent	Left-hand cooling intake – do not obstruct	—
8.	Left-hand speaker	Left-hand speaker	—

Bottom view

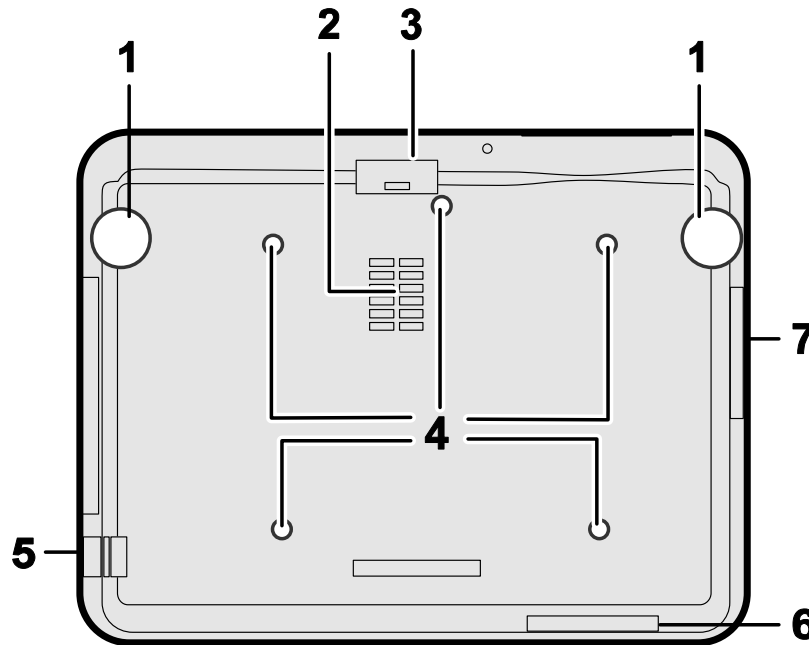

ITEM	LABEL	DESCRIPTION	SEE PAGES:
1.	Height adjusters	Adjust projection height	38
2.	Intake vent	Color wheel cooling vent – do not obstruct	—
3.	Front filter	Keep the fan free of dust – clean regularly for optimum performance	95
4.	Ceiling support holes	Contact your dealer for information on mounting the projector on a ceiling	—
5.	Security chain opening	Attach anti-theft device – see 8 Using the Physical Lock	54
6.	Rear filter	Keep the fans free of dust – clean regularly for optimum performance	95
7.	Side filter		

CAUTION



With ceiling installation, use approved mounting hardware & M4 screws; maximum depth of screw: 12 mm; distance from ceiling/ wall: 20 cm (0.7 feet) for proper ventilation; distance from fluorescent lamps: at least 1 m (3 feet) front and back of the projector. For permanent installations, follow local codes.

1. Introduction

④ Top Features

Lens Controls

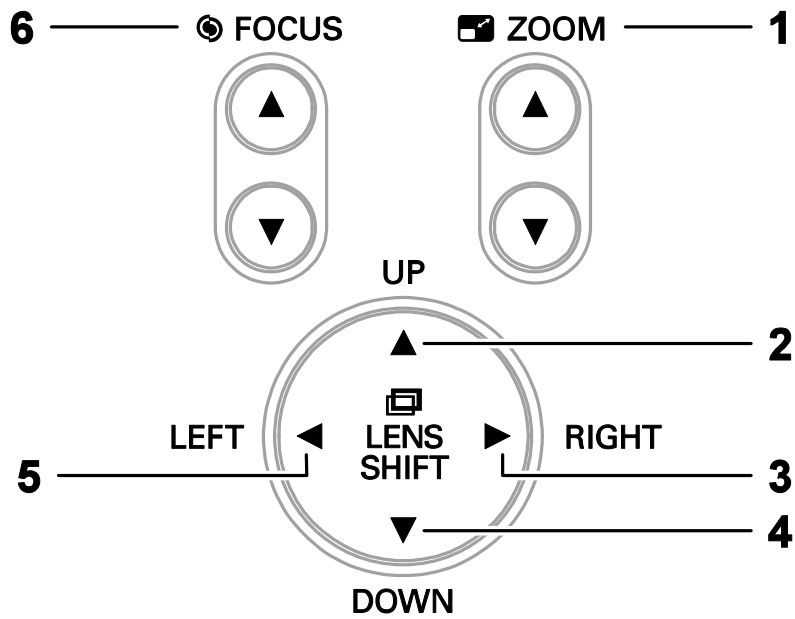

ITEM	LABEL	DESCRIPTION	SEE PAGE:
1.	ZOOM	Increase/decrease projected image size	44
2.	UP CURSOR	Move image left, right, up, or down	
3.	RIGHT CURSOR		
4.	DOWN CURSOR		
5.	LEFT CURSOR		
6.	FOCUS	Focus the projected image	44

Controls and Status

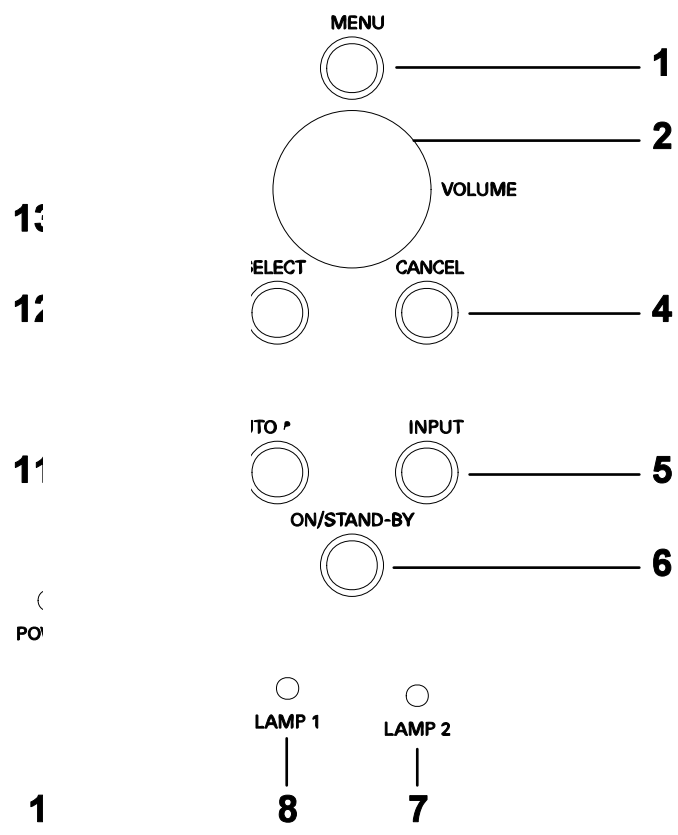

13

12

11

(
PO

1

1. Introduction

ITEM	LABEL	DESCRIPTION	SEE PAGE:
8.	LAMP 1 (LED)	See Indicator Messages	102
9.	WARNING (LED)	See Indicator Messages	102
10.	POWER (LED)	See Indicator Messages	102
11.	AUTO PC ADJ.	Optimize image size, position, and resolution	39
12.	SELECT	Select or change settings in the OSD	55
13.	LEFT CURSOR/VOLUME DECREASE	Decrease volume	40

5 Terminal Panel Features

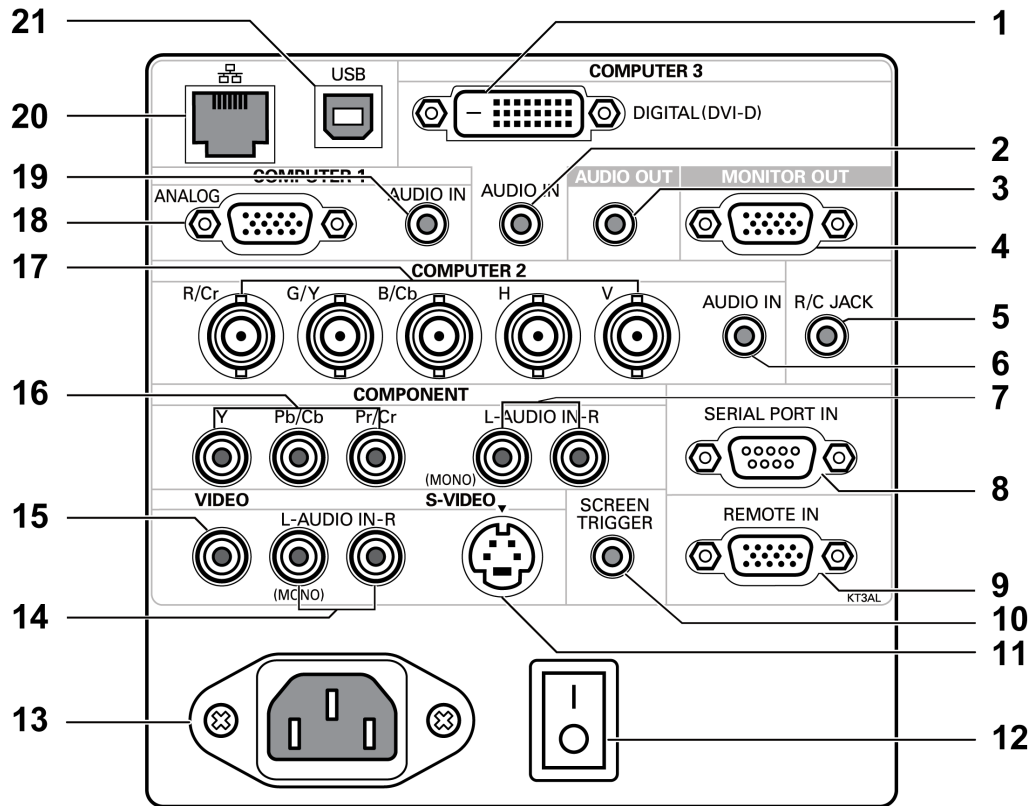

ITEM	LABEL	DESCRIPTION	SEE PAGE:
1.	COMPUTER 3 IN	Connect the DVI-D cable (not supplied) from a computer	26
2.	AUDIO IN (COMPUTER 3)	Connect the audio cable (not supplied) from the input device	—
3.	AUDIO OUT	Audio loop-thru	—
4.	MONITOR OUT	Connect to a monitor	—
5.	R/C JACK	Connect the remote to the projector	15
6.	AUDIO IN (COMPUTER 2)	Connect the audio cable (not supplied) from the input device	—
7.	AUDIO IN [L(MONO)/R] (COMPONENT)	Connect an RCA audio cables (not supplied) from the input device right and left channels	—
8.	SERIAL PORT IN	Installation control	115
9.	REMOTE IN	For external control	123

1. Introduction

ITEM	LABEL	DESCRIPTION	SEE PAGE:
10.	SCREEN TRIGGER	When connected to the screen through a commercially available cable, the screen deploys automatically on start up of the projector. The screen retracts when the projector is powered off (see notes below)	117
11.	S-VIDEO	Connect a commercially available S-video cable from a video device	30
12.	POWER SWITCH	Turn on/off the projector	32,41
13.	AC IN	Connect the supplied power cable	31
14.	AUDIO IN [L(MONO)/R] (VIDEO)	Connect RCA audio cables (not supplied) from the input device right and left channels. This audio jack is shared with S-Video input.	—
15.	VIDEO IN	Connect a composite video cable (not supplied) from a video device to the yellow RCA jack	30
16.	COMPONENT IN (Y, Cb/Pb, Cr/Pr)	Connect a component video enabled device	29
17.	COMPUTER 2 IN (R/Cr, G/Y, B/Cb, H, V)	Connect RGBHV or Component signal from computer or component video enabled device	26
18.	COMPUTER 1 IN	Connect a VGA cable (supplied) from a computer	26
19.	AUDIO IN (COMPUTER 1)	Connect the audio cable (not supplied) from the input device	—
20.	LAN	Connect a LAN cable (not supplied) from a computer	
21.	SERVICE	Connect the USB cable (not supplied) from a computer. For service personnel only.	—

Note:

- To use this feature, you must turn on the Screen Trigger function on the OSD.
- Screen controllers are supplied and supported by screen manufacturers.
- Do not use this jack for anything other than intended use. Connecting the wired remote control to the Trigger mini jack causes damage to the remote control.

⑥ Part Names of the Remote Control

ITEM	LABEL
1.	ON
2.	STAND-BY
3.	LIGHT Illuminate the remote panel.
4.	MENU Open or close the on-Screen menu.
5.	CANCEL
6.	VOLUME -
7.	SELECT Executes a selected menu item
8.	VOLUME +
9.	LENS SHIFT Shift the lens up, down, right and left.
10.	FOCUS/ZOOM Correct image distortion.
11.	IMAGE Select image mode
12.	SCREEN Select the screen size.
13.	FREEZE Freeze the picture.
14.	LAMP CONTROL Select a lamp mode.

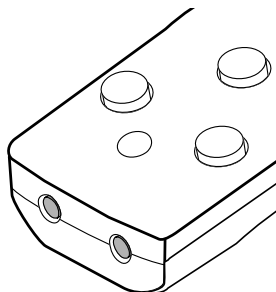

LABEL	ITEM
NO SHOW Temporarily turns off screen image.	15.
D. ZOOM -/+ Zoom in/out function.	16.
AUTO PC Automatically adjust the computer image.	17.
KEystone Correct keystone distortion.	18.
VOLUME -/+	19.
COMPUTER 1	20.
COMPUTER 2	21.
COMPUTER 3	22.
COMPONENT Select the component input source.	23.
S-VIDEO Select the S-video input source.	24.
VIDEO Select the video input source.	25.
IR TRANSMITTER	26.
IR TRANSMITTER	27.
REMOTE JACK Connect a wired remote control.	28.

1. Introduction

Important:

Avoid using the projector with bright fluorescent lighting turned on. Certain high-frequency fluorescent lights can disrupt remote control operation.

1. Be sure nothing obstructs the path between the remote control and the projector. If the path between remote and projector is obstructed, you can bounce the remote signal off certain reflective surfaces such as projector screens.

2. The buttons and keys on the projector have the same functions as the corresponding buttons on the remote control. This user's manual describes the functions based on the remote control.

Note:

* To turn off the projector, press the STAND-BY button twice.

Battery Installation

The Remote Control unit included with the projector does not contain batteries, though batteries are supplied as part of the complete package. To insert (or replace) the batteries, refer to the following guide.

1. Remove the battery compartment cover by squeezing the locking catch and sliding the cover in the direction of the arrow.

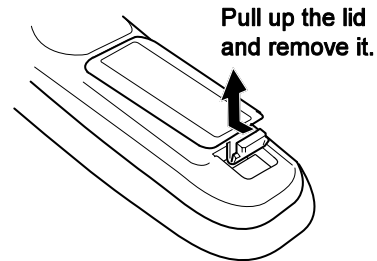

2. Insert the supplied batteries taking note of the polarity (+/-) as shown.

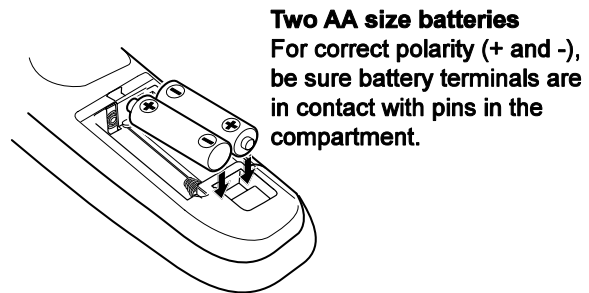

3. Replace the cover locator, and then click locking catch into place as shown.

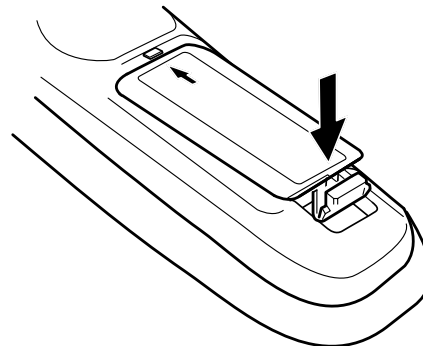

1. Introduction

Operating Range for Wireless Remote Control

Point the remote control toward the projector (to Infrared Remote Receivers) when pressing the buttons. Maximum operating range for the remote control is about 16.4 feet (5 m) and 60 degrees in front and rear of the projector.

Infrared remote receivers are provided both in front and back of the projector. You can conveniently use both of the receivers.

Remote Control Precautions

The following precautions ensure that the remote operates correctly and safely.

- Use two (2) AA or LR6 type alkaline batteries.
- Always replace batteries in sets.
- Do not use a new battery with a used one.
- Avoid contact with water or liquid.
- Do not expose the remote control to moisture or heat.
- Do not drop the remote control.
- If the battery has leaked on the remote control, carefully wipe the case clean and install new batteries.
- Risk of an explosion if battery is replaced by an incorrect type.
- Dispose of used batteries according to the instructions.

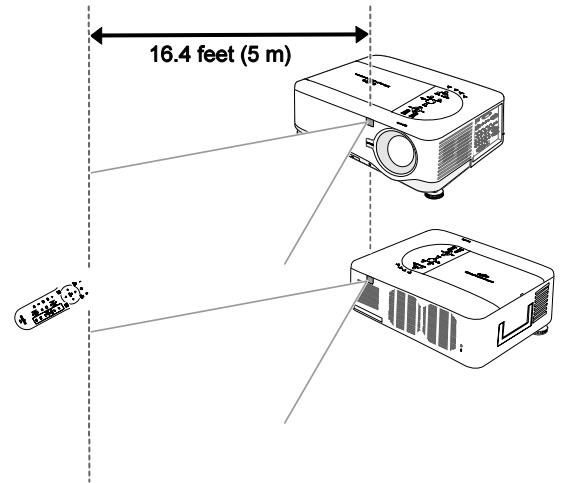

Using the Remote Control in Wired Operation

Connect the supplied remote cable to the R/C jack on the projector (see 5 Terminal Panel Features on page 9) and the other end to the remote jack on the remote control (see item 1, 6 Part Names of the Remote Control on page 11).

Note:

Connecting the remote cable to the R/C jack on the terminal panel will make the wireless operation unavailable.

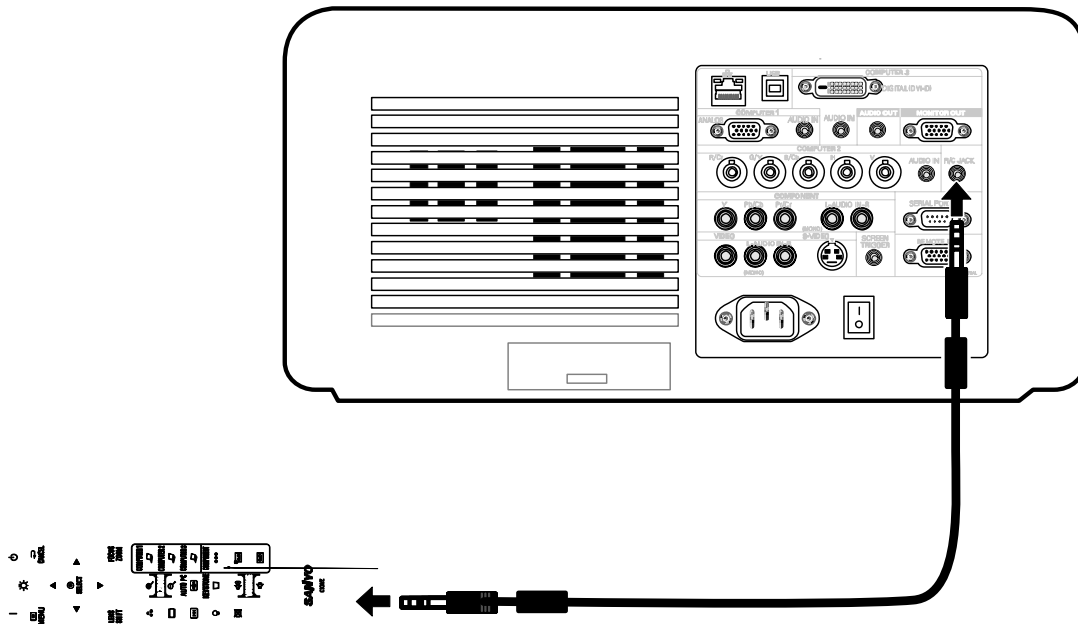

1. Introduction

Carrying the Projector

Always carry your projector by the handle.

Before moving or carrying the projector, disconnect the power cable and any other cables that may be attached to it.

When moving the projector or when the projector is not in use, cover the lens with the lens cap.

To extend the projector handle, refer to the following guide.

1. Stand the projector on its end with the control panels at the bottom.
2. Lift the handle in the direction shown until it is fully extended.

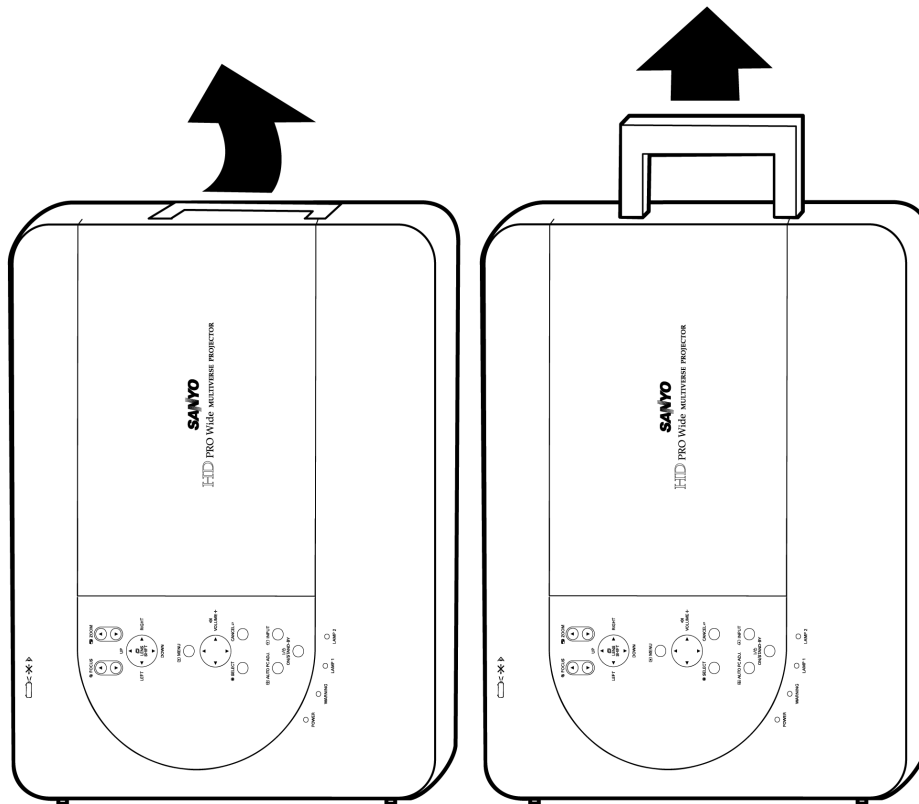

Note:

Stand the projector on its end by lifting the cabinet. Do not use the handle to place the projector upright.

2. Installation and Connections

① Setting Up the Screen and the Projector

This section briefly describes how to set up your projector and how to connect video and audio sources.

Your projector is simple to set up and use. But before you get started, you must first:

- Set up a screen and the projector.
- Connect your computer or video equipment to the projector. See ⑥ Making Connections on page 26.
- Connect the supplied power cable. See ⑦ Connecting the Supplied Power Cable on page 31.

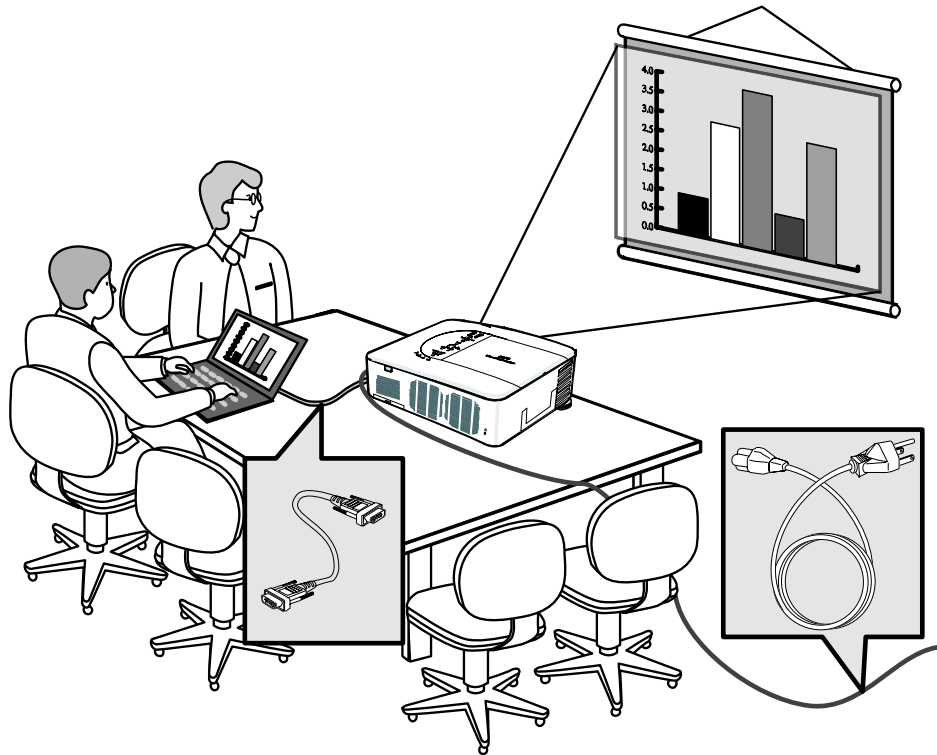

Note:

Ensure that the power cable and any other cables are disconnected before moving the projector. When moving the projector or when it is not in use, cover the lens with the lens cap.

2. Installation and Connections

② Selecting a Location

Locating the projector correctly ensures optimum performance and a longer parts life.

Take note of the following when setting up the projector:

- The projector table or stand should be level and sturdy.
- Position the projector so that it is perpendicular to the screen.
- Ensure cables do not cause a trip hazard.

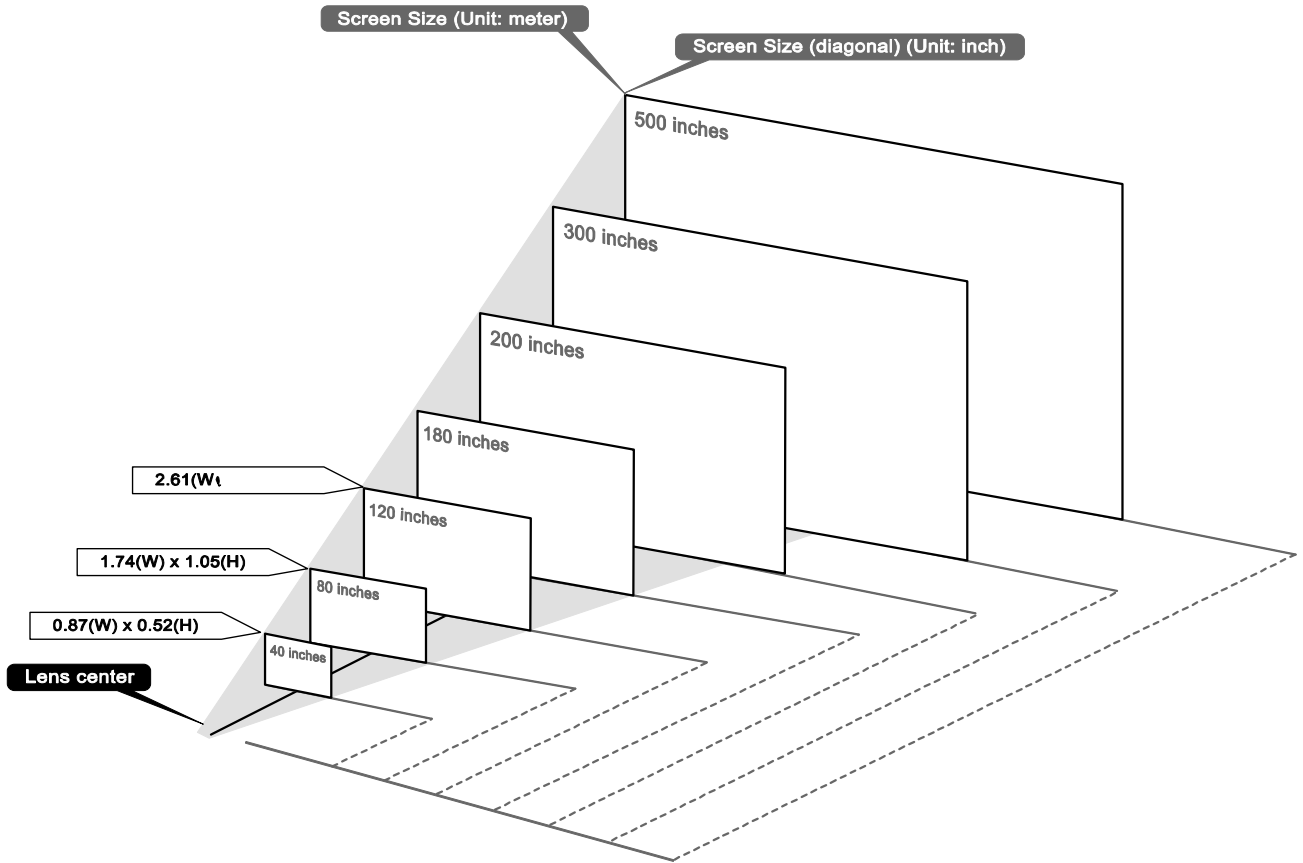

③ Installing or Removing the Optional Lens

CAUTION



- Do not shake or place excessive pressure on the projector or the lens components as the projector and lens components contain precision parts.
- When shipping the projector with the optional lens, remove the optional lens before shipping the projector. The lens and the lens shift mechanism may encounter damage caused by improper handling during transportation.
- Before removing or installing the lens, be sure to turn off the projector, wait until the cooling fans stop, and turn off the main power switch.
- Do not touch the lens surface when removing or installing the lens.
- Keep fingerprints, dust or oil off the lens surface. Do not scratch the lens surface.
- Work on a level surface with a soft cloth under it to avoid scratching.
- If you remove and store the lens, attach the lens cap to the projector to keep off dust and dirt.

Removing the Existing Lens From the Projector

1. Pull out the lens cap.

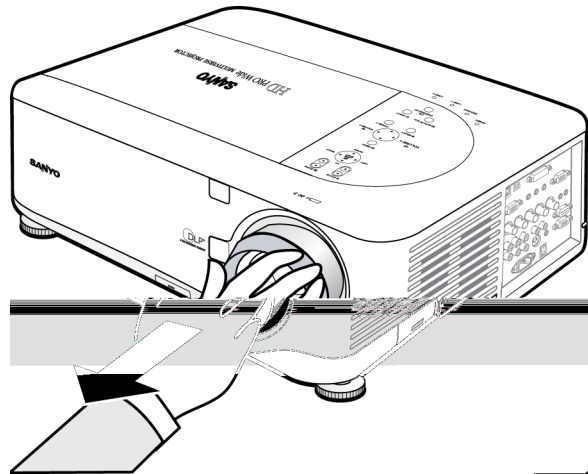

2. Push the LENS RELEASE button all the way in and rotate the lens counterclockwise. The existing lens will be disengaged.

Note:

If the lens cannot be removed even by using the LENS RELEASE button, the anti-theft screw for lens may be in use to secure the lens. If that is the case, remove the anti-theft screw first.

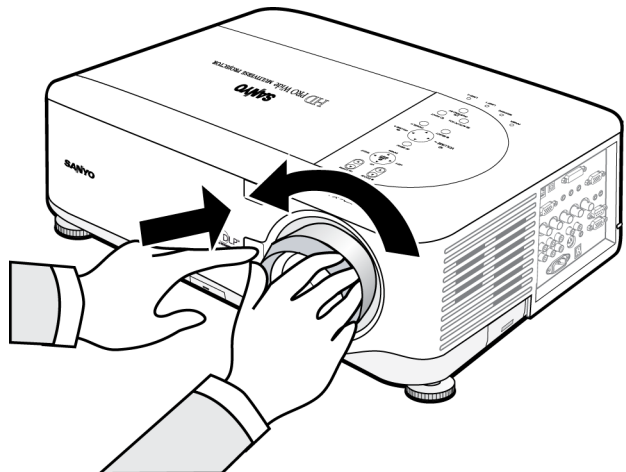

2. Installation and Connections

3. Pull out the existing lens slowly.

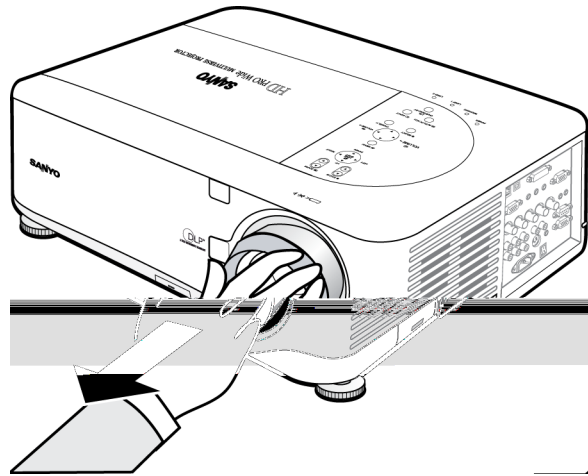

CAUTION



When installing the lens into the projector, be sure to remove the lens cap from the back of the optional lens before installing the optional lens into the projector. Failure to do so will cause damage to the projector.

Installing the New Lens

1. Insert the lens label side up.

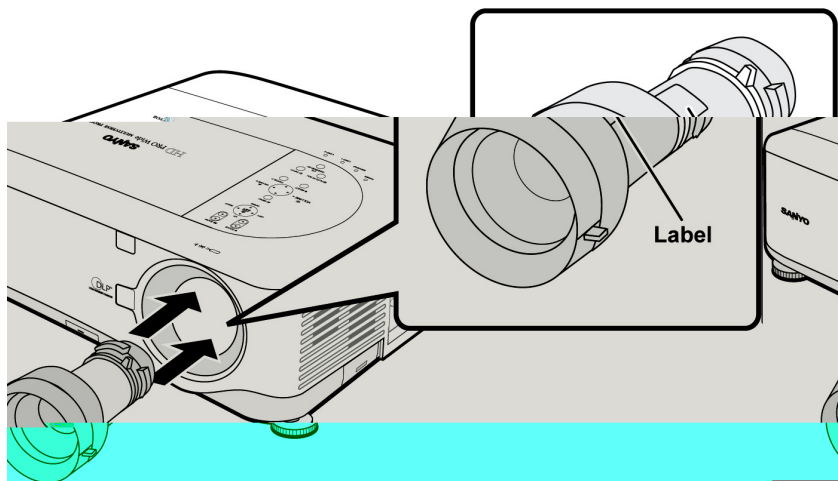

2. Rotate the lens clockwise until it clicks into place.

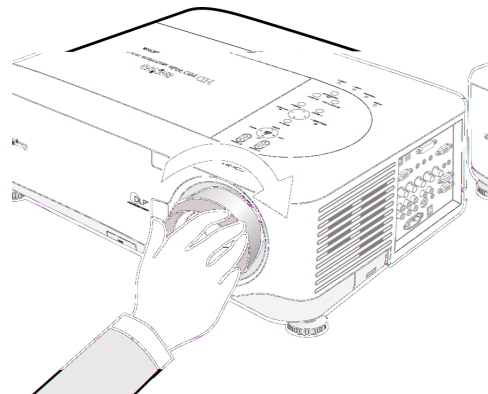

Installing the New Lens Using the anti-theft screw

Using the anti-theft screw to prevent theft of the lens.
Tighten the supplied anti-theft screw on the front bottom.

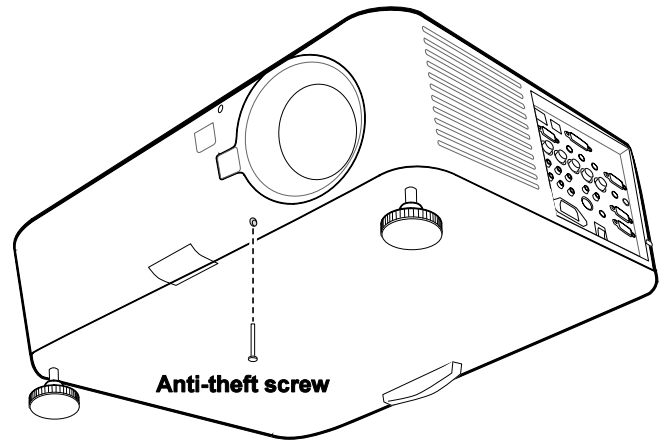

2. Installation and Connections

④ Throw Distance and Screen Size

Example of LNS-S40:

The further your projector is from the screen or wall, the larger the image. The minimum size the image can be is approximately 40 inches (1 m) measured diagonally when the projector is roughly 71 inches (1.8 m) from the wall or screen. The largest the image can be is 500 inches (12.7 m) when the projector is about 915 inches (23.2 m) from the wall or screen.

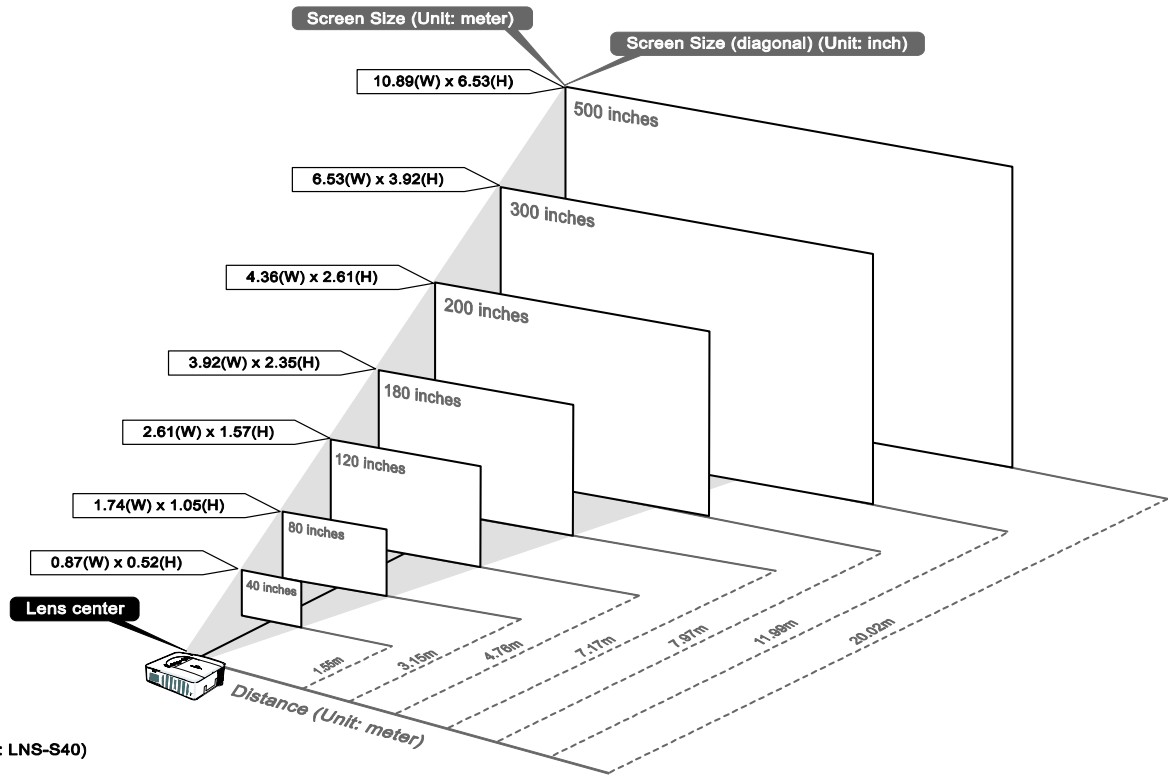

(Reference: LNS-S40)

Screen Size						LNS-W41		LNS-W40		LNS-S40	
Diagonal		Width		Height		0.77		1.33 - 1.79		1.78 - 2.35	
						Distance					
[inches]	[m]	[inches]	[m]	[inches]	[m]	[inches]	[m]	[inches]	[m]	[inches]	[m]
40	1.02	34.3	0.87	20.5	0.52			45.4 - 61.8	1.15 - 1.57	60.9 - 81.0	1.55 - 2.06
50	1.27	42.9	1.09	25.6	0.65	33.5	0.85	57.2 - 77.7	1.45 - 1.97	76.7 - 101.9	1.95 - 2.59
60	1.52	51.6	1.31	30.7	0.78	40.5	1.03	69.0 - 93.6	1.75 - 2.38	92.5 - 122.8	2.35 - 3.12
67	1.70	57.6	1.47	34.3	0.87	45.4	1.15	77.3 - 104.7	1.96 - 2.66	103.6 - 137.4	2.63 - 3.49
72	1.83	61.9	1.58	36.8	0.94	48.9	1.24	83.2 - 112.7	2.11 - 2.86	111.5 - 147.9	2.83 - 3.76
80	2.03	68.5	1.74	41.3	1.05	54.5	1.38	92.7 - 125.4	2.35 - 3.19	124.2 - 164.6	3.15 - 4.18
84	2.13	71.9	1.83	43.4	1.10	57.3	1.46	97.4 - 131.8	2.47 - 3.35	130.5 - 172.9	3.31 - 4.39
90	2.29	77.1	1.96	46.5	1.18	61.5	1.56	104.5 - 141.3	2.65 - 3.59	140.0 - 185.4	3.56 - 4.71
100	2.54	85.8	2.18	51.6	1.31	68.5	1.74	116.3 - 157.2	2.95 - 3.99	155.8 - 206.3	3.96 - 5.24
120	3.05	102.8	2.61	61.8	1.57	82.5	2.10	140.0 - 189.0	3.56 - 4.80	187.4 - 248.1	4.76 - 6.30
150	3.81	128.7	3.27	77.2	1.96	103.5	2.63	175.5 - 236.7	4.46 - 6.01	234.9 - 310.7	5.97 - 7.89
180	4.57	154.3	3.92	92.5	2.35	124.5	3.16	211.0 - 284.4	5.36 - 7.22	282.3 - 373.3	7.17 - 9.48
200	5.08	171.7	4.36	102.8	2.61	138.5	3.52	234.6 - 316.2	5.96 - 8.03	313.9 - 415.1	7.97 - 10.54
210	5.33	180.3	4.57	107.9	2.74			246.4 - 332.1	6.26 - 8.44	329.7 - 436.0	8.38 - 11.07
240	6.10	206.0	5.24	123.4	3.13			281.9 - 379.8	7.16 - 9.65	377.2 - 498.6	9.58 - 12.66
261	6.63	224.1	5.69	134.2	3.41			306.8 - 413.2	7.79 - 10.50	410.4 - 542.4	10.42 - 13.78
270	6.86	231.8	5.89	138.8	3.52			317.4 - 427.5	8.06 - 10.86	424.6 - 561.2	10.79 - 14.25
300	7.62	257.1	6.53	154.3	3.92			352.9 - 475.2	8.96 - 12.07	472.1 - 623.8	11.99 - 15.85
350	8.89	300.0	7.62	180.0	4.57			412.0 - 554.8	10.47 - 14.09	551.2 - 728.2	14.00 - 18.50
400	10.16	342.9	8.71	205.9	5.23			471.2 - 634.3	11.97 - 16.11	630.2 - 832.6	16.01 - 21.15
450	11.43	385.8	9.80	231.6	5.88			530.3 - 713.8	13.47 - 18.13	709.3 - 937.0	18.02 - 23.80
500	12.70	428.7	10.89	257.1	6.53			589.5 - 793.3	14.97 - 20.15	788.4 - 1041.4	20.02 - 26.45

Screen Size						LNS-T40		LNS-T41	
Diagonal		Width		Height		2.22 - 4.43		4.43 - 8.3	
Distance									
[inches]	[m]	[inches]	[m]	[inches]	[m]	[inches]	[m]	[inches]	[m]
40	1.02	34.3	0.87	20.5	0.52	75.7 - 155.0	1.92 - 3.94	151.7 - 289.8	3.85 - 7.36
50	1.27	42.9	1.09	25.6	0.65	95.7 - 194.7	2.43 - 4.95	190.9 - 363.5	4.85 - 9.23
60	1.52	51.6	1.31	30.7	0.78	115.6 - 234.5	2.94 - 5.96	230.2 - 437.3	5.85 - 11.11
67	1.70	57.6	1.47	34.3	0.87	129.6 - 262.4	3.29 - 6.66	257.7 - 488.9	6.55 - 12.42
72	1.83	61.9	1.58	36.8	0.94	139.6 - 282.3	3.55 - 7.17	277.3 - 525.8	7.04 - 13.36
80	2.03	68.5	1.74	41.3	1.05	155.6 - 314.1	3.95 - 7.98	308.8 - 584.9	7.84 - 14.86
84	2.13	71.9	1.83	43.4	1.10	163.6 - 330.0	4.15 - 8.38	324.5 - 614.4	8.24 - 15.60
90	2.29	77.1	1.96	46.5	1.18	175.5 - 353.9	4.46 - 8.99	348.0 - 658.6	8.84 - 16.73
100	2.54	85.8	2.18	51.6	1.31	195.5 - 393.6	4.97 - 10.00	387.3 - 732.4	9.84 - 18.60
120	3.05	102.8	2.61	61.8	1.57	235.4 - 473.2	5.98 - 12.02	465.9 - 880.0	11.83 - 22.35
150	3.81	128.7	3.27	77.2	1.96	295.3 - 592.6	7.50 - 15.05	583.7 - 1101.3	14.83 - 27.97
180	4.57	154.3	3.92	92.5	2.35	355.2 - 711.9	9.02 - 18.08	701.5 - 1322.6	17.82 - 33.59
200	5.08	171.7	4.36	102.8	2.61	395.2 - 791.5	10.04 - 20.10	780.0 - 1470.2	19.81 - 37.34
210	5.33	180.3	4.57	107.9	2.74	415.1 - 831.3	10.54 - 21.11	819.3 - 1543.9	20.81 - 39.22
240	6.10	206.0	5.24	123.4	3.13	475.0 - 950.6	12.07 - 24.15	937.1 - 1765.3	23.80 - 44.84
261	6.63	224.1	5.69	134.2	3.41	517.0 - 1034.1	13.13 - 26.27	1019.6 - 1920.2	25.90 - 48.77
270	6.86	231.8	5.89	138.8	3.52	534.9 - 1069.9	13.59 - 27.18	1054.9 - 1986.6	26.80 - 50.46
300	7.62	257.1	6.53	154.3	3.92	594.8 - 1189.3	15.11 - 30.21	1172.8 - 2207.9	29.79 - 56.08
350	8.89	300.0	7.62	180.0	4.57	694.7 - 1388.2	17.64 - 35.26	1369.1 - 2576.8	34.78 - 65.45
400	10.16	342.9	8.71	205.9	5.23	794.5 - 1587.1	20.18 - 40.31	1565.5 - 2945.7	39.76 - 74.82
450	11.43	385.8	9.80	231.6	5.88	894.3 - 1786.0	22.72 - 45.37	1761.9 - 3314.6	44.75 - 84.19
500	12.70	428.7	10.89	257.1	6.53	994.1 - 1984.9	25.25 - 50.42	1958.2 - 3683.4	49.74 - 93.56

Ceiling installation must be done by a qualified professional. Contact your SANYO dealer for more information.

It is not recommended you install the projector yourself.

Only use the projector on a solid, level surface. Serious injury and damage can occur if the projector is dropped.

CAUTION



Do not use the projector in an environment where extreme temperature occurs. The projector must be used at temperatures between 41 degrees Fahrenheit (5 degrees Celsius) and 104 degrees Fahrenheit (40 degrees Celsius).

Screen damage will occur if the projector is exposed to moisture, dust or smoke.

Do not cover the vents on the projector. Proper ventilation is required to dissipate heat. Damage to the projector will occur if the vents are covered.

2. Installation and Connections

7. Align the lamp cover (A) with the arrow mark on the cabinet and slide it into place.



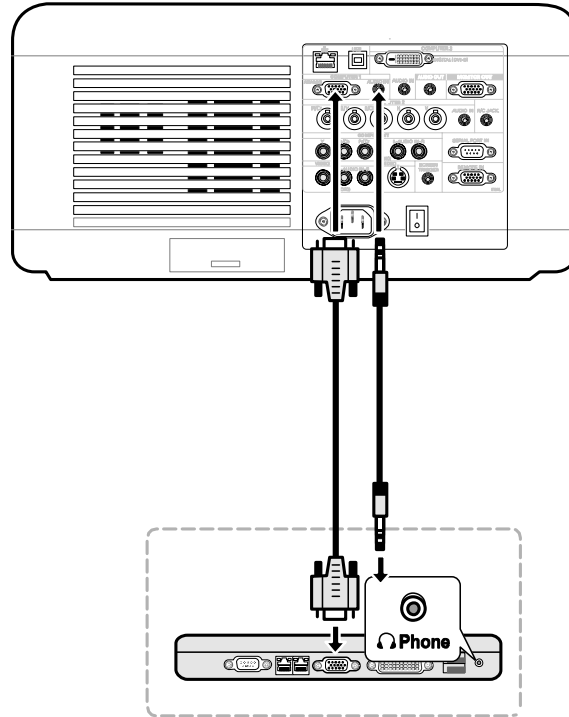

2. Turn on the projector and select the chosen method of connection from the source menu before turning on the PC (see [Selecting an Input Source](#) on page 34).
3. Turn on the PC.

Note:

Failure to follow the above steps may not activate the digital output of the graphics card resulting in no picture being displayed. Should this happen, restart your PC.

2. Installation and Connections

Connecting an External Monitor

Connect an external monitor to the projector through RGB out connections as shown below (see item 4, **Terminal Panel Features** on page 9)

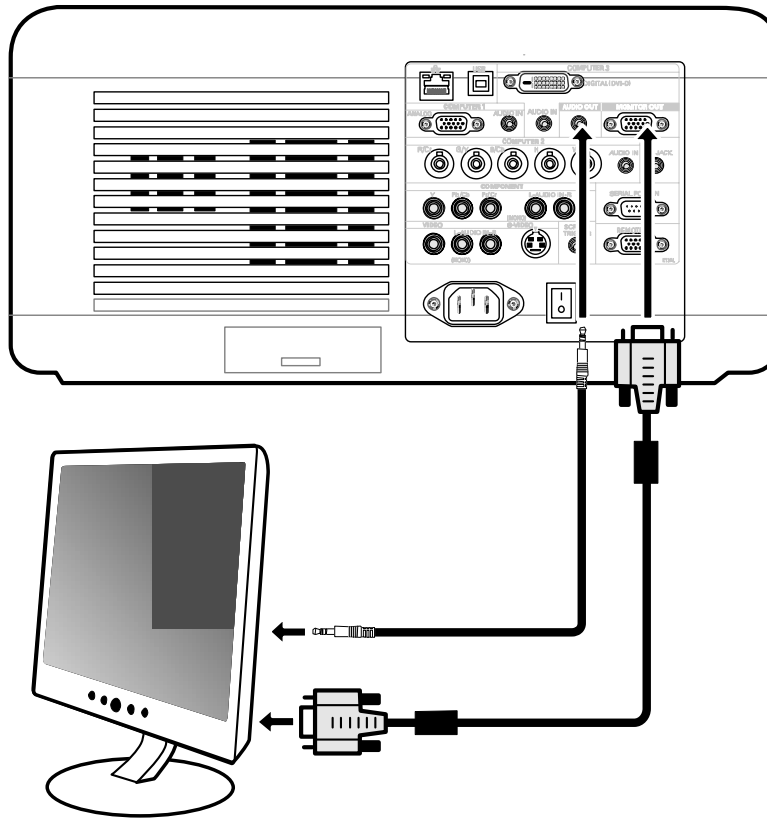

Connecting Your DVD Player with Component Output

To connect a DVD Player to the projector, refer to the following guide.

1. Connect the DVD Player to the projector as shown below before turning on the Player or the projector.

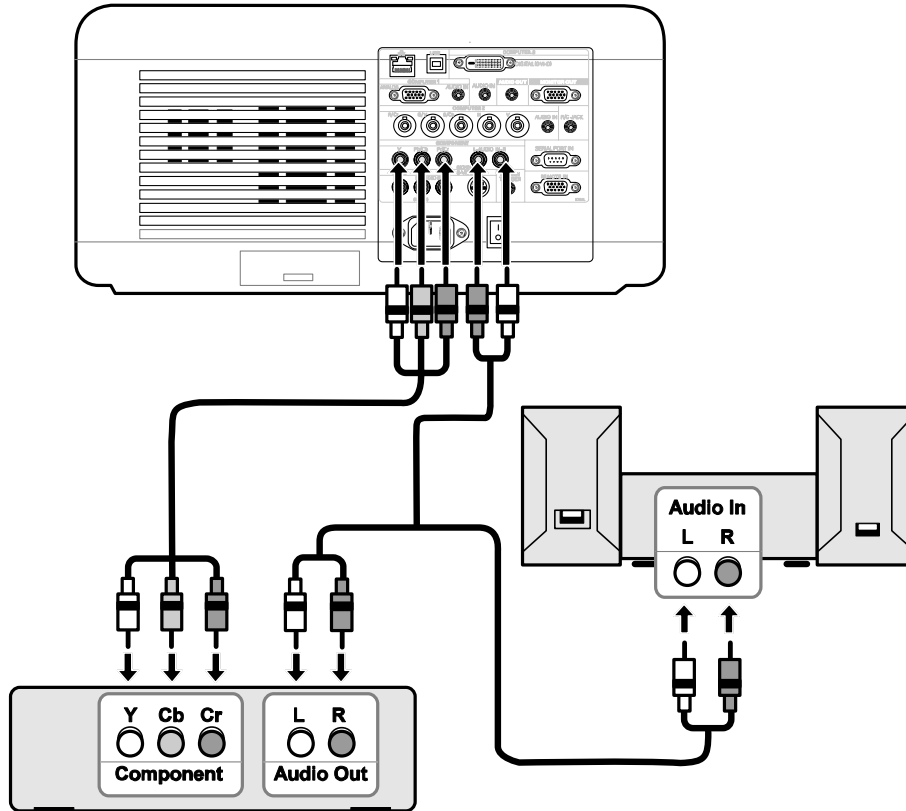

2. Turn on the projector and select **Component** from the source menu before turning on the DVD Player (see [Selecting an Input Source](#) on page 34).
3. Turn on the DVD Player.

Note:

Refer to your DVD player's user's manual for more information about your DVD player's video output requirements.

7 Connecting the Supplied Power Cable

This projector uses nominal input voltages of 100–120V or 200–240V AC and it automatically selects the correct input voltage. It is designed to work with single-phase power systems having a grounded neutral conductor. To reduce the risk of electrical shock, do not plug into any other type of power system. If you are not sure of the type of power being supplied, consult your authorized dealer or service station. Connect the projector with all peripheral equipment before turning the projector on.

CAUTION



For safety, unplug the AC power cord when the projector is not in use. When the projector is connected to an outlet with the AC power cord, it is in stand-by mode and consumes a small amount of electrical power.

NOTE ON THE POWER CORD

The AC power cord must meet the requirements of the country where you are utilizing the projector. Confirm the AC plug type with the chart below. The proper AC power cord must be used. If the supplied AC power cord does not match your AC outlet, contact your sales dealer.

Projector side	AC outlet side		
<p>To power cord connector on your projector.</p>	<p>For the U.S.A. and Canada</p> <p>Ground</p> <p>To the AC outlet. (120 V AC)</p>	<p>For Continental Europe</p> <p>To the AC outlet. (200–240 V AC)</p>	<p>For the U.K.</p> <p>To the AC outlet. (200–240 V AC)</p>

Note:

Make sure that the prongs are fully inserted into both the AC IN and the wall outlet.

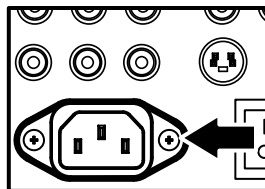

CAUTION



Ensure that the cables do not create a trip hazard.

3. Projecting an Image (Basic Operation)

1 Turning on the Projector

Once the projector is correctly located and the power cable and other connections are in place, it is important that the projector is powered on correctly in order to avoid damage to components and unnecessary wear and tear. Refer to the following guide to power on the projector.

1. Connect the power cable (A). Press the main power switch to the on (I) position as shown (B). The power LED lights orange and warning LED lights green.

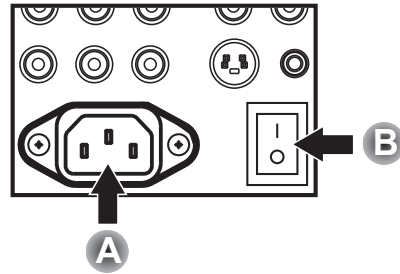

2. Press the **On/Standby** button once (see OSD Controls and Status LEDs on page 7). The power LED lights green and the internal cooling fan starts.
3. After approximately 10 seconds, the power LED flashes intermittently green.

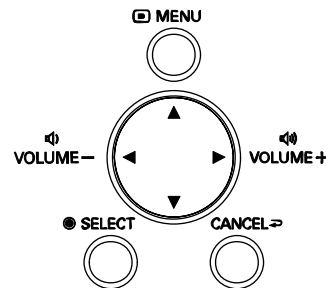

4. The Lamp1 and Lamp2 LEDs light green and the Power LED flashes more rapidly.
5. Once the power LED is lit a solid green, the projector is ready for use.

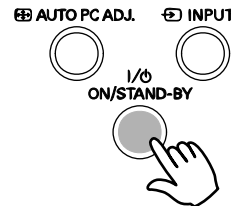

Note:

If any of the LEDs remain flashing or blink there may be a problem with the startup. Please refer to the **1 Troubleshooting** section on page 102.

Note on Startup Screen (Menu Language Select screen)

In the first instance of powering on the projector, the language menu is displayed to select the default language.

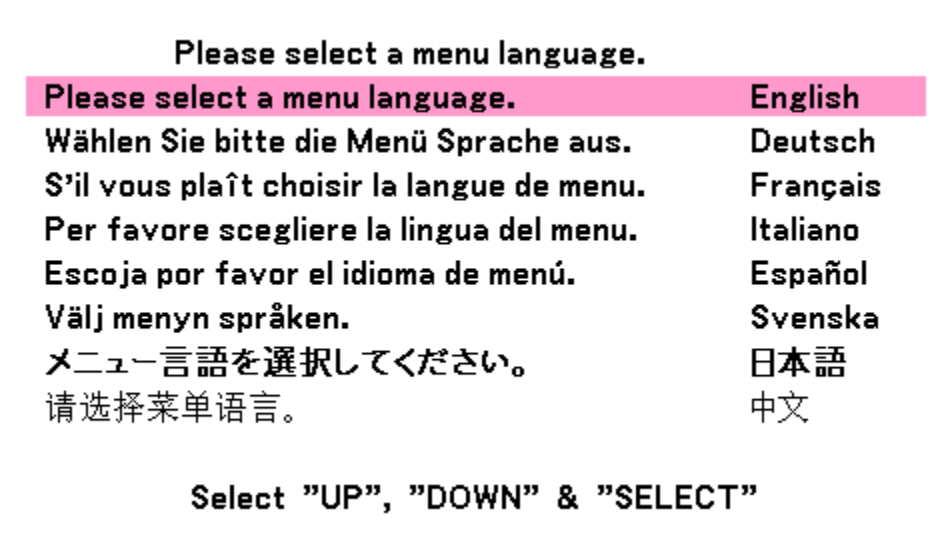

Select the required default language using the ▲ or ▼ buttons on the OSD menu panel or the remote control unit and press **Select**.

Note:

The language select screen only appears on the first instance of power on. All subsequent operations assume the selected default language. To change the default see page 74.

3. Projecting an Image (Basic Operation)

② Selecting an Input Source

The Input Source can be selected from the projector's control panel or from the remote control unit. Refer to the following guide to select the Input Source.

1. Press **Menu** on the OSD control panel or on the remote control unit to display the **Main Menu**. Scroll to the **Input** menu using **▲** or **▼** and press **Select**.

Note:

Return to the projected image by pressing **Cancel** twice.

2. Select the required source using **▲** or **▼** and press **Select**.

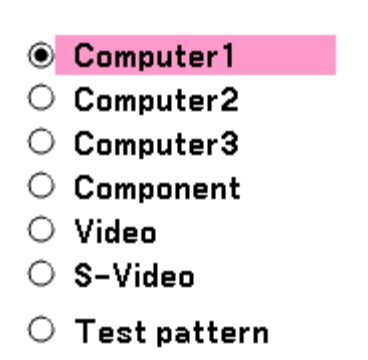
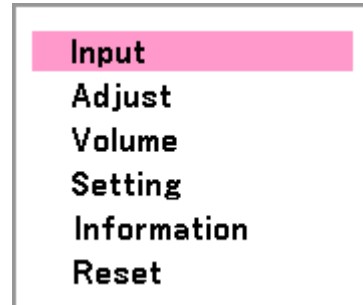

Note:

If an XGA signal is not correctly recognized, set "WXGA Mode" to off (see page 63).

To check if the signal is recognized, go to "Input" under "Information" menu (see page 90).

③ Adjusting the Picture Position and Picture Size

The Picture Position and Picture Size can be adjusted manually from the lens control panel or from the remote control unit. Refer to the following guides to adjust Picture Position manually.

Adjusting Picture Position Manually

1. Press the Select keypad in any direction to bring up the Lens Shift window.

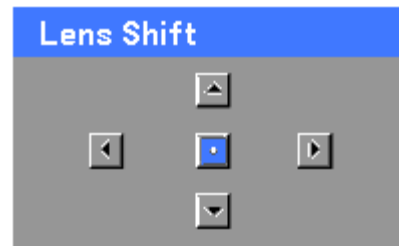

2. Press the directional key as required to shift the image. Releasing the directional arrow will re-center the cursor.

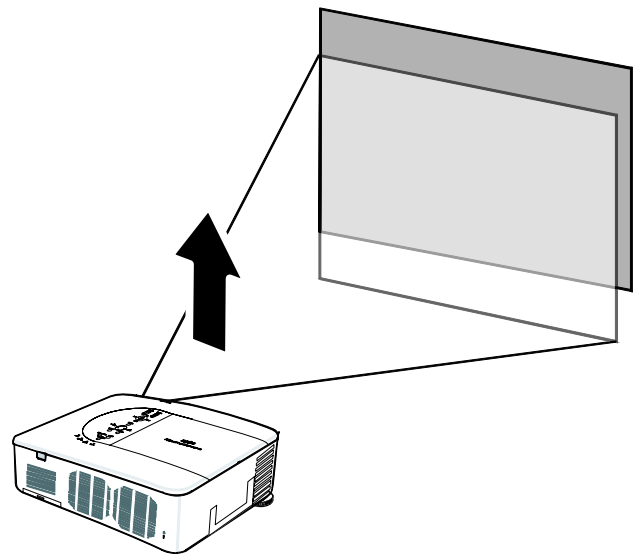

3. To alter the picture size, press **Menu** and select the **Adjust** menu using **▲** or **▼**. Press **Select** to open the **Adjust** menu. Press **◀** or **▶** to select **Image Options** followed by **▲** or **▼** to select **Screen**. Press **Select**.

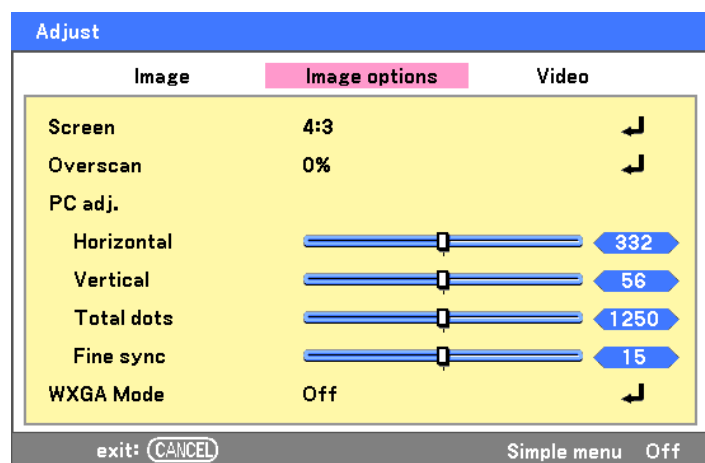

3. Projecting an Image (Basic Operation)

4. The **Screen** window is displayed. Select the desired picture size using ▲ or ▼ and press **Select**.

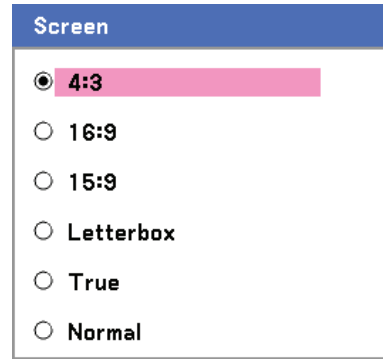

5. When finished, press **Cancel** to return to the projected image.

Lens Shift Adjustable Range

The adjustable range for lens shift is tabulated below and subject to the conditions listed.

Note:

The drawings below apply to the standard lens (LNS-S40) only.

Desktop front projection

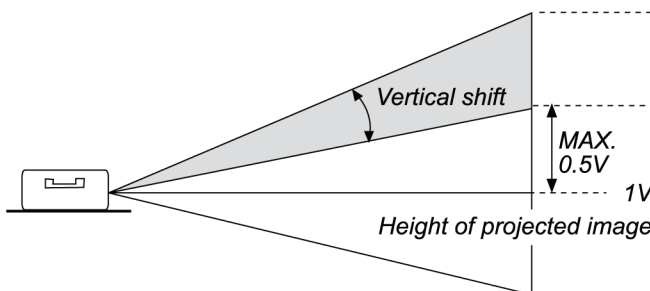

Normal projection position

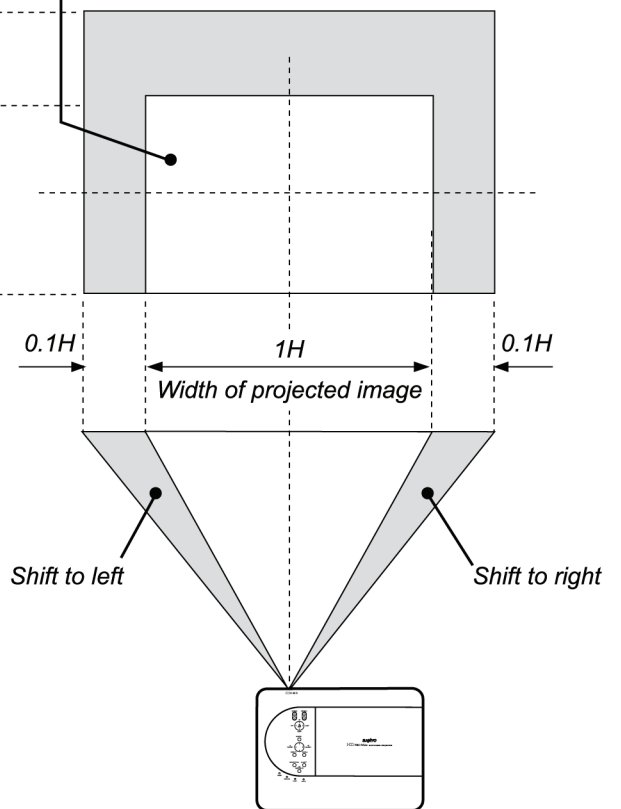

Ceiling front projection

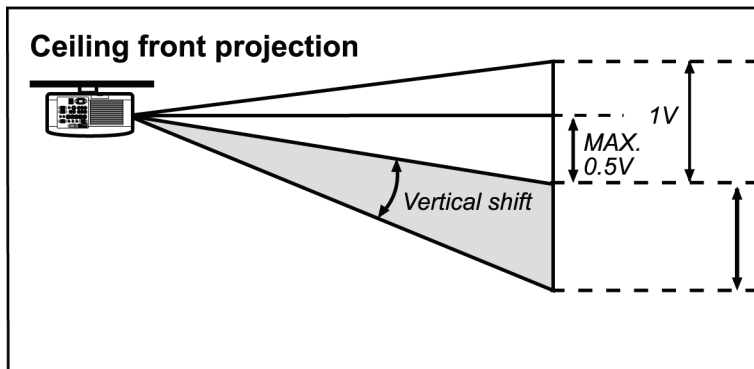

From the Remote Control Unit

1. Press the **Lens Shift** button to bring up the Lens Shift window.

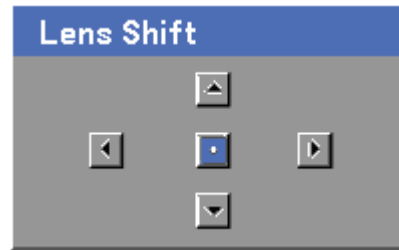

2. Press the directional keys as required to shift the image. Releasing the directional arrow will re-center the cursor.

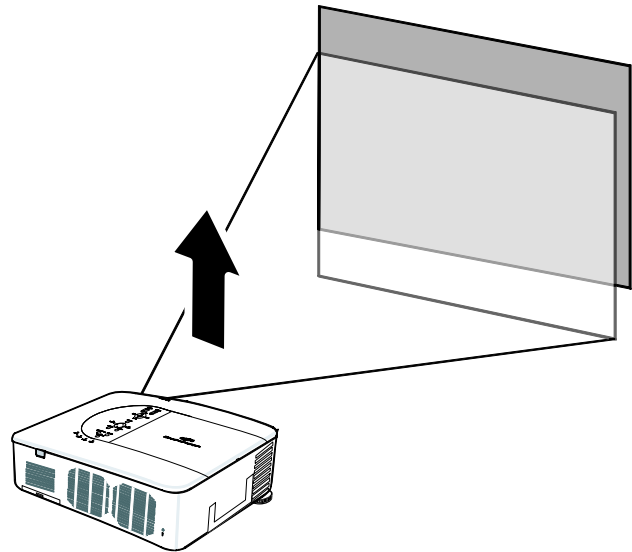

3. To alter the picture size, press the **Screen** button to display the **Screen** window.

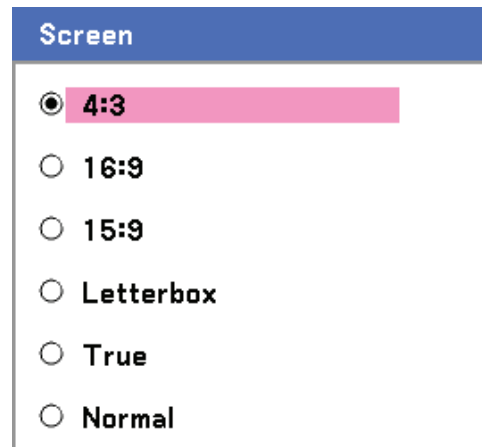

4. Select the desired picture size using ▲ or ▼ and press **Select**.
5. When finished, press **Cancel** to return to the projected image.

3. Projecting an Image (Basic Operation)

Adjusting the Projector Level

1. To raise the level of the projector, twist the adjusters clockwise.

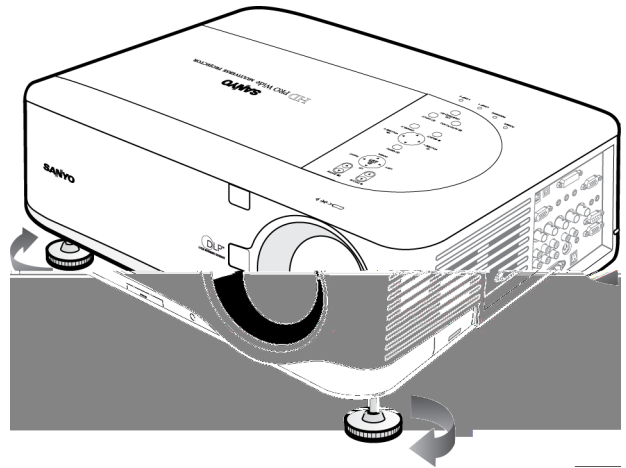

2. To lower the level of the projector, lift the projector and twist the adjusters counter clockwise.

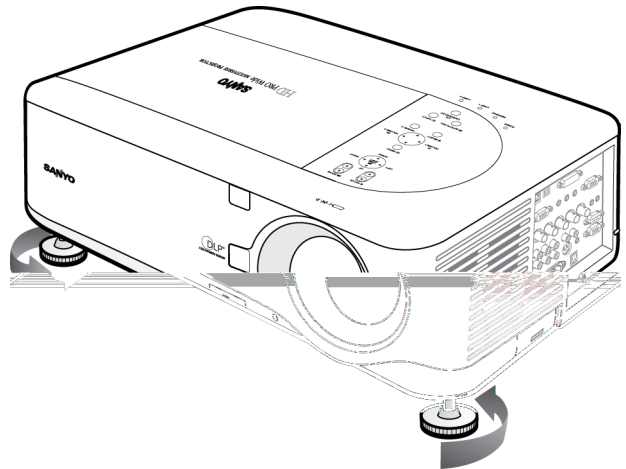

④ Optimizing an RGB Image Automatically

Adjusting the Image Using AUTO PC ADJ.

To optimize an RGB image automatically refer to the following guide.

Press the AUTO PC button on the remote control (see item 17, ⑥ Part Names of the Remote Control on page 11) or the AUTO PC ADJ. button on the OSD control panel to optimize an RGB image automatically.

This adjustment may be necessary when you connect your computer for the first time.

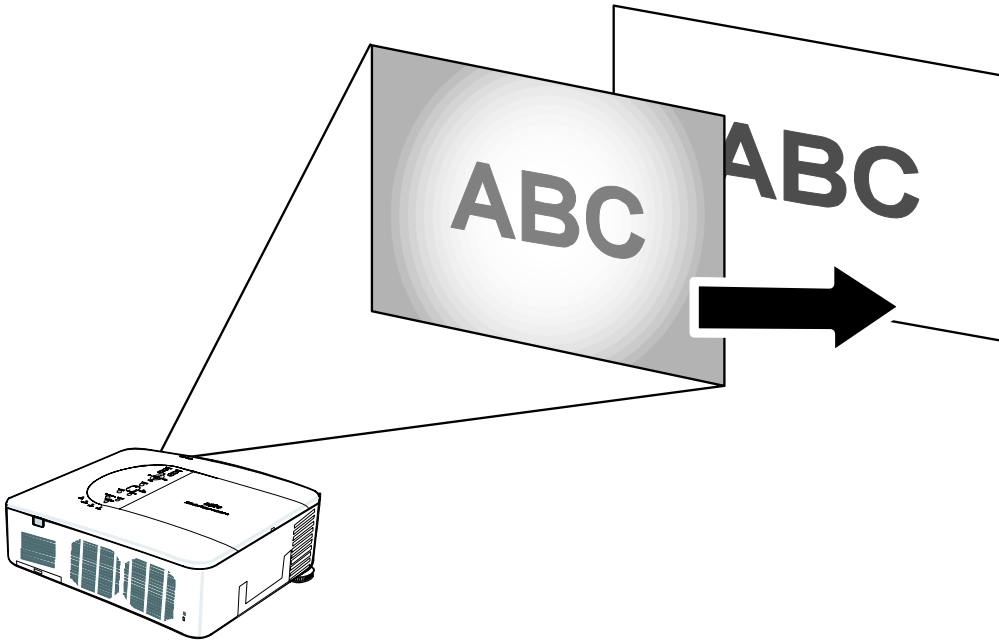

3. Projecting an Image (Basic Operation)

5 Adjusting Volume Up and Down

The volume can be adjusted from the OSD Control Panel or with the Remote Control unit. Refer to the following as a guide.

1. Press the **Volume +/-** buttons on the remote control or the ◀ ▶ buttons on the OSD control panel. The volume level is displayed on screen.
2. Use the **Volume +/-** buttons or the ◀ ▶ buttons on the OSD control panel to adjust the level.

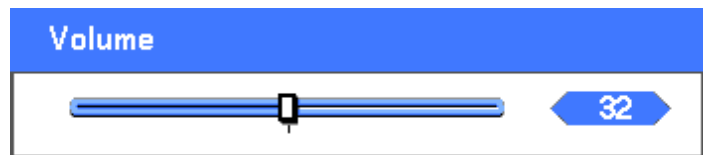
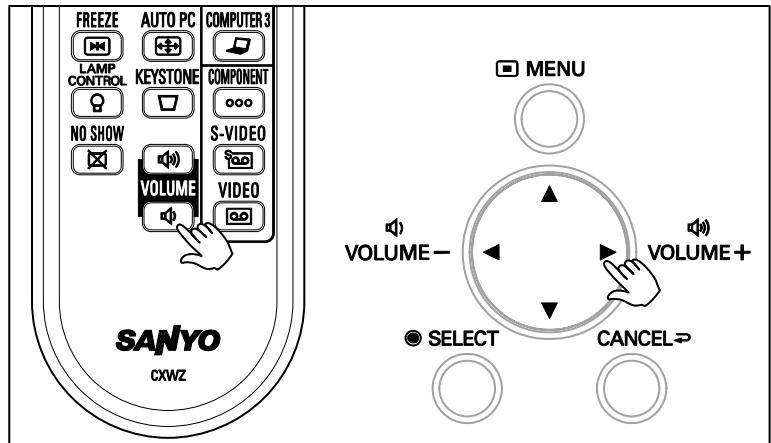

6 Turning off the Projector

Once the projector is no longer required, it is important to shut it down correctly to avoid damage or unnecessary wear and tear to the projector.

CAUTION



- Do not unplug the power cable from the wall outlet or projector when the projector is powered on. Doing so can cause damage to the AC IN connector of the projector and (or) the prong plug of the power cable. To turn off the AC power supply when the projector is powered on, use a power strip equipped with a switch and a breaker.
- Do not turn off the AC power supply within 10 seconds of making adjustment or setting changes and closing the menu. Doing so can cause loss of adjustments and settings and return to default.

Refer to the following guide to shut down the projector.

1. Press the **On/Standby** button once. The Power Off window displays.

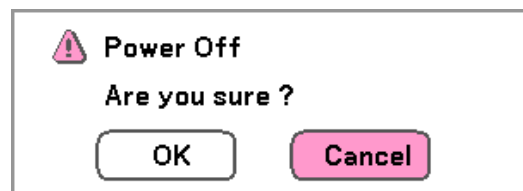

2. Press the **On/Standby** button or **Select** again on the OSD control panel or remote control to verify power off.
The cooling fans continue to operate (cooling-off time).
The cooling fans stop operating when the projector turns off.

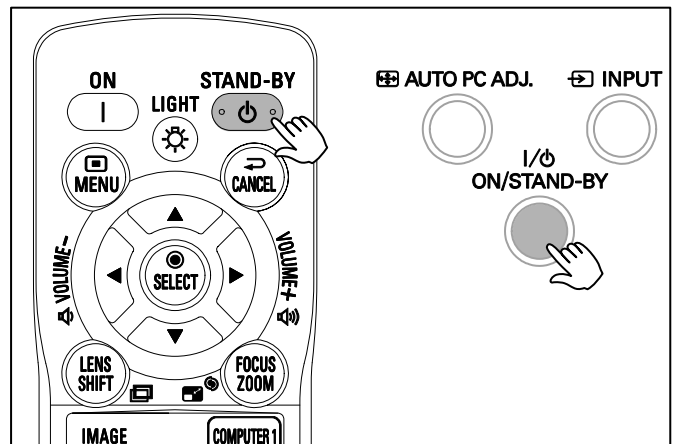

3. The projector enters Standby mode and the power LED lights orange.
4. Press the Main Power switch to the off position (O) to turn off the projector.

Please wait a moment.

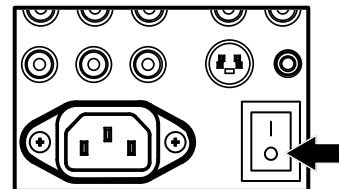

3. Projecting an Image (Basic Operation)

About Direct Power Off

The projector has a feature called "Direct Power Off". This feature allows the projector to be turned off (even when projecting an image) using a power strip equipped with a switch and a breaker.

Note:

Before using Direct Power Off, be sure to allow at least 20 minutes immediately after turning on the projector and starting to display an image.

After Use

Preparation: Make sure that the projector is turned off.

1. Unplug the power cable.
2. Disconnect any other cables.
3. Return the height adjusters to their original, minimum position.
4. Cover the lens with the lens cap.

4. Convenient Features

③ Adjusting the Focus/Zoom Manually

The focus and zoom can be adjusted manually from the projector focus/zoom panel or from the remote control unit. Refer to the following guides to adjust the focus and zoom manually.

Adjusting by Using the OSD Control Panel

1. Press the **Focus** or **Zoom** button on the projector panel to display the appropriate window.

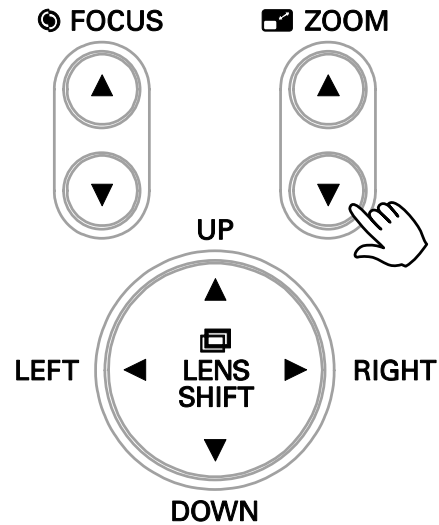

2. Adjust the Focus/Zoom using the increase and decrease buttons as required.
3. Press **Cancel** to return to the projected image.



④ Changing Lamp Mode

The projector has two lamp modes available, **Normal** and **Eco**. The **Normal** mode is used for everyday standard projection, whereas the **Eco** mode is used for saving power and lamp life. To change the Lamp Mode, refer to the following guides.

Changing Lamp Mode by Using the Projector's OSD Control Panel

1. Press **Menu** on the projector's OSD control panel to display the **Main Menu**. Scroll to the **Setting** menu using **▲** or **▼** and press **Select**.

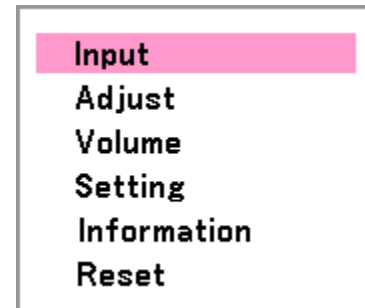

2. Select the **Basic** tab using **◀** or **▶** and select **Lamp control** using **▲** or **▼**. Press **Select**.

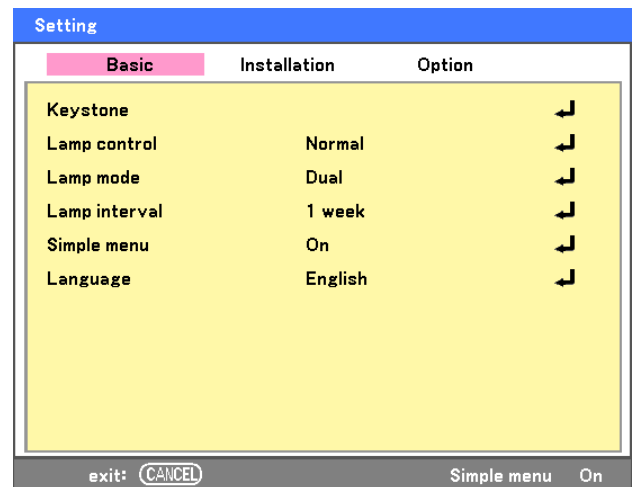

3. From the **Lamp control** window, select **Normal** or **Eco** using **▲** or **▼**. Select **OK** and press **Select**.

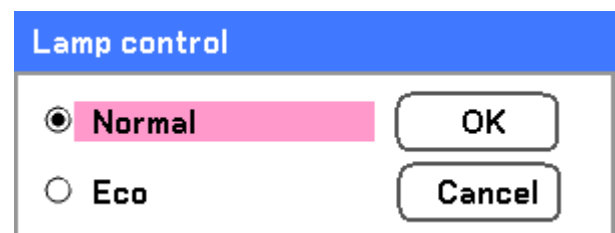

4. Convenient Features

Changing Lamp Mode by Using the Remote Control

1. Press the **Lamp control** button on the remote control to access the Lamp control menu.
2. From the **Lamp control** window, select **Normal** or **Eco** using **▲** or **▼**. Move the cursor to **OK** and press **Select**.

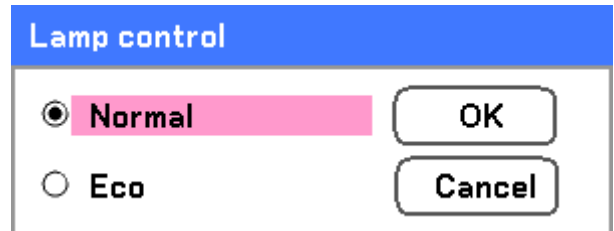

Note:

When the projector is in Eco mode, brightness may be affected.

Normal Mode: 100% Brightness

Eco Mode: approx. 85% Brightness

5 Getting Information

The Information screen provides details on the life of consumable items within the projector as well as other information such as software version. To access the Information screen, refer to the following guide.

1. Press **Menu** on the projector's OSD control panel or remote control to display the **Main Menu**. Scroll to the **Information** menu using **▲** or **▼** and press **Select**.

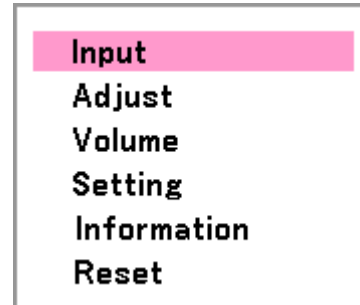

2. The **Usage time** menu is displayed as the default view. The menu items in this screen are for display and cannot be modified.

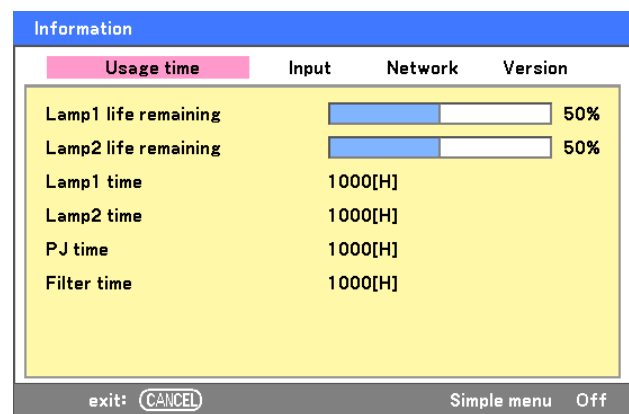

3. Press **Cancel** to return to the projected image.

4. Convenient Features

⑥ Adjusting Position/Total Dots/Fine Sync

The Position/Total dots/Fine sync and Keystone Correction can be adjusted manually from the projector's control panel or from the remote control unit. Refer to the following guides to adjust the Keystone Distortion manually.

Adjusting Position/Total Dots/Fine Sync by using the OSD Control Panel

1. Press the **Menu** button to display the Main menu. Select the **Adjust** menu using **▲** or **▼** and press **Select** to display the Adjust menu.

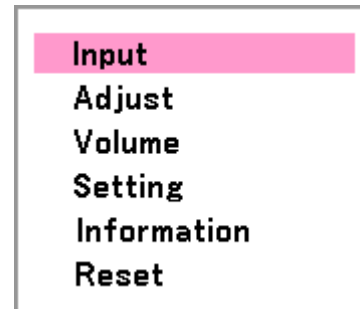

2. From the Adjust menu, press **◀** or **▶** to select Image Options and scroll using **▲** or **▼** to **Horizontal**, **Vertical**, **Total dots**, or **Fine sync**.

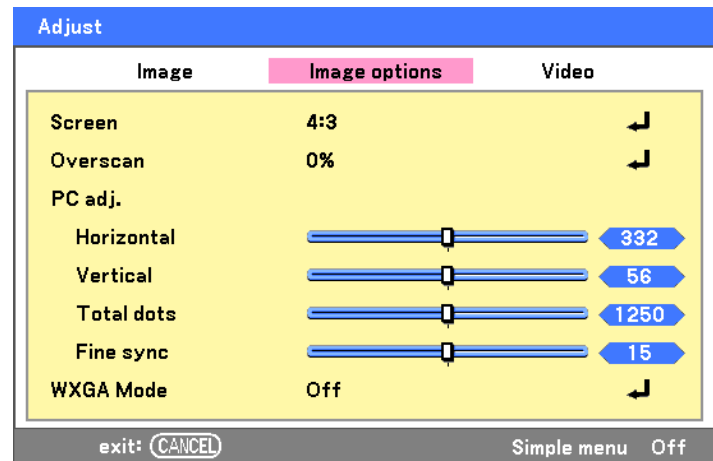

3. Adjust the **Horizontal**, **Vertical**, **Total dots**, or **Fine sync** sliding bars using the select **▲** **▼** **◀** **▶** buttons.
4. Press **Cancel** to return to the projected image.

Correcting Keystone by Using the Remote Control

1. Press the **Keystone** button to display the Keystone window.

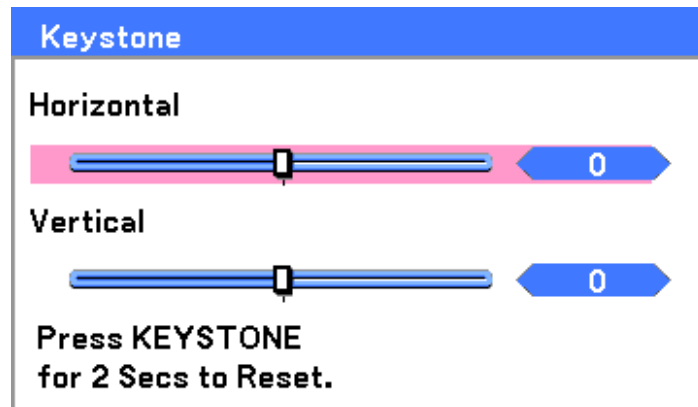

2. Adjust the **Horizontal** and **Vertical** sliding bars using the select ▲▼◀▶ buttons.
3. Adjust the slide bars until the screen trapezoid is a regular shape (see diagram).

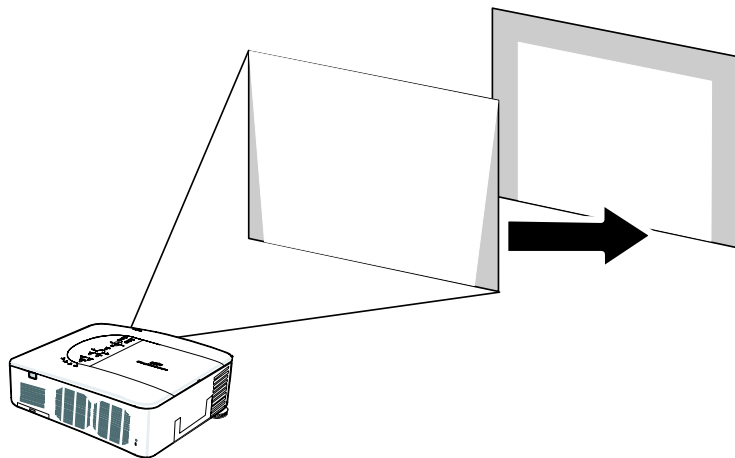

4. Press **Cancel** to return to the projected image.

Note:

Holding down the Keystone button for 2 seconds resets the default keystone values.

4. Convenient Features

ADJUSTMENT	HORIZONTAL	VERTICAL
Keystone	Max. +/- 35° approx.	Max. +/- 40° approx.

The following are conditions under which the maximum angle is achieved:

- When the standard lens (LNS-S40) is used
- When the lens shift is set to H for center and V for 0.5 shift.
- When the lens shift is used and yet you do not get the above-mentioned condition (H for center and V for 0.5 shift), you cannot adjust the keystone correctly.
- Image is projected in Wide mode
- Resolution is WXGA

Note:

Higher resolution than WXGA narrows the adjustable range.

Menu items should be set as follows:

- Aspect Ratio 15:9

Horizontal and Vertical are adjusted separately.

A combination of both adjustments narrows the adjustable range.

⑦ Preventing the Unauthorized Use of the Projector

The projector has a built-in security feature to lock the OSD control panels and deny remote control operation. The security feature has no default keyword; in the first instance of enabling the security feature, the user must define a keyword.

Locking the Projector

To setup the security keyword, refer to the following guide.

- 1.

4. Convenient Features

4. The PIN code window is displayed. Enter a PIN code between 4 and 10 characters using ▲▼◀▶. The PIN code characters change to “*”. Press **Select**.



5. Once a successful PIN code is entered, a confirmation screen is displayed. Enter the same password as the previous step and write it down for later reference. Press **Select**. A security activation message is displayed. Select **Cancel** to return to the **Setting** menu or select **OK** to enable security.

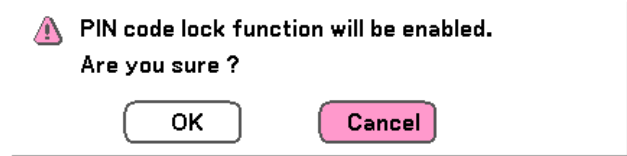

CAUTION



When you have set or changed the PIN code, take a memo and keep it securely. If you forget your PIN code, the projector can no longer be started. Contact your dealer or the service center.

While the projector is locked with the PIN code...

Put on the label below (supplied) in a prominent place of the projector's body while it is locked with a PIN code.

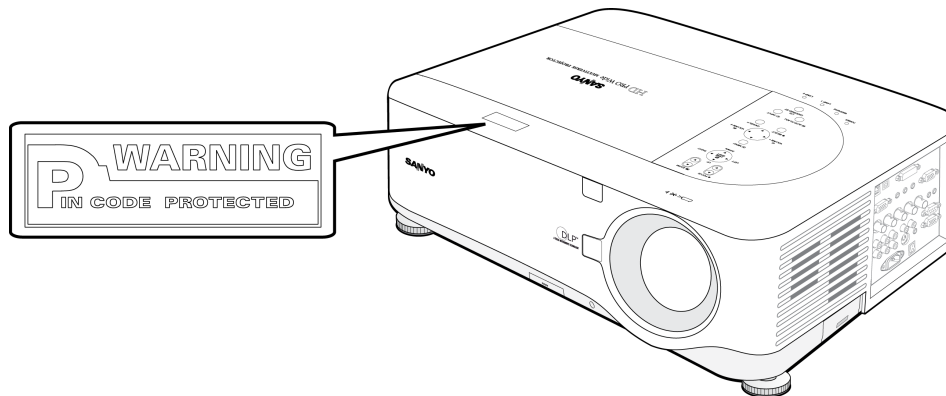

Unlocking the Projector

To unlock the projector, refer to the following guide.

1. When the projector is locked, either by request during operation or at start up, the locked message is displayed.
2. To unlock the projector, press **Menu** on the control panel or remote control. The PIN code window is displayed. Enter the previously defined PIN code to activate the projector.



Projector is locked! Enter your PIN code.



PIN code

4. Convenient Features

⑧ Using the Physical Lock

For security and authorized usage, the projector comes with two types of security features, the Kensington Lock and the Security Chain Lock.

Using the Kensington Lock

If you are concerned about security, attach the projector to a permanent object with the Kensington slot and a security cable.

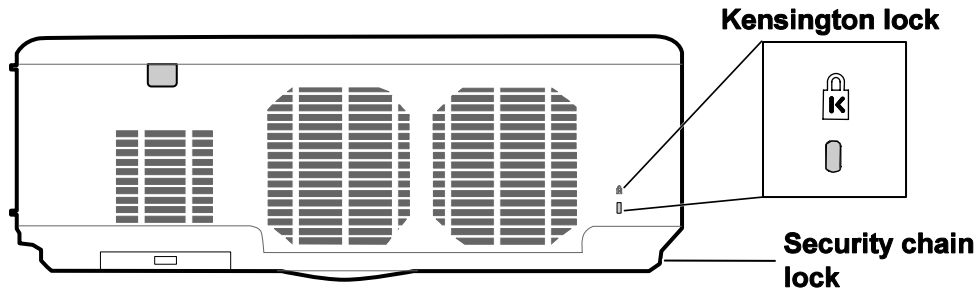

Using the Security Chain Lock

In addition to the password protection function and the Kensington lock, the security chain opening helps protect the projector from unauthorized use.

See the following illustration.

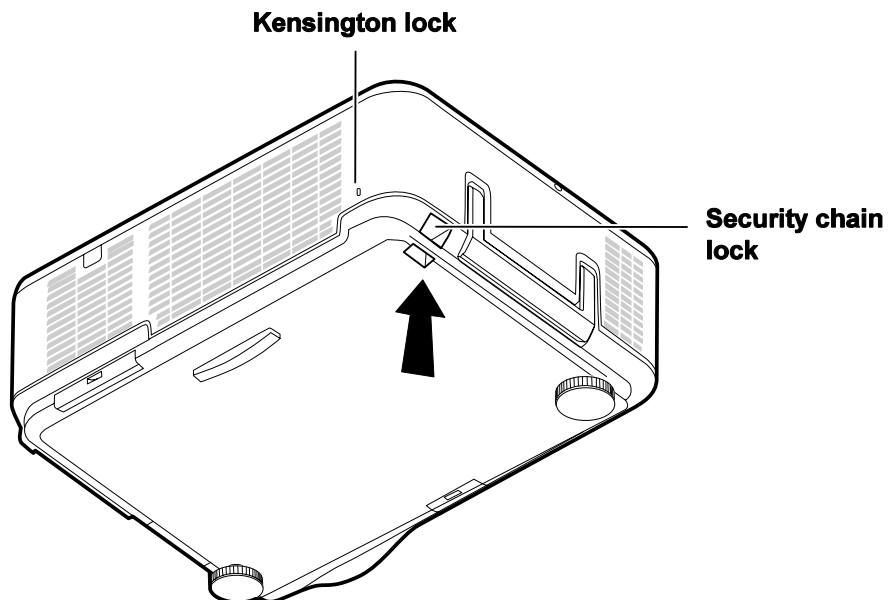

5. Using On-Screen Display

① Using the Menus

The projector has an On-Screen Display (OSD) that lets you make image adjustments and change various settings.

Navigating the OSD

You can use the remote control or the buttons on the top of the projector to navigate and make changes to the OSD. The following illustration shows the corresponding buttons on the remote control and on the projector.

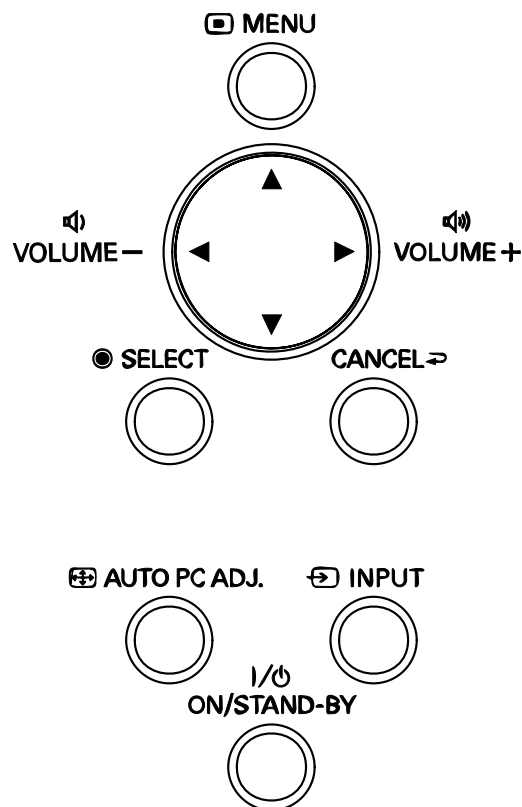

1. To open the OSD, press the **Menu** button on the OSD control panel or remote control. There are six initial menus. Press the cursor **▲** or **▼** buttons to move through the initial menus and **Select** to enter the desired menu.

Input
Adjust
Volume
Setting
Information
Reset

5. Using On-Screen Display

2. Press the cursor ◀ or ▶ button to move through secondary menus.

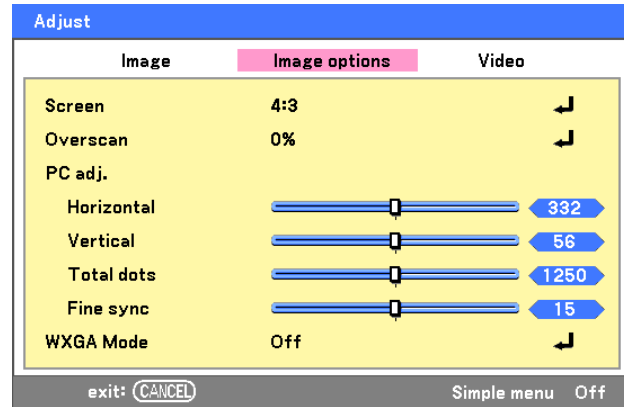

3. Press ▲ or ▼ to select menu items and ◀ or ▶ to change values for settings. Press **Select** to confirm the new setting.

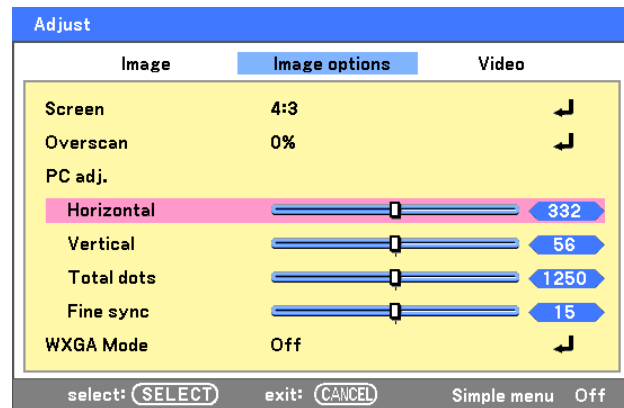

4. Press **Cancel** to close the OSD or leave a submenu.

② Menu Tree

The gray shaded areas indicate factory default settings.

MENU		ITEM		
Input		Computer 1, Computer 2, Computer 3, Component, Video, S-Video		
		Test pattern	CrossHatch, Raster(0%), Raster(25%), Raster(50%), Raster(100%), Raster Red, Raster Green, Raster Blue, Raster Blue 60, Gray Raster 10, Gray Raster 30, Ramp H, Ramp V, Red Ramp H	
Adjust	Image	Image select	High-bright/Presentation/Video/Movie/Graphic/sRGB	
		Detail setting	Basic	Reference
			Gamma	Dynamic/Natural/Black detail
			Color temp.	5000K/6500K/7800K/8500K/9300K/10500K
			Brilliant color	1 to 3
		White balance	Red	1 to 100
			Green	1 to 100
			Blue	1 to 100
			Contrast R	1 to 100
			Contrast G	1 to 100
			Contrast B	1 to 100
		Color correction	Red, Green, Blue, Yellow, Magenta, Cyan	-60 to 60
		Contrast	0 to 100	
		Brightness	0 to 100	
		Sharpness	0 to 31	
		Color	0 to 100	
		Tint	0 to 100	
		Reset		
	Image options	Screen	4:3/16:9/15:9/Letterbox/True/Normal	
		Overscan	0%/5%/10%/15%	
		PC Adj.		
		Horizontal	±50	
		Vertical	±25	
		Total dots	±50	
		Fine sync	0 to 63	
		WXGA Mode	Off/On	
	Video	Noise reduction	Off/Low/Mid/High	
		3D Y/C separation	Off/On	
		Progressive	Off/Still/Normal/Movie	
		Color matrix	Auto/RGB/SDTV/HDTV	
		Motion adaptive mode	Motion adaptor/Field Jam/Scaled Field/Mixed Mode	
		Film	Off/2-2/2-3 Auto/2-2 On/2-3 On	
Volume		0~61		
Setting	Basic	Keystone	Horizontal Vertical	
		Lamp control	Normal/Eco	
		Lamp mode	Dual/Lamp1/Lamp2	
		Lamp Interval	Off/1 week/4 week/2000H	
		Simple menu	On/Off	
		Language	English/Deutsch/Français/Italiano/Español/Svenska/ /	

5. Using On-Screen Display

MENU	ITEM		
Installation	Ceiling & Rear	Desktop Front/Ceiling Rear/Desktop Rear/Ceiling Front	
	Communication speed	4800bps/9600bps/19200bps/38400bps	
	Menu color select	Color/Monochrome	
	Display time	Manual/Auto 5sec/Auto 15sec/Auto 45sec	
	Background	Blue/Black/Logo	
	PIN code lock	Off/On	
	Key lock	Off/On	
	Dynamic black	Off/On	
	RC sensor	Both, Front, Back	
	Network setting	DHCP Enable/Disable	
		IP address	
		Subnet	
		Gateway	
		DNS	
	Network PIN code (0000 to 9999)		
	Apply settings		
	Standby mode	Normal/Power-saving	
	PC control	PC control/Network	
Option	On start	Off/On	
	Power management	Off/00:05/00:10/00:20/00:30	
	Screen trigger	Off/On	
	Fan control	Normal/Max	
	Default input select	Last/Auto/Computer1/Computer2/Computer3/ Component/Video/S-Video	
	Color system		
	Video	Auto/NTSC/PAL/SECAM	
	S-Video	Auto/NTSC/PAL/SECAM	
	Remote control	Code1/Code2/Code3/Code4/Code5/Code6/Code7/Code8	
	Message	Off/On	
	Filter warning	Off/100[H]/200[H]/500[H]/1000[H]	
	Search mode	Normal/Fine	
	Information	Usage time	Lamp1 life remaining, Lamp2 life remaining Lamp1 time, Lamp2 time PJ time Filter time
		Input	Input name Signal H-sync freq. V-sync freq. Video type Sync type Sync polarity Scan type
Network		IP address, Subnet, Gateway, MAC address	
Version		Model name, Serial number, Firmware, Data, Remote control	
Reset		Current signal, All data, Clear lamp1 time, Clear lamp2 time, Clear filter time	

3 Menu Elements

Some menus and windows contain large amounts of information in a small area. Refer to the following guide to navigate through options more easily.

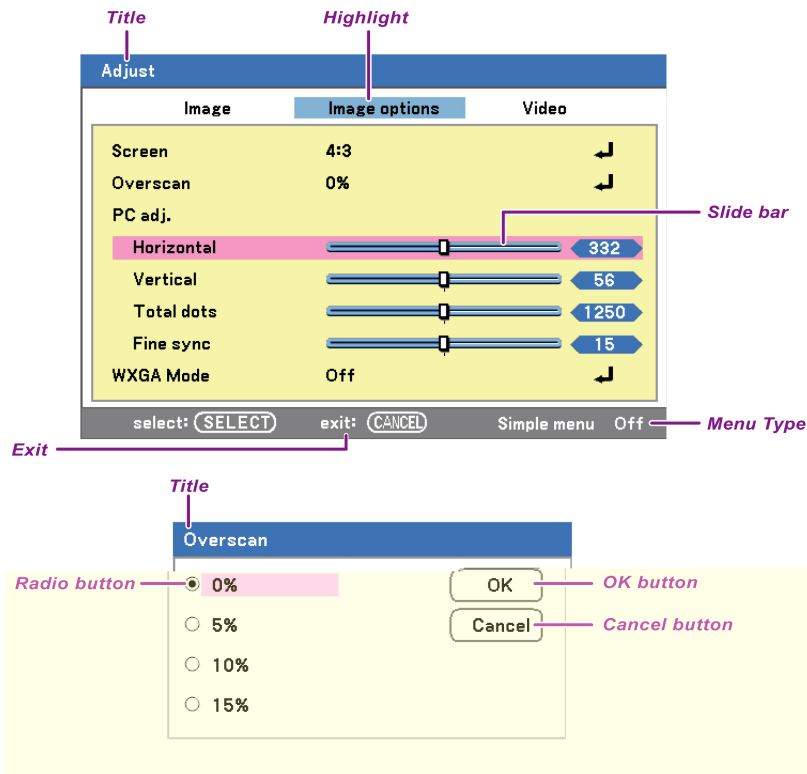

5. Using On-Screen Display

④ Source Menu Descriptions and Functions

The Source menu displays all supported image sources.

- Computer1**
- Computer2**
- Computer3**
- Component**
- Video**
- S-Video**
- Test pattern**

Select the required source from the menu using ▲ or ▼ and press **Select** to confirm.

ITEM	DESCRIPTION
Computer 1	Select the source connected to the Computer 1 input (see Connecting Your PC or Macintosh Computer on page 26).
Computer 2	Select the source connected to the Computer 2 input (see Connecting Your PC or Macintosh Computer on page 26).
Computer 3	Select the source connected to the Computer 3 input (see Connecting Your PC or Macintosh Computer on page 26).
Component	Select the source connected to the Component input (see Connecting Your DVD Player with Component Output on page 29).
Video	Select the source connected to the Video input (see Connecting Your VCR or Laser Disc Player on page 30).
S-Video	Select the source connected to the S-Video input (see Connecting Your VCR or Laser Disc Player on page 30).
Test Pattern	Displays information about the type of test pattern (Range: CrossHatch, Raster (0%), Raster (25%), Raster (50%), Raster (100%), Raster Red, Raster Green, Raster Blue, Raster Blue 60, Gray Raster 10, Gray Raster 30, Ramp H, Ramp V, Red Ramp H).

5 Adjust Menu Descriptions and Functions

The Adjust menu contains overall projector settings for image output such as sharpness, overscan and color matrix.

Three tabs are accessible through the Adjust menu, Picture, Image Options and Video.

Image menu

The image menu is used to alter picture settings and can be accessed from the Adjust menu.

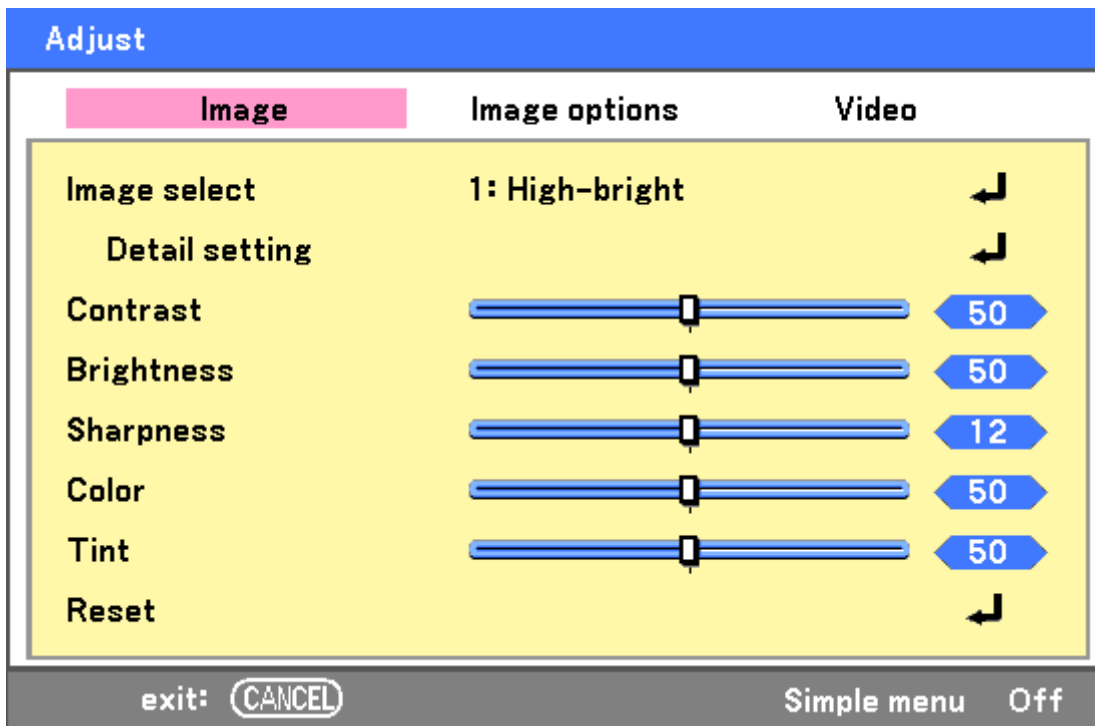

The following table lists all functions with a description and the default setting.

ITEM	DESCRIPTION
Image select	Select a set of preset values using ◀ or ▶ from the list. Notice that the below values will change depending on the preset selection.
Detail Setting	See 6 Detail Settings Menu Descriptions and Functions on page 67.
Contrast	Adjust the Contrast value using ◀ or ▶ to highlight the differences between light and dark areas of the picture.
Brightness	Adjust the Brightness value using ◀ or ▶ to lighten or darken the picture.
Sharpness	Adjust the Sharpness value using ◀ or ▶ to sharpen or blur the borders between colors and objects.
Color	Adjust the Color value using ◀ or ▶ to increase or decrease color input to the picture.
Tint	Adjust the Tint value using ◀ or ▶ to increase or decrease the color Hue of the picture.
Reset	The settings and adjustments are set to initial factory settings.

5. Using On-Screen Display

Image options menu

The Image Options menu is used to configure image options such as screen positioning and aspect ratio. Access the image options menu in the Adjust menu.

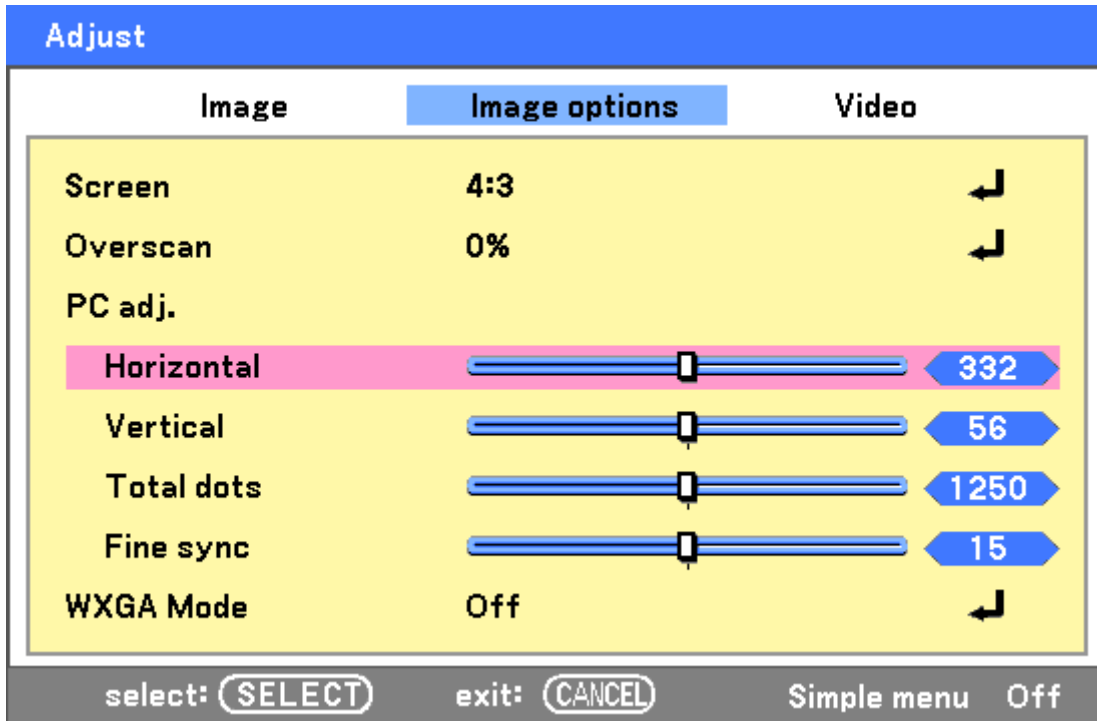

The following table lists all functions with a description and the default setting.

ITEM	DESCRIPTION
Screen	Select Screen using ◀or▶ from the list (see page 63).
Overscan	Set the Overscan value using ◀or▶ (see page 63).
PC adj.	<p>Adjust the position values using the slides.</p> <p>Horizontal: Adjusts the image location horizontally using ◀or▶.</p> <p>Vertical: Adjusts the image location vertically using ◀or▶.</p> <p>Total dots: Fine tune a computer image or remove any vertical banding that might appear.</p> <p>Fine sync: Adjust the clock phase or reduce video noise, dot or cross talk.</p> <p>Note: Only use the Phase settings after the total dots settings have been modified.</p>
WXGA Mode	Select WXGA Mode (see page 63).

Screen

The screen option allows for the adjustment of the aspect ratio to alter the appearance or ratio of the projected image.

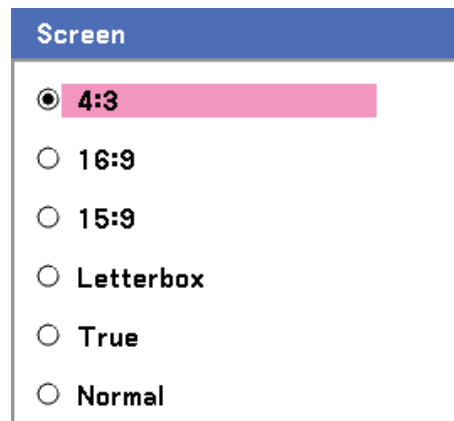

4:3 – Standard TV screen (4:3), proportionally four units wide for every three units high, no matter the size of the screen.

16:9 – A wide-screen aspect ratio for video.

15:9 – Uses the full display.

Letterbox – Reduce image to display the true aspect with black borders on top and bottom.

True – Displays the current image in its true resolution.

Normal – Displays the current image in its aspect ratio.

Overscan

Video images normally exceed the size of the display screen. The edge of the picture may or may not be displayed correctly. The border area that is cropped can be adjusted by using the Overscan menu.

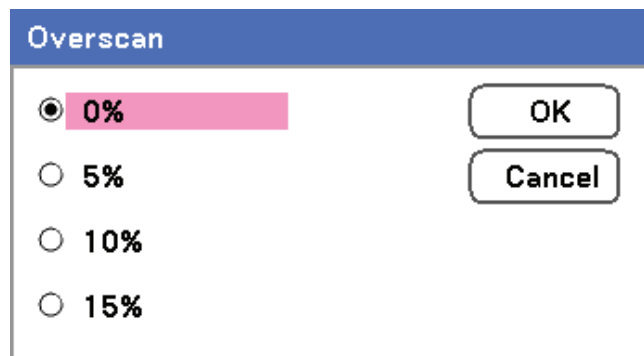

Set the overscan percentage between 0 – 15% to compensate for different screen sizes.

WXGA Mode



Selecting On gives priority to a WXGA (1280 x 768) signal when recognizing an input signal.

When WXGA Mode is set to On, an XGA (1024 x 768) signal may not be recognized. Set WXGA Mode to Off if this occurs. To check if the signal is recognized, go to "Input" under "Information" menu (see page 90).

5. Using On-Screen Display

Video menu

The Video menu is used to configure image options such as film. Access the Video menu in the Adjust menu.

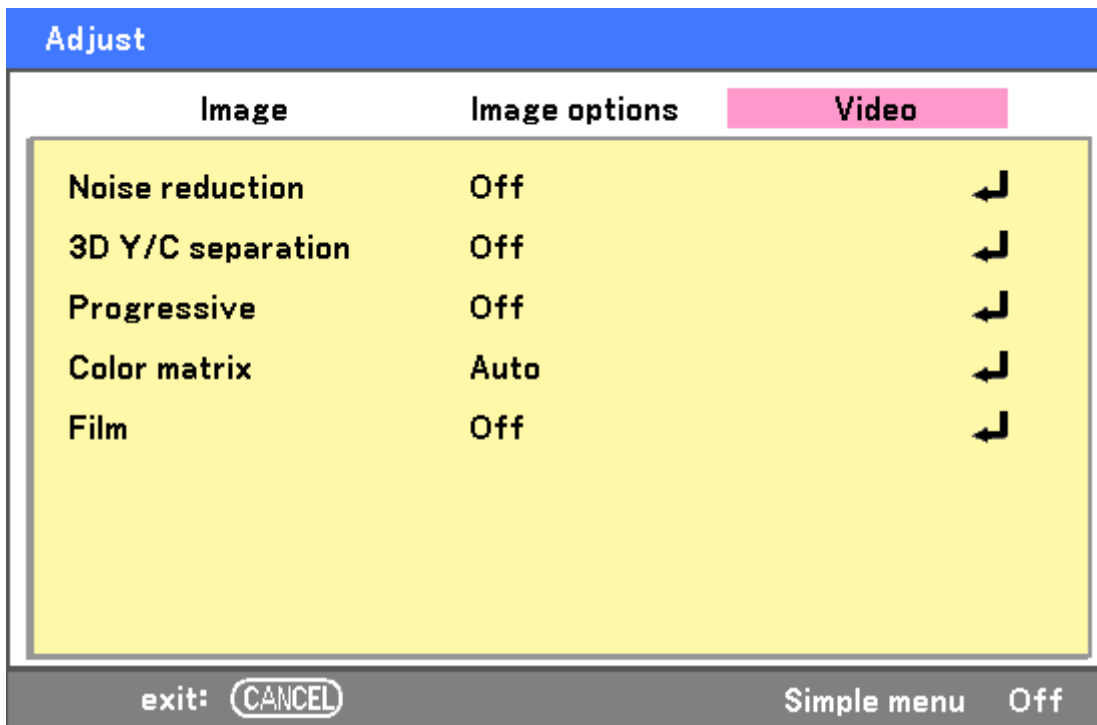

The following table lists all functions with a description and the default setting. A detailed description follows the table.

ITEM	DESCRIPTION
Noise reduction	Select Noise reduction mode (see page 65).
3D Y/C separation	Select 3D Y/C separation mode (see page 65).
Progressive	Select Progressive mode (see page 65).
Color matrix	Select Color matrix mode (see page 65).
Film	Select Film mode (see on page 65).

Noise reduction

Select the level of noise reduction required.

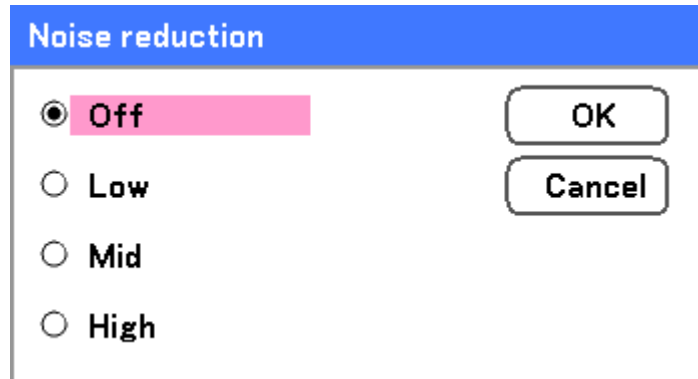

The dialog box has a blue header with the text "Noise reduction". Below the header, there are four radio button options: "Off", "Low", "Mid", and "High". The "Off" option is selected and highlighted with a pink background. To the right of the options are two buttons: "OK" and "Cancel".

Range: Off, Low, Mid, High.

3D Y/C separation

3D Y/C Separation separates composite signal to Y (brightness) signal and C (color) signal, and can help to produce clearer and sharper images without overlapping colors (rainbow effect).

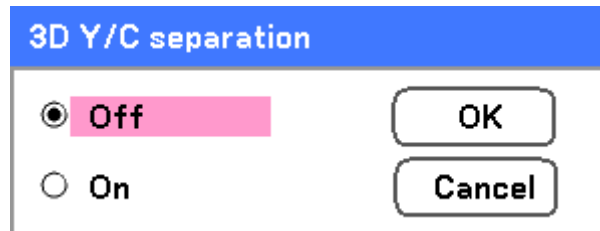

The dialog box has a blue header with the text "3D Y/C separation". Below the header, there are two radio button options: "Off" and "On". The "Off" option is selected and highlighted with a pink background. To the right of the options are two buttons: "OK" and "Cancel".

Set 3D Y/C Separation On or Off.

Progressive

Progressive converts an interlaced image to a progressive scan image.

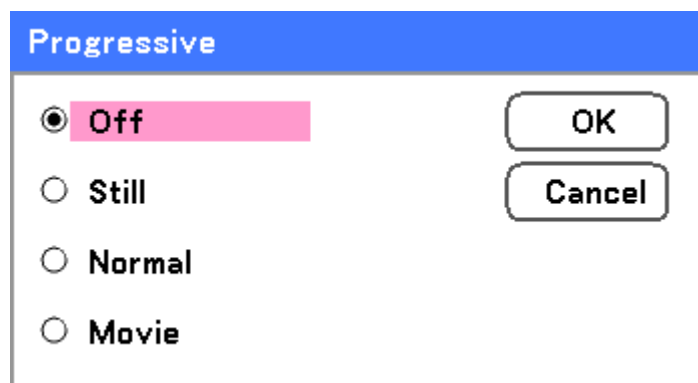

The dialog box has a blue header with the text "Progressive". Below the header, there are four radio button options: "Off", "Still", "Normal", and "Movie". The "Off" option is selected and highlighted with a pink background. To the right of the options are two buttons: "OK" and "Cancel".

Select the form of Deinterlacing required from:

Still – Select for stills such as slide projections or screen shots.

Normal – Select Normal for non-specialized projection.

Movie – Select for movie projection.

5. Using On-Screen Display

Color matrix

Color Matrices define the amount of the three-color components R (red), G (green), and B (blue) in a single point in color space.

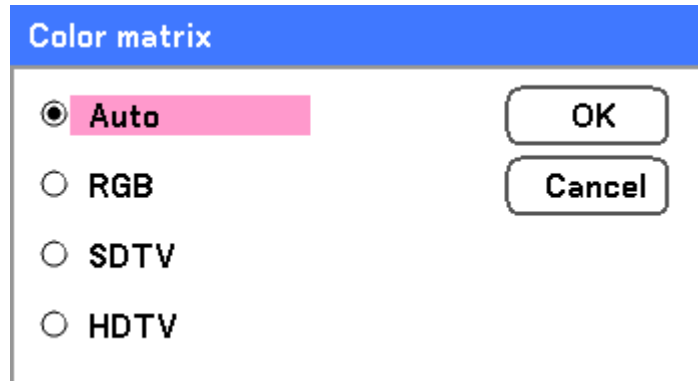

Select from the following:

Auto – Auto selects the color matrix.

RGB – Sets the color matrix to RGB, use for PC monitor or camera imaging.

SDTV – Sets the color matrix to SDTV, use for Standard Definition imaging.

HDTV – Sets the color matrix to HDTV, use for High Definition imaging.

Film

Film aids in converting motion picture film images into video. The process adds additional frames to the picture in order to increase the frame rate.

Note:

This feature is only available when Progressive is turned on and SDTV signal is selected.

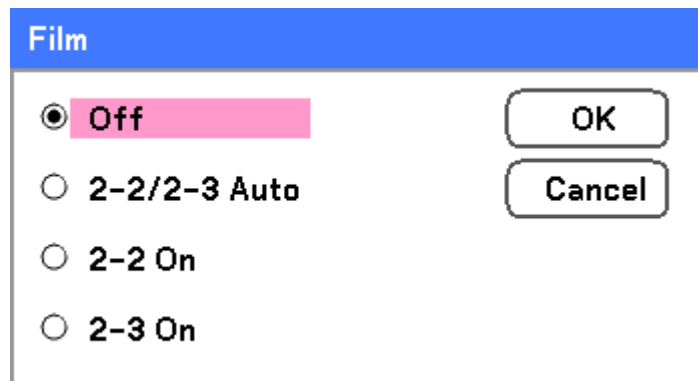

Select from the following:

Off – Film mode is turned off.

2-2/2-3 Auto – Detects pull-down correction method.

2-2 On – Uses 2-2 pull-down correction method.

2-3 On - Uses 2-3 pull-down correction method.

⑥ Detail Settings Menu Descriptions and Functions

The Detail settings menu contains basic and advanced color adjustment options such as gamma correction, color contrast and color correction.

Basic

The Basic tab contains general Detail Settings such as gamma correction and color temperature. Access to the General tab is through the Detail Settings menu.

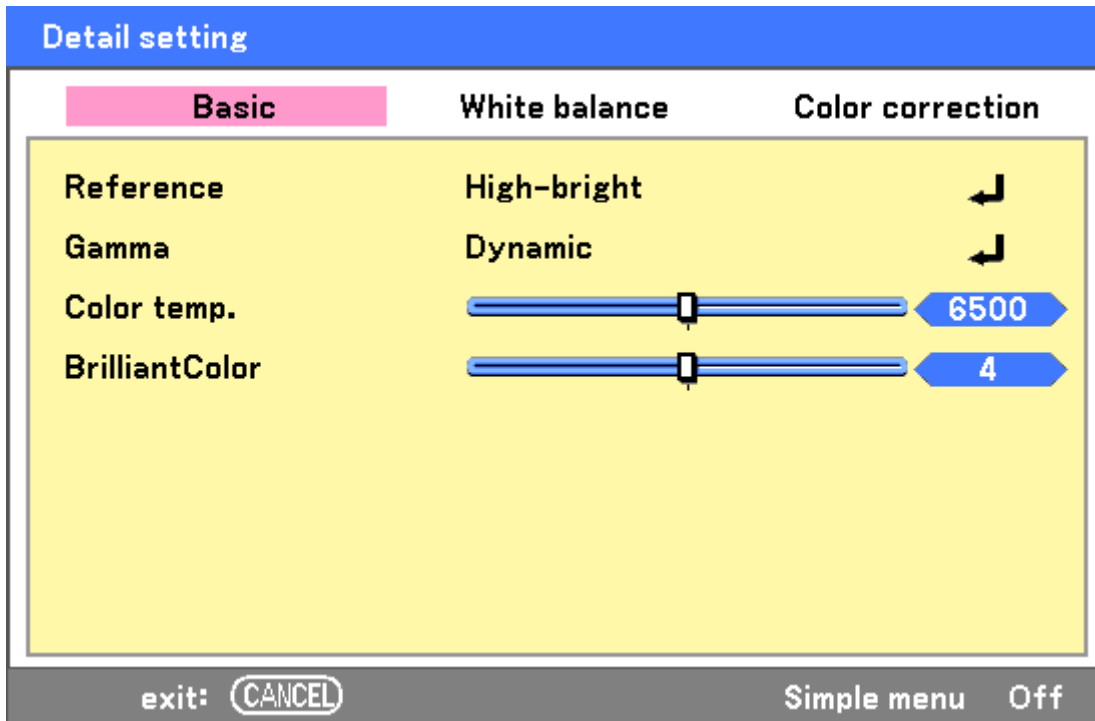

The following table lists all functions with a brief description.

ITEM	DESCRIPTION
Reference	Set Reference mode (see page 68).
Gamma	Select Gamma Correction mode (see page 68).
Color temp.	Move the slider bar left or right to set the color temperature value in Kelvin (K). Compensate for the amount of light available. Daylight is approximately 5500K.
BrilliantColor	Move the slider bar left or right to set the BrilliantColor™ value. BrilliantColor extends the exposure range and sharpens detail for grain free images.

5. Using On-Screen Display

Reference

The Reference mode allows the projector to differentiate between source materials for example movies, PC images or video stills.

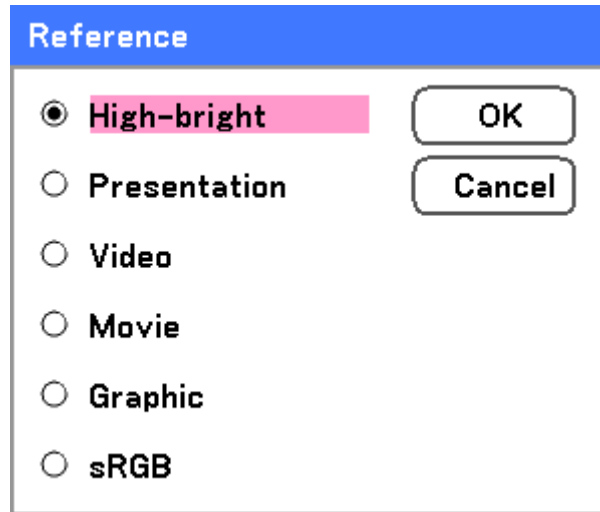

Select from the following:

High-bright – Select for use in a brightly lit room.

Presentation – Select if the projector is to be used for presentation purposes.

Video – Select for video projection.

Movie – Select for Movie projection.

Graphic – Select Graphic for still images.

sRGB – Select for projecting PC or web page images.

Gamma

Gamma enables adjustment to the light intensity (brightness) of an image in order to match the source more closely.

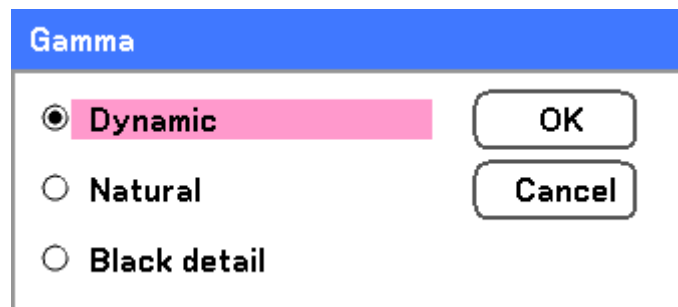

Select from the following:

Dynamic – Allows the projector to alter the gamma correction automatically.

Natural – Attempts to emulate the original source as closely as possible.

Black detail – Black detail highlights boundaries between light and dark areas of the image more clearly.

White balance

White Balance allows the projector to compensate for different colors of light being emitted by different light sources.

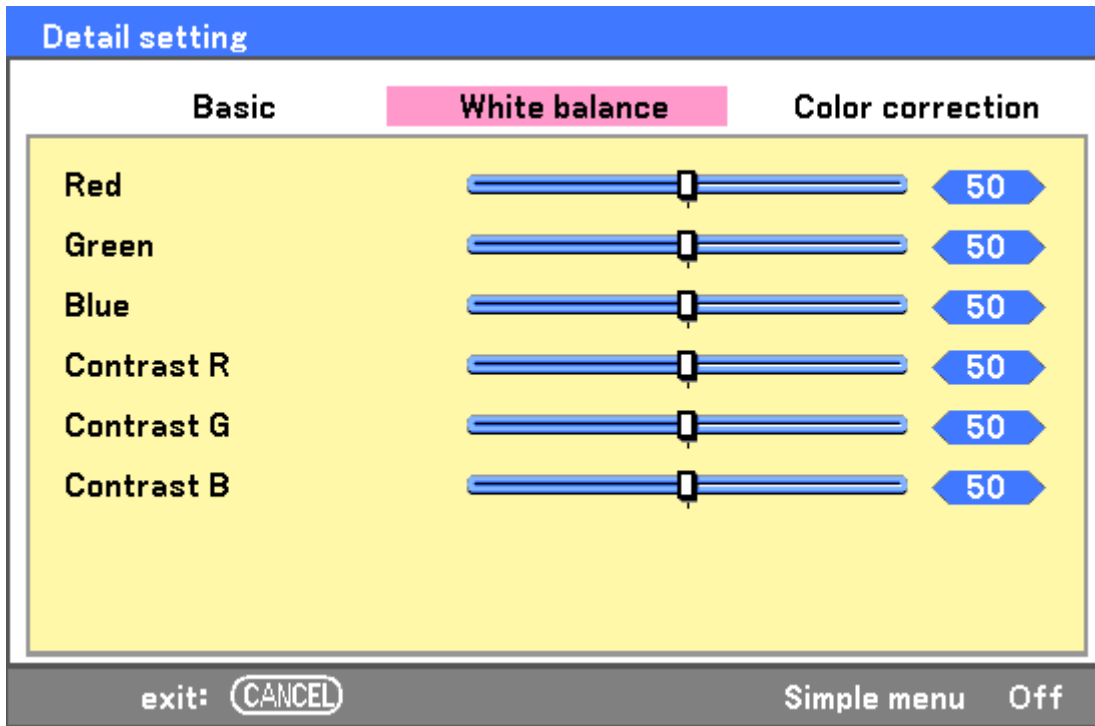

The following table lists all functions with a brief description.

ITEM	DESCRIPTION
------	-------------

5. Using On-Screen Display

Color correction

The Color correction tab enables the adjustment of color values in an image to remove unwanted effects, improve color, characteristics or add more of a particular color.

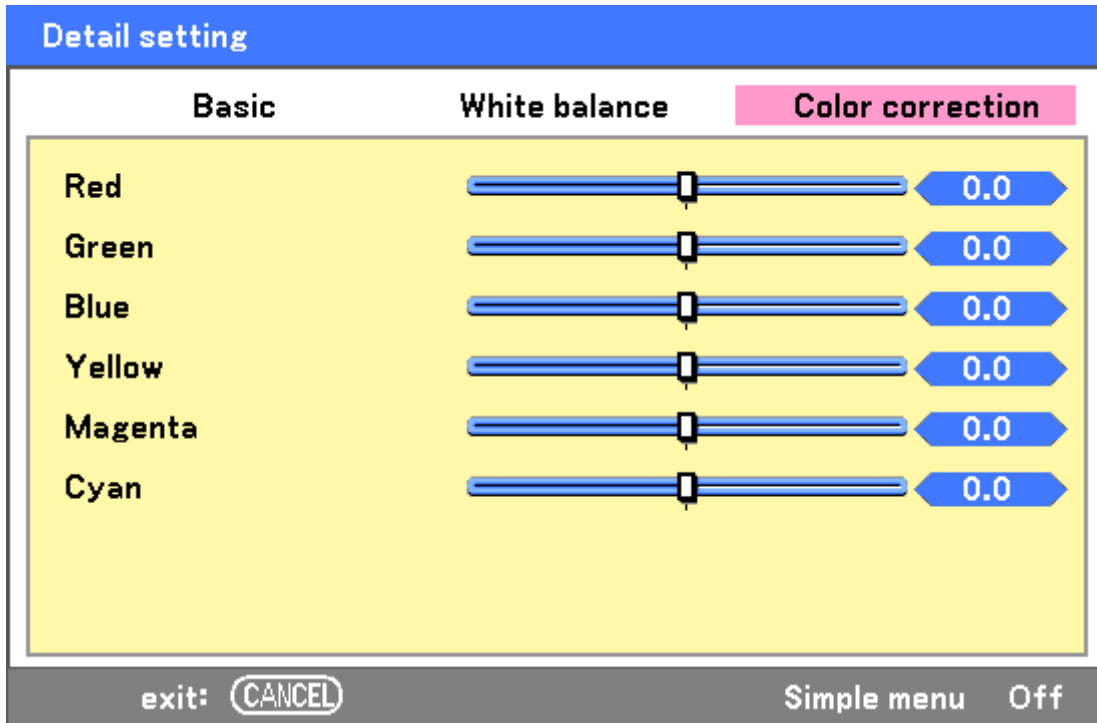

The following table lists all functions with a brief description.

ITEM	DESCRIPTION
Red	Increase or decrease the amount of red in the projected output using ◀ and ▶.
Green	Increase or decrease the amount of green in the projected output using ◀ and ▶.
Blue	Increase or decrease the amount of blue in the projected output using ◀ and ▶.
Yellow	Increase or decrease the amount of yellow in the projected output using ◀ and ▶.
Magenta	Increase or decrease the amount of magenta in the projected output using ◀ and ▶.
Cyan	Increase or decrease the amount of cyan in the projected output using ◀ and ▶.

7 Setting Menu Descriptions and Functions

The Setup menus contain the most often used settings during installation and options to customize the general output of the projector. Three tabs are accessible through the Setup menu, general, installation and option.

Basic

The **Basic** tab contains general setup options such as lamp mode and OSD language settings and can be accessed with the projector control panel or with the remote control unit.

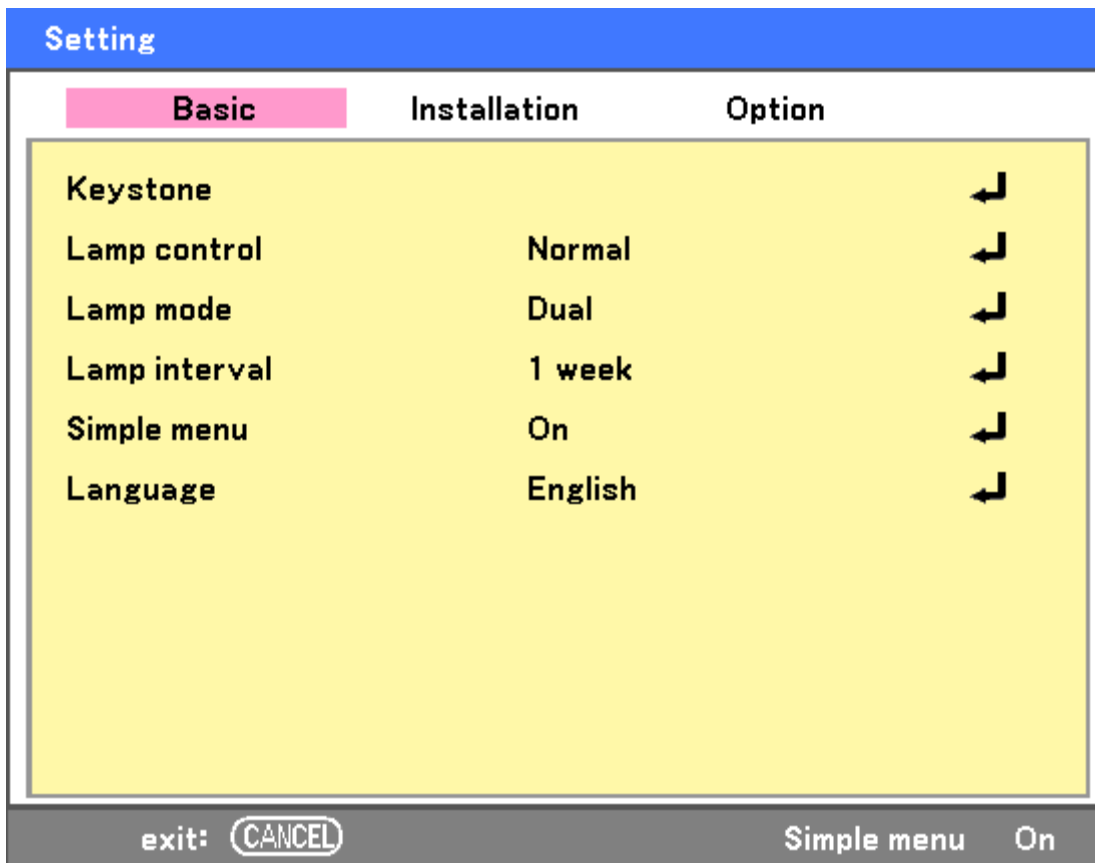

The following table lists all functions with a brief description.

ITEM	DESCRIPTION
Keystone	Adjust the Keystone trapezoid (see Keystone page 72).
Lamp control	Select Lamp control. Range: Normal or Eco.
Lamp mode	Select Lamp configuration. Range: Dual, Lamp1 or Lamp2.
Lamp interval	Select Lamp interval. Range: Off, 1 week, 4 weeks or 2000 hours.
Simple menu	Displays menus with minimum essential options. This setting is best suited to novices.
Language	Select the OSD language (see Language on page 74).

5. Using On-Screen Display

Keystone

The keystone trapezoid can be adjusted by selecting this option.

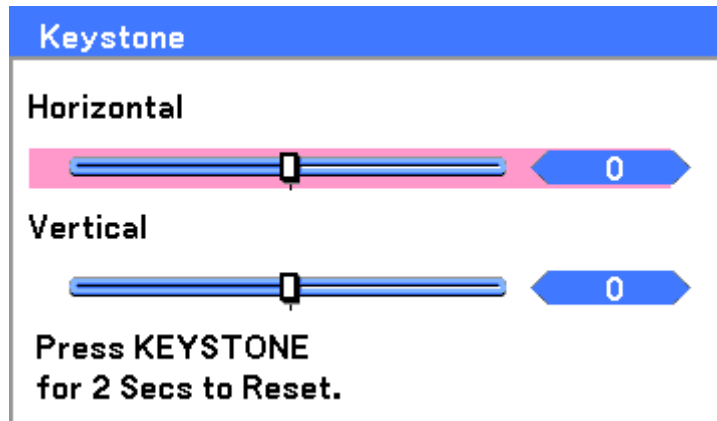

Select Horizontal or Vertical using ▲ or ▼ then, use ◀ or ▶ to adjust the projected image appearance as required.

Lamp control

Select Normal or Eco from the lamp mode window. The lamp life can be extended by using the Eco mode and the fan noise can be reduced.

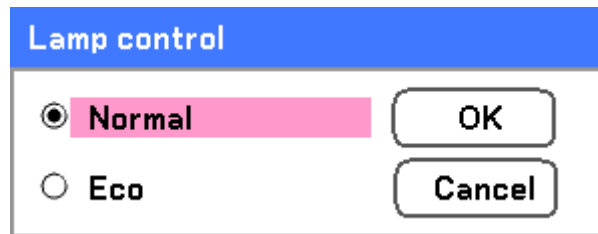

Lamp mode

Select the lamps to be used for projection.

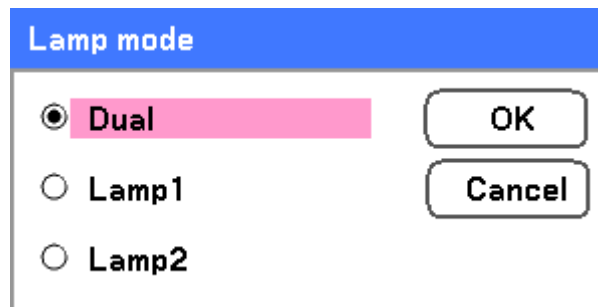

Select from the following:

Dual – Uses both lamps simultaneously.

Lamp1 – Uses Lamp1 only.

Lamp2 – Uses Lamp2 only.

Lamp interval

The period of time for regulating lamp usage when not in dual lamp mode.

Lamp interval

Off

1 week

4 weeks

2000H

OK

Cancel

Select from the following:

Off, 1 week, 4 weeks and 2000H

Simple menu

Select the Simple menu to display.

Simple menu

On

Off

OK

Cancel

Set Simple menu On or Off.

5. Using On-Screen Display

Language

Select the OSD language to be used.

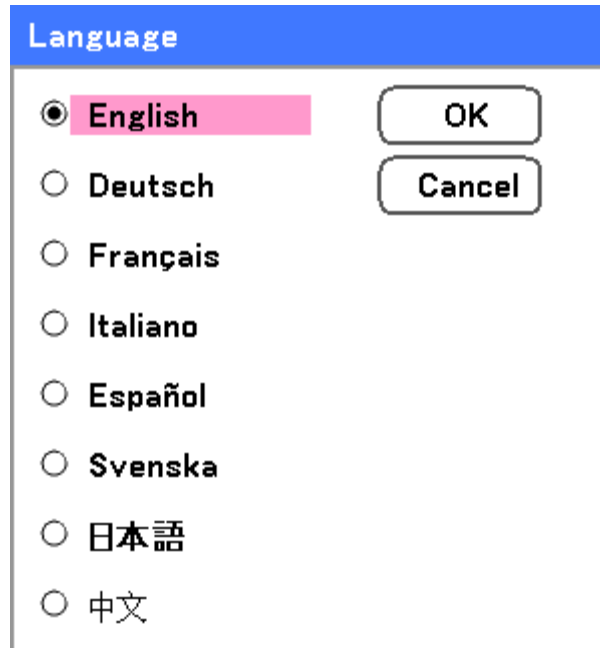

Select from the following:

- **English**
- **German**
- **French**
- **Italian**
- **Spanish**
- **Swedish**
- **Japanese**
- **Simplified Chinese**

Installation

The Installation tab contains menu options for various setup conditions such as orientation and remote sensor mode and is accessed through the Setup menu.

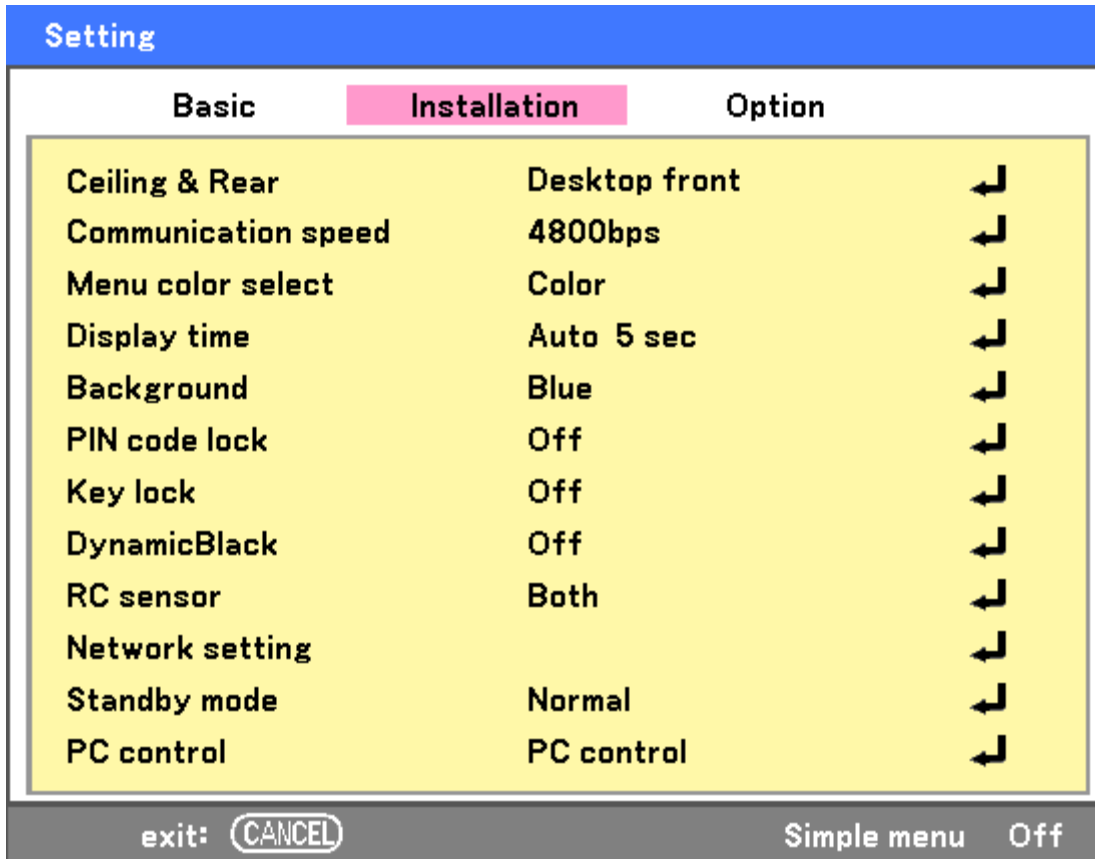

The following table lists all functions with a brief description.

ITEM	DESCRIPTION
Ceiling & Rear	Select from four projection methods depending on projection site (see Ceiling & Rear page 76).
Communication speed	Select Communication speed. Range: 4800bps, 9600bps, 19200bps, 38400bps
Menu color select	Select the menu color from the list. Range: color or monochrome.
Display time	Select Display time. Range: Manual, Auto 5s, Auto 15s, Auto 45s
Background	Select Background appearance when there is no signal. Range: blue, black or logo
PIN code lock	Set PIN code lock On/Off (see PIN Code Lock on page 79).

Communication speed

Select communication speed to set the baud rate of the connection.

Note:

Longer cable connections may require lower settings.

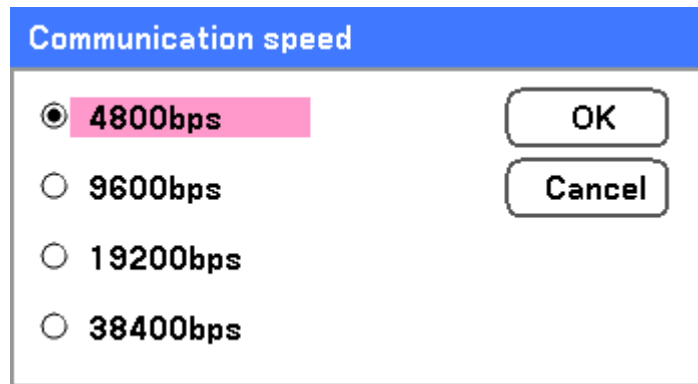

Select from the following options:

- 4800bps
- 9600bps
- 19200bps
- 38400bps

Note:

In the Network mode, Communication Speed function is not available.

Menu color select

Select color mode to set the menu color.

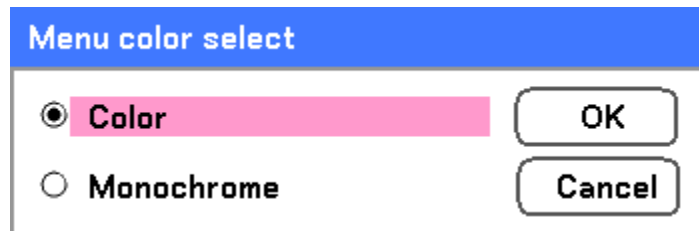

Select from the following options:

- Color

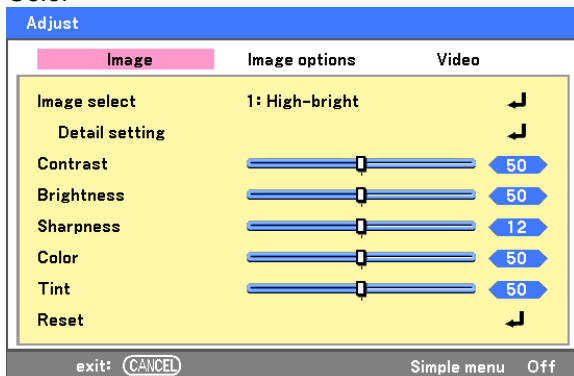

5. Using On-Screen Display

Monochrome

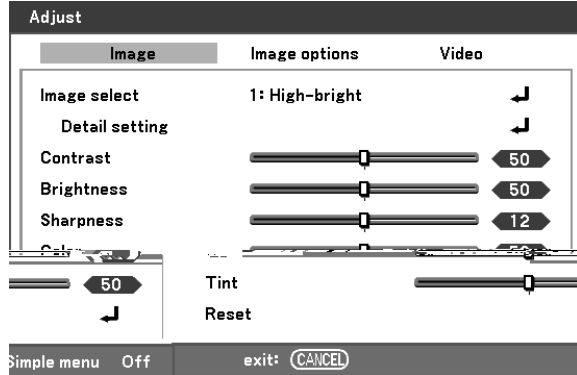

Display time

Sets the amount of time a menu is displayed.

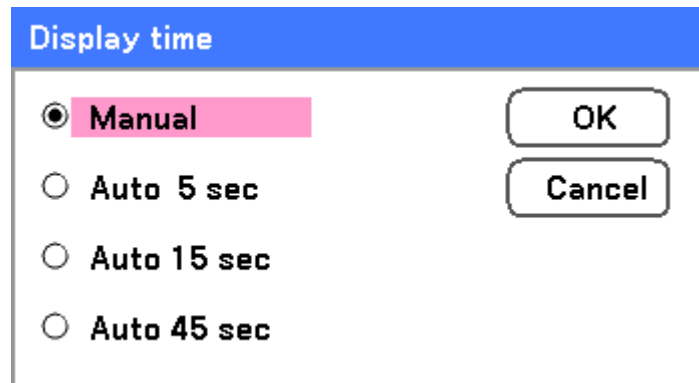

Select from the following:

Manual – Menus stay on screen until the **Menu** button is pressed again.

Auto 5 secs—Menu is displayed for 5 seconds.

Auto 15 secs – Menu is displayed for 15 seconds.

Auto 45 secs – Menu is displayed for 45 seconds.

Background

Background enables you to display a blue/black screen when there is no signal. The default background is blue.

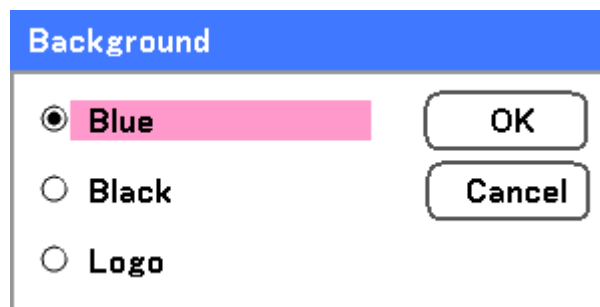

Select from the following:

- Blue
- Black
- Logo

PIN Code Lock

See 7 Preventing the Unauthorized Use of the Projector on page 51 – 53.

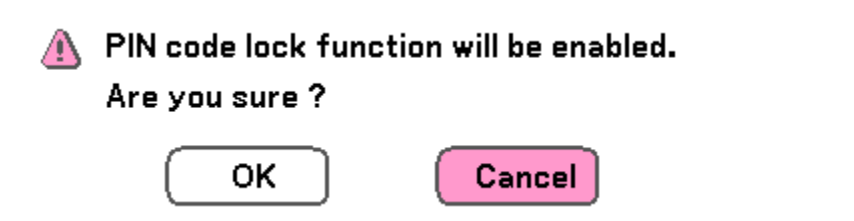

Key lock

Turn On/Off the Key Lock function for cabinet buttons.

Note:

- This Control Panel Lock does not affect the remote control functions.
- When the control panel is locked, pressing and holding the Cancel button on the projector cabinet for about 10 seconds. The setting will change to Off.



DynamicBlack

DynamicBlack™ enables you to improve the black level of the projector.

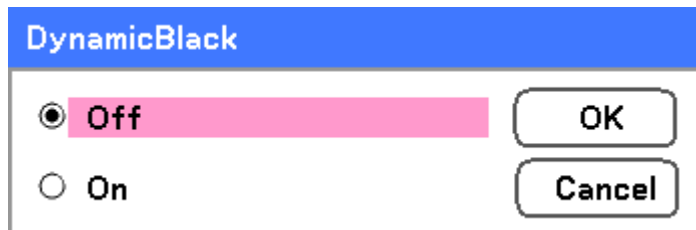

RC sensor

Set the operating range for the wireless remote control.

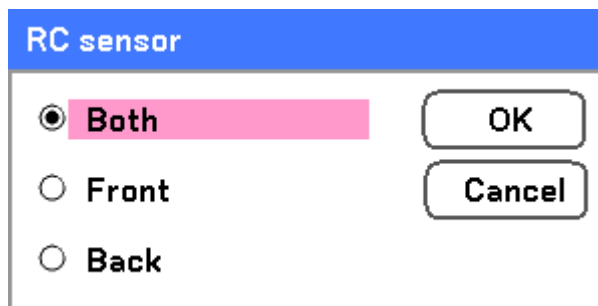

Select from the following:

- Both
- Front
- Back

5. Using On-Screen Display

Network Setting

See Network setting on page 82.

Standby mode

There are two standby modes available: Normal and Power-saving. Power-saving mode allows you to put the projector in the standby condition to consume less power than Normal.

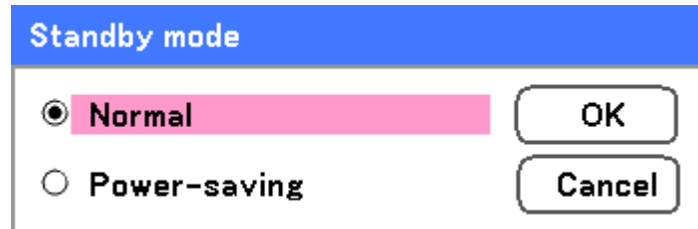

Note:

Be sure to connect the projector and computer while the projector is in standby mode and before turning on the computer.

Select from the following:

- Normal
- Power-saving

Note:

The HTTP server functions are not available during Power-saving mode.

The MONITOR OUT function is not available during Power-saving mode.

Control through the PC Control connector and Network mode is not available during Power-saving mode. For PC control and Network mode of the projector it is recommended to leave the projector in the Normal mode.

Normal mode:	POWER indicator: Orange light WARNING indicator: Green light
Power-saving mode:	POWER indicator: Orange light WARNING indicator: Off

PC control

This function enables you to select the path for PC control (see ⑤ PC Control Codes and Cable Connections on page 115).

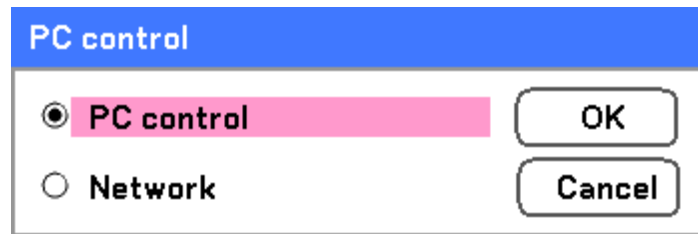

The image shows a dialog box titled "PC control" with a blue header. Inside the dialog, there are two radio button options: "PC control" (which is selected and highlighted with a pink background) and "Network". To the right of the options are two buttons: "OK" and "Cancel".

Note:

In the Network mode, Communication Speed function is not available.

Select from the following:

- PC control
- Network

5. Using On-Screen Display

Network setting

The Network setting tab is accessed by using the Setup/Installation tab and contains the general LAN settings.

Network setting

Setting

DHCP Enable Disable

IP address 172 . 16 . 7 . 15

Subnet 255 . 255 . 255 . 0

Gateway Enable Disable

 172 . 16 . 7 . 201

DNS Enable Disable

 172 . 16 . 1 . 84

Network PIN code 0 0 0 0

Apply settings ↵

exit: **CANCEL** Simple menu Off

The following table lists all functions with a description and the default setting.

ITEM	DESCRIPTION
DHCP	Select either a static IP or DHCP IP setting by selecting the appropriate radio button.
IP address	Displays the IP address.
Subnet	Displays the subnet mask.
Gateway	Enable or disable the network gateway setting. Click on the radio button to change the setting.
DNS	Enable or disable the DNS server settings. Click on the radio button to change the setting.
Network PIN code	A password can be set to restrict access to the setting pages of the projector using the web browser. The default password is "0000". Range: 0000 ~ 9999
Apply settings	Apply and save settings.

Option

The Option tab contains miscellaneous setup menu settings such as Power Management and Default Input Select and can be accessed by using the Setting Menu.

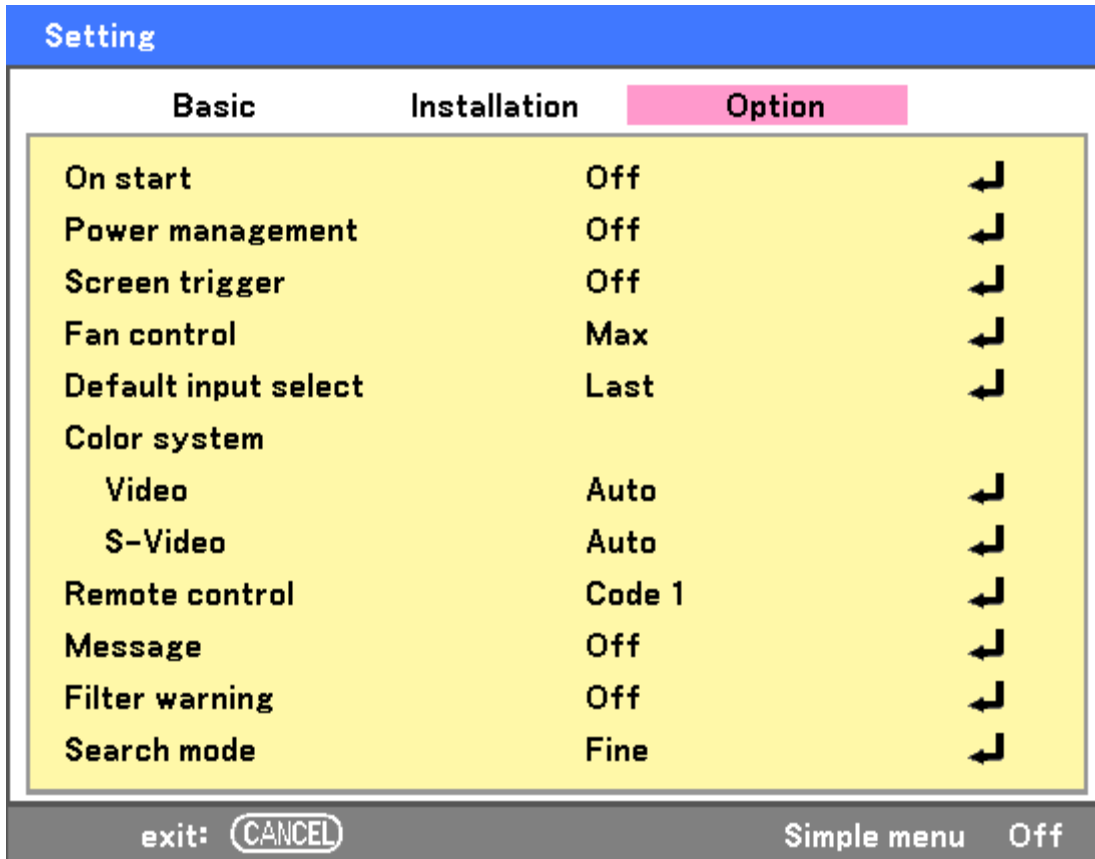

The following table lists all functions with a description and the default setting.

ITEM	DESCRIPTION
On start	Set this item on to enable the projector to power up when AC plug in. Range: On or Off
Power management	Select the amount of time the projector remains idle before powering down. Range: Off, 0:05, 0:10, 0:20, 0:30
Screen trigger	Set this item to On to enable the projector to automatically lower the projection screen when powering on. Range: On or Off
Fan control	Select Fan control. Range: Normal or Max (see Fan control page 85)
Default input select	Select the default input for projection. Range: Last, Auto, Computer1, Computer2, Computer3, Component, Video, S-Video

5. Using On-Screen Display

ITEM	DESCRIPTION
Remote control	This option switches remote control codes. Range: Code 1, Code 2, Code 3, Code 4, Code 5, Code 6, Code 7, Code 8
Message	This option turns on or off messages. Range: Off or On
Filter warning	Set this item to on to have the projector display a message when the air filter needs servicing. Range: Off, 100[H], 200[H], 500[H], 1000[H]
Search mode	This feature sets the Auto Adjust mode. Range: Normal, Fine

On start

On start enables the projector to start automatically when the power cable is connected to an active power outlet and the main power switch is on. This eliminates the need to always use the **POWER** (On) button on the remote control or projector cabinet. To use the On start function, you must first press the main power switch to On before connecting the power cable.



Note:

- When the projector is off by using the **POWER** button (or put in the standby mode) and the power cable is disconnected, On start will not activate after power (AC) is applied.
- When the projector is off by using the Direct Power Off function or after the power (AC) is removed (no standby mode), On start will be activated after power (AC) is applied.
- The Direct Power Off function means you can turn off the power (AC) to the projector by using a power strip equipped with a switch and a breaker.

Power management

Power management enables the projector to automatically turn off if there is no signal received by any input.

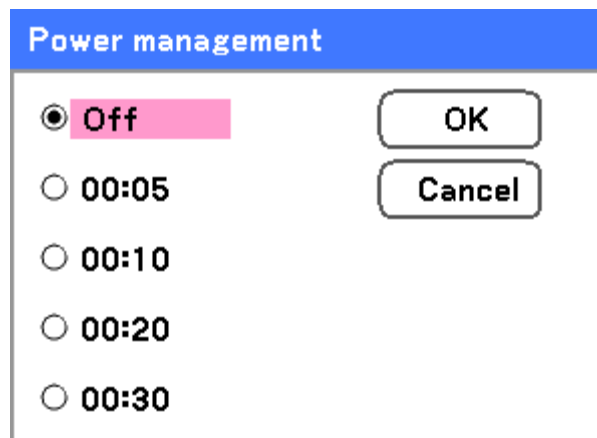

Select from the following:

- Off
- 5 minutes
- 10 minutes
- 20 minutes
- 30 minutes

Screen trigger

Set Screen trigger to On to enable the projector to automatically lower the projection screen when powering on. When powering off, Screen trigger stops sending a low voltage trigger to the screen controller and the screen goes up.

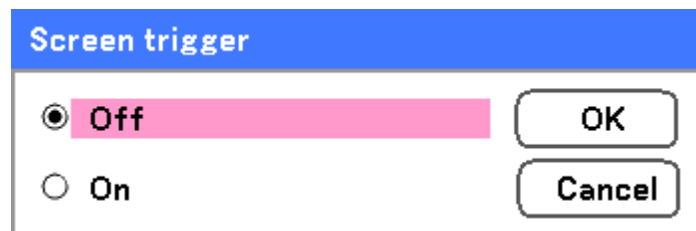

The image shows a menu titled "Screen trigger" with a blue header. Below the header, there are two radio button options: "Off" and "On". The "Off" option is selected, indicated by a filled circle and a pink highlight bar behind the text. To the right of the "Off" option is an "OK" button, and to the right of the "On" option is a "Cancel" button.

Fan control

Fan control is used to set the speed of the internal cooling fan. Set Fan Speed to Max in altitudes over 1500 meters (5000 feet).



The image shows a menu titled "Fan control" with a blue header. Below the header, there are two radio button options: "Normal" and "Max". The "Normal" option is selected, indicated by a filled circle and a pink highlight bar behind the text. To the right of the "Normal" option is an "OK" button, and to the right of the "Max" option is a "Cancel" button.

The Fan control option default is **Normal**, which enables the projector to automatically detect fan requirements. For higher temperature locations or prolonged use, the **Max** option is available to provide greater cooling capacity.

5. Using On-Screen Display

Default input select

The Default input is the image source that the projector will search for automatically on startup.

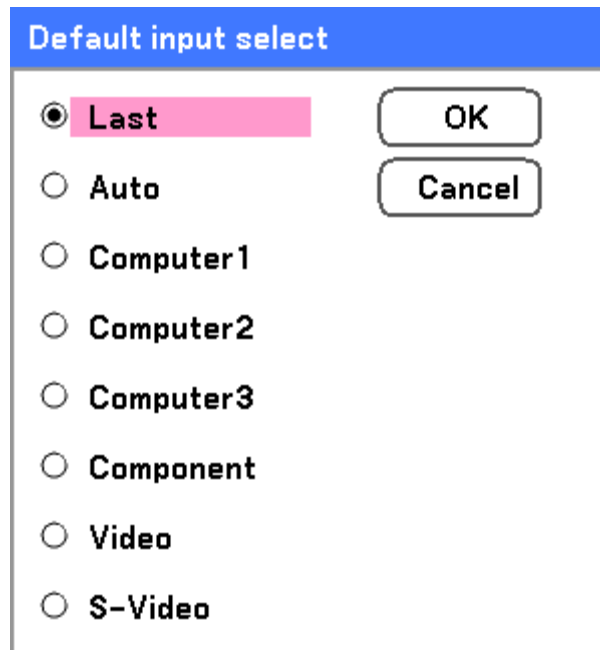

Last – Uses the most recently used image source.

Auto – Auto detects the default image source.

Computer1/2/3 – Uses Computer1, 2 or 3 as the default image source.

Component – Uses last component as the default image source.

Video – Uses last video input as default image source.

S-Video – Uses last S-video input as default image source.

Remote control

This projector has eight different remote control codes; the factory set normal mode (Code 1) and the other seven codes (Code 2 to Code 8). This switching function prevents remote control operation mixture (jam) when operating several projectors or video equipment together.

To change the code of Projector:

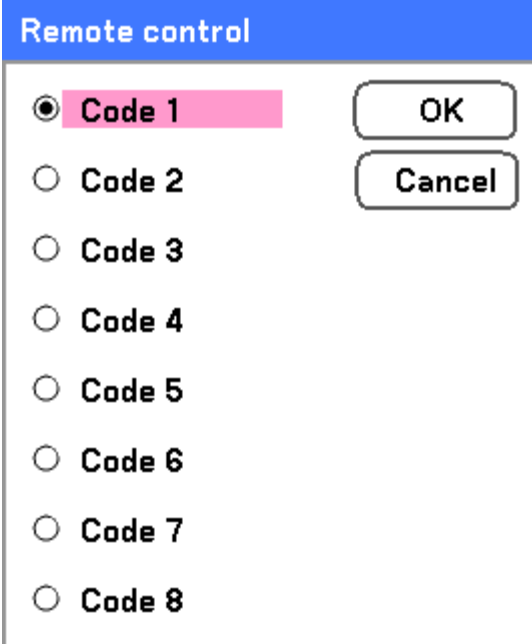

The screenshot shows a menu titled "Remote control" with a blue header. It contains eight radio button options: Code 1, Code 2, Code 3, Code 4, Code 5, Code 6, Code 7, and Code 8. The "Code 1" option is selected and highlighted with a pink background. To the right of the list are two buttons: "OK" and "Cancel".

To change the Remote control code of the projector used in ON SCREEN MENU is selectable from Code 1 to Code 8.

Message

This option turns on or off messages. Even though selecting [Off], the following message will appear. "Projector is locked" when the projector security is unlocked, the message will disappear.



The screenshot shows a menu titled "Message" with a blue header. It contains two radio button options: "Off" and "On". The "Off" option is selected and highlighted with a pink background. To the right of the list are two buttons: "OK" and "Cancel".

5. Using On-Screen Display

Filter warning

Set Filter warning to have the projector display a message when the air filter needs servicing.

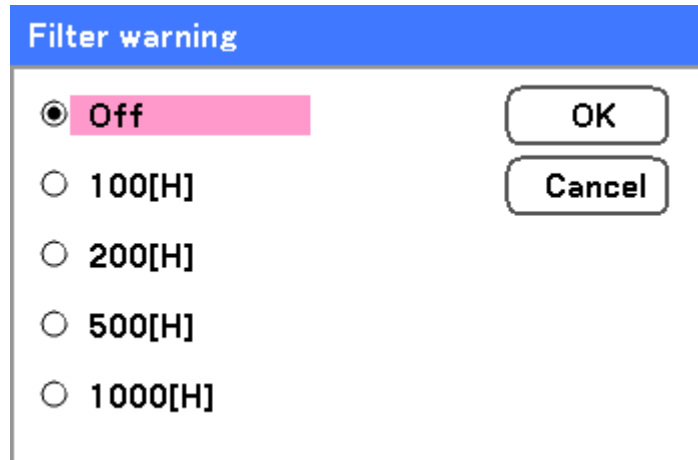

The screenshot shows a menu titled "Filter warning" with a blue header. Below the header, there are five radio button options: "Off", "100[H]", "200[H]", "500[H]", and "1000[H]". The "Off" option is selected and highlighted with a pink bar. To the right of the options are two buttons: "OK" and "Cancel".

The message below shows when this function is activated.

Please clean filter.

Search mode

This feature sets the Auto Adjust mode so that the RGB image can be automatically or manually adjusted for noise and stability. You can automatically make adjustments in two ways: [Normal] and [Fine].



The screenshot shows a menu titled "Search mode" with a blue header. Below the header, there are two radio button options: "Normal" and "Fine". The "Normal" option is selected and highlighted with a pink bar. To the right of the options are two buttons: "OK" and "Cancel".

Normal: The RGB image will be automatically adjusted. Normally select this option (Default).

Fine: Select this option if fine adjustment is needed. It takes more time to switch to the source than the Normal settings.

⑧ Information Menu Descriptions and Functions

The information menu provides only screens for the quick access of menus. The Information menu contains four distinct tabs.

Usage time

The Usage Time tab displays information about lamp usage and remaining lamp life.

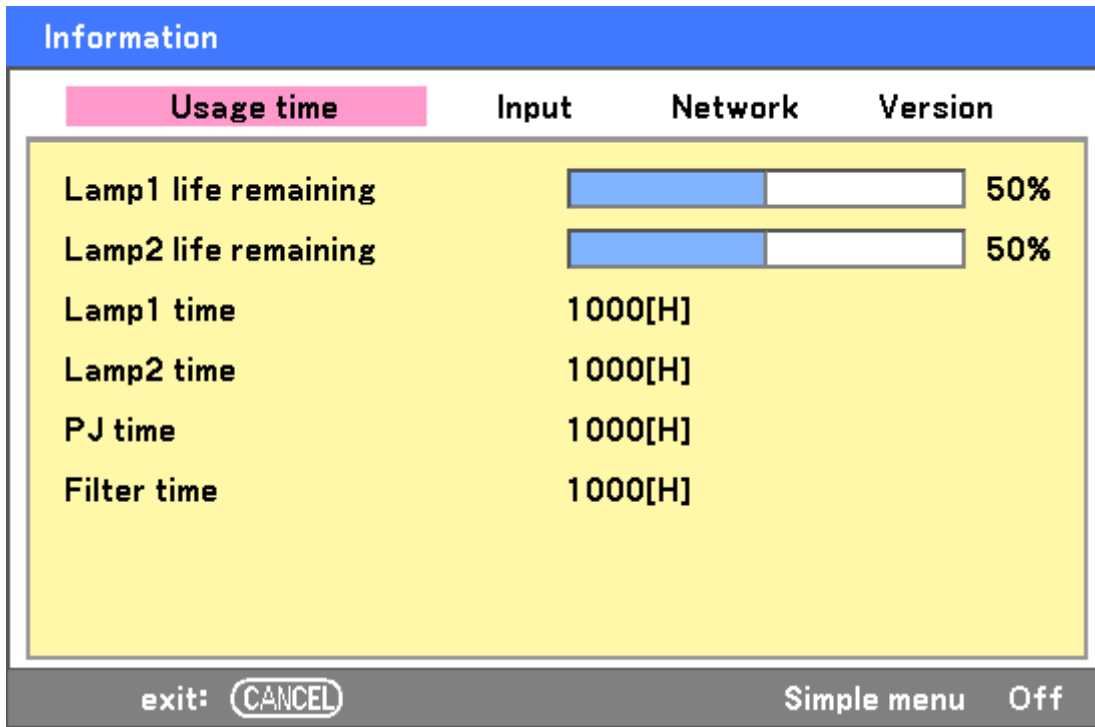

The following table lists all items with a description.

ITEM	DESCRIPTION
Lamp1 Life remaining	Displays the Lamp1 life remaining as a percentage.
Lamp2 Life remaining	Displays the Lamp2 life remaining as a percentage.
Lamp1 time	Displays the Lamp1 total usage in hours.
Lamp2 time	Displays the Lamp2 total usage in hours.
PJ time	Displays the projector total usage in hours.
Filter time	Displays how many hours the filter has been used.

5. Using On-Screen Display

Input

The Input tab displays various source and frequency values at a glance.

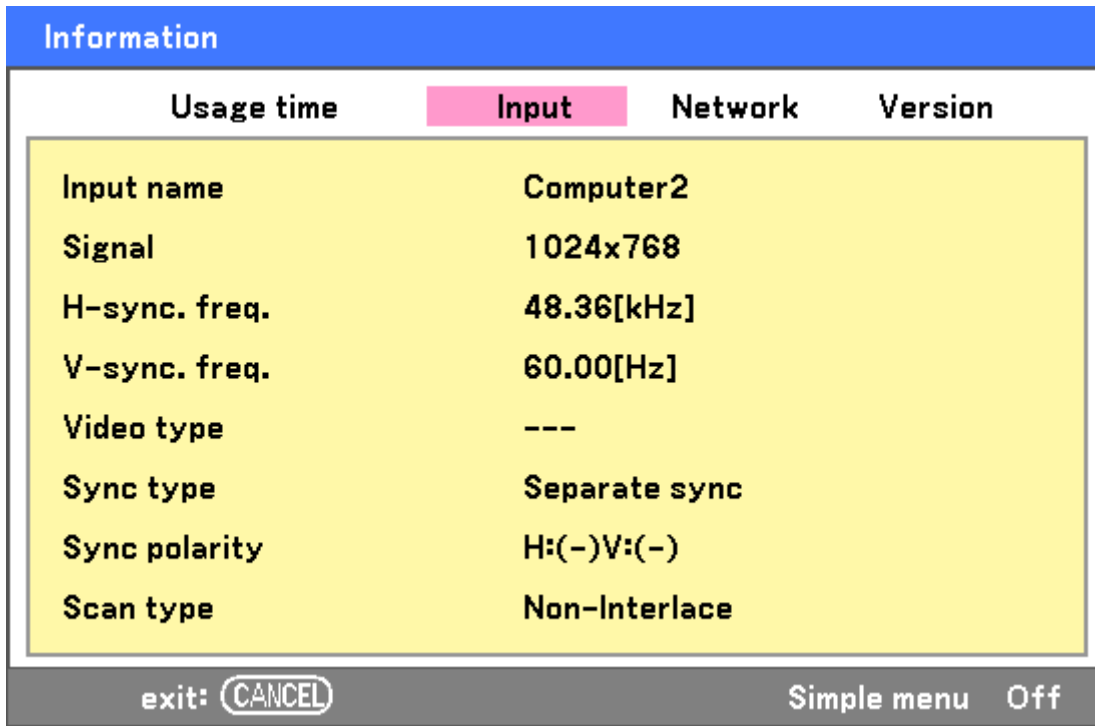

The following table lists all items with a description.

ITEM	DESCRIPTION
Input name	Displays the Input Terminal that is presently being used (see Default input select on page 86).
Signal	Displays the Source name of the signal presently being used (see Option on page 83).
H-sync. freq.	Displays Horizontal frequency in KHz.
V-sync. freq.	Displays Vertical frequency in Hz.
Video type	Displays Video type.
Sync type	Displays Sync type.
Sync polarity	Displays Sync polarity.
Scan type	Displays Scan type.

Network

The Network tab displays LAN settings as previously defined (see Network setting on page 82).

Information			
Usage time	Input	Network	Version
IP address	192.168.10.10		
Subnet	255.255.255.0		
Gateway	0.0.0.0		
MAC address	00:30:13:04:9E:01		

exit: Simple menu Off

5. Using On-Screen Display

Version

The Version tab displays all the version and product details of the projector and associated software (for display only).

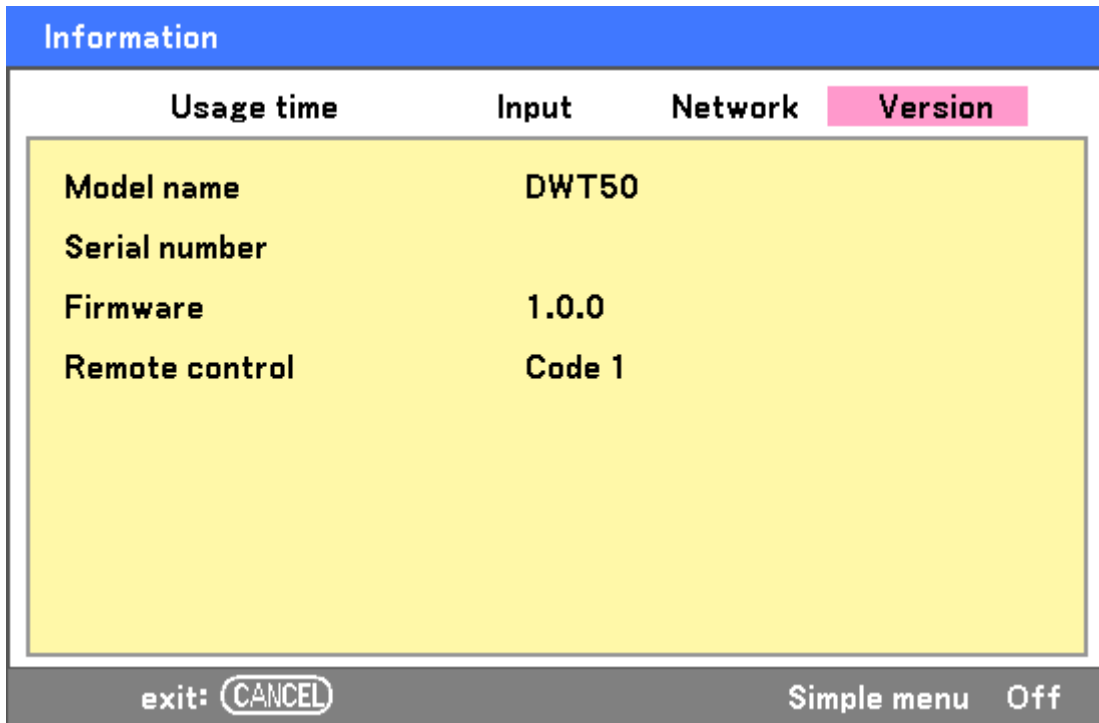

The following table lists all items with a description.

ITEM	DESCRIPTION
Model name	Displays Product ID.
Serial number	Displays projector Serial number.
Firmware	Displays Firmware version and Color Wheel currently installed (4-seg or 6-seg).
Remote control	Displays remote control code.

9 Reset Menu Descriptions and Functions

Occasionally, circumstances may require that factory defaults be reset, for demonstration purposes for example, or when components are replaced.

The Reset menu contains options for returning settings to the factory default and is accessed by using the Main menu.



The following table lists all items with a description.

ITEM	DESCRIPTION	
Current signal	Reset the adjustments for current signal to factory preset levels. All items in Adjust can be reset.	
All data	Resets all options to factory default regardless of when they were changed. Reset all the adjustments and settings for all the signals to the factory preset except Language, Background, Key lock, Security, Network Mode, Communication Speed, Lamp life remaining, Lamp time, and Filter time.	
Clear lamp1 time	Reset lamp1 time	These options should only be used when components are cleaned or replaced (see 6. Maintenance on page 94)
Clear lamp2 time	Reset lamp2 time	
Clear filter time	Reset filter hours	

6. Maintenance

① Cleaning the projector

Cleaning the Cabinet

Refer to the following guide to clean the projector cabinet.

1. Wipe off dust with a clean dampened cloth.
2. Moisten the cloth with warm water and mild detergent and wipe the cabinet.
3. Rinse all detergent from the cloth and wipe the projector again.

CAUTION



To prevent discoloration or fading of the case, do not use abrasive alcohol-based cleaners.

Cleaning the Lens

Refer to the following guide to clean the projector lens.

1. Apply a little optic lens cleaner to a clean, lint free cloth (do not apply the cleaner directly to the lens).
2. Lightly wipe the lens in a circular motion.

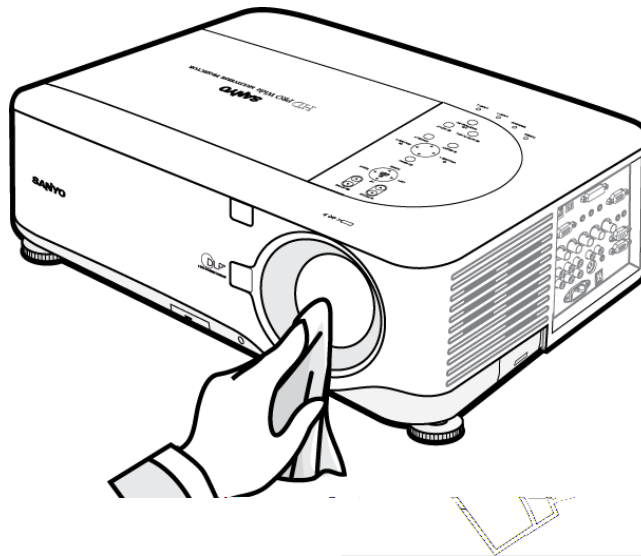

CAUTION



Do not use abrasive cleaners or solvents.

To prevent discoloration or fading, avoid getting cleaner on the projector case.

Cleaning the Filters

The projector uses three filters to keep the fans free of dust and other particles, and should be cleaned every 500 hours of operation. In dusty environments, it is recommended to clean the filters more frequently. If the filter is dirty or clogged, your projector may overheat. When the message below is displayed, the filters must be cleaned.

Please clean filter.

Note:

When the Please clean filter message is displayed, please clean or replace all three filters at the same time to synchronize the Filter time display.

The Filter Message item should be enabled in the Options menu. Refer to Option on page 83.

Refer to the following guide to clean the filters.

1. Lift the projector to expose the underside to locate the first filter.
See the drawing on the right.

Note: Only clean the outside of the exhaust vents with a vacuum cleaner.

2. The left-side filter and intake grille (located in the rear) can be cleaned as demonstrated in the following images.

Bottom view

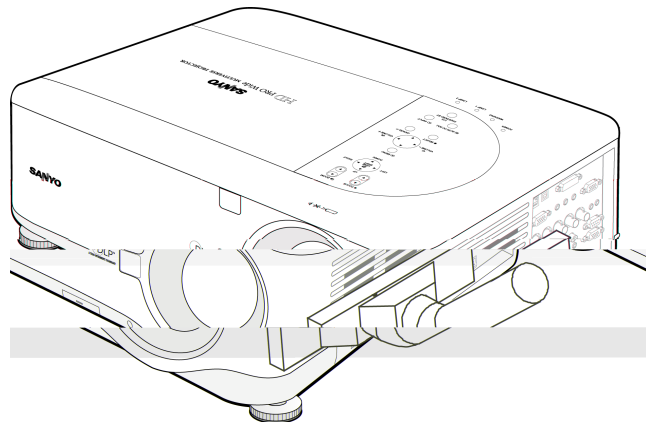
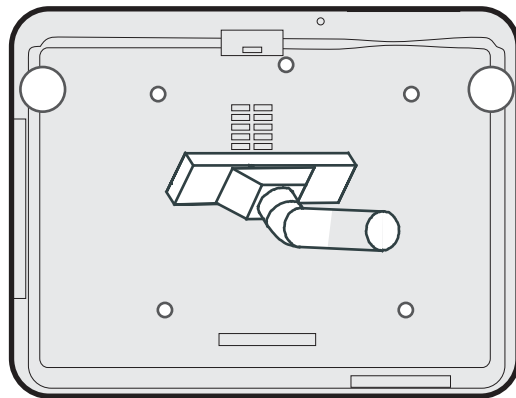

6. Maintenance

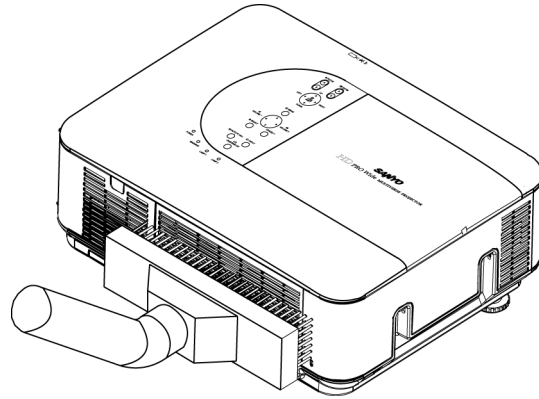

3. The rear filter can be accessed as shown.

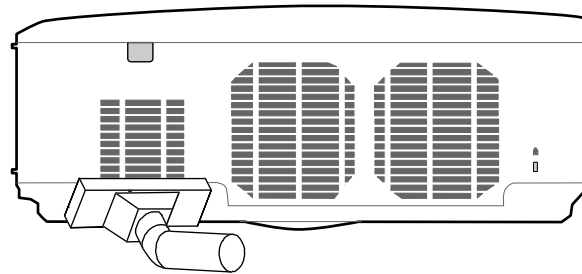

Once the filters are cleaned, please reset the filter hours by using the **Clear filter time** option in the **Reset Menu Descriptions and Functions** on page 93.

Note:

Using the projector without the air filter fitted inside, dirt and dust are sucked into the projector, causing failure.

become worn out resulting in reduced performance. The following parts within the projector quickly and safely.

Note the following:

Disconnect the projector from the power supply.

Turn the projector to the correct position before replacing parts.

Allow the projector to cool before attempting replacing any consumable parts.

Replace the lamp after the projector has been used once.

The projector will display the correct lamp usage hours.

For more information on lamp replacement. See page 24 and 98 for more details.

The fan should also be replaced, not cleaned.

Filters.

Do not touch the fan with your hand or fingers while lifting the projector to replace the filters. Doing so can damage the fan.

The filters are located on the bottom.

Remove the bottom covers in the di-

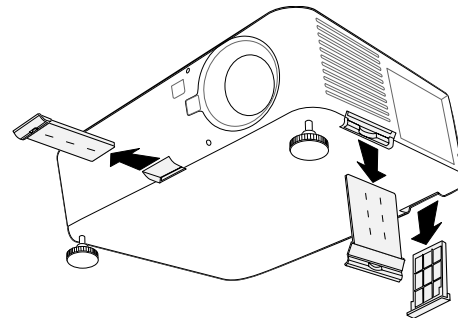

Replacing the Lamps

When a lamp reaches the end of its usable life, the following message is displayed. Replace the lamp.

**The lamp has reached the end of its usable life.
Please replace the lamp.**

The projection lamps should be replaced when they burn out. They should only be replaced with a certified replacement part, contact your local dealer if unsure.

Note:

1. Lamps are positioned differently. Take care not to force the lamps when replacing.
2. Installation of both lamp modules (Lamp 1 and Lamp 2) is required to operate the projector in dual or single lamp mode. If only a single lamp module is installed, the projector's lamp will not turn on and will appear as a lamp failure.
3. Lamps last approximately 2000-2100 hours (2500-2600 hours in Eco mode) and the End of lamp life message is displayed during the lamps' final 100 hours of operational life. Please replace during 2000-2100 hour.

Important:

1. The lamp contains a certain amount of mercury and should be disposed of according to local ordinance regulations.
2. Avoid touching the glass surface of the new lamp: doing so may shorten its operation life.

Lamp Handling Precautions

This projector uses a high-pressure lamp which must be handled carefully and properly. Improper handling may result in accidents, injury, or create a fire hazard.

- Lamp life may differ from lamp to lamp and according to the environment of use. There is no guarantee of the same life for each lamp. Some lamps may fail or terminate their life in a shorter period of time than other similar lamps.
- If the projector indicates that the lamp should be replaced, i.e., if LAMP 1 and/or LAMP 2 light up, replace the lamp with a new one IMMEDIATELY after the projector has cooled down. (Follow carefully the instructions in the Lamp Replacement section of this manual.) Continuous use of the lamp with LAMP 1 and/or LAMP 2 lighted may increase the risk of lamp explosion.
- A Lamp may explode as a result of vibration, shock or degradation as a result of hours of use as its lifetime draws to an end. Risk of explosion may differ according to the environment or conditions in which the projector and lamp are being used.

CAUTION



If a lamp explodes, the following safety precautions should be taken:

Disconnect the projector's AC plug from the AC outlet immediately. Contact an authorized service station for a checkup of the unit and replacement of the lamp. Additionally, check carefully to ensure that there are no broken shards or pieces of glass around the projector or coming out from the cooling air circulation holes. Any broken shards found should be cleaned up carefully. No one should check the inside of the projector except those who are authorized trained technicians and who are familiar with projector service. Inappropriate attempts to service the unit by anyone, especially those who are not appropriately trained to do so, may result in an accident or injury caused by pieces of broken glass.

Resetting the Lamp Time Counter

After replacing the lamp(s), the lamp hour counter(s) should be reset to zero. Refer to the following guide:

1. Press the **Menu** button on the OSD control panel or Remote Control to open the Main menu.

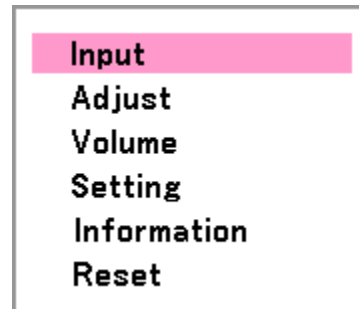

2. Press the **▲** or **▼** button to move to the **Reset** menu and press **Select**.

3. The **Reset** menu is displayed. Select **Clear lamp1 time** or **Clear lamp2 time** as required using **▲** or **▼** and press **Select**.

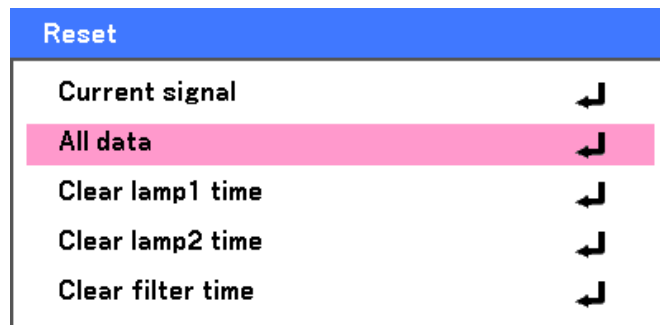

4. A confirmation box is displayed. Select **OK** using **◀** or **▶** and press **Select** to reset the selected Lamp hours to zero.



Ordering a Replacement Lamp

Replacement lamp can be ordered through your dealer. When ordering, give the following information to the dealer.

- Model No. of your projector: PDG-DWT50L, PDG-DWT50KL
- Replacement Lamp Type No: POA-LMP117
(Service Parts No. 610 335 8406)

7. Appendix

❶ Troubleshooting

Indicator Messages

Several indicator messages are used by the projector to alert users of problems with setup or internal parts. The LEDs on the top surface of the projector show the status of the WARNING and lamp 1/2 as well as the general working order of the projector through the WARNING LED (see OSD Controls and Status LEDs on page 7 for location). The following tables describe the various states of the 4 LEDs.

The POWER LED

PROJECTOR STATUS	LED CONDITION	LED SEQUENCE	PROJECTOR CONDITION
AC off	Off	Off	Off
Cooling	Orange blink	0.5 secs on 0.5 secs off	After power off
Power up sequence	Green blink	0.5 secs on 0.5 secs off	Start up
Standby	Orange on	On	Standby
Power on	Green on	On	On

The WARNING LED

PROJECTOR STATUS	LED CONDITION	LED SEQUENCE	PROJECTOR CONDITION
Normal condition	Off	Off	Power on
Cover ERROR	Red 1 time blink (repeatedly)	0.5 secs on 2.5 secs off	ERROR
Temperature ERROR	Red 2 times blink (repeatedly)	(0.5 secs ON > 0.5 secs OFF) * 2 > 2.0 secs OFF	ERROR
Power ERROR	Red 3 times blink	(0.5 secs ON > 0.5 secs OFF) * 3 > 2.0 secs OFF	ERROR
Fan ERROR	Red 4 times blink (repeatedly)	(0.5 secs ON > 0.5 secs OFF) * 4 > 2.0 secs OFF	ERROR
Keylocked (when push key)	Orange light up	On	Keylocked function enabled
Standby (Power-saving)	Off	Off	Standby (Power-saving)
Standby (Normal)	Green light	On	Standby (Normal)

The LAMP LEDs

PROJECTOR STATUS	LED CONDITION	LED SEQUENCE	PROJECTOR CONDITION
Lamp off	Off	Off	Lamp off
End of the lamp life	Red blink	0.5 secs on 0.5 secs off	Replace lamp
No lamp	Red 1 time blink (repeatedly)	0.5 secs on 2.5 secs off	ERROR
Lamp ERROR	Red 6 times blink (repeatedly)	(0.5 secs ON > 0.5 secs OFF) * 6 > 2.0 secs OFF	ERROR
Cooling lamp	Orange blink	0.5 secs ON > 0.5 secs OFF	Switching lamp1 and 2
Re-light up sequence	Green blink	0.5 secs ON > 0.5 secs OFF	Start up
Lamp life over	Red on	On	Replace lamp
Eco mode	Orange on	On	Power on
Normal mode	Green on	On	Power on

Common Problems and Solutions

These guidelines provide tips to deal with problems you may encounter while using the projector. If the problem remains unsolved, contact your dealer for assistance.

Often the problem is something as simple as a loose connection. Check the following before proceeding to the problem-specific solutions.

- Use some other electrical device to confirm that the electrical outlet is working.
- Ensure the projector is turned on.
- Ensure all connections are securely attached.
- Ensure the attached device is turned on.
- Ensure a connected PC is not in suspend mode.
- Ensure a connected notebook computer is configured for an external display. (This is usually done by pressing an Fn-key combination on the notebook.)

Tips for Troubleshooting

In each problem-specific section, try the steps in the order suggested. This may help you to solve the problem more quickly.

Try to pinpoint the problem to avoid replacing non-defective parts.

For example, if you replace batteries and the problem remains, put the original batteries back and go to the next step.

Keep a record of the steps you take when troubleshooting: The information may be useful when calling for technical support or for passing on to service personnel.

② Image Problems

Problem: No image appears on the screen

1. Verify the settings on your notebook or desktop PC.
2. Turn off all equipment and power up again in the correct order.

Problem: The image is blurred

1. Adjust the **Focus** on the projector.
2. Press the **AUTO PC ADJ.** button on the remote control or projector.
3. Ensure the projector-to-screen distance is within the specified range.
4. Check that the projector lens is clean.
5. Remove the lens cover.

Problem: The image is blurred and distorted

1. Check the WXGA Mode is set to Off (see page 63).
2. When WXGA Mode is set to On, an XGA (1024 x 768) signal may not be recognized. Set WXGA Mode to Off if this occurs. To check if the signal is recognized, go to "Input" under "Information" menu (see page 90).

Problem: The image is wider at the top or bottom (trapezoid effect)

1. Position the projector so it is as perpendicular to the screen as possible.
2. Use the Keystone button on the remote control to correct the problem.

Problem: The image is reversed or upside down

- Check the **Ceiling & Rear** setting on the **Setting** menu of the OSD.

Problem: The image is streaked

1. Set the **Total dots** and **Fine sync.** settings on the **Adjust** menu of the OSD to the default settings.
2. To ensure the problem is not caused by a connected PC's video card, connect to another computer.

Problem: The image is flat with no contrast

1. Adjust the **Contrast** setting on the **Adjust** menu of the OSD.
2. Adjust the **Brightness** setting on the **Adjust** menu of the OSD.

Problem: The color of the projected image does not match the source image.

- Adjust the **Color temp.** and **Gamma** settings on the **Detail setting** menu of the OSD.

Lamp Problems

Problem: There is no light from the projector

1. Check that the power cable is securely connected.
2. Ensure the power source is good by testing with another electrical device.
3. Restart the projector in the correct order and check that the Power LED is green.
4. If you have replaced the lamp recently, try resetting the lamp connections.
5. Replace the lamp module.
6. Remove the lens cap.
7. Put the old lamp back in the projector and have the projector serviced.

7. Appendix

Problem: The lamp goes off

1. Power surges can cause the lamp to turn off. Press the power button twice to turn off the projector. When the Power LED is orange, press the power button.
2. Replace the lamp module.
3. Put the old lamp back in the projector and have the projector serviced.

Remote Control Problems

Problem: The projector does not respond to the remote control

1. Direct the remote control towards remote sensor on the projector.
2. Ensure the path between remote and sensor is not obstructed.
3. Turn off any fluorescent lights in the room.
4. Check the battery polarity.
5. Replace the batteries.
6. Turn off other Infrared-enabled devices in the vicinity.
7. Have the remote control serviced.
8. Ensure that the remote control code conforms to the projector's code.
9. Ensure that the reset switch in the compartment lid on back of the remote control is set to use position.

Audio Problems

Problem: There is no sound

1. Adjust the volume on the remote control.
2. Adjust the volume of the audio source.
3. Check the audio cable connection.
4. Test the source audio output with other speakers.
5. Have the projector serviced.

Problem: The sound is distorted

1. Check the audio cable connection.
2. Test the source audio output with other speakers.
3. Have the projector serviced.

③ Having the Projector Serviced

If you are unable to solve the problem, you should have the projector serviced. Pack the projector in the original carton. Include a description of the problem and a checklist of the steps you took when trying to fix the problem. The information may be useful to the service personnel. Return the projector to the place you purchased it.

8. Specifications

① Projector Specifications

This section provides technical information about the projector's performance.

Optical Specifications

ITEM	DESCRIPTION
Projection system	Single DLP® chip, 4 segment color wheel
Resolution	1280 x 768 pixels* (up to UXGA @ 60 Hz, up to SXGA+ @ 60 Hz on DVI-D)
Lamp	260 W AC (230 W in Eco mode), Dual lamp system
Image size (diagonal)	50" - 200" / 1.27m - 5.08m (LNS-W41) 40" - 500" / 1.02m - 12.7m (LNS-W40, LNS-S40, LNS-T40, LNS-T41)
Lens options	LNS-W41: Power focus, throw ratio 0.77:1, F2.0, f=11.4 mm LNS-W40: Power zoom and focus, throw ratio 1.33-1.79:1, F1.8-2.3, f=19.3-25.8 mm LNS-S40: Power zoom and focus, throw ratio 1.78-2.35:1, F1.7-1.9, f=26-34 mm LNS-T40: Power zoom and focus, throw ratio 2.22-4.43:1, F2.1-2.9, f=32-63 mm LNS-T41: Power zoom and focus, throw ratio 4.43-8.3:1, F2.2-3.1, f=63.5-117.4 mm
Lens shift	Vertical + 0.5V, Horizontal +/- 0.1H (LNS-W40, LNS-S40, LNS-T40, LNS-T41)

*Effective pixels are more than 99.99%

8. Specifications

Electrical Specifications

ITEM	DESCRIPTION
Inputs	1 Analog RGB (Mini D-Sub 15P), 1 Analog RGB R/Cr, G/Y, B/Cb, H, V (BNC x 5), 1 Digital RGB (DVI-D 24P), 1 Component Y, Cb/Pb, Cr/Pr (RCA x 3), 1 Component (Mini D-Sub 15P) shared with COMPUTER 1 IN, 1 S-Video (Mini DIN 4P), 1 Video, 3 Stereo Mini Audio, 2 (L/R) RCA Audio, 1 Remote Control (Stereo Mini)
Outputs	1 RGB (Mini D-Sub 15P), 1 Stereo Mini Audio, 1 Screen Trigger
Control	1 PC Control Port (D-Sub 9P), 1 GPIO (Mini D-sub 15P)
USB Port	1 B Type (for Service)
LAN Port	RJ-45
Video Compatibility	NTSC, NTSC4.43, PAL, PAL-60/N/M/B/G/H/I), SECAM, HDTV: 1080i, 720p, SDTV: 576p, 576i, 480p, 480i
Scan Rate	Horizontal: 15 kHz, 31 to 90 kHz (RGB: 31 kHz or over) Vertical: 50 Hz to 85 Hz
Video Bandwidth	RGB: 100 MHz (-3dB)
Color Reproduction	16.7 million colors simultaneously, Full color
Horizontal Resolution	NTSC / NTSC4.43 / PAL / PAL-M / PAL-N / PAL60: 540 TV lines SECAM: 300 TV lines RGB: 1280 dots (H) x 768 dots (V)
External Control	RS232, IR, LAN, GPIO
Sync Compatibility	Separate Sync / Composite Sync / Sync on G
Built-in Speakers	3W x 2
Power Requirement	100 - 240V AC, 50/60Hz
Input Current	7.7A

ITEM	DESCRIPTION
Power Consumption	655W in Dual Lamp Normal mode / 580W in Dual Lamp Eco mode 350W in Single Lamp Normal mode / 315W in Single Lamp Eco mode < 30W in Standby mode Normal < 5W in Standby mode Power saving

Mechanical Specifications

ITEM	DESCRIPTION
Dimensions	19.9" (W) x 7.6" (H) x 15.2" (D) 505 mm (W) x 192 mm (H) x 385 mm (D) (not including protrusions)
Weight	36.3 lbs/16.5 kg

Environmental Considerations

ITEM	DESCRIPTION
Operational Temperatures	41° to 104°F / 5° to 40°C, 10% to 90% humidity (non-condensing)
Storage Temperatures	14° to 140°F (-10° to 60°C), 5% to 90% humidity (non-condensing)

Regulations

UL/C-UL Approved (UL 60950-1, CSA 60950-1)

CB (IEC60950-1) Approved

Meets FCC Class B requirements

Meets DOC Canada Class B requirements

Meets AS/NZS CISPR.22 Class B

Meets EMC Directive (EN55022, EN55024, EN61000-3-2, EN61000-3-3)

Meets C-TICK (AS/NZS CISPR.22 Class B)

Meets Korea EK

Meets Low Voltage Directive (EN60950-1, TÜV GS Approved)

8. Specifications

Optional Parts

The parts listed below are optionally available. When ordering those parts, specify the item name and Model No. to the sales dealer.

Standard Zoom Lens	: LNS-S40
Long Zoom Lens	: LNS-T40
Ultra Long Zoom Lens	: LNS-T41
Short Zoom Lens	: LNS-W40
Fixed Short Zoom Lens	: LNS-W41
Six-segment Color Wheel	: POA-CW01
Wired Remote Cable (30m)	: POA-CA-RC30

8. Specifications

③ Pin Assignments of Mini D-Sub 15 Pin Input Connector

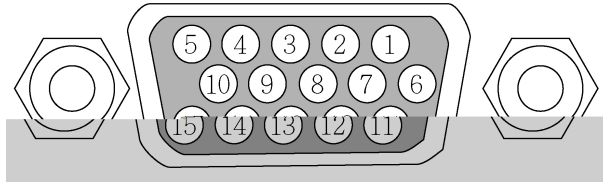

Signal Levels

Video signal: 0.7Vp-p (Analog)

Sync signal: TTL level

PIN NUMBER	RGB SIGNAL (ANALOG)	YCbCr SIGNAL
1	Red	Cr
2	Green or Sync on Green	Y
3	Blue	Cb
4	Ground	
5	Ground	
6	Red Ground	Cr Ground
7	Green Ground	Y Ground
8	Blue Ground	Cb Ground
9	No Connection	
10	Sync Signal Ground	
11	No Connection	
12	Bi-directional DATA (SDA)	
13	Horizontal Sync or Composite Sync	
14	Vertical Sync	
15	Data Clock	

④ Compatible Input Signal List

The following table shows compatible signal types, their resolution and frequency refresh rates.

Horizontal: 15kHz, 31kHz to 90 kHz

Vertical: 50 Hz to 85 Hz

Signal	Resolution	H-Sync [KHz]	V-Sync [Hz]	Component	Video	RGB	DVI
VGA	640 x 350	31.5	70.1	--	--	0	0
VESA(DMT)	640 x 350	37.9	85.1	--	--	0	0
	720 x 350	31.5	70.0	--	--	0	0
CGA84	640 x 400	31.5	70.1	--	--	0	0
VESA(DMT)	640 x 400	37.9	85.1	--	--	0	0
	720 x 400	31.5	70.0	--	--	0	0
VESA(DMT)	720 x 400	37.9	85.0	--	--	0	0
SMT	720 x 480	31.5	60.0	--	--	0	0
SMT	640 x 480	31.5	60.0	--	--	0	0
VESA	640 x 480	37.9	72.8	--	--	0	0
VESA(DMT)	640 x 480	37.5	75.0	--	--	0	0
VESA(DMT)	640 x 480	43.3	85.0	--	--	0	0
VESA	800 x 600	35.2	56.3	--	--	0	0
VESA	800 x 600	37.9	60.3	--	--	0	0
VESA	800 x 600	46.9	75.0	--	--	0	0
VESA(DMT)	800 x 600	48.1	72.2	--	--	0	0
VESA(DMT)	800 x 600	53.7	85.1	--	--	0	0
	1024 x 768i	35.5	43.0	--	--	0	0
VESA	1024 x 768	48.4	60.0	--	--	0	0
VESA	1024 x 768	56.5	70.1	--	--	0	0
VESA(DMT)	1024 x 768	60.0	75.0	--	--	0	0
VESA(DMT)	1024 x 768	68.7	85.0	--	--	0	0
VESA(DMT)	1152 x 864	67.5	75.0	--	--	0	0
	1280 x 720	37.5	50	--	--	0	0
	1280 x 720	45	60	--	--	0	0
DMT	1280 x 768	47.4	60.0	--	--	0	0
DMT	1280 x 768	47.8	60.0	--	--	0	0
DMT	1280 x 768	60.3	75.0	--	--	0	0
DMT	1280 x 768	68.6	85.0	--	--	0	0
	1280 x 800	41.2	50	--	--	0	0
DMT	1280 x 800	49.7	60	--	--	0	0
	1280 x 800	49.6	60.05	--	--	0	0
DMT	1280 x 800	62.8	75	--	--	0	0
DMT	1280 x 800	71.6	85	--	--	0	0
VESA(DMT)	1280 x 960	60.0	60.0	--	--	0	0
VESA(DMT)	1280 x 960	85.9	85.0	--	--	0	0
VESA(DMT)	1280 x 1024	64.0	60.0	--	--	0	0
VESA(DMT)	1280 x 1024	80.0	75.0	--	--	0	0
VESA(DMT)	1280 x 1024	91.1	85	--	--	0	0
	1360 x 768	47.7	60.0	--	--	0	0

8. Specifications

	1366 x 768	48.36	60	--	--	○	○
	1376 x 768	48.36	60	--	--	○	○
DMT	1400 x 1050	64.7	60.0	--	--	○	○
DMT	1400 x 1050	65.3	60.0	--	--	○	○
DMT	1400 x 1050	82.3	75.0	--	--	○	○
CVT	1440 x 900	55.9	60.0	--	--	○	○
CVT	1440 x 900	70.6	75.0	--	--	○	○
CVT	1440 x 900	80.4	85.0	--	--	○	○
VESA(DMT)	1600 x 1200	75.0	60.0	--	--	○	○
CVT	1680 x 1050	65.3	60.0	--	--	○	○
1035i	1920x1035i	33.75	60	--	--	○	○
D-1080p/30	1920 x 1080	33.75	30	--	--	○	○
D-1080p/25	1920 x 1080	28.125	25	--	--	○	○
D-1080p/24	1920 x 1080	27	24	--	--	○	○
1080P/50	1920 x 1080	56.25	50	--	--	○	○
1080P/60	1920 x 1080	67.5	60	--	--	○	○
CVT	1920 x 1200	74.0	60.0	--	--	○	○
Apple Macintosh	640 x 480	35.0	66.7	--	--	○	○
	832 x 624	49.7	74.5	--	--	○	○
	1024 x 768	60.2	74.9	--	--	○	○
	1152 x 870	68.7	75.1	--	--	○	○
NTSC/NTSC4.43	Chroma Sub-carrier Frequency, 3.58 MHz & 4.43 MHz			--	○	--	--
PAL	CCIR, Chroma Sub-carrier Frequency, 4.43 MHz			--	○	--	--
SECAM	CCIR Sub-carrier frequency, 4.25/4.4 MHz			--	○	--	--
SDTV	480i	15.8	60.0	○	--	--	--
	576i	15.6	50.0	○	--	--	--
EDTV	480p	31.5	60.0	○	--	--	--
	576p	31.3	50.0	○	--	--	--
HDTV	720p	45.0	60.0	○	--	--	--
	720p	37.5	50.0	○	--	--	--
	1080i	33.8	60.0	○	--	○	○
	1080i	28.1	50.0	○	--	○	○

○ : Supported frequency

-- : Not Supported frequency

Note:

Character "i" that follows the number of displayed dots stands for interlace signal.

Flicker (line flicker) occurs in images if interlace signals are connected.

An image with higher or lower resolution than the projector's native resolution (1280 x 768) will be compressed.

Some Composite and Sync on Green signals may not be displayed correctly.

Signals other than those specified in the table above may not display correctly. If this should happen, change the refresh rate or resolution on your PC. Refer to the Display Properties help section of your PC for procedures.

5 PC Control Codes and Cable Connections

This projector provides a function to control and monitor the projector's operations by using the RS-232C serial port.

1. Connect a RS-232C serial cross cable to SERIAL PORT IN on the projector and serial port on the PC.
2. Launch a communication software provided with PC and setup the communication condition as follows:

Baud rate	: 38400 bps
Parity check	: none
Stop bit	: 1
Flow control	: none
Data bit	: 8

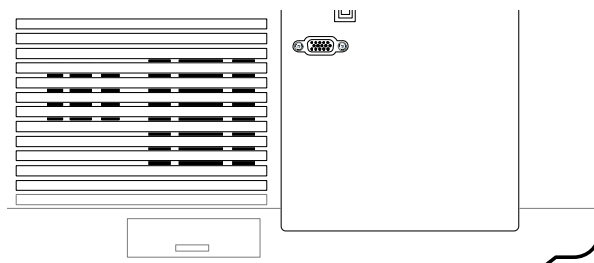

Type the command for controlling the projector and then enter the "Enter" key.

8. Specifications

Status Read Command Table

COMMAND	FUNCTION
CR0	Status Read
CR6	Temperature Read

PC Control Connector (DIN-9P)

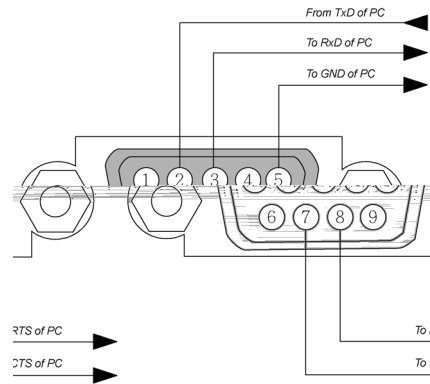

Note:

1. Pin 1, 4, 6 and 9 are not used.
2. Jumper "Request to Send" and "Clear to Send" together on both ends of the cable to simplify the cable connection.
3. For long cables, it is recommended to set communication speed within projector menus to 9600 bps.

⑥ Screen Trigger

When the projector is powered ON the screen trigger output sends a low voltage trigger to the screen controller and the screen will go down. When the projector is powered OFF the screen trigger stops sending a low voltage trigger to the screen controller and the screen will go up.

Note:

To use this feature, you must turn on the Screen Trigger function. See Screen Trigger on page 85 for more information.

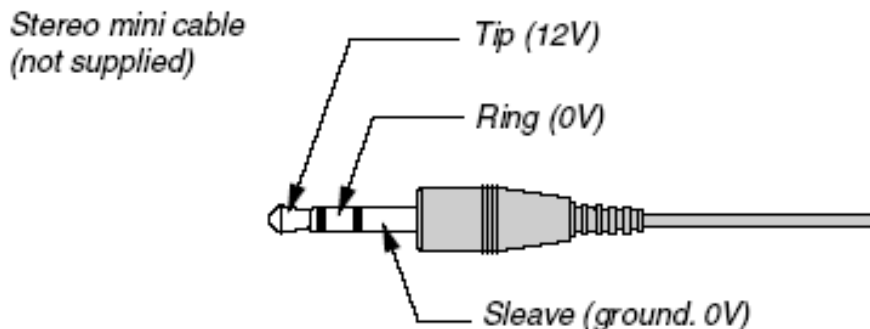

Note:

Screen controllers are supplied and supported by screen manufacturers.

Note:

Do not use this jack for anything other than intended use. Connecting the wired remote control to the SCREEN TRIGGER Mini Jack causes damage to the remote control.

8. Specifications

⑦ Operation Using HTTP Browser

Overview

The use of HTTP server functions will allow control of the projector from a web browser without the installation of special software. Please be sure to use “Microsoft Internet Explorer 4.x” or a higher version for the web browser. (This device uses “JavaScript” and “Cookies” and the browser should be set to accept these functions. The setting method will vary depending on the version of browser. Please refer to the help files and the other information provided in your software).

Access is gained to the HTTP server functions by specifying the following address in the entry column of the URL:

http:// <the projector's IP address> /index.html

http:// <the projector's IP address> /lanconf.html

Note:

The display or button responses can be slowed down or operation may not be accepted depending the settings of your network. Should this happen, consult your network administrator. The projector may not respond if its buttons are repeatedly pressed in rapid intervals. Should this happen, wait a moment and repeat. If you still can't get any response, turn off and back on the projector.

Preparation Before Use

Make network connections, set up the projector and confirm that it is complete before engaging in browser operations (see Network setting on page 80 for more information).

Operation with a browser that uses a proxy server may not be possible depending on the type of proxy server and the setting method. Although the type of proxy server will be a factor, it is possible that items that have actually been set will not be displayed depending on the effectiveness of the cache, and the contents set from the browser may not be reflected in operation. It is recommended that a proxy server not be used unless it is unavoidable.

Handling of the Address for Operation by Using a Browser

Regarding the actual address that is entered for the address or entered to the URL column when operation of the projector is via a browser, the host name can be used as it is when the host name corresponding to the IP address of the projector has been registered to the domain name server by a network administrator, or the host name corresponding to the IP address of the projector has been set in the “HOSTS” file of the computer being used.

Example 1:

When the IP address of the projector is **192.168.73.1**, access is gained to the HTTP server functions by specifying **http://192.168.73.1/index.html** for the address or the entry column of the URL.

Configuring Network Settings

The Network Settings screen is displayed as follows:

http:// <the projector's IP address> /lanconf.html

The screenshot shows the 'PROJECTOR' network settings interface. It is divided into four main sections, each with a title and a set of controls:

- Domain:** Contains two text input fields labeled 'Host Name' and 'Domain Name', and an 'Apply' button below them.
- Mail:** Starts with a radio button selection for 'Alert Mail' (Enable/Disable). Below are four text input fields for 'Sender's Address', 'SMTP Server Name', 'Recipient's Address 1', and 'Recipient's Address 2'. A fifth field for 'Recipient's Address 3' is partially visible. An 'Apply' button is at the bottom.
- Test Mail:** Features an 'Execute' button on the left and a 'Test Mail Status' dropdown menu on the right.
- PJLink:** Includes a radio button selection for 'PJLink' (On/Off) and a 'Password' text input field, with an 'Apply' button below.

Domain

Host Name: Type in a hostname. Up to 60 alphanumeric characters can be used.

Domain Name: Type in domain name of the network connected to the projector. Up to 60 alphanumeric characters can be used.

Apply: Click to reflect the entries.

Mail

Alert Mail: Click "Enable" to enable Alert Mail feature. This option notifies your computer of an error message via e-mail when using wired LAN. The error message will be notified when the projector lamp has reached the end of its usable life or an error occurs in the projector.

Sender's Address: Specify the sender's address. Up to 60 alphanumeric and symbols, characters can be used.

SMTP Server Name: Type in the SMTP server name to be connected to the projector. Up to 60 alphanumeric characters can be used.

Recipient's Address 1 to 3: Type in your recipient's address. Up to 60 alphanumeric and symbols characters can be used.

Apply: Click to apply the settings.

8. Specifications

Test Mail

Send a test mail to check if your settings are correct. Click to "Execute" to enable this feature.

Test Mail Status Button: Click to display the test result.

Sample of a message sent from the projector:

Projector Name: X X X X

Lamp 1 or 2 Hours Used: xxxx [H]

The lamp is at the end of its usable life. Please replace the lamp.

Note:

If you entered an incorrect address in a test, you may not receive an Alert mail. Should this happen, check if the Recipient's Address is correctly set.

Unless any one of the [Sender's Address], [SMTP Server's Name] or [Recipient's Address 1-3] is selected, [Test Mail] is not available.

PJLink

This option allows you to set a password when you use the PJLink feature.

On/Off: Enable or disable the password.

Password: Enter a password (up to 32 characters)

Note:

PJLink is a standardization of protocol used for controlling projectors of different manufacturers. This standard protocol is established by Japan Business Machine and Information System Industries Association (JBMA) in 2005.

The projector supports all the commands of PJLink Class 1.

PROJECTOR INPUT	PJLINK INPUT	PARAMETER
Computer 1	RGB 1	11
Computer 2	RGB 2	12
Video	VIDEO 1	21
S-Video	VIDEO 2	22
Component	VIDEO 3	23
Computer 3	DIGITAL 1	31

The PJLink logo features the letters 'PJ' in a large, bold, stylized font, followed by 'Link' in a standard sans-serif font. A small 'TM' trademark symbol is positioned at the top right of the 'k'.

Structure of the HTTP Server

Once the projector is connected to a network and configured correctly, the following screen is displayed through the web browser.

[http:// <the projector's IP address>/index.html](http://<the projector's IP address>/index.html)



FUNCTION	SETTING	DESCRIPTION
Power Panel	On Off	This controls the power to the projector
Volume Panel	▲ – Increases the volume adjustment value ▼ – Decreases the volume adjustment value	This controls the volume of the projector
Mute Panel	Picture On – Mutes the video Picture Off – Cancels the video muting Sound On – Mutes the audio Sound Off – Cancels the audio muting OSD On – Mutes the on-screen display OSD Off – Cancels the muting of the on-screen display All On – Mutes each of the video, audio, and on-screen display functions All Off – Cancels the muting of each of the video, audio, and on-screen display functions	This controls the mute functions of the projector
Image Panel	Brightness ▲▼ – Increases or decreases the brightness adjustment value Contrast ▲▼ – Increases or decreases the contrast adjustment value Color ▲▼ – Increases or decreases the color adjustment value Tint ▲▼ – Increases or decreases the hue adjustment value Sharpness ▲▼ – Increases or decreases the sharpness adjustment value	Controls the video adjustments of the projector

8. Specifications

FUNCTION	SETTING	DESCRIPTION
Input Select Panel	Computer1 – Switches to the COMPUTER 1 IN connector Computer2 – Switches to the COMPUTER 2 IN connector Computer3 – Switches to the COMPUTER 3 IN connector Component – Switches to the COMPONENT IN connectors Video – Switches to the VIDEO IN connector S-Video – Switches to the S-VIDEO IN connector	This switches the input connector of the projector
Projector Status Panel	Refresh – Updates the panel with the latest information available Lamp1 life remaining – Displays the remaining life of Lamp 1 as a percentage Lamp2 life remaining – Displays the remaining life of Lamp 2 as a percentage Lamp1 time – Displays the number of hours Lamp 1 has been used Lamp2 time – Displays the number of hours Lamp 2 has been used PJ time – Displays the number of hours the project has been used Error Status – Displays the status of errors occurring within the projector	This displays the status of selected projector functions

Note:

The functions that can be controlled will vary depending on the signal being input to the projector (see [Selecting an Input Source](#) on page 34 for more information).

⑧ 15 Pin GPIO Control

Type: 15Pin D-SUB black female type

PIN No.	SHORT/OPEN				FUNCTION
14	SHORT OPEN				EXTERNAL CONTROL MODE ON EXTERNAL CONTROL MODE OFF
5	SHORT OPEN				POWER ON POWER OFF
10	SHORT OPEN				PICTURE MUTE ON PICTURE MUTE OFF
3	SHORT OPEN				SOUND MUTE ON SOUND MUTE OFF
4, 8, 12, 11	11	12	8	4	
	OPEN	OPEN	OPEN	OPEN	COMPUTER1
	OPEN	OPEN	OPEN	SHORT	VIDEO1
	OPEN	OPEN	SHORT	OPEN	S-VIDEO1
	OPEN	OPEN	SHORT	SHORT	COMPONENT
	OPEN	SHORT	OPEN	OPEN	NOT AVAILABLE
	OPEN	SHORT	OPEN	SHORT	COMPUTER2
	OPEN	SHORT	SHORT	OPEN	NOT AVAILABLE
	OPEN	SHORT	SHORT	SHORT	NOT AVAILABLE
	SHORT	OPEN	OPEN	OPEN	COMPUTER3 (DVI)
	SHORT	OPEN	OPEN	SHORT	NOT AVAILABLE
	SHORT	OPEN	SHORT	OPEN	NOT AVAILABLE
	SHORT	OPEN	SHORT	SHORT	NOT AVAILABLE
	SHORT	SHORT	OPEN	OPEN	NOT AVAILABLE
	SHORT	SHORT	OPEN	SHORT	NOT AVAILABLE
	SHORT	SHORT	SHORT	OPEN	NOT AVAILABLE
	SHORT	SHORT	SHORT	SHORT	NOT AVAILABLE

Note:

The term "SHORT" is defined as having a connection to pin 15.

9. Troubleshooting Check List

Before contacting your dealer or service personnel, check the following list to be sure repairs are needed also by referring to the ● Troubleshooting section on page 102 of your user's manual. This checklist below will help us solve your problem more efficiently.

Frequency of Occurrence always sometimes (How often? _____) other (_____)

Power

- No power (POWER indicator does not light green) See also "Status Indicator (WARNING)".
 - Power cable's plug is fully inserted into the wall outlet.
 - Main power switch is pressed to the ON position.
 - Lamp cover is installed correctly.
 - Lamp Time (lamp operation hours) was cleared after lamp replacement.
- Shut down during operation.
 - Power cable's plug is fully inserted into the wall outlet.
 - Lamp cover is installed correctly.
 - Power Management is turned off.

Video and Audio

- No image is displayed from your PC or video equipment to the projector.
 - Still no image even though you connect the projector to the PC first, then start the PC.
 - Enabling your notebook PC's signal output to the projector.
 - A combination of function keys will enable/disable the external display. Usually, the combination of the "Fn" key along with one of the 12 function keys turns the external display on or off.
 - No image (blue background, logo, no display).
 - Still no image even though you press the AUTO PC ADJ. button.
 - Still no image even though you carry out [Reset] in the projector's menu.
 - Signal cable's plug is fully inserted into the input connector
 - A message appears on the screen.
(_____)
The source connected to the projector is active and available.
 - Still no image even though you adjust the brightness and/or the contrast.
 - Input source's resolution and frequency are supported by the projector.
- Image is too dark.
 - Remains unchanged even though you adjust the brightness and/or the contrast.
- Image is distorted.
 - Image appears to be trapezoidal (unchanged even though you carry out the [Keystone] adjustment).
- Parts of the image are lost.
 - Still unchanged even though you press the AUTO PC ADJ. button.
 - Still unchanged even though you carry out [Reset] in the projector's menu.
- Image is shifted in the vertical or horizontal direction.
 - Horizontal and vertical positions are correctly adjusted on a computer signal.
 - Input source's resolution and frequency are supported by the projector.
 - Some pixels are lost.
- Image is flickering.
 - Still unchanged even though you press the AUTO PC ADJ. button.
 - Still unchanged even though you carry out [Reset] in the projector's menu.
 - Image shows flickering or color drift on a computer signal.
- Image appears blurry or out of focus.
 - Still unchanged even though you checked the signal's resolution on PC and changed it to projector's native resolution.
 - Still unchanged even though you adjusted the focus.
- No sound.
 - Audio cable is correctly connected to the audio input of the projector.
 - Still unchanged even though you adjusted the volume level.
 - AUDIO OUT is connected to your audio equipment.

Other

- Remote control does not work.
 - No obstacles between the sensor of the projector and the remote control.
 - Projector is placed near a fluorescent light that can disturb the infrared remote controls.
 - Batteries are new and are not reversed in installation.
 - The remote control code conforms to the projector's code.
- Buttons on the projector cabinet do not work.
 - Control Panel Lock is not turned on or is disabled in the menu.
 - Still unchanged even though you press and hold the CANCEL button for a minimum of 10 seconds.

KW3AL



SANYO Electric Co., Ltd.

Free Manuals Download Website

<http://myh66.com>

<http://usermanuals.us>

<http://www.somanuals.com>

<http://www.4manuals.cc>

<http://www.manual-lib.com>

<http://www.404manual.com>

<http://www.luxmanual.com>

<http://aubethermostatmanual.com>

Golf course search by state

<http://golfingnear.com>

Email search by domain

<http://emailbydomain.com>

Auto manuals search

<http://auto.somanuals.com>

TV manuals search

<http://tv.somanuals.com>