

OPERATING INSTRUCTIONS

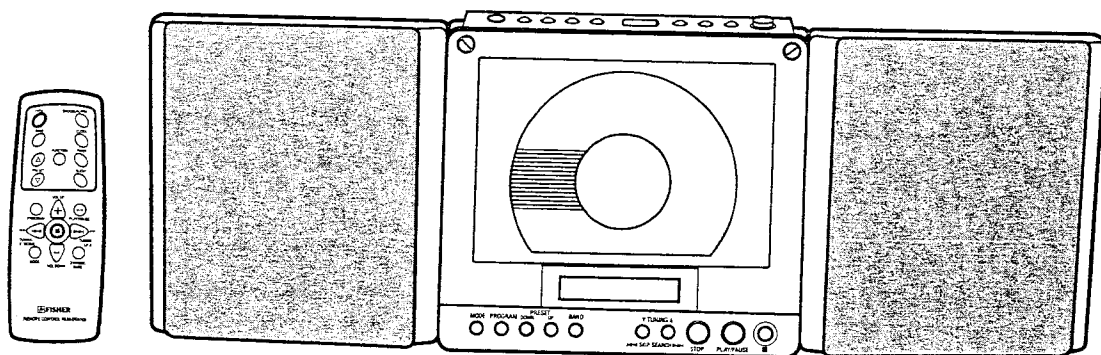

PH-DTA100

Desktop Audio System



FISHER'S HELP-LINE

Call the toll-free number below if you have any difficulties operating this product.
1-800-421-6382 (Weekdays 8:00 AM - 5:00 PM, Pacific Time)

1AD6P1P1372-- PH-DTA100, Issue Number 1

Download from Www.Somanuals.com. All Manuals Search And Download.

English

CONTENTS

Safety certification	E2
For safe and efficient operation	E3
Speaker system connections	E4
Place picture	E5
Power supply	E5
Remote control	E6
Adjusting the clock	E7
Common operation	E8
Compact disc operation	
CD play	E9
Selecting Various Playing Mode	E12
Programmed play	E13
Radio operation	
Frequency up/down tuning	E14
Manual preset tuning	E15
Timer operation	
Timer	E16
10 min interval alarm	E17
Snooze	E17
Sleep	E18
Remote control operation	E19
Maintenance	E20
Troubleshooting guide	E21
Warranty	E22

WARNING:

UNAUTHORIZED RECORDING OF COPYRIGHT MATERIAL MAY VIOLATE APPLICABLE COPYRIGHT LAWS. THE MANUFACTURER ASSUMES NO RESPONSIBILITY FOR UNAUTHORIZED DUPLICATION, USE OR OTHER ACTS WHICH INFRINGE UPON THE RIGHTS OF COPYRIGHT OWNERS.

SAFETY CERTIFICATION

This unit is made and tested to meet exacting safety standards. It meets FCC requirements and complies with safety performance standards of the U.S. Department of Health and Human Services.

CAUTION - USE OF CONTROLS OR ADJUSTMENTS OR PERFORMANCE OF PROCEDURES OTHER THAN THOSE SPECIFIED HEREIN MAY RESULT IN HAZARDOUS RADIATION EXPOSURE.

THIS UNIT SHOULD NOT BE ADJUSTED OR REPAIRED BY ANYONE EXCEPT PROPERLY QUALIFIED SERVICE PERSONNEL.

FCC INFORMATION

This device complies with Part 15 of the FCC Rules.

Operation is subject to the following two conditions:

(1) This device may not cause harmful interference, and (2) this device must accept any interference received, including interference that may cause undesired operation.

CAUTION:

Changes or modifications not expressly approved by Fisher may void the user's authority to operate this equipment.

NOTE:

This equipment has been tested and found to comply with the limits for a Class B digital device, pursuant to Part 15 of the FCC Rules. These limits are designed to provide reasonable protection against harmful interference in a residential installation. This equipment generates, uses and can radiate radio frequency energy and, if not installed and used in accordance with the instructions, may cause harmful interference to radio communications. However, there is no guarantee that interference will not occur in a particular installation. If this equipment does cause harmful interference to radio or television reception, which can be determined by turning the equipment off and on, the user is encouraged to try to correct the interference by one or more of the following measures:

- Reorient or relocate the receiving antenna.
- Increase the separation between the equipment and receiver.
- Connect the equipment into an outlet on a circuit different from that to which the receiver is connected.
- Consult the dealer or an experienced radio/TV technician for help.



FOR SAFE AND EFFICIENT OPERATION

- Use this only with the supplied AC adaptor. Other AC adaptors could damage the unit. Do not touch the AC adaptor with wet hands. Doing so is dangerous, as this could result in an electrical shock.
- If water should enter the unit, electrical shock or a malfunction may result. Use in an area where there is low humidity and little dust.
- Do not disassemble or alter the unit in any way.
- Do not use the unit in areas where extremes in temperature occur (below 40°F or exceeding 95°F), or where it may be exposed to direct sunlight.
- Because of the CD player's extremely low noise and wide dynamic range, there is a tendency to turn the volume on the amplifier higher than necessary. Doing so may produce an excessively high output from the amplifier which can cause damage to your speakers. Please be careful in this regard.
- Sudden changes in the surrounding temperature can cause dew to form on the optical pickup lens inside the unit. Under this condition the unit may be unable to operate properly. If this should occur, remove the disc and allow the player to adjust to the surrounding temperature.
- **The speaker uses a strong magnet. Keep it away from TV, cards with magnetically coded strips, and etc.**

WHAT TO DO IF

If the operation of the unit or display is not normal, even though the appropriate buttons have been pressed.

1. Disconnect the AC adaptor.
2. Wait for at least 30 seconds.
3. Connect the AC adaptor again.
4. Press [⏻/ON] to turn on the power.
5. Press the desired function button.

NOTE:

If the unit does not operate correctly, please contact your nearest Fisher Authorized Service Center.

SPEAKER SYSTEM CONNECTIONS

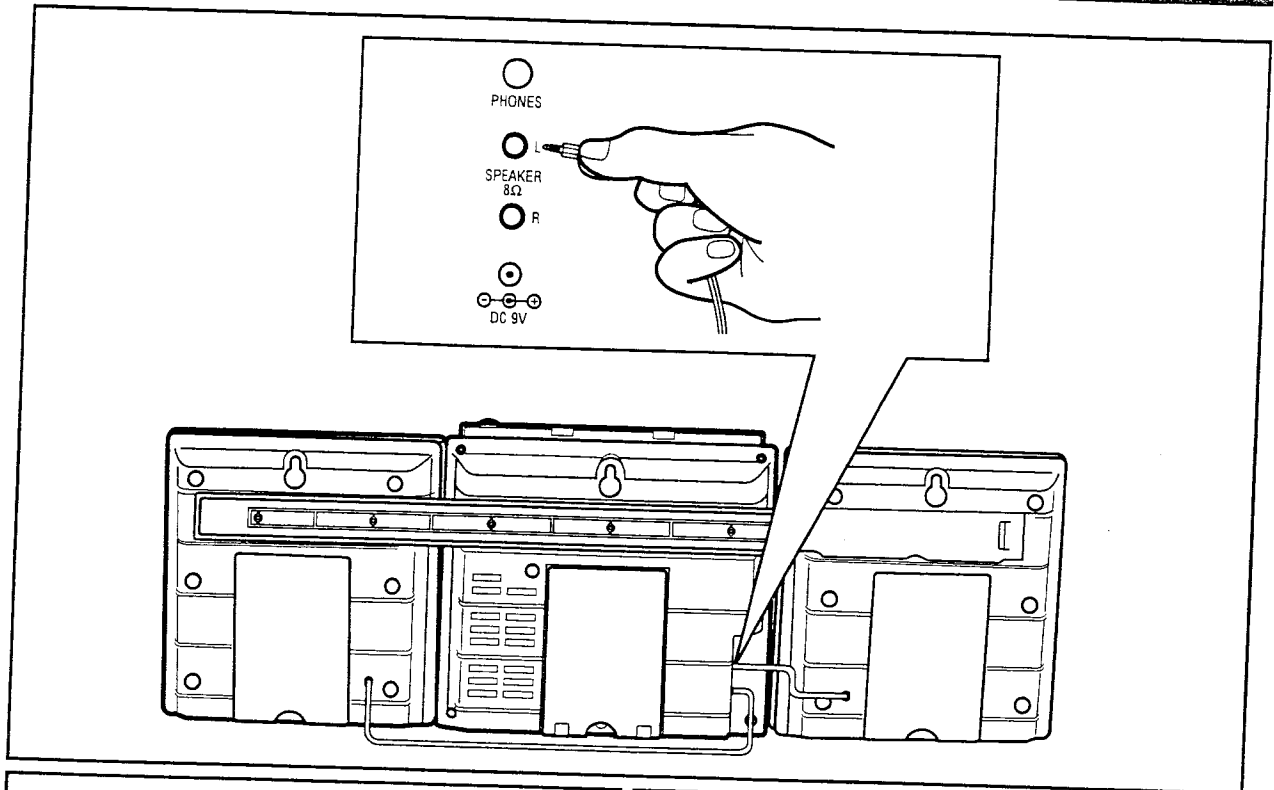

To detach the speaker enclosures

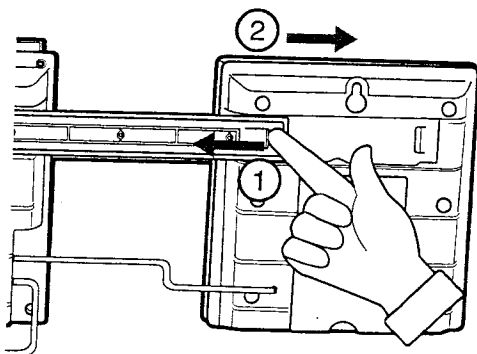

To attach the speaker enclosures

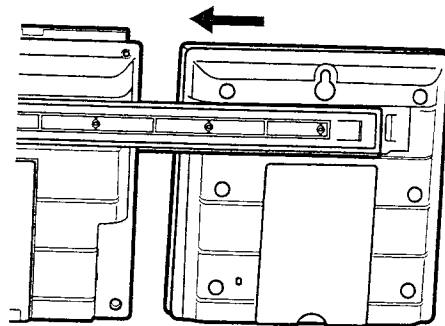

OPEN

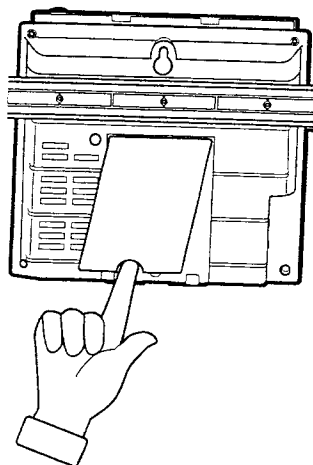

CLOSE

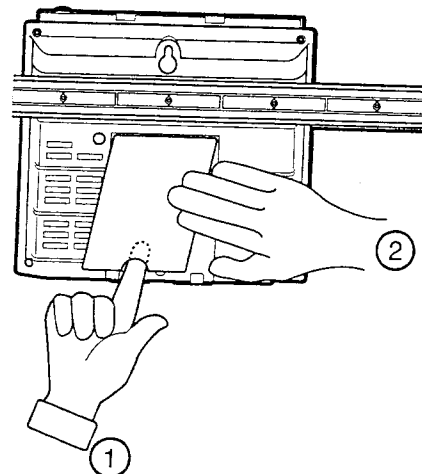

PLACE PICTURE

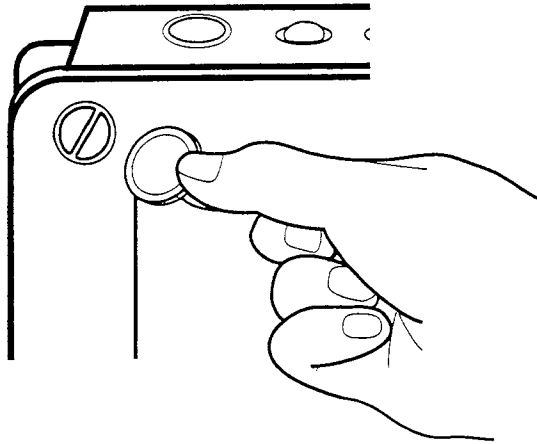

A picture (up to 3 1/2 x 5") may be placed under the transparent plastic top by removing the screws with a coin.

POWER SUPPLY

TO USE THE AC ADAPTOR

Connect the supplied AC adaptor as shown in the illustration.

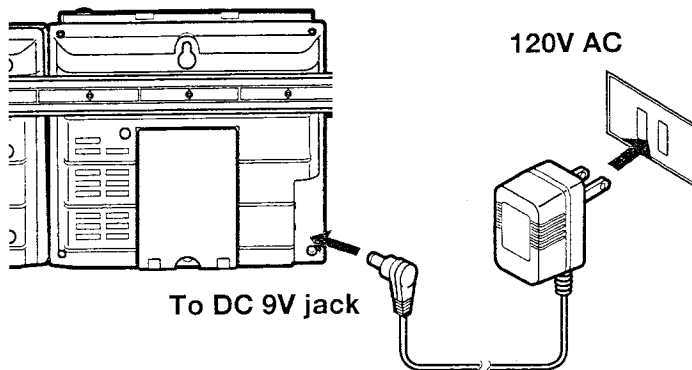

Cautions on the AC Adaptor

- Use this unit only with the supplied AC adaptor. Use with other AC adaptors could damage the unit.
- Do not touch the AC adaptor with wet hands. Doing so is dangerous as this could result in an electrical shock.

REMOTE CONTROL

NOTE:

The buttons on the remote control perform similar functions to similarly marked buttons on the front panel of the unit.

Controls

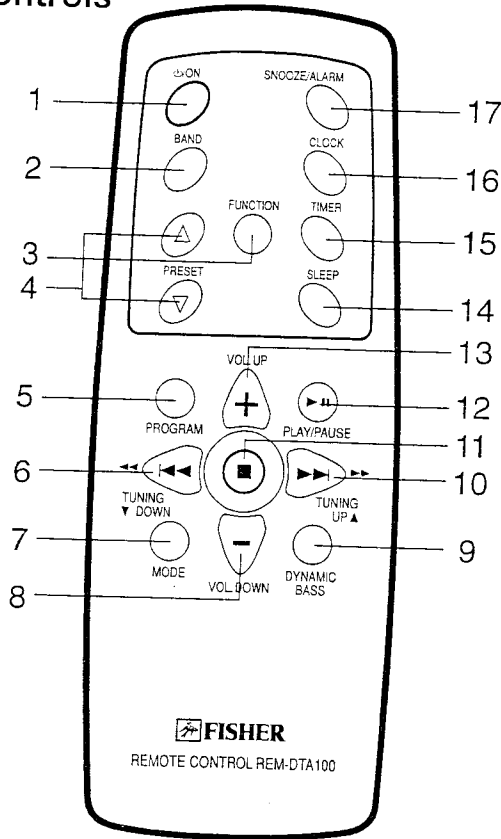

1. Power button (ON/OFF)
2. Band select button (BAND)
3. Function button (FUNCTION)
4. Preset tuning buttons (PRESET ▲, ▼)
5. Program button (PROGRAM)
6. Skip/Search, Tuning down button (◀◀/◀◀, TUNING ▼ DOWN)
7. Mode button (MODE)
8. Volume down button (VOL. DOWN -)
9. Dynamic bass button (DYNAMIC BASS)
10. Skip/Search, Tuning up button (▶▶/▶▶, TUNING UP ▲)
11. Stop button (STOP ■)
12. Play/Pause button (PLAY/PAUSE ▶||)
13. Volume up button (VOL. UP +)
14. Sleep button (SLEEP)
15. Timer button (TIMER)
16. Clock button (CLOCK)
17. Snooze/Alarm button (SNOOZE/ALARM)

Inserting batteries

1.

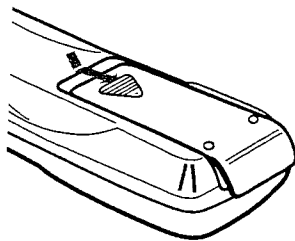

2.

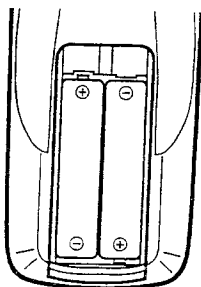

Two "AAA" batteries
(not supplied)

Remote control range

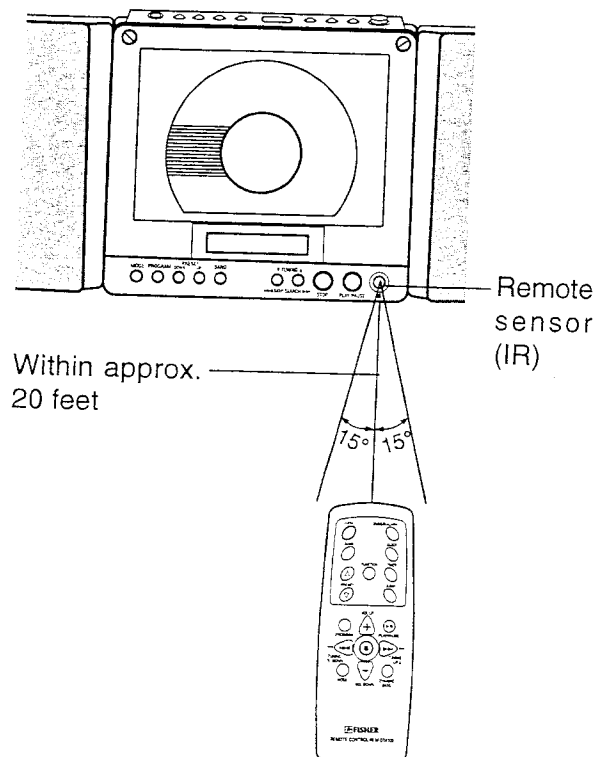

ADJUSTING THE CLOCK

NOTE:

When the unit is first connected to the AC power line, the clock display blinks on the display.

Example: To set the "PM 6:30".

Use the main unit or the remote control for this operation.

1. Press [CLOCK] for at least 2 seconds. The clock display blinks.



CLOCK



2. Press [VOLUME] + or - to set "PM 6:30".

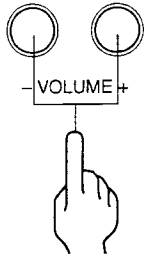

3. Press [CLOCK]. The clock starts.

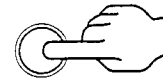

CLOCK



- To display the clock during operation, press [CLOCK] briefly. After a few seconds, the original display returns.
- If a power failure occurs, reset time again.

COMMON OPERATION

Turning the power on and off

Press [⏻/ON].

- "00 00:00" or frequency of tuner appears.



To turn off the power, press [⏻/ON] again.
The clock display remains lit.

Using headphones

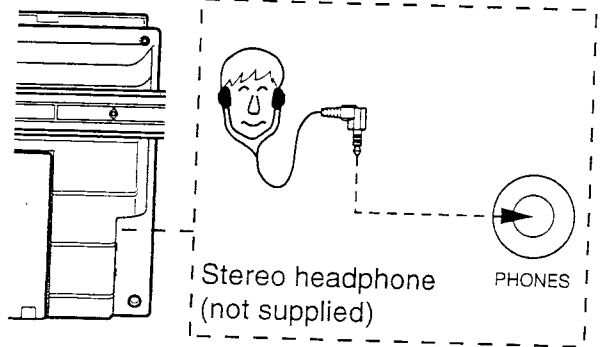

Adjusting the volume

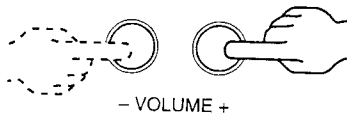

Dynamic bass system

Press [DYNAMIC BASS] to enhance the bass sound.

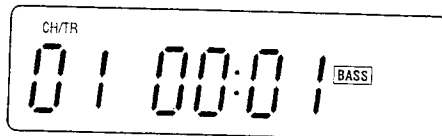
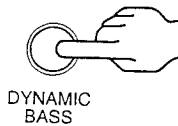

COMPACT DISC OPERATION

CD PLAY

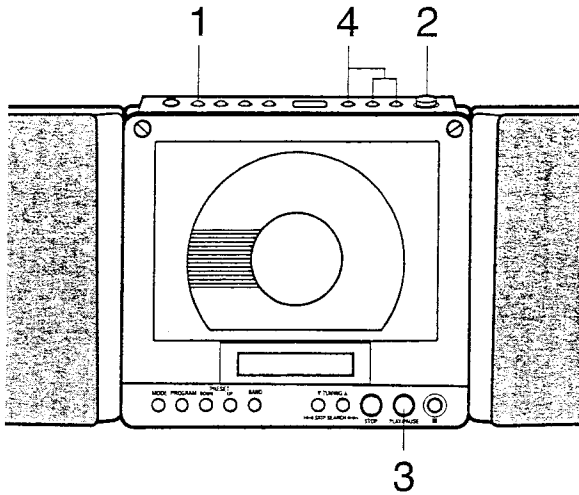

1 Press [FUNCTION] to select CD.



FUNCTION

2



CD OPEN

Push down.

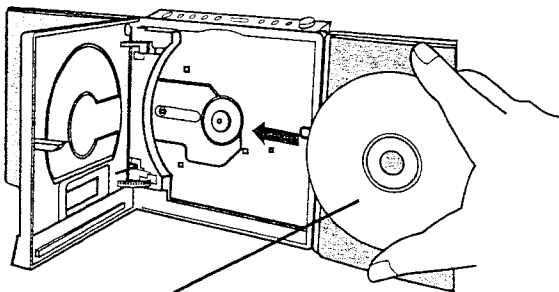

Label facing up

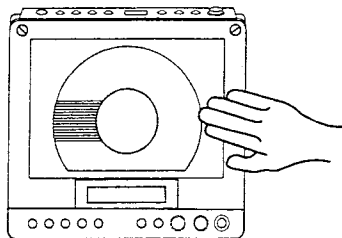

Close.

Total play time

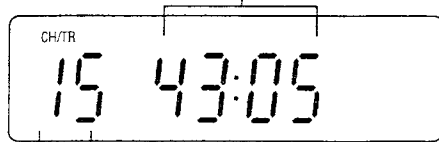

Total track number

3 Press [PLAY/PAUSE].



PLAY/PAUSE

Elapsed playing time of the current track

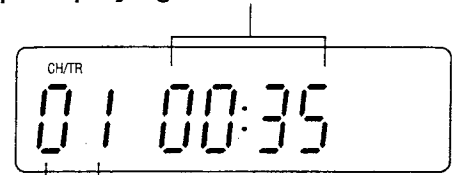

Current track number

4 To control the sound.

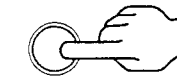

DYNAMIC
BASS

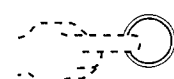

- VOLUME +

Press [STOP].

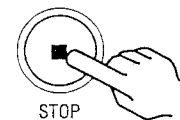

STOP

NOTES:

- If the disc is loaded with the label facing downward, or if a badly scratched disc is loaded, or if no disc is loaded, "no dISC" blinks.

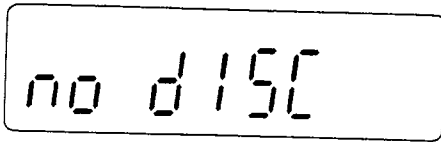

If this occurs, load the disc correctly with the label facing upward, or replace the damaged disc.

- Opening the CD compartment lid while a CD is playing could scratch the disc.
- Always press [STOP] and wait for the disc to stop rotating before opening the CD compartment lid.

Compact discs

- Both 3-inch and 5-inch discs can be played in this unit.

NOTE: Place only one disc at a time in the CD compartment.

- Only discs bearing the logo as shown can be played in this unit.



- Always place the compact disc in the CD compartment with the label facing up. Compact discs can be played on only one side.
- Fingerprints and dust should be carefully wiped from the disc's signal surface (opposite the label side) with a soft cloth. Gently wipe in a straight motion from the inside to the outside of the disc.
- Discs should be returned to their cases after use to avoid serious scratches which could cause the player to skip.
- Do not expose a disc to direct sunlight, high humidity, or high temperatures for extended periods of time to prevent warping the disc.
- Do not apply paper or writing instruments, or the inks used in some felt-tip pens, may damage the surfaces of the disc.
- Do not use cleaners or antistatic sprays on discs, such as those used for phonograph records.

Temporarily stopping play

1. Press [PLAY/PAUSE] during play. Play will temporarily stop, and the elapsed time will blink.



2. Press [PLAY/PAUSE] again to resume play.

Skip play

To skip to track 6 while track 3 is playing, press [SKIP/SEARCH] ►► repeatedly until "06" appears in the CH/TR section on the display.

To skip back to track 3 while track 6 is playing, press [SKIP/SEARCH] ◄◄ repeatedly until "03" appears.

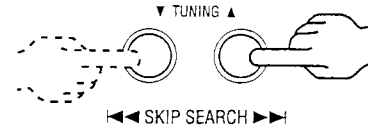

Search (forward/reverse)

If [SKIP/SEARCH] ►► or ◄◄ is pressed during play, the player search at high speed in the forward or reverse direction while the button is being pressed. When the button is released, normal play will continue.

SELECTING VARIOUS PLAYING MODE

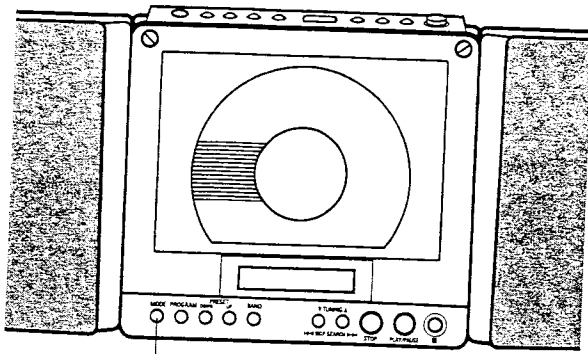

MODE

Press [MODE] repeatedly before or during play to select a various play mode available.

Each time [MODE] is pressed, the mode changes as shown below:

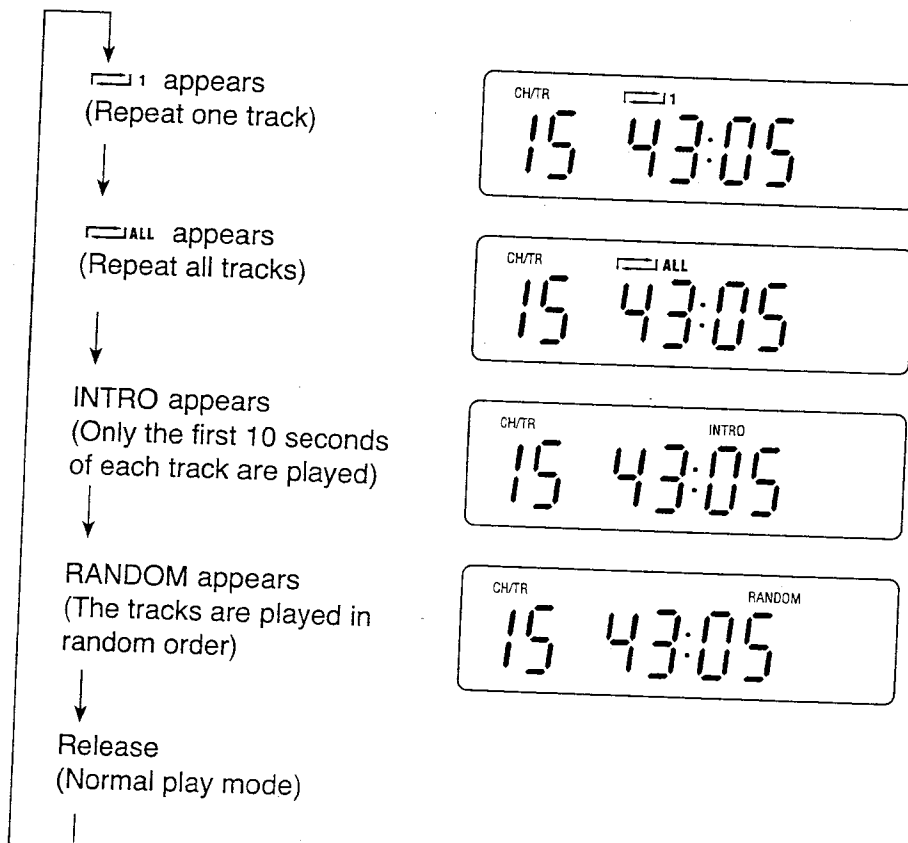

NOTE:

"INTRO" and "RANDOM" mode can not be selected during a programmed play.



PROGRAMMED PLAY

- Up to 20 selections can be programmed for play in any order.

TO PROGRAM

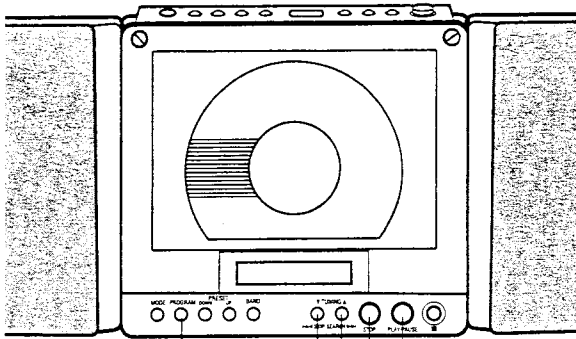

1 Press [STOP].

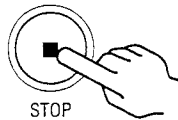

2 Press [PROGRAM].

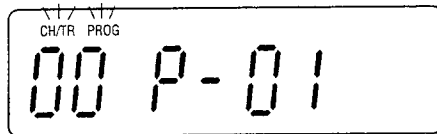
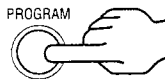

"CH/TR" and "PROG" blink.

3 Press [SKIP/SEARCH]

▶▶ or ◀◀ to select track number 5.

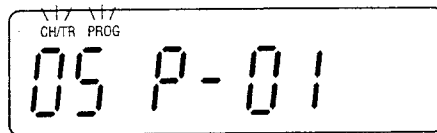
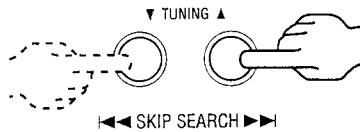

4 Press [PROGRAM].

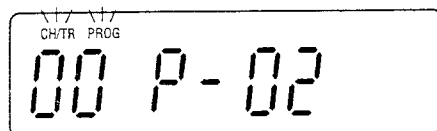
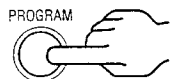

"CH/TR" and "PROG" blink.

5 Repeat 3 and 4 to memorize additional tracks.

Checking the program

Press [PROGRAM] repeatedly in the stop mode.

The programmed details sequentially appear on the display. "CH/TR" and "PROG" blink.

Changing a program

To add a new selection to a program:

1. In the stop mode, press [PROGRAM] repeatedly until "00P" appears on the display.
2. Select the track number as explained above.
3. Press [PROGRAM].

To change a selection:

1. In the stop mode, press [PROGRAM] repeatedly until the selection to be replaced is displayed.
2. Select the track number as explained above.
3. Press [PROGRAM].

TO BEGIN PROGRAM PLAY

6 While "PROG" is blinking, press [PLAY/PAUSE].

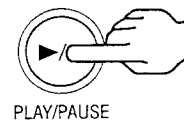

Programmed play will begin.
"PROG" remains lit.

- Press [STOP] to stop play at any time.

CLEARING THE PROGRAM

In the stop mode, press [PROGRAM], then [STOP]. Also, the program is cleared in the following cases:

- The CD compartment lid is opened.
- The power is turned off.

RADIO OPERATION

FREQUENCY UP/DOWN TUNING

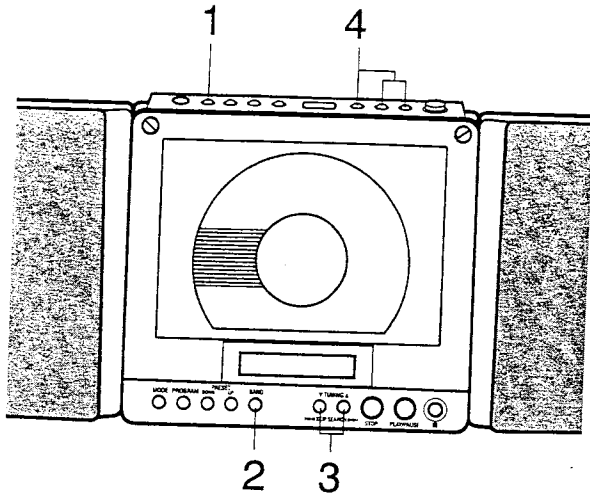

1 Press [FUNCTION] to select tuner.



2 Press [BAND] to select a band (AM, FM).

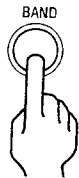

3 Tune in a station.

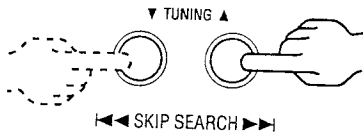

Automatic tuning

Press [TUNING] ▲ or ▼ for at least 1 second to tune in a station. The unit will scan up or down the band and select the next receivable station.

Manual tuning

Press and release [TUNING] ▲ or ▼ repeatedly to tune in a station.

4 To control the sound.

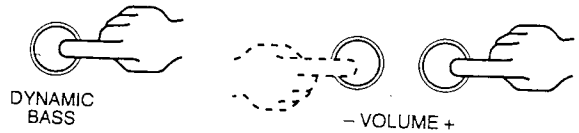

Selecting FM MODE

"ST" appears when an FM stereo broadcast is received.

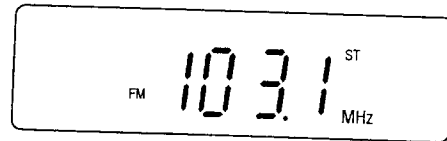

If the signal from an FM stereo station is weak and reception is poor, press [MODE]. "ST" disappears.



MANUAL PRESET TUNING

- Up to 20 AM and 20 FM stations can be preset.

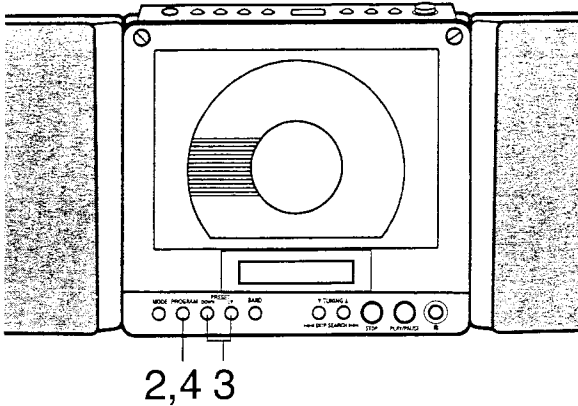

1 Tune in a station.

See "FREQUENCY UP/DOWN TUNING".

2 Press [PROGRAM].

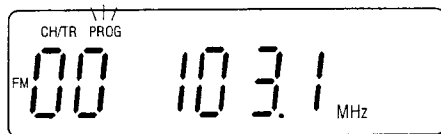
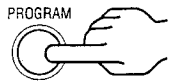

"PROG" blinks.

3 Press [PRESET] UP or DOWN to select the channel number.

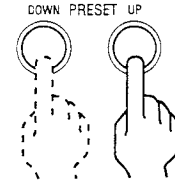

4 Press [PROGRAM].

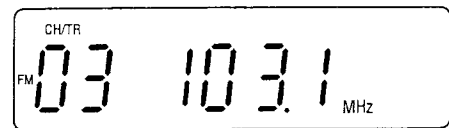
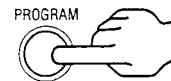

5 Repeat the steps above to add more preset stations.

Listening to preset stations Press [PRESET] UP or DOWN.

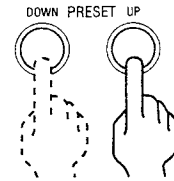

To improve reception

FM-Extend the antenna lead wire as straight as possible and, while listening to the sound from the system, secure it in a position where the best FM reception is found.

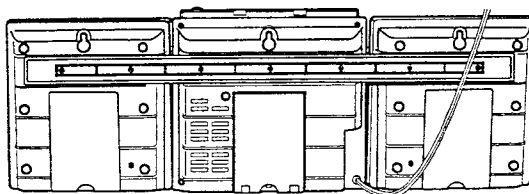

AM - Rotate unit.

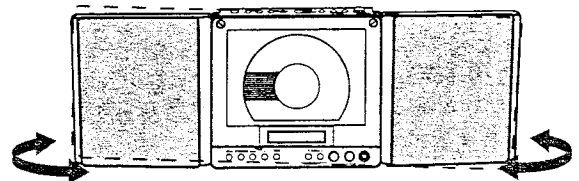

TIMER OPERATION

TIMER

Before setting the timer, make sure that the clock is set to the present time (See "ADJUSTING THE CLOCK"). Load a CD or tune in to the desired band and station and, then adjust the volume level as desired.

Example:

Set waking up 7:30AM every day.

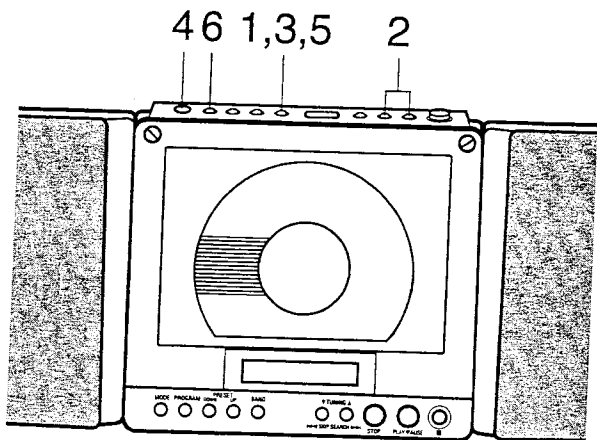

- When the waking up time arrives, the power is turned on automatically and the units starts playing with the preset function selected.
- When you still want to sleep for a while, press [snooze], playing or beep sound stops temporarily, 9 minutes later playing continues or beep sound can be heard again.
- When timer wake up, function playing (CD or TUNER or BUZZER) for 60 minutes and then power off.
- CD mode will jump to BUZZER mode if no disc inside a unit.
- If [ON/OFF] is pressed during timer operation, the power is turned off and the timer is set to the standby mode.

NOTE:

- The BUZZER sound level is the constant level, not concerned with the volume level.
- The timer functions every day, unless it is released. To release the timer, press "TIMER" again with the power off. "TIMER" disappears on the display.

1. Press [TIMER] for at least 2 seconds.



"TIMER" blinks.

2. Press [VOLUME] + or -.



3. Press [TIMER].

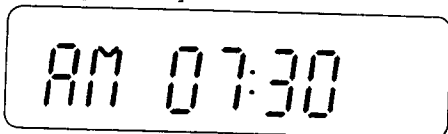

The display returns to the previous function.

4. Press [ON/OFF] to turn off the power.
5. Press [TIMER]. "TIMER" appears on the display.

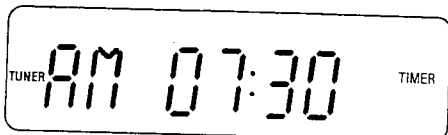

6. Press [FUNCTION] to select "CD", "TUNER" or "BUZZER". The selected function appears on the display.

10 MIN INTERVAL ALARM

This feature will notify you of the time lapse every 10 minutes after the set time arrives. When first ten-minute passed. One beep sound can be heard, second ten-minute pass two beep sounds can be heard. In the same way, when sixth ten-minute pass, six beep sounds can be heard and then power off.

Note:

Beep sound level is not concerned with the volume level.

- The beep sound is mixed with function sound (CD, TUNER).

SNOOZE/ALARM

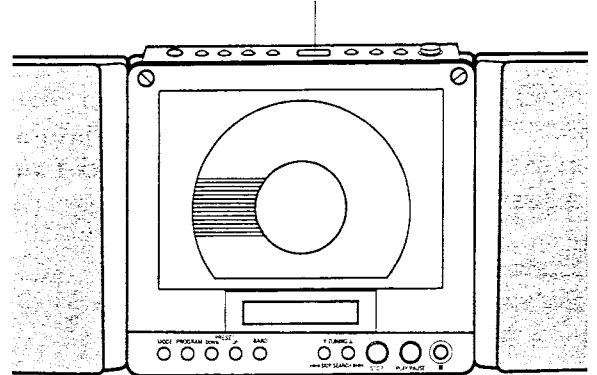

1. Set the TIMER time first. See "TIMER" section.
2. Press [SNOOZE/ALARM]. "ALARM" appears.

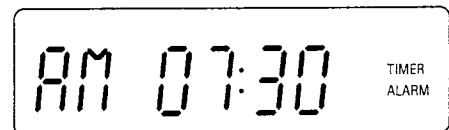

When the timer ON time arrives, the power is turned on automatically, and the unit start playing with the preset function selected.

NOTE:

It only can be set under timer set on and power off status.

SNOOZE

When the timer is switched on, the sound will be turned up to the position previously set with the VOLUME control.

Press [SNOOZE/ALARM]. "SNOOZE" blinks on the display. The sound stop for about 9 minutes, then start again. This is repeated every time [SNOOZE/ALARM] is pressed until the timer goes out.

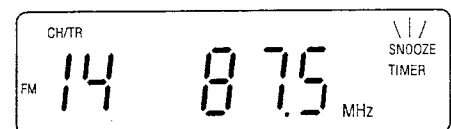

- To stop the snooze, press [ON].

SNOOZE/ALARM

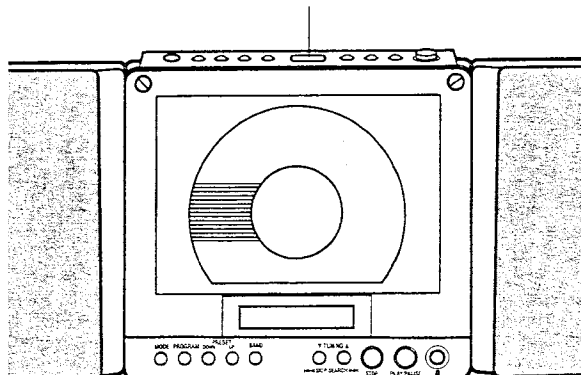

SLEEP

Before setting the sleep, make sure that the clock is set to the present time. See "ADJUSTING THE CLOCK".

- To release the sleep, press [SLEEP] repeatedly until "00" appears. "SLEEP" disappears on the display.

SLEEP

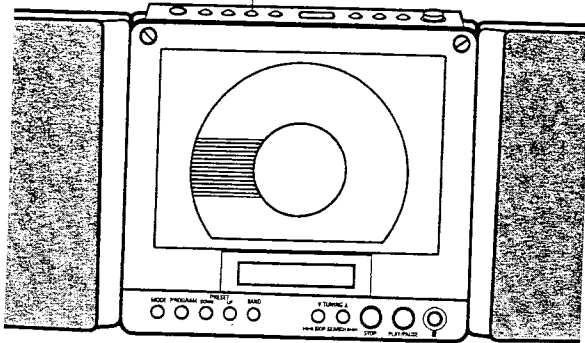

Press [SLEEP]. A preset time and "SLEEP" appear on display.

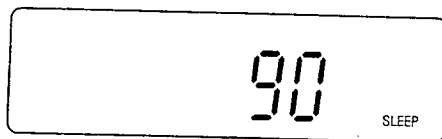

Each time [SLEEP] is pressed, there is a different preset time appears on display, there are 9 time periods available: 90, 80, 70, 60, 50, 40, 30, 20 and 10 minutes. The timer automatically switches off the power after a preset time has elapsed.

REMOTE CONTROL OPERATION

NOTE:

The buttons on the remote control perform similar function to similarly marked buttons on the front panel.

Operation

(Common section)

Power On/Off	⏻/ON
Adjust volume	VOL UP + or VOL DOWN -
Select Bass function	DYNAMIC BASS
Adjust clock	CLOCK → VOL. UP + or VOL. DOWN - → CLOCK
Adjust Timer	TIMER → VOL. UP + or VOL. DOWN - → TIMER
Select snooze function	SNOOZE
Set sleep time	SLEEP
Select Function	FUNCTION

(Tuner section)

Select TUNER and/or Select band	BAND
Tune in a station	TUNING UP ▲ or TUNING DOWN ▼
Preset stations	BAND → TUNING → PROGRAM → PRESET ▲ or ▼ → PROGRAM
Select preset station	In TUNER mode PRESET ▲ or ▼
Select FM mode	MODE

(CD changer section)

Start play	PLAY/PAUSE ►
Select the desired track	In CD mode ◀◀/▶▶ or ▶▶/▶▶▶▶
Programmed play	In CD mode PROGRAM → ◀◀/▶▶ or ▶▶/▶▶▶▶ → PROGRAM
Temporarily stop play	During play PLAY/PAUSE ►
Skip play	During play ◀◀/▶▶ or ▶▶/▶▶▶▶ (press once)
Search	During play ◀◀/▶▶ or ▶▶/▶▶▶▶ (press continuously)
Repeat play	MODE
Random play	MODE
Stop	■
Introscan play	MODE

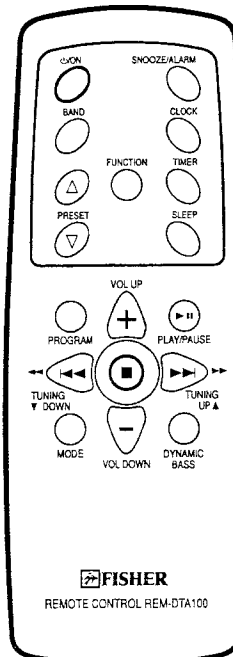

MAINTENANCE

Cleaning the unit

Clean the outside of the unit with a clean soft cloth, moistened with lukewarm water. Do not use solvents such as benzene or thinner. These will permanently damage the units finish.

Cleaning the CD player lens

The lens should never be touched. If dust is on the lens, blow it off using a camera lens blower. (Please consult your dealer.)

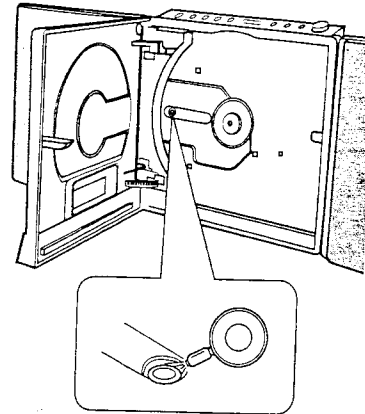

If trouble occurs ...

To avoid the hazard of electric shock and damage to the unit, have the unit bench tested by an authorized FISHER service station. Do not remove the unit from its cabinet to attempt repairs yourself.



TROUBLESHOOTING GUIDE

If you have followed the instructions and are having difficulty operating the unit, locate the SYMPTOM in the left column below. Check the corresponding POSSIBLE CAUSE and CORRECTIVE ACTION columns to locate and remedy the problem.

SYMPTOM	POSSIBLE CAUSE	CORRECTIVE ACTION
No power when [⏻/ON] is set to on.	The AC adaptor is not connected.	Insert the AC adaptor into the AC outlet, and the other end of it into the DC 9V jack.
No sound.	Volume control is set to minimum.	Turn up the volume. (See page E8.)
	The wrong function is selected.	Select the correct function.
Sound is heard from only one speaker.	Faulty connection of one speaker wire.	Connect the wire firmly to the speaker terminals. (See page E4.)
The CD player does not operate and "no DISC" blinks.	The disc is loaded with the label side down.	Load the disc with the label facing up. (See page E9 & E10.)
The sound from the CD player skips.	The compact disc is dirty.	Clean the disc. (See page E10.)
	The compact disc is scratched.	Replace the disc. (See page E9.)
Abnormal CD or display operation with the correct button settings.	The memory must be reset.	Disconnect the AC adaptor, and wait for at least 30 seconds. Connect it again and press [⏻/ON]. (See page E3.)
Flickering "ST".	Weak signal.	Press [MODE] "ST" disappears.

SERVICING:

Should this product require service, refer to the FISHER audio limited warranty.

**FISHER AUDIO
MODEL PH-DTA100 LIMITED WARRANTY**

OBLIGATIONS

In order to obtain factory warranty service, call the toll-free number below. The unit must be packed in the original carton or a well padded sturdy carton in order to avoid shipping damage.

Note: Do not return this unit to the retail store for service.

To obtain factory warranty service, product operation information or for problem resolution, call
Customer Information 1-800-421-6382
Weekdays 8:00 AM - 5:00 PM Pacific Time

THIS WARRANTY IS VALID ONLY ON FISHER PRODUCTS PURCHASED AND USED IN THE UNITED STATES OF AMERICA.

THIS WARRANTY APPLIES ONLY TO THE ORIGINAL RETAIL USER, AND DOES NOT APPLY TO PRODUCTS USED FOR ANY INDUSTRIAL, PROFESSIONAL OR COMMERCIAL PURPOSE. THE ORIGINAL DATED BILL OF SALE OR SALES SLIP MUST BE SUBMITTED AT THE TIME WARRANTY SERVICE IS REQUESTED.

Subject to the OBLIGATIONS above and EXCLUSIONS below, SANYO FISHER COMPANY (SFC) warrants this FISHER product against defects in materials and workmanship for the periods of LABOR and PARTS specified below. SFC will repair or replace (at its option) the product and any of its parts which fail to conform to this warranty with new or reconditioned products or parts. The warranty period commences on the date the product was first purchased at retail.

LABOR	PARTS
90 DAYS	90 DAYS

EXCLUSIONS

This warranty does not cover (A) the adjustment of customer-operated controls as explained in the appropriate model's instruction manual, or (B) the repair of any product whose serial number has been altered, defaced or removed.

This warranty shall not apply to the cabinet or cosmetic parts, antenna, knobs or routine maintenance.

This warranty does not apply to uncrating, setup, installation, removal of the product for repair or reinstallation of the product after repair.

This warranty does not apply to repairs or replacements necessitated by any cause beyond the control of SFC including, but not limited to, any malfunction, defect or failure caused by or resulting from unauthorized service or parts, improper maintenance, operation contrary to furnished instructions, shipping or transit accidents, modification or repair by the user, abuse, misuse, neglect, accident, incorrect power line voltage, fire, flood or other Acts of God, or normal wear and tear.

The foregoing is in lieu of all other expressed warranties and SFC does not assume or authorize any party to assume for it any other obligation or liability.

THE DURATION OF ANY WARRANTIES WHICH MAY BE IMPLIED BY LAW (INCLUDING THE WARRANTIES OF MERCHANTABILITY AND FITNESS) IS LIMITED TO THE TERM OF THIS WARRANTY. IN NO EVENT SHALL SFC BE LIABLE FOR SPECIAL, INCIDENTAL OR CONSEQUENTIAL DAMAGES ARISING FROM OWNERSHIP OR USE OF THIS PRODUCT, OR FOR ANY DELAY IN THE PERFORMANCE OF ITS OBLIGATIONS UNDER THIS WARRANTY DUE TO CAUSES BEYOND ITS CONTROL.

SOME STATES DO NOT ALLOW LIMITATIONS ON HOW LONG AN IMPLIED WARRANTY LASTS AND/OR DO NOT ALLOW THE EXCLUSION OR LIMITATION OF CONSEQUENTIAL DAMAGES, SO THE ABOVE LIMITATIONS AND EXCLUSIONS MAY NOT APPLY TO YOU.

THIS WARRANTY GIVES YOU SPECIFIC LEGAL RIGHTS. YOU MAY HAVE OTHER RIGHTS, WHICH VARY FROM STATE TO STATE.

FO-PHD R1

For your protection in the event of theft or loss of this product, please fill in the information below for your own personal records.

Model No. _____ Serial No. _____
 Date of Purchase _____ (Located on back or bottom side of unit)
 Where Purchased _____ Purchase Price _____





21605 Plummer Street Chatsworth, CA 91311

Printed in China

Free Manuals Download Website

<http://myh66.com>

<http://usermanuals.us>

<http://www.somanuals.com>

<http://www.4manuals.cc>

<http://www.manual-lib.com>

<http://www.404manual.com>

<http://www.luxmanual.com>

<http://aubethermostatmanual.com>

Golf course search by state

<http://golfingnear.com>

Email search by domain

<http://emailbydomain.com>

Auto manuals search

<http://auto.somanuals.com>

TV manuals search

<http://tv.somanuals.com>