

OPERATING INSTRUCTIONS



FVH-E420

Video Cassette Recorder



Only cassettes marked **VHS** can be used with this video cassette recorder.



As an ENERGY STAR® Partner, FISHER has determined that this product or product model meets the ENERGY STAR® guidelines for energy efficiency.

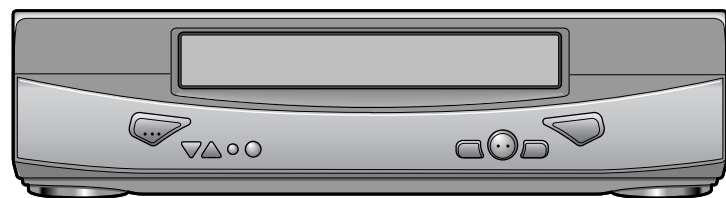

Studio-Standard®





Please read this manual and accompanying "IMPORTANT SAFETY INSTRUCTIONS" sheet carefully before connecting your VCR and operating it for the first time.
Be sure to read carefully and follow all the PRECAUTIONS on page 1.
Keep the manual in a safe place for future reference.

NOTE: Locate serial number (shown on rear panel of unit) and record it here ➔ _____

PRECAUTIONS

	CAUTION RISK OF ELECTRIC SHOCK DO NOT OPEN	
<p>CAUTION: TO REDUCE THE RISK OF ELECTRIC SHOCK, DO NOT REMOVE COVER (OR BACK). NO USER-SERVICEABLE PARTS INSIDE. REFER SERVICING TO QUALIFIED SERVICE PERSONNEL.</p>		

	<p>The lightning flash with arrowhead symbol, within an equilateral triangle, is intended to alert the user to the presence of uninsulated "dangerous voltage" within the product's enclosure that may be of sufficient magnitude to constitute a risk of electric shock to persons.</p>
	<p>The exclamation point within an equilateral triangle is intended to alert the user to the presence of important operating and maintenance (servicing) instructions in the literature accompanying the product.</p>

WARNING: To reduce the risk of fire or electric shock, do not expose this appliance to rain or moisture.

CAUTION: To prevent electric shock, match wide blade of plug to wide slot of electrical outlet and insert fully.

CAUTION: Changes or modifications not expressly approved by the manufacturer may void the user's authority to operate this VCR.

Location

For safe operation and satisfactory performance of your VCR, keep the following in mind when selecting a place for its installation:

- Shield it from direct sunlight and keep it away from sources of intense heat.
- Avoid dusty or humid places.
- Avoid places with insufficient ventilation for proper heat dissipation. Do not block the ventilation holes of the VCR. Do not place the unit on a carpet because this will block the ventilation holes.
- Install the VCR in a horizontal position only.
- Avoid locations subject to strong vibrations.
- Avoid moving the VCR between cold and hot locations (see "Moisture Condensation Problems", this page).
- Do not place the VCR directly on top of the TV, as this may cause playback or recording problems.

Avoiding Electric Shock or Fire

- Do not handle the power cord with wet hands.
- Do not pull on the power cord when disconnecting it from an AC wall outlet. Grasp it by the plug.
- If any liquid is spilled on the VCR, unplug the power cord immediately and have the unit inspected at a factory-authorized service center.
- Do not place anything directly on top of the VCR.

WARNING: Unauthorized recording or use of television broadcast, video tape, film or other copyrighted material may violate applicable copyright laws. The manufacturer assumes no responsibility for unauthorized duplication, use or other acts that infringe upon the rights of copyright owners.

Declaration of Conformity

Model Number : FVH-E420
 Trade Name : Fisher
 Responsible party : SANYO FISHER COMPANY
 Address : 21605 Plummer Street,
 Chatsworth, California 91311
 Telephone No. : (818) 998-7322

- This device complies with Part 15 of the FCC Rules. Operation is subject to the following two conditions:
 - (1) this device may not cause harmful interference, and
 - (2) this device must accept any interference received, including interference that may cause undesired operation.

Moisture Condensation Problems

Cause:

When the VCR is first installed, moved from a cold area to a warm area or placed in a location with high humidity, dew (moisture) may form inside the unit. If you operate the VCR with dew inside, damage may result.

Prevention:

- 1 Make all necessary connections.
- 2 Plug the power cord into a 120 V AC wall outlet.
- 3 Turn on the power.
- 4 Do not operate the VCR or insert a cassette for approximately 2 hours.

This allows the VCR to warm up to the temperature of the room where it will be used.

Technology licensed by FAROUDJA Laboratories Inc.	This VCR has a Y/C filtering technique incorporated under license from Faroudja Laboratories Inc.
--	---

FEATURES

TIMER/CLOCK

- Selectable standard/daylight saving time
- 1-year/8-event program timer with daily/weekly settings
- Smart Time Record function
- Smart Speed Record function
- Remaining tape duration display
- Quick timer recording (QTR)
- Off timer (up to 6 hours)

VIDEO

- Digitally-adjusted clean playback

SPECIAL PLAYBACK/SEARCH

- Ad JUMP®
- Recording contents on-screen list (Rec. List Super)
- Double-Azimuth 4-head video recording/playback system for clean special playback:
 - Forward/reverse search, double-speed playback, clean still image, frame advance, variable-speed slow motion
- Zero search
- Index search

AUTOMATIC FUNCTIONS

- Automatic clock setting and adjustment
- Automatic head cleaner
- Endless playback
- Automatic digital tracking
- Automatic channel programming
- Full auto playback functions: power-on, rewind, eject, record auto cancel, power-off eject

GENERAL

- Multilanguage, multicolor on-screen menu
- Remote control
- Vibration-suppressing mid-mount design
- Child lock

CONTENTS

Precautions	1
Features	2
Accessories	2

DESCRIPTION

VHS video cassette tapes	3
Locations of controls and indicators	4
Remote control	7

CONNECTIONS





Basic antenna/cable connections	9
Alternative cable TV connections	10
Audio/video connections	12

BASIC OPERATION

Initial setup	13
Multifunction on-screen displays	15
On-screen menu	16
Setting the clock	18
Changing the menu language	20
Programming channels	20
Viewing TV only	21
Playing a rental tape	21
Normal playback	22
Tracking control	22
Recording	23
Rec. List super	25

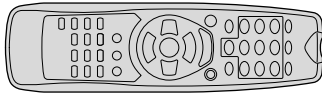
ACCESSORIES

Make sure that all the accessories listed below have been included with your VCR.

Power cord 	Remote control 
75-ohm coaxial cable 	Quick Start Guide 
Two AA batteries (1.5 volt) 	

ADVANCED USE

Special playback	27
Zero search	28
Index search	28
Program timer recording	29
Quick timer recording (QTR)	33
Child lock	34
Ad JUMP®	34
Copying a tape	35
Maintenance	35
Troubleshooting guide	36
Specifications	37

VHS VIDEO CASSETTE TAPES

Record/Play Times

	Tape Length	T-60	T-120	T-160	
Tape Speed	SP Mode	1 hour (60 minutes)	2 hours (120 minutes)	2-2/3 hours (160 minutes)	highest video quality
	LP Mode (playback only)	2 hours (120 minutes)	4 hours (240 minutes)	5-1/3 hours (320 minutes)	excellent video quality
	SLP Mode	3 hours (180 minutes)	6 hours (360 minutes)	8 hours (480 minutes)	good video quality (longest recording time)

NOTE: This unit cannot record in LP mode.

When Handling Video Cassettes

- Do not expose video cassettes to extreme heat, high humidity or strong magnetic fields.
- Do not tamper with the cassette mechanism.
- Do not touch the tape with your fingers.
- Always store an unused cassette in its case.

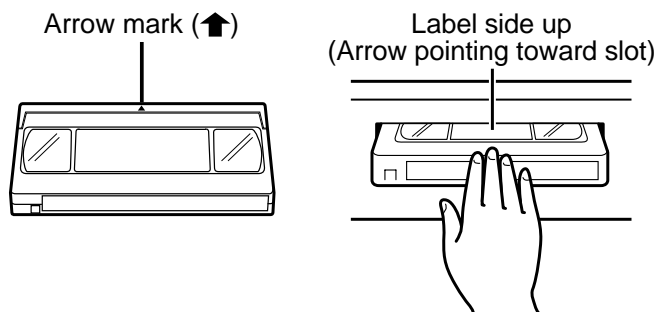

Safety Tab

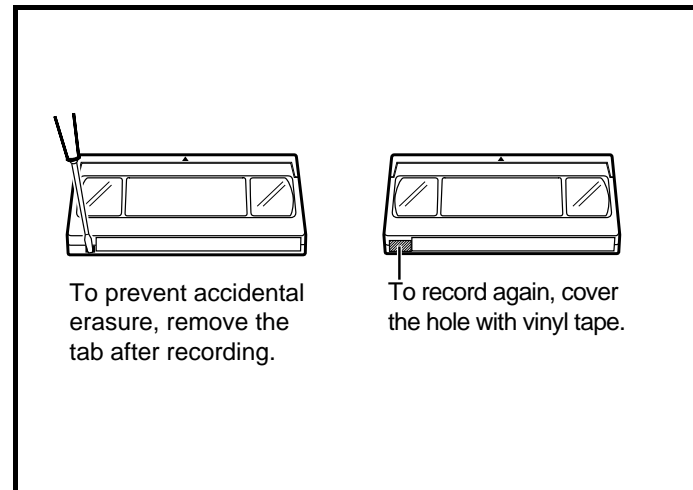

Loading

- 1 Gently push the center of the cassette until it is drawn in automatically.

The clock display changes to the tape counter display automatically and the Tape-In icon (●●) lights.

NOTES:

- If the cassette is not inserted correctly, it will be ejected in approximately 3 seconds.
- Do not try to pull the cassette out once automatic loading starts.
- Do not force the cassette into the VCR.

CAUTION: To avoid possible injury or accident, keep children away from this unit. Do not put your hand or other objects into the cassette loading slot.

Unloading

- 1 When in the STOP mode, press the **STOP/EJECT** button on the front panel. In any other mode, press the button twice.

The tape counter display changes to the clock display automatically.

- 2 After the cassette appears in the loading slot, gently pull it out.

AUTO POWER-OFF/EJECT: The cassette is ejected when the **STOP/EJECT** button on the front panel is pressed, even if the VCR's power is off. (The power cord must be connected to an AC wall outlet.)

LOCATIONS OF CONTROLS AND INDICATORS

Front Panel

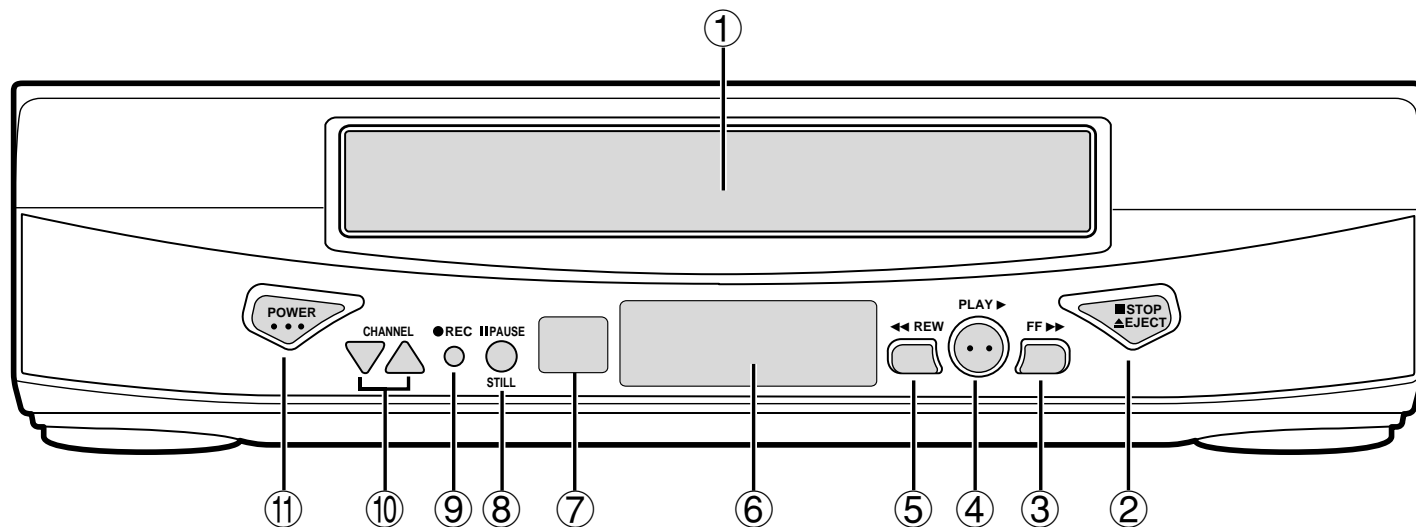

Reference pages are shown in square brackets.

- ① Cassette loading slot
- ② STOP/EJECT button [3, 22]
- ③ FF (fast forward) button [27]
This button is used both for fast forward and forward picture search.
- ④ PLAY button [22]
- ⑤ REW (rewind) button [27]
This button is used both for rewind and reverse picture search.
- ⑥ Indicator panel [5]
- ⑦ Remote control sensor
- ⑧ PAUSE/STILL button [23, 27]
 - Press this button in the record mode to temporarily stop a recording (PAUSE).
 - Press this button in the playback mode to view a still frame (STILL).
 - Press this button repeatedly in the still mode to advance the picture one frame at a time.
- ⑨ REC (record) button [23, 33]
- ⑩ CHANNEL selection buttons (▼ and ▲) [14, 22, 33]
- ⑪ POWER button

LOCATIONS OF CONTROLS AND INDICATORS

Indicator Panel

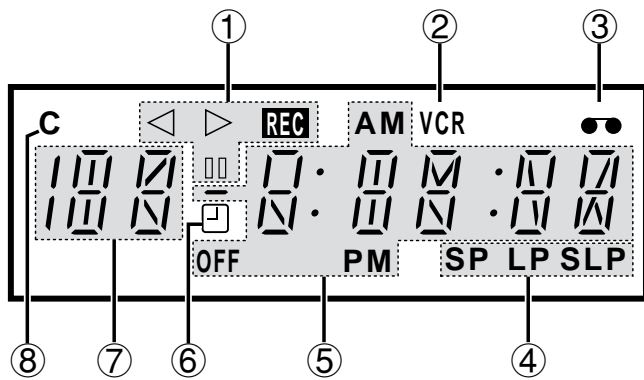

① Operation Icons (see below).

② VCR indicator

Use the **TV/VCR** button on the remote control to turn this indicator ON or OFF.

ON: for playback, VCR programming or watching TV programs through the VCR tuner

OFF: for watching TV programs through TV tuner

③ Tape-In icon

④ Tape Speed indicators

⑤ Clock/ Tape Counter/ QTR (Quick Timer Recording) indicators

⑥ Timer icon

⑦ Input source indicator:
Channel number or audio/video input (L1)

⑧ CATV indicator

Operation Icons

Play, Forward Search, Slow 	Reverse Search 	Fast forward (blinking)	Rewind (blinking)
Record 		Record pause (blinking)	
Still (blinking)		Frame advance 	

Example of Indications

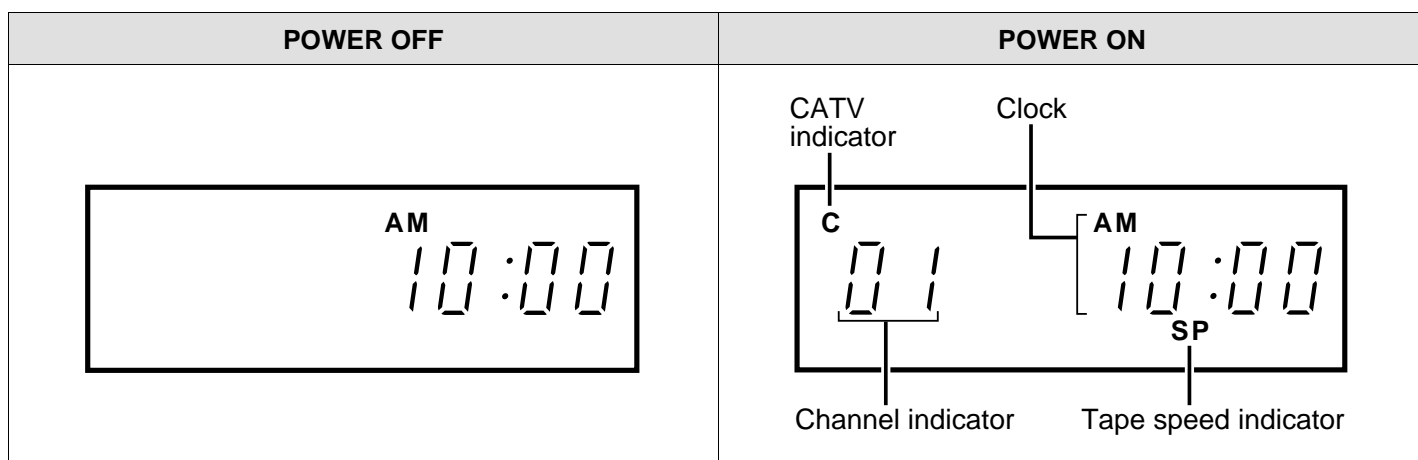

LOCATIONS OF CONTROLS AND INDICATORS

Back Panel

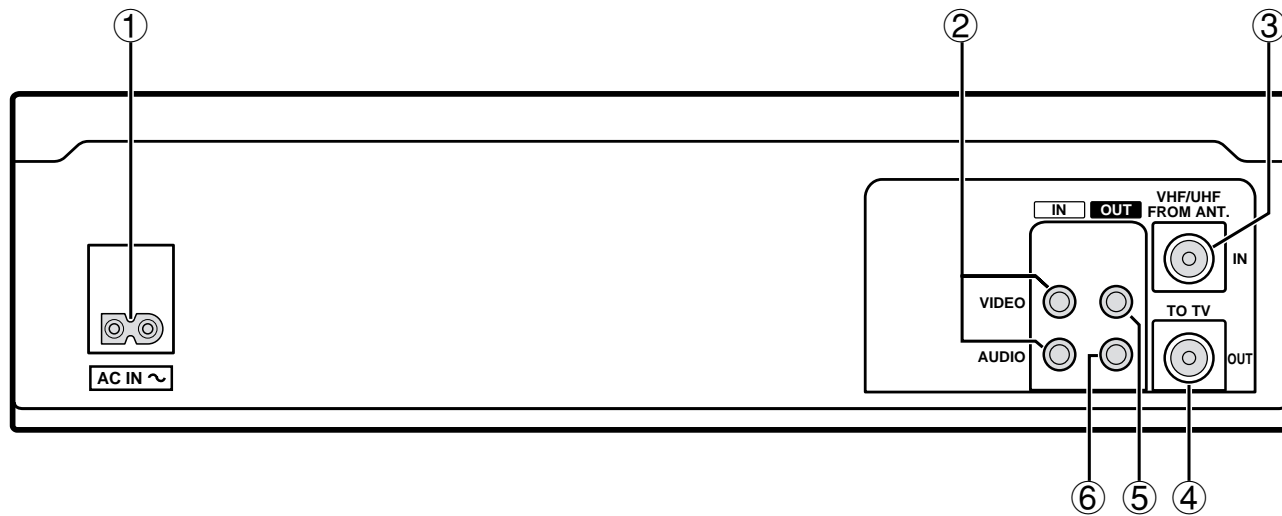

- ① AC power input
- ② Rear-panel AUDIO/VIDEO input jacks
Connect the audio and video outputs from an external unit (i.e. a video camera, second VCR) to these jacks. To record the signals coming from the external unit, press the **INPUT** button on the remote control to display "L1" instead of a channel number (see page 23).
- ③ VHF/UHF antenna input jack
- ④ VHF/UHF antenna output jack
- ⑤ VIDEO output jack (yellow)
- ⑥ AUDIO output jack (white)

REMOTE CONTROL

Locations of Controls

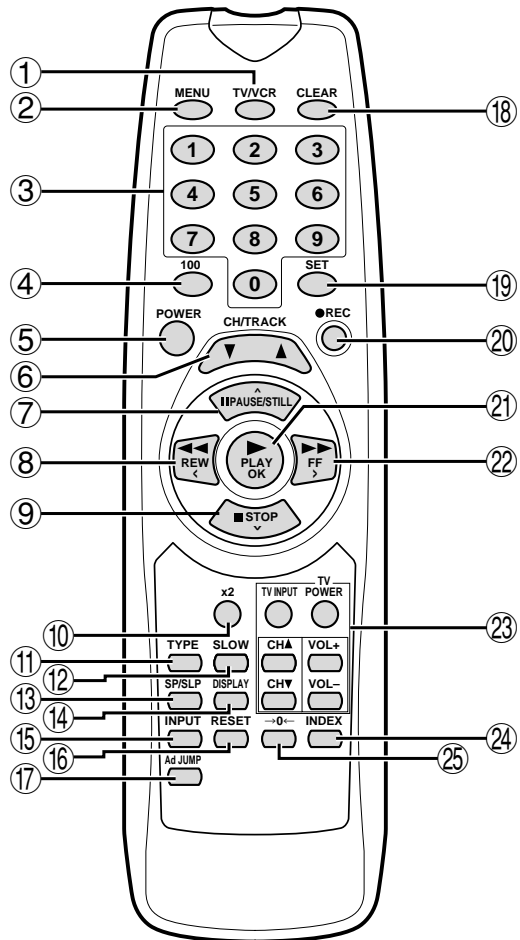

Reference pages are shown in square brackets.

- ① TV/VCR mode button [13]
Lets you select TV or VCR mode. When VCR mode is selected, the VCR indicator lights on the front panel.
- ② MENU button [16]
- ③ Number buttons (0 – 9) [14, 19]
- ④ 100 button [14]
- ⑤ POWER button [13]
- ⑥ CH (channel) selection/TRACK (tracking) buttons (▼ and ▲) [14, 22, 33]
- ⑦ PAUSE/STILL · ▲ button [16, 23, 27]
- ⑧ REW (rewind) · ◀ button [17, 27]
- ⑨ STOP · ▼ button [16, 23]
- ⑩ x2 button [27]
- ⑪ TYPE button [26]
- ⑫ SLOW button [27]
- ⑬ SP/SLP button [23]
- ⑭ DISPLAY button [15, 28]
- ⑮ INPUT button [23]
- ⑯ Tape counter RESET button [28]
- ⑰ Ad JUMP button [34]
- ⑱ CLEAR button [14]
- ⑲ SET button [14]
- ⑳ REC (record) button [23, 33]
- ㉑ PLAY · OK button [16, 22]
- ㉒ FF (fast forward) · ▶ button [17, 27]
- ㉓ TV control buttons (TV POWER, TV INPUT, CH ▼ and ▲, VOL + and –)
- ㉔ INDEX button [28]
- ㉕ →0← (Zero Search) button [28]

Using the remote control

To enter the menu settings, use the ▼, ▲, ▶, ◀ or **OK** button.

The ▼ button is equivalent to the **STOP** button, the ▲ button to the **PAUSE/STILL** button, the ▶ button to the **FF** button, the ◀ button to the **REW** button and the **OK** button to the **PLAY** button.

In this manual, the explanations are based on the displayed menu screens and when doing operations within a menu screen, "press the ▼ (▲, ▶, ◀ or **OK**) button" will be indicated.

REMOTE CONTROL

Battery Installation and Operation

- 1 Install the two supplied **AA** batteries as shown.
- 2 Aim the remote control at the VCR and press the desired buttons to operate.

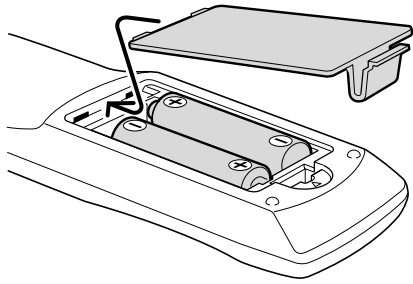

IMPORTANT NOTE:

SPENT OR DISCHARGED BATTERIES MUST BE RECYCLED OR DISPOSED OF IN A SAFE MANNER IN COMPLIANCE WITH ALL APPLICABLE LAWS.

FOR DETAILED INFORMATION, CONTACT YOUR LOCAL COUNTY SOLID WASTE AUTHORITY.

NOTES:

- The remote control will not operate properly if something comes between the VCR and the remote control.
- This infrared remote control will also control the basic functions of most Fisher TVs.

BASIC ANTENNA/CABLE CONNECTIONS

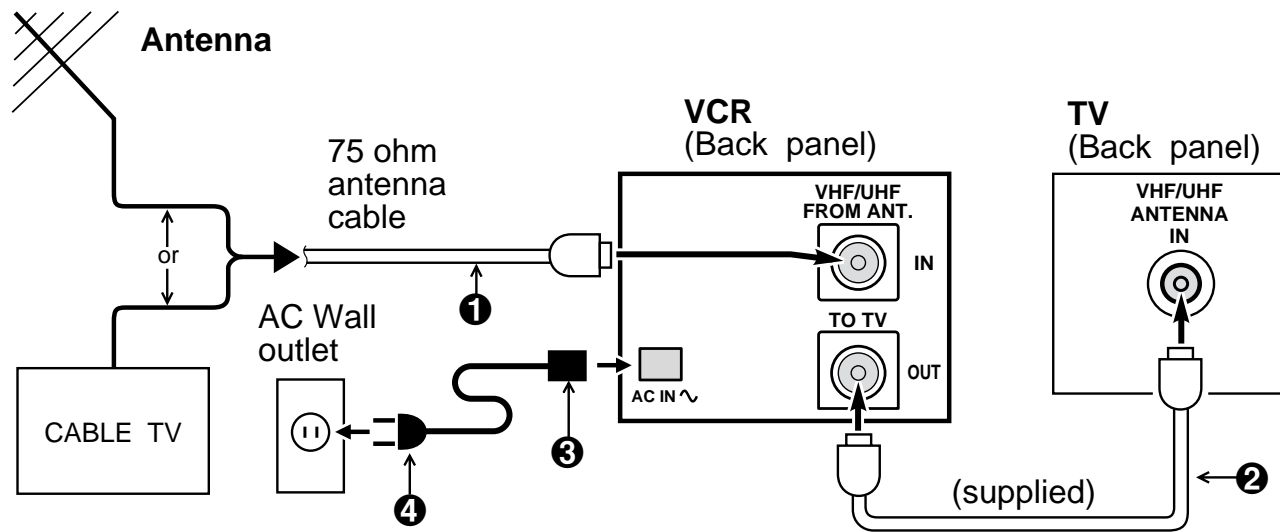

- ❶ Connect an antenna (or a cable TV system) to the VCR.
- ❷ Connect the VCR to the TV with the 75 ohm coaxial cable (supplied).
- ❸ Plug the power cord (supplied) into the AC power input (AC IN ~) on the VCR back panel. Insert the plug firmly.
- ❹ Insert the plug end of this power cord into a wall outlet.

NOTES:

- If you have a cable converter connected to your TV, see "ALTERNATIVE CABLE TV CONNECTIONS", next page.
- If your antenna has a twin-lead cable or your TV has screw-type antenna terminals, use a matching transformer (not supplied).

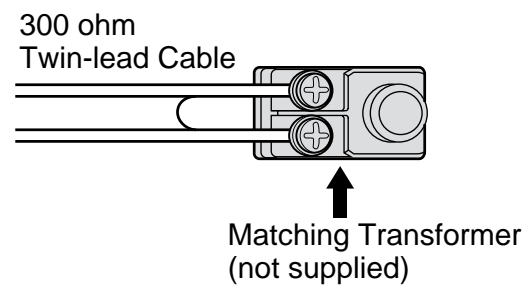

ALTERNATIVE CABLE TV CONNECTIONS

Your VCR can receive all unscrambled cable channels without the use of an external converter. If you wish to view and record scrambled cable channels, you must connect a converter/decoder as described below.

Your local cable TV company will advise you of the channels available in your area.

We recommend that you consult your cable TV company to make sure that the cable is properly connected.

When the TV does not have a built-in cable converter

Connect the cable TV converter between the VCR and the TV so that you can watch a cable TV program while recording another program.

NOTE: Set the TV channel to the cable converter output channel (CH02 ~ 07).

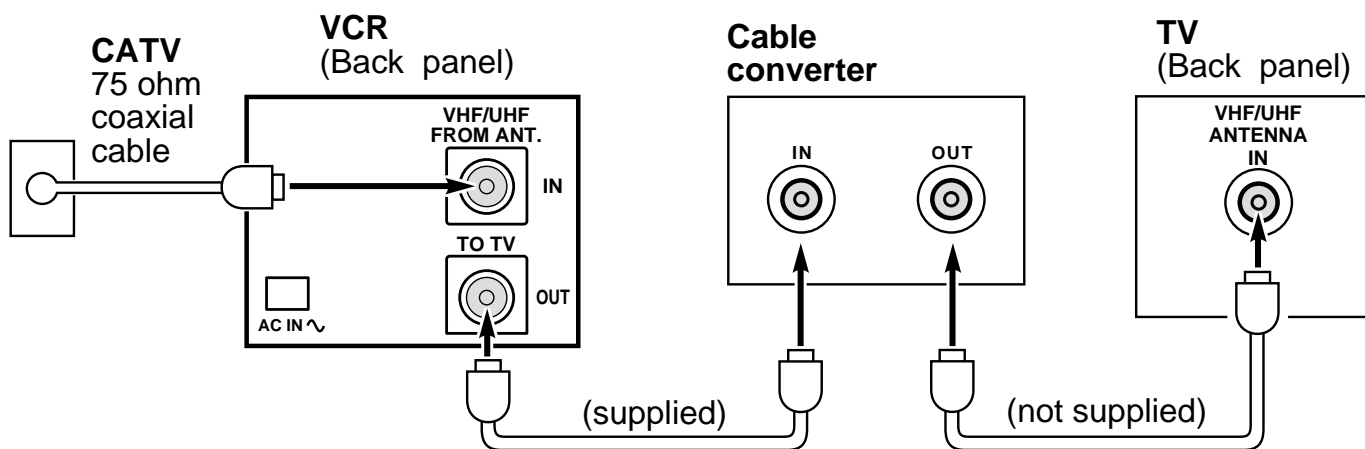

When you have both cable and pay TV (scrambled channels)

NOTES:

- With this method the TV and VCR receive the same channel. Recording one program while watching another is not possible.
- With this connection, the VCR must be set to the cable converter/decoder output channel. (See next page.)

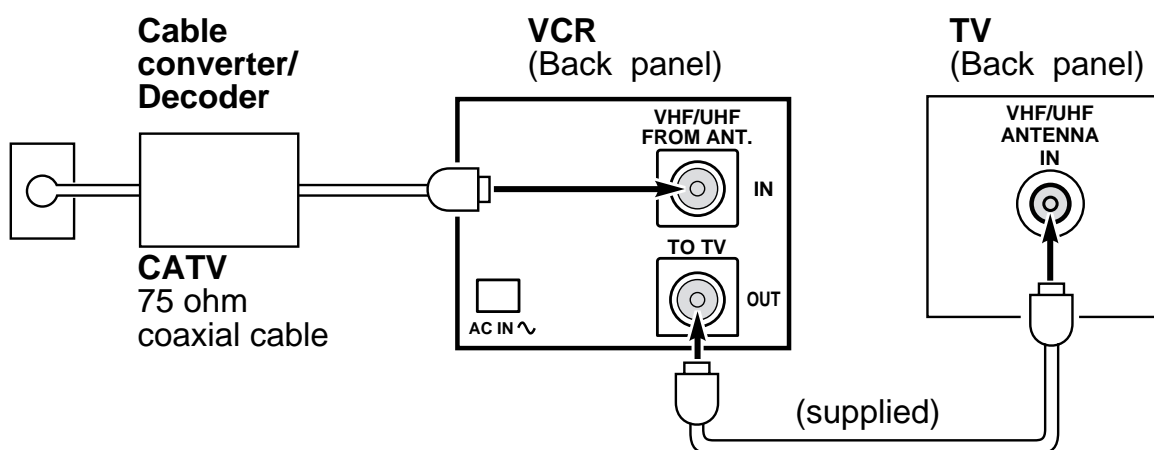

NOTE TO CATV SYSTEM INSTALLER (USA only): This reminder is provided to call the CATV system installer's attention to Article 820-40 of the NEC that provides guidelines for proper grounding and, in particular,

specifies that the cable ground shall be connected to the grounding system of the building, as close to the point of cable entry as practicable.

ALTERNATIVE CABLE TV CONNECTIONS

Cable converter/decoder output channel setup

- ❶ Be sure the cable connections are correct. (See page 10.)
- ❷ Turn on the TV, VCR and cable converter/decoder.
- ❸ Set the TV to channel 3 or 4.
- ❹ If the VCR indicator is off, press the **TV/VCR** button on the remote control.

The VCR indicator lights.

NOTE: If the initial setup has not yet been completed, the "Auto Setup" and "RF Channel Setting Ch03 (or RF Channel Setting Ch04)" message will appear. In that case, first follow steps ❹ – ❺ under "INITIAL SETUP" on page 13.

- ❺ Press the **MENU** button on the remote control.

The main MENU appears.

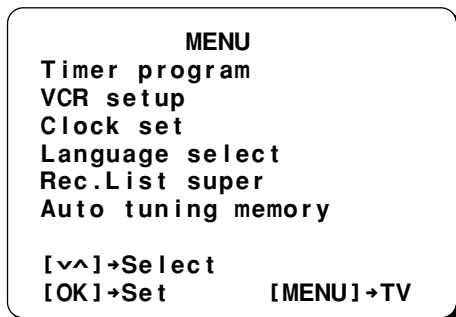

- ❻ Press the **v** (or **^**) button to select the VCR setup option, then press the **OK** button.

The VCR setup menu appears.

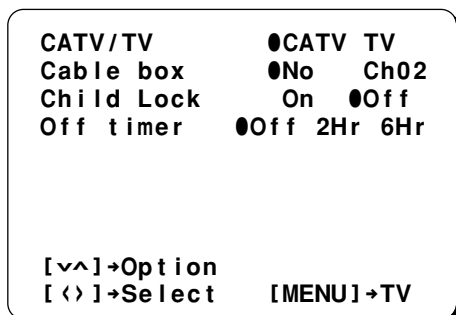

- ❼ Press the **v** (or **^**) button to select the Cable box option.
- ❽ Press the **>** (or **<**) button to set your cable converter/decoder output channel. The output channel should be indicated on the cable converter/decoder back panel. If not, please refer to the cable converter/decoder instruction manual for details.

Press the > (or <) button repeatedly. Each time you press the button, the selection changes:

→ No ↔ Ch02 ↔ Ch03 ... Ch07 ←

The selection is indicated by the "●" next to it.

NOTE: Select "No" if you are not using the cable box.

- ❾ When finished, press the **MENU** button to exit the menu display.

IMPORTANT NOTES:

When the cable converter/decoder output channel is selected as described above,

- The VCR tuner remains set to receive the same channel as the output channel of the cable converter/decoder. Auto channel programming and manual channel selection using the VCR tuner are not possible.
- If you turn on the cable converter/decoder after turning on the VCR, no image will appear on the TV screen. In this case, turn off the VCR, then turn it on again.
- Leave the cable converter/decoder on until timer recording is complete.
- For timer recordings, you must select the channel to be recorded using the channel selector on the cable converter/decoder.

AUDIO/VIDEO CONNECTIONS

The VIDEO and AUDIO outputs of your VCR can be connected separately to the input jacks of a TV monitor and an audio system. This will provide the best possible picture and sound quality, because the video/audio signals from your VCR will not have to be processed by the television tuner.

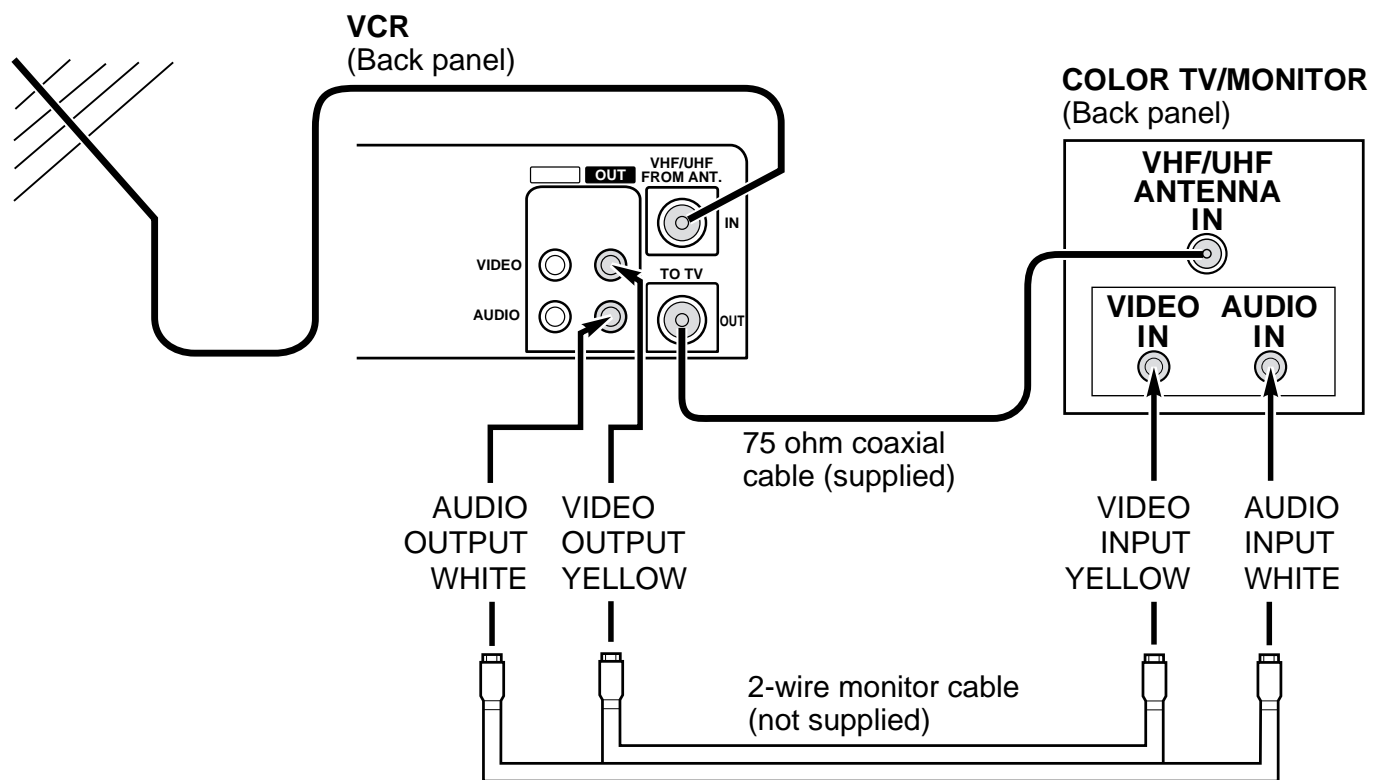

NOTES:

- Even when audio/video connections are made, always make the antenna connection between the VHF/UHF OUT (VCR) and the VHF/UHF IN (TV) using the supplied 75-ohm coaxial cable.
- If a direct audio/video connection is made between the VCR and the TV, set the source selector on the television to A/V input.

INITIAL SETUP

When you are setting up the VCR for the first time, or after the power has failed for more than 5 seconds, follow the steps below. This AUTO SETUP operation automatically sets the RF output channel, enters all available channels in your area into the VCR tuner memory and sets the VCR internal clock.

Many TV stations transmit a signal called Extended Data Services (XDS). This VCR uses the XDS signal to automatically set the clock. If no XDS signal is available in your area, the VCR prompts you to set the clock manually.

AUTO SETUP

- During AUTO SETUP, do not press any buttons other than the ones indicated here.

Before starting

- Be sure the antenna or cable connections are correct. (See pages 9 and 10.)

- 1 Press the **POWER** button on the VCR.

Auto RF output channel setting will start.

RF output channel setting rule

Channel 3	Channel 4	RF output channel
No broadcast	No broadcast	Channel 3
No broadcast	Broadcasting	Channel 3
Broadcasting	No broadcast	Channel 4
Broadcasting	Broadcasting	Channel 3

The setting is completed, and "RF-03" (or "RF-04") will light on the indicator panel.

- 2 Turn on the TV power and turn to the indicated RF channel.
- 3 If the VCR indicator is off, press the **TV/VCR** button on the remote control.

The VCR indicator will light.

The "Auto Setup" and "RF Channel Setting Ch03 (or RF Channel Setting Ch04)" message will appear.



This is your VCR channel. The TV must be set to this channel whenever the VCR is used for playing a tape or watching a TV program.

To change the RF output channel setting, press the number button 3 (or 4).

- 4 Press the **OK** button to save the RF output channel setting.

The "RF-03 (or RF-04)" display on the indicator panel will change to the clock display.

The Language select menu will appear.

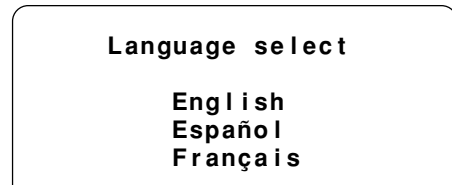

- 5 Press the **▼** (or **▲**) button to move down or up the list and highlight the language of your choice. Press the **OK** button.

The menu language is selected.

"Auto tuning memory" appears on screen. The VCR scans all 125 channels and memorizes each active channel in your area in succession. It takes about 4-6 minutes.

- 6 When Auto Tuning is completed, the VCR will select the channel that carries the XDS signal and proceed to Auto Clock setting.



The Auto Clock setting normally takes about 3 minutes. During this time, the VCR's front panel shows the channel number that is sending the XDS signal for Auto Clock setting. Make a note of this number, which you may need to refer to for readjusting the clock later (see page 18).

If the Auto Clock setting entered the incorrect date and/or time, correct it by following the steps under Automatic Clock Adjustment on page 18.

If no XDS signal is available in your area:

"Clock set" will not appear on the screen when the Auto Tuning operation is completed. Instead, the TV program on the lowest channel that the VCR memorized will appear on screen. In this case, you must set the clock manually. Follow the steps under Manual Clock Setting on page 19.

NOTES:

- The VCR will search for and memorize channels in the CATV (cable TV) mode and TV mode.
- If the AC power to the VCR is interrupted for more than 5 seconds, the memorized RF output channel, channel and clock may be erased.

INITIAL SETUP

To modify the RF output channel setting after the Auto setup is completed

- ❶ With the VCR turned off, press the **SET** button for about 3 seconds or more.
The current RF output channel setting will light on the indicator panel and will appear on the screen.
- ❷ Press the number button **3** (or **4**).
After about 5 seconds, the RF channel setting value is saved, and the VCR will turn off.

Channel Selection Convenience

You can select a channel on your VCR by using one of the two methods shown below:

10-KEY RANDOM ACCESS TUNING

Select the desired channel number by using the number buttons and **100** button on the remote control. For single-digit numbers, press **0** first. For channel numbers higher than 99, press the **100** button first.

UP/DOWN SELECTION

Press and hold the **CH/TRACK** down (▼) or up (▲) (or **CHANNEL** on the front panel) button until the desired channel is received.

NOTE: When an inactive TV channel is selected on the VCR, the "No Signal" message appears and the sound is muted.

Manual Erase

You can eliminate unwanted channels or channels with weak or scrambled signals from the memorized channel sequence.

- ❶ Select the channel you want to erase.
- ❷ Press the **CLEAR** button for about 2 seconds.
*"Erase" is displayed on-screen for about 3 seconds.
The channel is now erased from the memory.*

Manual Programming

You can add channels to the memorized channel sequence by manually adding them to the tuner memory.

- ❶ Select the channel you want to add using the number buttons on the remote control.
- ❷ Press the **SET** button for about 2 seconds.
*"Add" is displayed on-screen for about 3 seconds.
The channel is now added to the memory.*

MULTIFUNCTION ON-SCREEN DISPLAYS

Various displays appear, superimposed over the screen image, indicating the operation mode and features in use.

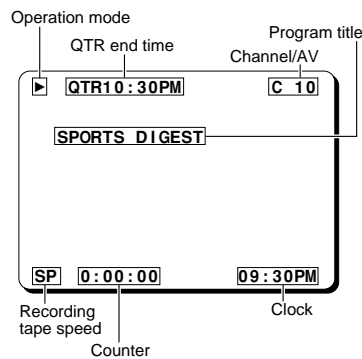

Status display

- 1 Press the **DISPLAY** button on the remote control.
The status display appears.

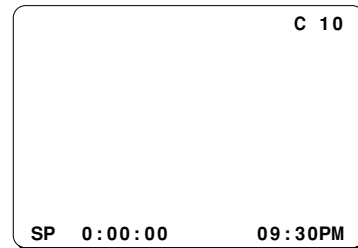

- 2 To remove the status display, press the **DISPLAY** button (press the button twice if a tape is loaded in the VCR).

NOTE: The status display will not appear if a menu is displayed on screen, or during special playback.

Remaining Tape Duration Display

- 1 Press the **DISPLAY** button twice.
The remaining tape duration appears at the bottom of the screen. It is calculated in hours and minutes from the current position to the end of the tape.



If "-- : --" is displayed, the remaining tape duration has not been calculated.

- 2 To remove the remaining tape duration display, press the **DISPLAY** button again.

NOTES:

- The remaining tape duration display will not appear if a menu is displayed on screen or during special playback.
- This feature will not work properly on T-140 tapes or tapes longer than T-160. (The feature will work on T-160 tapes.)
- Depending on the condition and type of tape used, the VCR may not accurately detect the remaining tape duration.

Operation Mode Display

When an operation button is pressed, the corresponding operation mode icon is displayed in the top left corner of the screen for about 3 seconds.

NOTE: The recording pause mode icon will remain displayed until recording is resumed or stopped.

Operation	Icon	Operation	Icon
Play	▶	Record	●
Fast-forward	▶▶	Record pause	● II
Rewind	◀◀		

Channel Number Display

The channel number display appears for about 3 seconds when a channel is selected.

Program Title Display

When a channel is tuned or when normal playback is started, the program title (maximum 24 characters) will be displayed for about 4 seconds.

NOTES:

- The program title is only displayed if the broadcast carries the title information or if it has been recorded on the tape.
- Depending on the TV signal or tape condition the program title may not be displayed even if it is available.

Recording Tape Speed Display

The recording tape speed is displayed for about 3 seconds after recording is started or when the tape speed is changed. The "SS" display means that the smart speed record function is used (see page 24).

ON-SCREEN MENU

Your new VCR is designed with user-friendly on-screen menus to help you operate its many features. Color-coded menus prompt you step-by-step through operations by highlighting the sections awaiting your entries.

Displaying the On-Screen Menus

- ❶ Turn on the power (TV and VCR).
- ❷ Set the TV to channel 3 or 4.
- ❸ If the VCR indicator is off, press the **TV/VCR** button on the remote control.

The VCR indicator lights.

NOTE: If the initial setup has not yet been completed, the "Auto Setup" and "RF Channel Setting Ch03 (or RF Channel Setting Ch04)" message will appear. Follow steps ❹ – ❻ under "INITIAL SETUP" on page 13.

- ❹ Press the **MENU** button on the remote control.

The main MENU appears.

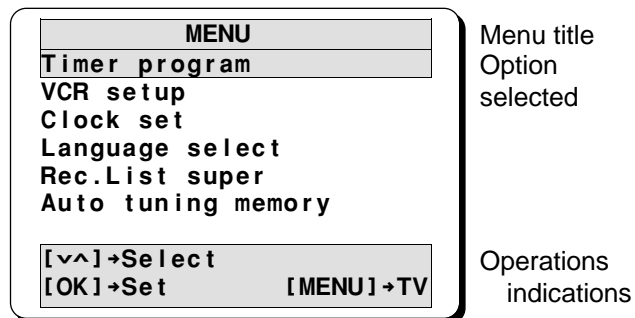

The menu items are color-coded as shown below:

- Menu title: On magenta background
- Option selected: Highlighted in green
- Operations indications: On blue background
- Others: On gray background

NOTE: If the clock has not yet been set, the Clock set menu appears. To set the clock, see "SETTING THE CLOCK" on page 18.

Press the v (or ^) button to select the desired option, then press the OK button.

- ❺ Press the **MENU** button to exit the menu.

Main Menu Options

Reference pages are shown in square brackets.

Timer program [29 – 32]

- Select this to program, check or cancel a timer recording setting.

VCR setup [17]

- Select this to set the VCR functions.

Clock set [18, 19]

- Select this to set the clock or change the clock setting.

Language select [20]

- Select this to change the on-screen language.

Rec. List super [25, 26]

- Select this to list the recordings on the tape inserted in the VCR.

Auto tuning memory [20]

- Select this to program the channels into the VCR's tuner memory.

ON-SCREEN MENU

Displaying the VCR Setup Menus

Before starting

- Turn on the power (TV and VCR).
- Set the TV to channel 3 or 4.
- If the VCR indicator is off, press the **TV/VCR** button on the remote control.

The VCR indicator lights.

- 1 Press the **MENU** button on the remote control.

The main MENU appears.

- 2 Press the **▼** (or **▲**) button to select the VCR setup option, then press the **OK** button.

The VCR setup menu appears.

CATV/TV	●CATV TV
Cable box	●No Ch02
Child Lock	On ●Off
Off timer	●Off 2Hr 6Hr

[**▼▲**]→Option
[**◀▶**]→Select [MENU]→TV

- 3 Press the **▼** (or **▲**) button to highlight the desired option.
- 4 Press the **▶** (or **◀**) button once or more to move the "●" indicator in front of your selection.
- 5 When finished, press the **MENU** button to save the settings.

VCR Setup Menu Options

Reference pages are shown in square brackets.

CATV/TV [20]

- Indicate whether you subscribe to cable TV or use antenna.

Cable box [11, step ③]

- If you use a cable converter/decoder (cable box), set the output channel.

Child Lock [34]

- Select this to block picture and sound.

Off timer

- Select this to set the VCR to automatically shut off after a specified period of non-operation.

Off: The power will not be turned off automatically.

2Hr: The power is turned off after 2 hours.

6Hr: The power is turned off after 6 hours.

NOTE: The Off timer begins counting down after the last VCR activity. Approximately 5 minutes before the power is turned off, the "Your VCR will be off shortly" message is displayed.

SETTING THE CLOCK

Generally, during the initial setup, your VCR will automatically set the clock by detecting a channel that is transmitting the XDS (Extended Data Services) signal. However, if the XDS signal necessary for Automatic Clock Setting was poor or unavailable at the time, Automatic Clock Setting may not have been possible. Follow the steps below to set the clock.

Before starting

- Turn on the power (TV and VCR).
- Set the TV to channel 3 or 4.
- If the VCR indicator is off, press the **TV/VCR** button on the remote control.

The VCR indicator lights.

- 1 Press the **STOP** button, then enter the channel number that you have made note of during Automatic Clock Setting (see page 13).
- 2 Press and hold the **PAUSE/STILL** button for more than 2 seconds.

If the channel is transmitting the XDS signal, "Clock set" starts blinking on screen after approximately 4 seconds.

When Automatic Clock Setting is completed, the screen shows the current TV program.

If the screen returns to the current TV program immediately, the XDS signal for clock setting is not available in your area. Use the Manual Clock Setting procedure on page 19.

NOTE: If the Automatic Clock Setting procedure set the wrong clock time, follow the steps under Automatic Clock Adjustment.

Automatic Clock Adjustment

- 1 Press the **MENU** button.
The main MENU appears.
- 2 Press the **▼** (or **▲**) button to select the Clock set option, then press the **OK** button.

The Clock set menu appears.

```

          Clock set
          03/07[Wed]2001 09:30 PM
          Clock adjust ●Auto Off

          [DISPLAY]→Clock adjust
          [▼▲]→Day/STD shift
          [▶]→AM/PM
          [◀]→Cancel
          [OK]→Set
  
```

- 3 Press the **◀** button until the wrong clock setting is erased, then enter the correct time.
- 4 Press the **DISPLAY** button to set the Clock adjust option to Off.
- 5 When finished, press the **OK** button to exit from the menu.

When you set the Clock adjust option to Auto, the time will automatically be adjusted twice a week (every Sunday at 3:00 AM and 6:00 AM) according to the XDS signal.

If the automatic clock setup procedure enters the wrong time, make sure to select Off for the Clock adjust option. If set to Auto, an incorrect time will be entered again at the next automatic clock adjustment.

NOTES:

- The Clock adjust option appears only when the clock has been set automatically.
- The automatic clock adjustment will not be performed if the power is on, or if a program timer recording is set to start within 5 minutes of the automatic clock adjustment times (2:55 AM – 3:05 AM and 5:55 AM – 6:05 AM).
- If using a cable converter/decoder, the automatic clock adjustment may not function properly.

SETTING THE CLOCK

Manual Clock Setting

- ❶ Follow the steps in **Before starting**.
- ❷ Press the **MENU** button.
The main MENU appears.
If the clock has not yet been set, the Clock set menu appears.
- ❸ Press the **▼** (or **▲**) button to select the Clock set option, then press the **OK** button.
The Clock set menu appears.

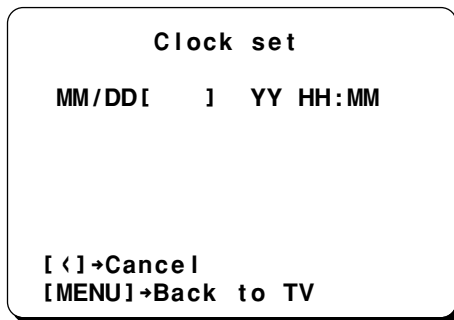

- ❹ Press the number buttons (**0 – 9**) to set the date and time.
 - **EXAMPLE:** Setting the clock to standard time.
March 7, 2001, 9:30 PM (03/07/01, 9:30 PM).
 - Date March 7: Press **0 – 3 – 0 – 7**
 - Year '01: Press **0 – 1**
 - Time 9:30: Press **0 – 9 – 3 – 0**
 - PM: Press **>**

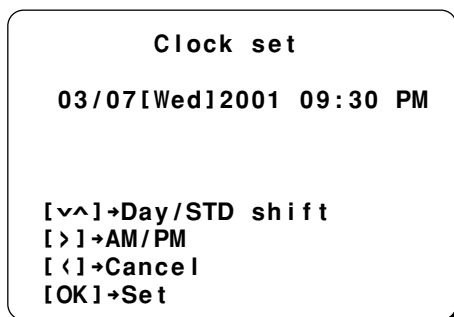

NOTES:

- When entering the year, press the two number buttons that correspond to the last two digits of the year (i.e. 00 for 2000, 05 for 2005 or 25 for 2025).
 - If you press the wrong button, press the **<** button to erase the wrong number. Then press the correct button to continue.
- ❺ When finished, press the **OK** button to save the settings.

Standard/Daylight Time Adjustment

The clock time can be easily changed to daylight saving time (by adding one hour) or standard time (by subtracting one hour).

- ❶ Press the **MENU** button.
The main MENU appears.
- ❷ Press the **▼** (or **▲**) button to select the Clock set option, then press the **OK** button.
- ❸ Press the **▼** (or **▲**) button.
Every time the ▼ (or ▲) button is pressed, 1 hour is subtracted (or added) to the displayed time.
- ❹ When finished, press the **OK** button to save the settings.

CHANGING THE MENU LANGUAGE

English, Spanish or French can be selected by the user.

Before starting

- Turn on the power (TV and VCR).
- Set the TV to channel 3 or 4.
- If the VCR indicator is off, press the **TV/VCR** button on the remote control.

The VCR indicator lights.

- 1 Press the **MENU** button.

The main MENU appears.

- 2 Press the **▼** (or **▲**) button to select the Language select option, then press the **OK** button.

- 3 Press the **▼** (or **▲**) button to select the language of your choice, then press the **OK** button.

The Language select menu disappears, and the on-screen menu language has been selected.

PROGRAMMING CHANNELS

Once the initial setup is completed, the channels can be programmed again. This may be necessary if you are switching from cable service to antenna reception.

NOTES:

- Make sure the antenna or cable connections are correct. (See pages 9 and 10.)
- If the input source is set to L1, press the **INPUT** button on the remote control until the indicator panel shows a channel number.

Channel Programming

- 1 Follow the steps in **Before starting** above.
- 2 Press the **MENU** button.
The main MENU appears.
- 3 Press the **▼** (or **▲**) button to select the VCR setup option, then press the **OK** button.
The VCR setup menu appears.

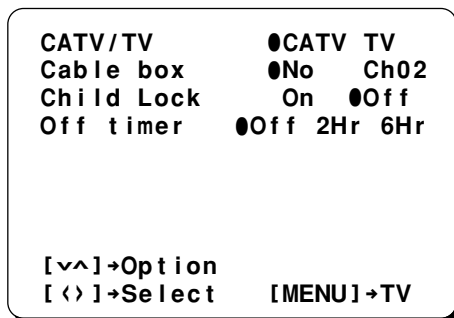

- 4 Press the **▼** (or **▲**) button to select the CATV/TV option, then press the **▶** (or **◀**) button to select "CATV" (if you subscribe to a cable TV service) or "TV" (for normal broadcast reception through an antenna).

The CATV indicator "C" displayed on the indicator panel means that the cable TV system is selected.

- 5 Press the **MENU** button twice.

The main MENU appears.

- 6 Press the **▼** (or **▲**) button to select the Auto tuning memory option, then press the **OK** button.

The VCR programs all unscrambled channels that are available in your area into the tuner memory.

The "Auto tuning memory" message is displayed while the channels are automatically set.

VIEWING TV ONLY

You do not need to disconnect the VCR from the TV in order to watch a TV program without recording it.

- 1 Turn off the VCR.
- 2 Turn on the TV and set it to the channel you want to watch.

PLAYING A RENTAL TAPE

When you load a cassette with the safety tab removed, the VCR starts playing it automatically.

Before starting

- Turn on the TV.
- Set the TV to channel 3 or 4.

This VCR features full automatic playback and rewind. Load a cassette (with the safety tab removed).

- The power turns on automatically and playback begins.
- At the end of the tape, the VCR stops, then rewinds.
- The cassette is ejected after rewinding.

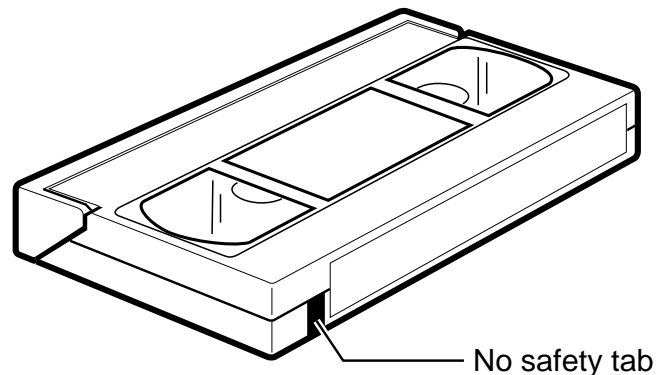

BASIC OPERATION

Playback of Copyguarded Tapes

Some prerecorded tapes employ a copyguard system that may cause intermittent distortion in the upper portion of the picture during playback. (This distortion is more likely to be visible on an older TV.) If you experience this problem, do the following:

- 1 Select a TV station with a strong, clear signal.
- 2 Record a brief segment of that station's programming.
- 3 Play back the recording.

If the playback picture is clear, the VCR is operating properly. The distortion on the prerecorded tape is due to the copyguard system.

NORMAL PLAYBACK

Before starting

- Turn on the power (TV and VCR).
- Set the TV to channel 3 or 4.
- Load a cassette.

Digitally-Adjusted Clean Playback

Advanced technology developed by Fisher enables your VCR to detect imperfections in the condition of a recording (an old recording that has been played back many times, for example) then automatically adjust the playback signal to deliver the best possible image.

- 1 Press the **PLAY** button.

Normal playback begins.

The tape counter starts.

The tape stops and rewinds when the end of the tape is reached.

- 2 Press the **STOP** button (or **STOP/EJECT** on the front panel) to stop playback.

- To rewind the tape, press the **REW** button.
- To fast forward the tape, press the **FF** button.

NOTES:

- When the tape comes to a blank segment during playback, the "No Signal" message appears and the sound is muted.
- If the playback picture shows noise or no video at all while audio is properly heard, first try the manual tracking adjustment. If this does not correct the problem, it may indicate that the video heads need maintenance. Contact an authorized service center.

TRACKING CONTROL

Tracking Control Adjustments

When you play a tape that was not recorded on this VCR, some noise may appear in the picture due to incorrect head-to-tape tracking.

The VCR will automatically adjust the tracking for the optimum results.

If noise still appears:

MANUAL TRACKING CONTROL

- 1 Press and hold the **CH/TRACK** ▼ or ▲ button (or **CHANNEL** on the front panel) during playback to eliminate the noise streaks from the picture.

The automatic tracking control mode is canceled.

To return to automatic tracking, eject the cassette, then reinsert it.

RECORDING

Before starting

- Turn on the power (TV and VCR).
- Set the TV to channel 3 or 4.
- If the VCR indicator is off, press the **TV/VCR** button on the remote control.

The VCR indicator lights.

- Press the **INPUT** button on the remote control to select the tuner mode. (See "Recording Input Options".)

A channel number appears.

- Load a cassette.

Rec. List Super Feature

The Rec. List Super feature lets you keep track of all recordings you make on this VCR. The information automatically includes the channel number, date and start time. In addition you have an option to add the program type to the information list. See page 25 for more detailed instructions on the Rec. List Super feature.

Recording One Program While Viewing Another

- 1 Follow the steps 1 – 3 in "RECORDING".

- 2 Press the **TV/VCR** button.

The VCR indicator goes off.

- 3 Tune the TV to the channel you want to watch.

NOTES:

- If you have connected your cable converter/decoder to the input of the VCR, recording one program while watching another is not possible.
- If audio/video connections are made between the VCR and the TV, set the source selector on the television to TV.

Recording Input Options

You can record not only from the VCR tuner (TV programs), but also from the external equipment (i.e., another VCR, camcorder or digital camera) connected to the rear-panel A/V inputs.

Before starting to record, make sure the correct input source is shown in the front-panel indicator. If not, press the **INPUT** button on the remote control until you see the correct input source.

Recording source	Indicator shows:
VCR Tuner (TV programs)	Selected channel number
External unit connected to the rear-panel A/V jack	L1

- 1 Select a channel to record (on the VCR).

- 2 Press the **SP/SLP** button on the remote control to select the tape record speed, if necessary.

Selected Tape Speed indicator lights.

If the SP and SLP indicators are both on, the smart speed function is set (see the next page).

- 3 Press the **REC** button.

The Record indicator (REC) lights.

Recording begins.

RECORD AUTO CANCEL: Recording will not start if the safety tab has been removed from the cassette. The cassette will automatically be ejected.

- 4 Press the **PAUSE/STILL** button to temporarily stop recording (record pause mode).

The Pause/Still indicator (□□) blinks.

*During the pause, if you want to change the channel, press the **CH/TRACK** ▼ or ▲ button on the remote control (or **CHANNEL** on the front panel).*

If the record pause mode continues for approximately 5 minutes, the VCR automatically stops recording.

- 5 Press the **REC** button, or press the **PAUSE/STILL** button again.

The Pause/Still indicator goes off.

Recording continues.

- 6 Press the **STOP** button (or **STOP/EJECT** on the front panel) when you want to stop recording.

The Record indicator goes off.

RECORDING

Smart Speed Record Function

When the Smart Speed Record function is set, the VCR automatically calculates the remaining time left on the tape during recording. If there is not enough time left for the program to be recorded, the VCR switches the recording speed from SP (standard play) to SLP (super long play) to enable the entire program to fit onto the remaining tape.

- To set the Smart Speed Record function, press the **SP/SLP** button until "SS" is displayed on-screen at the Recording tape speed display position (or both SP and SLP indicators light on the indicator panel).

Recording will start in SP mode. During recording, based on a calculation using the remaining tape and the XDS signal information, if the remaining tape duration is not enough to record the program to the end, the recording speed will be automatically switched to SLP mode. If the necessary information is not contained in the received XDS signal, the recording will be done in SP mode.

For example, when recording a 150-minute program onto a T-120 (120-minute) tape:

The recording will be done in SP mode for almost 105 minutes and in SLP mode for the last 45 minutes.

During Smart Speed Recording, the current recording speed indicator will flash on the display.

During Smart Speed Recording, SS will appear on the screen.

NOTES:

- During timer recording, the set end time will be considered as the time the program ends.
- If during Quick Timer Recording (QTR), the end time is set using the **REC** and/or **CH/TRACK** ▼ (or ▲) buttons, the duration until the set end time will be considered as one single program.
- This feature will not work properly on T-140 tapes or tapes longer than T-160. (The feature will work on T-160 tapes.)
- If two or more timer recordings are programmed, all the programs may not fit onto a single tape. In that case, make sure the Smart Speed Record mode is not set, and select the recording speed manually.
- There may be some interference in the image at the point where the speed has been switched.
- If a program to be taped cannot fit into the remaining time left on the tape, even in SLP mode, the program will not be recorded till the end.

Rec. List SUPER

Rec. List (Recording Contents List) Super

Every time a recording is made with this VCR, the channel number, date and start time information is automatically recorded on the tape. When you call up the Rec. List super menu, the VCR scans the information on the tape and displays it on screen. You can then use the menu to easily find a desired recording and play it back at the touch of a button.

The Rec. List super feature also gives you the option of adding the type (or title) of program you record to the list. To use this option, you must select the type name using the Type input menu before setting up the recording. See next page for more detailed instructions.

- ❶ Load a cassette that has been recorded on this unit.
- ❷ Press the **MENU** button.
The main MENU appears.
- ❸ Press the \downarrow (or \uparrow) button to select the Rec. List super option, then press the **OK** button.
The Rec. List super menu appears.

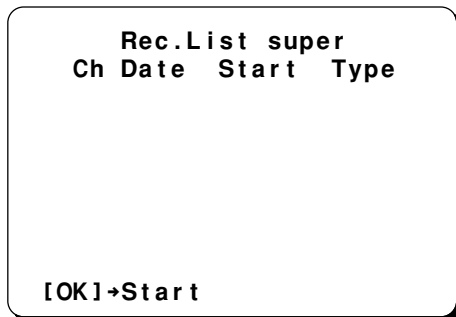

NOTE: If no cassette tape is loaded, the Rec. List super menu will not be displayed.

- ❹ Press the **OK** button.
The tape rewinds to the beginning. Then the VCR begins scanning the tape for the Rec. List super information and when detected, displays it on screen. Wait for the desired recording to be listed.

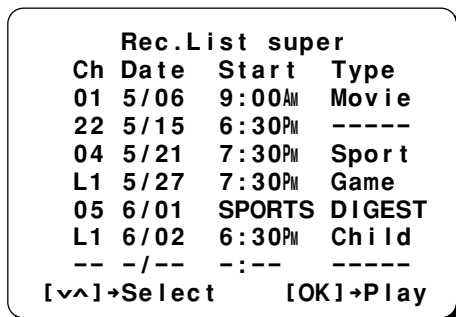

- ❺ Press the **STOP** button, if the desired recording is listed.
- ❻ Press the \downarrow (or \uparrow) button to set the desired recording, then press the **OK** button.
“Searching” will flash on screen while the tape rewinds to the beginning of the selected recording. Playback will start automatically.

NOTES:

- To cancel the operation, press the **STOP** button. The scanned section of the list will be kept in the VCR memory until the tape is removed from the VCR.
- The scanned Rec. List super information will be kept in the VCR memory until the tape is removed from the VCR.
- When 8 or more recordings are found on the tape, the list scrolls up, and the last 7 recordings are listed.
- The list shows “--” for the sections where there is no data or the data is unreadable (recorded by another VCR, for example).
- A recording shorter than 5 minutes may not be listed.
- When a second selection for playback is made (after having played the first selection), the tape first rewinds to the beginning before searching for the selected recording.
- If a new recording is made over an old one, the Rec. List super information from the old recording will be deleted.
- If the tape is ejected while the recording list menu is displayed, the menu disappears.

Rec. List SUPER

Entering the Program Type

To have the program type included in the Rec. List super menu, you must enter the program type before proceeding to step ① of "RECORDING" on page 23.

- The clock must be set before the program type can be selected.

- ① Press the **TYPE** button on the remote control.

The Type input menu will be displayed on screen.



- ② Press the **TYPE** button repeatedly until the desired program type is displayed.

Each time the TYPE button is pressed, a different type, "-----"-Movie-Talk-Sport (Sports)-Game-Soap-News-Child-Auto is displayed.

Auto: If the recorded program transmission carries title information, it will automatically be entered. Then, when using the Rec. List super function, the title will be displayed (up to 15 characters).

"-----": The program type is not set.

Other settings: When using the Rec. List super function, the setting entered here will be displayed as the program type.

- ③ Press the **SET** button to enter the settings.

The entered type code (e.g. Movie → MO) will be displayed for about 3 seconds on the indicator panel.

NOTES:

- To enter the selected program type, press the **SET** button within 10 seconds after selecting a program type.
- Program types set manually have priority over automatic settings.
- After pressing the **POWER** button (to switch off the power), or ejecting the cassette, the selected type will be cancelled if no recording have been made.

SPECIAL PLAYBACK

Picture Search (Forward and Reverse)

- ❶ Press the **FF** or **REW** button during normal playback.
The picture plays forward or backward rapidly.
- ❷ Press the **PLAY** button to resume normal playback.

FR (Fast Response) Search

- ❶ Press the **FF** button (in fast forward mode) or the **REW** button (in rewind mode).
The forward or reverse picture can be viewed.
- ❷ Press the **FF** or **REW** button again to return to the fast forward or rewind mode.

Still Image

- ❶ Press the **PAUSE/STILL** button during normal playback.
*The Pause/Still indicator (□□) blinks.
A still image appears on the screen.*
- ❷ Press the **PLAY** button to resume normal playback.

Slow Motion

- ❶ Press the **SLOW** button on the remote control during normal playback.
*Slow motion playback starts.
The slow-motion playback speed switches between 1/5 and 1/30 of normal playback each time the **SLOW** button is pressed.*
- ❷ Press the **PLAY** button to resume normal playback.

Frame Advance

- ❶ Press the **PAUSE/STILL** button repeatedly during still mode.
The picture advances one frame at a time.
- ❷ Press the **PLAY** button to resume normal playback.

Double Speed Playback

- ❶ Press the **x2** button during normal playback.
The picture plays back at about 2 times the normal playback speed.
- ❷ Press the **PLAY** button to resume normal playback.

Endless Playback

This function will play back a tape to the end, rewind it and then replay and rewind over and over until you stop it.

- ❶ In the stop or playback mode, press and hold the **PLAY** button on the front panel, then while holding it down press the **REW** button on the front panel.
The tape rewinds to the beginning, then endless playback starts.

- ❷ Press the **STOP** button (or **STOP/EJECT** on the front panel) to cancel endless playback.

NOTE: If an operation button is pressed during endless playback, the function is cancelled.

If noise appears on double-speed or slow motion play:

Press and hold the **CH/TRACK** ▼ (or ▲) button (or **CHANNEL** on the front panel) to reduce the noise.

If noise appears on a still picture:

Start slow motion play, and then repeat the operation above.

- This adjustment also corrects tracking errors for a still picture.

If the picture is unstable (vertical jitter) during double speed playback, still or slow motion modes

- ❶ Press the **PLAY** button.
 - ❷ Press the **PAUSE/STILL** button.
A still image appears on the screen.
 - ❸ Press and hold the **CH/TRACK** ▼ or ▲ button (or **CHANNEL** on the front panel) to reduce the vertical jitter.
- This adjustment also corrects tracking errors during double speed playback and slow motion playback.

NOTES:

- During special effects playback, the sound is muted.
- Noise bands (narrow white lines in the picture) may appear during picture search. This is normal and cannot be eliminated by using the tracking control.
- After staying in still or slow motion playback for 5 minutes, the VCR automatically stops.

ZERO SEARCH

Use the zero search function to go back to the beginning of a program immediately after you have recorded it.

- ❶ Press the **DISPLAY** button.
The status display appears.
- ❷ Press the **RESET** button.
The tape counter resets to 0:00:00.
- ❸ Begin playback or recording.
- ❹ Press the **STOP** button (or **STOP/EJECT** on the front panel) to stop playback or recording.
- ❺ Press the **→0←** button.
“▶▶ 0:00:00 ◀◀” is displayed on screen for about 3 seconds.
The tape rewinds and will stop at or near the counter zero (“0:00:00”) position.

NOTES:

- The tape counter indicates tape elapsed time in hours, minutes and seconds.
- When you eject a cassette, the tape counter resets to 0:00:00.
- The tape counter does not operate when a blank tape or a blank portion of a tape is played.
- If the tape is rewound beyond the 0:00:00 counter reading, a negative indicator (–) appears.

INDEX SEARCH

You can easily return to the beginning of the current program or skip to the beginning of the next program and start playback.

- **EXAMPLE:** To skip to the next program.
- ❶ Press the **INDEX** button in the play or stop mode.
“◀◀ Index Search ▶▶” will be displayed on-screen.
- ❷ Press the **FF** button.
The tape quickly advances to the beginning of the next program.
Playback begins.

NOTES:

- There may be a slight discrepancy between the position shown on the tape counter and the actual tape position.
- Each time a recording is made, an index code is automatically placed on the tape at the beginning of the recording.
- When a recording is resumed after a record pause, no index code is marked.
- The index codes cannot be individually erased. However, when recording over an indexed tape, the old index codes will be erased along with the programs.

INDEX SEARCH Operation

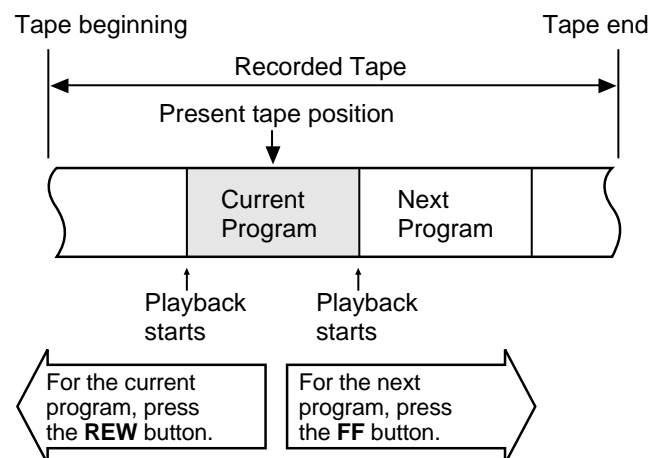

PROGRAM TIMER RECORDING

The Program Timer switches your VCR on and off to record a TV program at a preset time. On any occasion, you can preset a maximum of 8 programs to be recorded during the next 1-year period.

You can also set any of the 8 time slots to repeatedly record the same channel at the same time daily (Monday through Friday) or weekly. Daily and weekly settings are retained in the timer memory and will continue to cue the VCR to record as long as tape is available.

During timer programming, you may want to take advantage of convenient features that give you the option of saving the title/type of program being recorded (Rec. List Super, page 25), having the VCR automatically set the proper tape speed (Smart Speed Record Function, page 24), and having the VCR automatically adjust the start and stop times (Smart Time Record Function, page 30).

NOTE: The clock time must be set before a timer recording can be programmed.

Timer Programming

- 1 Follow the “**Before starting**” steps, under “RECORDING” on page 23.
- 2 Press the **MENU** button.
The main MENU appears.
- 3 Press the **OK** button.
The Timer program menu appears.

Ch	Date	Start	End
--	M/DD	H:MM	H:MM SP
--	-/--	-:--	-:-- --

- 4 Press the number buttons (0 – 9) to set the timer program.
 - **EXAMPLE:** To record a program on channel 10 once (Once recording mode) on March 9, from 09:00 PM to 10:30 PM, using the SLP recording speed (March 9 = 03/09).
 - Channel 10: Press 1 – 0
 - Date March 9: Press 0 – 3 – 0 – 9
 - Daily/Weekly setting: Press >

Timer Recording Modes

- Daily (M-F):** Records a program at the same time, Monday through Friday.
- Weekly (WK):** Records a program on the same day and time each week.

Each time the > button is pressed, a different recording mode (Daily – Weekly – Once) is selected.

Set the start and end time.

Start time 9:00 PM: Press 0 – 9 – 0 – 0 –>
End time 10:30: Press 1 – 0 – 3 – 0

The end time AM/PM setting will be entered automatically.

NOTE: If you press the wrong button, press the < button to erase the wrong number. Each time the < button is pressed, the previous number will be erased. Press the correct button to continue.

- 5 To change the recording tape speed, press the **SP/SLP** button.

For automatic speed selection, select “SS” for tape speed. (See Smart Speed Record Function on page 24.)

Ch	Date	Start	End
10	3/09Fr	9:00PM	10:30PM SLP
--	-/--	-:--	-:-- --

- 6 Press the **OK** button.

If you do not want to use other options, proceed to step 1.

Continued on the next page. →

PROGRAM TIMER RECORDING

- 7 Press the **TYPE** button.

The Type and Smart Time Rec. setting menu appears.

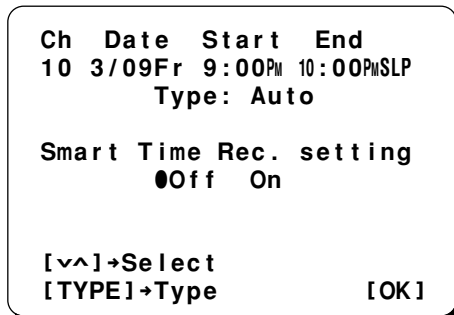

- 8 Press the **TYPE** button repeatedly to select the correct program type. (See Entering the Program Type on page 26.)
- 9 Press the **v** (or **^**) button to select the Smart Time Rec. setting option.
- 10 Press the **TYPE** button repeatedly to select the correct rating. (See Smart Time Record Function on page 30.)
- Each time you press the **TYPE** button, the selection changes: OFF → TV-Y → TV-Y7 → TV-G → TV-PG → TV-14 → TV-MA → G → PG → PG-13 → R → NC-17 → X.*
- Select OFF if you are not using the Smart Time Record function.*
- 11 Press the **OK** button.
- The next timer recording slot can be programmed.*
- When two or more program timer recordings are set, they will be listed in chronological order of the recording start times with the earliest time listed first.*
- 12 When finished, press the **MENU** button to exit the menu.
- 13 Press the VCR **POWER** button.
- The VCR power turns off and the timer is set to the recording standby mode.*
- The Timer icon (⏸) appears.*

Smart Time Record Function

Sometimes, TV program start or end times are later than published schedules. With the Smart Time Record function, the VCR is informed of the altered times and adjusts Program Timer recording to the actual broadcast time.

This function operates by recognizing program rating signals incorporated into broadcasts. When you have programmed the timer up to step 6, you can call up the Type and Smart Time Rec. setting menu by pressing the **TYPE** button on the remote control and then follow steps 7 through 11 on page 30.

Not all TV stations transmit rating information signals.

NOTES:

- If more than one programmed recording set with the Smart Time Record function is delayed, the VCR will wait (up to 3 hours) for the first one to be broadcast and that program will have priority over the other programmed recordings.
- If the option Auto A/V select is set to "On" and the input at the front A/V input connectors is being viewed, when a program is delayed, the message "Smart Time Rec." will flash from the scheduled start time (setup on the VCR) to the actual start time of the program broadcast (up to a maximum of 3 hours).
- If the start time of a programmed recording not using the Smart Time Record function is reached during the start time wait period for a delayed recording programmed with the Smart Time Record function, the recording programmed without the Smart Time Record function will have priority and will first be recorded to the end.
- If the Smart Time Record function is set after having set the Smart Speed Record function, the tape speed will change to SLP and the Smart Speed Record function will not operate. Note that even if the Smart Time Record function is set to "Off", the tape speed will remain as set and will not return automatically to its previous setting.
- If the program transmission start time is delayed more than 3 hours the function will be canceled.
- If the previous and following programs are not rated, and the desired program broadcast time is changed, the unit may record some of the previous or following program.

PROGRAM TIMER RECORDING

Setting a Program Timer Recording Using the Buttons on the VCR

If the remote control does not operate or is not available you can use the buttons on the VCR front panel to set a program timer recording.

NOTE: Eject the cassette tape, before proceeding with the steps below.

- ❶ Press and hold the **REC** button on the front panel for about 5 seconds.

The Timer program menu appears.

If the clock has not yet been set, the Clock set menu appears.

*If necessary, the clock can also be set using the **CHANNEL** ▼ (or ▲) and **FF** buttons. (Refer to the next step for button functions.)*

- ❷ Use the **CHANNEL** ▼ (or ▲) and **FF** buttons on the VCR front panel to program the timer.

CHANNEL button: To select numbers or switch settings

FF button: To select the next item

NOTE: If you enter the wrong number or setting, press the **REW** button to return to the wrong number or setting, then enter the correct one.

- ❸ When the recording tape speed is set, press the **FF** button on the front panel to save the settings.
- ❹ When finished, press the **REC** button on the front panel to exit from the menu.
- ❺ Load a cassette.
- ❻ Press the **POWER** button.

NOTES:

- Daily or weekly recording, or the program type cannot be set using this method.
- Once a program timer recording has been set, it cannot be erased using the buttons on the VCR front panel.

Checking the Program Timer

- ❶ Turn on the power (TV and VCR).

- ❷ Set the TV to channel 3 or 4.

- ❸ Press the **MENU** button.

The main MENU appears.

- ❹ Press the **OK** button.

The programmed recordings are listed.

NOTE: To display the program type or rating, press the **TYPE** button after selecting the desired program using the ▼ (or ▲) button.

- ❺ When finished, press the **MENU** button to exit the menu.

- ❻ Press the **POWER** button.

The VCR power turns off and the timer is set to the recording standby mode.

The Timer icon (⏸) appears.

Clearing the Program Timer

- ❶ Follow steps ❶ – ❹ in “Checking the Program Timer”.

- ❷ Press the ▼ (or ▲) button to select the program to be cleared.

- ❸ Press the **CLEAR** button.

The erase confirmation screen appears.

- ❹ Press the **CLEAR** button again. (To cancel the erase procedure, press the **SET** button.)

The selected timer program is erased from the program memory.

- ❺ When finished, press the **MENU** button to exit the menu.

- ❻ Press the **POWER** button.

Changing the Program Timer

- ❶ Follow the steps under “Clearing the Program Timer” to erase the program that you wish to change.

- ❷ Follow the steps under “Timer Programming” to add a new timer program.

PROGRAM TIMER RECORDING

Using Timer Recording for Several Programs

If two or more programmed recording times overlap on the same day, the VCR will not begin recording a new program until the previous program has ended (as shown below).

Program Recording Order

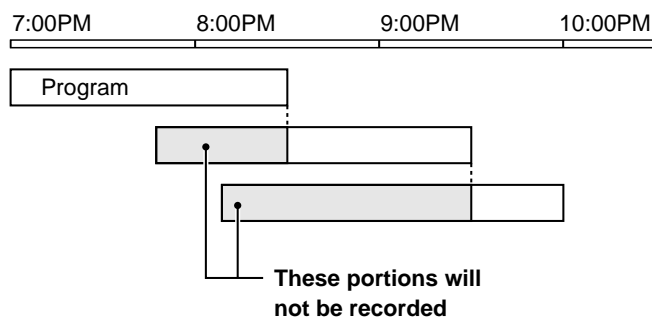

TIMER SETTING NOTES:

- If the programmed recording falls on a Saturday or a Sunday, the Daily recording mode will not be possible.
- To select the A/V recording mode, press the **INPUT** button instead of selecting a channel number.
- 12:00 PM = noon; 12:00 AM = midnight.
- If the end of the tape is reached during timer recording, the VCR stops and the power turns off automatically.
- **If the power fails or the VCR is unplugged from the AC outlet, the correct clock time and timer settings are kept in memory for approximately 5 seconds. After 5 seconds, the clock and program timer must be reset when power is restored. Refer to INITIAL SETUP to set the VCR.**

QUICK TIMER RECORDING (QTR)

As the name suggests, the QTR feature provides a quick and simple way to set the timer to record. A QTR setting overrides Program Timer settings.

- The clock must be set before Quick Timer Recording can be performed.
- To set the type of the recording, first follow the steps under Entering the Program Type on page 26.
- Start a recording following the instructions for "RECORDING", steps ❶ – ❸ on page 23.

- ❶ Press the **REC** button during recording.

"-- : --" appears on the VCR display.

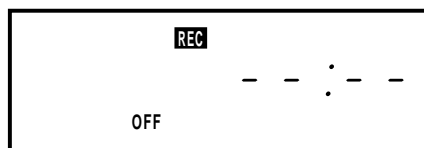

- ❷ Set the recording end time using the **REC** button (to advance the time in 30-minute increments to the nearest hour or half hour) or the **CH/TRACK** ▼ (or ▲) button (or **CHANNEL** on the front panel) (to increase or decrease the time in 1-minute increments).

Auto Setting

If an XDS-encoded broadcast is being recorded, "AUTO" appears at step ❶ above and blinks for 10 seconds in the display. The VCR timer receives the end time information from the XDS signal and the recording continues until the end of the program.

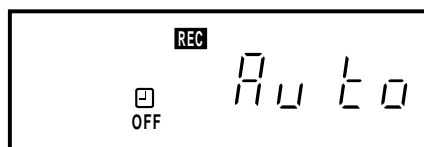

Notes on using the AUTO setting

- To set the recording end time manually, press the **REC** button while "AUTO" is blinking. The display will switch to "-- : 30" or "-- : 00". Then use the **REC** button and/or the **CH/TRACK** ▼ (or ▲) button to set the recording end time.
- Depending on the reception conditions of TV signal or remaining program duration, the AUTO QTR operation may not be accurate.

NOTES:

- The end time can be advanced for a total of up to 24 hours.
- Recording ends if the end of the tape is reached.
- To stop recording before the end time is reached, press the **STOP** button (or **STOP/EJECT** on the front panel).

CHILD LOCK

With the Child Lock function on, the picture is blanked and the sound muted, virtually blocking the ability to view a videotape or TV program received through the VCR tuner.

- 1 Press the **MENU** button.

The main MENU appears.

- 2 Press the **▼** (or **▲**) button to select the VCR setup option, then press the **OK** button.

The VCR setup menu appears.

- 3 Press the **▼** (or **▲**) button to select the Child Lock option, then press the **▶** (or **◀**) button to select the "On" position, as indicated by the "●".

NOTE: Select the "Off" position to cancel the child lock function.

- 4 When finished, press the **MENU** button to exit the menu.

While the child lock function is active, the message "Blocked" will appear on the TV screen.

NOTES:

- Even when the child lock function is activated, timer recording and other functions can still operate normally.
- Since the child lock function can be activated or deactivated by remote control, you may wish to store the remote control in a secure location while the child lock function is activated.

Ad JUMP[®]

The Ad JUMP[®] feature allows you to skip through to the end of a commercial break at a faster speed and resume normal playback at the point when the program restarts.

- 1 During playback, press the **Ad JUMP** button when a commercial starts.

Forward picture search begins.

The sound is muted.

- 2 Press the **Ad JUMP** or the **PLAY** button when the commercial ends.

The tape will rewind for a few seconds, then playback will resume.

COPYING A TAPE

You can copy recordings (such as home videos) from one tape to another using two VCRs.

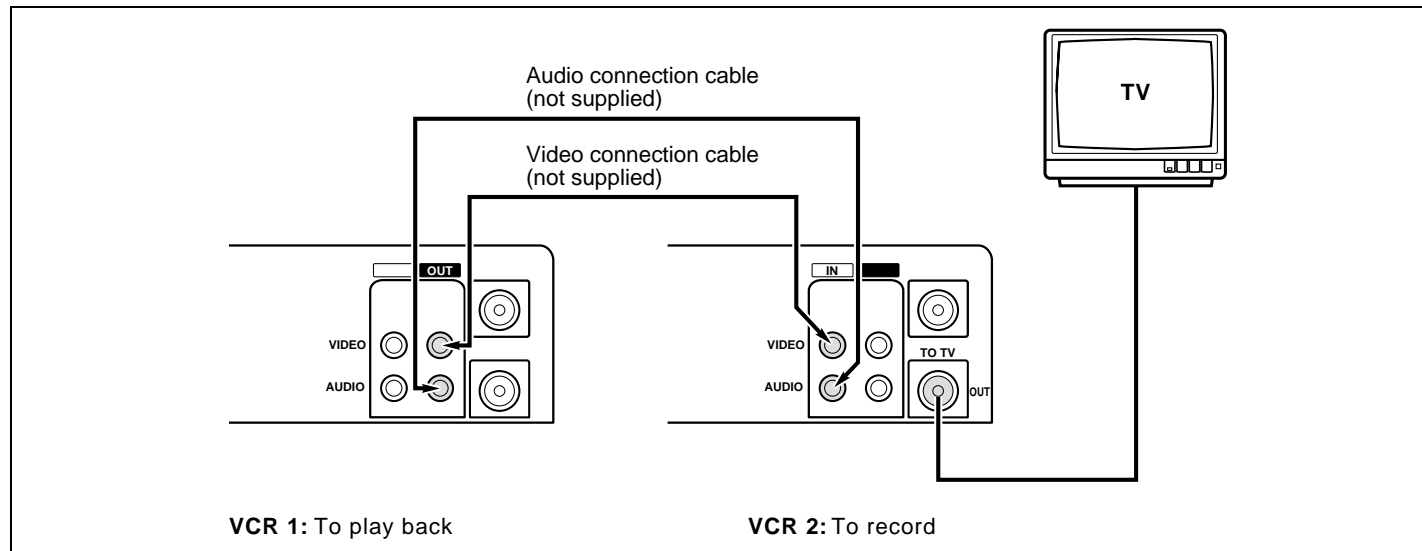

- ❶ Connect the VCRs as shown.
 - ❷ Insert the recorded cassette into VCR 1.
 - ❸ Insert a blank tape into VCR 2.
 - ❹ Set the desired recording speed on VCR 2.
 - ❺ Turn on the TV and set it to channel 3 or 4.
- If you use this model as VCR 2 to record:
- Press the **INPUT** button on VCR 2 to select the rear input jacks.
The AV indicator "L1" is displayed instead of a channel number.
- ❻ Press the **TV/VCR** button on VCR 2 to select the VCR mode.
 - ❼ Place VCR 2 in the record/pause mode.
 - ❽ Press **PLAY** on VCR 1.
 - ❾ When the tape in VCR 1 has reached the desired point, press (release) **PAUSE/STILL** on VCR 2. Recording begins.
 - ❿ Press **STOP** (or **STOP/EJECT** on the front panel) on both VCRs when finished.

MAINTENANCE

Head Care and Cleaning

- This VCR has a built-in automatic head cleaner. **Under normal conditions**, the heads should not require additional cleaning. If you suspect a problem, contact a factory-authorized service center.

Cabinet Cleaning

- Clean the outside of the cabinet with a clean, soft cloth, moistened with lukewarm water and wrung dry.

DO NOT USE SOLVENTS OR OTHER TYPES OF CLEANSERS. THESE CHEMICALS CAN CRACK OR DISCOLOR THE CABINET.

TROUBLESHOOTING GUIDE

If you have followed the instructions in this manual and still have difficulty operating your VCR, check the steps below before getting help from a factory-authorized service center.

SYMPTOM	POSSIBLE CAUSE	CORRECTIVE ACTION
No power.	<ul style="list-style-type: none"> ● The power cord is not connected. ● The power is not on. 	<ul style="list-style-type: none"> ● Connect the power cord to the AC power input socket, then to an AC wall outlet. ● Turn the power on.
The "Auto Setup" message is displayed when the power is turned on.	<ul style="list-style-type: none"> ● The VCR is being used for the first time or after the power has failed or has been disconnected for more than 5 seconds. 	<ul style="list-style-type: none"> ● The VCR is not set or the settings have been erased from the memory. Please refer to INITIAL SETUP to set the VCR.
Timer recording does not function.	<ul style="list-style-type: none"> ● The clock is not set correctly. ● The program timer is set incorrectly. ● The timer is not set to ON. 	<ul style="list-style-type: none"> ● Set the clock correctly. ● Set the program timer correctly. ● Turn the power off. The timer icon (⏸) appears.
Recording is not possible.	<ul style="list-style-type: none"> ● The record safety tab on the cassette is missing. ● The channel selected on the VCR does not correspond to the cable converter/decoder output channel. 	<ul style="list-style-type: none"> ● Place vinyl tape over the safety tab hole in the cassette. ● Select the correct channel (CH 02 ~ 07).
The picture is poor during playback.	<ul style="list-style-type: none"> ● The TV channel selector is not set to the proper channel. ● The TV fine tuning is not set correctly. 	<ul style="list-style-type: none"> ● During playback, set the TV's channel selector to channel 3 or 4 to match the VCR's channel switch setting. ● Fine-tune the TV. ● If the playback picture is still poor, contact a factory-authorized service center.
White lines (noise bands) in the picture during playback.	<ul style="list-style-type: none"> ● Poor quality recording or tape. 	<ul style="list-style-type: none"> ● Try a different tape.
No picture during playback.	<ul style="list-style-type: none"> ● The TV is not set to the proper channel. 	<ul style="list-style-type: none"> ● Set the TV's channel selector to match the VCR's channel switch setting (channel 3 or 4).
Playback picture is partially noisy. (horizontal white lines)	<ul style="list-style-type: none"> ● The tracking control is not set to the proper position. 	<ul style="list-style-type: none"> ● Adjust the tracking control for a better picture.
TV programs cannot be seen.	<ul style="list-style-type: none"> ● The cable connections are incorrect. 	<ul style="list-style-type: none"> ● Recheck all cable connections.

SPECIFICATIONS

General Specifications

Television system	NTSC standard system		
Recording system	Rotary helical scan system		
Number of heads	4, Double azimuth video		
Format	VHS standard		
Tape width	1/2 inch		
Tape speed	SP : 33.35 mm/sec. (1.31"/sec.) LP : 16.67 mm/sec. (0.65"/sec.) (playback only) SLP : 11.12 mm/sec. (0.43"/sec.)		
Recording time	SP : 120 minutes with T-120 cassette SLP : 360 minutes with T-120 cassette SLP : 480 minutes with T-160 cassette		
Tuner receivable channels (181 total)	TV Position	CATV Position	
	VHF channels 2-13	VHF channels	1-13
	UHF channels 14-69	Mid band channels	14-22
		Super band channels	23-36
		Hyper band channels	37-94, 100-125
		Mid low band channels	95-99
RF converter	Built-in VHF converter		
Converter output	Channel 3 or 4 selectable		
Time indication	AM/PM 12-hour system		
Timer	1 year/8-event programmable		

Terminals

Antenna input	VHF/UHF: F type
Antenna output	VHF/UHF: F type
Video input/output	RCA jack
Audio input/output	RCA jack

Electrical Specifications

Video output level/impedance	1 V(p-p)/75 ohms
Audio output level/impedance	316 mV (-10 dBV)/less than 2.2 kohms
Video input level/impedance	500 mV(p-p) - 2.0 V(p-p)/75 ohms
Audio input level/impedance	316 mV (-10 dBV)/more than 47 kohms

Other Specifications

Power requirements	120 V AC, 60 Hz
Power consumption	14 watts
Dimensions (W x H x D)	360 mm x 97 mm x 275 mm (14.17" x 3.82" x 10.83")
Weight (approximate)	3.0 kg (6.6 lbs.)
Remote control	B24605

The manufacturer reserves the right to modify product designs and specifications without notice and without incurring any obligation.



21605 Plummer Street,
Chatsworth, California 91311

1AC6P1P2254--
SC4/UF
(0300KP-SJC)

Issue No. 1

Copyright FISHER, 2000 All rights reserved.

Printed in Indonesia

Free Manuals Download Website

<http://myh66.com>

<http://usermanuals.us>

<http://www.somanuals.com>

<http://www.4manuals.cc>

<http://www.manual-lib.com>

<http://www.404manual.com>

<http://www.luxmanual.com>

<http://aubethermostatmanual.com>

Golf course search by state

<http://golfingnear.com>

Email search by domain

<http://emailbydomain.com>

Auto manuals search

<http://auto.somanuals.com>

TV manuals search

<http://tv.somanuals.com>