

00809-0100-4737

English

Rev. EA

Models 244EH and 244ER PC-Programmable Temperature Transmitters

Product Discontinued



ROSEMOUNT[®]
FISHER-ROSEMOUNT[™]

Models 244EH and 244ER PC-Programmable Temperature Transmitters

NOTICE

Read this manual before working with the product. For personal and system safety, and for optimum product performance, make sure you thoroughly understand the contents before installing, using, or maintaining this product.

Within the United States, Rosemount Inc. has two toll-free assistance numbers:

Customer Central

Technical support, quoting, and order-related questions.

1-800-999-9307 (7:00 am to 7:00 pm CST)

North American Response Center

Equipment service needs.

1-800-654-7768 (24 hours—includes Canada)

Outside of the United States, contact your local Rosemount representative.

⚠ CAUTION

The products described in this document are NOT designed for nuclear-qualified applications. Using non-nuclear qualified products in applications that require nuclear-qualified hardware or products may cause inaccurate readings.

For information on Rosemount nuclear-qualified products, contact your local Rosemount Sales Representative.

Rosemount Models 244EH and 244ER Smart Temperature Transmitters may be protected by one or more U.S. Patents pending. Other foreign patents pending.

Rosemount and the Rosemount logotype are registered trademarks of Rosemount Inc.

Noryl and Lexan are registered trademarks of General Electric.

Microsoft, Windows, Windows 95, and Windows NT are registered trademarks of Microsoft Corp.

MINIGRABBER is a trademark of Pamona Electronics.

WAGO is a registered trademark of Kontakttechnik GmbH.

Cover photo: 644-244C901

Rosemount Inc.
8200 Market Boulevard
Chanhassen, MN 55317
USA
Tel 1-800-999-9307
Fax (952) 949-7001

Fisher-Rosemount Limited
Heath Place
Bognor Regis
West Sussex PO22 9SH
England
Tel 44 (1243) 863 121
Fax 44 (1243) 867 5541

Fisher-Rosemount
Singapore Pte Ltd.
1 Pandan Crescent
Singapore 128461
Tel (65) 777-8211
Fax 65 777-0947
AP.RMT-Specialist@frco.com

Product documentation available at...
www.rosemount.com

© Rosemount Inc., 2000



00809-0100-4737 Rev EA 10/00



Fisher-Rosemount satisfies all obligations coming from legislation to harmonise product requirements in the European Union.

ROSEMOUNT
FISHER-ROSEMOUNT



Table of Contents

SECTION 1 Introduction

Safety Messages	1-1
Transmitter Overview	1-1
Manual Overview	1-2
Considerations	1-3
General	1-3
Mechanical	1-3
Electrical	1-3
Environmental	1-3

SECTION 2 Installation

Safety Messages	2-1
Warnings	2-1
Tools needed for Installation	2-2
Mounting	2-3
Special Mounting Considerations	2-4
Installation Procedures	2-5
Transmitter	2-5
Configuration Software	2-9
Model 244EC Configuration Interface	2-11
Field Wiring	2-12
Sensor Connections	2-13
Failure Mode	2-16
Changing Switch Positions	2-16

SECTION 3 Operation

Safety Messages	3-1
Warning	3-1
Power Supply	3-1
Surges/Transients	3-1
Grounding	3-2
Configuration	3-2
Configuring a Single Transmitter	3-3
Configuring Several Transmitters Identically	3-4
Viewing the Process Variable	3-5
Intermittent Sensor Algorithm	3-5
Case Examples	3-6
Intermittent Sensor Algorithm and Damping	3-7
Intermittent Sensor Detect (Advanced Feature)	3-8
Implementation	3-9

SECTION 4 Maintenance and Troubleshooting

Safety Information	4-1
Warning	4-1
Troubleshooting	4-1
Model 244EH software version 5.5.1	4-1

APPENDIX A Reference Data	Transmitter Specification	A-1
	Functional.	A-1
	Performance	A-2
	Physical	A-5
	Model 244EC Configuration Interface	A-5
	Ordering Information	A-6
	Ordering Flameproof and Explosion-proof Approvals for Temperature Assemblies	A-8
	Dimensional Drawings	A-9
	Transmitter.	A-9
	Enclosure and Model 244EC Configuration Interface.	A-9
APPENDIX B Approvals	Safety Messages	B-1
	Hazardous Locations Installations	B-1
	Locations Certifications	B-2
	Installation Drawings	B-4
APPENDIX C Models 644 and 244E Temperature Transmitters Manual Supplement	Old Transmitter.	C-2
	Transmitter Design.	C-2
	Sensor Wiring Diagrams	C-2
	Special Mounting Considerations	C-2
	New Transmitter	C-3
	Transmitter Design.	C-3
	Sensor Wiring Diagrams	C-3
	Special Mounting Considerations	C-3
	HART Communicator (Model 644H only)	C-3
	Specifications	C-4

Introduction

Safety Messages	page 1-1
Transmitter Overview	page 1-1
Manual Overview	page 1-2
Considerations	page 1-3

SAFETY MESSAGES

Procedures and instructions in this manual may require special precautions to ensure the safety of the personnel performing the operations. Information that raises potential safety issues is indicated by a warning symbol (⚠). Refer to the safety messages listed at the beginning of each section before performing an operation preceded by this symbol.

⚠ WARNING

Failure to follow these installation guidelines could result in death or serious injury.

- Make sure only qualified personnel perform the installation.

TRANSMITTER OVERVIEW

Thank you for choosing the Model 244E. Features of the Model 244EH and Model 244ER transmitters include:

- Configuration using the Model 244EC Configuration Interface and a Microsoft® Windows®-based PC running the Models 244EH and 244ER Configuration Software
- The ability to convert RTD and thermocouple inputs to 4–20 mA, 2-wire outputs that are less susceptible to electrical noise
- The capability to linearize RTD and thermocouple inputs with temperature
- Electrical input-output isolation
- Electronics that are completely encapsulated in epoxy and enclosed in a metal housing, making the transmitter extremely durable and ensuring long-term reliability
- A compact size and two housing options allowing mounting flexibility for the control room or the field

Rosemount Inc. has a full range of compatible connection heads, sensors, and thermowells to provide complete assemblies for process temperature measurements. Refer to Volume 1 of the Rosemount Temperature Sensors and Assemblies Product Data Sheet (document number 00813-0100-2654) for thread mount sensors and accessories, or refer to Volume 2 (document number 00813-0100-2654) for DIN-style sensors and accessories.

MANUAL OVERVIEW

This manual is designed to assist in the installation, operation, and maintenance of Rosemount® Model 244EH and 244ER PC Programmable Temperature Transmitters and the Model 244EC Configuration Interface.

Section 2: Installation

- Tools for installation
- Mounting
- Installation
- Field wiring

Section 3: Operation

- Power Supply
- Configuration

Section 4: Maintenance and Troubleshooting

- Software Troubleshooting

Appendix A: Reference Data

- Specifications
- Dimensional drawings
- Ordering information

Appendix B: Approvals

- Locations certifications
- Installation drawings

Appendix C: Models 644 and 244E Temperature Transmitters Manual Supplement

- Comparison between new and old Models 644 and 244E
- Specifications

CONSIDERATIONS

General

Electrical temperature sensors such as RTDs and thermocouples produce low-level signals proportional to their sensed temperature. The Models 244EH and 244ER transmitters convert the low-level sensor signal to a standard 4–20 mA dc signal that is relatively insensitive to lead length and electrical noise. This current signal is then transmitted to the control room via two wires.

Mechanical

When choosing an installation location and position, take into account the need for access to the transmitter.

Wiring Connections

Make wiring connections through the cable entry in the side of the connection head. Be sure to provide adequate clearance for cover removal.

Electrical

Proper electrical installation is necessary to prevent errors due to sensor lead resistances and electrical noise. Shielded cable should be used in electrically noisy environments.

Environmental

The transmitter electronics module is permanently sealed within the housing, resisting moisture and corrosive damage. Verify that the operating atmosphere of the transmitter is consistent with the appropriate hazardous locations certifications.

Installation

Safety Messages	page 2-1
Tools needed for Installation	page 2-2
Mounting	page 2-3
Installation Procedures	page 2-5
Field Wiring	page 2-12
Failure Mode	page 2-16

SAFETY MESSAGES

Instructions and procedures in this section may require special precautions to ensure the safety of the personnel performing the operations. Information that raises potential safety issues is indicated by a warning symbol (⚠). Please refer to the following safety messages before performing an operation preceded by this symbol.

Warnings

⚠ WARNING

Explosions could result in death or serious injury.

- Do not remove the enclosure cover in explosive atmospheres when the circuit is live.
- Verify that the operating atmosphere of the transmitter is consistent with the appropriate hazardous locations certification.
- Enclosure covers must be fully engaged to meet explosion-proof requirements.

⚠ WARNING

Process leaks could result in death or serious injury.

- Install and tighten thermowells or sensors before applying pressure, or process leakage may result.
- Do not remove the thermowell while in operation. Doing so may cause process fluid leaks.

⚠ WARNING

Electrical shock could cause death or serious injury.

- If the sensor is installed in a high-voltage environment and a fault condition or installation error occurs, high voltage may be present on transmitter leads and terminals.
- Use extreme caution when making contact with leads and terminals.

Rosemount Models 244EH and 244ER PC-Programmable Temperature Transmitters

Figure 2-1. Transmitter Installation Flowchart

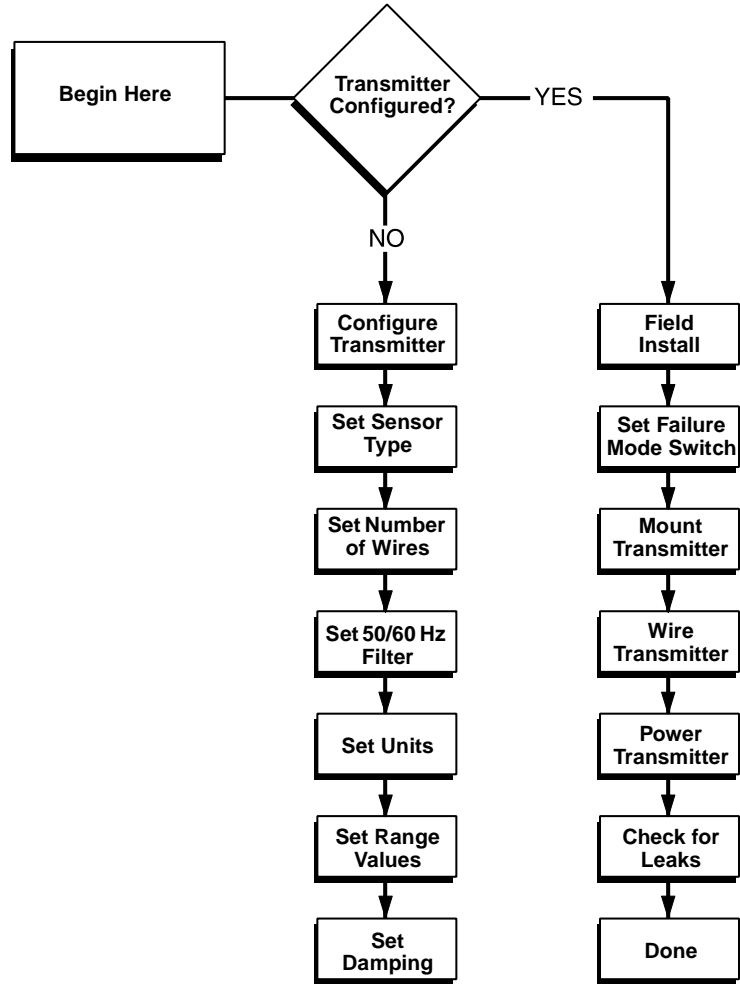

244-244_02A

TOOLS NEEDED FOR INSTALLATION

The tools needed for installation are as follows:

Models 244EH and 244ER:

- Transmitter
- Mounting apparatus

Model 244EC Configuration Interface:

- Transmitter
- 9-pin connector cable
- MINIGRABBER™ clips

Model 244EH and 244ER Configuration Software:

- PC
- Windows-based software

MOUNTING

The Model 244EH installs in a connection head or universal head mounted directly on a sensor assembly, apart from a sensor assembly using a universal head, or to a DIN rail using an optional mounting clip. The Model 244ER mounts directly to a wall or to a DIN rail.

The Models 244EH and 244ER transmitters will operate within specifications for ambient temperatures between -40 and 185 °F (-40 and 85 °C).

In a direct mounting configuration using a Model 244EH transmitter, process heat is transferred from the thermowell to the transmitter via the connection head. If the expected connection head temperature is near or beyond specification limits, consider the use of additional thermowell lagging, an extension nipple, or a remote mounting configuration to isolate the transmitter from excessive temperatures. Figure 2-2 provides an example of the relationship between transmitter housing temperature rise and extension length. Use Figure 2-2 as a guide for determining adequate thermowell extension length.

Figure 2-2. Model 244EH Connection Head Temperature Rise vs. Extension Length

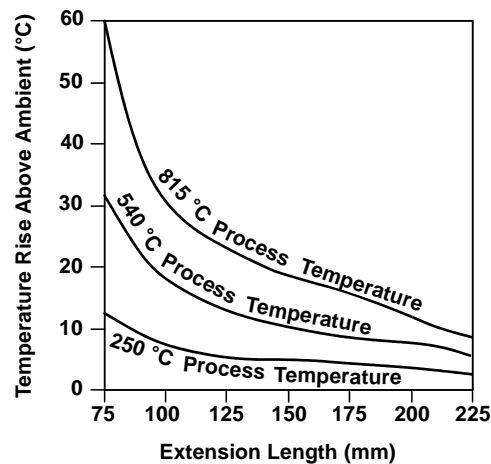

3044-0123A

Example

The transmitter specification limit is 85 °C. If the ambient temperature is 55 °C and the process temperature to be measured is 800 °C, the maximum permissible connection head temperature rise is the transmitter specification limit minus the ambient temperature ($85 - 55$ °C), or 30 °C. In this case, an extension of 100 mm meets this requirement, but 125 mm provides a margin of 8 °C, thereby reducing any temperature effects in the transmitter.

Special Mounting Considerations

Special mounting hardware is available for mounting a Model 244EH head mount transmitter to a DIN rail, or assembling a new Model 244EH to an existing threaded sensor connection head (former option code L1).

Mounting a Model 244EH to a DIN Rail

To attach a head mount transmitter to a DIN rail, assemble the appropriate rail mounting kit (part number 00644-5301-0010) to the transmitter as shown in Figure 2-3, then follow the procedure under “Rail Mount Transmitter with Integral Mount Sensor” on page 2-7.

Figure 2-3. Assembling Rail Clip Hardware to a Model 244EH

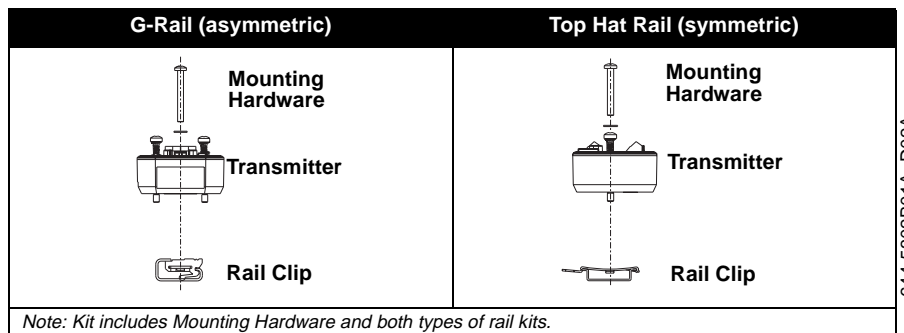

644-5302B01A, D02A

Retrofitting a Model 244EH for Use in an Existing Threaded Sensor Connection Head

To mount a Model 244EH in an existing threaded sensor connection head (former option code L1), order the Model 244EH retrofit kit (part number 00644-5321-0010). The retrofit kit includes a new mounting bracket and all associated hardware necessary to facilitate the installation of the Model 244EH in the existing head.

Figure 2-4. Assembling Model 244EH for Use in an Existing L1 Connection Head

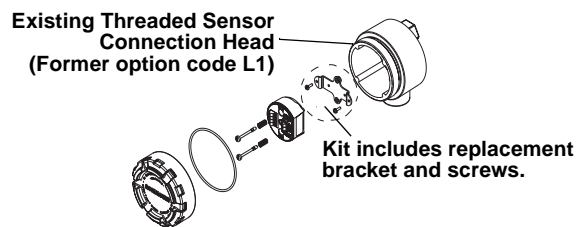

644-5321A01A

INSTALLATION PROCEDURES

Transmitter

Refer to the appropriate procedure and the accompanying illustrations when installing the transmitter.

Head Mount Transmitter with DIN Plate Style Sensor

The least complicated assembly uses:

- an integral mount sensor with flying leads
- an integral DIN style connection head
- a standard extension
- a threaded thermowell

Refer to Volume 2 of the Rosemount Sensors Product Data Sheet (document number 00813-0101-2654) for complete sensor and mounting accessory information.

To complete the assembly, follow the steps described below.

1. Attach the thermowell to the pipe or process container wall. Install and tighten the thermowell before applying pressure.
2. Set the transmitter failure mode switch (see Figure 2-13 on page 2-16).
3. Assemble the transmitter to the sensor. Push the transmitter mounting screws through the sensor mounting plate and insert the snap rings (optional, part number 00644-4432-0001) into the groove of each transmitter mounting screw.
4. Insert the transmitter-sensor assembly into the connection head. Thread the transmitter mounting screw into the connection head mounting holes.
5. Assemble the extension to the connection head. Insert the assembly into the thermowell.
6. Attach a cable gland into the shielded cable.
7. Insert the shielded cable leads into the connection head through the cable entry. Connect and tighten the cable gland.
8. Connect the shielded cable leads to the transmitter power terminals. Avoid contact with leads and terminals.
9. Install and tighten the connection head cover. Enclosure covers must be fully engaged to meet explosion-proof requirements.

Figure 2-5. Typical Model 244EH Mounting Configuration Using Integral Mount Sensor and Assembly

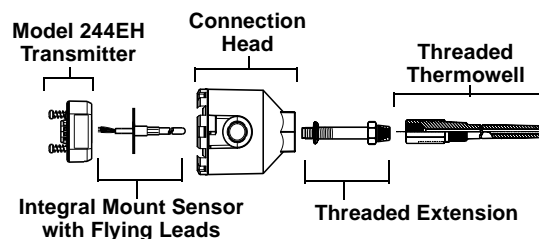

644-0000B04A

Head Mount Transmitter with Threaded Sensor

The least complicated assembly uses:

- a threaded sensor with flying leads
- the universal connection head
- a union and nipple extension assembly
- a threaded thermowell

Refer to Volume 1 of the Rosemount Sensors Product Data Sheet (document number 00813-0100-2654) for complete sensor and mounting accessory information.

To complete the assembly, follow the steps as described below.

1. Attach the thermowell to the pipe or process container wall. Install and tighten thermowells before applying pressure.
2. Attach necessary extension nipples and adapters. Seal the nipple and adapter threads with silicone tape.
3. Screw the sensor into the thermowell. Install drain seals if required for severe environments or to satisfy code requirements.
4. Set the transmitter failure mode switch (see Figure 2-13 on page 2-16).
5. Pull the sensor wiring leads through the extensions and adapters into the universal head. Mount the transmitter in the universal head by threading the transmitter mounting screws into the universal head mounting holes.
6. Mount the assembly into the thermowell. Seal adapter threads with silicone tape.
7. Install conduit for field wiring to the conduit entry of the universal head. Seal conduit threads with silicone tape.
8. Pull the field wiring leads through the conduit into the universal head. Attach the sensor and power leads to the transmitter. Avoid contact with leads and terminals.
9. Install and tighten the universal head cover. Enclosure covers must be fully engaged to meet explosion-proof requirements.

Figure 2-6. Typical Model 244EH Transmitter Mounting Configuration Using Threaded Style Sensor and Assembly

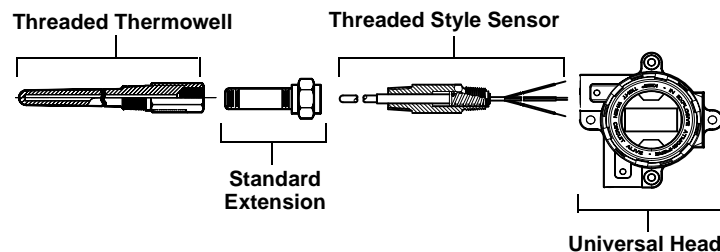

644-0000A04A

Rail Mount Transmitter with Integral Mount Sensor

The least complicated assembly uses:

- an integral mount sensor with terminal block
- an integral DIN style connection head
- a standard extension
- a threaded thermowell

Refer to Volume 2 of the Rosemount Sensors Product Data Sheet (document number 00813-0101-2654) for complete sensor and mounting accessory information.

To complete the assembly, follow the procedure described below.

1. Attach the transmitter to a suitable rail or panel.
- ⚠ 2. Attach the thermowell to the pipe or process container wall. Install and tighten the thermowell before applying pressure.
3. Attach the sensor to the connection head and mount the entire assembly to the thermowell.
4. Attach sufficient lengths of sensor lead wire to the sensor terminal block.
- ⚠ 5. Attach and tighten the connection head cover. Enclosure covers must be fully engaged to meet explosion-proof requirements.
6. Run sensor lead wires from the sensor assembly to the transmitter.
7. Set the transmitter failure mode switch (see Figure 2-13 on page 2-16).
- ⚠ 8. Attach the sensor and power leads to the transmitter. Avoid contact with leads and terminals.

Figure 2-7. Typical Rail Mount Transmitter Mounting Configuration Using Integral Mount Sensor and Assembly

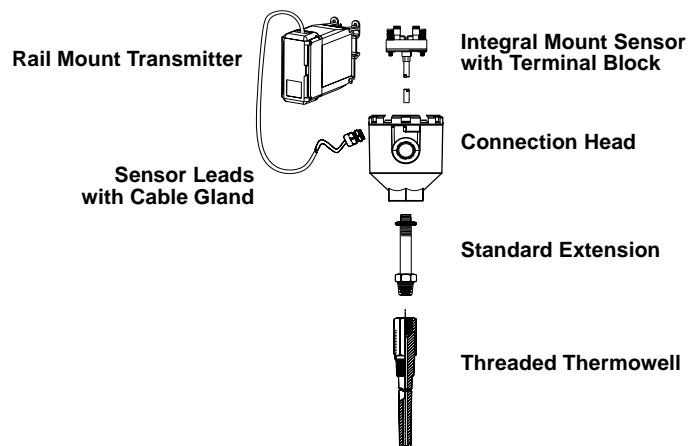

Rail Mount Transmitter with Threaded Sensor

The least complicated assembly uses:

- a threaded sensor with flying heads
- a threaded sensor connection head
- a union and nipple extension assembly
- a threaded thermowell

Refer to Volume 1 of the Rosemount Sensors Product Data Sheet (document number 00813-0100-2654) for complete sensor and mounting accessory information.

To complete the assembly, follow the procedure described below.

1. Attach the transmitter to a suitable rail or panel.
- ⚠ 2. Attach the thermowell to the pipe or process container wall. Install and tighten the thermowell before applying pressure.
3. Attach necessary extension nipples and adapters. Seal the nipple and adapter threads with silicone tape.
4. Screw the sensor into the thermowell. Install drain seals if required for severe environments or to satisfy code requirements.
5. Screw the connection head to the sensor.
6. Attach the sensor lead wires to the connection head terminals.
7. Attach additional sensor lead wires from the connection head to the transmitter.
- ⚠ 8. Attach and tighten the connection head cover. Enclosure covers must be fully engaged to meet explosion-proof requirements.
9. Set the transmitter failure mode switch (see Figure 2-13 on page 2-16).
- ⚠ 10. Attach the sensor and power leads to the transmitter. Avoid contact with leads and terminals.

Figure 2-8. Typical Rail Mount Transmitter Mounting Configuration Using Threaded Style Sensor and Assembly

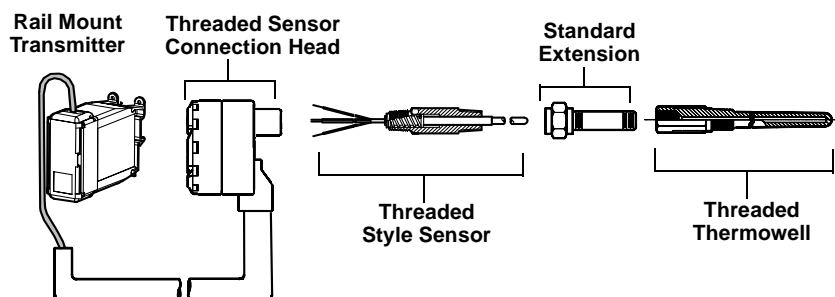

644-0000A04B

Multichannel Installations

Several transmitters can be connected to a single master power supply as shown in Figure 2-9. In this case, the system may be grounded only at the negative power supply terminal. In multichannel installations where several transmitters depend on one power supply and the loss of all transmitters would cause operational problems, consider a back-up battery or power supply that cannot be interrupted. The diodes shown in Figure 2-9 prevent unwanted charging or discharging of the back-up battery.

Figure 2-9. Multichannel Installations

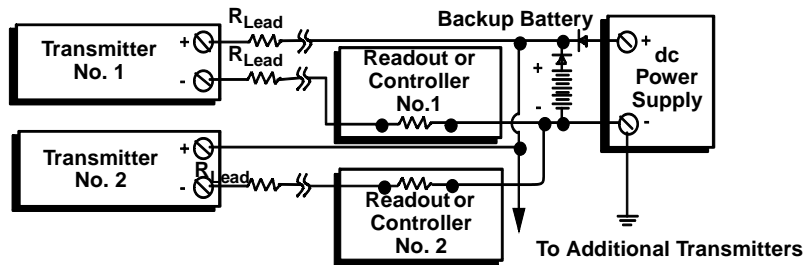

3044-0131A

Configuration Software

System Requirements

For the configuration software to function properly, the following minimum PC requirements must be observed.

- 80386 or faster processor
- 1 MB free disk space
- 3.5-inch floppy disk drive
- Mouse or other pointing device
- 256 color display (recommended settings are 16-bit color at 1024 × 728 screen resolution)
- Microsoft Windows 3.1, Windows for Workgroups 3.11, Windows 95, or Windows NT.

The configuration software is available in English, French, German, Italian, Spanish, Chinese, Japanese, and Korean language versions. The configuration software automatically selects the appropriate language based on the language version of Windows.

NOTE

Close all currently running applications before starting the installation procedure.

NOTE

Windows 98 is not compatible with this software.

Choose the procedure that matches the operating system you are using.

Procedure for Windows 3.1 or Windows for Workgroups 3.11

1. If you do not have Win32s installed, install it now. Follow the instructions on the diskette label.
2. Insert the Models 244EH and 244ER Configuration Software diskette into your floppy disk drive.
3. In the File Manager, choose **RUN** from the **FILE** menu.
4. The **RUN** dialog box appears. In the **COMMAND LINE** text box, type **<drive>:\setup**. Substitute the letter of your floppy disk drive (usually **a** or **b**) for **<drive>**. Click **OK**.
5. The **WELCOME** window appears. Click **OK**.
6. The **SELECT DESTINATION DIRECTORY** window appears. To accept the default installation directory, click **OK**. To specify a different installation directory, either type a new directory path in the **DESTINATION DIRECTORY** text box or select one from the list. Click **OK**.
7. The **COMM SETTINGS** window appears. In the **COMM PORT** drop-down box, choose the communication port to which you intend to connect the Model 244EC. Click **OK**.
8. The **SELECT PROGRAM MANAGER GROUP** window appears. To accept the default Program Manager group name, click **OK**. To specify a different group name, either type a new name in the **GROUP NAME** text box or select one from the list. Click **OK**.

Procedure for Windows 95 or Windows NT

1. Insert the Models 244EH and 244ER Configuration Software diskette into your floppy disk drive.
2. Click the **START** button on taskbar. Click **RUN**.
3. The **RUN** dialog box appears. In the **OPEN** text box, type **<drive>:\setup**. Substitute the letter of your floppy disk drive (usually **a** or **b**) for **<drive>**. Click **OK**.
4. The **SELECT DESTINATION DIRECTORY** window appears. To accept the default installation directory, click **OK**. To specify a different installation directory, either type a new directory path in the **DESTINATION DIRECTORY** text box or select one from the list. Click **OK**.
5. The **COMM SETTINGS** window appears. Choose the communication port to which you intend to connect the Model 244EC from the **COMM PORT** drop-down box. Click **OK**.
6. The **SELECT PROGRAM MANAGER GROUP** window appears. To accept the default Program Manager group name, click **OK**. To specify a different group name, either type a new name in the **GROUP NAME** text box or select one from the list. Click **OK**.

Screen Conventions

The Models 244EH and 244ER Configuration Software follows the Microsoft Windows screen conventions with the following exception: Configuration parameters change color to indicate fields where information has changed. Before placing a new transmitter into service, or before returning a transmitter to service after changing configuration information, verify that the values in the fields that have been changed reflect the correct configuration parameters for your application. For example, if you change the *Sensor Type* field to **PT100–Alpha 392**, the *Number of Wires*, *Units*, *4 mA Point*, and *20 mA Point* fields all change to reflect the default **PT100–Alpha 392** sensor values. Verify all information before placing the transmitter into service.

Model 244EC Configuration Interface

The Model 244EC Configuration Interface is a portable, self-contained link between your PC and a Model 244. The Model 244EC connects to a PC serial port with a standard 9-pin interconnecting plug and connects to a transmitter with two MINIGRABBER™ clips.

The Model 244EC will also operate using a wall power adapter or a single replaceable 9-volt battery.

Setting Up the Model 244EC Configuration Interface

All necessary power is provided through the configuration leads from the Model 244EC to the transmitter. The sensor does not need to be disconnected in order to configure the transmitter.

To set up the Model 244EC Configuration Interface and prepare it for use, refer to Figure 2-10 on page 2-12 and follow the procedure described below.

1. Install the 9-volt battery in the Model 244EC. Be sure the power switch remains in the “OFF” position.
2. Attach the ribbon cable from the Model 244EC to the serial port of your PC using the 9-pin interconnecting plug. If your PC has a 25-pin serial port, you will need a 25-pin to 9-pin adapter to accommodate the connection.

NOTE

It is not necessary to power down your PC before you attach the Model 244EC. However, if you are using a desktop model, you may wish to power down to reduce the risk of electric shock or computer damage.

3. Attach the configuration leads to the Model 244EC using the banana jacks provided. Be sure to observe proper polarity—attach the red lead to the positive (+) jack on the Model 244EC and the black lead to the negative (–) jack.
4. Attach the configuration leads to the configuration terminals (labeled “PROG”) on the transmitter using the MINIGRABBER clips provided. Be sure to observe proper polarity—attach the red lead to the positive (+) terminal on the transmitter and the black lead to the negative (–) terminal.

5. Turn on the Model 244EC using the power switch on the top side of the housing.

NOTE

Verify that the Model 244EC “Low Battery” LED is not on before initiating communication with the transmitter. If the low battery LED is on, you will not be able to configure the transmitter.

6. Using your PC, open the Configuration Software program. Access the online help if you have questions regarding the use of the program.

Figure 2-10. Complete Transmitter Configuration System

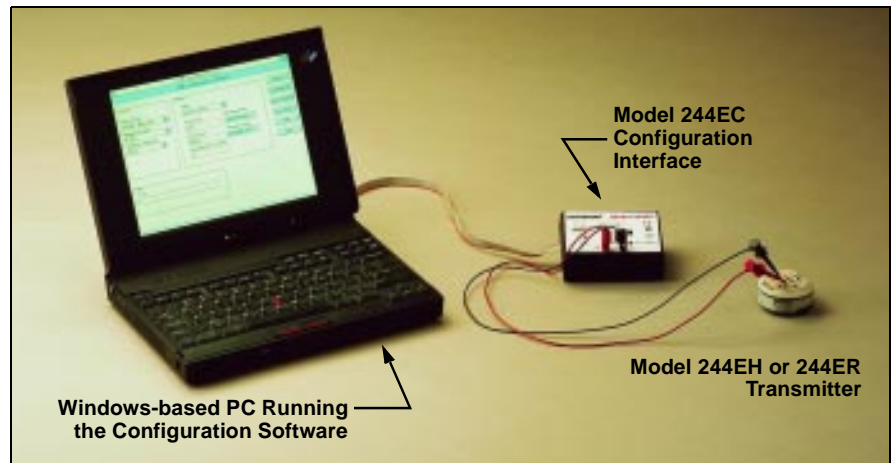

FIELD WIRING

- ⚠ All power to the transmitter is supplied over the signal wiring. Use ordinary copper wire of sufficient size to ensure that the voltage across the transmitter power terminals does not drop below 12.0 V dc.
- ⚠ If the sensor is installed in a high-voltage environment and a fault condition or installation error occurs, the sensor leads and transmitter terminals could carry lethal voltages. Use extreme caution when making contact with the leads and terminals.

NOTE

Do not apply high voltage (e.g., ac line voltage) to the transmitter terminals. Abnormally high voltage can damage the unit. (Sensor and transmitter power terminals are rated to 42.4 V dc.)

For multichannel installations, see “Multichannel Installations” on page 2-9. The transmitters will accept inputs from a variety of RTD and thermocouple types. Refer to Figure 2-12 on page 2-15 when making sensor connections.

Use the following steps to wire the transmitter:

1. Connect the positive lead from the power supply to the transmitter terminal marked “+” and the negative lead to the transmitter terminal marked “-” (see Figure 2-11 and Figure 2-13).
2. Tighten the terminal compression screws to ensure adequate contact. No additional power wiring is required.
3. After making connections, recheck the polarity and correctness of connections, then turn the power on.

Figure 2-11. Transmitter Field Wiring Diagrams

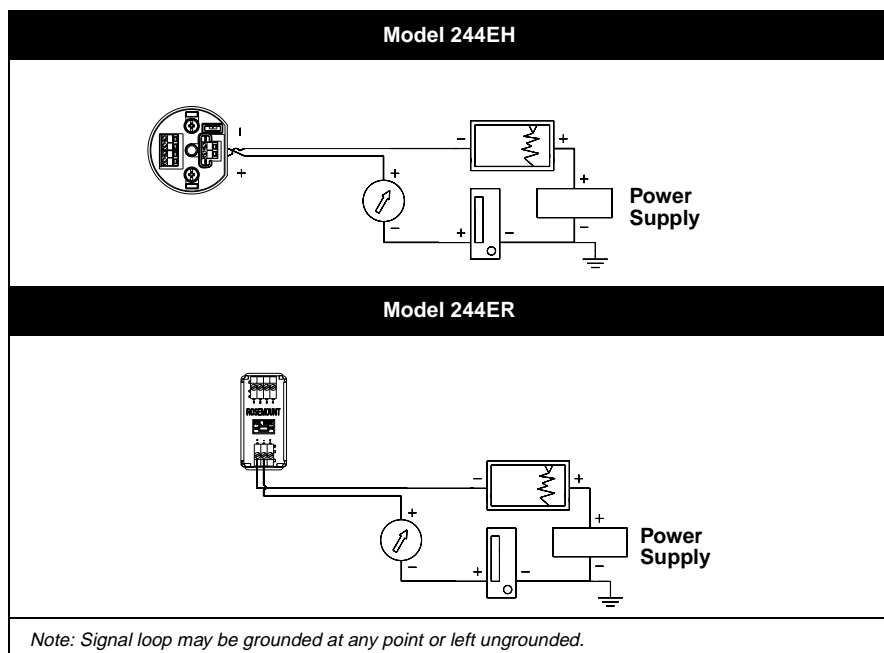

Sensor Connections

 The Models 244E are compatible with a number of RTD and thermocouple sensor types. Figure 2-12 shows the correct input connections to the sensor terminals on the transmitter. To ensure proper sensor connections, anchor the sensor lead wires into the appropriate compression terminals and tighten the screws.

RTD or Ohm Inputs

The transmitters will accept a variety of RTD configurations, including 2-wire, 3-wire, 4-wire, and compensation loop designs. If the transmitter is mounted remotely from a 3-wire or 4-wire RTD, it will operate within specifications, without recalibration, for lead wire resistances of up to 10 ohms per lead (equivalent to 1,000 feet of 20 AWG wire). In this case, the leads between the RTD and transmitter should be shielded. If using only two leads, both RTD leads are in series with the sensor element, so significant errors can occur if the lead lengths exceed three feet of 20 AWG wire (approximately 0.05 °C/ft). For longer runs, attach a third or fourth lead as described above.

Sensor Lead Wire Resistance Effect

RTD Input

When using a 4-wire RTD, the effect of lead resistance is eliminated and has no impact on accuracy. However, a 3-wire sensor will not fully cancel lead resistance error because it cannot compensate for imbalances in resistance between the lead wires. Using the same type of wire on all three lead wires will make a 3-wire RTD installation as accurate as possible. A 2-wire sensor will produce the largest error because it directly adds the lead wire resistance to the sensor resistance. For 2- and 3-wire RTDs, an additional lead wire resistance error is induced with ambient temperature variations. The table and the examples shown below help quantify these errors.

Table 2-1. Examples of Approximate Basic Error

Sensor Input	Approximate Basic Error
4-wire RTD	None (independent of lead wire resistance)
3-wire RTD	± 1.0 Ω in reading per ohm of unbalanced lead wire resistance (Unbalanced lead wire resistance = maximum imbalance between any two leads.)
2-wire RTD	1.0 Ω in reading per ohm of lead wire resistance

Examples of Approximate Lead Wire Resistance Effect Calculations

Given:

- Total cable length = 150 m
- Imbalance of the lead wires at 20 °C = 0.5 Ω
- Resistance/length (18 AWG Cu) = 0.025 Ω/Ω °C
- Temperature coefficient of copper (α_{Cu}) = 0.0039 Ω/Ω °C
- Temperature coefficient of platinum (α_{Pt}) = 0.00385 Ω/Ω °C
- Change in Ambient Temperature (ΔT_{amb}) = 25 °C
- RTD Resistance at 0 °C (R_0) = 100 Ω (for Pt 100 RTD)

- Pt100 4-wire RTD: No lead wire resistance effect.
- Pt100 3-wire RTD:

$$\text{Basic Error} = \frac{\text{Imbalance of Lead Wires}}{(\alpha_{Pt} \times R_0)}$$

$$\text{Error due to amb. temp. variation} = \frac{(\alpha_{Cu}) \times (\Delta T_{amb}) \times (\text{Imbalance of Lead Wires})}{(\alpha_{Pt}) \times (R_0)}$$

Lead wire imbalance seen by the transmitter = 0.5 Ω

$$\text{Basic error} = \frac{0.5 \Omega}{(0.00385 \Omega / \Omega \text{ } ^\circ\text{C}) \times (100 \Omega)} = 1.3 \text{ } ^\circ\text{C}$$

$$\begin{aligned} \text{Error due to amb. temp. var. of } \pm 25 \text{ } ^\circ\text{C} \\ = \frac{(0.0039 \Omega / \Omega \text{ } ^\circ\text{C}) \times (25 \text{ } ^\circ\text{C}) \times (0.5 \Omega)}{(0.00385 \Omega / \Omega \text{ } ^\circ\text{C}) \times (100 \Omega)} = \pm 0.13 \text{ } ^\circ\text{C} \end{aligned}$$

- Pt100 2-wire RTD:

$$\text{Basic Error} = \frac{\text{Lead Wire Resistance}}{(\alpha_{Pt} \times R_0)}$$

$$\text{Error due to amb. temp. variation} = \frac{(\alpha_{Cu}) \times (\Delta T_{amb}) \times (\text{Lead Wire Resistance})}{(\alpha_{Pt}) \times (R_0)}$$

Lead wire resistance seen by the transmitter = 150 m × 2 wires × 0.025 Ω/m = 7.5 Ω

$$\text{Basic error} = \frac{7.5 \Omega}{(0.00385 \Omega / \Omega \text{ } ^\circ\text{C}) \times (100 \Omega)} = 19.5 \text{ } ^\circ\text{C}$$

Error due to amb. temp. var. of ± 25 °C

$$= \frac{(0.0039 \Omega / \Omega \text{ } ^\circ\text{C}) \times (25 \text{ } ^\circ\text{C}) \times (7.5 \Omega)}{(0.00385 \Omega / \Omega \text{ } ^\circ\text{C}) \times (100 \Omega)} = \pm 1.9 \text{ } ^\circ\text{C}$$

Thermocouple or Millivolt Inputs

For integral mounting applications, the thermocouple can be connected directly to the transmitter. If mounting the transmitter remotely from the sensor, use appropriate thermocouple extension wire. Make connections for millivolt inputs with copper wire. Use shielding for long runs of wire.

Figure 2-12. Sensor Wiring Diagrams

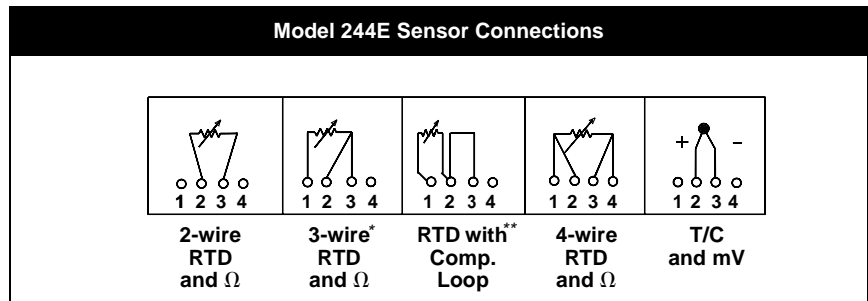

* Rosemount Inc. provides 4-wire sensors for all single element RTDs. You can use these RTDs in 3-wire configurations by leaving the unneeded leads disconnected and insulated with electrical tape.

** The transmitters must be configured for a 3-wire RTD in order to recognize an RTD with a compensation loop.

644-000B01A

Rosemount Models 244EH and 244ER PC-Programmable Temperature Transmitters

Figure 2-13. Transmitter Power, Sensor, and Configuration Terminals

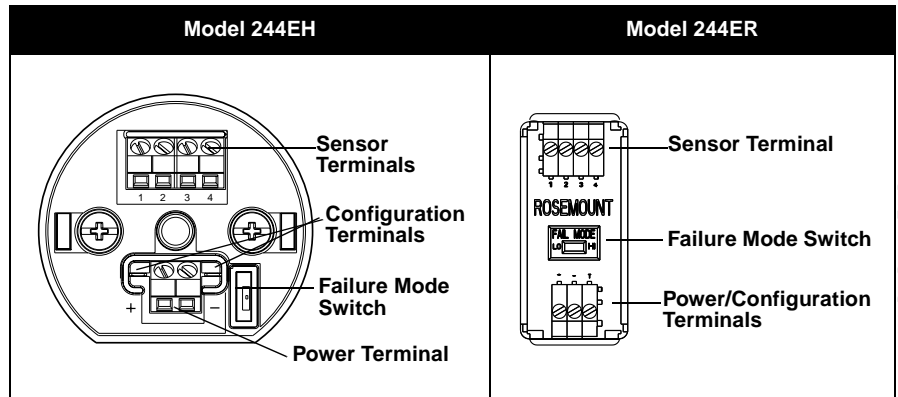

FAILURE MODE



The Models 244EH and 244ER features software driven alarm diagnostics and an independent circuit. These features are designed to provide separate backup alarm output in case the microprocessor, electronics, hardware, or software fails. The alarm levels are user selectable using the Failure Mode Switch. The position of the jumper determines the direction in which the output is driven (HI or LO) in case of alarm. The jumper switch feeds into the Digital-to-Analog (D/A) converter, which drives the proper alarm output even if the microprocessor fails.

The values to which the transmitter drives its output in failure mode depend on whether it is factory configured to *standard* or *NAMUR-compliant* operation. See “Failure Mode” on page A-2 for these parameters.

To determine the failure mode configuration of a transmitter, review the low and high alarm levels on the **SERVICE** menu provided by the configuration software.

Changing Switch Positions

To change the failure mode on the Model 244EH or 244ER transmitter, follow the steps described below.

-  1. If the transmitter is mounted in an enclosure, remove the enclosure cover.
2. Locate the orange failure mode switch. The switch is located near the power terminals on the Model 244EH and in the center of the front panel on the Model 244ER (see Figure 2-13).
3. Move the switch to the desired alarm setting. To set the failure mode to high alarm, position the switch toward the “HI” mark on the terminal block; to set the failure mode to low alarm, position the switch in the opposite direction.
-  4. Replace the enclosure cover (if applicable). Enclosure covers must be fully engaged to meet explosion-proof requirements.

Safety Messages	page 3-1
Power Supply	page 3-1
Configuration	page 3-2
Intermittent Sensor Algorithm	page 3-5

SAFETY MESSAGES

Instructions and procedures in this section may require special precautions to ensure the safety of the personnel performing the operations. Information that raises potential safety issues is indicated by a warning symbol (⚠). Please refer to the following safety messages before performing an operation preceded by this symbol.

Warning

⚠ CAUTION

If the transmitter is installed in a measurement loop, disconnect power to the transmitter before beginning to set up the Model 244EC Configuration Interface. If the Model 244EC connects to a transmitter while the transmitter is powered in a measurement loop, the Model 244EC will shunt the electrical current, possibly resulting in a dangerous situation within the measurement loop.

POWER SUPPLY

The dc power supply should provide power with a ripple that is less than two percent of the nominal supply voltage. The total resistance load is the sum of the resistance of the signal leads and the lead resistance of any controller, indicator, or related piece of equipment in the loop. Note that the resistance of intrinsic safety barriers, if used, must be included.

Surges/Transients

The transmitter will withstand electrical transients of the energy level usually encountered in static discharges or induced switching transients. However, high-energy transients, such as those induced by lightning strikes, welding, heavy electrical equipment, or switch gears, can damage both the transmitter and the sensor.

To protect against high-energy transients, install Models 244E into a suitable connection head with the Rosemount Model 470 Transient Protector. The Model 470 prevents damage from transients induced by lightning, welding, heavy electrical equipment, or switching gears. Refer to the Model 470 Transient Protector Product Data Sheet (document number 00813-0100-4191) for more information.

Grounding

The transmitter will operate with the current signal loop either floating or grounded. However, the extra noise in floating systems affects many types of readout devices. If the signal appears noisy or erratic, grounding the current signal loop at a single point may solve the problem. The best place to ground the loop is at the negative terminal of the power supply.

The transmitter is electrically isolated to 500 V ac rms, so the input circuit also may be grounded at a single point. When using a grounded thermocouple, the grounded junction serves as this point. Do not ground the current signal loop at more than one point.

NOTE

Do not ground the signal wire at both ends.

CONFIGURATION

The Models 244EH and 244ER are designed to be configured using a Model 244EC Configuration Interface connected to a Microsoft Windows-compatible PC running the Models 244EH and 244ER Configuration Software program. Configuration parameters include:

- Sensor type
- Number of wires
- 50/60 Hz filter selection
- Engineering units
- Upper and lower range values
- Damping value
- Tag
- Intermittent Sensor Detect

Each configuration parameter is explained in the on-line help provided with the software. To access the on-line help, either click the **HELP** button on the main configuration window (see Figure 3-1) or choose a topic from the **HELP** menu.

Configuring a Single Transmitter

NOTE

See “Configuration Software” on page 2-9 for instructions on how to install the configuration software.

To configure a single Model 244EH or 244ER transmitter, perform the following procedure:



1. Disconnect power to the transmitter if the transmitter is installed in a measurement loop.

NOTE

Configuring a transmitter while it is powered in a measurement loop could cause the Model 244EC to shunt the current.

2. Set up the transmitter configuration system (see “Model 244EC Configuration Interface” on page 2-11) and open the program.
3. Select **READ FROM XMTR** from the menu bar to initiate the transmitter configuration. The main configuration window will appear (see Figure 3-1).

Figure 3-1. Models 244EH and 244ER Configuration Software Main Configuration Window

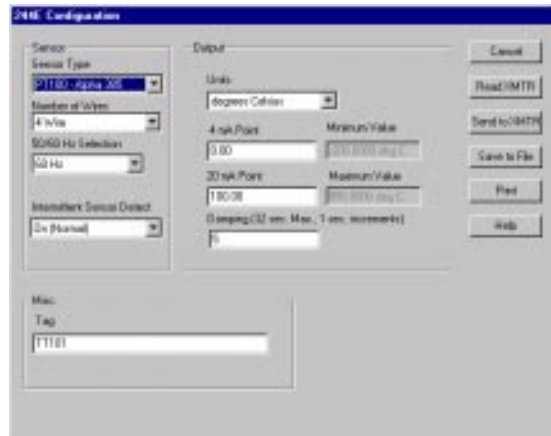

4. Set the configuration parameters. To view a complete list of options for each parameter, click the drop-down arrow in any parameter box. For example, on the main configuration screen, click the arrow in the **UNITS** box to view a list of available units.

NOTE

The configuration of the Intermittent Sensor Detect feature of the Model 244E Temperature Transmitter with version 5.5.1 software cannot be changed with the Model 244EC version 2.0 or earlier. For more information see Section 4: Maintenance and Troubleshooting.

244E-244DF01

NOTE

Each configuration parameter is explained in detail in the on-line help provided with the software. To access help, click the **HELP** button on the main configuration window (see Figure 3-1).

5. Click the **SEND TO XMTR** button to upload configuration information to the transmitter. The software will indicate whether the configuration is successful or unsuccessful. If the configuration succeeds, then go to step Step 6. If the configuration does not succeed, then refer to Section 4: Maintenance and Troubleshooting for a list of possible causes and repeat Step 5 until the transmitter configuration is successful.
6. Click the **SAVE TO FILE** button to save the configuration information for use with other transmitters.

NOTE

To ease the process of later finding a specific configuration file, name saved files according to a logical system and preserve the default **.244** filename extension.

7. Click the **CANCEL** button to close the main configuration window.

Configuring Several Transmitters Identically

To configure several Model 244E transmitters identically, perform the following procedure:

1. Configure a single transmitter according to “Configuring a Single Transmitter” on page 3-3 and save the configuration to a file.
2. Select **OPEN** from the **FILE** menu to open the saved configuration file.
3. Connect a new transmitter to the Configuration Interface.
4. Click the **SEND TO XMTR** button to upload the configuration information to the transmitter. The software will report whether the configuration is successful or unsuccessful. If the configuration succeeds, then go to Step 5. If the configuration does not succeed, then refer to Section 4: Maintenance and Troubleshooting for a list of possible causes and repeat Step 4 until the transmitter configuration is successful.
5. Repeat Steps 3 and 4 until all transmitters are configured.
6. Click the **CANCEL** button to close the main configuration screen.

Viewing the Process Variable

With version 2.0 and later of the Model 244EC Configuration Interface, users can view the measured temperature (PV) by selecting **SERVICE** from the menu bar of the main configuration window (see Figure 3-2). In order to view a valid PV, a temperature sensor must be connected to the Model 244E transmitter, and the transmitter must be configured properly for that sensor type. The PV will be automatically updated on the Model 244EC screen approximately two times per second.

Figure 3-2. Viewing the Process Variable with the 244EC

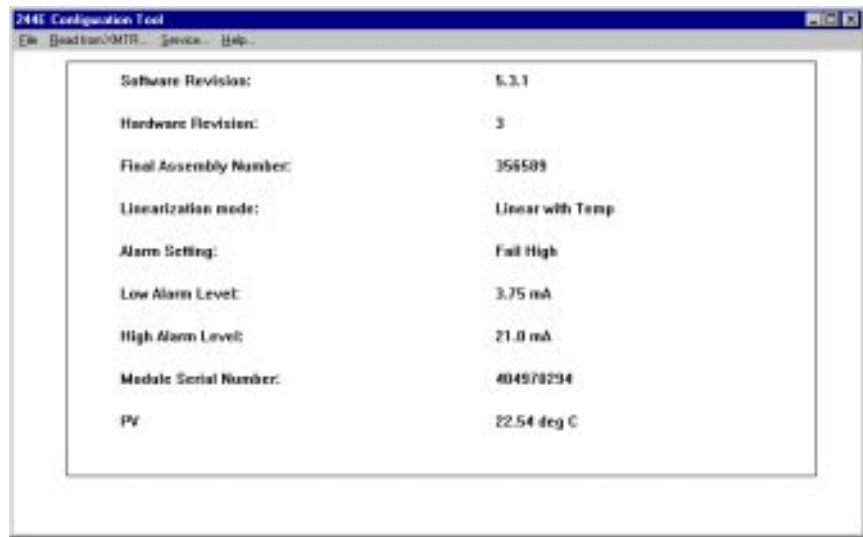

244E-244EC01

INTERMITTENT SENSOR ALGORITHM

The electronics of the Model 244E transmitter contains an intermittent sensor algorithm that monitors the input signal during operation. The signal diagnostics routine, which occurs at each temperature update (every 500 milliseconds), eliminates output pulsing in an intermittent open sensor condition. Further, it validates the input signal before the digital-to-analog (D/A) conversion takes place.

If the process temperature changes, the intermittent sensor algorithm causes the transmitter to respond according to one of the three cases described below. *Threshold value* is the maximum change in reading (as a percentage of output range) within one update cycle (500 ms). The threshold value of the Model 244E is 2% of output range.

Case Examples

Case 1: Open Sensor

If the algorithm detects an open sensor, the transmitter immediately goes into alarm (high or low, depending on the position of the failure mode switch).

Case 2: Temperature Change Greater than the Threshold Value(2% of Output Range)

If the algorithm detects a process temperature change (ΔT) greater than the threshold value (2 % of the output range), but which is not a true open sensor condition, the transmitter will go into a hold period. During the hold period, the transmitter determines whether or not this temperature measurement is valid by using the three additional measurement points. In the meantime, the output remains unchanged at the initial reading (Time = 0 ms).

A) If these next three readings are within the new threshold value (at Time = 500 ms), this measurement is validated. The output changes to reflect this and the transmitter is no longer in a hold period. In this case, the output delay is 1.75 to 2.00 seconds.

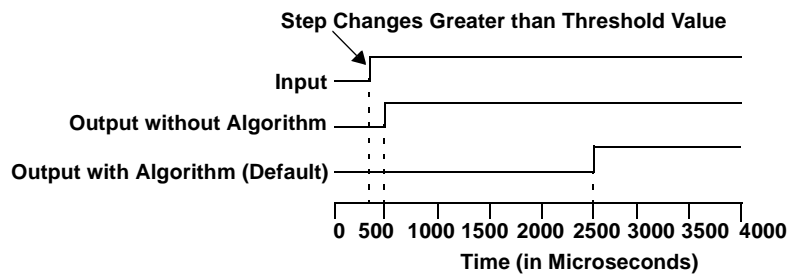

B) If the reading drops back within the original threshold value (at Time = 0 ms) during the hold period, the transmitter interprets the reading(s) outside the threshold value as a spike, and the output changes to reflect the latest reading. The transmitter is no longer in a hold period, and the spike is not seen at the output.

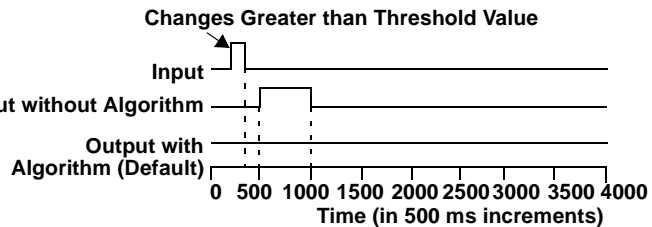

C) If any of the next three measurements is outside the new threshold value (at Time = 500 ms), the output remains unchanged at the initial reading (Time = 0 ms). the transmitter remains in a hold period until four consecutive measurements are within the threshold value of the first in the series.

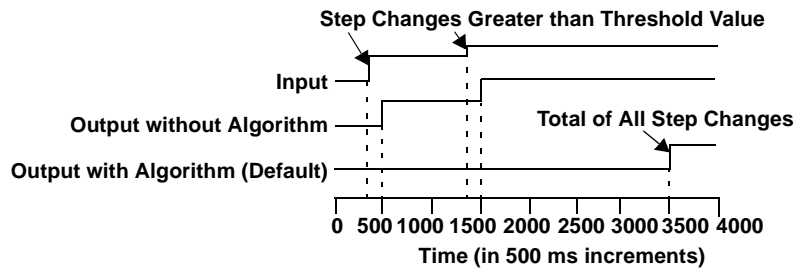

D) If an open sensor is validated at the end of the first update cycle (Time = 500 ms), the output will go directly to alarm level. The original spike (at Time = 0 ms) will not be seen at the output.

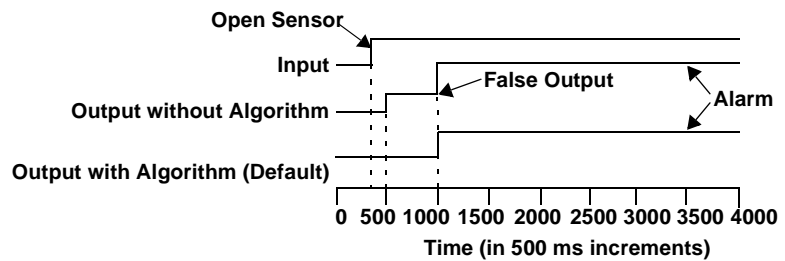

Case 3: Temperature Change Within the Threshold Value (2 % of Range)

If the transmitter detects an input change that is within the threshold value, it reports the new value within one output cycle (500 ms).

If the transmitter has both intermittent sensor detect and damping enabled, the output reading is calculated by the following formula:

$$\text{Damped Value} = (P - N) \times \left(\frac{2T - U}{2T + U} \right) + N$$

- P = previous damped value
- N = new sensor value
- T = damping time constant
- U = update rate

The transmitter outputs the corresponding value on the damping curve within 1.75 to 2.0 seconds and updates the output reading every 500 ms thereafter, according to the damping equation above. At the value to which the damping time constant is set, the transmitter output is at 63% of the input change.

Intermittent Sensor Algorithm and Damping

Figure 4-1 illustrates an example of intermittent sensor detect with damping enabled. If the temperature undergoes a step change greater than the threshold value, or from 100 degrees to 110 degrees, and the damping is set to 5.0 seconds, the transmitter calculates a new reading every 500 ms using the damping equation, but holds the output at 100 degrees for between 1.75 and 2.0 seconds. Within 1.75 and 2.0 seconds, the transmitter outputs the reading that corresponds to the damping curve at that time (❶), and continues to calculate and update the output reading every 500 ms thereafter (❷) according to the damping equation. After 5 seconds, the transmitter outputs 106.3 degrees, or 63% of the input change (❸), and the output continues to approach the input curve according to the equation above.

NOTE

If the damping time constant is set between 0 and 2 seconds, the transmitter does not report the output change until the intermittent sensor algorithm validates the input signal. After validating the input signal, the transmitter outputs the value that corresponds to the damping curve at that time.

Figure 3-3. Damping Function when Input Change is Greater Than the Threshold Value

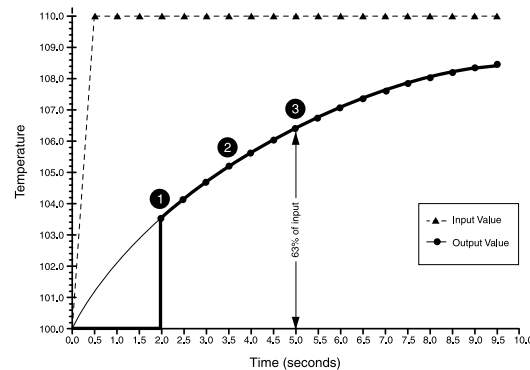

644-644_02A

Intermittent Sensor Detect (Advanced Feature)

NOTE

The Intermittent Sensor Detect feature is not available when using a Model 244EH with software revision 5.5.1. To determine the software version of a Model 244E temperature transmitter, first connect the transmitter to the Model 244EC configurator, open the Model 244EC software configuration tool, and then choose “service” from the Model 244EC software menu.

The Intermittent Sensor Detect feature is designed to guard against process temperature readings caused by intermittent open sensor conditions (an *intermittent* sensor condition is an open sensor condition that lasts less than 0.7 seconds). By default, the transmitter is shipped with the Intermittent Sensor Detect feature switched **ON**. In most applications, this is the preferred setting. The Intermittent Sensor Detect feature can be switched **ON** or **OFF** with the Model 244EC. The setting of this feature cannot be changed when using a Model 244E with version 5.5.1 software and a Model 244EC version 2.0 or earlier.

Transmitter Behavior with Intermittent Sensor Detect ON

When the Intermittent Sensor Detect feature is switched **ON**, the transmitter can eliminate the output pulse caused by intermittent open sensor conditions. Process temperature changes (ΔT) within 2% of the output range will be tracked normally by the transmitter's output. A ΔT greater than 2% of the output range will activate the intermittent sensor algorithm. True open sensor conditions will cause the transmitter to go into alarm.

Transmitter Behavior with Intermittent Sensor Detect OFF

When the Intermittent Sensor Detect feature is switched **OFF**, the transmitter tracks all process temperature changes, even if they are the consequence of an intermittent sensor. The output delay due to the intermittent sensor algorithm will be eliminated.

Implementation

The Intermittent Sensor Detect feature can be turned **ON** or **OFF** using a Model 244E transmitter with software version 5.4.1 or earlier with the Model 244EC software configuration tool when the transmitter is connected to the Model 244EC Configurator.

Turning the Intermittent Sensor Detect feature **OFF** does not affect the time needed for the transmitter to output the correct alarm signal after detecting a true open sensor condition. However, the transmitter may briefly output a false temperature reading for less than 0.5 seconds in either direction (see Figure 3-4) up to 100% of output range.

Figure 3-4. Open Sensor Response (Three Cases)

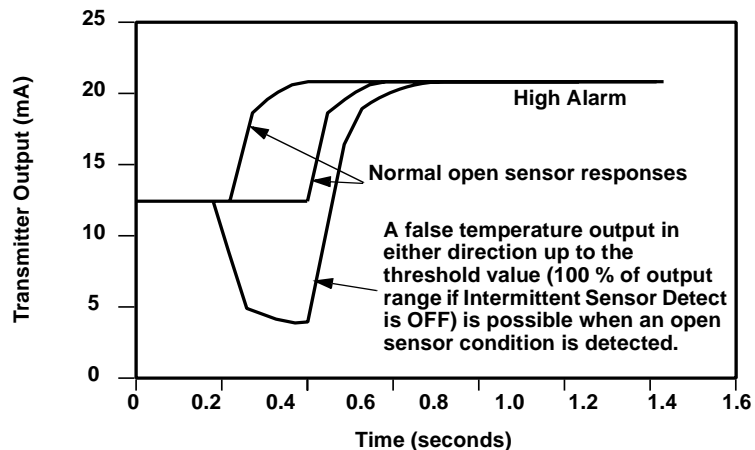

644-644_03

Unless rapid response rate is necessary, the suggested setting of the Intermittent Sensor Detect mechanism is ON.

Maintenance and Troubleshooting

Safety Information	page 4-1
Troubleshooting	page 4-1

SAFETY INFORMATION

Procedures and instructions in this manual may require special precautions to ensure the safety of the personnel performing the operations. Information that raises potential safety issues is indicated by a warning symbol (⚠). Refer to the safety messages listed at the beginning of each section before performing an operation preceded by this symbol.

Warning

⚠ WARNING

- Failure to follow these installation guidelines could result in death or serious injury.
- To clarify error messages that do not appear in this section, contact one of the technical support managers listed at the beginning of this manual.

TROUBLESHOOTING

To determine the software version of a Model 244E temperature transmitter, first connect the transmitter to the Model 244EC configurator, open the 244EC software configuration tool, and then choose "Service " from the 244EC software menu.

Model 244EH software version 5.5.1

The configuration of the Intermittent Sensor Detect feature of the Model 244E Temperature Transmitter with version 5.5.1 or greater software cannot be changed with the Model 244EC version 2.0.0 or earlier. If you attempt to change the configuration of this feature and then click the **SEND TO XMTR** button, the following screen will appear.



SCRNDUMP-244E-STATUS

Rosemount Models 244EH and 244ER PC-Programmable Temperature Transmitters

The “Information Transmitter **UNSUCCESSFUL**” message appears because the transmitter did not accept the change made in the Intermittent Sensor Detect field. However, any other configuration changes sent at the same time as the Intermittent Sensor Direct change will be sent successfully. These other configuration changes can be verified by clicking on the **READ XMTR** button.

TABLE 4-1. Models 244EH and 244ER Troubleshooting Chart

Error Message	Cause and Possible Solutions
Cannot Open 244E Communications Device Driver	The Models 244EH and 244ER Configuration Software is not working properly. Reinstall the software.
Cannot print	Computer cannot find or does not recognize a printer connected to it. Verify that the computer is connected to a suitable printer.
Cannot write to <filename>	The disk is write-protected or full. Verify that the disk is not write-protected and that there is sufficient free space available.
Error reading <filename>	The file's format may have been corrupted. Try reading a backup of the file.
Error writing to <filename>	The disk may have been corrupted or the filename is not valid. Try saving under a different filename.
Field device did not respond	The transmitter did not respond to the inquiry made by the software. Verify all connections in the configuration system. Verify that the transmitter is functional.
Information transfer UNSUCCESSFUL	See “Model 244EH software version 5.5.1” on page 4-1. Some configuration information was not properly transmitted from the configuration program to the transmitter. Verify all connections in the configuration system.
Invalid user entry	The entered values are not within the capabilities of the transmitter. Check the transmitter specifications, then adjust the range and damping values as necessary.
Is not a proper 244E config file	The file is not readable by the configuration software. Try another file.
No response from transmitter	The configuration software did not connect to a transmitter. Verify all connections in the configuration system.
WARNING—Battery low indication received	The battery for the configuration interface is running low on voltage. Replace the battery.

Reference Data

Transmitter Specification	page A-1
Ordering Information	page A-6
Dimensional Drawings	page A-9

TRANSMITTER SPECIFICATION

Functional

Inputs

User selectable using the Model 244EC Configuration Interface and the Models 244EH and 244ER configuration software; sensor terminals rated to 42.4 V dc. See Table A-2 on page A-3.

Output

Two-wire 4–20 mA, linear with temperature for RTDs and thermocouples, and linear with input for millivolts and ohms

Isolation

Input to output isolation tested up to 500 V ac rms (707 V dc) at 50/60 Hz

Power Supply

External power supply required. The transmitters operate on 12.0 to 42.4 V dc terminal voltage. Transmitter power terminals rated to 42.4 V dc.

Load Limitations

$$\text{Maximum Load} = 43.5 \times (\text{Supply Voltage} - 12.0)$$

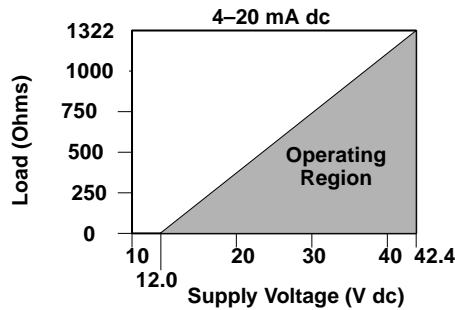

244-24401A

Ambient Temperature Limits

Operating

-40 to 85 °C (-40 to 185 °F)

Storage

-50 to 120 °C (-58 to 248 °F)

Failure Mode

The values that the transmitter drives its output to in failure mode depend on whether it is factory configured to *standard* or *NAMUR-compliant* operation. The values for standard and NAMUR-compliant are as follows:

TABLE A-1. Operation Parameters

	Standard	NAMUR-Compliant
Linear Output:	$3.9 \leq I \leq 20.5 \text{ mA}$	$3.8 \leq I \leq 20.5 \text{ mA}$
Fail High:	$21 \leq I \leq 23 \text{ mA}$ (default)	$21 \leq I \leq 23 \text{ mA}$ (default)
Fail Low:	$I \leq 3.75 \text{ mA}$	$I \leq 3.6 \text{ mA}$

Humidity Limits

0 to 99% relative humidity, non-condensing

Turn-on Time

Performance within specifications is less than 5.0 seconds after power is applied to the transmitter

Update Time

Approximately 0.5 seconds

Performance

The Models 244EH and 244ER maintain a specification conformance of at least 3σ .

Stability

$\pm 0.1\%$ of span or $0.1 \text{ }^\circ\text{C}$, whichever is greater, over 12 month period

Power Supply Effect

Less than $\pm 0.005\%$ of span per volt

Vibration Effect

The transmitters tested to the following specifications with no effect on performance:

Frequency	Vibration
10 to 60 Hz	0.21 displacement
60 to 2000 Hz	3 g peak acceleration

CE Electromagnetic Compatibility Compliance Testing

The Models 244EH and 244ER meet all requirements listed under IEC 61326: Amendment 1, 1998.

Accuracy

TABLE A-2. Model 244E Input Options and Accuracy.

Sensor Options	Sensor Reference	Input Ranges		Recommended Min. Span ⁽¹⁾		Accuracy (whichever is greater)
		°C	°F	°C	°F	
2-, 3-, 4-wire RTDs						
Pt 100	IEC 751, 1995 ($\alpha = 0.00385$)	-200 to 850	-328 to 1562	10	18	0.05% of span + 0.15 °C or 0.2 °C
Pt 100	JIS 1604, 1981 ($\alpha = 0.003916$)	-200 to 645	-328 to 1093	10	18	0.05% of span + 0.15 °C or 0.2 °C
Pt 200	IEC 751, 1995 ($\alpha = 0.00385$)	-200 to 850	-328 to 1562	10	18	0.01% of span or 0.4 °C
PT 500	IEC 751, 1995 ($\alpha = 0.00385$)	-200 to 850	-328 to 1562	10	18	0.01% of span or 0.3 °C
Pt 1000	IEC 751, 1995 ($\alpha = 0.00385$)	-200 to 300	-328 to 572	10	18	0.01% of span or 0.3 °C
Ni 120	Edison Curve No. 7	-70 to 300	-94 to 572	10	18	0.01% of span or 0.2 °C
Cu 10	Edison Copper Winding No. 1	-50 to 250	-58 to 482	10	18	0.5% of span or 1.5 °C
Thermocouples ⁽²⁾						
Type B ⁽³⁾	NIST Monograph 175, IEC 584	100 to 1820	212 to 3308	25	40	0.2% of span or 1.0 °C
Type E	NIST Monograph 175, IEC 584	-50 to 1000	-58 to 1832	25	40	0.1% of span or 0.5 °C
Type J	NIST Monograph 175, IEC 584	-180 to 760	-292 to 1400	25	40	0.1% of span or 0.5 °C
Type K	NIST Monograph 175, IEC 584	-180 to 1372	-292 to 2502	25	40	0.1% of span or 1.0 °C
Type N	NIST Monograph 175, IEC 584	-200 to 1300	-328 to 2372	25	40	0.1% of span or 1.0 °C
Type R	NIST Monograph 175, IEC 584	0 to 1768	32 to 3214	25	40	0.1% of span or 1.0 °C
Type S	NIST Monograph 175, IEC 584	0 to 1768	32 to 3214	25	40	0.1% of span or 1.0 °C
Type T	NIST Monograph 175, IEC 584	-200 to 400	-328 to 752	25	40	0.1% of span or 0.5 °C
DIN Type L	DIN 43710	-200 to 900	-328 to 1652	25	40	0.1% of span or 0.5 °C
DIN Type U	DIN 43710	-200 to 600	-328 to 1112	25	40	0.1% of span or 0.5 °C
Type W5Re/W26Re	ASTME 988-96	0 to 2000	32 to 3632	25	40	0.1% of span or 1.0 °C
Millivolt Input		-10 to 100 mV		3 mV		0.025 mV + 0.003% of span
2-, 3-, 4-wire Ohm Input		0 to 2000 ohms		20 ohm		0.75 Ω + 0.03% of span

(1) No minimum or maximum span restrictions within the input ranges. Recommended minimum span will hold noise within accuracy specification with damping at zero seconds.

(2) Total digital accuracy for thermocouple measurement: sum of digital accuracy + 0.5 °C (cold junction accuracy)

(3) Accuracy for NIST Type B thermocouple is ± 3.0 °C from 100 to 300 °C.

When using a Pt 100 ($\alpha = 0.00385$) sensor input with a 75 to 150 °C range, the accuracy will be 0.05% of span + 0.15 °C or 0.20 °C, whichever is greater. Sample Calculation: $[0.0005 (150-75) + 0.15] = 0.19$ °C, which is less than 0.20 °C, so the accuracy equals 0.20 °C.

Rosemount Models 244EH and 244ER PC-Programmable Temperature Transmitters

Ambient Temperature Effect

Transmitters can be installed in locations where the ambient temperature is between -40 and 85 °C (-40 and 185 °F). At the factory, each transmitter is individually characterized over this ambient temperature range. This special manufacturing technique is accomplished through hot and cold temperature profiling with individual adjustment factors programmed into each transmitter. The transmitters automatically adjust for component temperature drift caused by changing environmental conditions.

TABLE A-3. Models 244E Ambient Temperature Effects per 1 °C (1.8 °F)

Sensor Options ⁽¹⁾	Fixed Value	% of reading		% of Span
		(if reading > 0)	(if reading is < 0)	
2-, 3-, 4-wire RTDs				
PT 100 ($\alpha = 0.00385$)	0.003 °C	—	—	+0.001% of span
Pt 100 ($\alpha = 0.003916$)	0.003 °C	—	—	0.001% of span
Pt 200	0.004 °C	—	—	0.001% of span
Pt 500	0.003 °C	—	—	0.001% of span
Pt 1000	0.003 °C	—	—	0.001% of span
Ni 120	0.003 °C	—	—	0.001% of span
Cu 10	0.03 °C	—	—	0.001% of span
Thermocouples				
Type B (100 °C \leq reading $<$ 300 °C)	0.064 °C	-0.011	—	0.001% of span
(300 °C \leq reading $<$ 1000 °C)	0.040 °C	-0.025	—	0.001% of span
(reading \geq 1000 °C)	0.014 °C	—	—	0.001% of span
Type E	0.005 °C	-0.00043	-0.0043	0.001% of span
Type J, K, DIN L	0.006 °C	-0.00054	-0.0025	0.001% of span
Type N	0.007 °C	-0.00036	—	0.001% of span
Type R, S (reading $<$ 200 °C)	0.023 °C	-0.0036	—	0.001% of span
(reading \geq 200 °C)	0.016 °C	—	—	0.001% of span
Type T, DIN U	0.007 °C	—	-0.043	0.001% of span
Type W5Re/W26Re	0.023 °C	-0.0036	—	0.001% of span
	0.016 °C	—	—	—
Millivolt Input	0.0005 mV	—	—	0.001% of span
2-, 3-, 4-wire Ohm	0.0084 Ω	—	—	0.001% of span

(1) Change in ambient is with reference to the calibration temperature of the transmitter 68 °F (20 °C) from factory.

When using a Type J thermocouple with a -50 °C to 600 °C temperature range at an ambient temperature of 60 °C and a reading of -25 °C, the ambient temperature effect according to °C is: [fixed value (a) + (% of reading (b) \times reading) + (% of span (c) \times span)] = [0.006 + (-0.000025 \times (-25)) + (0.00001 \times 650)] = 0.013 °C per °C. With the ambient temperature 40 °C above reference condition temperature, the total ambient temperature effect is: $40 \times 0.013 = 0.52$ °C.

When using a Type J thermocouple with a -50 °C to 600 °C temperature range at an ambient temperature of 60 °C and a reading of 525 °C, the ambient temperature effect according to °C is: [fixed value (a) + (% of reading (b) \times reading) + (% of span (c) \times span)] = [0.006 + (0.000054 \times 525) + (0.00001 \times 650)] = 0.015 °C per °C. With the ambient temperature 40 °C above reference condition temperature, the total ambient temperature effect is: $40 \times 0.015 = 0.6$ °C.

The worst case error would be: Reference Accuracy + CJC Accuracy + Temp Effects = 0.65 °C + 0.5 °C + 0.52 °C = 1.67 °C. Total Probable Error: $\sqrt{0.65^2 + 0.5^2 + 0.52^2} = 0.97$ °C

Physical

Electrical Connections

Power and Sensor Terminals

Model 244EH	Compression screws permanently fixed to terminal block	Clips permanently fixed to terminal block
-------------	--	---

Model 244ER:	Compression screw permanently fixed to front panel	Clips permanently fixed to front panel
--------------	--	--

WAGO® spring clamp terminals are optional (option code G5)

Materials of Construction

Construction Material for the Electronics Housing and Terminal Block

Model 644H	Noryl® glass reinforced
------------	-------------------------

Model 644R:	Lexan® polycarbonate
-------------	----------------------

Mounting

The Model 244EH installs in a connection head or universal head mounted directly on a sensor assembly, apart from a sensor assembly using a universal head, or to a DIN rail using an optional mounting clip. The Model 244ER mounts directly to a wall or to a DIN rail.

Weight

Code	Options	Add ⁽¹⁾
Model 244EH	Head Mount	78 (2.75)
J5, J6	Universal Head	520 (18.43)
Model 644R	Rail Mount	173 (6.10)

(1) All weights are in grams (ounces).

Enclosure Ratings

Option codes J5 and J6 are NEMA 4X, IP66, and IP68.

Option code J6 is CSA Enclosure Type 4X

Model 244EC Configuration Interface

Power Supply

9 V dc battery or wall adapter

Output voltage rating:	8 to 12 V dc
------------------------	--------------

Output current rating:	100 mA minimum
------------------------	----------------

Connector:	3.5 mm diameter male plug, positive tip, negative sleeve
------------	--

To meet CSA ordinary location approval requirements, the wall power adapter must be CSA listed with a Class 2 output. To meet FM ordinary location approval requirements, the wall power adapter must be listed by a Nationally Recognized Test Laboratory (such as FM or UL) with a Class 2 output.

Ambient Temperature Limits

32 to 104 °F (0 to 40 °C)

Humidity Limits

0 to 99% relative humidity, non-condensing

Rosemount Models 244EH and 244ER PC-Programmable Temperature Transmitters

ORDERING INFORMATION

TABLE A-4. Model 244EH and 244ER Temperature Transmitter Ordering Information

		• = Available — = Not available		
Model	Product Description	Head Mount	Rail Mount	
244EH	Head Mount Temperature Transmitter	•	—	
244ER	Rail Mount Temperature Transmitter	—	•	
Code	Hazardous Area Certifications	Enclosure Purchase Required?	Head Mount	Rail Mount
E5	FM Explosion-Proof Approval	Yes	•	—
I5	FM Intrinsic Safety and Non-Incendive Approval	No*	•	•
K5	FM Intrinsic Safety, Non-Incendive, and Explosion-Proof Approval Combination	Yes	•	—
I6	CSA Intrinsic Safety and Non-Incendive Approval	No*	•	•
C6	CSA Intrinsic Safety, Non-Incendive, and Explosion-Proof Approval Combination	Yes	•	—
N1	CENELEC/BASEEFA Type n Approval	Yes	•	—
ED	CENELEC/KEMA Flameproof Approval	Yes	•	—
I1	CENELEC/BASEEFA Intrinsic Safety Approval	No*	•	•
E7	SAA Flameproof Approval. <i>Consult factory for availability.</i>	Yes	•	—
N7	SAA Type N Approval. <i>Consult factory for availability.</i>	Yes	•	—
I7	SAA Intrinsic Safety Approval. <i>Consult factory for availability.</i>	No*	•	•
NA	No Approval	No*	•	•
* Transmitters with intrinsic safety approvals can be ordered without enclosures. However, to meet intrinsic safety requirements, the transmitter must be installed in an enclosure with IP20 or higher rating. Model 244EH transmitters ordered with enclosure options J5 or J6 meet this requirement.				
Code	Options		Head Mount	Rail Mount
Assembly Options (Model 244EH Only)				
X1	Assemble Transmitter to a Sensor Assembly (hand tight, <i>Teflon</i> [®] (PTFE) tape where appropriate, fully wired)		•	—
X2	Assemble Transmitter to a Sensor Assembly (hand tight, no <i>Teflon</i> (PTFE) tape, unwired)		•	—
X3	Assemble Transmitter to a Sensor Assembly (wrench tight, <i>Teflon</i> (PTFE) where appropriate, fully wired)		•	—
<i>Note: If ordering X1, X2, X3, specify the same code on the sensor model number. Option codes X1 and X3 are not available with CSA Approvals (Hazardous Area Certifications C6 or I6)</i>				
Enclosure Options				
Threaded Style Temperature Sensor Users (Americas and Asia Pacific) <i>Remote/Integral Mount</i>				
J6	Universal Head (Junction Box), Aluminum Alloy with 2-in. SST Pipe Bracket (M20 Entries)		•	—
	DIN Plate Style Temperature Sensor Users (EMEA-Europe, Middle East, and Africa) <i>Remote Mount</i>			
J5	Universal Head (Junction Box), Aluminum Alloy with 2-in. SST Pipe Bracket (M20 Entries)		•	—
J6	Universal Head (Junction Box), Aluminum Alloy with 2-in. SST Pipe Bracket (1/2–14 NPT Entries)		•	—
Integral Mount				
*****Order connection head through Volume 2 of the Rosemount Temperature Sensor and Accessories Product Data Sheet (document number 00810-0101-2654) sensor model number*****				
Configuration Options				
A1	Analog Output Levels Compliant with NAMUR-Recommendations NE 43:June 1997		•	•
CN	Analog Output Levels Compliant with NAMUR-Recommendations NE 43: June 1997: Alarm Configuration Low		•	•
F6	60 Hz Line Voltage Filter		•	•
Calibration Options				
C4	5-Point Calibration. <i>Use Q4 option to generate a calibration certificate</i>		•	•
Q4	Calibration Certificate. <i>3-Point standard; use C4 with Q4 option for a 5-point calibration certificate.</i>		•	•
Accessory Options (Model 244EH only)				
G1	External Ground Screw. <i>Only available with enclosure options J5 or J6.</i>		•	—
G2	Cable Gland. <i>Only available with option code J5.</i>		•	—
G3	Cover Chain. <i>Only available with enclosure options J5 or J6. Not available with LCD meter option code M5.</i>		•	—
G5	WAGO Spring Clamp Terminals		•	—
Typical Model Number – Americas and Asia Pacific: 244EH E5 X1 J6 F6				
Typical Model Number – Europe, Middle East, Africa: 244EH ED X1				

TABLE A-5. Model 244EC Configuration Interface Ordering Information

• = Available
 — = Not available

Model	Product Description	244EH
244EC	Model 244EC Configuration Interface Hardware and Software	•
Typical Model Number: 244EC		

TABLE A-6. Transmitter Accessories

Part Description	Part Number
Aluminum Allow Universal Head, Standard Cover—M20 Entries	00644-4420-0002
Aluminum Allow Universal Head, Standard Cover—1/2-14 NPT Entries	00644-4420-0001
Ground Screw Assembly Kit	00644-4431-0001
Models 244EH and 244ER Configuration Software (Four 3.5" Diskettes)	00244-3401-0003
Black <i>MINIGRABBER</i> ™ Configuration Lead	C539920001
Red <i>MINIGRABBER</i> Configuration Lead	C539920002
Universal Clip for Rail or Wall Mount (Model 244ER only)	03044-4103-0001
Kit, Hardware for Mounting a Model 244EH to a DIN rail (includes clips for symmetrical and asymmetrical rails)	00644-5301-0010
Kit, Hardware for Retrofitting a Model 244EH in an existing Threaded Sensor Connection Head (former option code L1)	00644-5321-0010
24 Inches of Symmetric (Top Hat) Rail	03044-4200-0001
24 Inches of Asymmetric (G) Rail	03044-4201-0001
Ground Clamp for symmetric or asymmetric rail	03044-4202-0001
End Clamp for symmetric or asymmetric rail	03044-4203-0001
Blank Transmitter Configuration Labels (sheet of 48)	00644-5154-0001
Snap Rings Kit (used for assembly to DIN sensor)	00644-4432-0001

Ordering Flameproof and Explosion-proof Approvals for Temperature Assemblies

Both flameproof and explosion-proof protection depend on the enclosure type. Compliance with flameproof and explosion-proof approvals requires an appropriately approved assembly, including the sensor. The Model 244EH requires an appropriate enclosure for approved use in locations requiring flameproof or explosion-proof installations.

Orders that include enclosure options J5 or J6 must be ordered from the Model 244EH ordering information table.

When ordering a complete DIN style assembly, select the appropriate connection head from Volume 2 of the Rosemount Temperature Sensors and Accessories PDS (document number 00813-0101-2654).

Standard Configuration

Unless specified, transmitter will be shipped as follows:

Standard Configuration⁽¹⁾

Sensor Type:	RTD, PT 100 ($\alpha = 0.00385$, 4-wire)
4 mA Value:	0 °C
20 mA Value:	100 °C
Damping:	5 seconds
Failure Mode:	High/Upscale
Line Voltage Filter:	50 Hz
Tag	See "Tagging" below

(1) All standard configuration settings may be changed in the field with the Model 244EC Configuration Interface.

Custom Configuration

The transmitter can be ordered with custom configuration. Use Table A-7 to determine the requirements when specifying the custom configuration.

TABLE A-7. Custom Configuration Requirements/Specification.

Option Code	Requirements/Specification
A1: NAMUR-compliant	See Table A-1 on page A-2
CN: NAMUR-Compliant, Low Alarm	See Table A-1 on page A-2
C4: Five Point Calibration	Will include five-point calibration at 0, 25, 50, 75, and 100% analog and digital output points. Use with Rosemount Calibration Certificate Q4.
F6: 60 Hz Line Filter	Calibrated to a 60 Hz line voltage filter instead of the standard 50 Hz filter

Tagging

Hardware Tag	Software Tag
<ul style="list-style-type: none"> No charge Tagged in accordance with customer requirements Tags are adhesive labels Permanently attached to transmitter Character height is 1/16-in (1.6 mm) 	<ul style="list-style-type: none"> The transmitter can store up to 30 characters in its memory Transmitter can be ordered with different software and hardware tags If the software tag characters are not specified, the software tag will default to the first 30 characters of the hardware tag.

DIMENSIONAL DRAWINGS

Transmitter

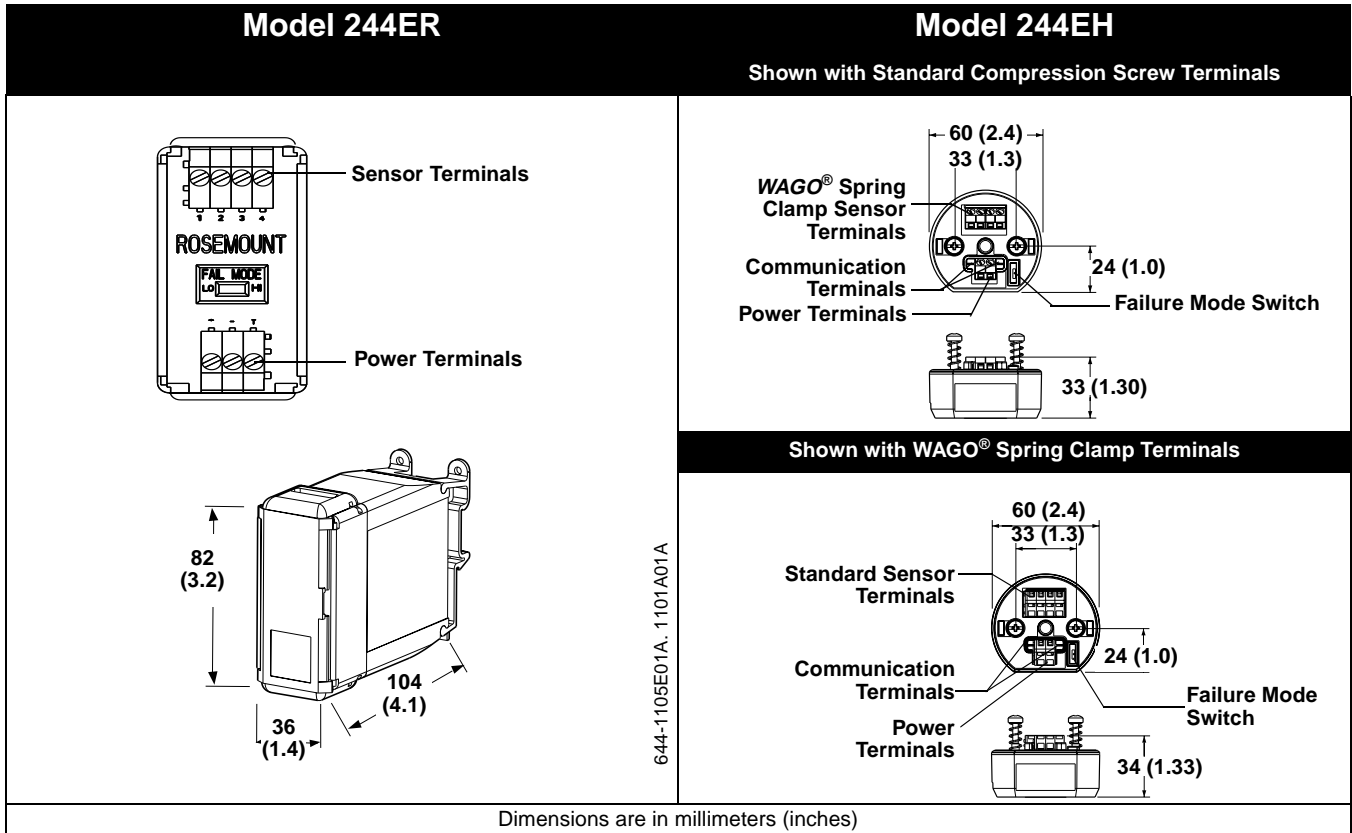

Enclosure and Model 244EC Configuration Interface

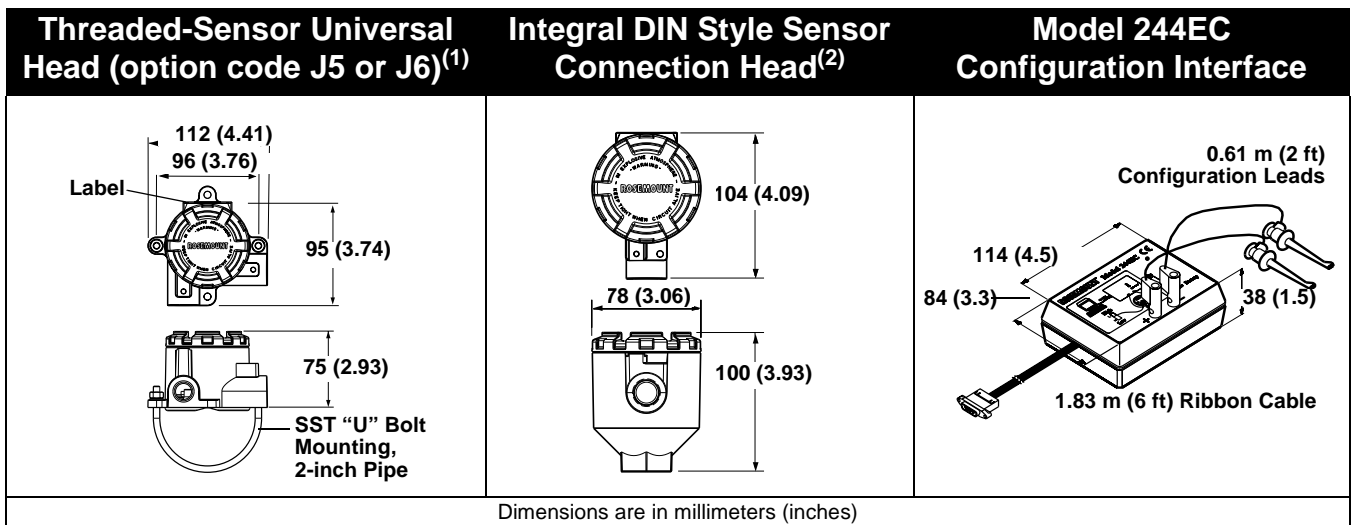

(1) A "U" Bolt is shipped with each universal head unless assembly option code X1, X2, or X3 is ordered. However, since the head can be integrally mounted to the sensor, it may not need to be used.

(2) Note: The DIN Style Integral sensor connection head is only available through Volume 2 of the sensors product data sheet.

Approvals

Safety Messages	page B-1
Hazardous Locations Installations	page B-1
Locations Certifications	page B-2
Installation Drawings	page B-4

SAFETY MESSAGES

Instructions and procedures in this section may require special precautions to ensure the safety of the personnel performing the operations. Information that raises potential safety issues is indicated by a warning symbol (⚠). Please refer to the following safety messages before performing an operation preceded by this symbol.

⚠ WARNING

Once a device labeled with multiple approval types is installed, it should not be reinstalled using any of the other labeled approval types. To ensure this, the approval label should be permanently marked to distinguish the used from the unused approval type(s).

HAZARDOUS LOCATIONS INSTALLATIONS

⚠ The Models 244E are available with circuitry that is suitable for intrinsically safe operation. The Model 244EH is available with optional explosion-proof enclosures and can be specified for non-incendive operation. Individual transmitters are clearly marked with a tag indicating the approvals they carry.

To maintain certified ratings for installed transmitters, they must be installed in accordance with all applicable installation codes and approval drawings. Verify that the operating atmosphere of the transmitter is consistent with the appropriate hazardous locations certification.

IMPORTANT

Once a device labeled with multiple approval types is installed, it should not be reinstalled using any of the other labeled approval types. To ensure this, the approval label should be permanently marked to distinguish the used from the unused approval type(s).

**LOCATIONS
CERTIFICATIONS**

Factory Mutual (FM) Approvals

- E5** Explosion-Proof for Class I, Division 1, Groups B, C, and D. Dust-Ignition Proof for Class II, Division 1, Groups E, F, and G. Dust-Ignition Proof for Class III, Division 1 hazardous locations when installed in accordance with Rosemount Drawing 00644-1049. Non-Incendive for Class I, Division 2, Groups A, B, C, and D. Ambient temperature limits: -50 to 85 °C. Conduit seal not required for compliance with NEC 501-5a(1). Temperature Code T5 ($T_{amb} = 85\text{ °C}$)
-

NOTE:

Approval E5 is only available with 244EH option codes J5 and J6.

- I5** Intrinsically Safe for Class I, II, III, Division 1, Groups A, B, C, D, E, F, G; Non-incendive for Class I, Division 2, Groups A, B, C, D. Ambient temperature limits: -50 to 60 °C when installed in accordance with Rosemount Drawing 00644-0009.

FM Entity Parameters: See installation drawing identified on the transmitter approval label and Appendix C: Models 644 and 244E Temperature Transmitters Manual Supplement for entity parameters.

- K5** Combination of E5 and I5
-

NOTE:

Approval K5 is only available with Model 244EH option codes J5 and J6.

Canadian Standards Association (CSA) Approvals

- I6** Intrinsically safe for Class I, Division 1, Groups A, B, C, and D when connected in accordance with Rosemount drawing 00644-1064 (see Appendix C: Models 644 and 244E Temperature Transmitters Manual Supplement for connection parameters).
- C6** Combination of I6 and the following: Explosion-Proof for Class I, Division 1, Groups C and D. Dust-ignition proof for Class II, Division 1, Groups E, F, and G. Dust-ignition proof for Class III, Division 1 hazardous locations when installed in accordance with Rosemount Drawing 00644-1059. Suitable for Class I, Division 2, Groups A, B, C, and D (must be installed in a suitable enclosure).
-

NOTE:

Approval C6 is only available with Model 244EH option code J6.

KEMA Approvals

ED ATEX II 2 G

Flameproof (Zone 1) (Model 244EH only)

EEx d IIC T6 ($T_{amb} = -40$ to 65 °C).

NOTE:

Flameproof certification is only available as a complete assembly with Rosemount universal head – option codes J5 or J6.

British Approvals Service for Electrical Equipment in Flammable Atmospheres (BASEEFA) Approvals

I1 ATEX II 1 G

Intrinsically Safe Operation (Zones 0)

EExia IIC T6 ($T_{amb} = -60$ to 40 °C)

EExia IIC T4 ($T_{amb} = -60$ to 80 °C)

Entity Parameters: See appropriate approval certificate and Appendix C: Models 644 and 244E Temperature Transmitters Manual Supplement for entity parameters.

Special Conditions for Safe Use (X):

The transmitter must be installed so that its external terminals and communication pins are protected to at least IP20.

N1 ATEX II 3 G

Type 'nL' Operation Non-Incendive Approval (Zone 2 only)

Ex nL IIC T5 ($T_{amb} = 70$ °C)

(Type 'nL' certification is only available as a complete assembly with the Rosemount universal head, thermometer, and thermowell.)

Standard Australia Quality Assurance Service (SAA)

NOTE

Consult factory for SAA availability.

I7 Intrinsic Safety,

Ex ia IIC T6 ($T_{amb} = -40$ to 40 °C)

Ex ia IIC T4 ($T_{amb} = -40$ to 70 °C)

Entity Parameters: See appropriate approval certificate

Special Conditions for Safe Use (X):

The transmitter must be installed so that its external terminals and communication pins are protected to at least IP20.

N7 Type N Approval,
Ex n IIC T5 ($T_{amb} = 70\text{ °C}$)

Special Conditions for Safe Use (X):

The assembly must be installed such that its external terminals and communication pins are protected to at least the requirements of IP54.

E7 Flameproof Approval (Model 244EH only)
Ex d IIC T6

NOTE:

Flameproof certification is only available as a complete assembly with Rosemount universal head – option codes J5 or J6.

Gostandart

Tested and approved by the Russian Metrological Institute
GOSTANDART.

The Model 244EC Configuration Interface is approved for Factory Mutual (FM) and Canadian Standards Association (CSA) Ordinary Locations

**INSTALLATION
DRAWINGS**

The installation guidelines presented by the drawings must be followed in order to maintain certified ratings for installed transmitters.

Rosemount Drawing 00644-1064, 1 Sheet,
Canadian Standards Association Intrinsic Safety Installation Drawing

Rosemount Drawing 00644-1059, 1 Sheet;
Canadian Standards Association Explosion-Proof Installation Drawing

Rosemount Drawing 00644-0009, 1 Sheet
Factory Mutual Intrinsic Safety Installation Drawing

Rosemount Drawing 00644-1049, 1 Sheet;
Factory Mutual Explosion-proof Installation Drawing

IMPORTANT

Once a device labeled with multiple approval types is installed, it should not be reinstalled using any of the other labeled approval types. To ensure this, the approval label should be permanently marked to distinguish the used from the unused approval type(s).

Figure B-1. Canadian Standards Association (CSA) Intrinsic Safety Installation Drawing 00644-1064, Rev. AB

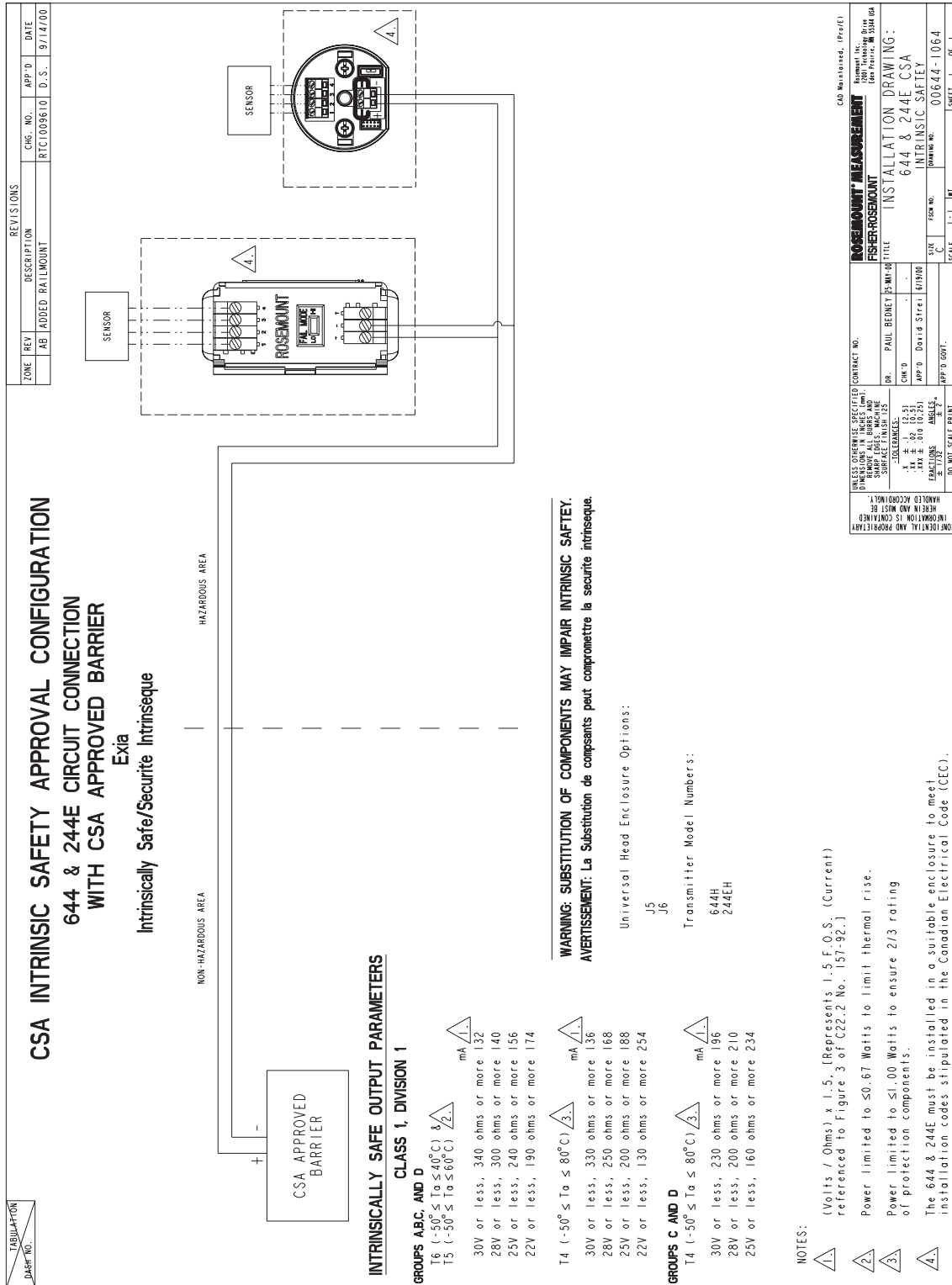

Rosemount Models 244EH and 244ER PC-Programmable Temperature Transmitters

Figure B-2. Canadian Standards Association (CSA) Explosion-Proof Installation Drawing 00644-1059, Rev. AA

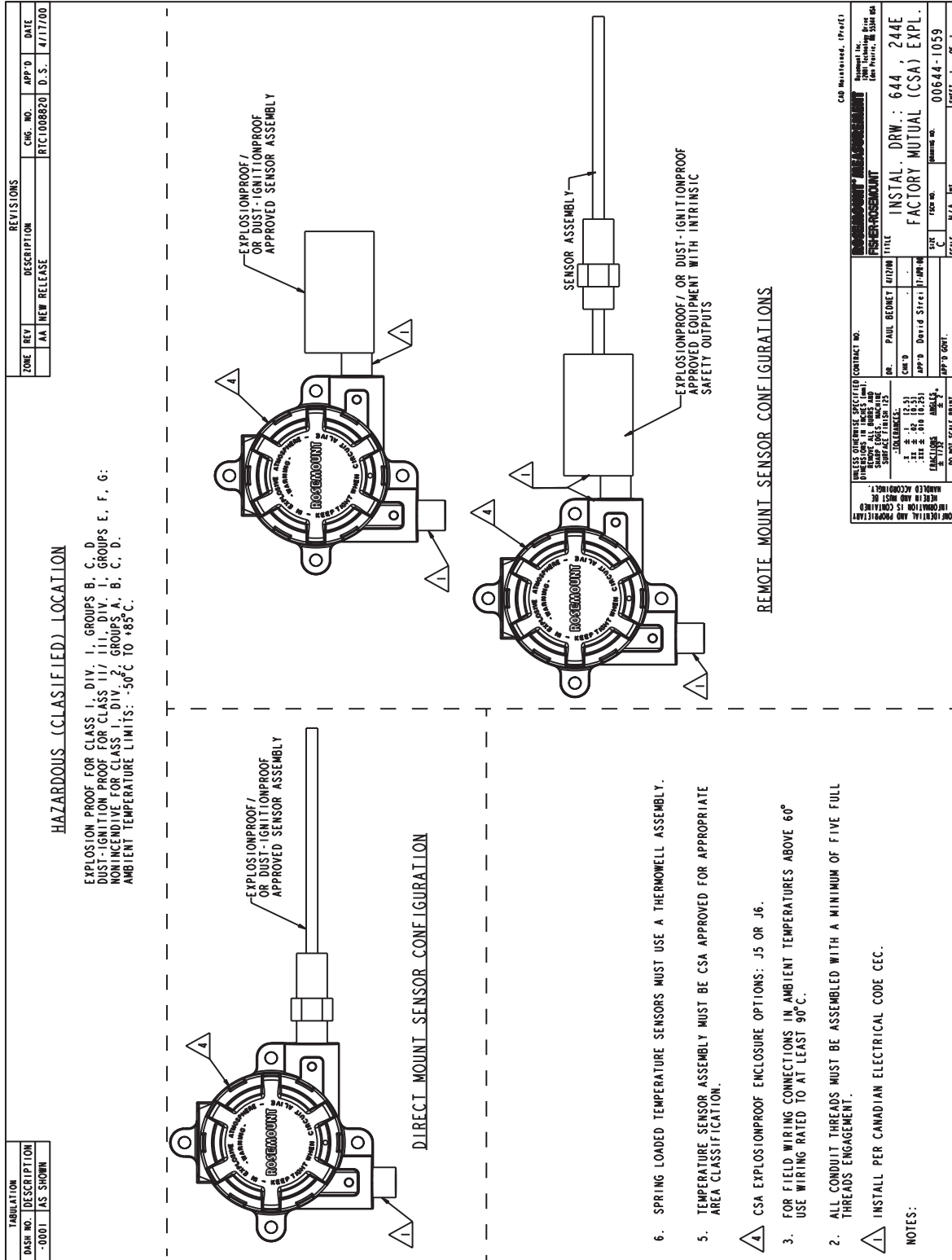
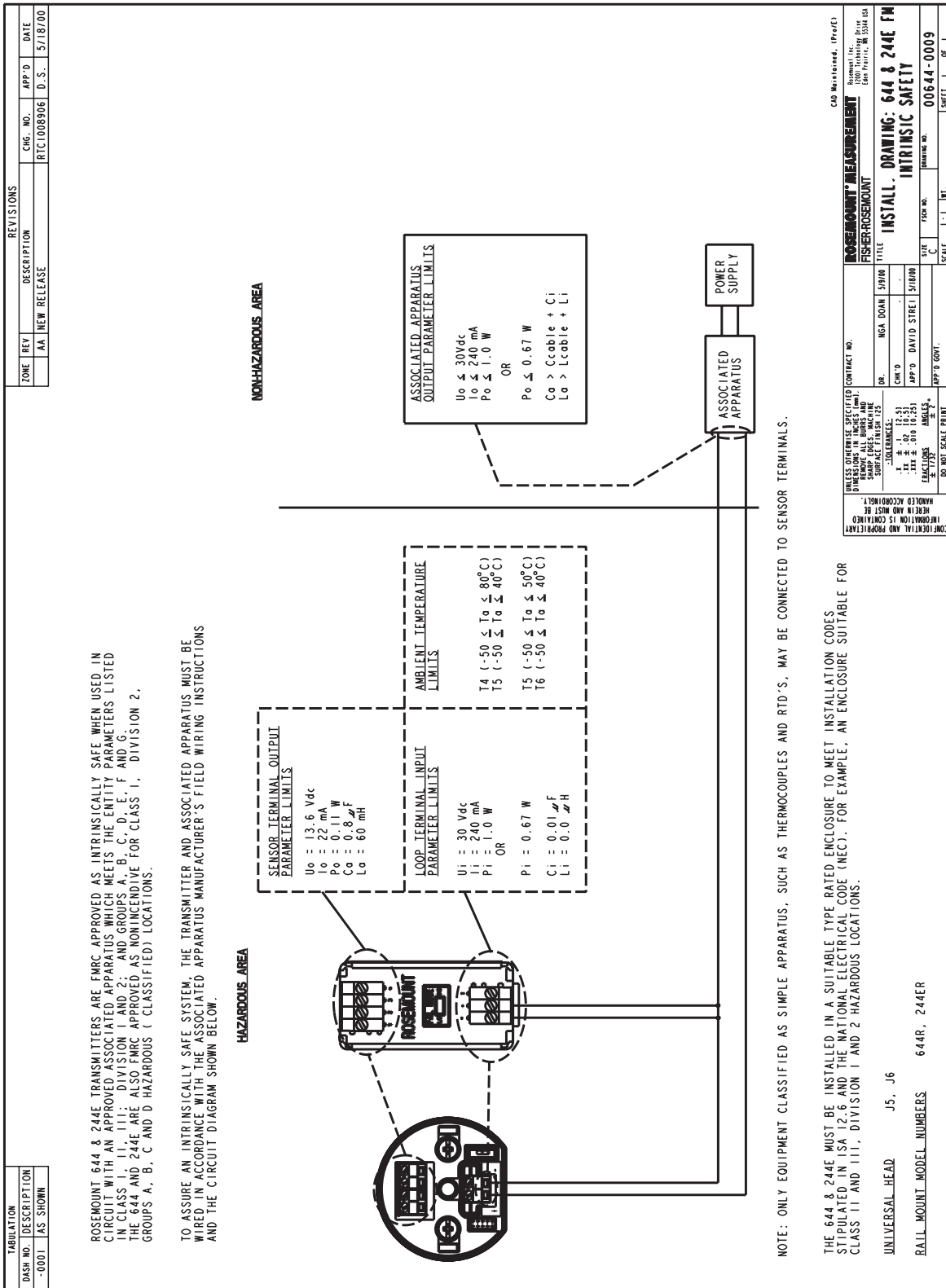

Figure B-3. Factory Mutual (FM)
Intrinsic Safety Installation Drawing
00644-0009, Rev. AA



644-0009A01A

Rosemount Models 244EH and 244ER PC-Programmable Temperature Transmitters

Figure B-4. Factory Mutual (FM)
Explosion-Proof Installation Drawing
00644-1049, Rev. AB

TABULATION		REVISIONS	
DASH NO.	DESCRIPTION	REV	DESCRIPTION
-0001	AS SHOWN	AB	UPDATE DESC. OF SENSOR ASST. RTIC1008912
			CHG. NO. APP'D DATE
			D. S. 4/27/00

HAZARDOUS (CLASSIFIED) LOCATION

EXPLOSION PROOF FOR CLASS 1, DIV. 1, GROUPS B, C, D
DUST-IGNITION PROOF FOR CLASS 11, DIV. 1, GROUPS E, F, G;
NON-IGNITIVE FOR CLASS 1, DIV. 2, GROUPS A, B, C, D.
AMBIENT TEMPERATURE LIMITS: -50°C TO +85°C.

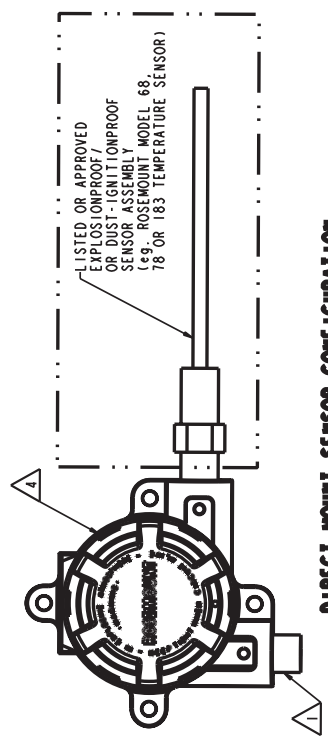

DIRECT MOUNT SENSOR CONFIGURATION

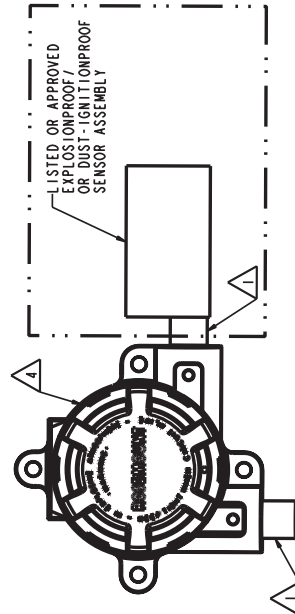

REMOTE MOUNT SENSOR CONFIGURATION

7. SPRING LOADED TEMPERATURE SENSORS MUST BE PLACED IN A LISTED OR APPROVED THERMOWELL RATED FOR APPROPRIATE AREA CLASSIFICATION TO PROVIDE A SEAL FROM THE PROCESS.

6. TEMPERATURE SENSOR ASSEMBLY MUST BE FM APPROVED FOR APPROPRIATE AREA CLASSIFICATION.

5. CONDUIT AND SENSOR MUST BE ASSEMBLED TO UNIVERSAL HEAD USING THREAD SEALANT OR TAPE.

4. FM EXPLOSIONPROOF ENCLOSURE OPTIONS: J5 OR J6.

3. FOR FIELD WIRING CONNECTIONS IN AMBIENT TEMPERATURES ABOVE 60° USE WIRING RATED TO AT LEAST 90°C.

2. ALL CONDUIT THREADS MUST BE ASSEMBLED WITH A MINIMUM OF FIVE FULL THREADS ENGAGEMENT.
INSTALL PER NATIONAL ELECTRICAL CODE (NEC). CONDUIT SEAL NOT REQUIRED FOR COMPLIANCE WITH NEC 501-5a(1).

1. NOTES:

CONTRACTOR AND PROPRIETARY INFORMATION IS CONTAINED HEREIN AND MUST BE HANDLED ACCORDING TO THE FOLLOWING:

1. ALL DIMENSIONS ARE TO SURFACE UNLESS OTHERWISE SPECIFIED.

2. DIMENSIONS ARE TO SURFACE UNLESS OTHERWISE SPECIFIED.

3. DIMENSIONS ARE TO SURFACE UNLESS OTHERWISE SPECIFIED.

4. DIMENSIONS ARE TO SURFACE UNLESS OTHERWISE SPECIFIED.

5. DIMENSIONS ARE TO SURFACE UNLESS OTHERWISE SPECIFIED.

6. DIMENSIONS ARE TO SURFACE UNLESS OTHERWISE SPECIFIED.

7. DIMENSIONS ARE TO SURFACE UNLESS OTHERWISE SPECIFIED.

8. DIMENSIONS ARE TO SURFACE UNLESS OTHERWISE SPECIFIED.

9. DIMENSIONS ARE TO SURFACE UNLESS OTHERWISE SPECIFIED.

10. DIMENSIONS ARE TO SURFACE UNLESS OTHERWISE SPECIFIED.

11. DIMENSIONS ARE TO SURFACE UNLESS OTHERWISE SPECIFIED.

12. DIMENSIONS ARE TO SURFACE UNLESS OTHERWISE SPECIFIED.

13. DIMENSIONS ARE TO SURFACE UNLESS OTHERWISE SPECIFIED.

14. DIMENSIONS ARE TO SURFACE UNLESS OTHERWISE SPECIFIED.

15. DIMENSIONS ARE TO SURFACE UNLESS OTHERWISE SPECIFIED.

16. DIMENSIONS ARE TO SURFACE UNLESS OTHERWISE SPECIFIED.

17. DIMENSIONS ARE TO SURFACE UNLESS OTHERWISE SPECIFIED.

18. DIMENSIONS ARE TO SURFACE UNLESS OTHERWISE SPECIFIED.

19. DIMENSIONS ARE TO SURFACE UNLESS OTHERWISE SPECIFIED.

20. DIMENSIONS ARE TO SURFACE UNLESS OTHERWISE SPECIFIED.

21. DIMENSIONS ARE TO SURFACE UNLESS OTHERWISE SPECIFIED.

22. DIMENSIONS ARE TO SURFACE UNLESS OTHERWISE SPECIFIED.

23. DIMENSIONS ARE TO SURFACE UNLESS OTHERWISE SPECIFIED.

24. DIMENSIONS ARE TO SURFACE UNLESS OTHERWISE SPECIFIED.

25. DIMENSIONS ARE TO SURFACE UNLESS OTHERWISE SPECIFIED.

26. DIMENSIONS ARE TO SURFACE UNLESS OTHERWISE SPECIFIED.

27. DIMENSIONS ARE TO SURFACE UNLESS OTHERWISE SPECIFIED.

28. DIMENSIONS ARE TO SURFACE UNLESS OTHERWISE SPECIFIED.

29. DIMENSIONS ARE TO SURFACE UNLESS OTHERWISE SPECIFIED.

30. DIMENSIONS ARE TO SURFACE UNLESS OTHERWISE SPECIFIED.

31. DIMENSIONS ARE TO SURFACE UNLESS OTHERWISE SPECIFIED.

32. DIMENSIONS ARE TO SURFACE UNLESS OTHERWISE SPECIFIED.

33. DIMENSIONS ARE TO SURFACE UNLESS OTHERWISE SPECIFIED.

34. DIMENSIONS ARE TO SURFACE UNLESS OTHERWISE SPECIFIED.

35. DIMENSIONS ARE TO SURFACE UNLESS OTHERWISE SPECIFIED.

36. DIMENSIONS ARE TO SURFACE UNLESS OTHERWISE SPECIFIED.

37. DIMENSIONS ARE TO SURFACE UNLESS OTHERWISE SPECIFIED.

38. DIMENSIONS ARE TO SURFACE UNLESS OTHERWISE SPECIFIED.

39. DIMENSIONS ARE TO SURFACE UNLESS OTHERWISE SPECIFIED.

40. DIMENSIONS ARE TO SURFACE UNLESS OTHERWISE SPECIFIED.

41. DIMENSIONS ARE TO SURFACE UNLESS OTHERWISE SPECIFIED.

42. DIMENSIONS ARE TO SURFACE UNLESS OTHERWISE SPECIFIED.

43. DIMENSIONS ARE TO SURFACE UNLESS OTHERWISE SPECIFIED.

44. DIMENSIONS ARE TO SURFACE UNLESS OTHERWISE SPECIFIED.

45. DIMENSIONS ARE TO SURFACE UNLESS OTHERWISE SPECIFIED.

46. DIMENSIONS ARE TO SURFACE UNLESS OTHERWISE SPECIFIED.

47. DIMENSIONS ARE TO SURFACE UNLESS OTHERWISE SPECIFIED.

48. DIMENSIONS ARE TO SURFACE UNLESS OTHERWISE SPECIFIED.

49. DIMENSIONS ARE TO SURFACE UNLESS OTHERWISE SPECIFIED.

50. DIMENSIONS ARE TO SURFACE UNLESS OTHERWISE SPECIFIED.

51. DIMENSIONS ARE TO SURFACE UNLESS OTHERWISE SPECIFIED.

52. DIMENSIONS ARE TO SURFACE UNLESS OTHERWISE SPECIFIED.

53. DIMENSIONS ARE TO SURFACE UNLESS OTHERWISE SPECIFIED.

54. DIMENSIONS ARE TO SURFACE UNLESS OTHERWISE SPECIFIED.

55. DIMENSIONS ARE TO SURFACE UNLESS OTHERWISE SPECIFIED.

56. DIMENSIONS ARE TO SURFACE UNLESS OTHERWISE SPECIFIED.

57. DIMENSIONS ARE TO SURFACE UNLESS OTHERWISE SPECIFIED.

58. DIMENSIONS ARE TO SURFACE UNLESS OTHERWISE SPECIFIED.

59. DIMENSIONS ARE TO SURFACE UNLESS OTHERWISE SPECIFIED.

60. DIMENSIONS ARE TO SURFACE UNLESS OTHERWISE SPECIFIED.

61. DIMENSIONS ARE TO SURFACE UNLESS OTHERWISE SPECIFIED.

62. DIMENSIONS ARE TO SURFACE UNLESS OTHERWISE SPECIFIED.

63. DIMENSIONS ARE TO SURFACE UNLESS OTHERWISE SPECIFIED.

64. DIMENSIONS ARE TO SURFACE UNLESS OTHERWISE SPECIFIED.

65. DIMENSIONS ARE TO SURFACE UNLESS OTHERWISE SPECIFIED.

66. DIMENSIONS ARE TO SURFACE UNLESS OTHERWISE SPECIFIED.

67. DIMENSIONS ARE TO SURFACE UNLESS OTHERWISE SPECIFIED.

68. DIMENSIONS ARE TO SURFACE UNLESS OTHERWISE SPECIFIED.

69. DIMENSIONS ARE TO SURFACE UNLESS OTHERWISE SPECIFIED.

70. DIMENSIONS ARE TO SURFACE UNLESS OTHERWISE SPECIFIED.

71. DIMENSIONS ARE TO SURFACE UNLESS OTHERWISE SPECIFIED.

72. DIMENSIONS ARE TO SURFACE UNLESS OTHERWISE SPECIFIED.

73. DIMENSIONS ARE TO SURFACE UNLESS OTHERWISE SPECIFIED.

74. DIMENSIONS ARE TO SURFACE UNLESS OTHERWISE SPECIFIED.

75. DIMENSIONS ARE TO SURFACE UNLESS OTHERWISE SPECIFIED.

76. DIMENSIONS ARE TO SURFACE UNLESS OTHERWISE SPECIFIED.

77. DIMENSIONS ARE TO SURFACE UNLESS OTHERWISE SPECIFIED.

78. DIMENSIONS ARE TO SURFACE UNLESS OTHERWISE SPECIFIED.

79. DIMENSIONS ARE TO SURFACE UNLESS OTHERWISE SPECIFIED.

80. DIMENSIONS ARE TO SURFACE UNLESS OTHERWISE SPECIFIED.

81. DIMENSIONS ARE TO SURFACE UNLESS OTHERWISE SPECIFIED.

82. DIMENSIONS ARE TO SURFACE UNLESS OTHERWISE SPECIFIED.

83. DIMENSIONS ARE TO SURFACE UNLESS OTHERWISE SPECIFIED.

84. DIMENSIONS ARE TO SURFACE UNLESS OTHERWISE SPECIFIED.

85. DIMENSIONS ARE TO SURFACE UNLESS OTHERWISE SPECIFIED.

86. DIMENSIONS ARE TO SURFACE UNLESS OTHERWISE SPECIFIED.

87. DIMENSIONS ARE TO SURFACE UNLESS OTHERWISE SPECIFIED.

88. DIMENSIONS ARE TO SURFACE UNLESS OTHERWISE SPECIFIED.

89. DIMENSIONS ARE TO SURFACE UNLESS OTHERWISE SPECIFIED.

90. DIMENSIONS ARE TO SURFACE UNLESS OTHERWISE SPECIFIED.

91. DIMENSIONS ARE TO SURFACE UNLESS OTHERWISE SPECIFIED.

92. DIMENSIONS ARE TO SURFACE UNLESS OTHERWISE SPECIFIED.

93. DIMENSIONS ARE TO SURFACE UNLESS OTHERWISE SPECIFIED.

94. DIMENSIONS ARE TO SURFACE UNLESS OTHERWISE SPECIFIED.

95. DIMENSIONS ARE TO SURFACE UNLESS OTHERWISE SPECIFIED.

96. DIMENSIONS ARE TO SURFACE UNLESS OTHERWISE SPECIFIED.

97. DIMENSIONS ARE TO SURFACE UNLESS OTHERWISE SPECIFIED.

98. DIMENSIONS ARE TO SURFACE UNLESS OTHERWISE SPECIFIED.

99. DIMENSIONS ARE TO SURFACE UNLESS OTHERWISE SPECIFIED.

100. DIMENSIONS ARE TO SURFACE UNLESS OTHERWISE SPECIFIED.

CONTRACT NO.	CONTRACT NO.	CONTRACT NO.	CONTRACT NO.	CONTRACT NO.	CONTRACT NO.
ROSEMOUNT MEASUREMENT	ROSEMOUNT MEASUREMENT	ROSEMOUNT MEASUREMENT	ROSEMOUNT MEASUREMENT	ROSEMOUNT MEASUREMENT	ROSEMOUNT MEASUREMENT
FISHER-ROSEMOUNT	FISHER-ROSEMOUNT	FISHER-ROSEMOUNT	FISHER-ROSEMOUNT	FISHER-ROSEMOUNT	FISHER-ROSEMOUNT
DRW. NO. 644-244E	DRW. NO. 644-244E	DRW. NO. 644-244E	DRW. NO. 644-244E	DRW. NO. 644-244E	DRW. NO. 644-244E
FACTORY MUTUAL (FM) EXPL.	FACTORY MUTUAL (FM) EXPL.	FACTORY MUTUAL (FM) EXPL.	FACTORY MUTUAL (FM) EXPL.	FACTORY MUTUAL (FM) EXPL.	FACTORY MUTUAL (FM) EXPL.
SCALE N/A	SCALE N/A	SCALE N/A	SCALE N/A	SCALE N/A	SCALE N/A
SHEET 1 OF 1	SHEET 1 OF 1	SHEET 1 OF 1	SHEET 1 OF 1	SHEET 1 OF 1	SHEET 1 OF 1

Models 644 and 244E Temperature Transmitters Manual Supplement

Old Transmitter	page C-2
New Transmitter	page C-3
Specifications	page C-4

This manual supplement is intended to indicate the primary differences between the old and new Models 644 and 244E. These differences are as follows:

- Transmitter design
- Sensor Wiring Diagrams
- Special Mounting Considerations
- Specifications

OLD TRANSMITTER

Transmitter Design

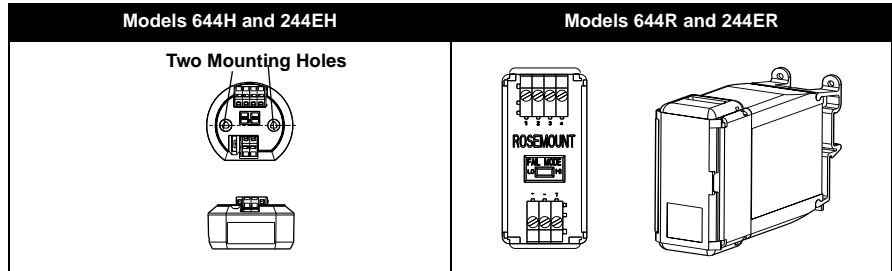

Sensor Wiring Diagrams

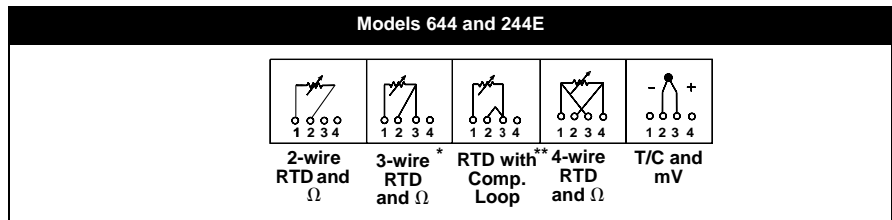

* Rosemount Inc. provides 4-wire sensors for all single element RTDs. You can use these RTDs in 3-wire configurations by leaving the unneeded leads disconnected and insulated with electrical tape.

** The transmitters must be configured for a 3-wire RTD in order to recognize an RTD with a compensation loop.

Special Mounting Considerations

Mounting a Model 644H to a DIN Rail	G-Rail	Top Hat Rail
<ol style="list-style-type: none"> Assemble the appropriate rail clip (part number 00644-5301-0001). Attach the transmitter to a rail or panel. Attach the thermowell to the pipe or process container wall and attach sufficient lengths of sensor lead wire. Tighten the connection head cover. Run the sensor lead wires from the sensor and set the transmitter failure mode switch. Attach the sensor and power leads to the transmitter. 		
<p>Use with an Existing Threaded Sensor Connection Head</p> <p>To mount the Models 644H and 244EH in an existing L1 connection head, assemble the Model 644H retrofit kit (part number 00644-5321-0001) to the transmitter as shown. Then mount the assembly in the connection head.</p>		
<p>Kit includes replacement bracket and screw</p>		

644-5301B01B, D01B
644-644-505TA01A

NEW TRANSMITTER

Transmitter Design

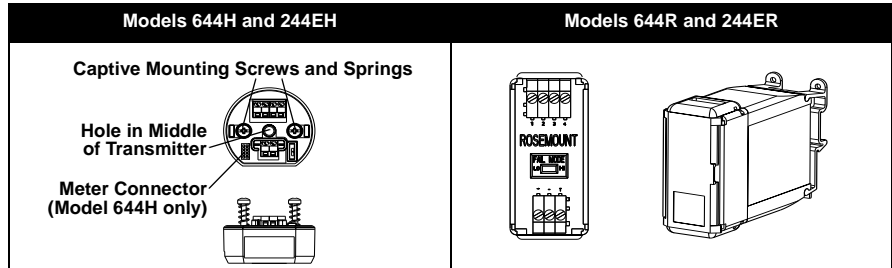

644, 244-1360A02B

Sensor Wiring Diagrams

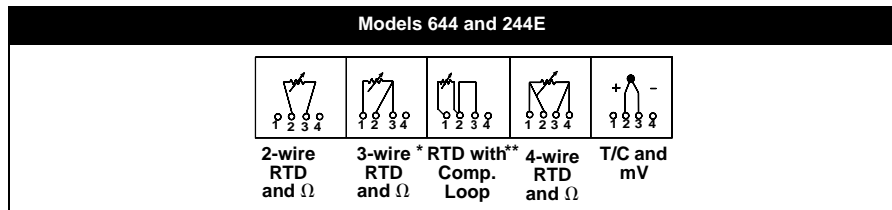

644-0000B01C

* Rosemount Inc. provides 4-wire sensors for all single element RTDs. You can use these RTDs in 3-wire configurations by leaving the unneeded leads disconnected and insulated with electrical tape.

** The transmitters must be configured for a 3-wire RTD in order to recognize an RTD with a compensation loop.

Special Mounting Considerations

Use with an Existing DIN Plate Style Sensor	
<ol style="list-style-type: none"> Secure the bottom of the mounting screw sleeve with pliers. Remove the mounting screws and springs. Once the springs are removed, use the new transmitter mounting screws to assembly the transmitter to the DIN plate and connection head. (Optional snap rings (part number 00644-4432-0001) are available to ease installation to the existing DIN plate style sensor.) 	
Use with an Existing Threaded Sensor Connection Head	
<p>To mount the new Models 644H or 244EH to the existing threaded sensor connection head (former option code L1), order the models 644H and 244EH retrofit kit (part number 00644-5321-0010). The fit includes a new mounting bracket and all associated hardware necessary to facilitate the installation of the Models 644H and 244EH into the existing head.</p>	

SENSORS-0000A02B

644-644-5321A01A

HART Communicator (Model 644H only)

To guarantee proper transmitter functionality and communication, your Model 275 HART Communicator should contain device revision Dev v5 DD v2 or higher. To check software device revision,

- Turn on the communicator.
- Select *1 Off-line, 1 New Configuration, Rosemount, 644 Temp*

If you do not have this device revision, contact your local Rosemount representative for information on receiving an upgrade.

Rosemount Models 244EH and 244ER PC-Programmable Temperature Transmitters

SPECIFICATIONS

		Old			New		
BASEFFA⁽¹⁾ Intrinsically Safe Installation Entity Parameters:							
Power Loop	$U_{\max:\text{in}}$	30 V dc			30 V dc		
	$I_{\max:\text{in}}$	200 mA			200 mA		
Group II C Zones 0 and 1	$W_{\max:\text{in}}$	1.0 W			1.0 W	0.67 W	
		<ul style="list-style-type: none"> T5 ($-40 \leq T_a \leq 40^\circ\text{C}$) T4 ($-40 \leq T_a \leq 80^\circ\text{C}$) 			<ul style="list-style-type: none"> T5 ($-60 \leq T_a \leq 40^\circ\text{C}$) T4 ($-60 \leq T_a \leq 80^\circ\text{C}$) 	<ul style="list-style-type: none"> T6 ($-60 \leq T_a \leq 40^\circ\text{C}$) T5 ($-60 \leq T_a \leq 50^\circ\text{C}$) 	
Sensor	C_{eq}	13.4 nF			10 nF		
	L_i	0 μH			0 μH		
	U_o	24.2 V dc			13.6 V dc		
	I_o	33 mA			80 mA		
	P_o	0.2 W			0.08 W		
Cable Load		IIC	IIB	IIA	IIC	IIB	IIA
	C_o (μF)	0.2	0.6	1.6	0.7	5.1	18.5
	L_o (mH)	31	93	248	5	23	48
<i>Special Conditions for Safe Use: The apparatus must be installed such that its external terminals and the communication pins are protected to at least IP20.</i>				<i>Special Conditions for Safe Use: The apparatus must be installed in an enclosure which affords it a degree of protection of at least IP20. Non-metallic enclosures must have a surface resistance of less than 1 $\text{G}\Omega$, light alloy or zirconium enclosures must be protected from impact and friction when installed.</i>			
CSA⁽²⁾ Intrinsically Safe Installation Connection Parameters:							
Class I Div. 1 Groups A, B, C, and D	T5 ($-50 \leq T_a \leq 60^\circ\text{C}$)	<ul style="list-style-type: none"> 30 V or less, 330 ohms or more 28 V or less, 300 ohms or more 25 V or less, 200 ohms or more 22 V or less, 180 ohms or more 			T6 ($-50 \leq T_a \leq 40^\circ\text{C}$)	<ul style="list-style-type: none"> 30 V or less, 340 ohms or more 28 V or less, 300 ohms or more 25 V or less, 240 ohms or more 22 V or less, 190 ohms or more 	
		T4 ($-50 \leq T_a \leq 80^\circ\text{C}$)	<ul style="list-style-type: none"> 30 V or less, 330 ohms or more 28 V or less, 250 ohms or more 25 V or less, 240 ohms or more 22 V or less, 190 ohms or more 		<ul style="list-style-type: none"> 30 V or less, 330 ohms or more 28 V or less, 250 ohms or more 25 V or less, 240 ohms or more 22 V or less, 190 ohms or more 		
Class I Div. 1 Groups C and D		<ul style="list-style-type: none"> 30 V or less, 150 ohms or more 			T4 ($-50 \leq T_a \leq 80^\circ\text{C}$)	<ul style="list-style-type: none"> 30 V or less, 230 ohms or more 28 V or less, 200 ohms or more 25 V or less, 160 ohms or more 	
Factory Mutual⁽³⁾ Intrinsically Safe Installation Entity Parameters:							
Power Loop	V_i	30 V dc			30 V dc		
	I_i	250 mA			240 mA		
Class I, II, and III Div. 1 Groups A, B, C, D, E, F, and G	P_i	1.0 W			1.0 W	0.67 W	
		<ul style="list-style-type: none"> T5 ($-50 \leq T_a \leq 60^\circ\text{C}$) 			<ul style="list-style-type: none"> T5 ($-50 \leq T_a \leq 40^\circ\text{C}$) T4 ($-50 \leq T_a \leq 80^\circ\text{C}$) 	<ul style="list-style-type: none"> T6 ($-50 \leq T_a \leq 40^\circ\text{C}$) T5 ($-50 \leq T_a \leq 50^\circ\text{C}$) 	
Sensor	C_i	0.008 μF			0.010 μF		
	L_i	0 μH			0 μH		
	V_t	10.7 V dc			13.6 V dc		
	I_t	15.3 mA			22 mA		
	P_o	0.04 W			0.11 W		
	C_a	2.23 μF			0.8 μF		
	L_a	140 mH			60.0 mH		

(1) For more information see approval certificate, Old: Model 644H: 95C2010X, Model 244E: 95C2019X; New: Model 644H: BAS00ATEX1033X, Model 244E: BAS00ATEX1034X

(2) For more information see Rosemount drawing 00644-1040, Rev. B (old) and 00644-1064, Rev AB (new).

(3) For more information see Rosemount drawing 00644-1056, Rev. B (old) and 00644-0009, Rev AA (new)

Index

A

- Alarm
 - see* Failure mode
- Ambient TemperatureA-4
- ApprovalsB-1

C

- Changing Switch Positions . . . 2-16
- Configuration 3-2
 - 244EC Interface
 - Ambient temperature . . .A-5
 - Humidity limitsA-5
 - CustomA-8
 - Process variable 3-5
 - Single Transmitter 3-3
 - StandardA-8
 - Transmitters identically . . . 3-4
- Configuration Interface 2-11
- Considerations 1-3
 - Electrical 1-3
 - Environmental 1-3
 - General 1-3
 - Mechanical 1-3

D

- Dimensional DrawingsA-9
 - Configuration interface . . .A-9
 - EnclosureA-9
 - TransmitterA-9

E

- Electrical considerations 1-3
 - Electrical connectionsA-5
 - Surges and transients 3-1
- Enclosure RatingsA-5
- Environmental considerations . . 1-3

F

- Failure Mode 2-16, A-2
 - Change switch position . . . 2-16
 - Switch 2-16
- Failure mode 2-12
- Field Wiring 2-12
 - Diagrams 2-13
 - Sensor connections 2-13

G

- General considerations 1-3
- Grounding 3-2

H

- Humidity
 - 244EC, limits forA-5
 - TransmittersA-2

I

- Inputs
 - RTD or Ohm 2-13
 - Thermocouple or Millivolt . . 2-15
- Installation 2-1
 - Existing threaded sensor . . . 2-4
 - Flowchart 2-2
 - Head mount transmitters . . . 2-6
 - DIN plate style sensor . . . 2-5
 - Threaded Sensor 2-6
 - Mounting to a DIN rail 2-4
- Procedures 2-5
 - Configuration software . . . 2-9
 - Interface 2-11
 - Multichannel 2-9
 - Transmitter 2-5
- Rail clip hardware 2-4
- Rail mount transmitters . . . 2-8
 - Integral mount sensor . . . 2-7
 - Threaded sensor 2-8
- Tools 2-2
- Installation Drawings B-4
- Intermittent Sensor Algorithm . . 3-5
 - Advanced feature 3-8
 - Case Examples 3-6
 - Damping 3-7
 - Implementation 3-9
- Introduction 1-1

L

- Locations Certifications B-2

M

- Maintenance 4-1
- Manual Overview 1-2
- Manual Supplement C-1
- Mechanical considerations 1-3
- Mounting 2-3
 - Special 2-4
- Mounting Considerations
 - Existing threaded sensor . . . 2-4
 - Mounting to a DIN rail 2-4

O

- Operation 3-1

Ordering

- Information A-6
- Ordering Information
 - Accessories A-7
 - Configuration Interface A-7
 - Table A-6

P

- Power Supply 3-1, A-1
 - Grounding 3-2
 - Surges 3-1
 - Transients 3-1
- Process variable
 - Viewing 3-5

S

- Sensor Connections 2-13
 - Diagram 2-15
 - RTD or Ohm 2-13
 - Thermocouple or Millivolt . . 2-15
- Sensor Terminals 2-16
- Software
 - Installation 2-10
 - Requirements 2-9
 - Screen conventions 2-11
 - Troubleshooting 4-1
- Specifications
 - Configuration interface A-5
 - Transmitter A-1
 - Functional A-1
 - Performance A-2
 - Physical A-5
- Stability A-2
- Surges
 - see* Electrical considerations

T

- Tagging A-8
- Temperature
 - Rise vs. extension length . . . 2-3
- Transients
 - see* Electrical considerations
- Troubleshooting 4-1
 - Software 4-1

U

- Using This Manual 1-1

W

- Weight A-5

Rosemount Model 3244MV MultiVariable Temperature Transmitter with Profibus-PA

Wiring

diagrams	2-13
Sensors diagram	2-15
terminal	2-16

Rosemount Inc.

8200 Market Boulevard
Chanhassen, MN 55317
USA
Tel 1-800-999-9307
Fax (952) 949-7001

Fisher-Rosemount Limited

Heath Place
Bognor Regis
West Sussex PO22 9SH
England
Tel 44 (1243) 863 121
Fax 44 (1243) 867 5541

Fisher-Rosemount

Singapore Pte Ltd.
1 Pandan Crescent
Singapore 128461
Tel (65) 777-8211
Fax 65 777-0947
AP.RMT-Specialist@frco.com

© Rosemount Inc., 2000



00809-0100-4737 Rev EA 10/00

Product documentation available at...
www.rosemount.com

ROSEMOUNT®
FISHER-ROSEMOUNT™

Free Manuals Download Website

<http://myh66.com>

<http://usermanuals.us>

<http://www.somanuals.com>

<http://www.4manuals.cc>

<http://www.manual-lib.com>

<http://www.404manual.com>

<http://www.luxmanual.com>

<http://aubethermostatmanual.com>

Golf course search by state

<http://golfingnear.com>

Email search by domain

<http://emailbydomain.com>

Auto manuals search

<http://auto.somanuals.com>

TV manuals search

<http://tv.somanuals.com>