

JOHN FLUKE MFG. CO., INC.

P. O. Box 7428
Seattle, Washington 98133

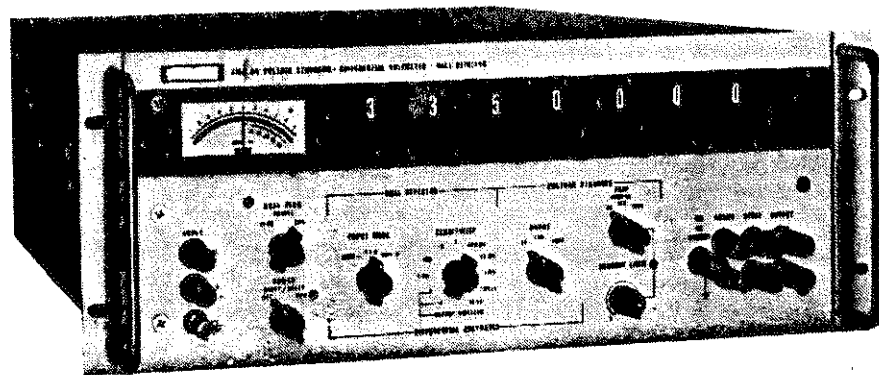

MODEL
335D
VOLTAGE STANDARD
DIFFERENTIAL VOLTMETER
NULL DETECTOR
Serial No. 812 and on

MAY 1972

CHANGE/ERRATA INFORMATION

MANUAL — [TITLE: 335D
ISSUE: MAY 1972

Please make changes in this manual according to the following change and/or errata information:

WARNING



DANGER: HIGH VOLTAGE!

The output terminals will be at the potential indicated by the readout dials whenever the POWER switch is in the OPR position, and when unit is used in the differential voltmeter mode.

Table of Contents

| SECTION | TITLE | PAGE |
|----------|---|------------|
| 1 | INTRODUCTION AND SPECIFICATIONS | 1-1 |
| 1-1. | Introduction | 1-1 |
| 1-6. | Specifications | 1-1 |
| 1-7. | Voltage Standard | 1-1 |
| 1-8. | Differential Voltmeter | 1-2 |
| 1-9. | Conventional Voltmeter | 1-2 |
| 1-10. | General | 1-4 |
| 2 | OPERATING INSTRUCTIONS | 2-1 |
| 2-1. | Introduction | 2-1 |
| 2-4. | Controls, Terminals, and Indicators | 2-1 |
| 2-6. | Input Power | 2-1 |
| 2-8. | Preliminary Operation | 2-1 |
| 2-9. | General | 2-1 |
| 2-11. | Trip Setting | 2-1 |
| 2-13. | Current Limit Setting | 2-4 |
| 2-15. | VM AC Common Connections | 2-4 |
| 2-17. | Sense Connections | 2-4 |
| 2-20. | Guard Connection | 2-5 |
| 2-22. | Operation as a Voltage Standard | 2-5 |
| 2-24. | Operation as a High Impedance Voltmeter or Null Detector | 2-7 |
| 2-26. | Operation as a Differential Voltmeter | 2-7 |
| 2-28. | Operation with a Recorder | 2-8 |
| 3 | THEORY OF OPERATION | 3-1 |
| 3-1 | Introduction | 3-1 |
| 3-3 | Voltage Standard Function | 3-1 |
| 3-40 | Voltmeter Function | 3-7 |

(continued on page ii)

TABLE OF CONTENTS, *continued*

| SECTION | TITLE | PAGE |
|---------|-------------------------------|------|
| 4 | MAINTENANCE | 4-1 |
| 4-1 | Introduction | 4-1 |
| 4-3 | Service Information | 4-1 |
| 4-6 | General Maintenance | 4-1 |
| 4-21 | Performance Tests | 4-6 |
| 4-46 | Calibration | 4-13 |
| 4-66 | Troubleshooting | 4-20 |

Section 1

Introduction & Specifications

1-1. INTRODUCTION

1-2. The Model 335D Voltage Standard combines a dc voltage source and a dc voltage measurement capability in one instrument. Precision dc voltages up to 1100 volts, variable by way of the front panel readout dials, are provided at the OUTPUT terminals of the instrument. Measurement capabilities from 10 microvolts to 1000 volts are provided by a precision dc differential voltmeter. This combination allows flexible use of the instrument as a voltage standard, a differential voltmeter, or as a null detector.

1-3. Protection against possible equipment failures or operator errors, which might otherwise damage expensive instruments, is incorporated. The VOLTAGE TRIP and VERNIER controls provide a means of limiting the output voltage within the range. Should the output voltage exceed a preset limit, the OUTPUT terminals are de-energized. A current limiting circuit limits the available current to a level determined by the setting of the CURRENT LIMIT control. Therefore, it is able to provide currents up to, but not exceeding the level determined by the setting of the CURRENT LIMIT control.

1-4. The inner chassis and circuitry are surrounded by an isolation guard which is also isolated from the front panel and the outside cover. When properly connected, the guard bypasses any circulating ground currents which otherwise may cause error. Remote sensing of the output voltage is also used with the instrument to reduce errors caused by voltage drop in external cables.

1-5. Most of the instrument circuitry is mounted on modular plug-in cards. An extender card is provided as an accessory to aid in the maintenance and adjustment of the instrument.

1-6. SPECIFICATIONS

1-7. Voltage Standard

OUTPUT VOLTAGE: 0 to 1111.1110 VDC
 OUTPUT CURRENT: 0 to 50 milliamperes
 VOLTAGE RANGES: 10, 100, and 1000V with outputs as follows:

0 to 11.111110 (1 uV steps)

0 to 111.11110 (10uV steps)

0 to 1111.1110 (100 uV steps)

RESOLUTION: 0.1 ppm of range (1 uV maximum).

ACCURACY OF OUTPUT: (For 60 Days)

10V range - $\pm(0.001\%$ of setting +10 uV)

100V range - $\pm(0.001\%$ of setting +0.00002% of range)

1000V range - $\pm(0.0015\%$ of setting +0.00002% of range)

NOTE: The above accuracies are absolute, relative to NBS standards, and include effects of stability, line regulation, load regulation, and calibration uncertainties under standard reference conditions of 23°C \pm 1°C and up to 70% relative humidity.

TEMPERATURE COEFFICIENT OF OUTPUT:
Less than $\pm(0.0002\%$ of setting $+1 \mu\text{V})/^\circ\text{C}$ from 0°C to 50°C .

STABILITY OF OUTPUT: (At standard reference conditions described under **ACCURACY OF OUTPUT**).

10V range

$\pm(5\text{ppm of setting } +7\mu\text{V})$ per month

100V and 1000V ranges

$\pm(5 \text{ ppm of setting } +30\mu\text{V})$ per month

OVERCURRENT PROTECTION: Automatic current limiting continuously adjustable from 1 to 60 ma with front panel control and indicator. Normal operation restored upon removal of overload.

OVERVOLTAGE PROTECTION: Automatically disconnects load if output voltage exceeds 1 to 1200V setting of front panel controls. Manual reset.

RIPPLE AND NOISE (all frequencies):

10V range - less than 20 $\mu\text{V rms}$

100V range - less than 30 $\mu\text{V rms}$

1000 range - less than 40 $\mu\text{V rms}$

SETTLING TIME: Typically, within 10 ppm of final output, less than 20 seconds after a range change.

OUTPUT RESISTANCE:

Less than 0.0005 ohms or $(0.0001E_0)$ ohms at dc.

REGULATION: 0.0002% of setting or 10 μV for either a 10% line voltage change or a full load change.

COMMON MODE REJECTION: Better than 125 db from dc to 400 Hz, up to 700V rms or 1000 VDC.

ISOLATION: Either output terminal may be floated up to 1000 VDC from chassis ground.

REMOTE SENSING: Separate terminals are provided to sense the output voltage directly at the load, reducing errors caused by voltage drop in connecting wires between the output and the load.

1-8. Differential Voltmeter

ABSOLUTE ACCURACY: Same as output
TEMP. COEF. OF ACCURACY: characteristics
INPUT RANGES: under
STABILITY: Voltage Standard.

NULL SENSITIVITIES: 1000V to 10 μV (full-scale) in 9 decade ranges. Any null sensitivity may be used on any voltage range.

INPUT RESISTANCE:

Infinite at null from 0 to 1111.1110 VDC.

METER AND DIAL RESOLUTION: 0.1 ppm of range.

1-9. Conventional Voltmeter

ACCURACY: $\pm 3\%$ of range

RANGES: Voltage Range Input Resistance:

| | |
|-------------------|-------------|
| 1000-0-1000 | 100 Megohms |
| 100-0-100 | 100 Megohms |
| 10-0-10 | 100 Megohms |
| 1-0-1 | 100 Megohms |
| 0.1-0-0.1 | 10 Megohms |
| 0.01-0-0.01 | 10 Megohms |
| 0.001-0-0.001 | 1 Megohm |
| 0.0001-0-0.0001 | 1 Megohm |
| 0.00001-0-0.00001 | 1 Megohm |

1-10. General

DESIGN: Solid-state throughout (no tubes).

STABILITY OF METER ZERO:

On most sensitive range (10 μV full-scale):
0.5 μV peak-to-peak noise.

0.5 μV peak-to-peak stability for 10% line voltage variation.

RECORDER/ISOLATION AMPLIFIER OUTPUT:

Adjustable from 0 to over 1.0V for end-scale meter deflection; source resistance 5 to 8 kilohms; linearity better than $\pm 0.5\%$ of end-scale. Gain as an isolation amplifier is 1.0V/null range sensitivity. Recorder output may be grounded or floating up to 100 VDC.

TEMPERATURE: 0°C to +50°C, operating; -40°C to +65°C, non-operating.

HUMIDITY: 0 to 70% relative humidity.

SHOCK AND VIBRATION: Meets all requirements of MIL-T-945A, rigidly mounted or rack-mounted with slides.

ALTITUDE: 10,000 ft. operating; 50,000 ft. non-operating.

FUNGUS NUTRIENTS; MERCURIC COMPONENTS: None.

FUSES: One power-line fuse; one high-voltage fuse.

INPUT POWER: 115/230 VAC $\pm 10\%$, 50-60 Hz, single phase, approximately 130 VA fully loaded.

MOUNTING: Standard EIA relay rack (tapped for attachment of slides); resilient feet for bench use.

SIZE: 7" high by 19" wide by 18" behind panel.

WEIGHT: Approximately 50 lbs.

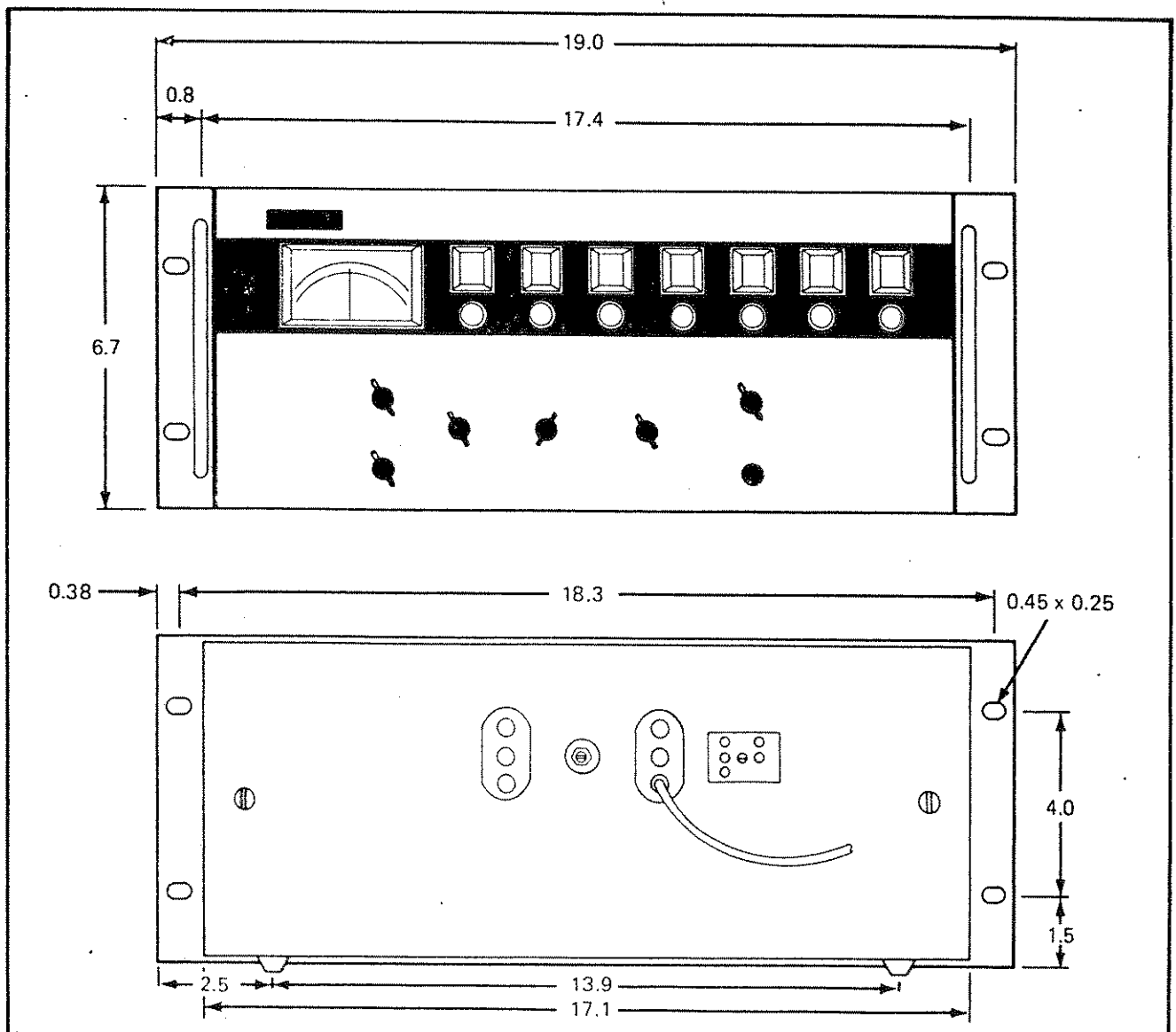

Figure 1-1. OUTLINE DRAWING(Sheet 1 of 2)

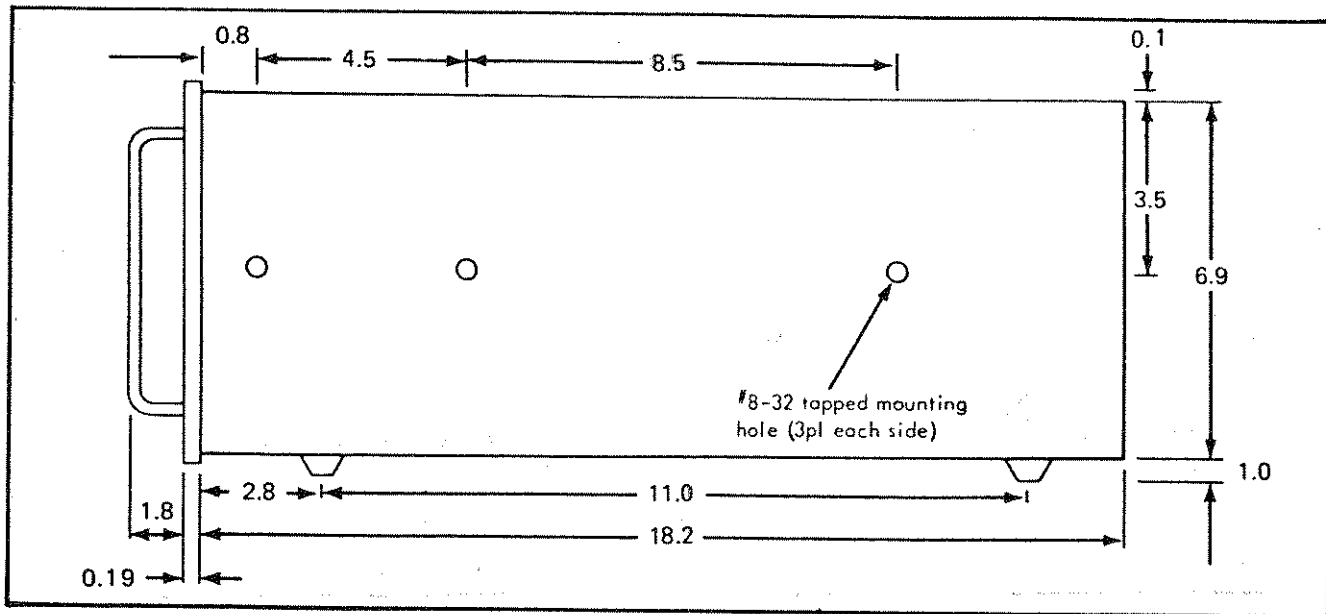

Figure 1-1. OUTLINE DRAWING(Sheet 2 of 2)

Section 2

Operating Instructions

2-1. INTRODUCTION

2-2. This section consists of information about operating and applying the instrument. Prior to initial instrument operation, you may become familiar with the functions of the instrument controls by reading the information contained in paragraph 2-4, "CONTROLS, TERMINALS, AND INDICATORS". Prior to instrument application, a few optional control adjustments and terminal connections, that enhance the instruments performance and safety to external equipment, should be considered. Paragraph 2-8, "PRELIMINARY OPERATION", describes these adjustments and connections. Instructions for operating and applying the Model 335D as either a voltage standard, high impedance voltmeter or null detector, or differential voltmeter are described in paragraphs 2-22, 2-24, and 2-26, respectively.

2-3. If any problem is encountered in operation of the instrument, contact your nearest John Fluke Sales Representative or write directly to the John Fluke Manufacturing Company with a statement of the problem. Please include the serial number of the instrument in such correspondence.

2-4. CONTROLS, TERMINALS AND INDICATORS

2-5. The name and function of the front and rear panel controls, terminals, and indicators are illustrated and described in Figure 2-1. The numbers at the tails of the arrow callouts correspond to the reference numbers

in the chart immediately following the photographs.

2-6. INPUT POWER

2-7. The power transformer of the instrument has dual primary windings. Normally, these primary windings are connected in parallel for 115 volt operation. Upon request, the primary windings are connected in series at the factory for 230 volt operation. Should it become desirable to convert the instrument from one type of power line operation to the other, refer to section 4-19.

2-8. PRELIMINARY OPERATION

2-9. General

2-10. Before operating the instrument as a voltage source or voltmeter, some preliminary settings and connections should be considered. Whether to use these settings and connections, or not, depends upon the degree of equipment safety and accuracy required. The following five paragraphs discuss the merits and procedures for each of the settings and connections.

2-11. Trip Setting

2-12. The TRIP switch and VERNIER control provide protection to external equipment by limiting the maximum allowable output voltage to the external load. The range of voltage limiting is selected with the TRIP switch. Refinement of the value of the voltage to be limited is accomplished with the VERNIER control. If

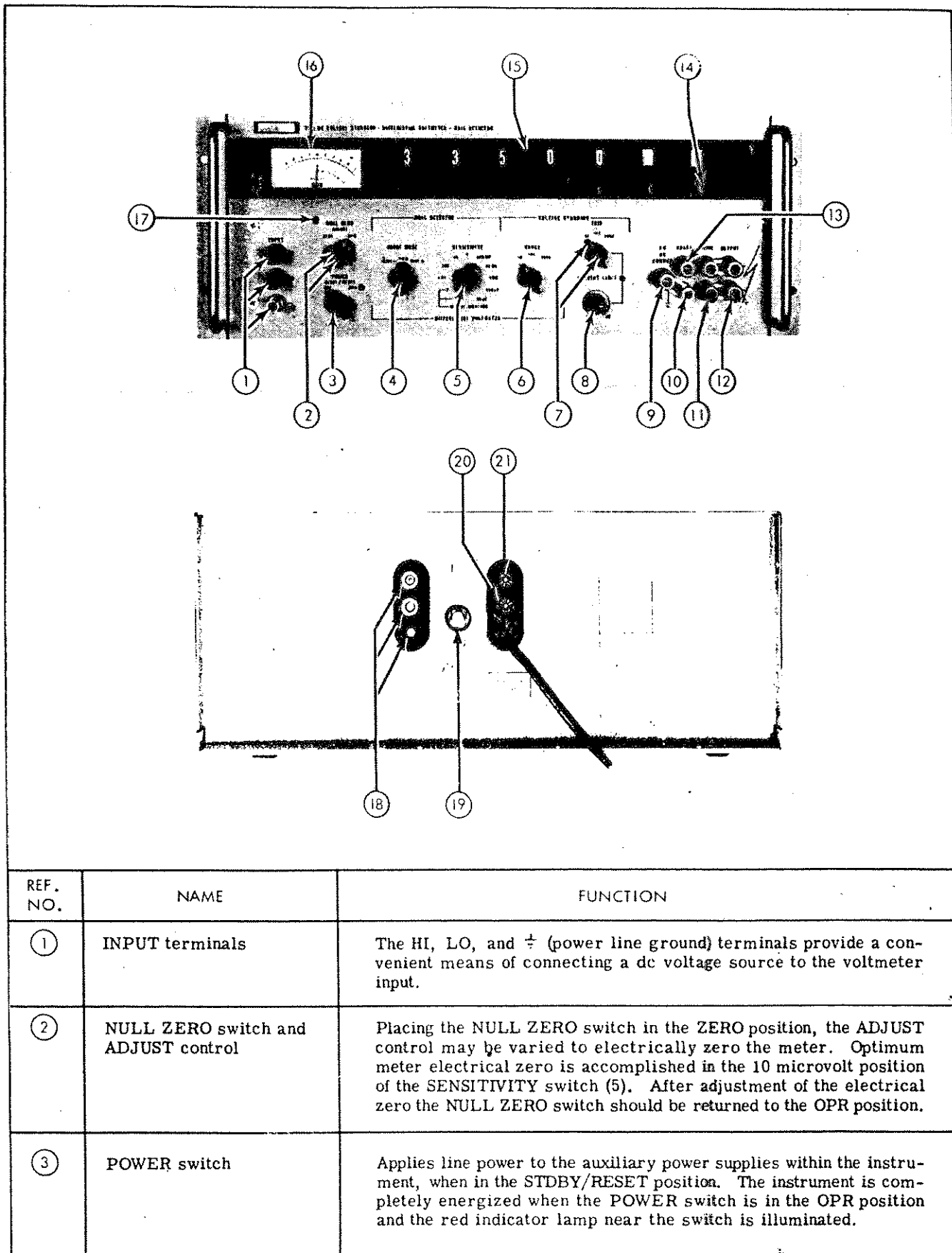

Figure 2-1 CONTROLS, TERMINALS, AND INDICATORS (Sheet 1 of 3)

| REF. NO. | NAME | FUNCTION |
|----------|---------------------------------|--|
| ④ | INPUT MODE switch | Allows selection of either Differential Voltmeter operation, in DIFF- or DIFF+, or Null Detector operation, in TVM (Transistor VoltMeter). |
| ⑤ | SENSITIVITY switch | Provides selection of 10 microvolts through 1 kilovolt full scale input ranges for Null Detector operation. Also, selects 10 microvolts through 1 kilovolt null sensitivity ranges for Differential Voltmeter operation. The "I" and "V" positions allow monitoring of the current and voltage output of the Voltage Standard portion of the instrument. |
| ⑥ | RANGE switch | Allows selection of one of three ranges (10, 100 and 1000 volts) for use in either Voltage Standard or Differential Voltmeter operation of the instrument. |
| ⑦ | TRIP switch and VERNIER control | The TRIP switch provides a means of limiting the output voltage in three ranges (10, 100, and 1000 volts) independent of the RANGE switch. The VERNIER control varies the amount of limiting within the ranges of the TRIP switch. When an over-voltage condition exists, the red indicator lamp near the TRIP switch will illuminate and the red lamp near the POWER switch will be extinguished. |
| ⑧ | CURRENT LIMIT control | Provides a means of setting a limit on the magnitude of the output current within a range to 0 to 60 milliamperes. An over-current condition is signified when the indicator lamp, near the CURRENT LIMIT control, illuminates. |
| ⑨ | VM AC COMMON terminal | Provides optimum common mode rejection when connected to the GUARD terminal (13) for Voltage Standard operation. Provides minimum common mode voltage at the INPUT terminals (1), when connected to the \div terminal (10) for voltmeter operation. |
| ⑩ | | Power line ground. |
| ⑪ | SENSE terminals | Allows the regulating circuitry within the Model 335D to be connected directly to the OUTPUT terminals (12) or to the load for optimum regulation. |
| ⑫ | OUTPUT terminals | Provides a convenient means of connecting the load to the output of the Model 335D. |
| ⑬ | GUARD terminal | Provides a means of eliminating circulating ground currents through the load, when properly connected. |
| ⑭ | Readout Dials | Used to select the desired output voltage from the Voltage Standard portion of the instrument. Also, indicates the value of an unknown voltage when used in conjunction with the Differential Voltmeter portion of the instrument. When a dial is set to "X"(10), it represents 0 with a 1 carry-over to the digit to the immediate left. For example: 10 . X X X X X X represents 11.11110 volts. |
| ⑮ | Decimal Lamps | These lamps indicate the proper decimal point setting when illuminated and are controlled by the RANGE switch. |
| ⑯ | Meter | Indicates the full value of a voltage applied to the INPUT terminals (1) when the INPUT MODE switch (4) is in the TVM position. When the INPUT MODE switch is in the DIFF+ or DIFF- positions, the meter indicates the difference between an unknown voltage at the INPUT terminals and the voltage indicated on the Readout Dials. The meter provides an indication of the output voltage when |

Figure 2-1. CONTROLS, TERMINALS, AND INDICATORS (Sheet 2 of 3)

| REF. NO. | NAME | FUNCTION |
|-----------------|--------------------------------|---|
| (16) (con't) | Meter | the SENSITIVITY (5) switch is in the "V" position. An indication of the output current may be determined from the red meter scale when the SENSITIVITY switch is in the "I" position. |
| (17) | Mechanical Zero adjust | Provides a means of setting the meter mechanical zero. Adjustment should be made after the instrument has been completely de-energized for at least 3 minutes. |
| (18) | RECORDER OUTPUT terminals | Terminals provided for the connection of a recording instrument. The (black) terminal is connected to power line ground. |
| (19) | RECORDER OUTPUT ADJUST control | Allows adjustment of the Model 335A/335D recorder output level from 0 to 1 volt, for an end scale deflection of the front-panel meter. |
| (20) | Fuse, line | A 3 ampere slow-blow fuse for 115 volt power line operation. Use a 1-1/2 ampere slow-blow fuse for instruments converted to 230 volt power line operation. |
| (21) | Fuse, high voltage | A 1/4 ampere slow-blow fuse electrically located at the output of the high voltage rectifier circuit. |

Figure 2-1. CONTROLS, TERMINALS, AND INDICATORS (Sheet 3 of 3)

no degree of limiting is required within the ranges of the instrument, set the TRIP switch to 1000 and the VERNIER fully clockwise. Should some degree of limiting be desirable, proceed as follows:

- a. Without the load connected to the OUTPUT terminals and the POWER switch in the STDBY/RESET position, set the front-panel controls as follows:
- | | |
|---------------|--|
| RANGE | As desired |
| TRIP | To the lowest range that overlaps the desired trip voltage |
| VERNIER | Fully cw |
| CURRENT LIMIT | As desired |
| INPUT MODE | TVM |
| SENSITIVITY | V |
| Readout Dials | Desired trip voltage |
- b. Set the POWER switch from the STDBY/RESET position to OPR.
- c. Slowly rotate the VERNIER control counter-clockwise until the indicator lamp near the TRIP switch illuminates and the red lamp near the POWER switch is extinguished. The voltage trip is now set to the value indicated on the readout dials and the instrument is tripped to the STDBY mode.
- d. To reset the instrument, set the readout dials to a value less than the trip voltage and place the POWER switch in the STDBY/RESET position, then to OPR.

2-13. Current Limit Setting

2-14. The CURRENT LIMIT control provides a means of limiting the amount of output current. If no limiting

within the current range of the instrument is desirable, set the CURRENT LIMIT control to the fully clockwise position (60). Should some degree of current limiting be desirable, proceed as follows:

- a. With the POWER switch in the STDBY/RESET position, set the front panel controls as follows:
- | | |
|------------------|-----------------|
| RANGE | As desired |
| TRIP and VERNIER | As desired |
| CURRENT LIMIT | Fully clockwise |
| INPUT MODE | TVM |
| SENSITIVITY | I |
| Readout Dials | 1 volt |
- b. Place a short across the OUTPUT terminals.
- c. Set the POWER switch to the OPR position.
- d. Adjust the CURRENT LIMIT control until the current indicated on the meter is the value of the desired limiting current.
- e. Place the POWER switch in the STDBY/RESET position. Remove the short. Current limiting is now set to the desired value for any output voltage.

2-15 VM AC Common Connections

2-16. For optimum common mode rejection, connect the VM AC COMMON terminal to either the GUARD or ground terminal with the shorting link provided. The decal on the rear of the instrument case shown in Figure 2-1 illustrates the proper connections depending upon whether the instrument is operated as a voltage source or as a voltmeter.

2-17. Sense Connections

2-18. When a load is connected, there may be an appreciable voltage drop between the instrument and

the load due to the length and gauge of the connecting wire leads. The nomograph, in Figure 2-2 can be used to determine the approximate voltage across the connecting wire leads.

2-19. Using the nomograph of Figure 2-2 lay a straight edge from the value of the output current, represented on scale 1, to the gauge of the connecting wires used, represented on scale 2. The voltage across the connecting wires, expressed in millivolts per foot, is obtained from scale 3. To determine the total voltage across the connecting wires, multiply the total length in feet by the value obtained from scale 3. For example, assume that two AWG #28 wires, each 3 feet long, are used to connect a load, requiring 50 milliamperes, to the instrument. With a straight edge, connect the known current on scale 1 (50 ma) and the wire size on scale 2 (#28). The resulting IR drop on scale 3 is approximately 3.2 millivolts per foot. Therefore, the connecting wires develop a total voltage of 19.2 millivolts ($2 \times 3\text{ft} \times 3.2 \text{mv/ft} = 19.2 \text{mv}$), which is several times the published load regulation of the instrument at 1000 volts output. To compensate for this, the instrument is equipped with remote sensing, which maintains regulation at the load. Consequently, the voltage across the connecting wires will have no effect. Determine if the wire leads, used to connect the instrument to the load, will cause a voltage drop in excess of the load regulation specifications. If this voltage drop is excessive, remote sensing should be used. To prepare the instrument for remote sensing, proceed as follows:

- a. With the POWER switch set to OFF, or to STDBY/RESET, remove the front-panel shorting links between the SENSE and OUTPUT terminals.
- b. Using a twisted pair of insulated wires, connect the + SENSE terminal to the positive side of the load, and connect the - SENSE terminal to the negative side of the load.

CAUTION!

Insure that the SENSE terminals are connected to the load in the proper polarity. Incorrect connections will result in loss of regulation and possible damage to the instrument.

2-20. Guard Connection

2-21. When the instrument is connected to another instrument (both instruments grounded through their respective power cords), a potential difference may exist between the power line grounds of these two instruments. This potential difference can cause circulating ground currents, which could cause errors in the output voltage. To prevent these errors from occurring, the instrument is equipped with a guard. This guard, when properly connected to the load, will provide a separate path for the circulating ground currents; thus eliminating possible errors in the output voltage. For proper connection, connect the GUARD terminal directly to the grounded side of the load, at the load. Figure 2-3 illustrates the correct GUARD terminal connection and the rerouted circulated ground current path.

2-22. OPERATION AS A VOLTAGE STANDARD

2-23. Operate the instrument in accordance with following procedure:

- a. Set the voltmeter controls as follows:

| | |
|-------------|-----|
| NULL ZERO | OPR |
| INPUT MODE | TVM |
| SENSITIVITY | V |

- b. Set the POWER switch in the STDBY/RESET position. Allow at least a 10 minute warm-up period, if the instrument has just been energized.
- c. Connect the SENSE terminals to the OUTPUT terminals with the shorting links provided.
- d. Set the CURRENT LIMIT control fully clockwise (60) or to a predetermined value, using the procedure of paragraph 2-13.
- e. Set the RANGE switch to the desired output voltage range (10, 100, or 1000).
- f. Set the voltage TRIP and VERNIER controls fully clockwise or to a predetermined value, using the procedure of paragraph 2-11.
- g. Set the readout dials to the value of the output voltage desired.
- h. Connect the VM AC COMMON terminal to the GUARD terminal with the shorting link provided. If desired, connect the GUARD terminal to the grounded side of the load in accordance with paragraph 2-20. The SENSE terminals may remain connected to the OUTPUT terminals. Should remote sensing be desired, connect the SENSE terminals to the load in accordance with paragraph 2-17.
- i. Connect the load to the OUTPUT terminals.
- j. Set the POWER switch to the OPR position.
- k. The output voltage provided to the load will be the voltage indicated on the readout dials. Should it be desirable to monitor the output voltage or current, place the SENSITIVITY switch in either the V (voltage) or I (current) position.

2-24. OPERATION AS A HIGH IMPEDANCE VOLTMETER OR NULL DETECTOR

2-25. Use the following procedure for operating the instrument as a high impedance voltmeter. Since it incorporates a center-scale zero meter, the instrument may also be used as a null detector. In this application, the following procedure also applies.

- a. Set the VOLTAGE STANDARD controls as follows:

| | |
|-------|----|
| RANGE | 10 |
| TRIP | 10 |

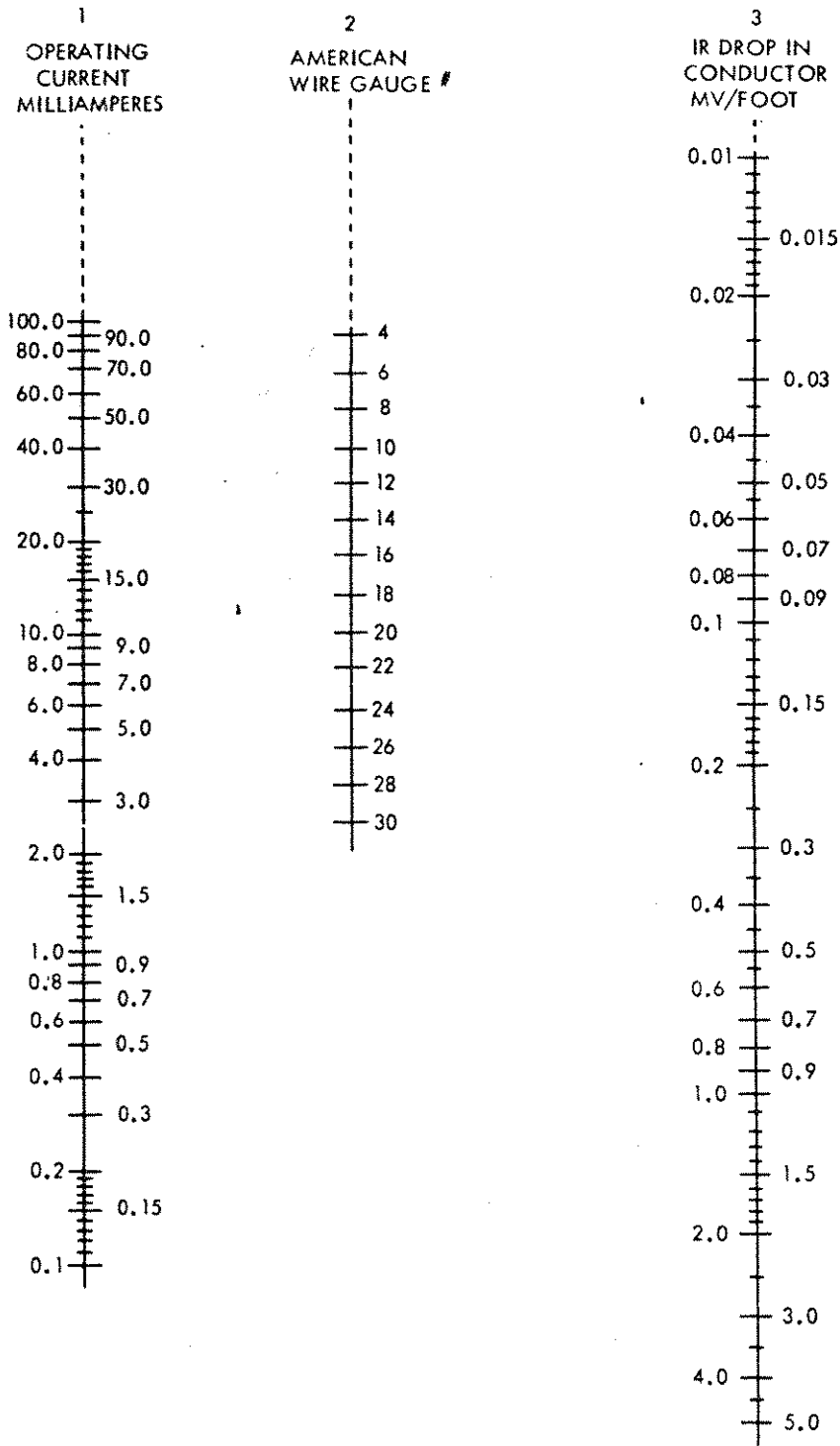

Figure 2-2. NOMOGRAPH OF VOLTAGE DROP ACROSS LOAD WIRES

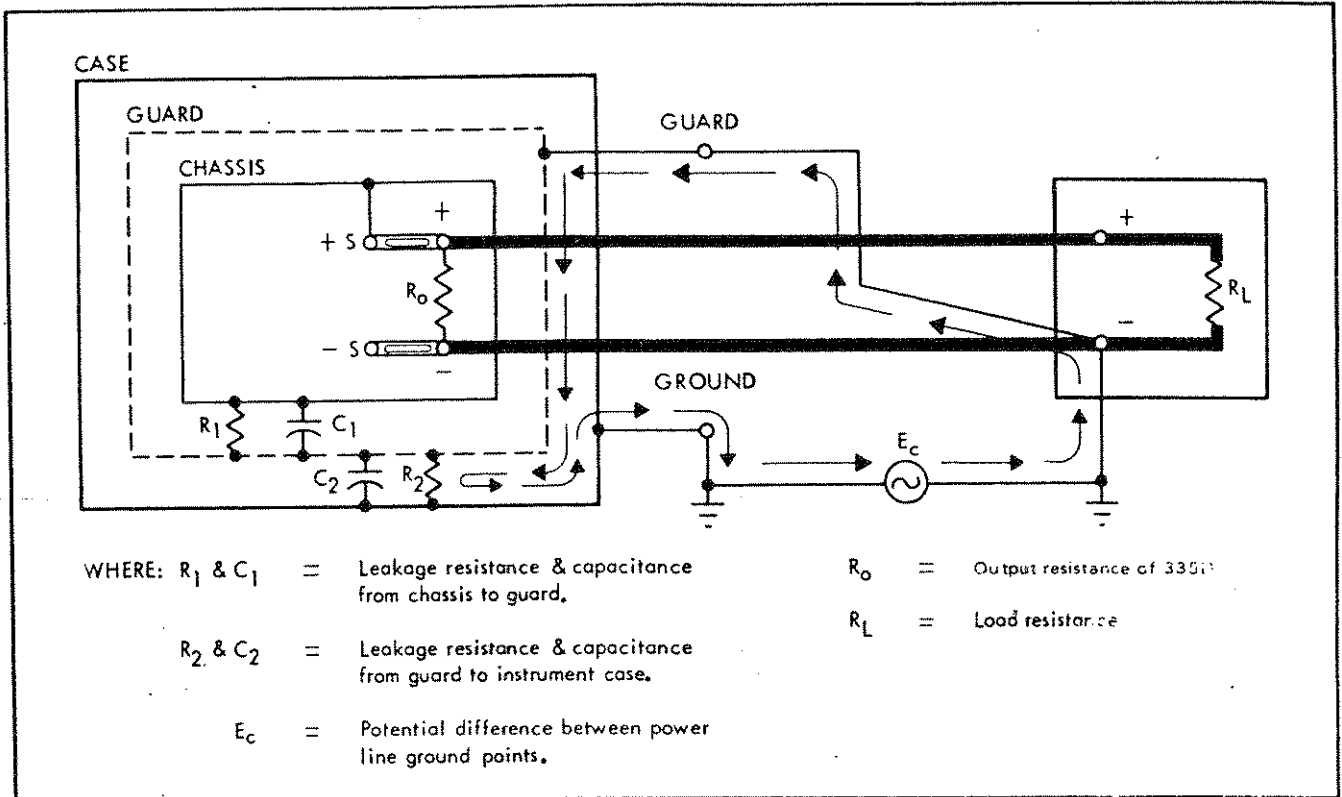

Figure 2-3 GUARD CONNECTION

| | |
|---------------|-----------------|
| VERNIER | Fully clockwise |
| CURRENT LIMIT | Fully clockwise |
| Readout Dials | All zero |

- b. Set the NULL DETECTOR controls as follows:

| | |
|-------------|------|
| NULL ZERO | OPR |
| INPUT MODE | TVM |
| SENSITIVITY | 1 KV |

- c. Connect the VM AC COMMON to the ground terminal with the shorting link provided.
- d. Set the POWER switch to the STDBY/RESET position.
- e. Connect the voltage source to the INPUT terminals of the Model 335D.
- f. Set the SENSITIVITY switch to the highest sensitivity range that will allow an on-scale deflection. As indicated on the meter, a deflection to the left of zero represents a negative input voltage; whereas a deflection to the right of zero represents a positive input voltage.
- g. When using the higher sensitivity ranges (1 mv, 100 uv, or 10 uv), the electrical zero should be

adjusted. Set the NULL ZERO switch to the ZERO position and the SENSITIVITY switch to the 10 uv position. Rotate the ADJUST control until the meter indicates zero. After the adjustment has been completed, return the SENSITIVITY switch to its original position; then set the NULL ZERO switch to the OPR position.

2-26. OPERATION AS A DIFFERENTIAL VOLTMETER

2-27. To operate the instrument as a differential voltmeter, proceed as follows:

- a. Set the front-panel controls as follows:

| | |
|---------------|----------------------|
| POWER | STDBY/RESET |
| NULL ZERO | OPR |
| INPUT MODE | TVM |
| SENSITIVITY | 1 KV |
| RANGE | As desired |
| TRIP | 1000 |
| VERNIER | Fully clockwise |
| CURRENT LIMIT | Fully clockwise (60) |
| Readout Dials | All zero |

- b. Connect the VM AC COMMON terminal to the ground terminal with the shorting link provided.
- c. Set the POWER switch to the OPR position.
- d. Connect the external voltage source to the INPUT terminals.
- e. Use the instrument as a high impedance voltmeter to determine the approximate value of the unknown input voltage. Adjust the RANGE switch and Readout Dials, such that this value is indicated on the front-panel readout.
- f. If the front-panel meter indicates to the right (+) side of zero, set the INPUT MODE switch to DIFF+. If the front-panel meter indicates to the left (-) side of zero, set the INPUT MODE switch to DIFF-.
- g. Adjust the readout dials for a null (zero) indication on the front-panel meter. Set the SENSITIVITY switch to successively more sensitive positions while adjusting the Readout Dials for a null indication on the front-panel meter at each setting.
- h. Check and adjust, if necessary, the meter electrical zero in accordance with paragraph 2-25, step g. If an electrical zero adjustment was necessary, re-adjust the Readout Dials for a null indication on the front-panel meter.
- i. The value of the voltage indicated on the front panel readout is that of the external voltage source.

2-28. OPERATION WITH A RECORDER

2-29. To use the instrument with a recorder for measuring a voltage or voltage excursions, proceed as follows:

- a. Set the front-panel controls as follows:

| | |
|-------|-------------|
| POWER | STDBY/RESET |
|-------|-------------|

| | |
|---------------|----------------------|
| NULL ZERO | OPR |
| INPUT MODE | DIFF+ |
| SENSITIVITY | 1 |
| RANGE | 10 |
| Readout Dials | 1.0 0 0 0 0 0 |
| TRIP | 1000 |
| VERNIER | Fully clockwise |
| CURRENT LIMIT | Fully clockwise (60) |
| Terminal | See Figure 2-2 (b) |
| Connections | |

- b. Connect the recorder to the RECORDER OUTPUT terminals at the rear panel. The recorder outputs may be floated up to 100 volts dc above ground.
- c. Short the HI and LO INPUT terminals.
- d. Set the POWER switch to the OPR position.
- e. The front-panel meter should indicate full scale to the left of zero (-1). This full-scale deflection will allow up to 1 volt at the RECORDER OUTPUT terminals, depending upon the setting of the RECORDER OUTPUT ADJUST control.
- f. Adjust the RECORDER OUTPUT ADJUST control to provide the desired recorder deflection for the full scale front-panel meter deflection.
- g. Set the INPUT MODE switch to the TVM position and remove the short from the INPUT terminals.
- h. Set the SENSITIVITY switch to the 1000 volt position.
- i. Connect the voltage source to be measured to the INPUT terminals and operate the instrument as either a differential voltmeter (paragraph 2-26) or high impedance voltmeter (paragraph 2-24).

Section 3

Theory of Operation

3-1. INTRODUCTION

3-2. The Model 335D unites a precision voltage standard and high impedance voltmeter-null detector in one chassis. In addition to using the voltmeter-null detector and voltage standard separately, they must be combined to function as a differential voltmeter. How it accomplishes these functions will be described in this section. Use the text in conjunction with the functional schematic diagrams at the end of this manual. Paragraphs 3-3 and 3-4 describe the voltage standard and voltmeter functions, respectively.

3-3. VOLTAGE STANDARD FUNCTION**3-4. General**

3-5. The voltage standard portion is a series regulated power supply basically consisting of the voltage control circuitry, pre-regulation circuitry, and protection circuitry. The voltage control circuits are the main regulation circuits and respond to load, RANGE, and readout dial changes. Figure 3-1 illustrates a simplified schematic diagram of the voltage control circuitry. Both the error amplifier and series pass element, illustrated in the shaded portion, constitute a dc operational amplifier. The tendency of the operational amplifier is to maintain the summing point effectively at + SENSE potential. In this condition the output voltage of the voltage standard is equal to the ratio of the sample string resistance (R_{READOUT}) to the range resistance (R_{RANGE}) times the reference voltage ($E_{\text{REFERENCE}}$), as illustrated in Figure 3-1. The

constant reference voltage ($E_{\text{REFERENCE}}$), in combination with the appropriate series resistance (R_{RANGE}), provides a constant current to the sample string. Due to the constant current, the output is proportional to the resistance of the sample string (R_{READOUT}). Since the tendency of the operational amplifier is to maintain the summing point at + SENSE potential, the output voltage is equal to the sample string voltage. Changing the setting of the readout dials (sample string) causes the output voltage to change correspondingly. Each change in the RANGE switch setting causes the constant current to change by a factor of 10; thus the output voltage changes by the same factor. A detailed block diagram is illustrated in the Functional Block Diagram (335A-1500), following Section 5. In this diagram, the chopper amplifier, differential amplifier, and series pass driver constitute the error amplifier of Figure 3-1.

3-6. Series regulated power supplies have the inherent disadvantage of low efficiency. When providing a low level output, the series pass element of the supply must dissipate the bulk of the power supplied by the high voltage transformer circuit. A unijunction oscillator circuit monitors the voltage across the series pass element and provides voltage level information to a pre-regulation circuit. The pre-regulation circuit utilizes this information to provide full-wave phase control of the input line voltage to the primary of the high voltage transformer. Thus, the power supplied by the high voltage transformer is controlled to provide only that amount necessary for the load requirements. This in turn increases

the overall efficiency of the instrument. This also accounts for symbolizing the unregulated dc voltage, in Figure 3-1, as a variable dc voltage.

3-7. Circuitry for protection of personnel as well as external equipment, is contained in the instrument. The instrument contains an interlock system to de-energize the high voltage circuits within the instrument for personal safety. A limit may be set for the output voltage and/or current. Whenever the output voltage or current tries to exceed the set limits, the instrument output is de-energized. Therefore, sensitive external equipment can be protected from excessive voltage and current.

3-8. Voltage Control Circuitry

3-9. REFERENCE CIRCUITS. The basic reference voltage for the instrument is supplied by zener diode CR1402. This diode is located in a proportionally controlled oven on the Reference P/C A5A1 Assembly, (332B/AF-1083). Current through the reference zener diode is maintained constant current source consisting of Q1401, CR1401, R1403, and R1. These components, except for R1, are also contained in the oven assembly for environmental stability.

3-10. A constant temperature is maintained in the proportionally controlled oven by the temperature regu-

lating circuitry, located on the Reference Supply P/C Assembly (A5A1). The temperature regulator circuitry consists of a differential amplifier (Q3 and Q4), a Darlington amplifier (Q1 and Q2), and associated circuitry. One input to the differential amplifier, the base of Q3, is connected to common. Consequently, the output current from the collector of Q3 is proportional to the current into the base of Q4. The temperature coefficient of R1402 is negative. Therefore as temperature decreases, the current into the base of Q4 increases, which increases the base drive of Q2. The increased current into the base of Q2 increases the conduction of both Q2 and Q1, which increases the current through the heater (R1401). Because of the Darlington configuration of Q1 and Q2, a small change in current into the base of Q2 results in a significant change in current through R1401; thus providing close regulation of the oven temperature.

3-11. The constant output voltage from the reference zener diode is applied to the Range Calibration P/C Assembly (332B/AF-1052). This assembly provides three output ranges. The zener reference diode provides a constant voltage of approximately 6.3 volts. This voltage is reduced by R1, calibration adjustment R2, and R3 to 6.02 volts. Resistors R9 and R10 provide a 1 milliamper current for the 1000 volt range. Resistors R7 and R8 provide a 0.1 milliamper current for the 100 volt range. Resistors R4, R5, and R6 provide a 0.01 milliamper current for the

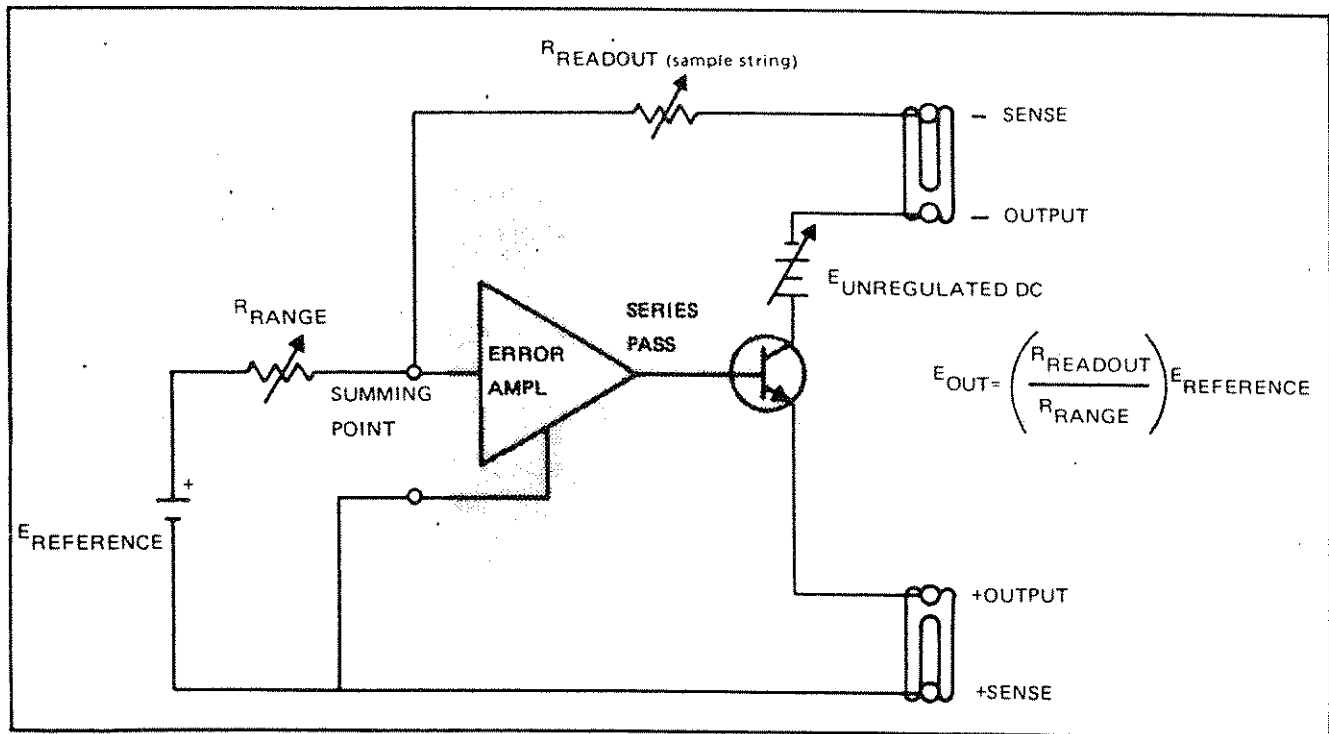

Figure 3-1. VOLTAGE CONTROL CIRCUITRY

10 volt range. One of the three constant currents is selected and supplied to the sample string, depending upon the position of the RANGE switch.

3-12. The Sample String P/C A2 Assembly is a resistance string whose value is controllable by the front-panel readout dials. The resistance of the sample string is such that the constant current through it develops a voltage equal to the value set on the readout dials.

3-13. CHOPPER AMPLIFIER. The voltage at the summing junction is applied through pin 5 to the junction of R1 and R4 on the Differential Amplifier A5A3 P/C Assembly (335A-1057). One path is provided for dc changes through R1 and pin 6 to the input of the Chopper Amplifier (A5A4) P/C Assembly, (333A-1004). The other path is for ac changes through the differential amplifier circuitry to be described later. The chopper amplifier compares the summing point voltage to the + sense voltage and provides an amplified dc error signal proportional to the difference. The + sense voltage is applied through a divider network, consisting of R7 through R12 located on the Reference Supply A5A1 P/C Assembly (332B/AF-1083), at pin 5. This network provides an internally adjustable dc bias to the chopper amplifier for compensation of offset voltages, when the instrument is set to zero input.

3-14. CHOPPER AMPLIFIER. The A5A4 Chopper Amplifier (333A-1004) compares low frequency and dc control signals from the A2 Sample String output to the + SENSE terminal voltage and amplifies any difference. The circuitry consists of an input filter, a MOSFET chopper, an operational amplifier, a synchronous demodulator, an output filter, and a multivibrator.

3-15. Low frequency and dc control signals at terminal 6 are passed through the input filter C2, R1, and C3 to reject frequencies above 30 Hz. The MOSFET chopper Q1 modulates the signal appearing at the junction of its drain and R2. C4 couples the resultant to the gate of JFET Q2. The output signal at the drain of Q2 is then amplified by the operational amplifier IC1, which has a gain of approximately 420. The paraphase amplifier Q3 amplifies the output of IC1 and provides two equal amplitude, but 180° out-of-phase signals. The collector signal of Q3 is coupled by C16 to the shunt demodulator Q4. The resulting demodulated signal appearing at the junction of C17 and R24 is filtered by R24, R26 and C18, leaving only the amplified dc and low frequency signals. The emitter signal of Q3 is applied through C14, R21, C15, R25, R23, and C22 to C18, where it is used to cancel any chopper ripple at 270 Hz.

3-16. The 270 Hz multivibrator is formed by Q6, Q7 and associated timing networks, in addition to a driver Q5. Variable resistor R43 adjusts the level of the signal applied to the driver Q5, and subsequently the output signal applied to the gate of Q1. The collector signal of Q5 is applied to the drain of Q1 to compensate for spikes coupled between the gate and drain. Variable resistor R34 provides adjustment of the compensation signal. An output signal at the collector of Q7 is applied to the base of Q4, which synchronously demodulates the Chopper Amplifier output.

3-17. DIFFERENTIAL AMPLIFIER. Error signals, in the form of ac changes, are applied to the differential amplifier through C1 to the gate of Field Effect Transistor (FET) Q2. Error signals appearing as dc changes are applied to the chopper amplifier at the base of Q6. Using a separate path for ac changes allows rapid regulation of the output voltage for rapid changes in load requirements. The Differential Amplifier P/C Assembly provides an output that is proportional to the amplified dc error signal from the Chopper Amplifier P/C Assembly.

3-18. Use of a Field Effect Transistor for Q2 provides high input impedance and low noise. Transistor Q8 is a current source for one stage of the differential amplifier. Use of the current source provides high gain and good common mode rejection at the input of the amplifier. The compound configuration of Q4-Q5 and Q6-Q7 provides high input impedance and minimizes temperature effects. The output signal from the collector of Q9 is applied to the base of the common collector amplifier Q11. Transistor Q11 provides impedance matching between the high output impedance of Q9 and the low input impedance of the series pass driver circuit.

3-19. SERIES PASS DRIVER. The Series Pass Driver A5A2 P/C Assembly (335A-1056), accomplishes two functions. One function is to de-energize the output in the case of an overvoltage or overcurrent condition, which will be described later. The other function is to provide sufficient drive current for error signals to the series pass element. Transistors Q5, Q6, Q7 and associated circuitry constitute the driver portion. Transistor Q7 is a common-base amplifier which provides part of the voltage gain necessary for control of the series pass element. Current gain is provided by common collector amplifiers Q6 and Q5. The output of Q5 is applied to the main series pass transistor Q8, on the Series Pass Element A8A1 P/C Assembly, (332B/AF-1061).

3-20. SERIES PASS ELEMENT. The series connection of transistors Q1 through Q8 constitute the series pass

element. This element is located on the Series Pass A8A1 P/C Assembly (332B/AF-1061). Transistors Q1 through Q7 are normally saturated by the base voltage supplied by the 150 volt power supply. Consequently, the entire voltage drop required for regulation is across Q8. Should the OUTPUT terminals be shorted or should the instrument be rapidly down-ranged, the voltage across Q8 may exceed 150 volts. Should this occur, transistors Q1 through Q7 will come out of saturation to share the voltage drop. The pre-regulator circuitry (paragraph 3-25), sensing the increased voltage across Q8, decreases the unregulated supply voltage. As soon as the voltage across Q8 decreases below 150 volts, Q1 through Q7 become biased to saturation and Q8 absorbs the entire regulation voltage.

3-21. POWER SUPPLIES. Operating voltages for the temperature regulating circuit, zener reference circuit, chopper amplifier, and differential amplifier are provided by the Auxiliary Power Supply A5A5 P/C Assembly (335A-1059). The auxiliary power supply consists of the 25 volt supply and -15 supply circuits. The auxiliary supply reference element is located in the 25 volt supply. The output of the 25 volt supply is then used as the reference for regulation of the -15 volt supply.

3-22. In the 25 volt supply, CR1 through CR4, C2, R4, and C3 provide unregulated dc voltage to the regulation circuitry consisting of Q2 through Q6. Transistors Q5 and Q6 constitute a differential amplifier. The base of Q6 is held at a constant voltage by zener diode CR6. The base of Q5 is connected to a voltage divider, consisting of R8, R9, and R10, referenced to the output of the supply. Variations in the +25 volt output of the supply are sensed at the base of Q5. Any difference between the base voltages of Q5 and Q6 is amplified by the differential pair and applied from the collector of Q5 to the base of series pass driver Q3. The amplifier error signal controls the conduction of Q3, which in turn controls the series pass element Q4. Transistor Q2 is a constant current source to supply base drive to Q3.

3-23. In the -15 volt supply, CR7 through CR10, R14, and C8 provide the unregulated dc voltage to the regulating circuit consisting of series pass element Q7 and differential pair Q8 and Q9. The base of Q9 is connected to a voltage divider referenced to the +25 volt supply output. The base of Q8 is connected to the positive side of the -15 volt supply. Variations in the output voltage are sensed at the base of Q9. Any difference between the base voltages of Q8 and Q9 is amplified by the differential pair and applied from the collector of Q8 to the base of series pass element Q7. The amplified error signal controls

the conduction of Q7 and consequently the magnitude of the output voltage. The positive side of the 15 volt supply is connected to the negative side of the +25 volt supply through pins 11 and 12. The + sense line is connected to this junction and is the common for the auxiliary power supply.

3-24. The ± 35 volt operating voltages for the series pass driver circuitry, on the Series Pass Driver A5A2 P/C Assembly, is provided by a power supply located on the Current Limiter A5A6 Assembly (335A-1060). In the diode bridge configuration of CR1 through CR4, diodes CR1 and CR2, R1 and C1 provide a positive unregulated dc voltage. Diodes CR3 and CR4, R4, and C4 provide negative unregulated dc voltage. The positive unregulated dc voltage is applied to the regulating circuit of Q1 and CR5 and through a voltage divider to the RANGE switch, for application to the appropriate decimal lamp. The 36 volt reference voltage, established by CR5, provides the input signal for the emitter follower configuration of Q1. This emitter follower configuration provides the necessary low output impedance and power gain of the power supply. The -35 volt supply functions in the same manner as the +35 volt supply.

3-25. Pre-Regulation Circuitry

3-26. OSCILLATOR. A unijunction oscillator, consisting of Q9 and associated circuitry, is located on the Series Pass Element A8A1 P/C Assembly (332B/AF-1061). Applied to base 2 of Q9 is a 6.8V clipped, full-wave rectified, 60 Hz sine wave. The potential at the emitter of Q9 depends upon the charge of C4 and C5. The charge of C5 depends upon the voltage across the main series pass element, Q8. At the trailing edge of each pulse at the base 2 of Q9, the oscillator provides a series of positive pulses until the leading edge of the next +6.8 volt pulse occurs. With an increased charge across C4 and C5, the initial output pulse of the oscillator will occur earlier in each half cycle. The initial pulse from the oscillator during each half cycle will switch the preregulator off to control the amount of line power supplied to the high voltage transformer. If the series pass element voltage of Q8 increases, the preregulator is switched off earlier in each half cycle. This, in turn, reduces the series pass element voltage of Q8 to its equilibrium value.

3-27. The +6.8 volt operating voltage for the oscillator circuit is taken from the +150 volt supply for the series pass element. A portion of the +150 volt supply is applied to the voltage divider consisting of R1 through R3. The divided down voltage is regulated by zener diode CR6 to approximately +6.8 volts.

3-28. **PRE-REGULATOR.** The series of unijunction pulses are coupled across A8T1 to the input of the pre-regulator on the Pre-Regulator A8A2 P/C Assembly (332B/AF-1082). At the beginning of each 60 Hz half cycle, Q5 is turned on by the positive going +V voltage, through R17 and L2. Conduction of Q5 saturates Q4, Q2, and Q1 (pre-regulator control transistor). Conduction of Q1 allows current to flow in the primary of the high voltage transformer. Sometime, during each half cycle, the initial pulse from the unijunction oscillator will trigger the regenerative pair (Q6 and Q7) into saturation. With Q6 and Q7 conducting, Q5, Q4, and Q1 turn off and remain off as Q6 and Q7 are conducting. Transistors Q6 and Q7 remain conducting until the end of each half cycle. At this time, the current through them automatically drops below the regenerative valve, due to the zero crossing of the full-wave rectified 60 Hz sine wave voltage (-V) at the emitter of Q7. Therefore, transistor Q1 is held off for the remainder of the half cycle. This limits the amount of power to the high voltage transformer and reduces the power dissipation requirements for the series pass element.

3-29. Operating voltages for the pre-regulator circuitry are provided by the diode bridge configuration of CR1 through CR4. Diodes CR2 and CR4 provide a negative full-wave rectified voltage for -V. Diodes CR1 and CR3 provide a positive full-wave rectified voltage for +V. A portion of the +V voltage is filtered by C4 and C5 to provide the +10 volt supply voltage. Diode CR5 serves to isolate the +V voltage from the filter capacitors.

3-30. Protection Circuitry

3-31. **TRIP.** The purpose of the trip circuit is to remove ac power from the primary of the high voltage transformer and open the negative output path, if an overvoltage or catastrophic overcurrent condition exists. The trip circuitry is located on the Series Pass Driver A5A2 P/C Assembly (335A-1056). Transistor Q3 is a constant current source for relays A8K1 and A8A2K2. With A8A2K2 (on the Pre-Regulator P/C Assembly) closed, current is provided to A8A2K1 which completes the primary circuit for the high voltage transformer. With relay A8K1 (on the High Voltage Motherboard P/C Assembly) closed, the negative output path is completed and power may be supplied to the load. The current sensing resistor, R22, is effectively connected through R24 to the base of normally off Q4. In the event of a catastrophic failure, in which the current limiting circuitry would not function, an excessive current approaching 120 milliamperes would develop sufficient voltage across R22 to turn on Q4. Because of the regenerative configuration, transistors Q4 and Q2 would

become saturated. With Q2 saturated, the potential at pin 10 becomes nearly the same as the positive buss potential. This bypasses the current away from the relays, which causes them to open. With the relays open, the OUTPUT terminals are de-energized, the input power to the high voltage transformer is interrupted, and the OPR indicator lamp goes out. To reset the instrument, the POWER switch is placed in the STDBY/RESET position; then to the OPR position once the cause of the overload has been corrected. With the POWER switch in the STDBY/RESET position, the circuit common is connected through a section of the POWER switch and pin 10 to the emitter of Q2. This results in turning off both Q2 and Q4, and thus returning them to their original state.

3-32. The overvoltage trip element is Q1. The base of Q1 is connected to R15 and the appropriate resistor selected by the TRIP switch. The voltage trip point is selected by the VERNIER control (R5), which sets a reference bias on Q1 (maintaining Q1 cut off). As the output voltage increases, the voltage at the base of Q1 increases negatively until it exceeds the selected trip voltage and causes Q1 to conduct. The conduction of Q1 saturates Q2 and results in de-energizing the instrument output terminals, as previously described.

3-33. **CURRENT LIMIT.** The current limit circuitry, located on the Current Limiter A5A6 P/C Assembly (335A-1060), provides a means of varying the limiting point of the output current. Current sensing resistor R22, on the Series Pass Driver A5A2 P/C Assembly, provides a voltage to the current limiter circuit that is proportional to the output current. This voltage is applied through pin 10 and CR12 to the base of Q5. The emitter of Q5 is connected to the wiper of the CURRENT LIMIT control (R6), which provides a variable bias for the base-emitter junction. Transistor Q5 is normally off. However, when the output current exceeds the set limit, Q5 turns on. Conduction of Q5 causes both Q4 and Q3 to conduct. Conduction of Q3 causes Q1, on the Differential Amplifier P/C Assembly, to conduct and bypass some of the sample string current. This causes the output voltage to be reduced and consequently the output current is reduced. The conduction of Q3 also turns on the regenerative pair, Q6 and Q7, which supply current to the red indicator lamp.

3-34. **INTERLOCKS.** The instrument is equipped with an interlock circuit for personnel safety. When either the top or bottom inner covers or printed circuit Assemblies A8A2, A8, A8A1, A5A1, A5A3, A5A4, A5A5, or A5A6 are removed, the ground return for the A8K1 and A8A2K2 relays is opened. This results in removal of the input power

to the high voltage transformer (T1) and opens the negative output side of the instrument.

3-35. TIME DELAY. The purpose of the time delay circuit, located on the Time Delay A7 P/C Assembly (332A-1020), is to provide a short interval for the auxiliary voltages to rise to nominal value. This insures that the control amplifiers are operating before the high voltage is available. The time delay circuit momentarily holds open relays A8K1 and A8A2K2, which prevents the closure of A8A2K1. The time delay is approximately 3 seconds. Diodes CR1 and CR2 provide a full-wave rectified voltage from a secondary winding of the power transformer between pins 20 and 22. When the POWER switch is in the STDBY/RESET position, a small current flows through R2001, S1c, K2001, R2004, and C2001. This current, although too small to actuate K2001, charges C2001. Capacitor C2001 charges until it reaches the firing point of Q2001, approximately 2 to 3 seconds. At this point A2001 conducts, increasing the current through K2001. The relay actuates and closes contact K2001A (which provides the current path when the POWER switch is in the OPR position) and opens contact K2001B. When K2001B opens, the grounding circuit is removed from the constant current source supplying A8K1 and A8A2K2, and these relays are allowed to actuate.

3-36. Miscellaneous Circuitry

3-37. OUTPUT CIRCUIT CURRENT SOURCE. In addition to the main high voltage bridge rectifier, CR1

through CR10 on the High Voltage Motherboard A8 P/C Assembly (335A-1063), is another high voltage bridge (CR 13 through CR20). This bridge rectifier is in series with R27 and R28 and forms a quasi-constant current source, connected in opposition to the output of the instrument. This current flows through the series pass transistors and acts as a minimum load to insure that their transconductance is held above a minimum value. Another purpose of the quasi-constant current source is to provide a quick discharge path for the output capacitor C1, when downranging. This helps to reduce the settling time.

3-38. CAPACITOR SWITCHII. The capacitor switch circuitry is located on the Capacitor Switch A3 P/C Assembly (335A-1092). When downranging from 1000 volts, capacitor C4 (on the chassis) will tend to charge to a voltage level proportional to the difference between the charge on C5 and the parallel combination of the output capacitors C1 and C2. If this difference is too great, C4 will receive a charge of sufficient magnitude to cause a dielectric absorption problem; thus excessive settling time will result. (Dielectric absorption is the tendency of the dielectric material of the capacitor to absorb and retain a small charge). To prevent this occurrence, C5 is discharged through R7 (on A3) when the RANGE switch is downranged from 1000 volts to 10 to 100 volts. In doing so the decay rate of C5 and the parallel combination of C1 and C2 will be equal; thus C4 does not receive an over charge. After C5 has discharged sufficiently (several seconds), the K1A contacts (on A3) close and parallels the low resistance of R6 with R7. This essentially shorts C5 and returns the

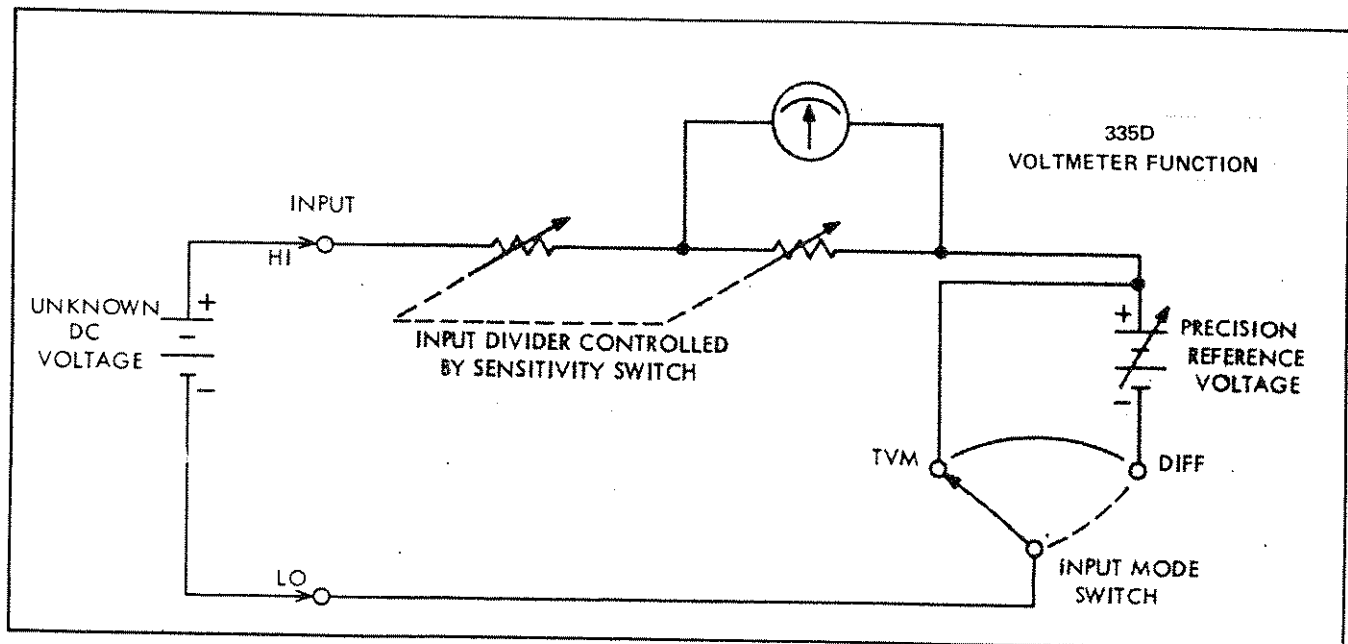

Figure 3-2. BASIC VOLTMETER OPERATION

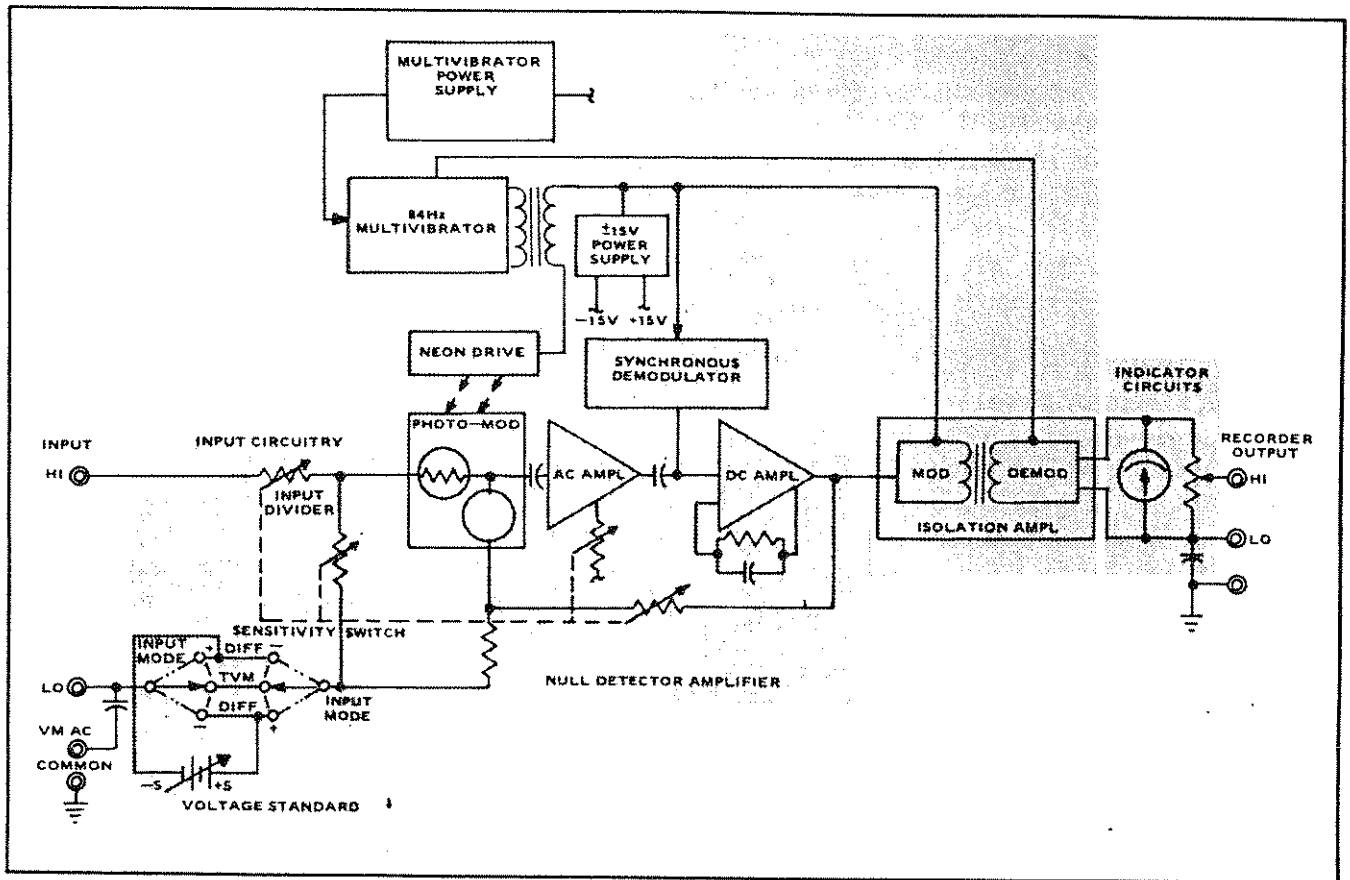

Figure 3-3. VOLTMETER FUNCTIONAL BLOCK DIAGRAM

loop gain to the required amount. The capacitor switch circuitry is responsible for allowing a time delay before closing the K1A contacts. When downranging from 1000 volts, C1 is charged by the +35 volt supply through R2 and R1. After several seconds, C1 accumulates a sufficient charge to cause Q1 to conduct. Conduction of Q1 energizes relay K1 which closes the K1A contacts.

3-39. CROWBAR CIRCUIT. If the output voltage was suddenly turned to zero with a load connected to the instrument, the voltage across the filter capacitors C1, C2, and C3 (located on the High Voltage Motherboard P/C Assembly, A8) would appear across the series pass transistors. This voltage could damage the series pass transistors. To protect the series pass transistors from this kind of damage, a "crowbar" circuit is utilized. (The term "crowbar" is derived from the use of such a device to discharge large capacitor banks in transmitter power supplies). The "crowbar" circuit consists of transistor Q10 and associated circuitry on the Series Pass Element P/C Assembly, A8A1. Also, relay K2 on the High Voltage Motherboard P/C Assembly, A8. When the voltage across the series pass element reaches approximately 225 volts, transistor Q10 conducts. Since relay K2 is in the collector circuit of Q10, the relay is

energized and closes the K2A contacts. With the K2A contacts closed, a discharge path through R15 is provided for the filter capacitors.

3-40. VOLTMETER FUNCTION

3-41. General

3-42. BASIC VOLTMETER OPERATION. The voltmeter section may be operated as either a high impedance voltmeter, null detector or differential voltmeter. A simplified schematic diagram of the basic voltmeter operation is illustrated in Figure 3-2. When operated as a high impedance voltmeter or null detector (INPUT MODE switch in TVM), the input divider is connected directly across the INPUT terminals (HI and LO). In this configuration, the front-panel meter indicates the full value of the unknown voltage applied to the INPUT terminals. For differential voltmeter operation, the INPUT MODE switch is placed in the DIFF+ position. This places a variable precision reference voltage in series with the input divider across the INPUT terminals. The polarity of the reference voltage must be such as to oppose that of the unknown voltage. The voltage difference between the unknown voltage and that

of the reference voltage is displayed by the front-panel meter. When the meter indicates a zero volt difference, the reference voltage is equal to the unknown voltage. The Voltage Standard section provides the precision voltage reference needed for the differential voltmeter mode of operation. When the meter indicates a zero voltage difference between the voltage standard and unknown voltage, the readout dials display the exact value of the unknown voltage, with the specified accuracy.

3-43. BLOCK DIAGRAM ANALYSIS. A detailed block diagram of the voltmeter section is illustrated in Figure 3-3. The voltmeter section basically consists of the input circuitry, Null Detector Amplifier A6A2 P/C Assembly, Null Detector Power Supply A6A1 P/C Assembly, and the indicator circuits.

3-44. The input circuit divider provides a reduced dc voltage to the Null Detector Amplifier P/C Assembly. In TVM operation, the divider provides a reduced dc voltage proportional to the dc input voltage. In DIFF \pm operation, the divider provides a reduced dc voltage proportional to the difference between the input voltage and the voltage indicated on the readout dials. This proportional voltage is then chopped at an 84 Hz rate by a photo-chopper circuit on the Null Detector Amplifier P/C Assembly. Magnitude and polarity information is contained in the amplitude and phase, respectively, of the chopped signal. This chopped signal is then applied to a high input impedance ac amplifier whose gain is controlled by the resistance selected by the SENSITIVITY switch. Demodulation of the amplified signal is accomplished by the synchronous demodulator. The demodulator reconstructs the amplified dc level and polarity information and applies it to a fixed gain dc amplifier. A portion of the dc amplifier output is fed back to the input of the Null Detector Amplifier to control the overall amplifier gain. The other portion of the dc amplifier output is applied to the isolation amplifier, located on the Null Detector Power Supply A6A1 P/C Assembly. Here the dc signal is again modulated at 84 Hz, coupled across an isolation transformer, demodulated to reconstruct dc level and polarity information, and applied to the meter and recorder output terminals. In the TVM position of the INPUT MODE switch, the meter will indicate the full value of the applied dc input voltage. In the DIFF+ and DIFF- positions, the meter will indicate the difference between the applied dc input voltage and the voltage set on the front-panel readout dials. In either case, the full scale sensitivity will be that indicated by the position of the SENSITIVITY switch.

3-45. Circuit Descriptions

3-46. NULL DETECTOR POWER SUPPLY. The Null Detector Power Supply A6A1 P/C Assembly consists of the 84 Hz multivibrator, multivibrator power supply, +15 volt power supply, and isolation amplifier. Refer to Schematic 335A-1053 for the following circuit descriptions.

3-47. The multivibrator power supply consisting of bridge rectifier CR1 through CR4, filter R1-C1, and regulating element CR5 is driven by a secondary winding of power transformer T1 between pins 11 and 12. The 17 volt rms signal is rectified, filtered, and regulated to provide a 10 volt dc operating voltage for the 84 Hz multivibrator. The 84 Hz multivibrator consists of Q1 and Q2; frequency determining elements C2, R2, R3, and frequency adjustment R4; and the primary windings of T1. A portion of the 84 Hz signal from the secondary of T1 is used to drive the neon drive circuit on the Null Detector Amplifier P/C Assembly. The secondary of T1 also provides an 84 Hz signal to drive the synchronous demodulator Q6, on the Null Detector Amplifier P/C Assembly, and the bases of Q3 and Q4 in the modulator section of isolation amplifier, on the Null Detector Power Supply P/C Assembly. Still another portion of the 84 Hz signal from the secondary of T1 is rectified and filtered by CR6, CR7, C3, and C4 to provide the ± 15 volts dc operating voltages for the Null Detector Amplifier P/C Assembly. The collectors of Q1 and Q2, in the 84 Hz multivibrator, provide two signals 180° out of phase to the bases of Q6 and Q5 respectively, in the demodulator section of the isolation amplifier. Although the isolation amplifier is located on the Null Detector Power Supply P/C Assembly, its operation will be discussed under paragraph 3-50, "NULL DETECTOR AMPLIFIER," since it provides the signal flow path between the null detector amplifier and the indicator circuits.

3-48. INPUT CIRCUITRY. The null detector has three basic sensitivities for full scale meter deflection: 1 millivolt, 100 microvolts, and 10 microvolts. Input voltages above 1 millivolt are reduced by the divider, consisting of R9 through R16 and two functions of the SENSITIVITY switch (S5a and S5B). At 1 millivolt and below, a fixed input resistance of 1 megohm (R12) is connected across the INPUT terminals. The input resistance is 10 megohms in the 10 and 100 millivolt ranges and 100 megohms at 1 volt and above.

3-49. Placing the divider in the proper configuration for either null detector or differential voltmeter operation is accomplished by the INPUT MODE switch. In the TVM position, the INPUT MODE switch connects the divider

directly across the HI and LO INPUT terminals. The null detector amplifier senses across a portion of the divider. This portion of the divider provides a voltage proportional to the total input voltage. In the DIFF± positions the instrument is connected in series with the divider in such a polarity as to oppose the unknown input voltage. The null detector amplifier then senses a voltage proportional to the difference between the voltage set on the readout dials and the unknown input voltage.

3-50. NULL DETECTOR AMPLIFIER. The proportional dc voltage from the input divider is filtered by a three stage low-pass RC-filter composed of R1-C2, R3-C3, and R4-C4. This filter reduces any ac voltage having a frequency above 1 Hz. The filtered voltage is then chopped by the photo-cells V1 and V2, which are driven alternately at an 84 Hz rate by the neon driver circuit consisting of DS1, DS2, CR3, CR4, R2, and C1. The resulting chopped signal, containing dc level and polarity information, is coupled through C5 to a high input impedance ac amplifier consisting of Q1, Q2, Q3. The gain of the ac amplifier is controlled by the common emitter resistance selected by SENSITIVITY switch S5e. The output of Q3 is coupled through C10 to a two stage current amplifier consisting of Q4 and Q5. A fixed negative feedback, from the emitter of Q5 through C11 and R19 to the base of Q4, holds the gain of these stages constant.

3-51. The output of Q5 is coupled through C12 and R22 to the emitter of Q6 for demodulation. An 84 Hz drive signal, in-phase with the photo-chopper drive signal is applied to the base of Q6, causing detection of the magnitude and polarity of the amplified signal. The demodulated signal is filtered by R24 and C15 before application to the dc amplifier.

3-52. The dc amplifier amplifies the detected dc signal. Transistors Q7 through Q12 comprise a two-stage differential amplifier with a complementary emitter-follower output. Negative feedback from the emitters of Q11 and Q12

through C17, C18, and R31 to the base of Q8 controls the dc amplifier gain. The output of the dc amplifier is taken from the common emitters of Q11 and Q12. One portion of the output is applied to the isolation amplifier and the other portion through S5f and the selected SENSITIVITY range resistor for overall null detector amplifier gain.

3-53. The isolation amplifier, located on the Null Power Supply P/C Assembly, receives a portion of the dc amplifier output through the center tap of the primary of T2. The dc signal is modulated at an 84 Hz rate by Q3 and Q4, with a phase dependent upon the polarity of the input voltage. This modulated signal is coupled across transformer T2 for isolation. The phase of the waveform at the secondary of T2 permits conduction of either Q5 or Q6 during alternate halves of the cycle, causing detection of the modulated signal.

3-54. INDICATING CIRCUITS. In addition to indicating voltage during null detector or differential voltmeter operation, the meter also indicates the output voltage ("V" position of the SENSITIVITY switch) or output current ("I" position of SENSITIVITY switch and red meter scale). Resistors R3 through R6 (Series Pass Driver P/C Assembly) and the resistors selected by the RANGE switch S2f provide a drive current to the meter that is proportional to the output voltage, when the SENSITIVITY switch is in the "V" position. Resistors R1 and R2 (Series Pass Driver P/C Assembly) provide a drive current to the meter that is proportional to the output current, when the SENSITIVITY switch is in the "I" position.

3-55. A recorder output, directly proportional to meter deflection, is provided through R29, R30, and filter capacitor C8. Recorder output level adjust, R29, provides an adjustable output from 0 to 1 volt for end scale meter deflection. The LO RECORDER OUTPUT terminal is isolated from ground by a 0.47 microfarad capacitor and may be floated up to 100 volts dc from ground.

Section 4

Maintenance

4-1. INTRODUCTION

4-2. Information concerning the maintenance and calibration is contained in this section. Paragraph 4-6, GENERAL MAINTENANCE, covers unique and miscellaneous maintenance procedures. A series of checks to determine if the instrument operates properly, plus information to aid in localizing possible problem areas, should any of these checks fail, is covered under paragraph 4-21. PERFORMANCE TESTS. Paragraph 4-46, CALIBRATION, contains procedures for alignment of circuits and final accuracy adjustments. Paragraph 4-66, TROUBLESHOOTING, covers procedures for locating and correcting deficiencies in the instrument.

4-3. SERVICE INFORMATION

4-4. Each instrument manufactured by the John Fluke Mfg. Co., Inc. is warranted for a period of one year upon delivery to the original purchaser. Complete warranty information is contained in the Warranty page located at the front of this manual.

4-5. Factory authorized calibration and repair service for all Fluke instruments are available at various world wide locations. A complete list of factory authorized service centers is located at the rear of the manual. If requested, an estimate will be provided to the customer before any repair work is begun on instruments beyond the warranty period.

4-6. GENERAL MAINTENANCE

4-7. Maintenance Access

4-8. The following procedure is used to gain access to the interior of the Model 335D:

- a. Turn off power and remove line cord from ac outlet.
- b. Unfasten two Dzus fasteners on rear panel.
- c. Unfasten four Dzus fasteners on calibration access panel on top cover and lift off top calibration access panel. See Figure 4-1.
- d. Set instrument vertically on handles and withdraw outside cover while guiding ac power cord through hole in rear of outside cover. See Figure 4-2
- e. To remove inner top cover from instrument unscrew ten screws securing inner top cover to chassis and remove cover. See Figure 4-3.
- f. To remove inner bottom cover from instrument unscrew nine screws securing inner bottom cover to chassis and remove cover.
- g. The instrument is assembled in its covers and case by reversal of the disassembly procedure.

4-9. Located parallel to the left side of the instrument chassis and behind the second bulkhead is the A9 Extender P/C Board. This board is used as an extender for the plug-in circuit boards to provide access for adjusting and testing. The extender board is substituted for the board to be adjusted or tested with the removed board plugged into the receptacle at the top of the extender board. All vertically mounted printed circuit boards behind the second bulkhead are removable by exerting a combined rocking and pulling force on the board itself, but never by pulling on a component on the board. When replacing a printed circuit board, first ensure that the board is aligned within its two vertical guides. As it is inserted in place, next ensure that the mating receptacles are correctly aligned before pressing it into final position. The extender board also must be aligned properly to be installed in its storage connector with the land-side of the board facing internal of the instrument.

4-10. Removal of the top and/or bottom covers opens one or both power interlock switches. Hence, operation of the instrument without its cover (s) requires bypassing or cheating the interlocks. However, operation of the instrument without its case or without case and covers and with the interlocks cheated raises the chassis to the + OUTPUT potential and is extremely hazardous. Use utmost caution when working on the instrument with its case and/or cover (s) removed.

4-11. Unique Maintenance Procedures

4-12. CLEAN BOARDS. Certain circuit board assemblies are ultrasonically cleaned at the factory to prevent the possibility of electrical leakage, caused by contamination from handling during assembly. These circuit board assemblies include the Null Detector Amplifier P/C Assembly (A6A2), Sample String P/C Assembly (A2), and Capacitor P/C Assembly (A1). When components are replaced on these assemblies that require soldering, the land pattern side of the board should be cleaned as described in paragraph 4-14. Should contamination be suspected on the component side of the circuit board, use Freon TF Degreaser (Miller-Stephenson Chemical Co.).

4-13. PHOTOCCELL REPLACEMENT. Should the photocell assembly on the Null Detector Amplifier P/C Assembly (A6A2) have to be replaced, be very careful not to contaminate the photocell assembly or the plastic light transmission rods. The recommended procedure is to wear clean white gloves when handling them. Should the photocell assembly or plastic rods become contaminated, clean them with ethyl alcohol, then with deionized water

and air dry. When replacing the photocell assembly, insure that the plastic rods are tight against the neon lamps and photocells.

4-14. CIRCUIT BOARD SEALANT. The land pattern side of all printed circuit boards within the instrument have been coated with epocast (a polyurethane resin) to inhibit fungus growth and moisture absorption. When soldering to a printed circuit land, the heat from the soldering iron decomposes the epocast resin, leaving a charred residue. Upon completion of soldering, this residue should be removed with a solvent, such as toluol.

CAUTION!

The following precautions should be adhered to when using toluol: avoid inhaling the vapors, avoid excessive contact with the skin, and keep away from open flames. Insure that plastic components do not come into contact with toluol, since it will dissolve most types of plastic.

After removal of the epocast residue, the affected area should be recoated with a sealant. A spray can of Circuit Coat (Furane Plastic Inc., 4516 Brazil Street, Los Angeles, California or 16 Spielman Road, Fairfield, New Jersey) may be used for recoating.

4-15. Fuse Replacement

4-16. The fuses are contained in bayonet type fuse holders located at the rear of the instrument. Listed below are the correct values for the fuses:

| REF DESIGN | FUNCTION | TYPE |
|------------|--------------|--|
| F1 | High Voltage | 1/4A, slow blow |
| F2 | Line | 3A, slow blow, 115V conn. 1-1/2A, slow blow, 230V conn. |

Under no circumstances should replacement fuses with higher current ratings be installed in the instrument.

4-17. Lamp Replacement

4-18. The indicator lamps are located immediately behind the front panel. The instrument may be partially

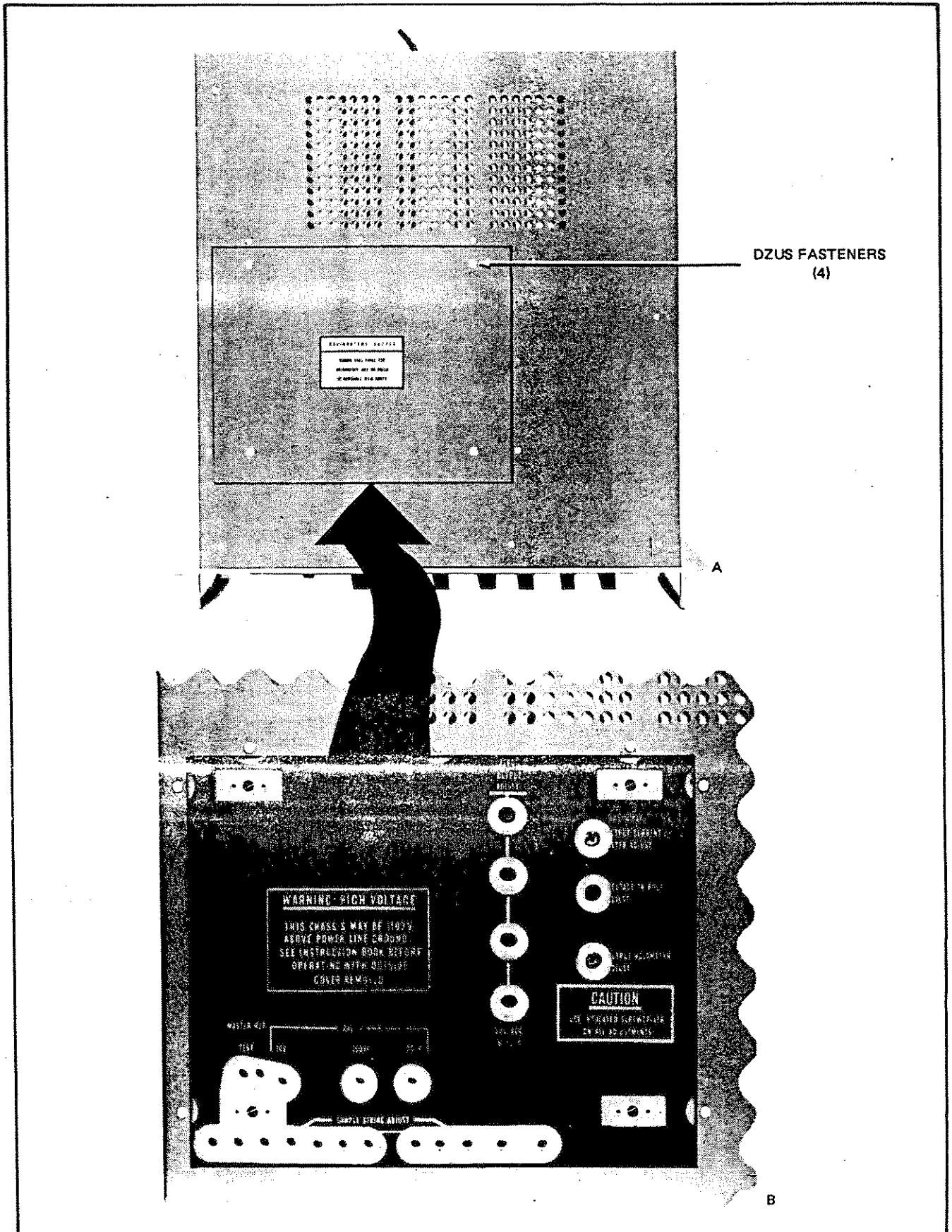

Figure 4-1. CALIBRATION ACCESS PANEL, INSTALLED (A) AND REMOVED (B)

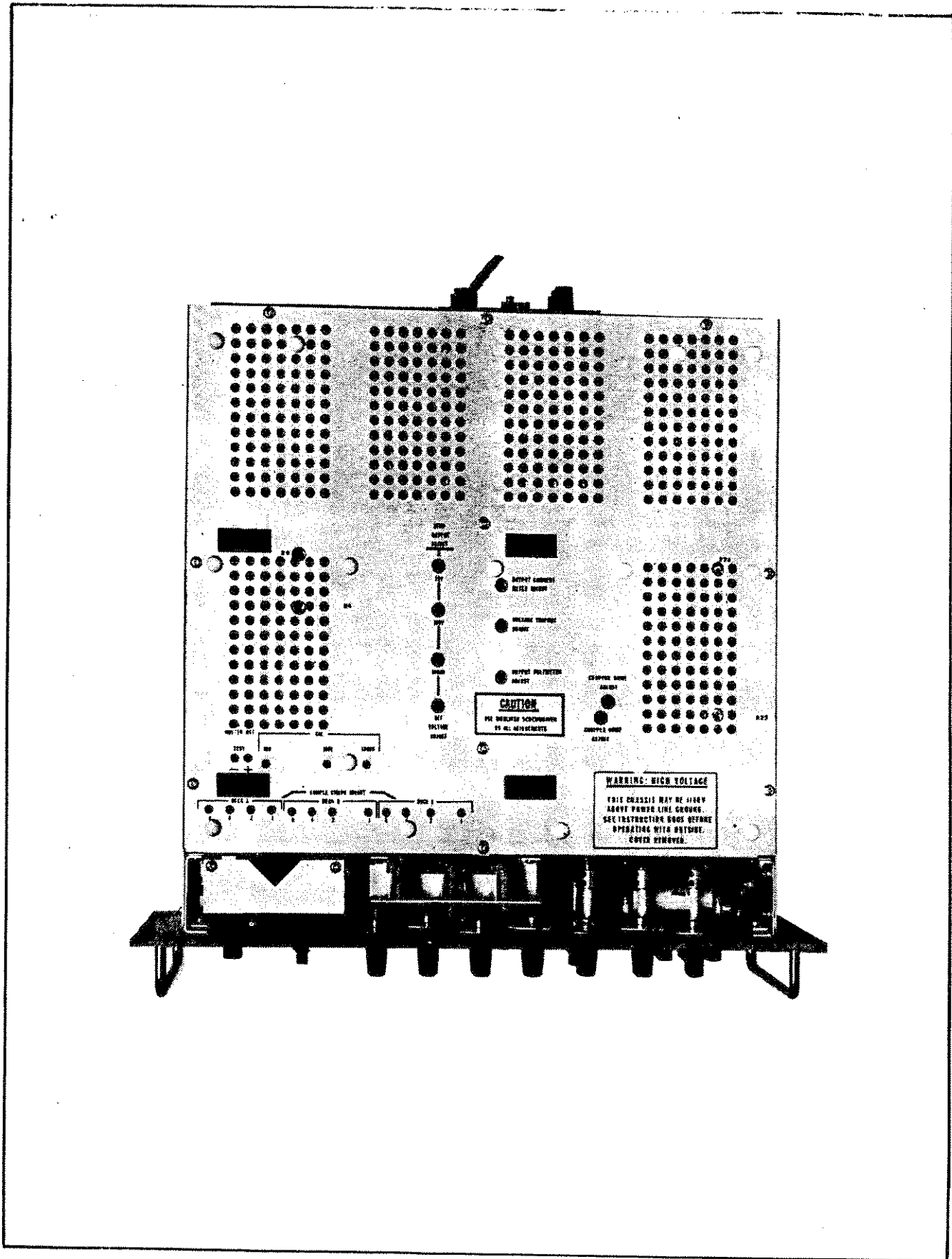

Figure 4-2. OUTSIDE COVER REMOVED

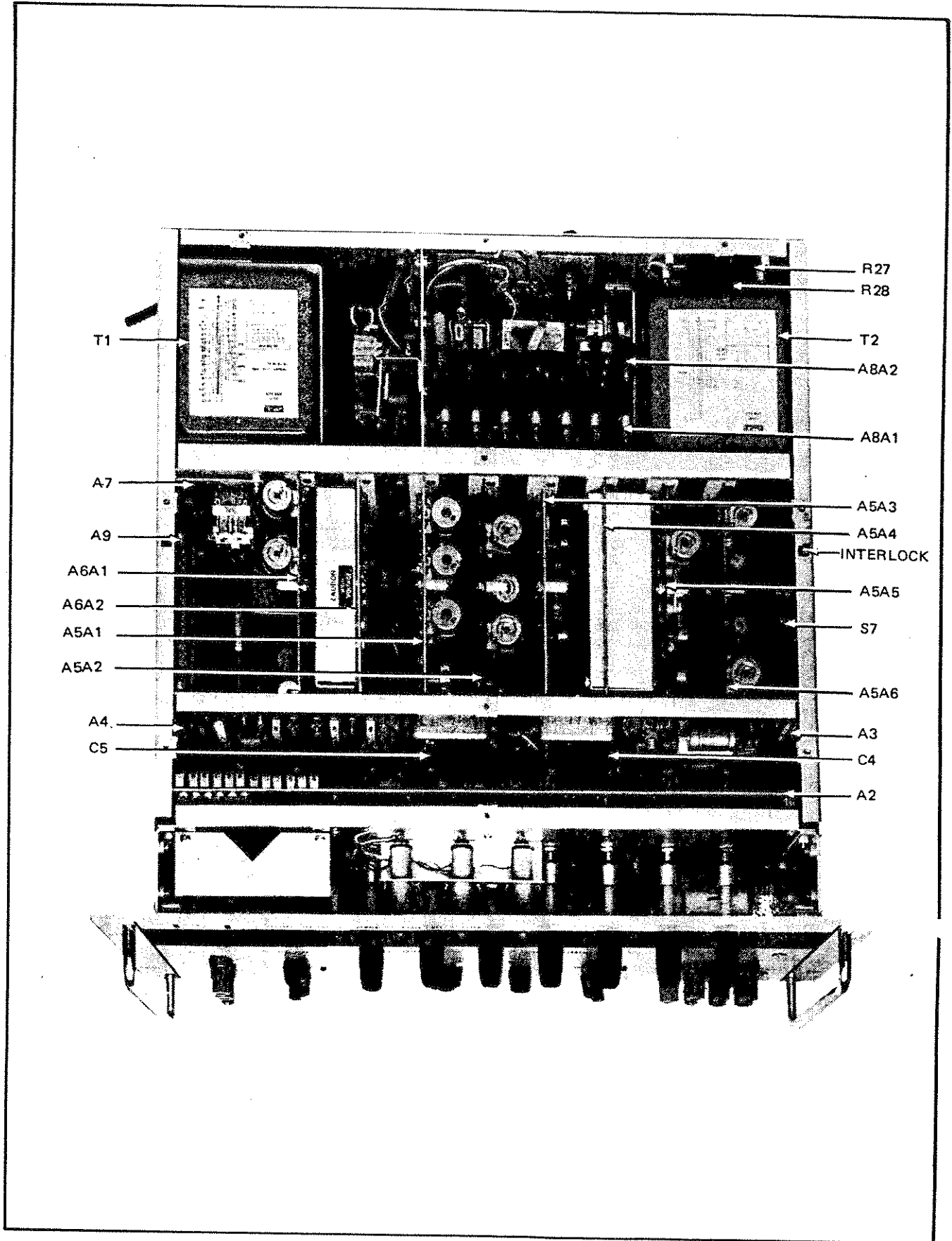

Figure 4-3. INNER TOP COVER REMOVED

removed from the case to gain access to the lamps. The decimal lamps are easily accessible and removable from the top of the instrument without the need of any special tools. To replace either the over current-voltage lamp or the operate lamp, remove the screw securing the lamp holder to its mounting, then remove the bayonet base lamp.

4-19, 115/230V Conversion

4-20. Depending upon the connection of the power transformers primary windings, the instrument may be operated from either a 115 or 230 volt ac power line. To convert it from one type of power line operation to the other, use the following procedure:

- Disconnect the line cord from the power line.
- Remove the instrument from the case and place upside down on a suitable work space.
- Orient the instrument and perform the appropriate electrical connections as illustrated in Figure 4-4.
- Use the proper fuse corresponding to the selected conversion, as discussed in paragraph 4-15.

4-21. PERFORMANCE TESTS

4-22. Introduction

4-23. The following tests are intended for checking the performance of the Model 335D. These tests may be used for incoming inspection, periodic inspections, and precalibration checks. It is recommended that these tests be performed prior to each calibration.

4-24. The tests in paragraphs 4-29 through 4-45 are divided into two groups: those associated with the voltage standard and those associated with the voltmeter portion of the instrument. In each case, a short introductory paragraph, prior to each test, briefly describes the purpose of each test and the circuitry involved. An understanding of the purpose of each test and the circuitry involved should aid the technician in analyzing a malfunction.

4-25. During the following tests, it will not be necessary to remove the instrument from the case. All external equipment will be connected to the terminals provided on the instrument. Table 4-1 lists the equipment needed for testing and calibrating.

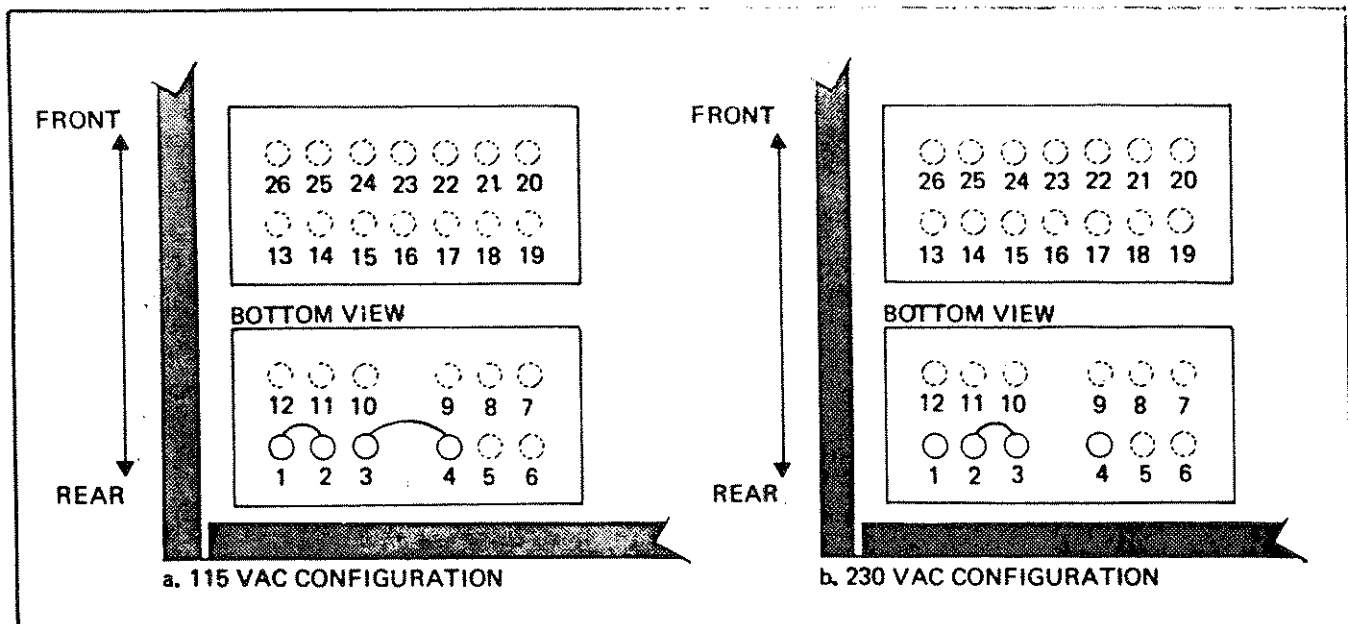

Figure 4-4 115/230 VAC CONVERSION

| EQUIPMENT REQUIRED | SPECIFICATIONS REQUIRED |
|---|---|
| Volt/Ohmmeter - RCA Voltohmyst or equivalent. | DC Accuracy of $\pm 3\%$ and input impedance of $10M\Omega$. |
| Metered Autotransformer - General Radio Variac W5MT3A or equivalent | Output of 0 to 130 vac at 3 amperes. |
| DC Differential Voltmeter - Fluke Model 895A | DC Accuracy of $\pm 0.0025\%$ with 100 uv null detector. |
| RMS Voltmeter - Fluke Model 931B or equivalent. Preamplifier | Accuracy of $\pm (0.05\%$ of input $+ 0.005\%$ of range) from 30 Hz to 50 kHz. Gain of 1000 and bandpass of 20 Hz to 30 kHz. |
| Oscilloscope - Tektronix Type 541 or equivalent. Preamplifier - Tektronix Type D | General purpose. 1 mv/cm sensitivity |
| General Purpose Power Supply | Provide 5.5 volts. |
| DC Milliammeter | 0 to 100 milliamperes $\pm 5\%$. |
| Load Resistor Box - Clarostat 240-C | Resistance range of 20 to $20,000\Omega$ at $\pm 5\%$. Capable of handling up to 80 watts. |
| Resistor, Composition | $100k\Omega \pm 5\%$, 1/2w |
| Lead Set | Low-leakage; low-thermal emf |
| Standard Cell Enclosure - Guildline Model 9152 | Accuracy of $\pm 0.0003\%$. |
| DC Voltage Calibration System - Fluke Model 7101B consisting of the following equipment, or an equivalent system: Voltage Standard, Model 332B Null Detector, Model 845AR Voltage Divider, Model 750A Kelvin-Varley Voltage Divider, Model 720A | Capable of measuring 0.1 to 1100 vdc with 5 ppm accuracy. |

Table 4-1. TEST AND CALIBRATION EQUIPMENT REQUIRED

4-26. Voltage Standard

4-27. **GENERAL.** Since the load, line, and ripple checks do not rely on any calibration adjustments, a major or minor out of tolerance indication should be investigated by troubleshooting. The remaining voltage standard checks do rely on proper calibration adjustments. Should minor out of tolerance indications be observed during these checks, calibration will more than likely correct these problems. However, should the calibration adjustments be ineffectual or at their extreme limits, you will have to investigate the cause of the problem.

4-28. In the event that a malfunction is discovered, complete as many of the performance tests as possible. Record which tests the instrument does not successfully pass and any abnormal indications. This will help in analyzing the problem and lead to more efficient troubleshooting.

4-29. **LINE REGULATION.** The line regulation test determines whether the output voltage will remain constant, within specified limits, for a low to high line input power change.

a. Connect the line cord through an auto-transformer connected to an ac power line. Set the auto-transformer to 115 volts ac.

b. Set the front panel controls as follows:

| | |
|-------------|-------------|
| POWER | STDBY/RESET |
| NULL ZERO | OPR |
| INPUT MODE | TVM |
| SENSITIVITY | I |

| | |
|---------------|----------------|
| RANGE | 10 |
| Readout | All Zero |
| TRIP | 1000 |
| VERNIER | Clockwise |
| CURRENT LIMIT | Clockwise (60) |

Terminal Connections - See Figure 2-2 (a).

c. Connect the Model 895A to the SENSE terminals and set to plus polarity. Connect the 240-C Load Resistor Box to the OUTPUT terminals.

d. Set the RANGE switch, readout dials, and load box to the values indicated in the first group of settings in Table 4-2. Set the POWER switch to the OPR position. Note the voltage indicated on the Model 895A. Set the autotransformer to low line (103V). The output voltage change, indicated on the Model 895A, should not exceed the specification listed in Table 4-2. Return the autotransformer setting to nominal line (115V). Note the voltage indication on the Model 895A. Set the autotransformer to high line (127V). The voltage change, indicated on the Model 895A, should not exceed the specification. Repeat this procedure for each group of settings in Table 4-2.

4-30. **LOAD REGULATION.** The load regulation test determines if the output voltage will remain constant, within specified limits, when the output is subjected to a no-load to full-load condition.

a. Connect the line cord to an autotransformer connected to an ac power line. Set the autotransformer to 115 volts ac.

| RANGE | READOUT | LOAD (50 ma) | SPEC. |
|-------|-----------|--------------|--------|
| 10 | 1.000000 | 20Ω | 10 uv |
| 10 | 10.000000 | 200Ω | 20 uv |
| 100 | 10.00000 | 200Ω | 20 uv |
| 100 | 100.00000 | 2000Ω | 200 uv |
| 1000 | 100.0000 | 2000Ω | 200 uv |
| 1000 | 1000.0000 | 20,000Ω | 2.0 mv |

Table 4-2. CONTROL SETTINGS, LOAD REQUIREMENTS, AND LIMITS FOR LINE REGULATION

b. Set the front panel controls as follows:

| | |
|---------------|----------------|
| POWER | STDBY/RESET |
| NULL ZERO | OPR |
| INPUT MODE | TVM |
| SENSITIVITY | I |
| RANGE | 10 |
| Readout | All Zero |
| TRIP | 1000 |
| VERNIER | Clockwise |
| CURRENT LIMIT | Clockwise (60) |

| | |
|---------------|----------------|
| NULL ZERO | OPR |
| INPUT MODE | TVM |
| SENSITIVITY | I |
| RANGE | 10 |
| Readout | All Zero |
| TRIP | 1000 |
| VERNIER | Clockwise |
| CURRENT LIMIT | Clockwise (60) |

Terminal Connections - See Figure 2-2 (a).

Terminal Connections - See Figure 2-2 (a).

c. Connect the Model 895A to the SENSE terminals.

d. Set the RANGE switch and Readout Dials to the values indicated in the first group of settings listed in Table 4-3. Set the POWER switch to the OPR position. Note the voltage indicated on the Model 895A. Connect the 20-ohm load to the OUTPUT terminals of the instrument, and note the output voltage change on the Model 895A. This change should not exceed the specification listed in the chart. Repeat this step for each group of settings.

e. Repeat step d. for low line (103V) and high line (127V).

4-31. RIPPLE. The ripple test determines if the rms value of the super-imposed ac component, on the dc output is within specified limits.

a. Connect the preamplifier to the OUTPUT terminals. Connect the Model 931 RMS Voltmeter to the output of the preamplifier.

b. Set the front panel controls as follows:

| | |
|-------|-------------|
| POWER | STDBY/RESET |
|-------|-------------|

c. With the autotransformer set to nominal line voltage (115 Vac), set the POWER switch to OPR. The ripple indicated on the Model 931B should not exceed 20 microvolts rms (Indication is via 1000X amplifier).

d. Set the readout dials to 10 volts. The ripple indicated on the Model 931B should not exceed 20 microvolts rms.

e. Connect the 200-ohm load resistor to the OUTPUT terminals. The ripple indicated on the Model 931B should not exceed 20 microvolts rms. Disconnect the load resistor.

f. Set the readout dials to zero, and set the RANGE switch to 100. The ripple indicated on the Model 931B should exceed 30 microvolts rms.

g. Set the readout dials to 100 volts. The ripple indicated on the Model 931B should not exceed 30 microvolts rms.

h. Connect the 2,000-ohm load resistor to the OUTPUT terminals. The ripple indicated by the Model 931B should not exceed 30 microvolts rms. Disconnect the load resistor.

i. Set the readout dials to zero, and set the RANGE

| RANGE | READOUT | LOAD (50 ma) | SPEC. |
|-------|-----------|--------------|--------|
| 10 | 1.000000 | 20Ω | 10 uv |
| 10 | 10.00000 | 200Ω | 20 uv |
| 100 | 10.00000 | 200Ω | 20 uv |
| 100 | 100.00000 | 2000Ω | 200 uv |
| 1000 | 100.0000 | 2000Ω | 200 uv |
| 1000 | 1000.0000 | 20,000Ω | 2.0 mv |

Table 4-3. CONTROL SETTINGS, LOAD REQUIREMENTS, AND LIMITS FOR LOAD REGULATION

switch to 1000. The ripple indicated on the Model 931B should not exceed 40 microvolts rms.

- j. Set the readout dials to 1000 volts. The ripple indicated on the Model 931B should not exceed 40 microvolts rms.
- k. Connect the 20,000-ohm load resistor to the OUTPUT terminals. The ripple indicated on the Model 931B should not exceed 40 microvolts rms. Disconnect the load resistor.

4-32. **VOLTAGE STANDARD ACCURACY.** If the voltage standard has successfully passed the line, load, and ripple specifications, it can be assumed to be operating correctly. The output voltage can now be checked and compared to the accuracy specifications. These checks should be accomplished after the unit has warmed up for 1 hour at standard reference conditions of $23^{\circ}\text{C} \pm 1^{\circ}\text{C}$, up to 70% relative humidity, and constant line voltage. One method of checking the instruments accuracy is by comparing the output voltages to a standard cell by means of a reference divider. Use the equipment and connections shown in Figure 4-8 and the procedure of paragraph 4-65, steps l. through t.

4-33. Meter and Protection Circuits

4-34. **V - I MONITOR.** This check investigates the circuitry involved with monitoring and displaying, on the front-panel meter, the output voltage and current.

- a. With the SENSITIVITY switch in the "V" position, set the RANGE switch and readout dials for 100 volts output.
- b. The front-panel meter should indicate 100 volts ± 3.0 volts.
- c. Check the meter linearity at the following cardinal points, Table 4-4. All meter indications should be within $\pm 3\%$ of full scale.

| RANGE | READOUT |
|-------|-------------|
| 10 | 1.000000 |
| 100 | 10.000000 |
| 1000 | 100.000000 |
| 10 | 10.000000 |
| 1000 | 1000.000000 |

Table 4-4. CONTROL SETTINGS FOR V-1 MONITOR TEST

- d. Set the RANGE switch to 10 volts, the readout dials to 5 volts, the CURRENT LIMIT control maximum clockwise, and the SENSITIVITY switch to "I".
- e. Connect a 0 to 100 dc milliammeter across the OUTPUT terminals.
- f. Rotate the CURRENT LIMIT control counter-clockwise until the external meter indicates 50 milliamperes. The front-panel meter should also indicate 50 milliamperes on the red scale.
- g. Set the RANGE switch to 100 volts then to 1000 volts. The front-panel meter should indicate 50 milliamperes in each position of the RANGE switch.

4-35. **CURRENT LIMIT.** This check determines the range of the CURRENT LIMIT control, which should be from 0.5 to 60 milliamperes.

- a. Set the POWER switch to STDBY/RESET, the RANGE switch to 10 volts, the readout dials to 5 volts, and the CURRENT LIMIT control maximum clockwise.
- b. Connect a 0 to 100 dc milliammeter across the output terminals.
- c. Set the POWER switch to OPR. The external meter should indicate 60 milliamperes.
- d. Rotate the CURRENT LIMIT control maximum counter-clockwise. The external meter should indicate 0.5 milliamperes.

4-36. **VOLTAGE TRIP.** This test determines if the trip circuit will actuate during an overvoltage condition, on each RANGE setting.

- a. Set the TRIP VERNIER maximum clockwise. Set the RANGE, TRIP, and readout dials to the values indicated in Table 4-5. In each case, rotate the VERNIER counter-clockwise from the maximum clockwise position until the trip circuitry just actuates. In each case, the VERNIER control should be approximately 30° from the maximum clockwise position.
- b. Set the output of the instrument for 4 volts on the 10 volt range. Set the TRIP switch to the 10 volt

| RANGE | TRIP | READOUT DIALS |
|-------|------|---------------|
| 10 | 10 | 10.X00000 |
| 100 | 100 | 10X.00000 |
| 1000 | 1000 | 10XX.X00 |

Table 4-5. CONTROL SETTINGS FOR VOLTAGE TRIP CHECK

position and the VERNIER control to the 12 o'clock position.

- c. Set the RANGE switch to 100 volts. The trip circuit should actuate.
- d. Set the TRIP switch to the 100 volt position and reset the instrument.
- e. Set the RANGE switch to the 1000 volt position. The trip circuit should actuate.
- f. Set the TRIP switch to the 1000 volt position and the VERNIER control maximum clockwise. Reset the instrument.
- g. Set the RANGE switch to 100 volts then to 10 volts. The trip circuit should not actuate in either position.

4-37. Voltmeter

4-38. GENERAL. A good indication of correct operation of the null detector is the electrical zero test. Should the instrument fail this test, you should investigate the cause of the problem.

4-39. LEAKAGE RESISTANCE. This test determines if the isolation between the LO INPUT terminal and ground, in the TVM mode, is at least 10^{12} ohms.

- a. Disconnect the Model 335D from the power line and connect to the Models 415B and 845AR, as illustrated in Figure 4-5, with teflon coated leads.
- b. Connect a 100 kilo-ohm ($\pm 5\%$) 1/2 watt resistor across the INPUT and COMMON terminals of the Model 845AR.
- c. Set the Model 845AR POWER switch to ON and the RANGE switch to 100 microvolts. Set the INPUT MODE switch to TVM and insure that the VM AC COMMON terminal is linked to (ground).
- d. Apply 1000 volts from the Model 415B.

- e. The indication on the Model 845AR should not exceed 100 microvolts. This indicates that the isolation is 10^{12} ohms or greater.
- f. Return the Model 415B to zero output and remove all equipment interconnections.

4-40. MECHANICAL ZERO. With the instrument still de-energized, adjust mechanical zero screw (located just below the meter) so that the meter pointer is over the center scale zero position.

4-41. ELECTRICAL ZERO. Connect the instrument to the power line and set the POWER switch to the STDBY/RESET position. Proceed as follows:

- a. Set the controls as follows:

| | |
|---------------|----------|
| Readout Dials | All Zero |
| INPUT MODE | TVM |
| NULL ZERO | ZERO |
| SENSITIVITY | 10 uv |

- b. Rotate the NULL ZERO control through its full range. The meter pointer should deflect a total of 16 microvolts.
- c. Set the meter pointer over the center scale zero position with the NULL ZERO control.
- d. Observe the meter pointer for a period of 10 seconds. The peak-to-peak excursions of the pointer should not exceed 0.5 microvolts.

4-42. VOLTMETER ACCURACY. The null detector accuracy can now be checked. Place the INPUT MODE switch in the TVM position. Known voltages may be applied to the INPUT terminals to check the null detector at the desired cardinal points. Null Detector accuracy is $\pm 3\%$ of full scale.

4-43. The differential voltmeter operation may also be checked for accuracy by placing the INPUT MODE switch in the DIFF \pm positions. When doing so, observe the same standard reference conditions used for checking the voltage standard accuracy.

4-44. RECORDER OUTPUT VOLTAGE

- a. With the INPUT MODE switch to the TVM position, set the SENSITIVITY switch to the 1 milli-

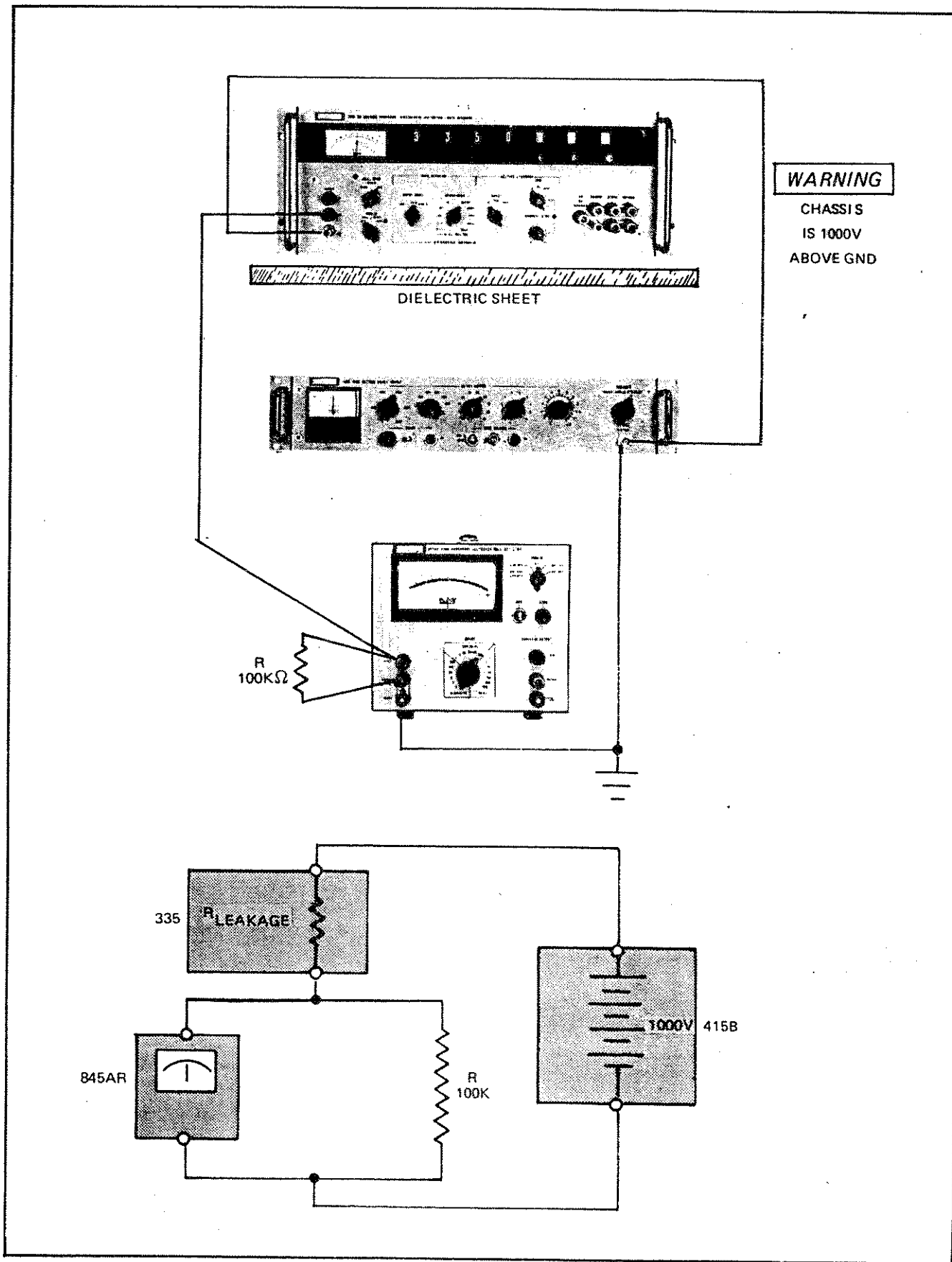

Figure 4-5. LEAKAGE RESISTANCE TEST CONNECTIONS

volt position and apply one millivolt to the INPUT terminals. The meter should deflect full scale.

- b. Connect a Model 895A to the RECORDER OUTPUT terminals.
- c. Vary the RECORDER OUTPUT ADJUST to both extremes. The voltage at the RECORDER OUTPUT terminals should vary from 0 to over 1 volt (typically 1.2 volts).
- d. Disconnect the Model 895A and the 1 millivolt source.

4-45. RECORDER OUTPUT GROUND ISOLATION

- a. With the INPUT MODE switch in the TVM position, set the SENSITIVITY switch to the 10 microvolt position and apply 10 microvolts to the INPUT terminals. Adjust recorder output for 1.0 volt.
- b. Apply ± 100 volts, from the Model 335D OUTPUT terminals, between the LO₁ and (ground) RECORDER OUTPUT terminals.
- c. The change in deflection on the front-panel meter should be less than 0.5 microvolts.
- d. Remove connections.

4-46. CALIBRATION

4-47. Introduction

4-48. The following procedures are intended for calibration. The equipment required is listed in Table 4-1. During the first portion of the calibration procedure, the instrument will have to be removed from its case. Refer to paragraph 4-8 for maintenance access procedures. The top inner cover will also have to be removed. However, upon removal of the top inner cover it will be necessary to "cheat" the interlock located on the top right-hand edge of the instrument chassis.

WARNING!

The inner chassis is at + OUTPUT potential
Lethal voltages exist between inner chassis and front panel.

4-49. Voltmeter

4-50. MECHANICAL ZERO. With the instrument de-energized for at least 3 minutes, adjust the mechanical zero screw (located just below the front-panel meter) so that the meter pointer is over the center scale zero position.

4-51. NULL DETECTOR DRIVE FREQUENCY. Extend the Null Detector Power Supply P/C Assembly (A6A1) on the extender card provided. Set the POWER switch to STDBY/RESET and allow approximately one minute for warm-up. Proceed as follows:

- a. Set the oscilloscope vertical input to 20 volts/centimeter and the horizontal sweep for 2 milliseconds/centimeter.
- b. Connect the oscilloscope between the collectors of Q1 and Q2.
- c. Refer to Figure 4-6 and adjust R4 until the period of the square wave is 11.9 milliseconds.

4-52. NULL SENSITIVITY ADJUST. Proceed as follows:

- a. Adjust the meter electrical zero. Set the INPUT MODE switch to TVM, the SENSITIVITY switch to 1 millivolt, and NULL ZERO to OPR.
- b. Apply +1 millivolt to the INPUT terminals.
- c. Refer to Figure 4-6 and adjust R9 for a full-scale meter deflection $(1.0) \pm 1/2$ a small division.
- d. Apply -1 millivolt to the INPUT terminals. The meter pointer should deflect full-scale to the left of zero $\pm 1/2$ a small division.
- e. Apply to each of the remaining SENSITIVITY ranges, the corresponding voltage that will cause a full-scale deflection. In each case, the meter pointer should deflect full-scale, ± 1 small division.

4-53. Voltage Standard

4-54. AUXILIARY POWER SUPPLY. With POWER switch in the OFF position, connect the Model 335D through an autotransformer to the power line. Adjust the autotransformer for nominal line voltage. Extend the Auxiliary Power Supply P/C Assembly (A5A5) on the extender card provided. Set the POWER switch to the

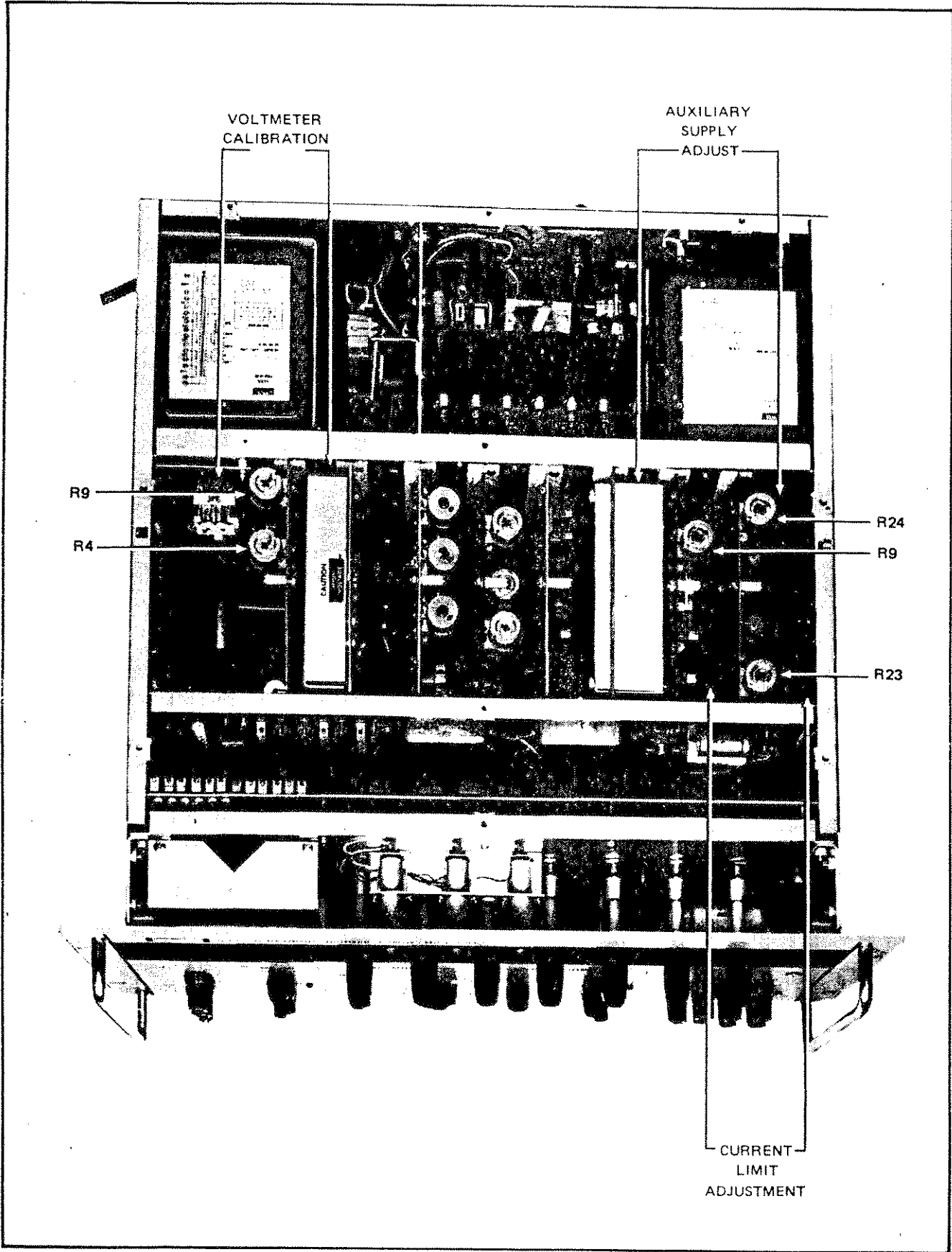

Figure 4-6. LOCATION OF ADJUSTMENTS

STDBY/RESET position. Allow approximately 10 minutes for warm-up; then proceed as follows:

- a. Using the +SENSE terminal as common, connect a Model 895A to pin 10 on the Auxiliary Power Supply P/C Assembly.
- b. Referring to Figure 4-6, adjust R9 until the Model 895A indicates 25 volts, ± 10 millivolts.
- c. While varying the line voltage from 100 to 130 volts ac, the Model 895A indication should not change more than 40 millivolts.
- d. Set the POWER switch to OFF. Disconnect the Model 895A. Replace the Auxiliary Power Supply P/C Assembly. Return the POWER switch to the STDBY/RESET position.

4-55. CURRENT LIMIT. Proceed as follows:

- a. Set the controls as follows:

| | |
|---------------|-------------------|
| POWER | STDBY/RESET |
| RANGE | 10 |
| Readout Dials | 5.0 0 0 0 0 0 |
| TRIP | 1000 |
| VERNIER | Maximum Clockwise |
| CURRENT LIMIT | Maximum Clockwise |

- b. Connect a 0 to 100 dc milliammeter across the OUTPUT terminals. Set the POWER switch to OPR.
- c. Referring to Figure 4-6, adjust R23 for a 60 milliampere indication on the external meter.
- d. Rotate the CURRENT LIMIT control maximum counter-clockwise. Referring to Figure 4-6, adjust R24 for a 0.5 milliampere indication on the external meter.
- e. If necessary, readjust R23 and R24 until the range of the CURRENT LIMIT control is from 0.5 to 60 milliamperes.
- f. Set the POWER switch to STDBY/RESET. Replace the top inner cover on the Model 335D.

4-56. OUTPUT CURRENT MONITOR. Proceed as follows:

- a. Set the SENSITIVITY switch to "1".

- b. Adjust the CURRENT LIMIT control to obtain a 50 milliampere indication on the external meter.
- c. Rotate the adjustment labelled OUTPUT CURRENT METER ADJUST until the front-panel meter pointer indicates 50 milliamperes on the red scale.
- d. Set the RANGE switch to 100 volts; then to 1000 volts. The front-panel meter should indicate 50 milliamperes in each position of the RANGE switch.
- e. Set the POWER switch to STDBY/RESET. Remove the external meter connections from the instrument.

4-57. OUTPUT VOLTAGE MONITOR. Proceed as follows:

- a. Set the front panel controls as follows:

| | |
|---------------|------------------------|
| SENSITIVITY | V |
| RANGE | 100 |
| Readout Dials | <u>10</u> 0. 0 0 0 0 0 |

- b. Rotate the adjustment labelled OUTPUT VOLT-METER ADJUST until the front-panel meter indicates 100 volts ± 0.5 volts.
- c. Meter linearity may be checked at the cardinal points listed in Table 4-6. All full-scale meter indications should be within $\pm 3\%$ of the readout dial settings.

| RANGE | READOUT DIALS |
|-------|-------------------|
| 10 | 1.000000 |
| 100 | 10.00000 |
| 1000 | 100.0000 |
| 10 | <u>10</u> .000000 |
| 1000 | <u>1000</u> .0000 |

Table 4-6. CONTROL SETTINGS FOR VOLTAGE MONITOR LINEARITY CHECK

4-58. VOLTAGE TRIP. Proceed as follows:

- a. Set the controls as follows:

| | |
|---------------|-----------------|
| RANGE | 100 |
| Readout Dials | 10 X. 0 0 0 0 0 |

| | |
|---------------------------------------|-------------------------------|
| VOLTAGE TRIPOUT ADJUST (top cover) | maximum counter- clockwise |
| TRIP | 100 |
| VERNIER | 30° from maximum clockwise |

- b. Rotate the VOLTAGE TRIPOUT ADJUST until the output is de-energized, as indicated by the illumination of the red indicator lamp and the audible "click" of relays.
- c. Set the POWER switch to STDBY/RESET. Rotate the VERNIER control to the maximum clockwise position.
- d. Set the POWER switch to OPR. Set the RANGE switch, TRIP switch, and readout dials as listed in Table 4-7. Check the trip action on each range by rotating the VERNIER control counter-clockwise. The trip point should occur in each RANGE switch position when the VERNIER control is approximately 30° from the maximum clockwise position.

| TRIP | RANGE | READOUT DIALS |
|------|-------|---------------|
| 10 | 10 | 10.X00000 |
| 1000 | 1000 | 10 X X.X000 |

Table 4-7. CONTROL SETTINGS FOR TRIP RANGE CHECK

4-59. MASTER REFERENCE. Proceed as follows:

- a. Set the controls as follows:

| | |
|---------------|-------------------|
| POWER | OPR |
| RANGE | 1000 |
| Readout Dials | 00X.0000 |
| TRIP | 1000 |
| VERNIER | Maximum Clockwise |
| CURRENT LIMIT | Maximum Clockwise |

- b. Connect a Model 895A to the MASTER REFERENCE TEST points through the top inner cover.
- c. Adjust CAL 1000V, CAL 100V, and CAL 10V mechanically to mid-point of travel.
- d. Rotate R9 on Reference Supply pcb to obtain an indication of 15.00 volts (± 10 uV) on the Model 895A.

- e. Set the POWER switch to STDBY/RESET.

4-60. Voltage Standard Output

4-61. The voltage standard is calibrated by setting the zero output and adjusting the sample string resistors and the range resistors. Adjustment of sample string resistors determines output voltage ratio accuracy and adjustment of the range resistors determines absolute voltage accuracy. The linearization adjustment involves adjusting corresponding resistors in adjacent decades so they are in exact ten-to-one ratio with each other.

4-62. This procedure is divided into sections, initial and final. Both procedures are to be performed if any servicing has been done. The Final Calibration need only be done if the instrument is operating normally and requires certification.

4-63. INITIAL CALIBRATION. The following adjustments should be performed whenever repairs have been made to the Model 335D. After completion, however, the adjustments given under Final Calibration must also be done.

4-64. The instrument should be warmed-up for at least one hour at standard reference conditions of $23^\circ \pm 1^\circ\text{C}$, up to 70% relative humidity and constant line voltage before adjustments are made. The instrument must be operated in its case with the RANGE switch and readout dials set for 100 volts output.

- a. Set the Model 335D controls as follows:

| | |
|---------------|-------------------|
| POWER | ON |
| RANGE | 1000 |
| Readout Dials | 00X.0000 |
| TRIP | Maximum Clockwise |
| CURRENT LIMIT | Maximum Clockwise |

- b. Connect a Model 895A to the MASTER REFERENCE test points through the top inner cover.
- c. Rotate R9 on Reference Supply pcb to obtain an indication of 15.00 volts (± 10 uV) on the Model 895A.
- d. Connect a Model 895AR null detector across the OUTPUT terminals. Set the voltage standard dial readout to all zeros and the POWER switch to OPR.
- e. At each RANGE switch position, vary the corre-

sponding ZERO OUTPUT ADJUST (10V, 100V, 1000V) for a null indication (± 2 microvolt) on the null detector.

- f. Connect the 895A to the OUTPUT terminals of the 335D with the voltmeter common connected to the positive (+) output.
- g. Set RANGE switch and decades on the 335D as listed in Table 4-8. Null the 895A reading or adjust the specified Sample String adjustment potentiometer as required.

| Range | Dial Setting | Adjust 895A to: | Adjust * | |
|-------|--------------|-----------------|----------|----------|
| 1000 | 00 0X 00 0 | Null Reading | -- | C Decade |
| 1000 | 00 10 00 0 | ----- | 1 | |
| 1000 | 00 1X 00 0 | Null Reading | -- | |
| 1000 | 00 20 00 0 | ----- | 2 | |
| 1000 | 00 3X 00 0 | Null Reading | -- | |
| 1000 | 00 40 00 0 | ----- | 4 | |
| 1000 | 00 7X 00 0 | Null Reading | -- | B Decade |
| 1000 | 00 80 00 0 | ----- | 8 | |
| 1000 | 00 X0 00 0 | Null Reading | -- | |
| 1000 | 01 00 00 0 | ----- | 1 | |
| 100 | 01 X0 00 0 | Null Reading | -- | |
| 100 | 02 00 00 0 | ----- | 2 | |
| 100 | 03 X0 00 0 | Null Reading | -- | A Decade |
| 100 | 04 00 00 0 | ----- | 4 | |
| 100 | 07 X0 00 0 | Null Reading | -- | |
| 100 | 08 00 00 0 | ----- | 8 | |
| 100 | 0X 00 00 0 | Null Reading | -- | |
| 100 | 10 00 00 0 | ----- | 1 | |
| 10V | 1X 00 00 0 | Null Reading | -- | A Decade |
| 10V | 20 00 00 0 | ----- | 2 | |
| 10V | 3X 00 00 0 | Null Reading | -- | |
| 10V | 40 00 00 0 | ----- | 4 | |
| 10V | 7X 00 00 0 | Null Reading | -- | |
| 10V | 80 00 00 0 | ----- | 8 | |

* Adjust the specified Sample String potentiometers to within $\pm 2\mu$ volts of the previous null reading.

Table 4-8. SAMPLE STRING PRE-LINEARIZATION

| 335D RANGE | 335D Dial Setting | Adjust 895A To: | Adjust |
|------------|-------------------|-----------------|-------------------|
| 10V | 10.0 00 00 0 | 10.0 00 00 | 10V CAL to null |
| 100V | 10. 00 00 0 | 10.0 00 00 | 100V CAL to null |
| 1000V | 01 0.0 00 0 | 10.0 00 00 | 1000V CAL to null |

Table 4-9. PRELIMINARY RANGE CALIBRATION

- h. Leave the 895A connected as in step f.
- i. Set the RANGE and decades on the 335D as listed in Table 4-9. Adjust the 895A to 10.0 00 00 volts. Adjust the range calibration pots (CAL) shown in Figure 4-2 as required.
- j. Set the Model 335D controls as follows:

| | |
|---------------|-------------------|
| POWER | STDBY/RESET |
| RANGE | 10 |
| Readout Dials | 5.000000 |
| TRIP | 1000 |
| VERNIER | Maximum Clockwise |
| CURRENT LIMIT | Maximum Clockwise |

- k. Connect a 0 to 100 dc milliammeter across the OUTPUT terminals. Set the POWER switch to OPR.
- l. Referring to Figure 4-6, adjust R23 for a 60 milli-ampere indication on the external meter.
- m. Rotate the CURRENT LIMIT control maximum counter-clockwise. Adjust R24 for approximately 0.5 milliampere indication on the external meter.
- n. If necessary, re-adjust R23 and R24 until the range of the CURRENT LIMIT control is from 0.5 to 60 milliamperes.
- o. Set the POWER switch to STDBY/RESET. Replace the top inner cover on the Model 335D.
- p. Set the METER switch to CURRENT and the POWER switch to OPR.
- q. Adjust the CURRENT LIMIT control to obtain a 50 milliampere indication on the external meter.
- r. Rotate the adjustment labeled output CURRENT METER ADJUST until the front-panel meter pointer indicates 50 milliamperes on the red scale.
- s. Set the RANGE switch to 100 volts; then to 1000 volts. The front-panel meter should indicate 50 milliamperes in each position of the RANGE switch.
- t. Set the POWER switch to STDBY/RESET. Remove the external meter connections from Model 335D.

u. Set the Model 335D front panel controls as follows:

POWER METER RANGE Readout Dials OPR VOLTAGE 100 100.00000

v. Rotate the adjustment labeled OUTPUT VOLT-METER ADJUST until the front-panel meter indicates 100 volts ±0.5 volts.

w. Meter linearity may be checked at the cardinal points listed on Table 4-10. All full-scale meter indications should be within ±3% of full scale

| RANGE | READOUT DIALS |
|-------|---------------|
| 10 | 1.000000 |
| 100 | 10.00000 |
| 1000 | 100.0000 |
| 10 | 10.000000 |
| 1000 | 1000.0000 |

Table 4-10. CONTROL, SETTINGS FOR VOLTAGE MONITOR LINEARITY CHECK

x. Set the Model 335D controls as follows:

RANGE 1000V
 Readout Dials 125.0000
 VOLTAGE TRIPOUT ADJUST (top cover) Maximum Counter-clockwise
 TRIP 100
 VERNIER Fully Clockwise

y. Rotate the VOLTAGE TRIPOUT ADJUST until the output is de-energized, as indicated by the illumination of the red indicator lamp and the audible "click" of relays.

z. Set RANGE to 10 and reset the instrument.

aa. Set the POWER switch to OPR. Set the RANGE switch, TRIP switch, and readout dials as listed in Table 4-11. Check the trip action on each range by rotating the VERNIER control counter-clockwise. The trip point should occur in each RANGE switch position when the VERNIER control is approximately 30° from the maximum clockwise position.

| TRIP | RANGE | READOUT DIALS |
|------|-------|---------------|
| 10 | 10 | 10.X00000 |
| 1000 | 1000 | 10XX.X000 |

Table 4-11. CONTROL SETTINGS FOR TRIP RANGE CHECK

ab. Set the output of the instrument for 4 volts on the 10 volt range. Set the VOLTAGE TRIP switch to the 10 volt position and the VERNIER control to the 12 o'clock position.

ac. Set the RANGE switch to 100 volts. The trip circuit should actuate.

ad. Set the VOLTAGE TRIP switch to the 100 volt position and reset the instrument.

ae. Set the RANGE switch to the 1000 volt position. The trip circuit should actuate.

af. Set the VOLTAGE TRIP switch to the 1000 volt position and the VERNIER maximum clockwise. Re-set the instrument.

ag. Set the RANGE switch to 100 volts then to 10 volts. The trip circuit should not actuate in either position.

4-65. FINAL CALIBRATION. The following procedure should be performed to accomplish the final linearization of the Sample String and the Range Calibration on the 335D.

a. Connect a Model 895AR null detector across the OUTPUT terminals. Set the voltage standard dial readout to all zeros and the POWER switch to OPR.

b. At each RANGE switch position, vary the corresponding ZERO OUTPUT ADJUST (10V, 100V, 1000V) for a null indication (±1 microvolt) on the voltmeter.

c. Self-calibrate the 720A using the procedure contained in its instruction manual.

d. Using the 7101B DC Voltage Calibration System make the equipment connections shown in Figure 4-7.

- e. Set the readout dials of the 720A to the standard cell voltage (e.g. ".1018000").
- f. Set switch S1 to position A.
- g. Adjust the output of the 335D (approximately 11 volts) for a null indication (± 1 microvolt) on the 845AR.
- h. Set OPERATE switch on 845AR to ZERO. Set switch S1 to position B.
- i. Set the RANGE and readout dials to the values listed in Table 4-12 and adjust the RANGE CAL or SAMPLE STRING ADJUST potentiometers as indicated.
- j. Repeat steps a. through h. of paragraph 4-65.
- k. Set the RANGE and readout dials to the values listed in Table 4-13 and adjust the RANGE CAL

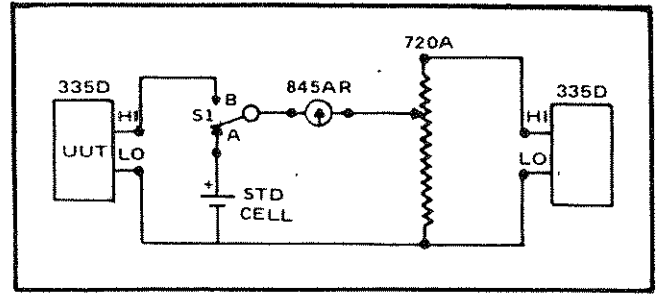

Figure 4-7. CONNECTIONS FOR SAMPLE STRING LINEARIZATION

potentiometers as indicated.

NOTE!

The calibration of the 335D should now be checked to ensure that it meets the accuracy specifications.

- l. Using the 7101B DC Voltage Calibration System make the equipment connections shown in Figure 4-8.

| STEP | 720 SETTING | 335D RANGE | 335D DIAL SETTING | NULL ADJUSTMENT | 845AR NULL |
|------|--------------|------------|-------------------|-----------------|---------------|
| 1 | 0000000 | 1000V | 000.0000 | ▷ 845AR | $\pm 1 \mu V$ |
| 2 | .1000000 | 1000V | 000.X00 | 1000V CAL | $\pm 1 \mu V$ |
| 3 | .1000000 | 1000V | 001.0000 | DECK C - 1 | $\pm 1 \mu V$ |
| 4 | .2000000 | 1000V | 002.0000 | DECK C - 2 | $\pm 1 \mu V$ |
| 5 | .4000000 | 1000V | 004.0000 | DECK C - 4 | $\pm 2 \mu V$ |
| 6 | .8000000 | 1000V | 008.0000 | DECK C - 8 | $\pm 4 \mu V$ |
| 7 | 0000000 | 1000V | 00X.0000 | ▷ 2 720A | $\pm 5 \mu V$ |
| 8 | Step 7 null | 1000V | 010.0000 | DECK B - 1 | $\pm 5 \mu V$ |
| 9 | 0000000 | 100V | 00.00000 | ▷ 1 845AR | $\pm 1 \mu V$ |
| 10 | .1000000 | 100V | 01.00000 | 100V CAL | $\pm 1 \mu V$ |
| 11 | .2000000 | 100V | 02.00000 | DECK B - 2 | $\pm 1 \mu V$ |
| 12 | .4000000 | 100V | 04.00000 | DECK B - 4 | $\pm 2 \mu V$ |
| 13 | .8000000 | 100V | 08.00000 | DECK B - 8 | $\pm 4 \mu V$ |
| 14 | 1.0000000 | 100V | 0X.00000 | ▷ 2 720A | $\pm 5 \mu V$ |
| 15 | Step 14 null | 100V | 10.00000 | DECK A - 1 | $\pm 5 \mu V$ |
| 16 | 0000000 | 10V | 0.000000 | ▷ 1 845AR | $\pm 1 \mu V$ |
| 17 | .1000000 | 10V | 1.000000 | 10V CAL | $\pm 1 \mu V$ |
| 18 | .2000000 | 10V | 2.000000 | DECK A - 2 | $\pm 1 \mu V$ |
| 19 | .4000000 | 10V | 4.000000 | DECK A - 4 | $\pm 2 \mu V$ |
| 20 | .8000000 | 10V | 8.000000 | DECK A - 8 | $\pm 4 \mu V$ |

▷ 1 Adjust the 845AR ZERO ADJ to obtain a system zero.

▷ 2 Adjust the 720A readout dials for a null on the 845AR. Retain this setting for the next step.

Table 4-12. FINAL LINEARIZATION OF DECK C, B AND A

- m. Set the Standard cell voltage on the standard cell readout dials of the 750A.
- n. Set the instruments to the settings shown in step 1 of Table 4-14.
- o. Connect the 845AR across the output terminals of the 335D. The 845AR should read zero volts and be within the tolerance specified in Table 4-14.
- p. Connect the 845AR to test points A shown in Figure 4-8.
- q. Set the instruments to the settings shown in step 2 of Table 4-14.
- r. Switch in the null indicator with the switch on the 750A and adjust the output of the 335D for a null indication (± 1 microvolt) on the 845AR. The 335D should read ≈ 1100 volts.
- s. Connect the 845AR to test points B shown in Figure 4-8. The null indicator should read within the tolerance specified for this step in Table 4-14.
- t. Perform the remaining checks in Table 4-14 by setting the instruments as specified in each step and checking the specified tolerance against the 845AR null indicator. The steps that are marked with a flag should be performed as in step o. of this paragraph.

WARNING!

During this procedure high voltage is present at the terminals of all test instruments except the standard cell. When relocating the null indicator the output of the 335D should be set to zero volts.

4-66. TROUBLESHOOTING

4-67. A thorough understanding of the principles of operation is necessary to efficiently troubleshoot the instrument. It is recommended that Section 3 be reviewed before attempting to troubleshoot the unit.

4-68. The following troubleshooting procedure is in such sequence that it can be applied to any unit, including one in which the trouble is totally unknown and there is doubt

| 720A SETTING | 335D RANGE | 335D DIAL SETTING | NULL ADJUSTMENT | 845AR NULL |
|--------------|------------|-------------------|-----------------|---------------------|
| 1.0000000 | 1000V | 010.0000 | 1000V CAL | $\pm 5 \mu\text{V}$ |
| 1.0000000 | 100V | 10.00000 | 100V CAL | $\pm 5 \mu\text{V}$ |
| 1.0000000 | 10V | 10.000000 | 10V CAL | $\pm 5 \mu\text{V}$ |

Table 4-13. FINAL RANGE CALIBRATION

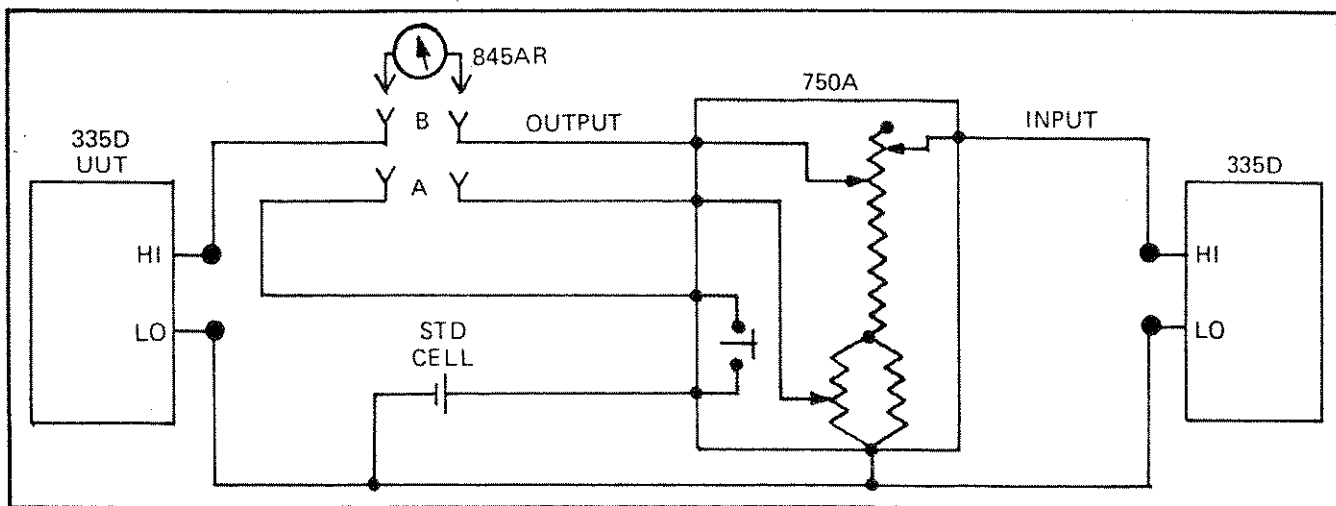

Figure 4-8. CONNECTIONS FOR RANGE CALIBRATION CHECKS

| STEP | 750A SETTING | | 335D | | TOLERANCE |
|------|-----------------|--------|-------|--------------|-----------|
| | INPUT | OUTPUT | RANGE | DIAL SETTING | |
| 1 | --- | --- | 10V | 0.000000 | ±10uV |
| | 1100 | 5 | 10V | 5.000000 | ±60uV |
| | 1100 | 10 | 10V | 10.000000 | ±110uV |
| 1 | --- | --- | 100V | 00.000000 | ±20uV |
| | 1100 | 5 | 100V | 05.000000 | ±70uV |
| | 1100 | 10 | 100V | 10.000000 | ±120uV |
| 1 | --- | --- | 100V | 50.000000 | ±520uV |
| | 1100 | 50 | 100V | 50.000000 | ±520uV |
| | 1100 | 100 | 100V | 100.000000 | ±1020uV |
| 1 | --- | --- | 1000V | 000.000000 | ±200uV |
| | 1100 | 5 | 1000V | 005.000000 | ±275uV |
| | 1100 | 10 | 1000V | 010.000000 | ±350uV |
| 1 | --- | --- | 1000V | 050.000000 | ±950uV |
| | 1100 | 50 | 1000V | 050.000000 | ±950uV |
| | 1100 | 100 | 1000V | 100.000000 | ±1700uV |
| 1 | --- | --- | 1000V | 100.000000 | ±1700uV |
| | 1100 | 500 | 1000V | 500.000000 | ±7.7mV |
| | 1100 | 1000 | 1000V | 1000.000000 | ±15.2mV |
| 1 | --- | --- | 1000V | 10X0.000000 | ±16.7mV |
| | 1100 | 1100 | 1000V | 1099.999X | ±16.7mV |

1 Perform this test as described in paragraph 4-65, step o.

Table 4-14. CONTROL SETTINGS AND TOLERANCES FOR CALIBRATION CHECK

whether power can be applied without causing damage. If the unit is operable, the Resistance Measurement and the Standby Power Check, paragraphs 4-69 and 4-71 may be omitted. The checkout follows the guidelines listed below, and is intended to localize the trouble to an assembly which may be tested individually.

- Remove the Pre-Regulator P/C Assembly.
- Check all auxiliary supplies and the reference voltage.
- Check the Control Amplifier to ensure that it operates properly when provided with an error signal.
- Verify that the Pre-Regulator is being turned on and off by the Unijunction Oscillator.

When it can be verified that the Pre-Regulator is controlling power to the High Voltage Rectifier, the POWER switch may be set to the OPR position and the Series Pass Element checked.

WARNING!

The inner chassis is at the same potential as the +OUTPUT terminal. Avoid contact with the

inner chassis and exposed parts. The Pre-Regulator circuitry is at line voltage above ground. When changing P/C boards, use the POWER switch OFF position and wait a few seconds after removing power to allow capacitors to discharge. When changing the Pre-Regulator Assembly, set the POWER switch to OFF.

4-69. Resistance Measurements

4-70. These checks verify correct output resistance of auxiliary voltage supplies. A check of the sample string may reveal an open resistor, which is sometimes a cause of loss of regulation. An ohmmeter (RCA VoltOhmyst or equivalent) is required for this test.

- Disconnect the instrument power plug from ac power. Disengage the chassis from the case by loosening the two Dzus fasteners on the rear of the instrument. Slide the unit out of the case and remove the top inner cover. This will open interlock.
- Remove the Pre-Regulator P/C Assembly. Set the instrument POWER switch to OFF and set the front panel controls as follows:

| | |
|---------------|----------------------|
| POWER | OFF |
| METER | V |
| VOLTAGE RANGE | 100V |
| TRIP | 1000V |
| VERNIER | Fully Clockwise (CW) |
| CURRENT LIMIT | Fully Clockwise (CW) |
| Decade Dials | 50.00000 |

- c. Measure the resistance between the following test points and the +SENSE terminal. Connect the assembly to the motherboard by using the extender card.

| ASSEMBLY | PIN | RESISTANCE (Approx.) |
|------------------------|-----|-------------------------|
| Auxiliary Power Supply | 9 | 8.4 kilohms |
| Auxiliary Power Supply | 10 | 2.1 kilohms |
| Current Limiter | 1 | 6.0 kilohms |
| Current Limiter | 3 | 3.0 kilohms |

- d. Disconnect the shorting links between the SENSE and OUTPUT terminals. Remove the Differential Amplifier Assembly and connect an ohmmeter between pin 5 of the Differential Amplifier socket and the negative SENSE terminal. The ohmmeter should indicate less than 0.5 ohm. Step each dial through its range; the resistance should increase according to the following table. Return each dial to zero after checkout.

NOTE!

This check detects gross errors only, such as an open resistor. Resistors are factory selected for accuracy and temperature coefficient.

| READOUT DIAL | RESISTANCE INCREASE OHMS PER STEP |
|--------------|--------------------------------------|
| Seventh | 0.1 |
| Sixth | 1.0 |
| Fifth | 10 |
| Fourth | 100 |
| Third | 1000 |
| Second | 10,000 |
| First | 100,000 |

- e. Reconnect the links between the SENSE and OUTPUT terminals and replace the Differential Amplifier Assembly.

4-71. Standby Power

4-72. This check measures power consumption in the STDBY/RESET mode. It reveals possible gross faults such as wiring errors or shorted components in the auxiliary power supply, voltage control circuitry and protection circuitry. A metered Variac and differential voltmeter are required for this test.

- Remove the top inner cover and the Pre-Regulator Assembly if not already accomplished.
- Connect the instrument through a Variac to a 115 volt, 60 Hz, power line with a wattmeter or ammeter in series between the Variac and the instrument. Set the Variac output to zero. Set the front panel controls as follows:

| | |
|---------------|-------------------|
| POWER | OFF |
| VOLTAGE RANGE | 100 |
| TRIP | 1000 |
| VERNIER | Maximum Clockwise |
| CURRENT LIMIT | Maximum Clockwise |
| Readout Dials | 50.00000 |

- Set the POWER switch to STDBY/RESET and slowly increase the output of the Variac to 115 volts. The CURRENT LIMIT and center decimal lights should come on and the time delay relay (A6-K2001) should operate. The wattmeter should indicate 30 to 40 watts power drain.



4-73. Auxiliary Supply Voltages

4-74. This procedure checks out the bias voltages, master reference voltage and the series pass element voltage.

- Using the Model 895A differential voltmeter, measure the voltage between the test points listed in Table 4-15 and the +SENSE terminal, which is common.
- Where indicated, perform the adjustment to determine that it can be made. These should be rechecked during calibration of the instrument.

4-75. Unijunction Oscillator and Chopper Amplifier

4-76. UNIUNCTION OSCILLATOR. This check verifies operation of the unijunction oscillator and the flow of error signal through the chopper amplifier, differential

| ASSEMBLY | PIN | VOLTS DC |
|---|--------------|--|
| Auxiliary Power Supply | 10 | 23 to 27  |
| Auxiliary Power Supply | 9 | -14 to -16 |
| Current Limiter | 1 | -33 to -39 |
| Current Limiter | 3 | 33 to 39 |
| Range Cal | Test Points | 14.9 to 15.1  |
| Reference Supply | Collector Q1 | 26 to 35  |
| Series Pass | Collector Q8 | Approx. 140 |
| Rear bulkhead power resistor, 100 kilohms | Yellow lead | 650 to 725 |



 Adjustable to 25 volts ± 10 mV with R9
 Adjustable to 15.0 volts ± 10 uv with R9 on Reference Supply pcb.
 Approximately 1 volt at turn-on, rising to 26 to 35 volts after 10 minute warm-up.

Table 4-15. REFERENCE AND AUXILIARY VOLTAGES

amplifier and series pass driver. An oscilloscope is required for this test.

- Connect the oscilloscope with a 10X isolation probe between pins 14 (common) and 15 (input) of the Series Pass P/C Assembly. Set the oscilloscope sweep speed to 1 milliseconds/cm and vertical sensitivity to 1 volt/cm.
- Set the POWER switch to STDBY/RESET. Positive going pulses of 1.0 to 2.0 volts peak-to-peak should be observed.

4-77. CHOPPER AMPLIFIER. This procedure checks the alignment and response of the Chopper Amplifier in the 335D. An oscilloscope and a general purpose supply are required for this test. To check alignment:

- Install the Chopper Amplifier assembly on the extender card. Connect an oscilloscope to the base of Q3 on the Chopper Amplifier Board. The scope common should be connected to Pin 13 of the card connector. Connect a clip lead between Pin 6 and Pin 12 of the input connector.
- Turn the POWER switch to STDBY/RESET. Turn the CHOPPER DRIVE ADJUST (R43) to maximum clockwise. Turn CHOPPER COMPENSATION ADJUST to maximum clockwise.
- Adjust CHOPPER COMPENSATION ADJUST (R34) for minimum pulse amplitude. The total adjustment range of R34 should provide a positive

and negative pulse swing. If this is not satisfied, cut the jumper across R33 and again adjust R34. When correctly adjusted, R34 will reduce the positive spike at transition point to zero.

- Alternately adjust R43 counter-clockwise and R34 as necessary to obtain maximum squareness of the chopper waveform without a spike at the transition point. When correctly adjusted, waveform should appear as shown in Figure 4-9.

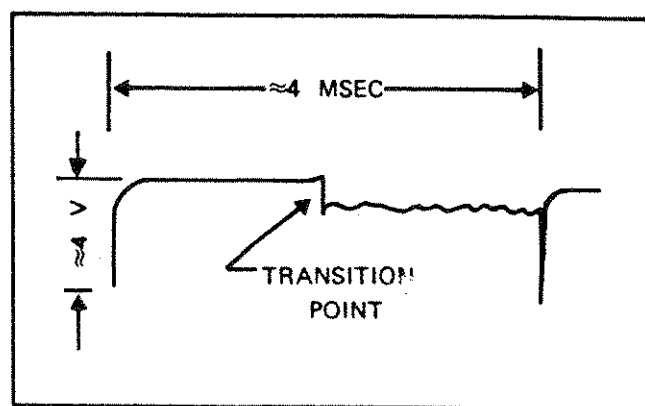

Figure 4-9. CHOPPER WAVEFORM

- Replace the chopper board in the instrument.
- 4-78. To check amplifier response:
- Connect the oscilloscope with a 10X isolation probe between Pins 14 (common) and 15 (input) of the Series Pass P/C Assembly. Set the oscilloscope sweep speed to 1 milliseconds/cm and vertical sensitivity to 1 volt/cm.

- b. Set the POWER switch to STDBY/RESET. Positive going pulses of 1.0 to 2.0 volts peak-to-peak should be observed.
- c. Set POWER switch to OPR. The pulses observed in step b. should disappear.
- d. Set the output of a laboratory power supply to 5.5V dc.
- e. With 335D POWER switch in OPR position, connect the lab supply to the corresponding OUTPUT terminals of the 335D.
- f. Set 335D controls as follows and observe unijunction pulses:

| Range | Dialed Voltage | Unijunction Pulses |
|-------|----------------|--------------------|
| 10V | 5.000000 | Should appear |
| 10V | 6.000000 | Should disappear |
| 100V | 05.00000 | Should appear |
| 100V | 06.00000 | Should disappear |
| 1000V | 005.0000 | Should appear |
| 1000V | 006.0000 | Should disappear |

4-79. Pre-Regulator

This check verifies operation of the Pre-regulator circuitry Q1 through Q8. An oscilloscope and power line isolation adapter are required for this test.

- a. Set the POWER switch to OFF. Install the Pre-Regulator P/C Assembly.
- b. Set the instrument front panel controls as follows:

| | |
|---------------|-------------------|
| POWER | OFF |
| RANGE | 1000 |
| TRIP | 1000 |
| VERNIER | Maximum Clockwise |
| CURRENT LIMIT | Maximum Clockwise |

- c. Connect the oscilloscope power plug to the ac line via a line isolator (two-to-three wire adapter). The oscilloscope must be operated ungrounded when observing pre-regulator waveforms.
- d. Connect the oscilloscope common to the emitter of Q1 and connect the input to the base. (Q1 is the stud-mounted power transistor). Set the vertical input to dc, sweep speed to 1 millisecond/cm and the vertical sensitivity to 0.5 volt/cm.

- e. Set the readout dials to 50.0000 and the POWER switch to STDBY/RESET. The oscilloscope waveform should appear as shown in Figure 4-10.
- f. Set the POWER switch to OPR. The oscilloscope waveform should appear as shown in Figure 4-11.
- g. Set POWER switch to STDBY/RESET and remove oscilloscope connections. Bypass the interlocks. Set POWER switch to OPR. Voltmeter 335D should indicate 50 ± 10 volts.
- h. Set RANGE switch to 10 volt range. Voltmeter should indicate 5 ± 1 volt.

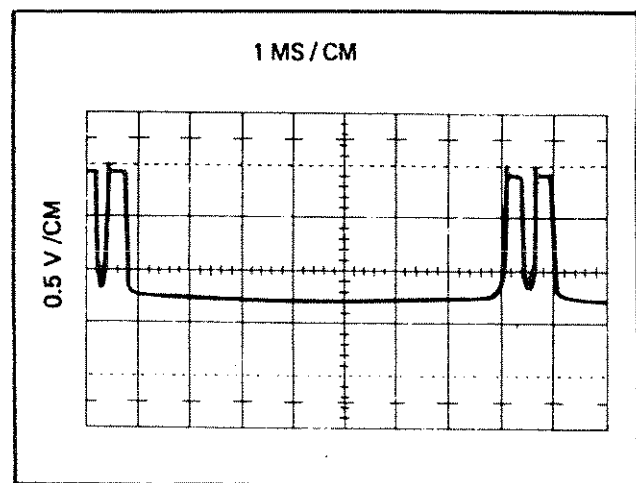

Figure 4-10. PRE - REGULATOR Q1, WAVEFORM ON STDBY/RESET

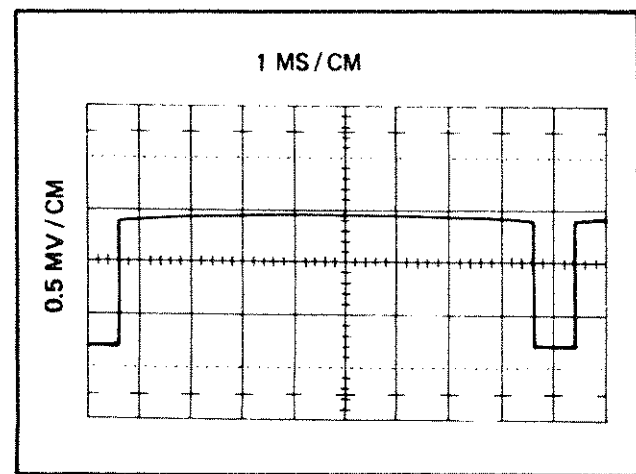

Figure 4-11. PRE - REGULATOR Q1, WAVEFORM ON OPR

- i. Set RANGE switch to 1000 volt range. Voltmeter should indicate 500 ± 100 volts. Set POWER switch to OFF.
- j. Connect the oscilloscope across the 50 watt zener diode on the pre-regulator assembly. Connect Oscilloscope "positive" input to cathod, connect "negative" input to the anode; use a 10X probe. Connect output to load box.
- k. Set decades for 1100 volt output, set POWER switch to OPR, and set CURRENT LIMIT to 60 mA.
- l. Set oscilloscope sensitivity to 50V/cm and sweep speed to 2 ms/cm.
- m. Set line voltage to 115V ac, 60 Hz. The waveform observed on the oscilloscope should appear as in Figure 4-12A and should not exceed 150 volts peak.
- n. Set line voltage to 100V ac, 60 Hz. The waveform observed on the oscilloscope should appear as in Figure 4-12B.
- o. Set line voltage to 130V ac, 60 Hz. The waveform observed on the oscilloscope should appear as in Figure 4-12C.
- p. Remove oscilloscope connections.

4-80. Series Pass Element

4-81. If the procedure has been completed satisfactorily thus far, the main parts of the voltage control circuitry have been checked out excluding the Series Pass P/C Assembly. A differential voltmeter and a load resistor box are required for this test.

- a. Set the line voltage to 100V ac and set readout dials to all zeros on 10 volt range. Connect a voltmeter between the collector of Q1 and the emitter of Q8 on the Pass Element assembly. This voltage should read less than 2V dc.
- b. Set the line voltage and 335D controls as in Table 4-16 and measure the voltage between the collector and emitter of Q8. The voltages should be within the specified limits.

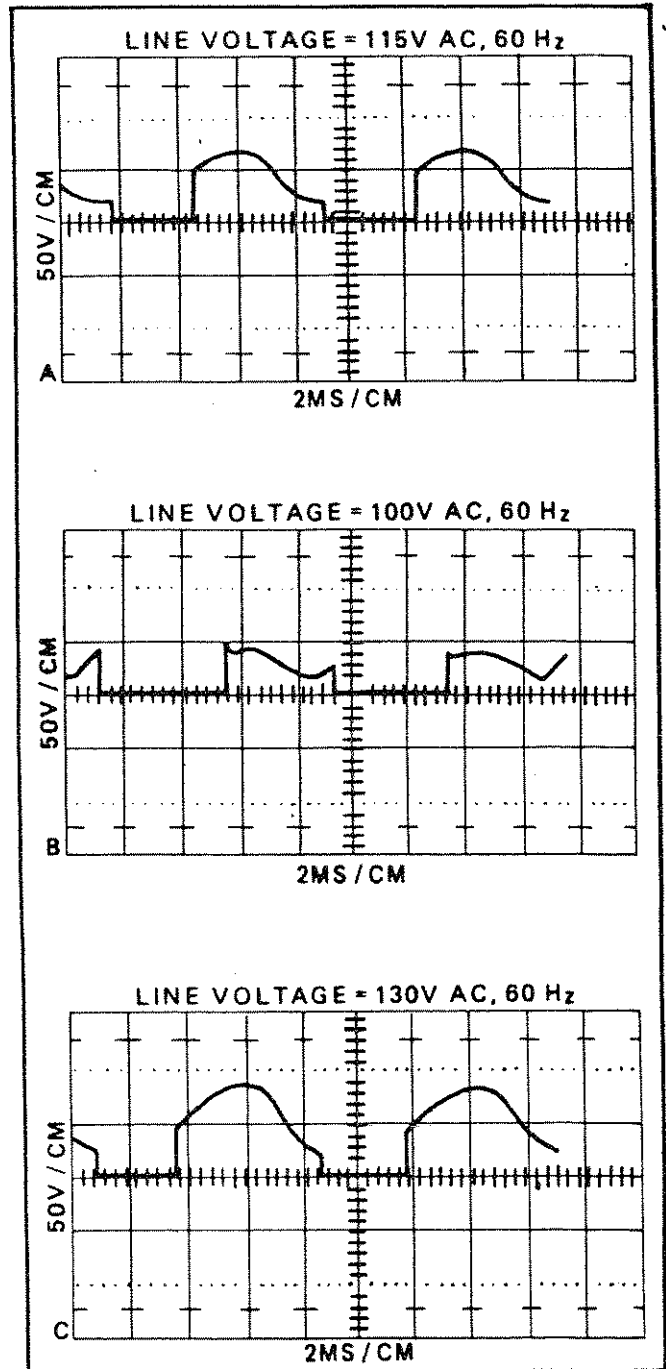

Figure 4-12. WAVEFORMS ACROSS ZENER DIODE

| Range | Output | Load | Line Voltage | Voltage Limits Across Q8 | |
|-------|--------|-------|--------------|--------------------------|------|
| | | | | Min. | Max. |
| 10 | 0 | 0 | 100 | 45 | 120 |
| 10 | 0 | 0 | 130 | 45 | 120 |
| 1000 | 1100 | 60 mA | 100 | 42 | 55 |
| 1000 | 1100 | 60 mA | 130 | 42 | 55 |

Table 4-16 SERIES PASS ELEMENT VOLTAGE CHECKS

- c. Connect the voltmeter across the OUTPUT terminals of the 335D. Set the 335D for the following outputs on the 1000 volt range (100, 300, 600, 900, 1100 volts) and short the OUTPUT terminals at each setting. The output should return to normal upon removal of the short.

4-82. Voltmeter-Null Detector

4-83. The purpose of the trouble shooting chart, Table 4-17, and the figures following is to locate and correct as quickly as possible any deficiency in operation of the voltmeter-null detector portion of the instrument. The causes and remedies of the more common troubles are listed in the troubleshooting chart, Table 4-17. Waveforms useful for troubleshooting are given in Figures 4-13 through 4-18.

| SYMPTOM | PROBABLE CAUSE | FAULT ISOLATION PROCEDURE |
|---|---|--|
| Blows fuses. | Short circuit across secondary of T1 Defective A6A1CR1 through A6A1CR4 | Test for short circuit between pins 11 and 12. Measure voltage of C1 (A6A1). Should be 10.5 volts. If near zero, replace CR1 through CR4, as necessary. |
| Photo Modulator inoperative. (Neon lights out) | Defective Q1 or Q2 Open winding on A6T1, or open C2. No drive to neon lamps DS1 and DS2 | If voltage across C1 is less than 7 volts, replace Q1 and/or Q2 Waveform at A6A1T1, pin 1 should agree with Figure 4-13. If square wave is absent, A6A1T1 or C2 is defective. A square wave of over 200 volts peak-to-peak should be present between pin 9 of A6A1T1 and the GUARD terminal. If not, A6A1T1 may be defective. |
| Meter movement inoperative. | Dead meter. Defective auxiliary supply. | Check meter with an ohmmeter. Panel meter should peg. Measure voltages at A6A1, pin 2 and A6A1, pin 3. If one voltage is near zero, check the associated diode and capacitor. If both voltages are zero, A6A1T1 is defective. |
| Meter pegs or wanders. | Meter mechanically stuck. Defective amplifier | Using an oscilloscope with dc coupling, measure waveforms at junction of A6A2R22 and R24. If waveforms agree with Figure 4-14, check Q11, Q12, Q9, Q10, Q7, and Q8 by replacement. If waveforms are not correct, then check the following: (a) Waveform at junction of A6A2R22 and R24 looks more like waveform at collector of Q5, Figure 4-15: Q6 is open (b) No change in waveform at junction of A6A2 R22 and R24 as ZERO control is rotated: R1 is shorted, base of Q1 is shorted, V1 or V2 is shorted. (c) Waveform at junction of A6A2 R22 and R24 looks like a square wave. Measure waveform at collector of Q5. If square wave disappears and waveform at collector of Q5 is correct, C12 is shorted. If waveform is not correct, remove Q4 and measure waveform at collector of Q3, |

Table 4-17. TROUBLESHOOTING (SHEET 1 OF 3)

| SYMPTOM | PROBABLE CAUSE | FAULT ISOLATION PROCEDURE |
|---|--|--|
| | continued Defective amplifier | <p>Figure 4-16. If square wave persists, short base of Q1 to common. If square wave disappears, remove short and transfer short to R4, C4, and V1 junction. If square wave returns, a photocell is defective, or C4 is shorted. If square wave does not return, move the short to the end of R1 that connects to SENSITIVITY switch. If signal reappears, CR1 or CR2 is defective. If square wave does not reappear, the SENSITIVITY switch is defective.</p> <p>(d) No signal at junction of A6A2 R22 and R24. If there is also no signal at collector of Q5, Q6 is probably shorted. If Q6 is satisfactory, measure waveform at collector of Q3. If there is still no signal, C7, CR5, Q1, Q2, or Q3 is defective.</p> |
| Erratic or unstable condition when measuring a voltage or zeroing instrument. | S6 Erratic Contact. | Replace or burnish contacts with crocus cloth. |
| Meter deflects in one direction, only. | Open winding on A6A1T2, defective Q3, Q4, Q5, or Q6. | Check and replace as necessary |
| Slower response in negative direction. | Leaky C6 | Test and replace if necessary. |
| Measurements are low on high-sensitivity. | Shorted C17 or C18 | Test and replace if necessary |
| Poor stability. | Defective CR5. | Replace if necessary. |
| Noise on 10 μ V range. | Dirty or defective Q1, or defective Q2. | <p>Measure waveform at collector of Q3. Figure 4-17 waveform shown is normal. Additional noise at collector Q3 is due to dirty or defective Q2. Remove Q11 and Q12, and apply an input of 10 mv with sensitivity at 10 μv. Observe waveform at emitter of Q3. For wave form shown in Figure 4-18:</p> <p>(a) Excessive noise can be caused by poor positioning of neon lamps.</p> <p>(b) Smaller waveform can be caused by slow response of photocells; if so, replace cells.</p> |

Table 4-17. TROUBLESHOOTING (SHT 2 OF 3)

| SYMPTOM | PROBABLE CAUSE | FAULT ISOLATION PROCEDURE |
|-------------------------|---|---|
| Unguarded leakage poor. | Dirty grommets. Leakage in A6A1T1 or A6A1T2. | Clean grommets. Test and replace if necessary. |
| Guarded leakage poor. | Leakage in A6A1T1 or A6A1T2, or pins touching circuit board. Contaminated binding posts. | Test and repair as necessary. Clean binding posts. |
| Poor overload. | Defective R1, CR1, CR2, C2, C3, or C4(A6A1). | Test and replace as necessary. |

Table 4-17. TROUBLESHOOTING (SHT 3 OF 3)

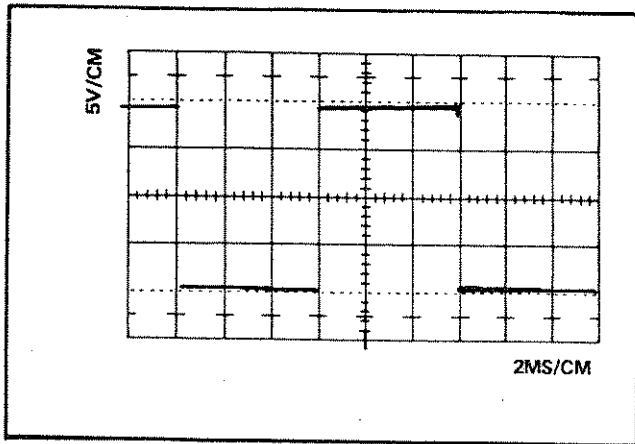

Figure 4-13. WAVEFORM AT PIN 1 OF A6A1T1

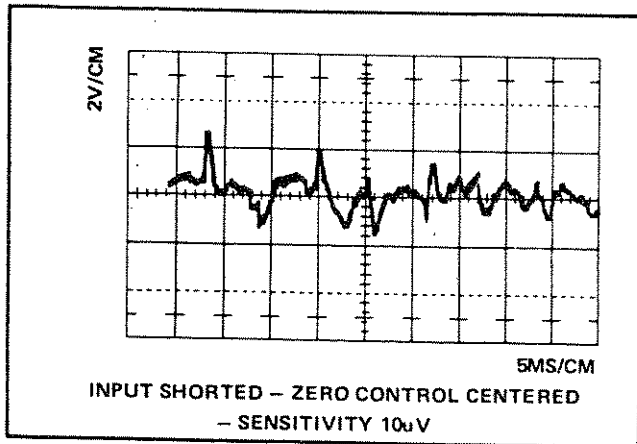

Figure 4-15. WAVEFORM AT COLLECTOR OF Q5

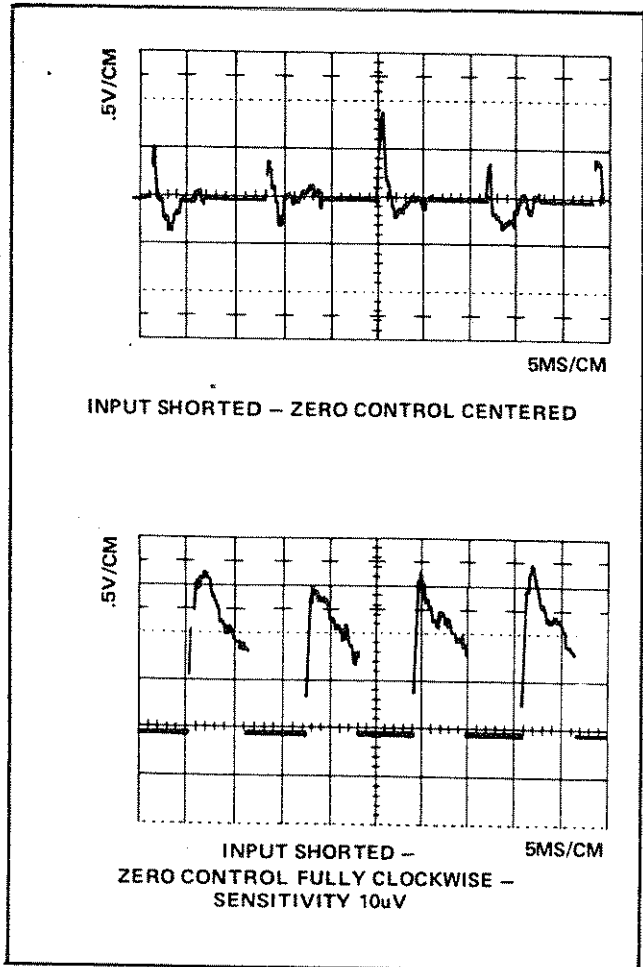

Figure 4-14. WAVEFORMS AT EMITTER OF Q6

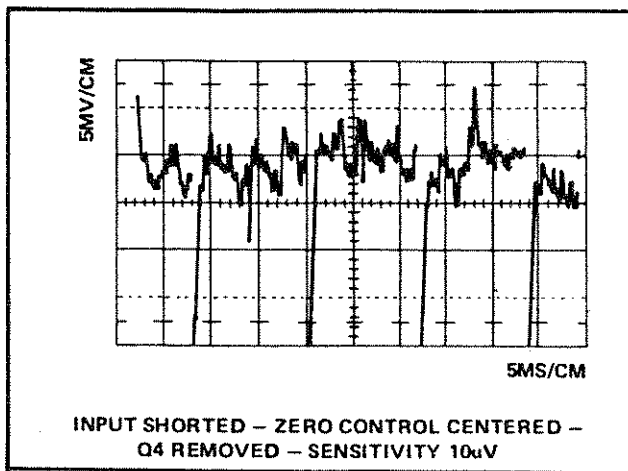

Figure 4-16. WAVEFORM AT COLLECTOR OF Q3 - Q4 REMOVED

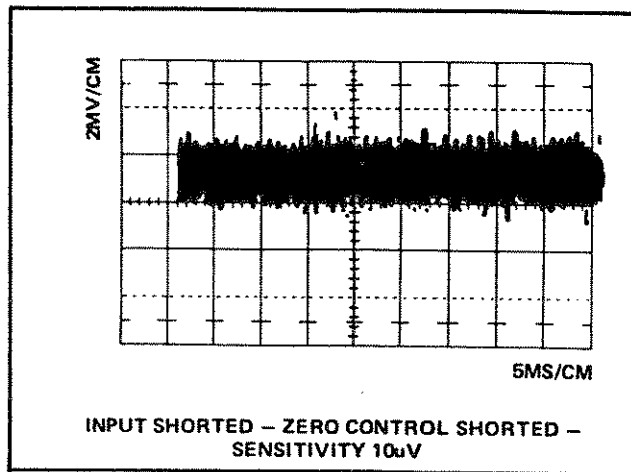

Figure 4-17. WAVEFORM AT COLLECTOR OF Q3

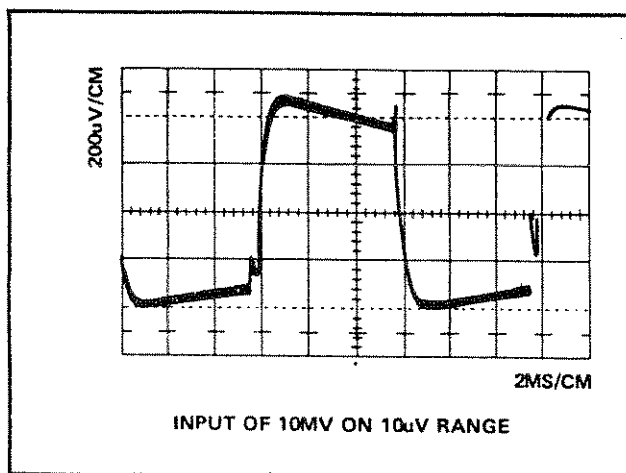

Figure 4-18. WAVEFORM AT EMITTER OF Q3

Free Manuals Download Website

<http://myh66.com>

<http://usermanuals.us>

<http://www.somanuals.com>

<http://www.4manuals.cc>

<http://www.manual-lib.com>

<http://www.404manual.com>

<http://www.luxmanual.com>

<http://aubethermostatmanual.com>

Golf course search by state

<http://golfingnear.com>

Email search by domain

<http://emailbydomain.com>

Auto manuals search

<http://auto.somanuals.com>

TV manuals search

<http://tv.somanuals.com>