

FoodSaver[®]

by Tilia™

The Original Home Vacuum Packaging System™



Vac 550

User Manual

Welcome

You have just purchased an appliance that will soon have you wondering how you ever got by without it. The FoodSaver Vac 550 is so convenient and versatile, you'll find yourself using it every day. We guarantee that if you make room for it on your countertop, you will quickly see how indispensable it becomes in your kitchen.

Foods Will Keep Their “Just Bought” Freshness, Flavor, and Nutritional Value 3 to 5 Times Longer.

- ▶ Meats, poultry, fish, and produce stay fresh and flavorful in your freezer.
- ▶ No more freezer burn.
- ▶ Foods stay fresh longer in your refrigerator.
- ▶ Dry ingredients stay fresh and insect-free in the pantry.

You'll Save Money, Time, and Effort.

- ▶ Buy in bulk to reduce your grocery bills.
- ▶ Repackage your purchases in portions sized for your family's needs.
- ▶ Prepare meals in advance so when you don't have time to cook, you and your family will still have great-tasting homemade meals.
- ▶ Take bags right from the freezer or refrigerator and boil or microwave.
- ▶ Reduce waste and spoilage.
- ▶ Prepare your own healthy frozen dinners. You control serving portions, calories, and nutritional content.
- ▶ Make and deliver home-cooked meals to those who can't get out.
- ▶ Keep non-food items dry and free of dust and mold.
- ▶ Stop silver from tarnishing because the metal is not exposed to air.

Table of Contents

	Welcome
2	The FoodSaver Vac 550
4	FoodSaver Accessories
	Operating Instructions: How to...
6	Make a Bag with FoodSaver Rolls
8	Vacuum Package Using Ready-Made and Custom-Made FoodSaver Bags
10	Vacuum Package Using FoodSaver Designer Canisters
12	Vacuum Package Using FoodSaver Bulk Storage and Square Canisters
14	Vacuum Package Using the FoodSaver Jar Sealer with Mason Jars
16	Vacuum Package Using FoodSaver Universal Lids
18	Vacuum Package Using FoodSaver Bottle Stoppers
20	Care and Cleaning Instructions
21	Food Preparation and Storage Guide
30	Important Safeguards
31	Troubleshooting
34	Marinating Recipes
39	Vacuum Packaging Non-Food Items
40	Warranty and Service Information

The FoodSaver Vac 550

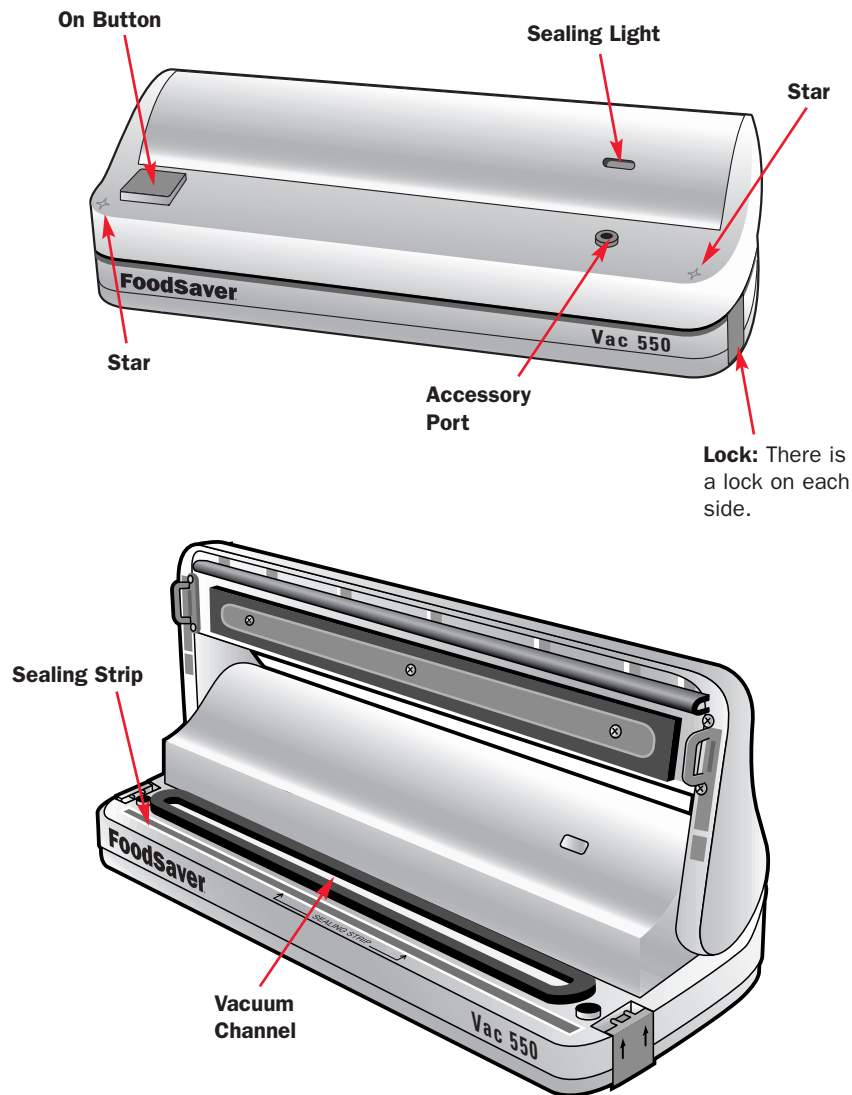

About Vacuum Packaging

Air is left in most food storage containers and plastic bags even when they are sealed tightly. Oxygen is one of the main reasons that food goes bad. It starts a chemical change – robbing food of its nutritional value, texture, color, flavor, and overall quality. The FoodSaver Vac 550 removes the air from our FoodSaver Bags and then seals the bags so that air cannot reenter. The Vac 550 is also designed to be used with a wide range of FoodSaver accessories that will keep a variety of foods fresh longer. Finally, you can maintain the same freshness at home that you get with professionally vacuum-packaged items you purchase at the grocery store.

FoodSaver Bags and Rolls

FoodSaver Bags and Rolls are made from a patented, 3-ply plastic material with special channels that remove the air. The outer layer of nylon seals freshness in, while locking air and moisture out.

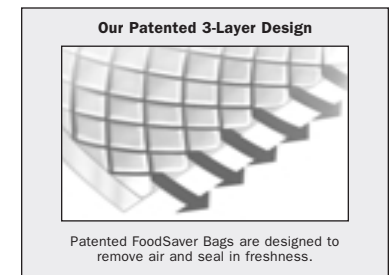

- FoodSaver Bags and Rolls can go straight from the freezer and refrigerator to the microwave or boiling water. They are reusable, washable (including in the dishwasher), and recyclable.
- FoodSaver Bags are ready-made in quart and gallon sizes to offer convenient, one-step storage.
- FoodSaver Rolls come in two widths, 8 inches and 11 inches, which allow you to make customized bags for the items that you are vacuum packaging.
- Most FoodSaver users like to keep both bags and rolls handy for the greatest packaging convenience.

FoodSaver Accessories

FoodSaver Canisters

- There are three styles of FoodSaver Canisters – Designer, Square, and Bulk Storage. They are ideal for storing delicate items and liquids, as well as dry goods and cooking staples. The

Canisters come in a variety of sizes and all can be used in the refrigerator and pantry. Canisters are not to be used in the freezer.

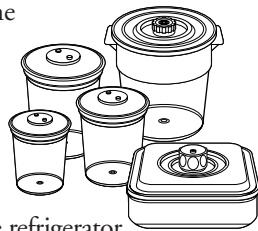

- FoodSaver Designer Canisters are especially attractive for use on your countertop.



- Vacuum packaging in the FoodSaver Square Canister is an excellent way to marinate foods because the process opens the pores of the food and seals in the flavor. The Vac 550 can marinate food in 20 minutes so you don't have to wait all day or overnight for that special taste. All FoodSaver Canisters work for marinating, but we recommend the Square Canister because less marinade will be needed.
- The Bulk Storage Canisters are designed to store pantry items such as cereal, chips, rice, and baking goods.

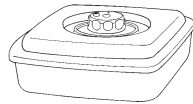

FoodSaver Regular Jar Sealer

- The FoodSaver Regular Jar Sealer allows you to vacuum package in regular or standard mouth mason jars. **Note:** FoodSaver Jar Sealers are designed to fit mason jars manufactured in the U.S., such as Ball® and Kerr® brands.

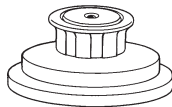

FoodSaver Wide-Mouth Jar Sealer

- The FoodSaver Wide-Mouth Jar Sealer allows you to vacuum package in wide-mouth mason jars.

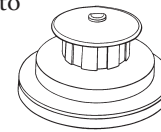

FoodSaver Universal Lids

- With this great kitchen accessory, you don't have to transfer many foods out of their original containers. Vacuum package and extend the life of foods in their original glass jars and metal cans.
- Available in two sizes – 4 inches and 5½ inches in diameter.

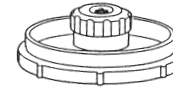

FoodSaver Bottle Stoppers

- FoodSaver Bottle Stoppers allow you to vacuum package bottles to protect the taste and extend the life of liquids such as wine, liquor, and cooking oils.

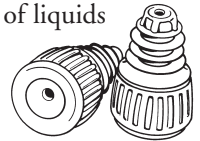

Purchasing FoodSaver Bags, Rolls, and FoodSaver Accessories

- Your Vac 550 kit includes FoodSaver Bags and Rolls and may include some accessories. Additional supplies and accessories are available at your local retailer. To find the nearest one, visit our website at

www.foodsaver.com

or call our Consumer Services Department at the number listed at the back of this manual.

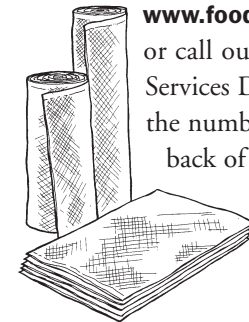

How to Make a Custom-Made Bag with FoodSaver Rolls

When using FoodSaver Rolls you first need to make a bag, then vacuum package your food in the bag. (If you are using ready-made FoodSaver Bags, go to page 8.)

- 1 Place the Vac 550 on a flat, dry surface and plug the power cord into a standard electrical outlet.
- 2 Lay the item(s) you want to vacuum package near the FoodSaver Roll so you can see where to cut the bag material. Leave at least 3 extra inches at one end of the bag and more if you want to reseal or reuse the bag. (One inch per reseal.)
- 3 Cut the FoodSaver Roll to the desired length, making sure you cut straight. The marks on the side of the roll are at 3" intervals and will assist you in cutting straight.

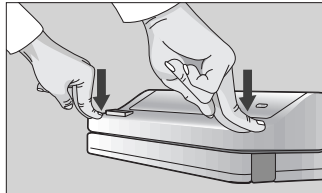

- 4 Open the lid of the Vac 550. If the lid is locked, release locks by pressing down firmly on the stars.
- 5 Place one end of the bag on the sealing strip.

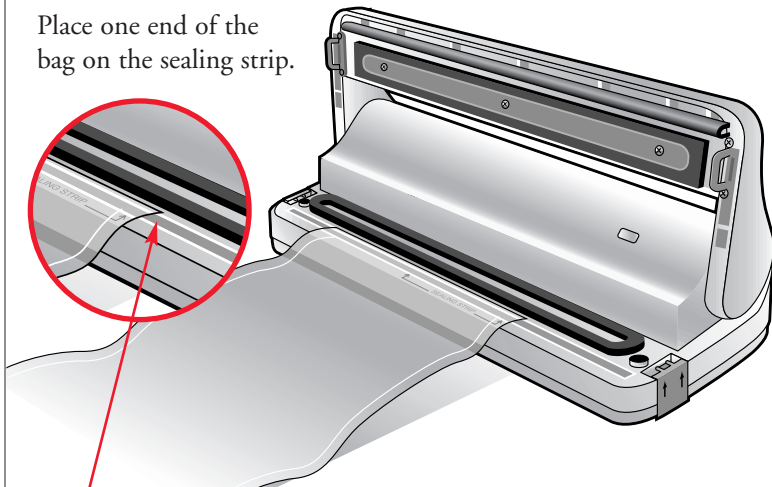

IMPORTANT: Make sure the end does not go over the black foam rubber ring, or into the vacuum channel.

- 6 Close the lid. Lock the lid by pressing in the locks on both sides. (You may need to press down lightly on the stars while pressing in the locks.)
- 7 Press and hold down the On button. The light will go on as the Vac 550 seals the bag. **Wait until the sound stops and the light turns off before releasing the lid.**
- 8 The locks on the sides will release automatically. Lift up the lid and remove the bag. You now have a custom-sized FoodSaver Bag.

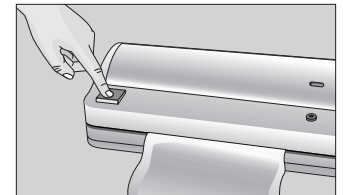
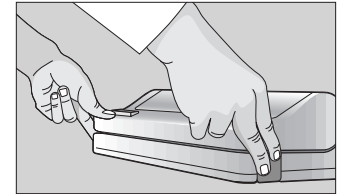

You are now ready to vacuum package. Just follow the instructions on page 8.

NOTE: Let the Vac 550 cool down for at least 20 seconds before using it again.

How to Vacuum Package Using Ready-Made and Custom-Made FoodSaver Bags

- 1 If you have not already done so, place the Vac 550 on a flat, dry surface and plug the power cord into a standard electrical outlet.
- 2 Open the lid of the Vac 550. If the lid is locked, release locks by pressing down firmly on the stars.
- 3 Place the item(s) to be vacuum packaged into the bag.
- 4 Place the open end of the bag **down into** the vacuum channel.

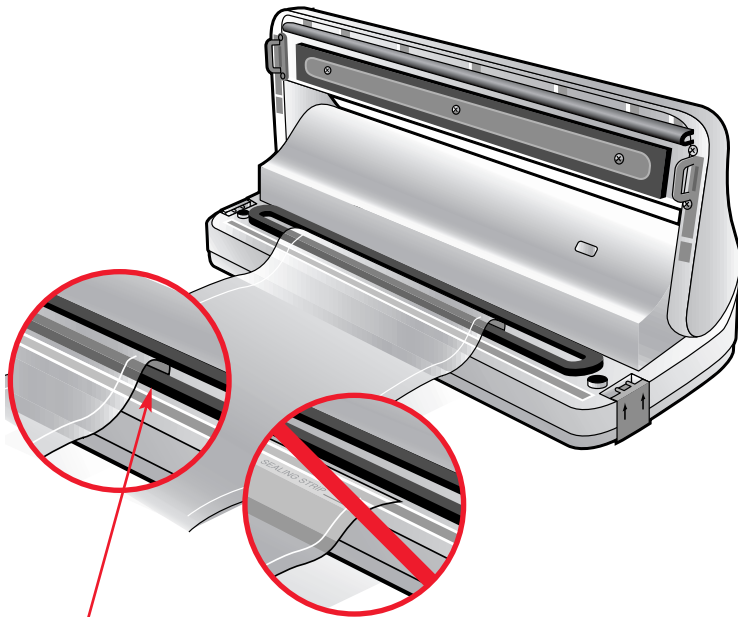

IMPORTANT: Make sure the open end of the bag touches the blue label on the bottom of the vacuum channel.

- 5 Close the lid. Lock the lid by pressing in the locks on both sides. (You may need to press down lightly on the stars while pressing in the locks.)
- 6 Press and hold down the On button. The light will go on as the Vac 550 seals the bag. **Wait until the sound stops and the light turns off before releasing the lid.**
- 7 The locks on the sides will release automatically. Lift up the lid and remove the bag.
- 8 Vacuum packaging is complete.

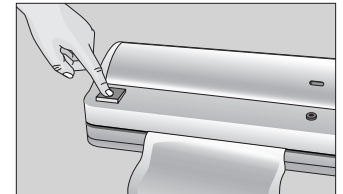
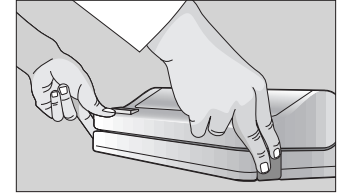

NOTE: Let the Vac 550 cool down for at least 20 seconds before using it again.

IMPORTANT: You will need to pre-freeze foods that have excess liquid or moisture before vacuum packaging in FoodSaver Bags because the liquid can be drawn up into the vacuum pump.

How to Vacuum Package Using FoodSaver Designer Canisters

FoodSaver Designer Canisters are both functional and attractive and an excellent way to store delicate items in the refrigerator, pantry, or on the countertop. FoodSaver Designer Canisters cannot be stored in the freezer, and unlike the Bulk Storage and Square Canisters, cannot be used in the microwave. The bases can be put in the dishwasher for cleaning. **However, do not put the lids in the dishwasher.**

- 1 Place the Vac 550 on a flat, dry surface and plug the power cord into a standard electrical outlet.
- 2 Place the item(s) to be vacuum packaged inside the canister. Leave at least one inch between the contents and the rim of the canister.
- 3 Place the lid on top of the canister.
- 4 Insert one end of the accessory hose into the accessory port on the Vac 550.
- 5 Insert the other end of the accessory hose into the hole on the top of the canister.

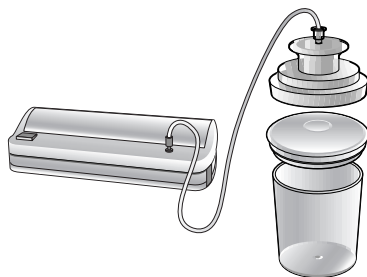
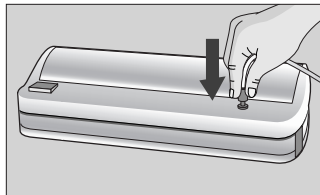

- 6 Close the lid. Lock the lid by pressing in the locks on both sides. (You may need to press down lightly on the stars while pressing in the locks.)
- 7 Press and hold down the On button. The light will turn on as the Vac 550 starts the vacuum cycle and air is removed from the canister. **Wait until the sound stops and the light turns off before releasing the lid.**
- 8 Vacuum packaging is complete.

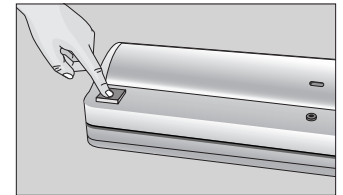
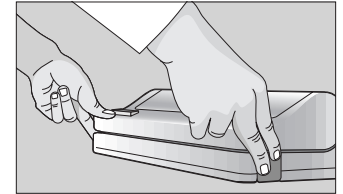

IMPORTANT: Remember to remove the accessory hose from the accessory port on the FoodSaver Vac 550 before you vacuum package in FoodSaver Bags.

How to Open the FoodSaver Designer Canister

To open the FoodSaver Designer Canister, press and hold down the grey rubber button in the center of the lid. This will release the vacuum and you should be able to remove the lid.

How to Vacuum Package Using FoodSaver Bulk Storage and Square Canisters

FoodSaver Bulk Storage and Square Canisters are a great way to store food in your refrigerator and pantry. The Square Canister is also ideal for marinating.

FoodSaver Canisters cannot be stored in the freezer. The Bulk Storage and Square Canister bases can be used in the microwave to reheat foods and put in the dishwasher for cleaning. **Do not put the lids in the microwave or dishwasher.**

- 1 Place the Vac 550 on a flat, dry surface and plug the power cord into a standard electrical outlet.
- 2 Place the item(s) to be vacuum packaged inside the canister. Leave at least one inch between the contents and the rim of the canister.

- 3 The canister lid is labeled "Open," "Vacuum," and "Closed." Turn the knob on the canister lid so the arrow points to "Vacuum."

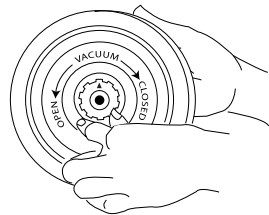

- 4 Place the lid on top of the canister.

- 5 Insert one end of the accessory hose into the accessory port on the Vac 550.

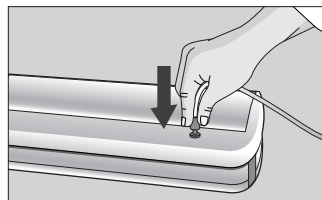

- 6 Insert the other end of the accessory hose into the hole on the top of the canister.

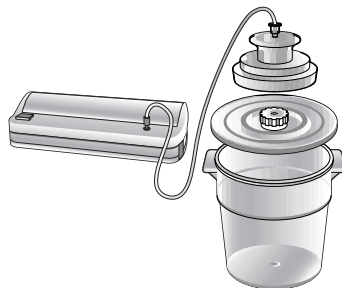

- 7 Close the lid. Lock the lid by pressing in the locks on both sides. (You may need to press down lightly on the stars while pressing in the locks.)
- 8 Press and hold down the On button. The light will turn on as the Vac 550 starts the vacuum cycle and air is removed from the canister. **Wait until the sound stops and the light goes off before releasing the lid.**
- 9 Turn the knob on the canister lid so the arrow points to "Closed."
- 10 Vacuum packaging is complete.

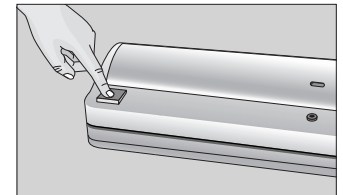
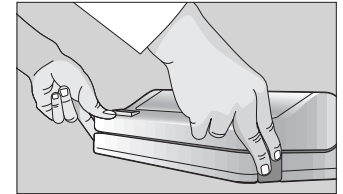

IMPORTANT: Remember to remove the accessory hose from the accessory port on the Vac 550 before you vacuum package in FoodSaver Bags.

How to Open the FoodSaver Bulk Storage or Square Canister

To open the FoodSaver Bulk Storage or Square Canister, turn the knob on the canister lid so the arrow points to "Open." This will release the vacuum and you should be able to remove the lid.

NOTE: Do NOT attempt to vacuum seal any contents that are warmer than room temperature, since the vacuum may cause the contents to bubble out of the canister or jar.

How To Vacuum Package Using the FoodSaver Jar Sealer with Mason Jars

The Vac 550 used with the FoodSaver Jar Sealer allows you to vacuum package food in mason jars. There are two sizes of jar sealers: the FoodSaver Wide-Mouth Jar Sealer for wide-mouth mason jars, and the FoodSaver Regular Jar Sealer for regular and standard-mouth mason jars. If you wish to store mason jars in the freezer, make sure to use tapered and tempered freezer-safe mason jars and leave extra space between the contents and the lid to allow for the normal expansion of liquids.

NOTE: Always pre-soak new metal lids. Bring water to a boil, then turn off. Pre-soak lids 5-10 minutes.

- 1 Place the Vac 550 on a flat, dry surface and plug the power cord into a standard electrical outlet.
- 2 Place the item(s) to be vacuum packaged inside the mason jar. Leave at least one inch between the contents and the rim of the jar.
- 3 Place the mason jar lid on the top of the mason jar. (You will not need the screw band section of the mason jar lid. It is not used when vacuum packaging.)

- 4 Insert one end of the accessory hose into the hose port on the Vac 550.

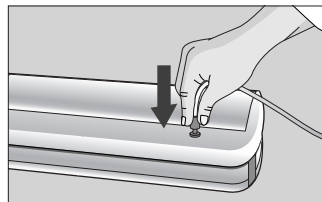

- 5 Insert the other end of the accessory hose into the hole on the top of the jar sealer.

- 6 Place the jar sealer over the top of the mason jar. Push down firmly until the jar sealer covers the entire rim of the jar.

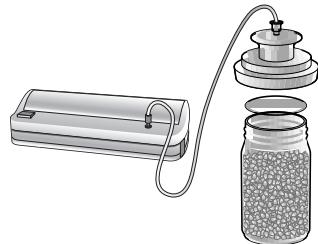

- 7 Close the lid. Lock the lid by pressing in the locks on both sides. (You may need to press down lightly on the stars while pressing in the locks.)

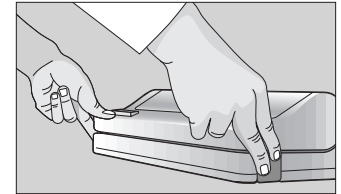

- 8 Press and hold down the On button. The light will turn on as the Vac 550 starts the vacuum cycle and air is removed from the mason jar. **Wait until the sound stops and the light goes off before releasing the lid.**

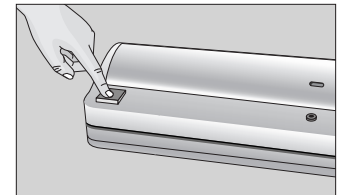

- 9 Gently pull up on the jar sealer to remove it. The metal lid should fit tightly on the jar; you should not be able to pull it off.
- 10 Vacuum packaging is complete.

IMPORTANT: Remember to remove the accessory hose from the accessory port on the Vac 550 before you vacuum package in FoodSaver Bags.

How to Open the Mason Jar

To open the mason jar, wedge a spoon between the mason jar lid and the highest part of the threaded rim. Twist the spoon gently to release the vacuum. When opened this way, the mason jar lid can be reused many times.



IMPORTANT: To avoid accidents, do not use a knife to remove the mason jar lid. Also, do not use a bottle opener to remove the mason jar lid as it will bend the lid and prevent its reuse. Vacuum packaging with the Vac 550 is not a substitute for canning.

How To Vacuum Package Using FoodSaver Universal Lids

FoodSaver Universal Lids give you the flexibility of vacuum packaging some foods in their original containers. They work on most metal cans and glass jars. They're excellent for retaining the freshness of tomato and pasta sauces, coffee, mustards, and toppings. However, vacuum packaged canned foods still must be refrigerated to minimize micro-organism growth. If you are planning to store canned foods for more than a day, transferring foods from the can into a FoodSaver Bag, FoodSaver Canister, a glass, or a hard plastic container is recommended to prevent "off-flavor" from developing from the can.

CAUTION: FoodSaver Universal Lids are not to be used with thin glass, crystal, plastic, or aluminum containers. The vacuum force exerted by the Vac 550 is very powerful and could implode a thin glass or a non-rigid container.

- 1 Place the Vac 550 on a flat, dry surface and plug the power cord into a standard electrical outlet.
- 2 The universal lid is labeled "Open," "Vacuum," and "Closed." Turn the knob on the universal lid so the arrow points to "Vacuum."
- 3 Place the universal lid on top of the open container.
- 4 Insert one end of the accessory hose into the accessory port on the Vac 550.
- 5 Insert the other end of the accessory hose into the hole on the top of the universal lid.

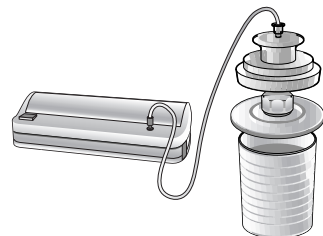
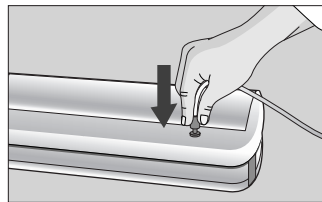
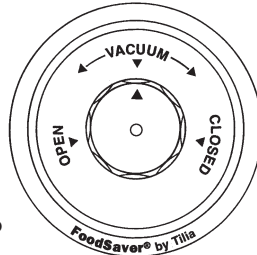

- 6 Close the lid. Lock the lid by pressing in the locks on both sides. (You may need to press down lightly on the stars while pressing in the locks.)
- 7 Press and hold down the On button. The light will turn on as the Vac 550 starts the vacuum cycle and air is removed from the can or jar. **Wait until the sound stops and the light goes off before releasing the lid.**
- 8 Turn the knob on the universal lid so the arrow points to "Closed."
- 9 Vacuum packaging is complete.

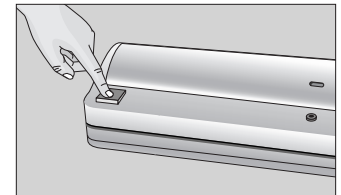
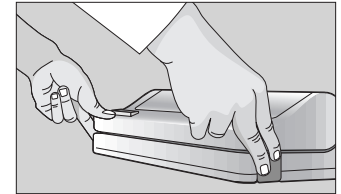

IMPORTANT: Remember to remove the accessory hose from the accessory port on the FoodSaver Vac 550 before you vacuum package in FoodSaver Bags.

How to Open the FoodSaver Universal Lid

To open the FoodSaver Universal Lid, turn the knob so the arrow points to "Open." You should now be able to remove the universal lid from the container.

How to Vacuum Package Using FoodSaver Bottle Stoppers

FoodSaver Bottle Stoppers are the best way to keep wine, oils, and non-carbonated bottled liquids fresh longer. You will keep their delicate taste from going stale by not exposing the liquids to air.

FoodSaver Bottle Stoppers are not to be used with plastic bottles. Also, do not use with any carbonated or sparkling beverages. Carbonation happens under pressure. A vacuum removes this pressure, releasing the bubbles and causing the beverages to become flat.

- 1 Place the Vac 550 on a flat, dry surface and plug the power cord into a standard electrical outlet.
- 2 Insert the bottle stopper into the neck of the bottle. Leave at least one inch between the contents and the bottom of the bottle stopper.
- 3 Insert one end of the accessory hose into the accessory port on the Vac 550.
- 4 Insert the other end of the accessory hose into the hole on the top of the bottle stopper.

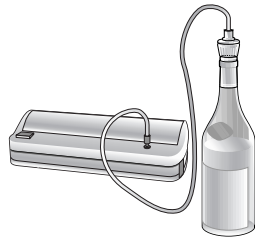

- 5 Close the lid. Lock the lid by pressing in the locks on both sides. (You may need to press down lightly on the stars while pressing in the locks.)
- 6 Press and hold down the On button. The light will turn on as the Vac 550 starts the vacuum cycle and air is removed from the bottle. **Wait until the sound stops and the light goes off before releasing the lid.**
- 7 Remove the accessory hose from the bottle stopper.
- 8 Vacuum packaging is complete.

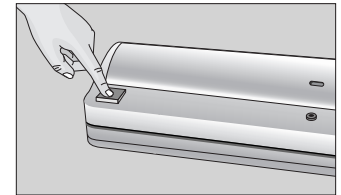
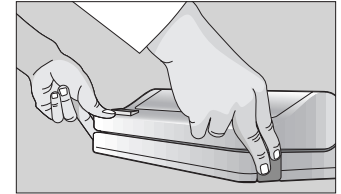

IMPORTANT: Remember to remove the accessory hose from the accessory port on the Vac 550 before you vacuum package in FoodSaver Bags.

How to Remove the FoodSaver Bottle Stopper

To remove the FoodSaver Bottle Stopper, simply twist and pull up on the bottle stopper to release the vacuum.

Care and Cleaning Instructions

The FoodSaver Vac 550

- 1 Always unplug the Vac 550 before cleaning.
- 2 Do not immerse the Vac 550 in water.
- 3 Do not use abrasive products or materials to clean any of the Vac 550 components. Such cleaners can scratch the surfaces and damage the black foam rubber pads, preventing a vacuum from forming.
- 4 Clean using a mild dishwashing soap and a warm, damp cloth. Wipe away any food residue from inside or around the vacuum channel, sealing strip, and black foam rubber pads.
- 5 Dry thoroughly before using.

FoodSaver Bags

- 1 Wash bags in warm water using a mild dishwashing soap.
- 2 Bags can be washed in the dishwasher by carefully turning the bags inside out and spreading them over the top rack of the dishwasher, so that all surfaces are exposed to the washing water.
- 3 Allow bags to dry thoroughly before reusing.

IMPORTANT: We do not recommend reusing bags that have been used to store raw meats or fish. Also, bags may not be reusable if they have been used to store greasy or fatty foods.

FoodSaver Accessories

- 1 All FoodSaver accessories should be washed in warm water using a mild dishwashing soap.
- 2 Dry thoroughly before using.
- 3 All FoodSaver Canister bases (but not the lids) may be washed in the dishwasher.
- 4 Square and Bulk Storage Canister bases (but not the lids) may be used to reheat foods in the microwave.
- 5 Designer Canister bases and lids are not to be used in the microwave.

Food Preparation and Storage Guide

Guidelines for Vacuum Packaging Food

Vacuum packaging is not a substitute for canning nor can it reverse deteriorating quality; it can only slow down changes in quality. It is impossible to predict how long a specific food will have top-quality flavor, appearance, and texture, because it depends on the age and condition of the food on the day it was vacuum packaged. Foods that are extremely fresh will last longer than foods that are already deteriorating.

Vacuum packaging extends the life of foods by removing nearly all the air in a sealed container, thereby reducing oxidation which affects nutritional value, flavor, and overall quality. However, most foods contain enough water to support micro-organisms which can grow with or without air. While micro-organisms are present everywhere, only certain ones cause problems, and only under certain conditions:

- ▶ **Mold:** Easy to identify because of its characteristic fuzz. Molds are virtually eliminated by vacuum packaging because they cannot grow in a low oxygen environment.
- ▶ **Yeast:** Results in fermentation, which can frequently be identified by smell or taste. Yeast requires water, sugar, and a moderate tem-

perature to grow, and can grow with or without air. Refrigeration slows the growth of yeast, and freezing stops it completely.

- ▶ **Bacteria:** Frequently results in discoloration, soft or slimy texture, and/or an unpleasant odor. Clostridium botulinum (the organism that causes Botulism), can grow without air under the right conditions, cannot be detected by smell or taste, and although extremely rare, can be very dangerous.

Maintaining low temperatures is a critical factor in preserving foods safely. Growth of micro-organisms is significantly reduced at temperatures of 40°F (4°C) or below. Freezing at 0°F (-17°C) does not kill micro-organisms, but it stops them from growing. For long term storage, always freeze “perishable” foods that have been vacuum packaged.

Thawing and Heating Vacuum Packaged Foods

Always thaw foods in either the refrigerator or microwave – do not leave perishable foods at room temperature to thaw.

To microwave in a FoodSaver Bag, cut a corner of the bag and place on a microwave-safe dish. You can also place the FoodSaver Bag in boiling water to heat.

NOTE: Vacuum packaging is NOT a substitute for refrigeration or freezing. Any perishable foods that require refrigeration prior to vacuum packaging still must be refrigerated or frozen after vacuum packaging.

Food Preparation and Storage Guide

MEATS/FISH	Where to Store	Recommended FoodSaver Container	Vacuum Packaged Storage Life	Normal Storage Life <i>(without vacuum packaging)</i>
Beef, lamb, and pork	Freezer	FoodSaver Bag	2 to 3 years	6 months
Ground meat	Freezer	FoodSaver Bag	1 year	4 months
Poultry	Freezer	FoodSaver Bag	2 to 3 years	6 months
Fish	Freezer	FoodSaver Bag	2 years	6 months

Preparation Guidelines for Meats/Fish:

Option 1: For best results pre-freeze meats and fish for 1-2 hours before vacuum packaging in a FoodSaver Bag to ensure the retention of juices and shape, and to help guarantee a good seal.

Option 2: If it is not possible to pre-freeze, place a folded paper towel between the meat/fish and the end of the bag. Leave the paper towel in the bag when vacuum packaging to absorb excess moisture and juices.

CHEESES	Where to Store	Recommended FoodSaver Container	Vacuum Packaged Storage Life	Normal Storage Life <i>(without vacuum packaging)</i>
Cheddar, Swiss, Parmesan	Refrigerator	FoodSaver Bag	4 to 8 months	1 to 2 weeks

Preparation Guidelines for Hard Cheeses:

Keep cheese fresh even if you use it everyday by vacuum packaging it with the Vac 550 after each use. Make your original FoodSaver Bag extra long. Simply cut along the sealed edge, remove the cheese and

slice off the amount needed, then place the cheese back in the bag and repackage. Allow approximately one inch of bag material for each time the bag will be opened and repackaged.

Preserve Your Garden Goodness

Your FoodSaver Vac 550 is an invaluable tool to help preserve the quality, freshness, and nutrients of your homegrown vegetables. When vacuum packaging and freezing items from your garden, you can enjoy your harvest year round.

plant will ripen at different times, the Vac 550 allows you to vacuum package small amounts frequently and cost effectively.

- ▶ Select top-quality young, tender produce that is free from mold and decay. Freezing will not improve the quality.
- ▶ Do not select vegetables that have frozen in the garden to use in any preservation method. However, these frozen-on-the-plant vegetables may be acceptable for immediate fresh eating if they are harvested before any decay starts.
- ▶ Clean vegetables thoroughly before freezing and vacuum packaging.

General Harvesting Information

- ▶ It is usually best to pick in the cool of the morning because produce has the best texture then.
- ▶ Harvesting from a home garden gives you the opportunity to enjoy produce that is ripened to perfection. Because different parts of the

LEAFY VEGETABLES	Where to Store	Recommended FoodSaver Container	Vacuum Packaged Storage Life	Normal Storage Life <i>(without vacuum packaging)</i>
Lettuce, Spinach	Refrigerator	Canister	2 weeks	3 to 6 days

Preparation Guidelines for Leafy Vegetables:

Wash vegetables, towel or spin dry, and vacuum package. You can then

open the canister and take what you need each time you make a salad.

Food Preparation and Storage Guide

VEGETABLES	Blanching Times	Where to Store	Recommended FoodSaver Container	Vacuum Packaged Storage Life	Normal Storage Life (without vacuum packaging)
Asparagus	1½ to 3 mins.	Freezer	FoodSaver Bag	2 to 3 years	8 months
Whole kernel corn	4 to 5 mins.	Freezer	FoodSaver Bag	2 to 3 years	8 months
Corn on cob	6 to 11 mins.	Freezer	FoodSaver Bag	2 to 3 years	8 months
Snow peas	1½ to 2 mins.	Freezer	FoodSaver Bag	2 to 3 years	8 months
Sugar snap peas	1½ to 2 mins.	Freezer	FoodSaver Bag	2 to 3 years	8 months
Green beans	3 mins.	Freezer	FoodSaver Bag	2 to 3 years	8 months
Broccoli	3 to 4 mins.	Freezer	FoodSaver Bag	2 to 3 years	8 months
Brussels sprouts	3 to 5 mins.	Freezer	FoodSaver Bag	2 to 3 years	8 months
Cabbage	3 to 5 mins.	Freezer	FoodSaver Bag	2 to 3 years	8 months
Cauliflower	3 to 4 mins.	Freezer	FoodSaver Bag	2 to 3 years	8 months

Preparation Guidelines for Vegetables:

- ▶ Vegetables should be blanched before vacuum packaging. This stops the enzyme action, which will eventually cause loss of flavor, color, and texture.
- ▶ Blanch vegetables by placing them in boiling water or in the microwave until they are cooked but still crisp. Immerse in cold water to stop the cooking process. Dry vegetables on a towel, then freeze.
- ▶ To freeze vegetables in individual servings, place them on baking sheets and spread out so that pieces are not touching. This way they will not freeze together in a block.
- ▶ Place baking sheet in the freezer for 1-2 hours until the pieces are solidly frozen.
- ▶ Vacuum package in a FoodSaver Bag and return to the freezer for long-term storage. Remember, you can microwave and boil FoodSaver Bags right from the freezer.
- ▶ Strong-smelling vegetables emit gases during storage. Therefore, they must be stored in the freezer only.

FRUITS	Where to Store	Recommended FoodSaver Container	Vacuum Packaged Storage Life	Normal Storage Life (without vacuum packaging)
Apricots, Nectarines, Peaches, Plums, All types of berries	Freezer	FoodSaver Bag	1 to 3 years	6 to 12 months
All types of berries	Refrigerator	Canister	1 to 2 weeks*	1 to 6 days

Preparation Guidelines for Fruits:

For best results, before vacuum packaging soft fruits or berries in a FoodSaver Bag, pre-freeze for 1-2 hours or until solidly frozen. To freeze fruits in individual servings, place sliced fruit or berries on a baking sheet and spread out so the pieces are not touching. This way they will not freeze together in a block. Then vacuum package in

portions for baking, or in your favorite combinations for easy fruit salad all year round.

Keep berries fresh longer in the refrigerator by repackaging them in a FoodSaver Canister. You can open the canister and take what you need for snacks or fruit salad, then reseal to maintain freshness.

***NOTE: Blueberries and cranberries will usually last about two weeks and softer berries such as boysenberries, blackberries, raspberries, and strawberries can be stored for approximately one week.**

Food Preparation and Storage Guide

BAKED GOODS	Where to Store	Recommended FoodSaver Container	Vacuum Packaged Storage Life	Normal Storage Life <i>(without vacuum packaging)</i>
Bread/rolls, Bagels/pastries	Freezer	FoodSaver Bag	1 to 3 years	6 to 12 months

Preparation Guidelines for Baked Goods:

Before vacuum packaging soft or airy baked goods, pre-freeze for 1-2 hours or until solidly frozen so that they will hold their shape. You can bake a double batch of bread or multiple pie shells and vacuum package the extras for later use. Also, you can vacuum package treats such as peanut brittle and fudge to send as gifts.

NUTS	Where to Store	Recommended FoodSaver Container	Vacuum Packaged Storage Life	Normal Storage Life <i>(without vacuum packaging)</i>
Walnuts, Pistachios, Almonds, Peanuts, Sunflower seeds	Pantry	FoodSaver Bag, Canister	2 years	6 months

Preparation Guidelines for Nuts:

Vacuum packaging eliminates the stale or rancid flavor nuts often get when stored. Plus, it eliminates the growth of molds that commonly occur with nuts. Keep nuts fresh by vacuum packaging them with the Vac 550. You can open the container and take what you need for baking or snacks and then repackage it. If using a FoodSaver Bag, allow approximately one inch of extra bag material for each time the bag will be opened and repackaged.

COFFEE	Where to Store	Recommended FoodSaver Container	Vacuum Packaged Storage Life	Normal Storage Life <i>(without vacuum packaging)</i>
Beans	Freezer	FoodSaver Bag	2 to 3 years	6 to 9 months
Ground	Freezer	FoodSaver Bag	2 years	6 months
Beans	Pantry	FoodSaver Bag, Canister	1 year	3 months
Ground	Pantry	Canister	5 to 6 months	1 month

Preparation Guidelines for Coffee:

When vacuum packaging ground coffee in a FoodSaver Bag, leave coffee in the original bag or place into a regular plastic bag and then place that bag into a FoodSaver Bag

for vacuum packaging. This will prevent grounds from being drawn into the vacuum pump and helps guarantee a good seal.

PREPARED LIQUIDS	Where to Store	Recommended FoodSaver Container	Vacuum Packaged Storage Life	Normal Storage Life <i>(without vacuum packaging)</i>
Soups, Stews, Sauces, Other liquids	Freezer	FoodSaver Bag	1 to 2 years	3 to 6 months

Preparation Guidelines for Prepared Liquids:

To vacuum package liquids for freezer storage, pre-freeze them first in a casserole or loaf pan until they are solid. Remove from the pan and vacuum package in a FoodSaver Bag. These "frozen bricks" stack conveniently in

your freezer and can go right into boiling water or the microwave when you are ready to use them. This same technique can be used for pre-cooked dinners and leftovers.

Food Preparation and Storage Guide

BOTTLED LIQUIDS	Where to Store	Recommended FoodSaver Container	Vacuum Packaged Storage Life	Normal Storage Life <i>(without vacuum packaging)</i>
Oils <i>(with no preservatives such as safflower, canola, corn oil)</i>	Pantry	Bottle Stopper	1 to 1½ years	5 to 6 months
Wine	Refrigerator	Bottle Stopper	2 to 4 months	1 to 3 weeks

Preparation Guidelines for Bottled Liquids:

Leave at least one inch of room between the contents and the bottom of the bottle stopper before vacuum packaging bottled liquids.

DRY FOODS	Where to Store	Recommended FoodSaver Container	Vacuum Packaged Storage Life	Normal Storage Life <i>(without vacuum packaging)</i>
Rice/risotto, Pasta, Beans, Grains	Pantry	FoodSaver Bag, Canister	1 to 2 years	6 months

Preparation Guidelines for Dry Foods:

Before vacuum packaging dry foods with sharp edges in a FoodSaver bag, such as rice and pasta, wrap the food in cushioning material, like a paper towel. This will help protect the FoodSaver Bag from punctures.

POWDERY FOODS	Where to Store	Recommended FoodSaver Container	Vacuum Packaged Storage Life	Normal Storage Life <i>(without vacuum packaging)</i>
Flour/sugar, Dry milk, Brown sugar, Dried coconut	Pantry	FoodSaver Bag, Canister	1 to 2 years	6 months

Preparation Guidelines for Powdery Foods:

For best results when vacuum packaging powdery foods in a FoodSaver Bag, leave the item in its original bag, then place that bag inside a FoodSaver Bag. This keeps fine or powdery food from being drawn into the vacuum pump and helps to guarantee a good seal.

Keep powdery foods fresh and protect them from insect infestation by repackaging them with the Vac 550 after each use. You can open the container and take what you need for baking or cooking.

NOTE: Placing a box inside a FoodSaver Bag may puncture the bag. Therefore, it is best to use the inner bag in which most powdery foods are generally packaged.

SNACK FOODS	Where to Store	Recommended FoodSaver Container	Vacuum Packaged Storage Life	Normal Storage Life <i>(without vacuum packaging)</i>
Crackers, chips, cookies	Pantry	Canister	3 to 6 weeks	1 to 2 weeks

Preparation Guidelines for Snack Foods:

Keep snack foods fresh even if you use them everyday by vacuum packaging them with the Vac 550. Open

the canister, take what you need, then repackage it to maintain freshness.

Important Safeguards

For Your Own Safety, Always Follow These Basic Safety Precautions When Using the FoodSaver Vac 550:

- 1 Read the instructions carefully.
- 2 Do not use the Vac 550 on wet or hot surfaces, or near a heat source.
- 3 Do not immerse any part of the Vac 550, power cord or plug into water or other liquid.
- 4 To disconnect, unplug the power cord from the electrical outlet. Do not disconnect by pulling on the cord.
- 5 Do not operate the Vac 550 with a damaged power cord or plug. Do not operate the Vac 550 if it malfunctions or is in any way damaged. If the cord or the machine is damaged, it must be returned to an authorized service center.
- 6 Do not use an extension cord with the FoodSaver 550.
- 7 Use only accessories or attachments recommended by Tilia, Inc.
- 8 Use the Vac 550 only for its intended use.
- 9 Closely supervise children when using any electrical appliance. Do not allow the Vac 550 to be used as a toy.
- 10 **120v Machines Only:** The Vac 550 has a polarized plug (one blade is wider than the other). To reduce the risk of electrical shock, this plug is intended to fit in a polarized outlet only one way. If the plug does not fit fully in the outlet, reverse the plug. If it still does not fit, contact a qualified electrician. Do not modify the plug in any way.

Troubleshooting

Nothing Happens When the On Button Is Pressed:

- 1 Make sure the power cord is firmly plugged into the electrical outlet.
- 2 Make sure the power cord is not damaged in any way.
- 3 Make sure the electrical outlet is operative by plugging in another appliance.
- 4 Wait 20 minutes to allow the Vac 550 to cool off, and then try using it again. The Vac 550 will shut off automatically if it becomes too hot. To keep the machine from becoming too hot:
 - a. Wait at least 20 seconds for the machine to cool down after vacuum packaging and/or sealing before attempting to vacuum and/or seal another bag.
 - b. Keep the lid open before vacuuming and/or sealing another bag.

Air Is Not Removed From the Bag:

- 1 Make sure the open end of the bag is resting entirely inside the vacuum channel. Make sure you are not putting the edge of the bag beyond the vacuum channel.
- 2 Check the bag for leaks. Seal the bag with some air in it. Submerge it in water and apply pressure. Bubbles indicate a leak. If the bag has a leak, you need to use a new bag.
- 3 If using a custom-sized FoodSaver Bag, check the seal of the bag. There may be a wrinkle in the bag along the seal, which causes leakage and prevents air from being removed. Cut the bag and reseal the edge.
- 4 Do not attempt to make your own side seams for a FoodSaver Bag. They are manufactured with special side seams, which are sealed all the way to the outer edge. Making your own side seams may leave air pockets, which will cause leakage and prevent air from being completely removed.

Troubleshooting

Air Was Removed From the Bag, But Has Come Back Into the Bag:

- 1** Check the seal of the bag. There may be a wrinkle in the bag along the seal, which caused leakage and allowed air to come back into the bag. Cut the bag open, and vacuum package it again.
- 2** Moisture or food material (i.e. juices, grease, crumbs, powders, etc.) along the seal may have caused leakage and allowed air to come back into the bag. Cut the bag open, wipe the top inside of the bag material to clear away any moisture or food residue, then vacuum package the bag again. See the "Food Preparation and Storage Guide" in this User Manual for guidelines for specific foods.
- 3** Food items with sharp edges may have punctured the bag. If you find a puncture hole, you will need to use a new FoodSaver Bag. Make sure to protect the bag from puncture holes by wrapping the items in cushioning material such as a paper towel.
- 4** If you find none of these conditions identified in 1-3 (above), and the bag appears to have air inside, fermentation or the release of natural gases from inside the foods may have occurred. This could indicate that the food may have begun to spoil and should be discarded.

The Bag Melts:

- 1** The sealing strip may have become too hot. Always wait at least 20 seconds for the Vac 550 to cool down before vacuuming and/or sealing another bag.

The Bag Will Not Seal:

- 1** Wait 20 minutes to allow the Vac 550 to cool off, then try using it again. The Vac 550 will shut off automatically if it becomes too hot. To help prevent the machine from becoming too hot:
 - a.** Wait at least 20 seconds for the machine to cool down after vacuum packaging and/or sealing before attempting to vacuum and/or seal another bag.
 - b.** Keep the lid open before vacuuming and/or sealing another bag.

The Mason Jar or FoodSaver Canister Will Not Vacuum:

- 1** Make sure the jar sealer is centered and pressed firmly over the lid on the mason jar.
- 2** Make sure the rubber gasket on the canister/mason jar lid is free from food materials, crumbs, etc.
- 3** Make sure the rim of the canister or mason jar does not have any cracks or scratches. Any gaps can prevent a vacuum from forming.
- 4** Make sure you aren't filling the canister or mason jar too full prior to vacuum packaging. Always leave at least one inch (1") between the contents and the lid.
- 5** Make sure the metal lid of the mason jar is not bent.

The FoodSaver Universal Lid Will Not Vacuum:

- 1** Make sure that the rim of the container is smooth and flat. Ragged edges will prevent a vacuum from forming.
- 2** Make sure the rubber gasket underneath the universal lid and the rim of the container are free from food materials, crumbs, etc.
- 3** Make sure the knob on the universal lid is closing and opening properly and that there are no food materials caught inside.

The FoodSaver Bottle Stopper Will Not Vacuum:

- 1** Make sure the bottle stopper is fitting snugly inside the bottle. If it is loose, air may leak in and prevent a vacuum from forming.
- 2** Make sure the neck of the bottle and tip of the hose attachment are free from food materials, crumbs, etc. Any gaps will prevent a vacuum from forming.

If You Cannot Fix the Problem:

Call our Consumer Services Department at the number listed at the back of this manual.

Marinating Recipes

You can marinate in a fraction of the usual time with FoodSaver Canisters. What usually takes hours to marinate takes only about 20 minutes when you vacuum package your food. All FoodSaver Canisters work for marinating, but we recommend the Square FoodSaver Canister because less marinade will be needed.

IMPORTANT:

- 1** Do not attempt to vacuum package any contents that are warmer than room temperature since the vacuum may cause the contents to bubble out of the container.
- 2** Leave at least one inch between the top of the contents and the canister rim.
- 3** The Square and Bulk Storage Canister bases can be used in the microwave to reheat food. However, do not put lids in the microwave. Also, do not put either part of the FoodSaver Designer Canisters in the microwave.

	Broiling/Grilling	Baking
Pork	Closest to heat source. 12 mins. per inch – turn once.	Not recommended
Beef	Closest to heat source. 10 mins. per inch – turn once.	Not recommended
Shrimp	Closest to heat source. 3-4 mins. per side.	Bake at 400° for 6-10 mins.
Fish	Furthest from heat source. 4-5 mins. per side.	Bake at 400° for 6-10 mins. per inch
Poultry with bone	Closest to heat source. 4-5 mins. per side.	Bake at 350° for 8-10 mins.
Poultry without bone	Closest to heat source. 12-14 mins.	Bake at 350° for 8-10 mins.
Vegetables	Closest to heat source. Time varies – see recipes.	Not recommended

Spicy Citrus Marinated Chicken

Serves 4

Ingredients needed:

1/4 to 1 1/2 lbs. boneless, skinless chicken thighs
 2 tablespoons each lemon, lime, orange juice
 1 tablespoon olive oil
 1 teaspoon cumin
 1 teaspoon chili powder
 1 teaspoon crushed garlic
 1/2 teaspoons minced jalapeño peppers

Place chicken thighs in FoodSaver Canister. Combine remaining ingredients. Pour over chicken thighs. Vacuum package. Marinate for 15-20 minutes in the refrigerator.

Remove chicken from the canister and broil, grill, or bake. See cooking chart for times.

Yogurt Marinated Chicken

Serves 4

Ingredients needed:

2 large chicken breasts – split (about 8 oz. each)
 1 tablespoon olive oil
 2 teaspoons cumin
 2 teaspoons coriander
 2 teaspoons paprika
 1/4 cup minced onion
 2 tablespoons lime juice
 1/2 cup plain yogurt
 1/4 teaspoon salt

Heat oil in small saucepan and add cumin, coriander, and paprika. Cook for a minute or two until aromatic. Remove from heat and add rest of ingredients. Let cool completely. Place chicken breasts in FoodSaver Canister. Pour marinade over chicken breasts. Vacuum package. Marinate 15-20 minutes in the refrigerator.

Remove chicken from the canister and broil, grill, or bake. See cooking chart for times.

Marinating Recipes

Pork New Orleans

Serves 4

Ingredients needed:

- 1½ lbs. pork sirloin
- ½ cup strong coffee
- ¼ cup molasses
- ¼ cup balsamic or red wine vinegar
- 2 tablespoons Dijon mustard
- ⅛ teaspoon cayenne pepper
- ¼ teaspoon salt

Place pork sirloin in FoodSaver Canister. Combine all ingredients and pour over pork sirloin. Vacuum package. Marinate 15-20 minutes in the refrigerator.

Remove pork from the canister and broil or grill. See cooking chart for times.

Steak Provençal

Serves 4-6

Ingredients needed:

- 1½ lbs. top sirloin steak
- 1 tablespoon Dijon mustard
- 1 tablespoon coarse mustard
- 2 tablespoons red wine
- 2 tablespoons balsamic vinegar
- 1½ tablespoons dry thyme, crumbled
- ½ teaspoon coarse black pepper
- 3 large garlic cloves

Combine all ingredients and place in FoodSaver Canister. Vacuum package. Marinate 15-20 minutes in the refrigerator.

Remove steak from the canister and broil or grill. See cooking chart for times.

Indonesian Marinated Flank Steak

Serves 4-6

Ingredients needed:

- 1½ to 1¾ lbs. flank steak
- 2 tablespoons chunky peanut butter
- 3 tablespoons light soy sauce
- 2 tablespoons lime juice
- 2 tablespoons orange juice
- 1½ teaspoons grated fresh ginger

Place flank steak in a FoodSaver Canister. Combine remaining ingredients. Pour over flank steak. Vacuum package. Marinate 15-20 minutes in the refrigerator.

Remove steak from canister and broil or grill. See cooking chart for times.

Smoked Salmon

Serves 4-6

Ingredients needed:

- 2½ lbs. fresh salmon filet
- 1 quart water (or enough to cover the salmon)
- 1 cup firmly packed dark brown sugar
- ¼ cup salt – should be salty to taste
- 2 bay leaves
- 1 tablespoon fresh grated ginger
- 6 whole allspice cloves crushed
- Honey to taste

In a 2-quart sauce pan combine water, brown sugar, salt, bay leaves, ginger, and allspice. Bring to rapid boil; stir until brown sugar is dissolved. Remove from heat. Let cool completely. In a FoodSaver Canister, place filet of salmon skin down. Pour cooled brine liquid over salmon to cover.

Vacuum package and refrigerate for approximately 4 hours. Remove salmon from canister and discard brine liquid. Rinse salmon thoroughly. Pat dry. Spread a layer of honey over flesh side of salmon. Sprinkle with coarsely ground pepper. Salmon is now ready to be smoked to desired consistency.

(Note: This recipe also works well with trout.)

Marinating Recipes

Salsa Marinated Shrimp

Serves 4-6

Ingredients needed:

1¼ lbs. shrimp, cleaned and de-veined
 2 tablespoons minced red onion
 6 cloves of garlic pressed or minced
 4 tablespoons lime juice
 1 large tomato chopped (about ¾ cup)
 4 tablespoons olive oil
 ½ cup minced cilantro

In FoodSaver Canister, combine onion, garlic, lime juice, and tomato until smooth. Slowly add oil until completely combined, then add cilantro. Salt to taste. Add shrimp to canister. Vacuum package. Marinate 15-20 minutes in the refrigerator.

Remove the shrimp from the canister and broil or grill. See cooking chart for time. (Easiest to cook if skewered.)

Mixed Marinated Vegetables

Serves 4

Ingredients needed:

1 lb. assorted squash (green zucchini, yellow crookneck, summer squash, patty pan squash)
 1 large bell pepper
 1 tablespoon balsamic or red wine vinegar
 1 tablespoon basil
 1 tablespoon dried thyme (crumbled)
 1 teaspoon Dijon mustard
 1 tablespoon olive oil

Cut squash into ¼" slices. Cut bell pepper into 1" strips. Combine all ingredients in a FoodSaver Canister. Vacuum package. Marinate 15-20 minutes in the refrigerator.

If using an oven, lay vegetables in a single layer on a baking sheet and broil 3-4 minutes on each side closest to the heat source. Follow the same instructions for grilling as for broiling. Serve hot or at room temperature.

Vacuum Packaging Non-Food Items

Your FoodSaver Vac 550 also protects non-food items from oxidation, corrosion, and moisture. Just follow the directions for vacuum packaging using the FoodSaver Bags or accessories.

- ▶ Vacuum package your silver. Without exposure to air, the silver will not tarnish. Be sure to cover fork tines in something cushioning like a paper towel, so they won't puncture the bag.
- ▶ Vacuum package your children's clay, so that it won't dry out and get cracked.
- ▶ Camping and hiking gear stays dry and compact. Vacuum packaging your clothes and equipment will help save space in your pack. Vacuum package matches, maps, and anything you want to stay dry.
- ▶ For picnics, fill a FoodSaver Bag with ice and seal. When it melts, you'll have fresh water for drinking or you can put it back in the freezer as a reusable ice pack.
- ▶ Vacuum package your food and equipment for a boating or sailing outing. Food will stay dry in the cooler, batteries and film won't get damaged by water, and you'll appreciate having a dry change of clothes.
- ▶ FoodSaver Bags are also great for storing extra keys or any spare parts you need for your boat. They will be dry and in one place.
- ▶ Vacuum package first aid kits and emergency kits for your house, your boat, and your car. Items will all be in one package and will stay dry and without dirt and mold. Include flares, batteries, flashlight, candles, and matches.
- ▶ Vacuum package extra spark plugs and precision tools that always seem to get lost. Seal nuts, bolts, and screws by size in separate bags.
- ▶ Keep the leftover oil from deep fryers from turning rancid. After the oil has cooled down, strain it into mason jars or FoodSaver Canisters and vacuum package.

Warranty and Service Information

ONE-YEAR LIMITED WARRANTY

The following warranty policy applies only to the original consumer of this product and is not transferable. Evidence of original purchase is required for warranty service (this could be the sales receipt or packing slip, etc).

Elements of Warranty

Tilia, Inc. ("Tilia") warrants, for one year from the date of purchase, to the original consumer, this product to be free from defects in materials and workmanship under intended normal use subject only to the limitations and exclusions set out below.

Warranty Limitation and Duration

This warranty to the original consumer shall terminate and be of no further effect 12 months after the date of the original purchase. This warranty is invalid if this product is:

- a. Used for commercial or rental purposes;
- b. Damaged or carelessly or improperly maintained, misused, abused, or is not operated in accordance with the operating instructions as explained in the User Manual.

- c. Serviced or repaired by persons other than those authorized by Tilia, Inc.
- d. Modified, aligned, altered, or tampered with.
- e. Damaged due to natural disasters including but not limited to lightning or power surges.
- f. Used in any conjunction with equipment or parts or as part of any System not manufactured by Tilia.

Statement of Remedy

In the event the product does not conform to this warranty at any time while this warranty is in effect, Tilia will repair or replace the product (at Tilia's option) and return it to you without charge for parts, services, or any other cost (except shipping and handling) incurred by Tilia or its representative in connection with the performance of this warranty. **The limited warranty set forth above is the sole and entire warranty pertaining to the product and is in lieu of and excludes all other warranties of any nature whatsoever, whether express, implied, or arising by operation**

of law, including, but not limited to any implied warranties of merchantability or fitness for a particular purpose. This warranty does not cover or provide for the reimbursement or payment of incidental or consequential damages. Some states do not allow this exclusion or limitation of incidental or consequential damages so the above limitation or exclusion may not apply to you.

Legal Remedies

This warranty gives you specific legal rights. You may also have other rights which vary from state to state.

This warranty is void outside North America (the United States, its possessions, Canada, and Mexico).

Procedure for Obtaining Performance Warranty

Before you return your product for warranty repair, call Tilia's Consumer Services Department listed below for complete shipping instructions and a Return Authorization (RA) number. Any product returned for warranty repair must be delivered freight prepaid in either its original packaging or packaging affording an equal degree of protection.

IF YOU NEED SERVICE

If you have any questions concerning service of this product, please contact:

Tilia, Inc.

P.O. Box 194530
San Francisco, CA 94119-4530
www.foodsaver.com
cust_service@tilia.com

Toll-Free Consumer Services Support

United States: 1.800.777.5452
Canada: 1.877.804.5383

Evidence of original purchase is required, so **it is important to hold onto your sales receipt or packing slip.**

©2000 by Tilia, Inc. All Rights Reserved.
This material may not be copied or reproduced in any
fashion without written permission from the publisher.

FoodSaver® is a registered trademark of Tilia, Inc.

First printing, June 2000
Printed in the United States of America

FoodSaver Patent 4,941,310
FoodSaver Bag Patent RE: 34,929

Item# 18-0501 (10/00)

Free Manuals Download Website

<http://myh66.com>

<http://usermanuals.us>

<http://www.somanuals.com>

<http://www.4manuals.cc>

<http://www.manual-lib.com>

<http://www.404manual.com>

<http://www.luxmanual.com>

<http://aubethermostatmanual.com>

Golf course search by state

<http://golfingnear.com>

Email search by domain

<http://emailbydomain.com>

Auto manuals search

<http://auto.somanuals.com>

TV manuals search

<http://tv.somanuals.com>