

Contents

Before driving

Introduction	2
Instrumentation	4
Controls and features	13
Seating and safety restraints	34

Starting and driving

Starting	59
Driving	63
Roadside emergencies	77

Servicing

Maintenance and care	95
Capacities and specifications	129
Reporting safety defects	139
Index	140

All rights reserved. Reproduction by any means, electronic or mechanical including photocopying, recording or by any information storage and retrieval system or translation in whole or part is not permitted without written authorization from Ford Motor Company.

Copyright © 1997 Ford Motor Company

Introduction

ICONS

Indicates a warning. Read the following section on *Warnings* for a full explanation.



Indicates vehicle information related to recycling and other environmental concerns will follow.



Correct vehicle usage and the authorized disposal of waste cleaning and lubrication materials are significant steps towards protecting the environment.

WARNINGS

Warnings provide information which may reduce the risk of personal injury and prevent possible damage to others, your vehicle and its equipment.

BREAKING-IN YOUR VEHICLE

There are no particular breaking-in rules for your vehicle. During the first 1 600 km (1 000 miles) of driving, vary speeds frequently. This is necessary to give the moving parts a chance to break in.

If possible, you should avoid full use of the brakes for the first 1 600 km (1 000 miles).

INFORMATION ABOUT THIS GUIDE

The information found in this guide was in effect at the time of printing. Ford may change the contents without notice and without incurring obligation.

SPECIAL NOTICES

Using your vehicle as an ambulance

If your light truck is equipped with the *Ford ambulance preparation package*, it may be utilized as an ambulance. Ford urges ambulance manufacturers to follow the recommendations of the *Ford incomplete vehicle manual*, *Ford truck body builder's layout book* and the *QVM guidelines* as well as pertinent supplements. For additional information, please contact the Light Truck Body Builders Advisory Service 1-800-635-5560.

Use of your Ford light truck as an ambulance, without the Ford Ambulance Preparation Package voids the Ford New Vehicle Limited Warranty and may void the Emissions Warranties. In addition, ambulance usage without the preparation package could cause high underbody temperatures, overpressurized fuel and a risk of spraying fuel which could lead to fires.

If your vehicle is equipped with the Ford ambulance preparation package, it will be indicated on the Safety Certification Compliance label. The label is located on the driver's side door pillar or on the rear edge of the driver's door. You can determine whether the ambulance manufacturer followed Ford's recommendations by directly contacting that manufacturer. Ford Ambulance preparation package is only available on certain 7.3L Diesel engine equipped vehicles.

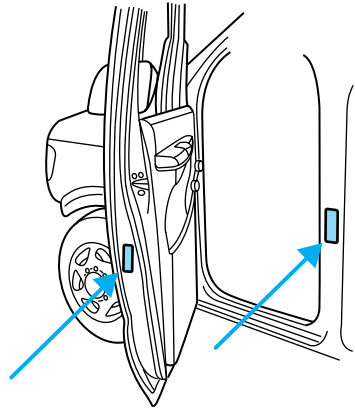

Diesel-powered vehicles

Read the 7.3L Diesel Engine Owner's Guide Supplement for information regarding correct operation and maintenance of your diesel-powered light truck.

Instrumentation

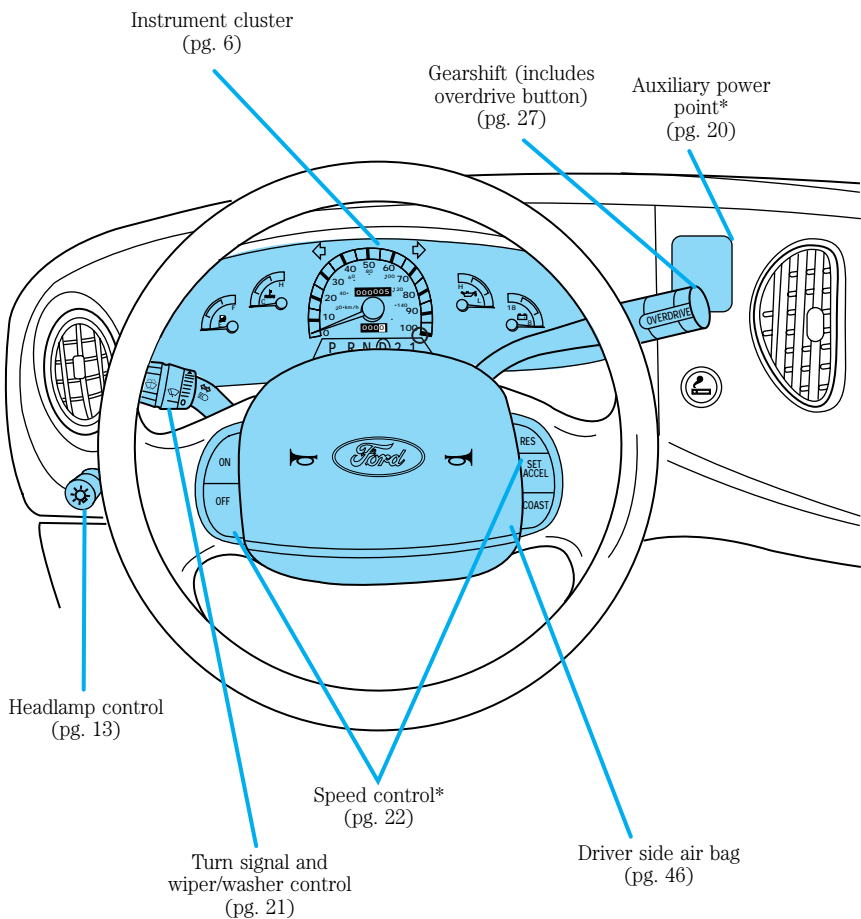

*if equipped

Instrumentation

Climate control systems
(pg. 14)

Electronic sound system;
refer to Audio Guide
(pg. 20)

Passenger side air bag
(pg. 46)

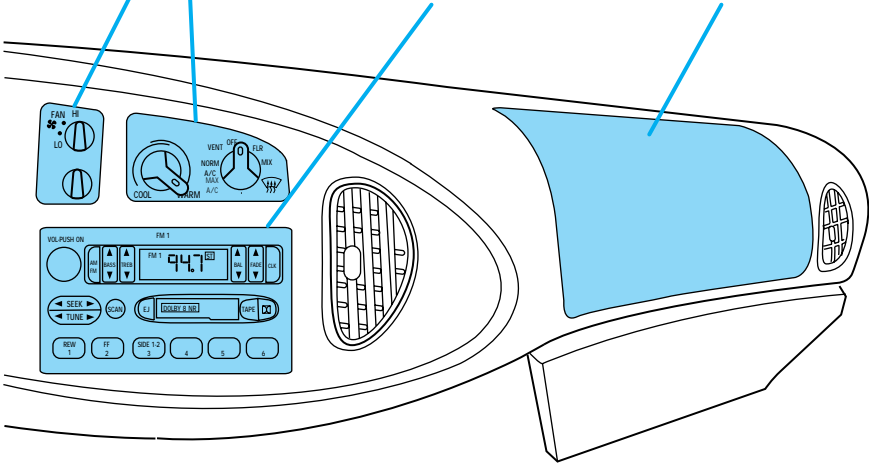

Instrumentation

WARNING LIGHTS AND CHIMES

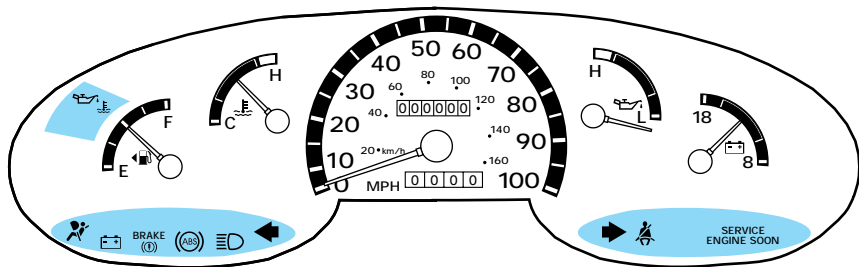

Brake system warning

Momentarily illuminates when the ignition is turned to the position ON and the engine is off. Also illuminates when the parking brake is engaged. Illumination after releasing the parking brake indicates low brake fluid level.



Anti-lock brake system (ABS) (If equipped)

Momentarily illuminates when the ignition is turned on and the engine is off. If the light stays on, the ABS needs to be serviced.



Service engine soon

Your vehicle is equipped with a computer that monitors the engine's emission control system. This system is commonly known as the On Board Diagnostics System (OBD II). This OBD II system protects the environment by ensuring that your vehicle continues to meet government emission standards. The OBD II system also assists the service technician in properly servicing your vehicle.



The *Service Engine Soon* indicator light illuminates when the ignition is first turned to the ON position to check the bulb. If it comes on after the engine is started, one of the engine's emission control systems may be malfunctioning. The light may illuminate without a driveability concern being noted. The vehicle will usually be drivable and will not require towing.

What you should do if the Service Engine Soon light illuminates

Light turns on solid:

This means that the OBD II system has detected a malfunction.

Temporary malfunctions may cause your *Service Engine Soon* light to illuminate. Examples are:

1. The vehicle has run out of fuel. (The engine may misfire or run poorly.)
2. Poor fuel quality or water in the fuel.
3. The fuel cap may not have been properly installed and securely tightened.

These temporary malfunctions can be corrected by filling the fuel tank with good quality fuel and/or properly installing and securely tightening the gas cap. After three driving cycles without these or any other temporary malfunctions present, the *Service Engine Soon* light should turn off. (A driving cycle consists of a cold engine startup followed by mixed city/highway driving.) No additional vehicle service is required.

If the *Service Engine Soon* light remains on, have your vehicle serviced at the first available opportunity.

Light is blinking:

Engine misfire is occurring which could damage your catalytic converter. You should drive in a moderate fashion (avoid heavy acceleration and deceleration) and have your vehicle serviced at the first available opportunity.



Under engine misfire conditions, excessive exhaust temperatures could damage the catalytic converter, the fuel system, interior floor coverings or other vehicle components, possibly causing a fire.

Instrumentation

Transmission control indicator light (TCIL)

The word OFF located on the end of the gearshift lever is the transmission control indicator light (TCIL).

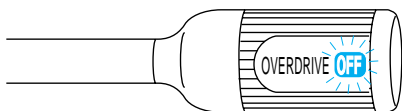

The TCIL may flash steadily if a malfunction is detected. If the TCIL is flashing, contact your Ford dealer as soon as possible. If this condition persists, damage to the transmission could occur.

Safety belt

Momentarily illuminates when the ignition is turned to the ON position to remind you to fasten your safety belts. For more information, refer to the *Seating and safety restraints* chapter.



Charging system

Momentarily illuminates when the ignition is turned to the ON position and the engine is off. The light also illuminates when the battery is not charging properly, requiring electrical system service.

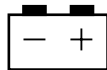

Air bag readiness

Momentarily illuminates when the ignition is turned ON. If the light fails to illuminate, continues to flash or remains on, have the system serviced immediately.



Turn signal

Illuminates when the left or right turn signal or the hazard lights are turned on. If one or both of the indicators stay on continuously, check for a burned-out turn signal bulb. Refer to *Exterior bulbs* in the *Maintenance and care* chapter.

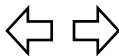

High beams

Illuminates when the high beam headlamps are turned on.



Oil pressure/Engine coolant

This light will come on when the key is in the ON position and the:

- engine coolant temperature is very high
- engine oil pressure is low

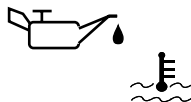

The light serves as a notice that a system needs your attention and to check the engine coolant temperature gauge and the engine oil pressure gauge.

Refer to *Engine coolant temperature gauge* and *Engine oil pressure gauge* in this chapter for more information.

Safety belt warning chime

Chimes to remind you to fasten your safety belts.

For information on the safety belt warning chime, refer to the *Seating and safety restraints* chapter.

Supplemental restraint system (SRS) warning chime

For information on the SRS warning chime, refer to the *Seating and safety restraints* chapter.

Key-in-ignition warning chime

Sounds when the key is left in the ignition in the OFF/LOCK or ACC position and either front door is opened.

Headlamps on warning chime

Sounds when the headlamps or parking lamps are on, the ignition is off (and the key is not in the ignition) and the driver's door is opened.

Instrumentation

GAUGES

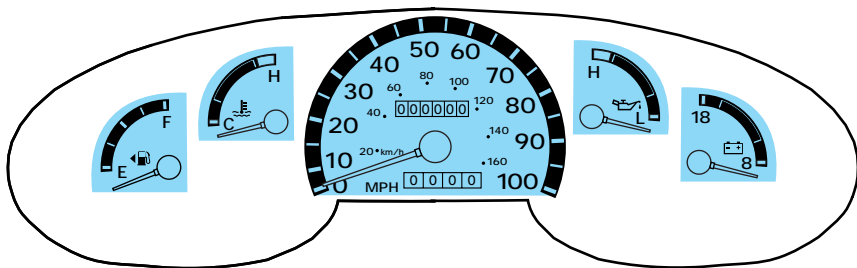

Speedometer

Indicates the current vehicle speed.

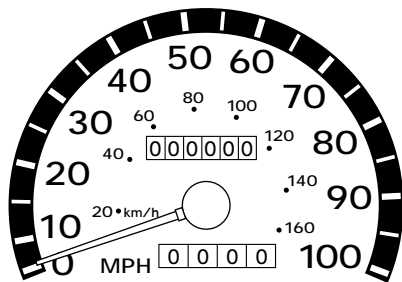

Fuel gauge

Displays approximately how much fuel is in the fuel tank (when the key is in the ON position). The fuel gauge may vary slightly when the vehicle is in motion. The ignition should be in the OFF position while the vehicle is being refueled. When the gauge first indicates empty, there is a small amount of reserve fuel in the tank. When refueling the vehicle from empty indication, the amount of fuel that can be added will be less than the advertised capacity due to the reserve fuel.

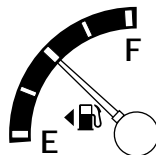

Engine coolant temperature gauge

Indicates the temperature of the engine coolant. At normal operating temperature, the needle remains within the normal area (the area between the “H” and “C”). If it enters the red section, the engine is overheating. Stop the vehicle as soon as safely possible, switch off the engine immediately and let the engine cool. Refer to *Engine coolant* in the *Maintenance and care* chapter.

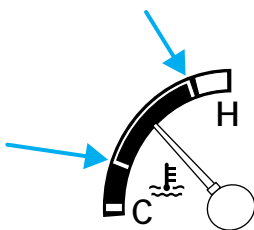

Never remove the coolant recovery cap while the engine is running or hot.

This gauge indicates the temperature of the engine coolant, not the coolant level. If the coolant is not at its proper level the gauge indication will not be accurate.

Engine oil pressure gauge

This shows the engine oil pressure in the system. Sufficient pressure exists as long as the needle remains in the normal range (the area between the “H” and “L”).

If the gauge indicates low pressure, stop the vehicle as soon as safely possible and switch off the engine immediately. Check the oil level. Add oil if needed (refer to *Checking and adding engine oil* in the *Maintenance and care* chapter). If the oil level is correct, have your vehicle checked at your dealership or by a qualified technician.

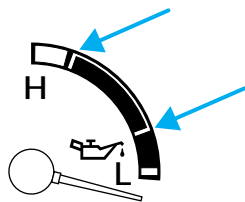

Instrumentation

Battery voltage gauge

This gauge shows the battery voltage when the ignition is in the ON position. If the pointer moves and stays outside the normal operating range (as indicated), have the vehicle's electrical system checked as soon as possible.

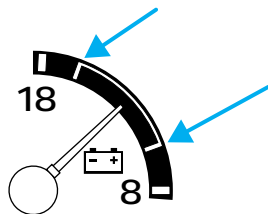

Odometer

Registers the total kilometers (miles) of the vehicle.

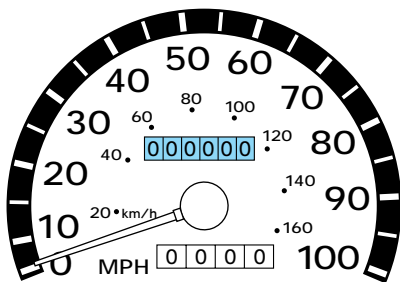

Trip odometer

Registers the kilometers (miles) of individual journeys. To reset, depress the control.

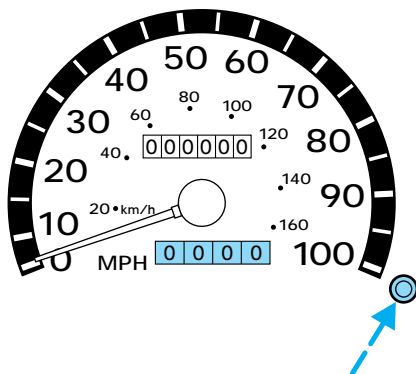

Controls and features

HEADLAMP CONTROL

- Pull the headlamp control toward you to the first position to turn on the parking lamps, tail lamps, license plate lamps and marker lamps.
- Pull the headlamp control toward you to the outer position to turn on the headlamps (in addition to the previous lamps).

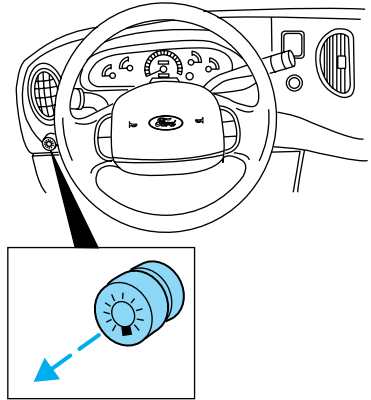

Daytime running lamps (DRL) (if equipped)

Turns the highbeam headlamps on with a reduced output. To activate:

- the engine must be running
- the headlamp control is in the OFF or Parking lamps position.



The Daytime Running Light (DRL) system will not illuminate the tail lamps and parking lamps. Turn on your headlamps at dusk. Failure to do so may result in a collision.

High beams

Push forward to activate.

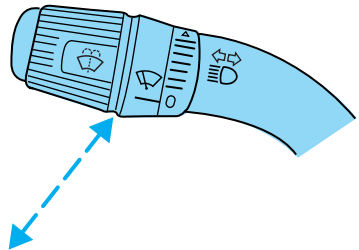

Controls and features

Flash to pass

Pull toward you to activate and release to deactivate.

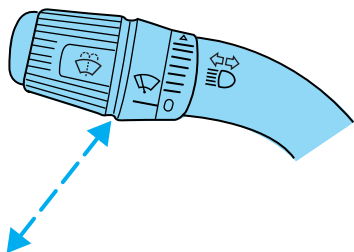

PANEL DIMMER CONTROL

Use to adjust the brightness of the instrument panel.

- Rotate clockwise/counterclockwise when it is in the on position.
- Rotate fully counterclockwise to turn on the courtesy and cargo lamps.

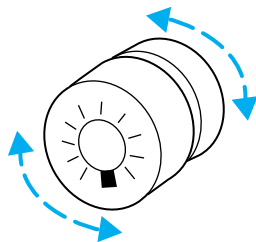

CLIMATE CONTROL SYSTEM

Heater only system (if equipped)

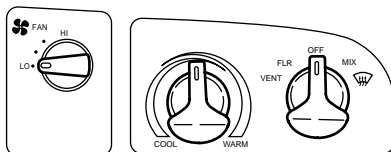

Controls and features

Fan speed control

Controls the volume of air circulated in the vehicle.

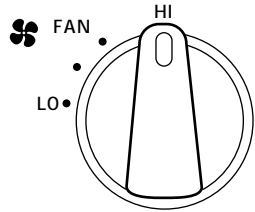

Temperature control knob

Controls the temperature of the airflow inside the vehicle. On heater-only systems, the air cannot be cooled below the outside temperature.

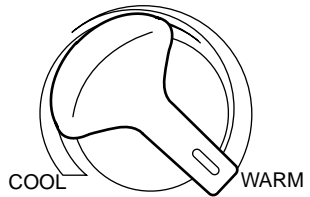

Mode selector control

Controls the direction of the airflow to the inside of the vehicle.

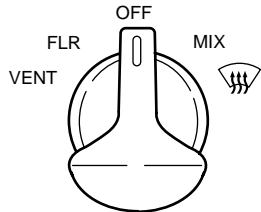

- VENT-Distributes outside air through the instrument panel registers.
- FLR-Allows for maximum heating. Distributes outside air through the floor ducts.
- OFF-Outside air is shut out and the fan will not operate.
- MIX-Distributes outside air through the floor ducts and the windshield defroster ducts.
-  -Distributes outside air through the windshield defroster ducts. It can be used to clear ice or fog from the windshield.

Controls and features

Operating tips

- In humid weather, select  before driving. This will help to prevent your windshield from fogging. After a few minutes, select any desired position.
- To prevent humidity buildup inside the vehicle, don't drive with the climate control system in the OFF position.
- Don't put objects under the front seat that will interfere with the airflow to the back seats.
- Remove any snow, ice or leaves from the air intake area (at the bottom of the windshield under the hood).

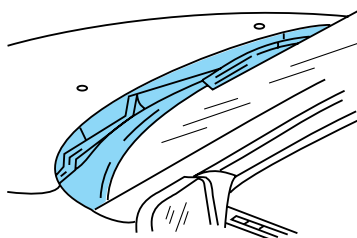

- When placing objects on top of your instrument panel, be careful to not place them over the defroster outlets. These objects can block airflow and reduce your ability to see through your windshield. Also, avoid placing small objects on top of your instrument panel. These objects can fall down into the defroster outlets and block airflow and possibly damage your climate control system.

Manual heating and air conditioning system (if equipped)

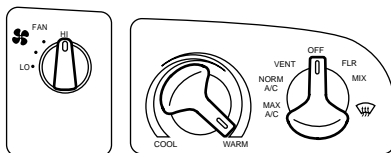

Controls and features

Fan speed control

Controls the volume of air circulated in the vehicle.

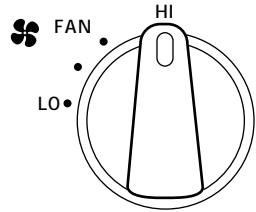

Temperature control knob

Controls the temperature of the airflow inside the vehicle.

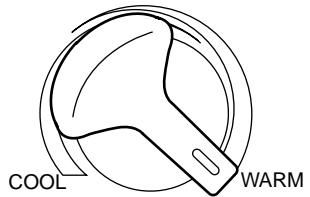

Mode selector control

Controls the direction of the airflow to the inside of the vehicle.

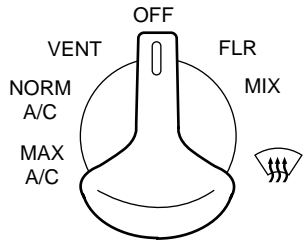

The air conditioning compressor will operate in all modes except VENT and FLR. However, the air conditioning will only function if the outside temperature is about 10°C (50°F) or above.

Since the air conditioner removes considerable moisture from the air during operation, it is normal if clear water drips on the ground under the air conditioner drain while the system is working and even after you have stopped the vehicle.

Controls and features

Under normal conditions, your vehicle's climate control system should be left in any position other than MAX A/C or OFF when the vehicle is parked. This allows the vehicle to "breathe" through the outside air inlet duct.

- **MAX A/C**-Uses recirculated air to cool the vehicle. MAX A/C is noisier than NORM A/C but more economical and will cool the inside of the vehicle faster. Airflow will be from the instrument panel registers. This mode can also be used to prevent undesirable odors from entering the vehicle.
- **NORM A/C**-Uses outside air to cool the vehicle. It is quieter than MAX A/C but not as economical. Airflow will be from the instrument panel registers.
- **VENT**-Distributes outside air through the instrument panel registers. However, the air will not be cooled below the outside temperature because the air conditioning does not operate in this mode.
- **OFF**-Outside air is shut out and the fan will not operate. For short periods of time only, use this mode to prevent undesirable odors from entering the vehicle.
- **FLR**-Allows for maximum heating by distributing outside air through the floor ducts. However, the air will not be cooled below the outside temperature because the air conditioning does not operate in this mode.
- **MIX**-Distributes outside air through the windshield defroster ducts and the floor ducts. Heating and air conditioning capabilities are provided in this mode. For added customer comfort, when the temperature control knob is anywhere in between the full hot and full cold positions, the air distributed through the floor ducts will be slightly warmer than the air sent to the windshield defroster ducts. If the temperature is about 10°C (50°F) or higher, the air conditioner will automatically dehumidify the air to prevent fogging.
-  -Distributes outside air through the windshield defroster ducts. It can be used to clear ice or fog from the windshield. If the temperature is about 10°C (50°F) or higher, the air conditioner will automatically dehumidify the air to prevent fogging.

Operating tips

- In humid weather, select  before driving. This will prevent your windshield from fogging. After a few minutes, select any desired position.

Controls and features

- To prevent humidity buildup inside the vehicle, don't drive with the climate control system in the OFF position.
- Don't put objects under the front seat that will interfere with the airflow to the back seats.
- Remove any snow, ice or leaves from the air intake area (at the bottom of the windshield).

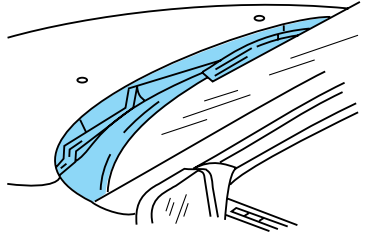

- If your vehicle has been parked with the windows closed during hot weather, the air conditioner will do a much faster job of cooling if you drive for two or three minutes with the windows open. This will force most of the hot, stale air out of the vehicle. Then operate your air conditioner as you would normally.
- When placing objects on top of your instrument panel, be careful to not place them over the defroster outlets. These objects can block airflow and reduce your ability to see through your windshield. Also, avoid placing small objects on top of your instrument panel. These objects can fall down into the defroster outlets and block airflow and possibly damage your climate control system.

Auxiliary heater and air conditioner (if equipped)

If your vehicle is equipped with a factory installed auxiliary unit, the front control panel will include separate controls for the front and rear fans.

In addition an auxiliary unit fan control is located in the headliner at a location between the front and rear seats.

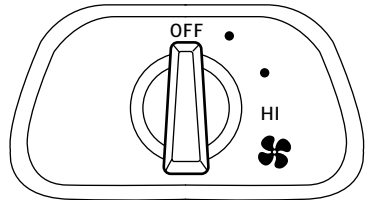

Controls and features

- To control the auxiliary fan with this control, the rear fan switch on the front control unit must be in the rear control position.
- The auxiliary unit does not provide for mixing of hot and cold air. Adjustment of temperature in the rear may be accomplished by increasing or decreasing the rear fan speed.

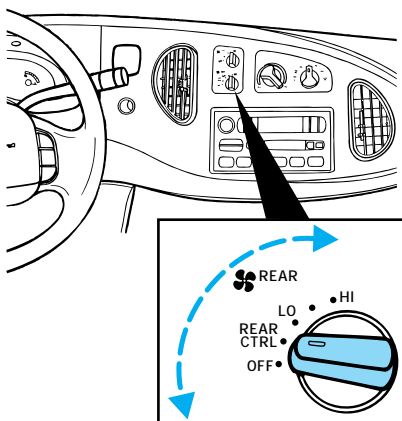

AUXILIARY POWER POINT

The auxiliary power point is located on the instrument panel.

Do not plug optional electrical accessories into the cigarette lighter. Use the power point.

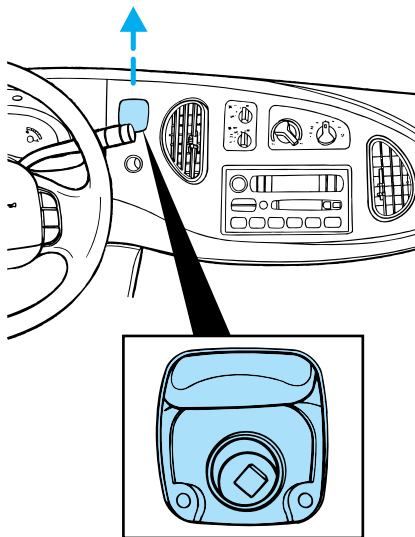

AUDIO SYSTEM

Refer to the “Audio Guide” for instructions on how to operate the audio system.

Controls and features

POSITIONS OF THE IGNITION

1. **ACCESSORY**, allows the electrical accessories such as the radio to operate while the engine is not running.

2. **LOCK**, locks the steering wheel, automatic transmission gearshift lever and allows key removal.

3. **OFF**, shuts off the engine and all accessories without locking the steering wheel.

4. **ON**, all electrical circuits operational. Warning lights illuminated. Key position when driving.

5. **START**, cranks the engine. Release the key as soon as the engine starts.

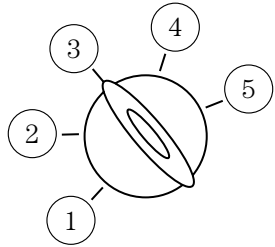

HAZARD FLASHER

For information on the hazard flasher control, refer to *Hazard lights control* in the *Roadside emergencies* chapter.

TURN SIGNAL CONTROL

- Push down to activate the left turn signal.
- Push up to activate the right turn signal.

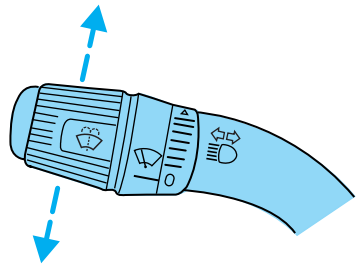

Controls and features

SPEED CONTROL (IF EQUIPPED)

To turn speed control on

- Press ON.

Vehicle speed cannot be controlled until the vehicle is traveling at or above 48 km/h (30 mph).

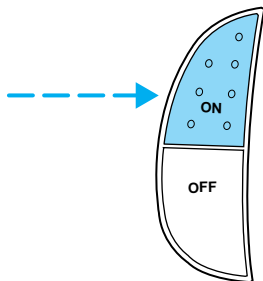

Do not use the speed control in heavy traffic or on roads that are winding, slippery, or unpaved.



Do not shift the gearshift lever into N (Neutral) with the speed control on.

To turn speed control off

- Press OFF or
- Turn off the vehicle ignition.

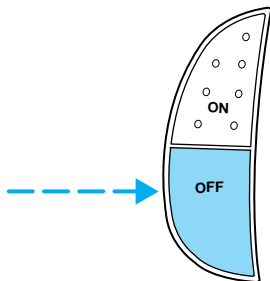

Once speed control is switched off, the previously programmed set speed will be erased.

Controls and features

To set a speed

- Press SET ACC/SET ACCEL. For speed control to operate, the speed control must be ON and the vehicle speed must be greater than 48 km/h (30 mph).

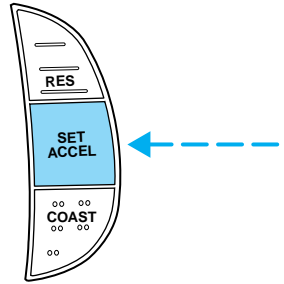

If you drive up or down a steep hill, your vehicle speed may vary momentarily slower or faster than the set speed. This is normal.

Speed control cannot reduce the vehicle speed if it increases above the set speed on a downhill. If your vehicle speed is faster than the set speed while driving on a downhill, you may want to shift to the next lower gear or apply the brakes to reduce your vehicle speed.

If your vehicle slows down more than 16 km/h (10 mph) below your set speed on an uphill, your speed control will disengage. This is normal. Pressing RES/RSM/RESUME will re-engage it.



Do not use the speed control in heavy traffic or on roads that are winding, slippery, or unpaved.

To set a higher set speed

- Press and hold SET ACC/SET ACCEL. Release the control when the desired vehicle speed is reached or
- Press and release SET ACC/SET ACCEL. Each press will increase the set speed by 1.6 km/h (1 mph) or
- Accelerate with your accelerator pedal, then press and release SET ACC/SET ACCEL.

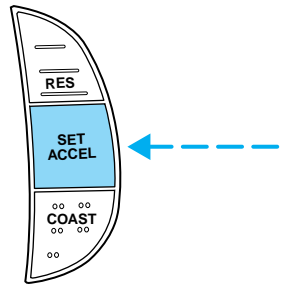

Controls and features

You can accelerate with the accelerator pedal at any time during speed control usage. Releasing the accelerator pedal will return your vehicle to the previously programmed set speed.

To set a lower set speed

- Press and hold CST/COAST. Release the control when the desired speed is reached or
- Press and release CST/COAST. Each press will decrease the set speed by 1.6 km/h (1 mph) or
- Depress the brake pedal. When the desired vehicle speed is reached, press SET ACC/SET ACCEL.

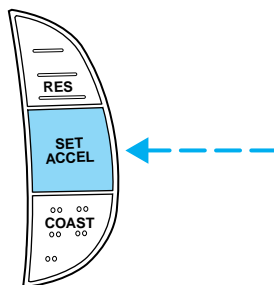
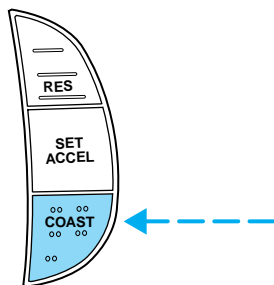

Controls and features

To disengage speed control

- Depress the brake pedal.

Disengaging the speed control will not erase the previously programmed set speed.

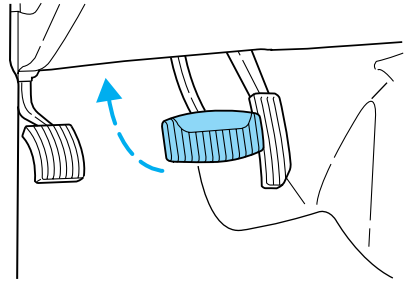

Pressing OFF will erase the previously programmed set speed.

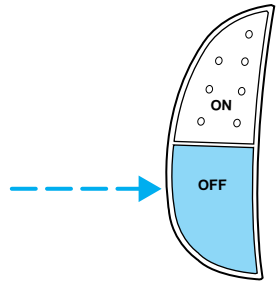

To return to a previously set speed

- Press RES/RSM/RESUME. For RES/RSM/RESUME to operate, the vehicle speed must be faster than 48 km/h (30 mph).

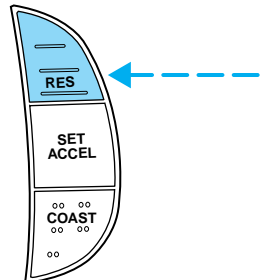

Controls and features

TILT STEERING (IF EQUIPPED)

Pull the tilt steering control toward you to move the steering wheel up or down. Hold the control while adjusting the wheel to the desired position, then release the control.

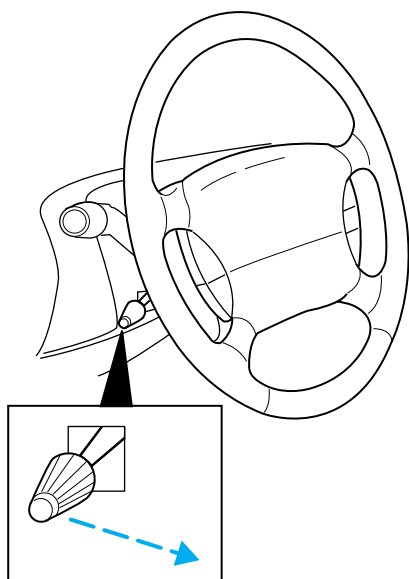

Never adjust the steering wheel when the vehicle is moving.

WINDSHIELD WIPER/WASHER CONTROLS

Rotate the windshield wiper control to the desired interval, low or high speed position.

The bars of varying length are for intermittent wipers. When in this position rotate the control upward for fast intervals and downward for slow intervals.

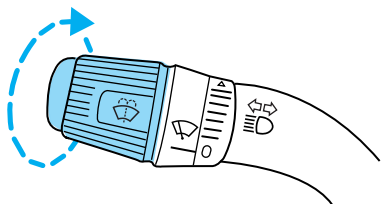

Controls and features

Push the control on the end of the stalk to activate washer. Push and hold for a longer wash cycle.

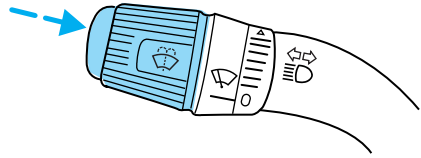

OVERDRIVE CONTROL

Activating overdrive

D (Overdrive) is the normal drive position for the best fuel economy. The overdrive function allows automatic upshifts to second, third and fourth gear.

Deactivating overdrive

Press the Transmission Control Switch (TCS) located on the end of the gearshift lever. The Transmission Control Indicator Light (TCIL) (the word OFF) will illuminate on the end of the gearshift lever.

The transmission will operate in gears one through three. To return to normal overdrive mode, press the Transmission Control Switch again. The TCIL (the word OFF) will no longer be illuminated.

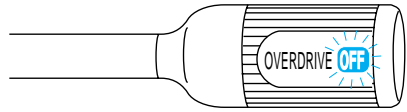

When you shut off and re-start your vehicle, the transmission will automatically return to normal **D** (Overdrive) mode.

Controls and features

INTERIOR LAMPS

Cargo and dome lamps

Rear cargo lamps equipped with an ON/OFF/DOOR control will light when:

- the doors are closed and the switch is in the ON position.
- the switch is in the DOOR position and any door is open.
- the switch is in the DOOR position and the front door handle is lifted.
- the instrument panel dimmer switch is turned to the courtesy lamp position.

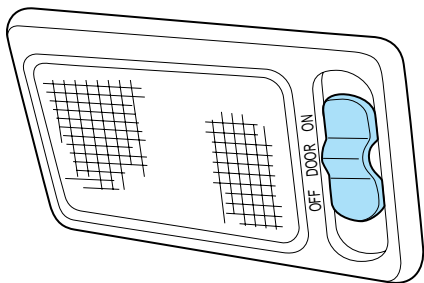

When the cargo lamp switch is in the OFF position, it will not illuminate when you open the doors or turn the headlamp control.

Front and rear courtesy/reading lamps

Rotate the lens to illuminate the lamp.

With the lens in the flat position, the courtesy lamp lights when:

- any door is opened.
- when the instrument panel dimmer switch is turned to the courtesy lamp position.
- the front door handle is lifted.

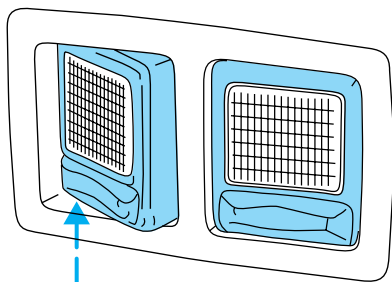

Controls and features

POWER WINDOWS (IF EQUIPPED)

Press and hold the rocker switches to open and close windows.

- Press the top portion of the rocker switch to close.

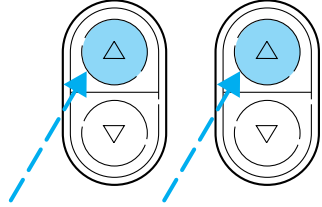

- Press the bottom portion of the rocker switch to open.

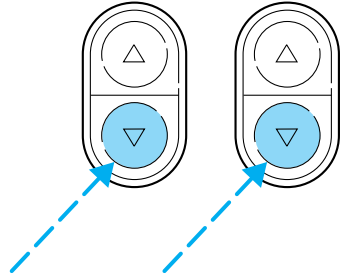

POWER DOOR LOCKS (IF EQUIPPED)

Press U to unlock all doors and L to lock all doors.

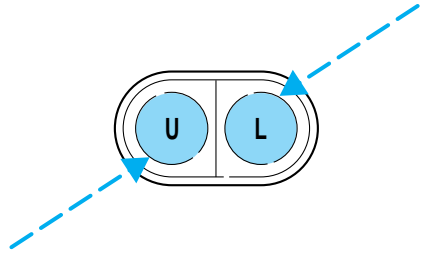

Controls and features

POWER SIDE VIEW MIRRORS (IF EQUIPPED)

To adjust your mirrors:

1. Select ◀ to adjust the left mirror or ▶ to adjust the right mirror.
2. Move the control in the direction you wish to tilt the mirror.

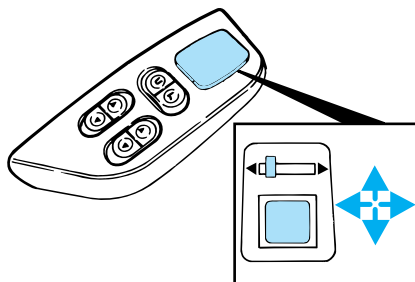

3. Return to the center position to lock mirrors in place.

REMOTE ENTRY SYSTEM (IF EQUIPPED)

The remote entry system allows you to lock or unlock all vehicle doors without a key.

The remote entry features only operate with the ignition in the OFF position.

Unlocking the doors

Press this control to unlock the driver door. The interior lamps will illuminate.

Press the control a second time within five seconds to unlock all doors.

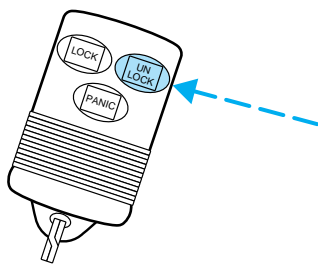

Controls and features

Locking the doors

Press this control to lock all doors.

To confirm all doors are closed and locked, press the control a second time within five seconds. The doors will lock again, the horn will chirp and the lamps will flash.

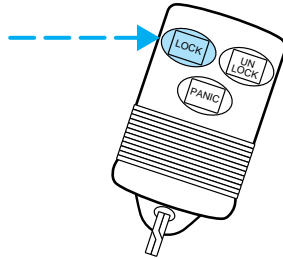

Sounding a panic alarm

Press this control to activate the alarm.

To deactivate the alarm, press the control again or turn the ignition to ACC or ON.

This device complies with part 15 of the FCC rules and with RS-210 of Industry Canada. Operation is subject to the following two conditions: (1) This device may not cause harmful interference, and (2) This device must accept any interference received, including interference that may cause undesired operation.

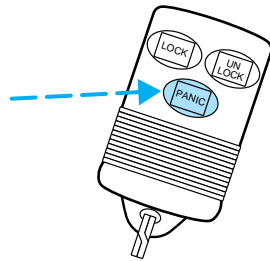

Changes or modifications not expressly approved by the party responsible for compliance could void the user's authority to operate the equipment.

Replacing the batteries

The transmitter is powered by two coin type three-volt lithium batteries. Typical operating range will allow you to be up to 10 meters (33 feet) away from your vehicle. A decrease in operating range can be caused by:

- battery weakness due to time and use
- weather conditions
- nearby radio towers

Controls and features

- structures around the vehicle
- other vehicles parked next to the vehicle

To replace the batteries:

1. Twist a thin coin between the two halves of the transmitter near the key ring. **DO NOT TAKE THE FRONT PART OF THE TRANSMITTER APART.**

2. Place the positive (+) side of new batteries down. Refer to the diagram inside the transmitter unit.

3. Snap the two halves back together.

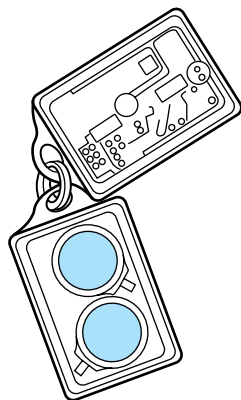

Replacing lost transmitters

Take all your vehicle's transmitters to your dealer for reprogramming if:

- a transmitter is lost or
- you want to purchase additional transmitters (up to four may be programmed).

To reprogram the transmitters, place the key in the ignition and switch from OFF to ON five times in rapid succession (within 10 seconds).

After doors lock/unlock, press any button on all transmitters (up to four). When completed, switch the ignition to OFF.

All transmitters must be programmed at the same time.

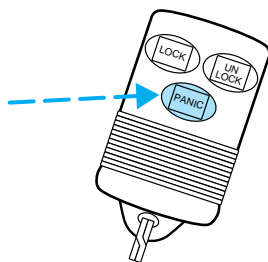

Reprogramming transmitters

To reprogram all transmitters, place the key in the ignition and switch from OFF to ON eight times in a row (within 10 seconds). After doors lock/unlock, press any button on all transmitters (up to four). When completed, switch the ignition to OFF.

All transmitters must be reprogrammed at the same time.

Illuminated entry

The interior lamps illuminate when the remote entry system is used to unlock the door(s) or sound the personal alarm.

The system automatically turns off after 25 seconds or when the ignition is turned to the START or ACC position. The dome lamp switch (if equipped) must **not** be set to the OFF position for the illuminated entry system to operate.

The inside lights will not turn off if:

- they have been turned on with the dimmer control or
- any door is open.

The battery saver will shut off the interior lamps 40 minutes after the ignition has been turned to the OFF position.

Seating and safety restraints

SEATING

Front seats



Never adjust the driver's seat or seatback when the vehicle is moving.



Do not pile cargo higher than the seatbacks to avoid injuring people in a collision or sudden stop.



Always drive and ride with your seatback upright and the lap belt snug and low across the hips.

Lift handle to move seat forward or backward.

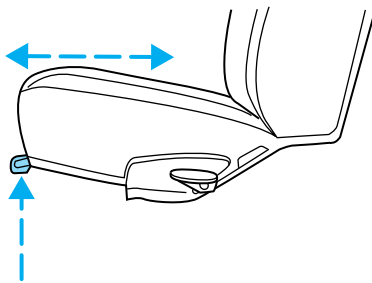

Pull lever up to adjust seatback.

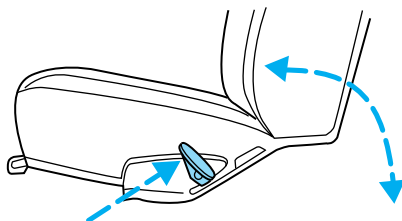

Seating and safety restraints

Adjusting the front power seat (if equipped)



Never adjust the driver's seat or seatback when the vehicle is moving.



Do not pile cargo higher than the seatbacks to avoid injuring people in a collision or sudden stop.



Always drive and ride with your seatback upright and the lap belt snug and low across the hips.

Press to raise or lower the front portion of the seat cushion.

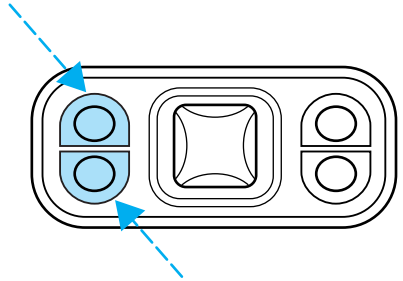

Press to raise or lower the rear portion of the seat cushion.

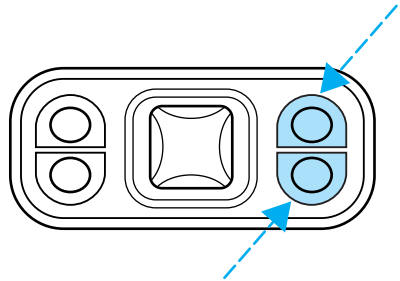

Press the control to move the seat forward, backward, up or down.

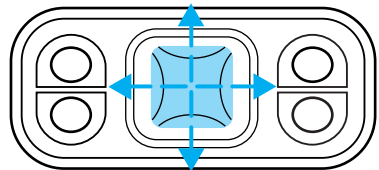

Seating and safety restraints

Using the manual lumbar support

Turn the lumbar support control clockwise to increase firmness.

Turn the lumbar support control counterclockwise to increase softness.

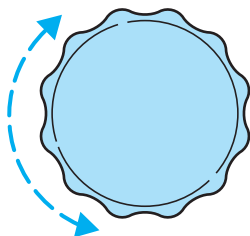

Rear bench seat

To remove the seats:

1. Disengage the lap/shoulder belt from the seat by inserting a key or small screwdriver into the slot in the detachable anchor and lifting upward.

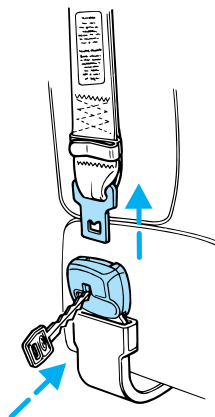

Seating and safety restraints

Stow the tongue end of the detachable anchor.

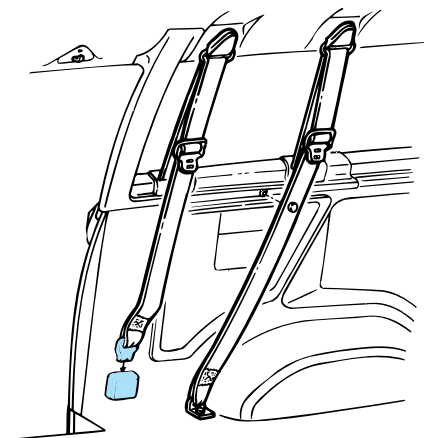

2. Lift and rotate the LH/RH seat latch handles rearward.
3. Lift the LH/RH latch rod hook ends out of the locking holes in the front strikers.
4. Move the seat rearward and lift the seats rear hooks away from the rear strikers prior to lifting the front hooks out from the front strikers.
5. Remove the seat assembly.

To install the seat:

1. Position the seat in the vehicle.
2. Align front hooks to front strikers, prior to lowering the rear hooks and aligning them with the rear strikers.
3. Engage the LH/RH latch rod hook ends in the front striker locking holes.
4. Rotate the LH/RH latch handles forward, and at the same time slide the seat assembly forward to engage the strikers. Continue forward movement until the seat reaches the end of its travel.
5. Make sure the safety belt is not twisted, then insert the seat belt tongue into detachable anchor until you hear a “click” and feel the latch engage.



Always latch the vehicle seat to the floor, whether the seat is occupied or empty. If not latched, the seat may cause injury during a sudden stop.

Seating and safety restraints

Quick release captains chair

To remove the seats:

1. Disengage the lap/shoulder belt from the seat by inserting a key or small screwdriver into the slot in the detachable anchor and lifting upward.

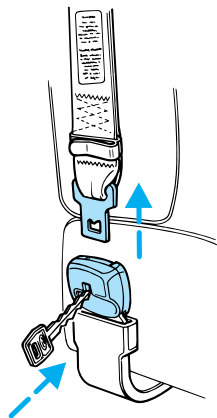

Stow the tongue end of the detachable anchor.

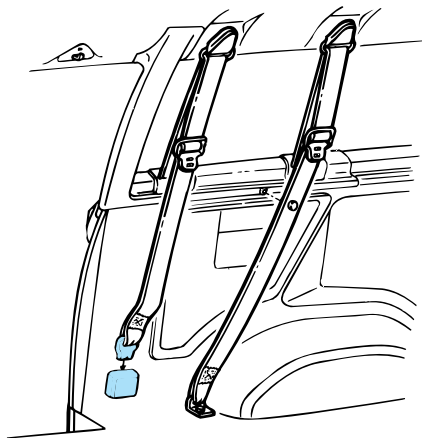

Seating and safety restraints

2. Pull the seat latch handle, then pull the seat toward the right side of the vehicle to disengage four pins from the floor mount.
3. Remove the seat.

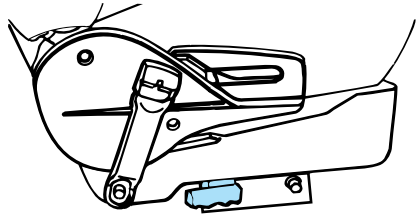

To install the seats:



Check to see that the seat and seatback is latched securely in position. Keep floor area free of objects that would prevent proper seat engagement. Never attempt to adjust the seat while the vehicle is in motion.

1. Position the seat to the floor mount.
2. Engage the four pins into the floor mount hole and push the seat toward the left side of the vehicle to fully engage.

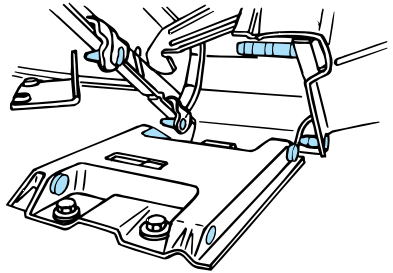

3. Pull the seat latch handle downward to lock the seat in position.
4. Make sure the safety belt is not twisted, then insert the seat belt tongue into detachable anchor until you hear a “click” and feel the latch engage.

SAFETY RESTRAINTS

Safety restraints precautions





Always drive and ride with your seatback upright and the lap belt snug and low across the hips.





To prevent the risk of injury, make sure children sit where they can be properly restrained.

Seating and safety restraints

 Never let a passenger hold a child on his or her lap while the vehicle is moving. The passenger cannot protect the child from injury in a collision.

 All occupants of the vehicle, including the driver, should always wear their safety belts.

 It is extremely dangerous to ride in a cargo area, inside or outside of a vehicle. In a collision, people riding in these areas are more likely to be seriously injured or killed. Do not allow people to ride in any area of your vehicle that is not equipped with seats and safety belts. Be sure everyone in your vehicle is in a seat and using a safety belt properly.

 Each seating position in your vehicle has a specific safety belt assembly which is made up of one buckle and one tongue that are designed to be used as a pair. 1) Use the shoulder belt on the outside shoulder only. Never wear the shoulder belt under the arm. 2) Never swing it around your neck over the inside shoulder. 3) Never use a single belt for more than one person.

Combination lap and shoulder belts

1. To fasten, insert the tongue into the slot in the buckle.

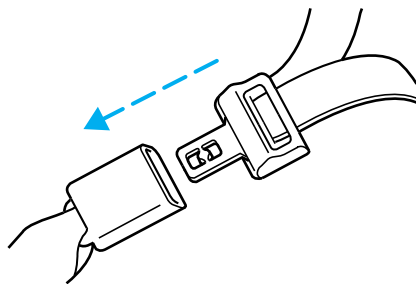

Seating and safety restraints

2. To unfasten, push the red release button and remove the tongue from the buckle.

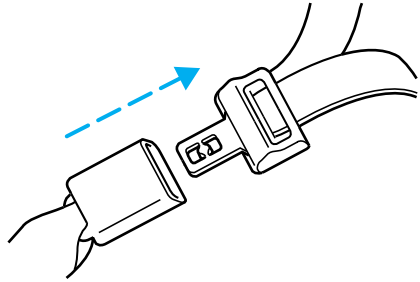

The front and rear outboard safety restraints in the vehicle are combination lap and shoulder belts. The front and rear seat passenger outboard safety belts have two types of locking modes described below:

Vehicle sensitive mode

The vehicle sensitive mode is the normal retractor mode, allowing free shoulder belt length adjustment to your movements and locking in response to vehicle movement. For example, if the driver brakes suddenly or turns a corner sharply, or the vehicle receives an impact of 8 km/h (5 mph) or more, the combination safety belts will lock to help reduce forward movement of the driver and passengers.

In this mode, the shoulder belt is automatically pre-locked. The belt will still retract to remove any slack in the shoulder belt.

The automatic locking mode is not available on the driver safety belt.

When to use the automatic locking mode

- When a tight lap/shoulder fit is desired.
- **Anytime** a child safety seat is installed in the vehicle. Refer to *Safety Restraints for Children* or *Safety Seats for Children* later in this chapter.

Seating and safety restraints

How to use the automatic locking mode

- Buckle the combination lap and shoulder belt.

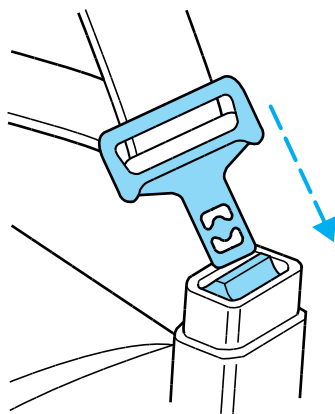

- Grasp the shoulder portion and pull downward until the entire belt is extracted.



- Allow the belt to retract. As the belt retracts, you will hear a clicking sound. This indicates the safety belt is now in the automatic locking mode.

How to disengage the automatic locking mode

Disconnect the combination lap/shoulder belt and allow it to retract completely to disengage the automatic locking mode and activate the vehicle sensitive (emergency) locking mode.

Safety belt buckle pretensioner

Your vehicle is equipped with safety belt buckle pretensioners at the driver and front passenger seating positions.

Seating and safety restraints

The safety belt buckle pretensioner is a device which removes excess webbing from the safety belt system. The safety belt buckle pretensioner uses the same crash sensor system as the air bag supplemental restraint system (SRS). When the safety belt buckle pretensioner deploys, the buckle moves downward, pulling excess webbing from the lap and shoulder safety belt.

Front safety belt height adjustment

Your vehicle has safety belt height adjustments for the driver and front passenger. Adjust the height of the shoulder belt so the belt rests across the middle of your shoulder.

To lower the shoulder belt height, push the button and slide the height control down. To raise the height of the shoulder belt, slide the height adjuster up. Pull down on the height adjustment assembly to make sure it is locked in place.

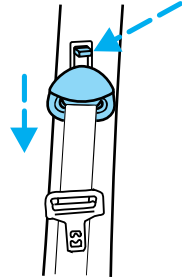

Position the shoulder belt height adjuster so that the belt rests across the middle of your shoulder. Failure to adjust the safety belt properly could reduce the effectiveness of the safety belt and increase the risk of injury in a collision.

Lap belts

Adjusting the lap belt

The lap belt does not adjust automatically. Adjust to fit snugly and as low as possible around your hips. Do not wear the lap belt around your waist.

Seating and safety restraints

Insert the tongue into the correct buckle. To lengthen the belt, turn the tongue at a right angle to the belt and pull across your lap until it reaches the buckle. To tighten the belt, pull the loose end of the belt through the tongue until it fits snugly across the hips.

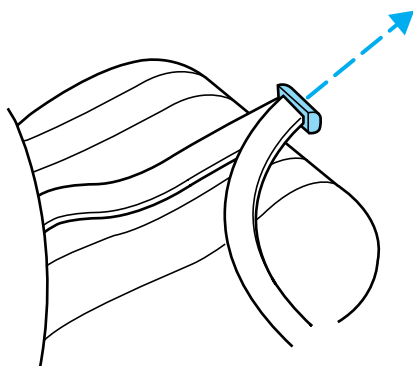

Shorten and fasten the belt when not in use.

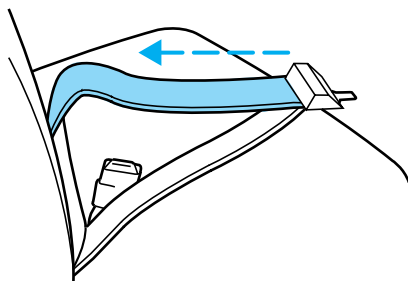

Safety belt extension assembly

If the safety belt assembly is too short, even when fully extended, 20 cm (8 inches) can be added to the safety belt assembly by adding a safety belt extension assembly (part number 611C22). Safety belt extension assemblies can be obtained from your dealer at no cost.

Use only extensions manufactured by the same supplier as the safety belt. Manufacturer identification is located at the end of the webbing on the label. Also, use the safety belt extension only if the safety belt is too short for you when fully extended. Do not use extensions to change the fit of the shoulder belt across the torso.

Safety belt warning light and indicator chime

The seat belt warning light illuminates in the instrument cluster and a chime sounds to remind the occupants to fasten their safety belts.

Seating and safety restraints

Conditions of operation

If...	Then...
The driver's safety belt is not buckled before the ignition switch is turned to the ON position...	The safety belt warning light illuminates for one to two minutes and the warning chime sounds for four to eight seconds.
The driver's safety belt is buckled while the indicator light is illuminated and the warning chime is sounding...	The safety belt warning light and warning chime turn off.
The driver's safety belt is buckled before the ignition switch is turned to the ON position...	The safety belt warning light and indicator chime remain off.

Safety belt maintenance

Check the safety belt systems periodically to make sure they work properly and are not damaged. Check the safety belts to make sure there are no nicks, wears or cuts. All safety belt assemblies, including retractors, buckles, front seat belt buckle assemblies (slide bar) (if equipped), shoulder belt height adjusters (if equipped), child safety seat tether bracket assemblies (if equipped), and attaching hardware, should be inspected after a collision. Ford recommends that all safety belt assemblies used in vehicles involved in a collision be replaced. However, if the collision was minor and a qualified technician finds that the belts do not show damage and continue to operate properly, they do not need to be replaced. Safety belt assemblies not in use during a collision should also be inspected and replaced if either damage or improper operation is noted.



Failure to replace the safety belt assembly under the above conditions could result in severe personal injuries in the event of a collision.

Refer to *Cleaning and maintaining the safety belts* in the *Maintenance and care* section.

Seating and safety restraints

AIR BAG SUPPLEMENTAL RESTRAINT SYSTEM (SRS)

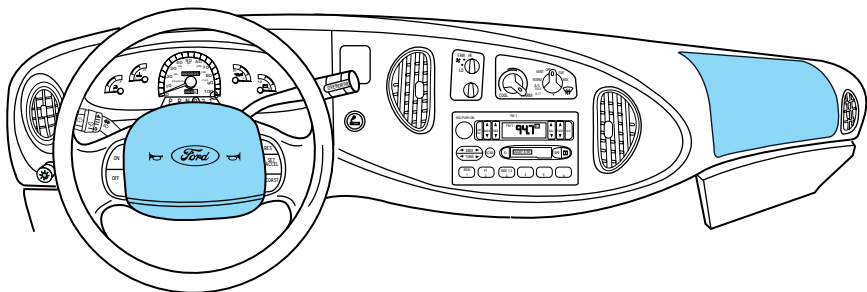

Important supplemental restraint system (SRS) precautions

The supplemental restraint system is designed to:

- work with the safety belt to protect the driver and right front passenger.
- reduce certain upper body injuries.

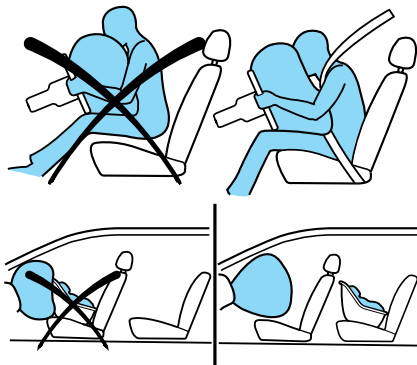

Failure to follow these instructions will affect the performance of the safety belts and increase the risk of personal injury.



The right front passenger air bag is not designed to restrain occupants in the center front seating position.



All occupants of the vehicle including the driver should always wear their safety belts even when air bag SRS is provided.

Seating and safety restraints



Do not place objects or mount equipment on or near the air bag cover on the steering wheel or in front seat areas that may come into contact with a deploying air bag. Failure to follow this instruction may increase the risk of personal injury in the event of a collision.



Do not attempt to service, repair, or modify the Air Bag Supplemental Restraint System or its fuses. See your Ford or Lincoln-Mercury dealer.

Children and air bags

For additional important safety information, read all information on safety restraints in this guide.

Children should always wear their safety belts. Failure to follow these instructions may increase the risk of injury in a collision.

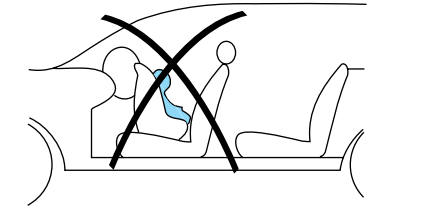

Air bag can kill or injure a child in a child seat. If you must use a forward-facing child seat in the front seat, move seat all the way back.

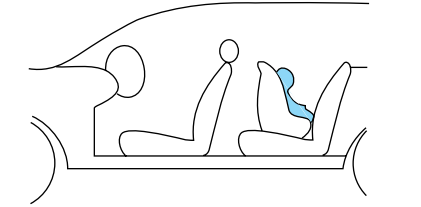

How does the air bag supplemental restraint system work?

The SRS is designed to activate when the vehicle sustains sufficient longitudinal deceleration.

The fact that the air bags did not inflate in a collision does not mean that something is wrong with the system. Rather, it means the forces were not of the type sufficient to cause activation.

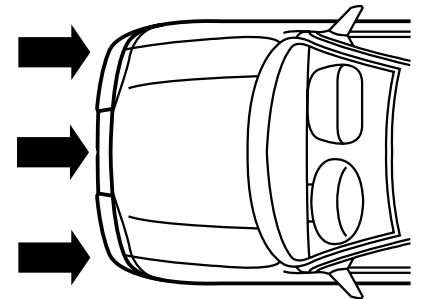

Seating and safety restraints

The air bags inflate and deflate rapidly upon activation.

After air bag deployment, it is normal to notice a smoke-like, powdery residue or smell the burnt propellant. This may consist of cornstarch, talcum powder (to lubricate the bag) or sodium compounds (e.g., baking soda) that result from the combustion process that inflates the air bag. Small amounts of sodium hydroxide may be present which may irritate the skin and eyes, but none of the residue is toxic.



Several air bag system components get hot after inflation. Do not touch them after inflation.



If the air bag is inflated, **the air bag will not function again and must be replaced immediately**. If the air bag is not replaced, the unrepaired area will increase the risk of injury in a collision.

The SRS consists of:

- driver and passenger air bag modules (which include the inflators and air bags),
- one or more impact and safing sensors,
- a readiness light and tone
- and the electrical wiring which connects the components.

The diagnostic module monitors its own internal circuits and the supplemental air bag electrical system warning (including the impact sensors), the system wiring, the air bag system readiness light, the air bag back up power and the air bag ignitors.

Determining if the system is operational

The SRS uses a readiness light in the instrument cluster or a tone to indicate the condition of the system. Refer to the *Air bag readiness*

Seating and safety restraints

section in the *Instrumentation* chapter. Routine maintenance of the air bag is not required.

A difficulty with the system is indicated by one or more of the following:

- The readiness light will either flash or stay lit.
- The readiness light will not illuminate immediately after ignition is turned on.
- A series of five beeps will be heard. The tone pattern will repeat periodically until the problem and light are repaired.



If any of these things happen, even intermittently, have the SRS serviced at your dealership or by a qualified technician immediately. Unless serviced, the system may not function properly in the event of a collision.

Disposal of air bags and air bag equipped vehicles

For disposal of air bags or air bag equipped vehicles, see your local dealership or qualified technician. Air bags **MUST BE** disposed of by qualified personnel.

SAFETY RESTRAINTS FOR CHILDREN

Important child restraint precautions

You are required by law to use safety restraints for children in the U.S. and Canada. If small children ride in your vehicle (generally children who are four years old or younger and who weigh 18 kg [40 lbs] or less), you must put them in safety seats made especially for children. Check your local and state or provincial laws for specific requirements regarding the safety of children in your vehicle.



Never let a passenger hold a child on his or her lap while the vehicle is moving. The passenger cannot protect the child from injury in a collision.

Always follow the instructions and warnings that come with any infant or child restraint you might use.

When possible, place children in the rear seat of your vehicle. Accident statistics suggest that children are safer when properly restrained in the rear seating positions than in the front seating position.

Seating and safety restraints

Install forward-facing convertible safety seats only in vehicle seating positions equipped with lap-shoulder belts. Forward facing convertible safety seats can be used in the center of the three-passenger second row bench seat only if a top tether strap is used. Ford recommends placing forward-facing safety seats in the second row and using safety seats with top tether straps for added protection. For more information on top tether straps, see **Attaching safety seats with tether straps** in this section.

Any booster seat that places the vehicle's lap belt or shoulder belt around a shield above and ahead of the child's hips should not be used in this vehicle.



Do not use a forward-facing safety seat or an infant seat in the last row of a 12- or 15-passenger Club Wagon.

Children and safety belts

Children who are too large for child safety seats (as specified by your child safety seat manufacturer) should always wear safety belts.

Follow all the important safety restraint and air bag precautions that apply to adult passengers in your vehicle.

If the shoulder belt portion of a combination lap and shoulder belt can be positioned so it does not cross or rest in front of the child's face or neck, the child should wear the lap and shoulder belt. Moving the child closer to the center of the vehicle may help provide a good shoulder belt fit.

If the shoulder belt cannot be properly positioned:

- move the child to one of the seats with a lap belt only (if equipped) or
- if the child is the proper size, restrain the child in a safety seat.



Do not leave children, unreliable adults, or pets unattended in your vehicle.

To improve the fit of lap and shoulder belts on children who have outgrown child safety seats, Ford recommends use of a belt-positioning booster seat that is labelled as conforming to all Federal motor vehicle safety standards. Belt-positioning booster seats raise the child and provide a shorter, firmer seating cushion that encourages safer seating posture and better fit of lap and shoulder belts on the child.

Seating and safety restraints

A belt-positioning booster should be used if the shoulder belt rests in front of the child's face or neck, or if the lap belt does not fit snugly on both thighs, or if the thighs are too short to let the child sit all the way back on the seat cushion when the lower legs hang over the edge of the seat cushion. You may wish to discuss the special needs of your child with your pediatrician.

SAFETY SEATS FOR CHILDREN

Child and infant or child safety seats

Use a safety seat that is recommended for the size and weight of the child. Carefully follow all of the manufacturer's instructions with the safety seat you put in your vehicle. If you do not install and use the safety seat properly, the child may be injured in a sudden stop or collision.

When installing a child safety seat:

- Use the correct safety belt buckle for that seating position.
- Make sure the tongue is securely fastened in the buckle.
- Keep the buckle release button pointing up and away from the safety seat, with the tongue between the child seat and the release button, to prevent accidental unbuckling.
- Place seat back in upright position.
- Put the safety belt in the automatic locking mode. Refer to *Automatic locking mode*.

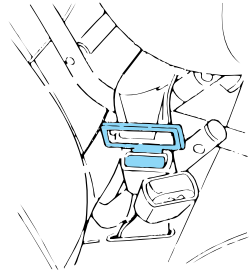

Ford recommends the use of a child safety seat having a top tether strap. Install the child safety seat in a seating position which is capable of providing a tether anchorage. For more information on top tether straps, refer to *Attaching safety seats with tether straps*.



Carefully follow all of the manufacturer's instructions included with the safety seat you put in your vehicle. If you do not install and use the safety seat properly, the child may be injured in a sudden stop or collision.

Seating and safety restraints

1. Position the child safety seat in a seat with a combination lap and shoulder belt.

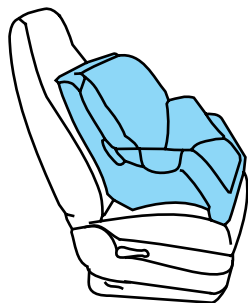

Air bag can kill or injure a child in a child seat. If you must use a forward-facing child seat in the front seat, move seat all the way back.

2. Pull down on the shoulder belt and then grasp the shoulder belt and lap belt together.

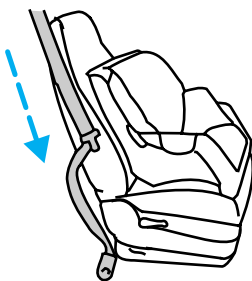

3. While holding the shoulder and lap belt portions together, route the tongue through the child seat according to the child seat manufacturer's instructions. Be sure the belt webbing is not twisted.

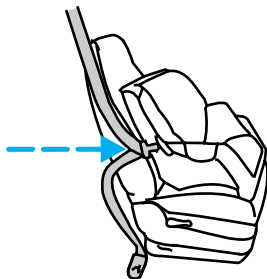

Seating and safety restraints

4. Insert the belt tongue into the proper buckle for that seating position until you hear and feel the latch engage. Make sure the tongue is latched securely by pulling on it.

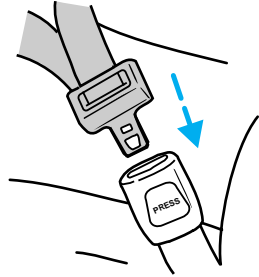

5. To put the retractor in the automatic locking mode, grasp the shoulder portion of the belt and pull downward until all of the belt is extracted and a click is heard.

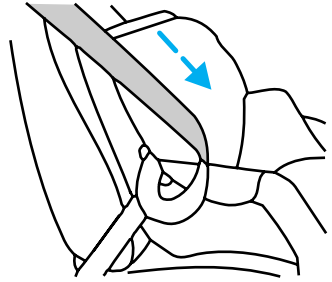

6. Allow the belt to retract. The belt will click as it retracts to indicate it is in the automatic locking mode.

7. Pull the lap belt portion across the child seat toward the buckle and pull up on the shoulder belt while pushing down with your knee on the child seat.

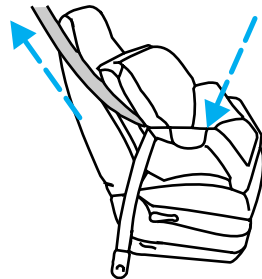

Seating and safety restraints

8. Allow the safety belt to retract to remove any slack in the belt.

9. Before placing the child in the seat, forcibly tilt the seat forward and back to make sure the seat is securely held in place.

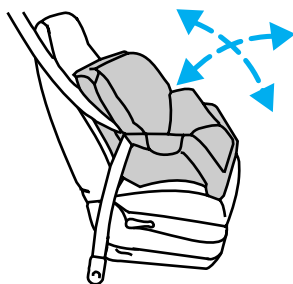

10. Try to pull the belt out of the retractor to make sure the retractor is in the automatic locking mode (you should not be able to pull more belt out). If the retractor is not locked, unbuckle the belt and repeat steps two through nine.

Check to make sure the child seat is properly secured before each use.

Attaching safety seats with tether straps

Some manufacturers make safety seats that include a tether strap that goes over the back of the vehicle seat and attaches to an anchoring point. Other manufacturers offer the tether strap as an accessory. Contact the manufacturer of your child safety seat for information about ordering a tether strap.

Tether anchorage hardware



Children should be placed in the rear in an appropriate child safety seat that is properly secured to the vehicle.



Rear-facing infant seats must always be secured in the rear seat. In vehicles without a rear seat, a rear-facing infant seat should be secured in the front seat only if your vehicle does not have a passenger side air bag or your vehicle is equipped with a passenger air bag deactivate switch and the switch is turned to "OFF."



When using forward-facing child safety seats in vehicles with only two seating positions so the forward-facing child safety seat cannot be placed in the rear of the vehicle, move the passenger seat as far back from the instrument panel as possible.

Seating and safety restraints

Front passenger seating position

The front passenger seating position does not require any tether hardware. The tether can be attached directly to the rear of the front seat.

1. Position the child safety seat on the front right-hand passenger seat.
2. Adjust the front right-hand passenger seat full forward.

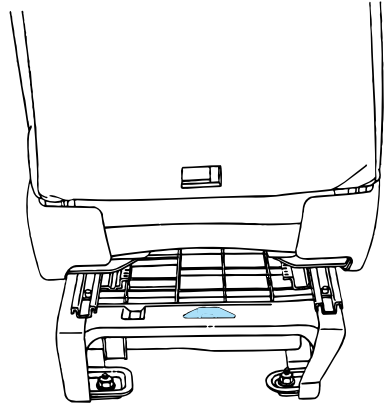

3. Route the child safety seat tether strap over the back of the front right-hand passenger seat as shown.

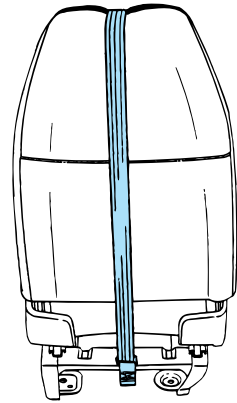

Seating and safety restraints

4. Grasp the tether strap and position it to the seat pedestal as shown.

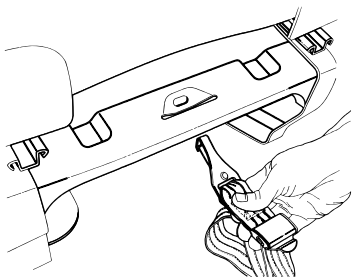

5. Rotate the tether strap as shown.

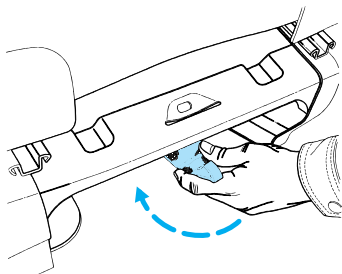

6. Clip the tether strap to the seat pedestal as shown.

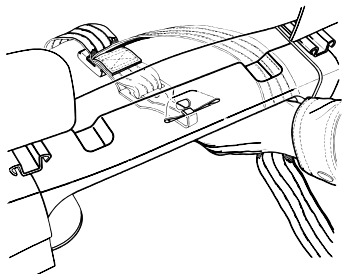

Do not clip the tether strap to the seat pedestal as shown.

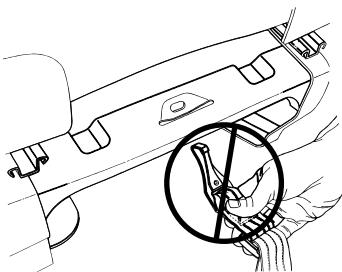

Seating and safety restraints

If the tether strap is clipped incorrectly (as shown) the child safety seat may not be retained properly in the event of a collision.

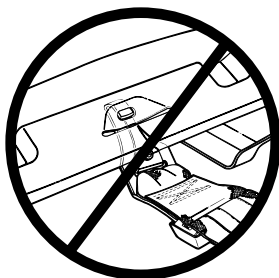

7. Rotate the tether strap clip as shown.

8. Adjust the front right-hand passenger seat to the full rearward position.

9. Refer to the instructions in this section under *Installing child safety seats in combination lap and shoulder belt seating positions* to secure the child safety seat.

10. Tighten the child safety seat tether strap according to the manufacturer's instructions.

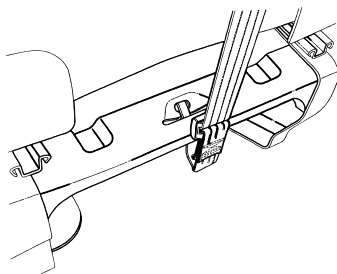
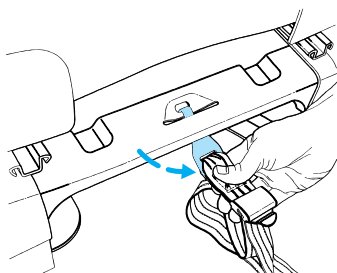

For additional important safety information on the proper use of seatbelts, child seats and infant seats, please read the entire *Seating and safety restraints* chapter in this owner's guide.

Rear seating positions

Attachment holes have been provided in your vehicle to attach anchor hardware, if required. Tether anchor hardware kits (Part No. 613D74)

Seating and safety restraints

including instructions, may be obtained at no charge from any Ford dealer.

- Second row bucket seats (at rear of lower seat frame)

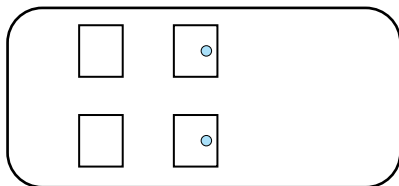

- 3-passenger bench seat (on rear rail of seat cushion frame)

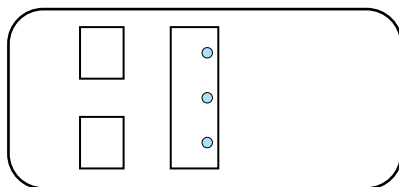

PREPARING TO START YOUR VEHICLE

Engine starting is controlled by the ignition system. This system meets all Canadian Interference-Causing Equipment standard requirements regulating the impulse electrical field strength of radio noise.

When starting a fuel-injected engine, avoid pressing the accelerator before or during starting. Only use the accelerator when you have difficulty starting the engine. For more information on starting the vehicle, refer to *Starting the engine* in this chapter.



Extended idling at high engine speeds can produce very high temperatures in the engine and exhaust system, creating the risk of fire or other damage.



Do not park, idle, or drive your vehicle in dry grass or other dry ground cover. The emission system heats up the engine compartment and exhaust system, which can start a fire.



Do not start your vehicle in a closed garage or in other enclosed areas. Exhaust fumes can be toxic. Always open the garage door before you start the engine. See *Guarding against exhaust fumes* in this chapter for more instructions.



If you smell exhaust fumes inside your vehicle, have your dealer inspect your vehicle immediately. Do not drive if you smell exhaust fumes.

Important safety precautions

A computer system controls the engine's idle revolutions per minute (RPM). When the engine starts, the idle RPM runs faster to warm the engine. If the engine idle speed does not slow down automatically, have the vehicle checked. Do not allow the vehicle to idle for more than ten minutes.

Before starting the vehicle:

1. Make sure all vehicle occupants have buckled their safety belts. For more information on safety belts and their proper usage, refer to the *Seating and safety restraints* chapter.

Starting

2. Make sure the headlamps and vehicle accessories are off.
3. Make sure the parking brake is set.

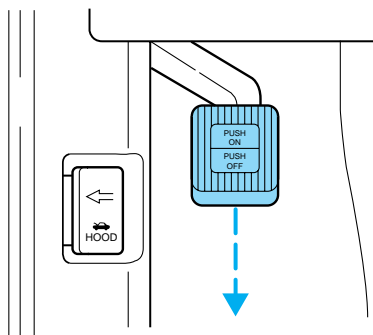

4. Make sure the gearshift is in P (Park).



5. Turn the key to 4 (ON) without turning the key to 5 (START).

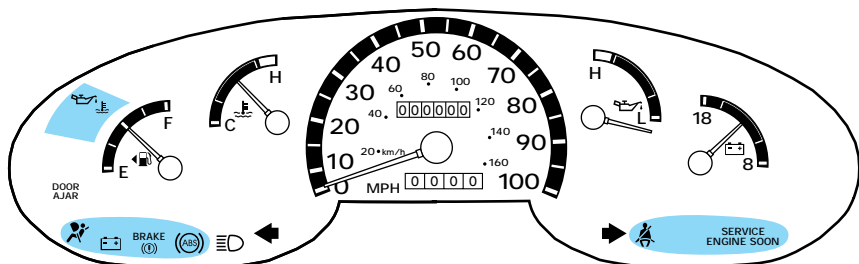
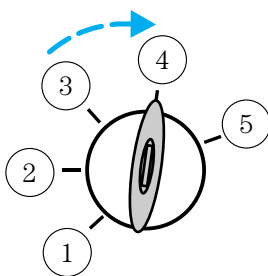

Make sure the corresponding lights illuminate briefly. If a light fails to illuminate, have the vehicle serviced.

- If the driver's safety belt is fastened, the light () will not illuminate.

STARTING THE ENGINE

1. Turn the key to 5 (START) without pressing the accelerator pedal and release as soon as the engine starts. The key will return to 4 (ON).

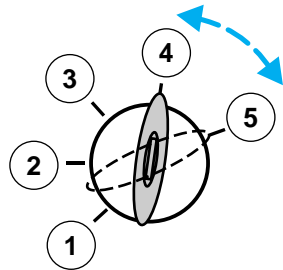

2. If the engine does not start within five seconds, wait ten seconds and try again.
3. If the engine does not start in two attempts or if the temperature is below -12°C (10°F), depress the accelerator and start the engine while holding the accelerator down. Release the accelerator when the engine starts.
4. After idling for a few seconds, apply the brake and release the parking brake.

Using the engine block heater (if equipped)

An engine block heater warms the engine coolant, which improves starting, warms up the engine faster and allows the heater-defroster system to respond quickly. Use of an engine block heater is strongly recommended if you live in a region where temperatures reach -23°C (-10°F) or below.

For best results, plug the heater in at least three hours before starting the vehicle. Using the heater for longer than three hours will not harm the engine, so the heater can be plugged in the night before starting the vehicle.



To prevent electrical shock, do not use your heater with ungrounded electrical systems or two-pronged (cheater) adapters.

Starting

Guarding against exhaust fumes

Although odorless and colorless, carbon monoxide is present in exhaust fumes. Take precautions to avoid its dangerous effects.



If you ever smell exhaust fumes of any kind inside your vehicle, have your dealer inspect and fix your vehicle immediately. Do not drive if you smell exhaust fumes. These fumes are harmful and could kill you.

Have the exhaust and body ventilation systems checked whenever:

- the vehicle is raised for service.
- the sound of the exhaust system changes.
- the vehicle has been damaged in a collision.

Important ventilating information

If the engine is idling while the vehicle is stopped in an open area for long periods of time, open the windows at least 2.5 cm (one inch).

Adjust the heating or air conditioning (if equipped) to bring in fresh air.

Improve vehicle ventilation by keeping all air inlet vents clear of snow, leaves and other debris.

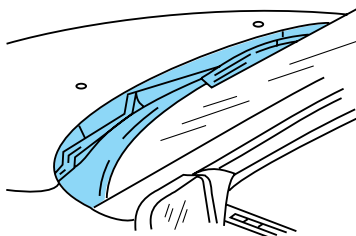

BRAKES

Your brakes are self-adjusting. Refer to the “Service Guide” for scheduled maintenance.

Occasional brake noise is normal and often does not indicate a performance concern with the vehicle’s brake system. In normal operation, automotive brake systems may emit occasional or intermittent squeal or groan noises when the brakes are applied. Such noises are usually heard during the first few brake applications in the morning; however, they may be heard at any time while braking and can be aggravated by environmental conditions such as cold, heat, moisture, road dust, salt or mud. If a “metal-to-metal,” “continuous grinding” or “continuous squeal” sound is present while braking, the brake linings may be worn-out and should be inspected by a qualified service technician.

Anti-lock brake system (ABS) (if equipped)

On vehicles equipped with an anti-lock braking system (ABS), a noise from the hydraulic pump motor and pulsation in the pedal may be observed during ABS braking events. Pedal pulsation coupled with noise while braking under panic conditions or on loose gravel, bumps, wet or snowy roads is normal and indicates proper functioning of the vehicle’s anti-lock brake system. If the vehicle has continuous vibration or shudder while braking, felt mainly in the steering wheel, the vehicle most likely needs service.

The ABS operates by detecting the onset of wheel lock up during brake applications and compensating for this tendency. The front wheels are prevented from locking even when the brakes are firmly applied. The accompanying illustration depicts the advantage of an ABS equipped vehicle (on bottom) to a non-ABS equipped vehicle (on top) during hard braking.

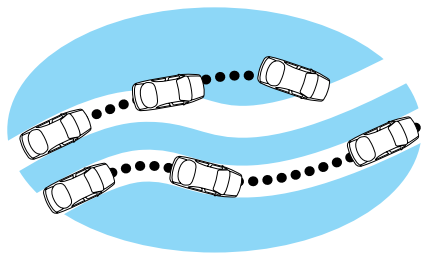

ABS warning lamp

The  warning lamp in the instrument cluster illuminates for about five seconds when starting the vehicle. If an ABS fault is detected, the

Driving

light will remain on and your vehicle should be serviced as soon as possible.

Normal braking is still effective unless the BRAKE warning lamp is also illuminated.

BRAKE
(!)

Using ABS

- In an emergency or when maximum efficiency from the ABS is required, apply continuous full force on the brake. The ABS will be activated immediately, thus allowing you to retain full steering control of your vehicle and, providing there is sufficient space, will enable you to avoid obstacles and bring the vehicle to a controlled stop.
- We recommend that you familiarize yourself with this braking technique. However, avoid taking any unnecessary risks.

Parking brake

Apply the parking brake whenever the vehicle is parked. Push pedal downward to set the parking brake.

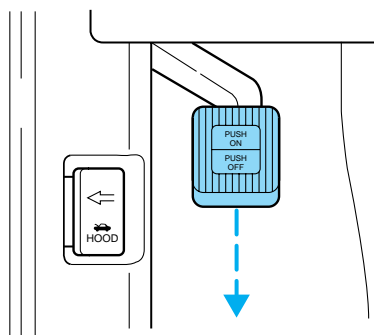

The BRAKE warning lamp in the instrument cluster illuminates and remains illuminated (when the ignition is turned ON) until the parking brake is released.

BRAKE
(!)



Always set the parking brake fully and make sure the gearshift is latched in P (Park). Turn off the ignition whenever you leave your vehicle.

The parking brake is not designed to stop a moving vehicle. However, if the normal brakes fail, the parking brake can be used to stop your vehicle in an emergency. Since the parking brake applies only the rear brakes, the vehicle's stopping distance will increase greatly and the handling of your vehicle will be adversely affected.

Push the pedal downward again to release the parking brake. Driving with the parking brake on will cause the brakes to wear out quickly and reduce fuel economy.

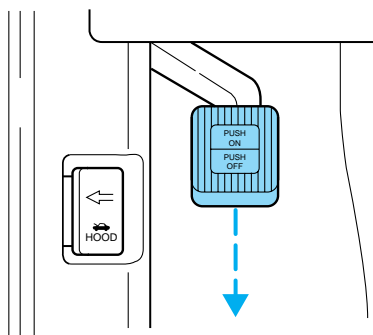

TRANSMISSION OPERATION

Brake-shift interlock

This vehicle is equipped with a brake-shift interlock feature that prevents the gearshift from being moved from P (Park) unless the brake pedal is depressed.

If you cannot move the gearshift out of P (Park) with the brake pedal depressed:

1. Apply the parking brake, turn ignition key to LOCK, then remove the key.
2. Insert the key and turn it to OFF. Apply the brake pedal and shift to N (Neutral).
3. Start the vehicle.

If it is necessary to use the above procedure to move the gearshift, it is possible that a fuse has blown and the vehicle's brakelamps may not be operating properly. Refer to *Fuses and relays* in the *Roadside emergencies* chapter.



Do not drive your vehicle until you verify that the brakelamps are working.

Driving

If your vehicle gets stuck in mud or snow it may be rocked out by shifting from forward and reverse gears in a steady pattern. Press lightly on the accelerator in each gear.

Do not rock the vehicle for more than a few minutes. The transmission and tires may be damaged or the engine may overheat.



Always set the parking brake fully and make sure the gearshift is latched in P (Park). Turn off the ignition whenever you leave your vehicle.

Driving with a 4-speed automatic transmission

Understanding gearshift positions

Pull the gearshift lever towards you and downward to move the automatic gearshift.



Hold the brake pedal down while you move the gearshift lever from position to position. If you do not hold the brake pedal down, your vehicle may move unexpectedly and injure someone.

P (Park)

Always come to a complete stop before shifting into P (Park). Make sure the gearshift is securely latched in P (Park).



R (Reverse)

With the gearshift in R (Reverse), the vehicle will move backward. Always come to a complete stop before shifting into and out of R (Reverse).



N (Neutral)

With the gearshift in N (Neutral), the vehicle can be started and is free to roll. Hold the brake pedal down while in this gear.



D (Overdrive)

The normal driving position for the best fuel economy. Transmission operates in gears one through four.

D (Overdrive) can be deactivated by pressing the Transmission Control Switch (TCS) on the end of the gearshift lever.

The transmission control indicator light (TCIL) (the word OFF) on the end of the gearshift lever will illuminate.

Drive – Not shown on the display. Activate by pressing the Transmission Control Switch (TCS) on the end of the gearshift lever with the gearshift in the **D** position. The TCIL (the word OFF) will illuminate on the gearshift lever. Transmission operates in gears one through three.

D (Drive) provides more engine braking than **D** (Overdrive) and is useful when:

- driving with a heavy load.
- towing a trailer up or down steep hills.
- additional engine downhill braking is desired. If towing a trailer, refer to *Driving while you tow* in the *Towing a trailer* chapter.

To return to **D** (Overdrive) mode, press the Transmission Control Switch (TCS). The TCIL (the word OFF) will no longer be illuminated.

Each time the vehicle is started, the transmission will automatically return to normal overdrive mode.

Every time the vehicle is shut off and restarted, you must press the transmission control switch to cancel overdrive operation if driving in overdrive is not desired.

2 (Second)

Use 2 (Second) to start-up on slippery roads or to provide additional engine braking on downgrades.

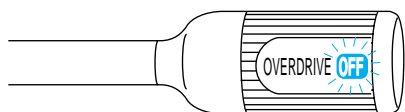
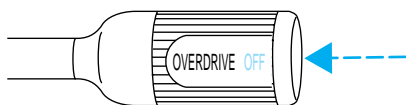

Driving

1 (First)

Use 1 (Low) to provide maximum engine braking on steep downgrades. Upshifts can be made by shifting to 2 (Second) or to

D (Overdrive). Selecting 1 (Low)

at higher speeds causes the transmission to shift to a lower gear, and will shift to 1 (Low) after vehicle decelerates to the proper speed.



VEHICLE LOADING

Before loading a vehicle, familiarize yourself with the following terms:

- **Base Curb Weight** : Weight of the vehicle including any standard equipment, fluids, lubricants, etc. It does not include passengers or aftermarket equipment.
- **Payload** : Combined maximum allowable weight of cargo, passengers and optional equipment. The payload equals the gross vehicle weight rating minus base curb weight.
- **GVW (Gross Vehicle Weight)** : Base curb weight plus payload weight. The GVW is not a limit or a specification.
- **GVWR (Gross Vehicle Weight Rating)** : Maximum total weight of the base vehicle, passengers, optional equipment and cargo. The GVWR is specific to each vehicle and is listed on the Safety Compliance Label on the driver's door pillar.
- **GAWR (Gross Axle Weight Rating)** : Carrying capacity for each axle system. The GAWR is specific to each vehicle and is listed on the Safety Compliance Label on the driver's door pillar.
- **GCWR (Gross Combined Weight Rating)** : Maximum combined weight of towing vehicle (including passengers and cargo) and the trailer. The GCWR indicates the maximum loaded weight that the vehicle is allowed to tow.
- **Maximum Trailer Weight Rating** : Maximum weight of a trailer the vehicle is permitted to tow. The maximum trailer weight rating is determined by subtracting the vehicle curb weight for each engine/transmission combination, any required option weight for trailer towing and the weight of the driver from the GCWR for the towing vehicle.

- **Maximum Trailer Weight** : maximum weight of a trailer the loaded vehicle (including passengers and cargo) is permitted to tow. It is determined by subtracting the weight of the loaded trailer towing vehicle from the GCWR for the towing vehicle.
- **Trailer Weight Range** : Specified weight range that the trailer must fall within that ranges from zero to the maximum trailer weight rating.

Remember to figure in the tongue load of your loaded trailer when figuring the total weight.



Do not exceed the GVWR or the GAWR specified on the Safety Compliance Certification Label.

Do not use replacement tires with lower weight capacities than the originals because they may lower the vehicle's GVWR and GAWR limitations. Replacement tires with a higher weight limit than the originals do not increase the GVWR and GAWR limitations.

Calculating the load your vehicle can carry/tow

1. Use the Safety Compliance Certification Label to find the axle code number and engine type for your vehicle.
2. Use the appropriate maximum gross combined weight rating (GCWR) chart to find the maximum GCWR for your type engine and rear axle ratio.
3. Weigh your vehicle as you customarily operate the vehicle without cargo. To obtain correct weights, try taking your vehicle to a shipping company or an inspection station for trucks.
4. Subtract your loaded vehicle weight from the maximum GCWR on the following charts. This is the maximum trailer weight your vehicle can tow and must fall below the maximum shown under maximum trailer weight on the chart.

Driving

DRIVING THROUGH WATER

Do not drive quickly through standing water, especially if the depth is unknown. Traction or brake capability may be limited and if the ignition system gets wet, your engine may stall. Water may also enter your engine's air intake and severely damage your engine.

If driving through deep or standing water is unavoidable, proceed very slowly. Never drive through water that is higher than the bottom of the hubs (truck)/wheel rims (car).

Once through the water, always try the brakes. Wet brakes do not stop the vehicle as effectively as dry brakes. Drying can be improved by moving your vehicle slowly while applying light pressure on the brake pedal.

TRAILER TOWING

Your vehicle may tow a class I, II or III trailer provided the maximum trailer weight is less than or equal to the maximum trailer weight listed for your engine and rear axle ratio on the following charts.

Trailer Towing Table				
GCWR (Gross Combined Weight Rating)/Trailer Weights				
Engine	Rear axle ratio	Maximum GCWR-kg (lbs.)	Trailer weight range-kg (lbs.) (0-Maximum)	Maximum Frontal Area Of Trailer-m² (ft²)
Regular Van E-150				
4.2L	3.31	4 082 (9 000)	1 860 (4 100)	5.52 (60)
4.2L	3.55	4 536 (10 000)	2 313 (5 100)	5.52 (60)
4.6L	3.31	4 990 (11 000)	2 766 (6 100)	5.52 (60)
4.6L	3.55	5 216 (11 500)	2 993 (6 600)	5.52 (60)
5.4L	3.55	5 443 (12 000)	3 130 (6 900)	5.52 (60)
Regular Van E-250				
4.2L	3.73	4 763 (10 500)	2 359 (5 200)	5.52 (60)
5.4L	3.73	5 897 (13 000)	3 402 (7 500)	5.52 (60)
Regular Van E-250 HD				
4.2L	4.09	4 990 (11 000)	2 586 (5 700)	5.52 (60)
5.4L	3.73	5 897 (13 000)	3 402 (7 500)	5.52 (60)

Trailer Towing Table

GCWR (Gross Combined Weight Rating)/Trailer Weights

Engine	Rear axle ratio	Maximum GCWR-kg (lbs.)	Trailer weight range-kg (lbs.) (0-Maximum)	Maximum Frontal Area Of Trailer-m ² (ft ²)
Super Van E-250				
4.2L	3.73	4 763 (10 500)	2 313 (5 100)	5.52 (60)
5.4L	3.73	5 897 (13 000)	3 357 (7 400)	5.52 (60)
Super Van E-250 HD				
4.2L	4.09	4 990 (11 000)	2 540 (5 600)	5.52 (60)
5.4L	3.73	5 897 (13 000)	3 356 (7 400)	5.52 (60)
Regular Van E-350				
5.4L	3.55	5 443 (12 000)	2 948 (6 500)	5.52 (60)
5.4L	4.10	5 897 (13 000)	3 402 (7 500)	5.52 (60)
6.8L	3.73	6 804 (15 000)	4 218 (9 300)	5.52 (60)
6.8L	4.10	8 392 (18 500)	4 536 (10 000)	5.52 (60)
7.3L (Diesel)	3.55	7 258 (16 000)	4 536 (10 000)	5.52 (60)
7.3L (Diesel)	4.10	9 072 (20 000)	4 536 (10 000)	5.52 (60)
Super Van E-350				
5.4L	3.55	5 443 (12 000)	2 858 (6 300)	5.52 (60)
5.4L	4.10	5 897 (13 000)	3 311 (7 300)	5.52 (60)
6.8L	3.73	6 804 (15 000)	4 173 (9 200)	5.52 (60)
6.8L	4.10	8 392 (18 500)	4 536 (10 000)	5.52 (60)
7.3L (Diesel)	3.55	7 258 (16 000)	4 445 (9 800)	5.52 (60)
7.3L (Diesel)	4.10	9 072 (20 000)	4 536 (10 000)	5.52 (60)
Club Wagon E-150 (8 passenger)				
4.2L	3.31	4 082 (9 000)	1 678 (3 700)	5.52 (60)
4.2L	3.55	4 536 (10 000)	2 132 (4 700)	5.52 (60)
4.6L	3.31	4 990 (11 000)	2 540 (5 600)	5.52 (60)

Driving

Trailer Towing Table

GCWR (Gross Combined Weight Rating)/Trailer Weights

Engine	Rear axle ratio	Maximum GCWR-kg (lbs.)	Trailer weight range-kg (lbs.) (0-Maximum)	Maximum Frontal Area Of Trailer-m ² (ft ²)
4.6L	3.55	5 216 (11 500)	2 767 (6 100)	5.52 (60)
5.4L	3.55	5 443 (12 000)	2 948 (6 500)	5.52 (60)
Club Wagon Regular E-350 (12 passenger)				
5.4L	3.55	5 443 (12 000)	2 722 (6 000)	5.52 (60)
5.4L	4.10	5 897 (13 000)	3 175 (7 000)	5.52 (60)
6.8L	3.73	6 804 (15 000)	4 037 (8 900)	5.52 (60)
6.8L	4.10	8 392 (18 500)	4 536 (10 000)	5.52 (60)
7.3L (Diesel)	3.55	7 258 (16 000)	4 309 (9 500)	5.52 (60)
7.3L (Diesel)	4.10	9 072 (20 000)	4 536 (10 000)	5.52 (60)
Club Wagon Super E-350 (15 passenger)				
5.4L	3.55	5 443 (12 000)	2 586 (5 700)	5.52 (60)
5.4L	4.10	5 897 (13 000)	3 039 (6 700)	5.52 (60)
6.8L	3.73	6 804 (15 000)	3 901 (8 600)	5.52 (60)
6.8L	4.10	8 392 (18 500)	4 536 (10 000)	5.52 (60)
7.3L (Diesel)	3.55	7 258 (16 000)	4 173 (9 200)	5.52 (60)
7.3L (Diesel)	4.10	9 072 (20 000)	4 536 (10 000)	5.52 (60)
E-350 RV Cutaway (single rear wheel)				
7.3L (Diesel)	4.10	9 072 (20 000)	4 717 (10 400)*	5.52 (60)
E-350 RV Cutaway (dual rear wheel)				
5.4L	4.10	5 897 (13 000)	1 134 (2 500)	5.52 (60)
6.8L	4.10	8 392 (18 500)	3 629 (8 000)	5.52 (60)
7.3L (Diesel)	4.10	9 072 (20 000)	4 309 (9 500)	5.52 (60)

Trailer Towing Table

GCWR (Gross Combined Weight Rating)/Trailer Weights

Engine	Rear axle ratio	Maximum GCWR-kg (lbs.)	Trailer weight range-kg (lbs.) (0-Maximum)	Maximum Frontal Area Of Trailer-m ² (ft ²)
E-350 Commercial Cutaway (single rear wheel)				
7.3L (Diesel)	4.10	9 072 (20 000)	4 717 (10 400)*	5.52 (60)
E-350 Commercial Cutaway (dual rear wheel)				
5.4L	4.10	5 897 (13 000)	1 225 (2 700)	5.52 (60)
6.8L	4.10	8 392 (18 500)	3 720 (8 200)	5.52 (60)
7.3L (Diesel)	4.10	9 072 (20 000)	4 400 (9 700)	5.52 (60)
E-Super Duty				
6.8L	4.63	9 072 (20 000)	4 536 (10 000)	5.52 (60)
7.3L (Diesel)	4.63	9 072 (20 000)	4 536 (10 000)	5.52 (60)
E-250/350 Stripped Chassis (single rear wheel)				
4.2L	4.09	4 990 (11 000)	1 090 (2 400)	5.52 (60)
5.4L	4.10	5 897 (13 000)	1 542 (3 400)	5.52 (60)
6.8L	3.73	6 804 (15 000)	2 540 (5 600)	5.52 (60)
E-250/350 Stripped Chassis (dual rear wheel)				
5.4L	4.10	5 897 (13 000)	1 361 (3 000)	5.52 (60)
6.8L	4.10	8 392 (18 500)	3 856 (8 500)	5.52 (60)
Maximum loaded trailer weight of 4 717 kg (10 400 lbs.) on 7.3L E350 RV and commercial cutaways (single rear wheel) applicable to fifth wheel trailer usage only. Otherwise, maximum trailer weight is 4 536 kg (10 000 lbs.).				
For high altitude operation reduce GCWR by 2% per 300 meters (1 000 ft) elevation.				
To determine the maximum trailer weight designed for you particular vehicle as equipped, follow the section <i>Calculating the load your vehicle can tow/carry</i> earlier in this chapter.				

Driving

Your vehicle's load capacity is designated by weight, not by volume, so you cannot necessarily use all available space when loading a vehicle.

Distribute the load so that only 10 to 15% of the total is on the tongue. Tie down the load so that it does not shift and change the weight on the hitch.

Towing a trailer places an additional load on your vehicle's engine, transmission, axle, brakes, tires and suspension. Inspect these components carefully after any towing operation.



Do not exceed the GVWR or the GAWR specified on the Safety Compliance Certification Label.



Towing trailers beyond the maximum recommended gross trailer weight could result in engine damage, transmission/axle damage, structural damage, loss of control, and personal injury.

Preparing to tow

Use the proper equipment for towing a trailer, and make sure it is properly attached to your vehicle. See your dealer or a reliable trailer dealer if you require assistance.

Hitches

Do not use or install hitches that clamp onto the bumper or to the axle. Underbody hitches are acceptable if installed properly.

Safety chains

Always connect the trailer's safety chains to the vehicle. To connect the trailer's safety chains, cross the chains under the trailer tongue and allow slack for turning corners.

If you use a rental trailer, follow the instructions that the rental agency gives to you.

Trailer brakes

Electric brakes and manual, automatic or surge-type brakes are safe if installed properly and adjusted to the manufacturer's specifications. The trailer brakes must meet local and Federal regulations.



Do not connect a trailer's hydraulic brake system directly to your vehicle's brake system. Your vehicle may not have enough braking power and your chances of having a collision greatly increase.

The braking system of the tow vehicle is rated for operation at the GVWR not GCWR.

Trailer lamps

Trailer lamps are required on most towed vehicles. Make sure your trailer lamps conform to local and Federal regulations. See your dealer or trailer rental agency for proper instructions and equipment for hooking up trailer lamps.

Using a step bumper

The rear bumper is equipped with an integral hitch and requires only a ball with a 25.4 mm (one inch) shank diameter. The bumper has a 2 270 kg (5 000 lb.) trailer weight and 227 kg (500 lb.) tongue weight capability.

If it is necessary to relocate the trailer hitch ball position, a frame-mounted trailer hitch must be installed.

Driving while you tow

Do not drive faster than 88 km/h (55 mph) when towing a trailer. Do not drive faster than 72 km/h (45 mph) with any weight on the trailer while towing on a hot day or in hilly country.

Speed control may shut off if you are towing on long, steep grades.

When towing a trailer:

- Use D (Drive) or a lower gear when towing up or down steep hills. This will eliminate excessive downshifting and upshifting for optimum fuel economy and transmission cooling.
- Anticipate stops and brake gradually.

When descending long, steep downhill grades, always use a lower gear to provide engine braking to save wear on brakes. Use Drive (Overdrive OFF) on moderately steep hills, Second (2) on steep hills, and First (1) on very steep hills.

Servicing after towing

If you tow a trailer for long distances, your vehicle will require more frequent service intervals. Refer to the Severe Duty Schedule in your "Service Guide" for more information.

Driving

Trailer towing tips

- Practice turning, stopping and backing up in an area before starting on a trip to get the feel of the vehicle trailer combination. When turning, make wider turns so the trailer wheels will clear curbs and other obstacles.
- Allow more distance for stopping with a trailer attached.
- The trailer tongue weight should be 10–15% of the loaded trailer weight.
- After you have traveled 80 km (50 miles), thoroughly check your hitch, electrical connections and trailer wheel lug nuts.
- When stopped in traffic for long periods of time in hot weather, place the gearshift in P (Park) and increase idle speed. This aids engine cooling and air conditioner efficiency.
- Vehicles with trailers should not be parked on a grade. If you must park on a grade, place wheel chocks under the trailer's wheels.

Launching or retrieving a boat

When backing down a ramp during boat launching or retrieval,

- Do not allow the static water level to rise above the bottom edge of the rear bumper and
- Do not allow waves to break higher than 15 cm (six inches) above the bottom edge of the rear bumper.

Exceeding these limits may allow water to enter critical vehicle components, adversely affecting driveability, emissions and reliability.

If the rear axle is submerged in water, the rear axle lubricant should be changed. Axle lubricant quantities are not to be checked unless a leak is suspected.

FUEL CONSUMPTION

Fuel economy can be improved by avoiding:

- lack of regular, scheduled maintenance.
- excessive speed.
- rapid acceleration.
- extended idle.

Roadside emergencies

HAZARD LIGHTS CONTROL

Use only in an emergency to warn traffic of vehicle breakdown, approaching danger, etc. The hazard flashers can be operated when the ignition is off.

- The hazard lights control is located on top of the steering column.
- Depress hazard lights control to activate all hazard flashers simultaneously.
- Depress control again to turn the flashers off.

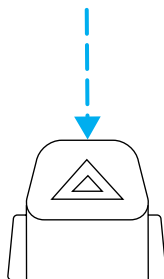

FUEL PUMP SHUT-OFF SWITCH

If the engine cranks but does not start after a collision, the fuel pump shut-off switch may have been activated. The shut-off switch is a device intended to stop the electric fuel pump when your vehicle has been involved in a substantial jolt.

1. Turn the ignition to the OFF position.
2. Check the fuel system for leaks.
3. If no fuel leak is apparent, reset the fuel pump shut-off switch by pushing in the button on the switch.
4. Turn the ignition to the ON position. Pause for a few seconds and return the key to the OFF position.
5. Make a further check for leaks in the fuel system.

Roadside emergencies

- Except commercial stripped chassis vehicles

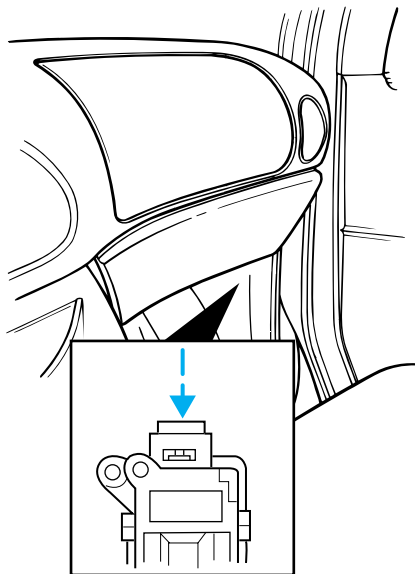

- Commercial stripped chassis vehicles

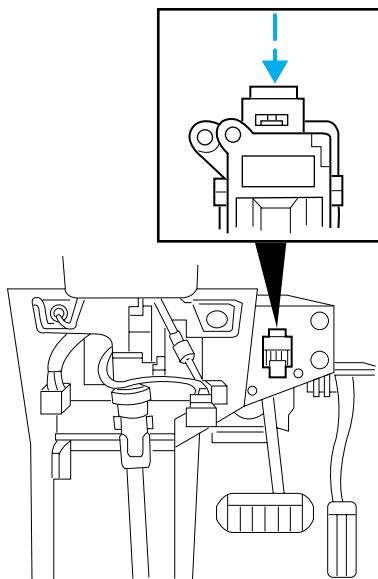

Roadside emergencies

FUSES AND RELAYS

Fuses

If electrical components in the vehicle are not working, a fuse may have blown. Blown fuses are identified by a broken wire within the fuse. Check the appropriate fuses before replacing any electrical components.

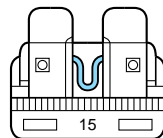
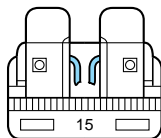

Always replace a fuse with one that has the specified amperage rating. Using a fuse with a higher amperage rating can cause severe wire damage and could start a fire.

Standard fuse amperage rating and color

Fuse rating	Color
5 amp	Tan
7.5 amp	Brown
10 amp	Red
15 amp	Light blue
20 amp	Yellow
20 amp fuse link	Light blue
25 amp	Natural
30 amp	Light green
30 amp fuse link	Pink
40 amp fuse link	Green
50 amp fuse link	Red
60 amp fuse link	Yellow
80 amp fuse link	Black
100 amp fuse link	Dark blue

Passenger compartment fuse panel

The fuse panel is located below and to the left of the steering wheel by the brake pedal. Remove the panel cover to access the fuses.

Roadside emergencies

To remove a fuse use the fuse puller tool provided on the fuse panel cover.

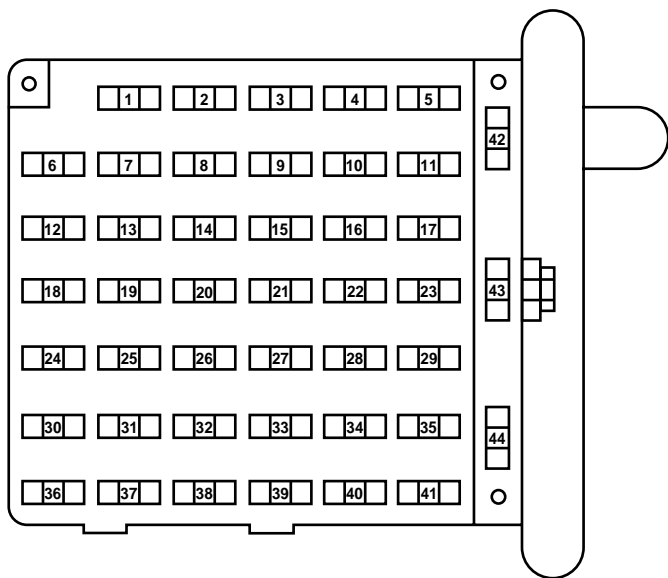

The fuses are coded as follows.

Fuse/Relay Location	Fuse Amp Rating	Description
1	20A	RABS/4WABS Module
2	15A	Brake Warning Diode/Resistor, Instrument Cluster, Warning Chime, 4WABS Relay, Warning Indicators
3	15A	Main Light Switch, RKE Module, Radio
4	15A	Power Locks w/RKE, Illuminated Entry, Warning Chime, Modified Vehicle, Power Mirrors, Main Light Switch, Courtesy Lamps
5	20A	RKE Module, Power Lock Switches, Memory Lock, Power Locks with RKE

Roadside emergencies

Fuse/Relay Location	Fuse Amp Rating	Description
6	10A	Shift Interlock, Speed Control, DRL Module
7	10A	Multi-Function Switch, Turn Signals
8	30A	Radio Capacitor(s), Ignition Coil, PCM Diode, PCM Power Relay, Fuel Heater, Glow Plug Relay (Diesel)
9	30A	Wiper Control Module, Windshield Wiper Motor
10	20A	Main Light Switch, (External Lamps) Multi-Function Switch (Flash-to-pass)
11	15A	Brake Pressure Switch, Multi-Function Switch (Hazards), RABS, Brake Pedal Position Switch
12	15A	Transmission Range (TR) Sensor, Auxiliary Battery Relay
13	15A	Blend Door Actuator, Function Selector Switch
14	5A	Instrument Cluster (Air Bag and Charge Indicator)
15	5A	Trailer Battery Charge Relay
16	30A	Power Seats
17	—	Not Used
18	—	Not Used
19	10A	Air Bag Diagnostic Monitor
20	5A	Overdrive Cancel Switch
21	30A	Power Windows*
22	15A	Memory Power Radio
23	20A	Cigar Lighter, Data Link Connector (DLC)
24	5A	Illuminated Entry Module
25	10A	Left Headlamp (Low Beam)
26	-	Not Used
27	5A	Radio
28	25A	Power Plug

Roadside emergencies

Fuse/Relay Location	Fuse Amp Rating	Description
29	—	Not Used
30	15A	Headlamps (High Beam Indicator), DRL
31	10A	Right Headlamp (Low Beam), DRL
32	—	Not Used
33	—	Not Used
34	10A	Transmission Range (TR) Sensor
35	—	Not Used
36	5A	(Cluster, A/C, Illumination, Radio), Steering Column Assembly
37	—	Not Used
38	10A	Air Bag Diagnostic Monitor
39	—	Not Used
40	30A	Modified Vehicle
41	30A	Modified Vehicle
42	—	Not Used
43	20A C.B.	Power Windows*
44	—	Not Used

*Either fuse 21 or circuit breaker 43 will be present for power windows.

Power distribution box

The power distribution box is located in the engine compartment. The power distribution box contains high-current fuses that protect your vehicle's main electrical systems from overloads.



Always disconnect the battery before servicing high current fuses.



Always replace the cover to the Power Distribution Box before reconnecting the battery or refilling fluid reservoirs.

Roadside emergencies

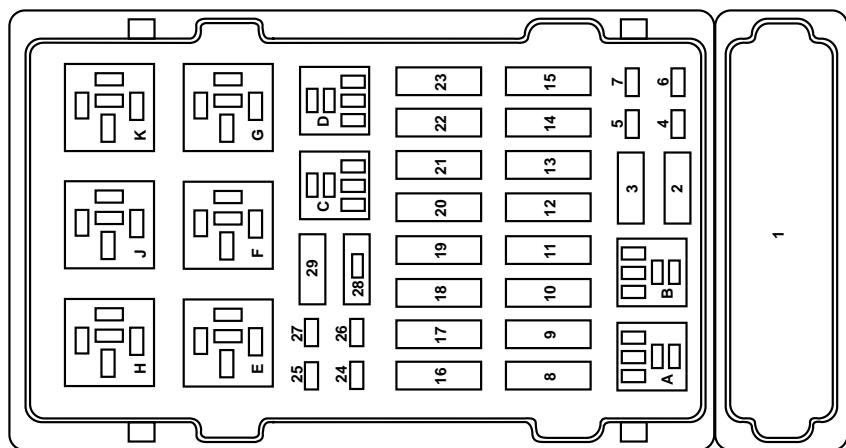

The high-current fuses are coded as follows.

Fuse/Relay Location	Fuse Amp Rating	Description
1	—	Not Used
2	—	Not Used
3	—	Not Used
4	10A	PCM Keep Alive Memory, Instrument Cluster
5	10A	Right Trailer Turn Signal
6	10A	Left Trailer Turn Signal
7	—	Not Used
8	60A	I/P Fuses 5, 11, 23, 38, 4, 10, 16, 22, 28
9	30A	PCM Power Relay, Engine Compartment Fuse 4
10	60A	Auxiliary Battery Relay, Engine Compartment Fuses 14, 22
11	30A	IDM Relay (1998 1/2 Vehicles)
12	60A	Engine Compartment Fuses 26, 27
13	50A	Blower Motor Relay (Blower Motor)

Roadside emergencies

Fuse/Relay Location	Fuse Amp Rating	Description
14	30A	Trailer Running Lamps Relay, Trailer Backup Lamps Relay
15	40A	Main Light Switch
16	50A	RKE Module, Auxiliary Blower Motor Relay
17	30A	Fuel Pump Relay, IDM (Diesel)
18	60A	I/P Fuses 40, 41
19	60A	4WABS Module
20	20A	Electric Brake Controller
21	50A	Modified Vehicle Power
22	40A	Trailer Battery Charge Relay (Modified Vehicles Only)
23	60A	Ignition Switch
24	—	Not Used
25	20A	NGV Module
26	10A	Generator/Voltage Regulator (Diesel Only)
27	15A	DRL Module, Horn Relay
28	—	PCM Diode
29	—	Not Used
A	—	Not Used
B	—	Not Used
C	-	Trailer Backup Lamps Relay
D	-	Trailer Running Lamps Relay
E	-	Trailer Battery Charge Relay
F	-	IDM Relay
G	-	PCM Relay
H	-	Blower Motor Relay
J	-	Horn Relay
K	-	Fuel Pump Relay, IDM Relay (Diesel)

Relays

Relays are located in the power distribution box and should be replaced by qualified technicians.

Roadside emergencies

CHANGING THE TIRES

If you get a flat tire while driving, do not apply the brake heavily. Instead, gradually decrease your speed. Hold the steering wheel firmly and slowly move to a safe place on the side of the road.

Spare tire information

The spare tire for your vehicle is stowed under the rear of your vehicle (except cutaway and stripped chassis models).

To remove the spare tire:

1. Open both rear doors and remove thumb screw and anti-theft bracket. If finger pressure will not remove the thumb screw, use the lug wrench to loosen the screw.

2. Remove the access cover from the rubber strip behind the left door.

3. Insert the tapered end of the lug wrench or the tip of the jack handle through the access hole and into the tube.

4. Turn the wrench counterclockwise until the cable is slack and the tire can be slid rearward from under the vehicle.

5. Remove the retainer from the spare tire.

To stow the cable retainer with the spare removed, turn the jack handle wrench clockwise until all slack is removed.

To stow the spare tire:

1. Lay the tire on the ground under the rear of the vehicle with the valve stem facing up.

Stow aluminum wheels with valve stem facing down.

2. Install the retainer through the wheel center.

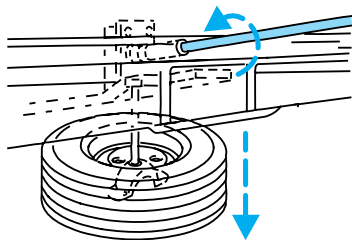
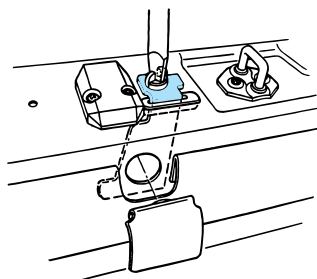

Roadside emergencies

3. Raise the tire by turning the wrench or handle clockwise. Continue until the lift mechanism “clicks.”

4. Check that the tire is tightly seated under the vehicle by pushing against the tire. Retighten as necessary.

5. Replace the access cover, anti-theft bracket and thumb screw. Use finger pressure only to secure the thumb screw.

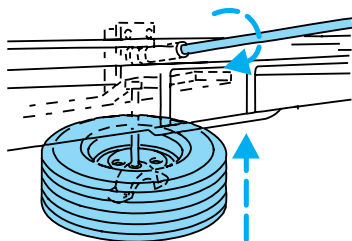

Make sure the spare tire and jacking equipment are stowed and secured in the proper storage location.



Never run the engine with one wheel off the ground.

Tire change procedure

Preparing to change the tire

1. Park on a level surface.
2. Activate the warning flashers.
3. Place the gearshift in P (Park)(automatic transmission) or R (Reverse)(manual transmission).
4. Apply the parking brake.

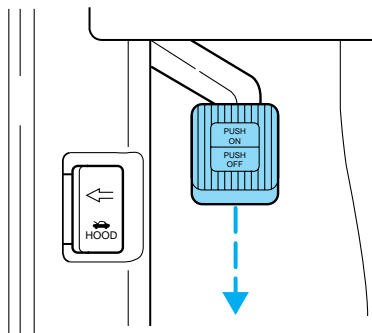

Roadside emergencies

5. Block the wheel that is diagonally opposite the tire you are changing.

On E-Super Duty vehicles, the parking brake is on the transmission. Therefore, the vehicle will not be prevented from moving when a rear wheel is lifted, even if the parking brake is applied. Be sure to block both directions of the wheel that is diagonally opposite to the wheel that is being lifted.

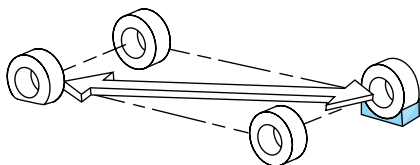

If the vehicle slips off the jack, you or someone else could be seriously injured.

6. Remove the spare tire and jack from the storage location.

7. Use the tapered end of the lug nut wrench to unscrew wheel ornaments attached by retaining screws. Remove any wheel trim. Insert the tapered end of the lug nut wrench behind wheel covers or hubcaps and twist off.

8. Loosen the wheel nuts by pulling up on the handle of the lug nut wrench about one-half turn (counterclockwise). Do not remove the wheel lug nuts until you raise the tire off the ground.

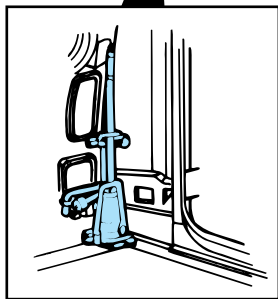
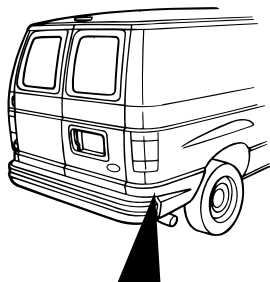

Roadside emergencies

Replacing the tire

1. Assemble the jack handle sections together and lock into jack. Use the jack handle to slide the jack under the vehicle.



To lessen the risk of personal injury, do not put any part of your body under the vehicle while changing a tire. Do not start the engine when your vehicle is on the jack. The jack is only meant for changing the tire.

2. Position the jack to raise the front or rear wheel.

- **Never use the front or rear differential as a jacking point.**

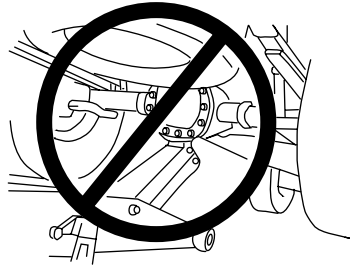

Rear axle jacking points:

- All models except E-Super Duty

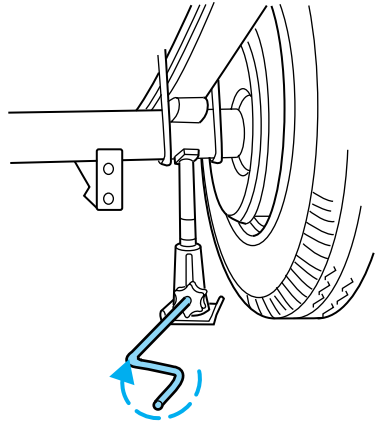

Roadside emergencies

- E-Super Duty

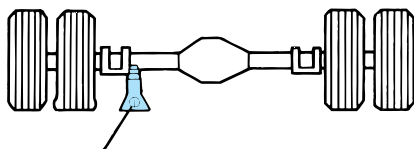

Front axle jacking points:

- All models

Place the jack under the pin on the front axle.

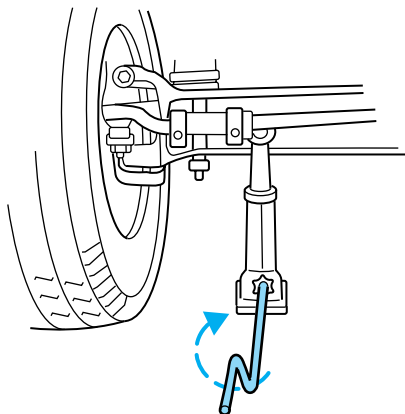

3. Turn the jack handle clockwise until the wheel is completely off the ground.

4. Remove the lug nuts with the lug nut wrench.

5. Replace the flat tire with the spare tire.

If your vehicle has dual rear wheels, there are locating pins on the hubs and wheels with corresponding holes. When you install the wheel make sure that the pins are aligned with the proper holes.

If your vehicle has single rear wheels, thread the lug nuts on the studs with the beveled face toward the wheel.

If your vehicle has dual rear wheels, thread the two element swiveling lug nuts on the studs with the flange facing toward the wheel.

6. Use the lug nut wrench to screw the lug nut snugly against the wheel.

7. Lower the vehicle by turning the jack handle counterclockwise.

8. Remove the jack and fully tighten the lug nuts in the following pattern:

Roadside emergencies

- 5 lug wheel

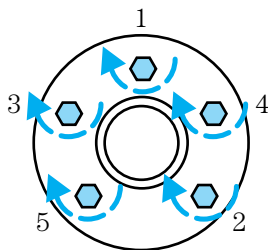

- 8 lug wheel

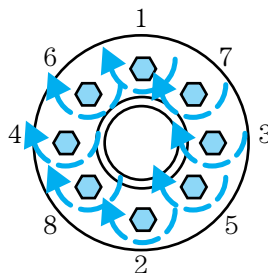

Never use wheels or lug nuts different than the original equipment as this could damage the wheel or mounting system. This damage could allow the wheels to come off while the vehicle is being driven.

9. Replace any wheel covers, ornaments or hub caps. Make sure they are screwed or snapped in place.
10. Stow the jack, handle and lug wrench.
11. Unblock the wheels.

On vehicles equipped with dual rear wheels, retighten the wheel lug nuts to the specified torque at 160 km (100 miles), and again at 800 km (500 miles) of new vehicle operation and at intervals specified in the "Service Guide."

On vehicles equipped with single rear wheels, retighten the lug nuts to the specified torque at 800 km (500 miles) of operation after any wheel change or any time the lug nuts are loosened.

Roadside emergencies

Model	Bolt Size	Wheel Lug nut Torque*	
		N•M	Ft-Lb
E-150	1/2-20	135	100
E-250, E-350 and E-Super Duty	9/16-18	190	140

* Torque specifications are for nut and bolt threads free of dirt and rust. Do not use oil or grease on threads. Use only Ford recommended replacement fasteners.

JUMP STARTING YOUR VEHICLE



The gases around the battery can explode if exposed to flames, sparks, or lit cigarettes. An explosion could result in injury or vehicle damage.



Do not push start your vehicle. You could damage the catalytic converter.



Batteries contain sulfuric acid which burns skin, eyes, and clothing.

Preparing your vehicle

Also see the label on the battery.

1. Use only a 12-volt supply to start your vehicle. If you connect your battery to a 24-volt power supply you can damage your starter, ignition system and other electrical components.
2. Do not disconnect the battery of the disabled vehicle as this could damage the vehicle's electrical system.
3. Park the booster vehicle close to the hood of the disabled vehicle making sure they **do not** touch. Set the parking brake on both vehicles and stay clear of the engine cooling fan and other moving parts.
4. Check all battery terminals and remove any excessive corrosion before you attach the battery cables.
5. Turn the heater fan on in both vehicles to protect any electrical surges. Turn all other accessories off.

Roadside emergencies

Connecting the jumper cables

1. Position the vehicles so that they do not touch one another.
2. Switch off the engine. Switch off any unnecessary electrical equipment.
3. Connect the positive (+) terminal of the discharged battery (1) to the positive (+) terminal of the booster battery (2).
4. Connect one end of the second lead to the negative (-) terminal of the booster battery (3) and the other end to a metal part of the engine to be started (4), not to the negative (-) terminal of the discharged battery.
5. Make sure that the jump leads are clear of moving parts of the engine.

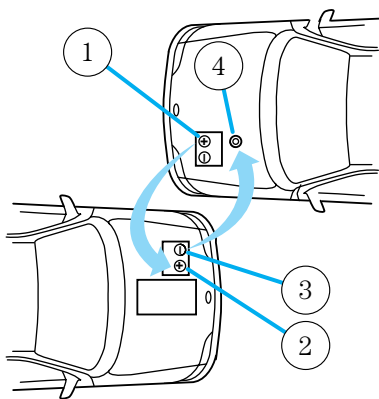

Do not connect the end of the second cable to the negative (-) terminal of the battery to be jumped. A spark may cause an explosion of the gases that surround the battery.

Roadside emergencies

Jump starting

1. Start the booster vehicle and run the engine at moderately increased speed.
2. Start the engine of the vehicle with the discharged battery.
3. Once the engine has been started, run both vehicles for a further three minutes before disconnecting the leads.

Removing the jumper cables

1. Remove the jumper cables in reverse order. Take the cable off the metallic surface (1) first, followed by the cable on the negative (-) booster battery terminal (2).
2. Remove the cable from the positive (+) terminal of the booster battery (3) and then the discharged battery (4).
3. After the disabled vehicle has been started, allow it to idle for a while so the engine can “relearn” its idle conditions.

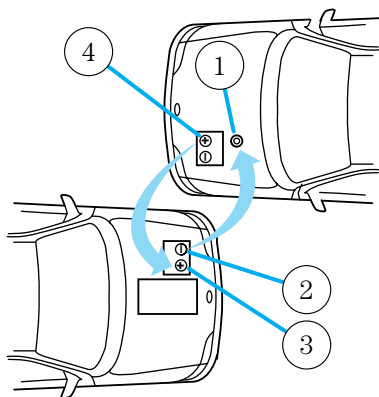

Roadside emergencies

WRECKER TOWING

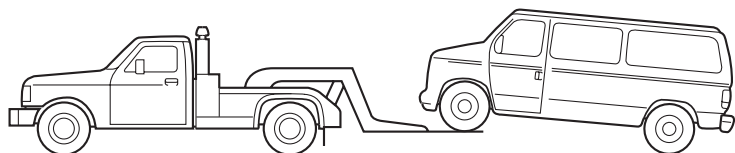
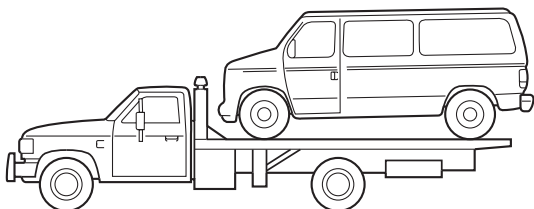
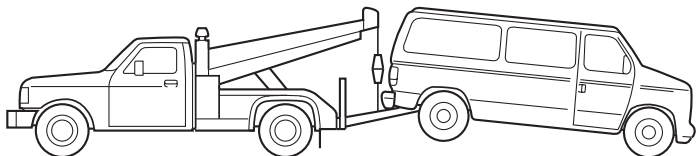

If you need to have your vehicle towed, contact a professional towing service or, if you are a member, your roadside assistance center. It is recommended that your vehicle be towed with a wheel lift or flatbed equipment.

When calling for a tow truck, tell the operator what kind of vehicle you have. A towing manual is available from Ford Motor Company for all authorized tow truck operators. Have your tow truck driver refer to this manual for proper hook-up and towing procedures for your vehicle.

SERVICE RECOMMENDATIONS

To help you service your vehicle:

- We highlight do-it-yourself items in the engine compartment for easy location.
- We provide a “Service Guide” which makes tracking routine service easy.

If your vehicle requires professional service, your dealership can provide necessary parts and service. Check your “Warranty Guide” to find out which parts and services are covered.

Use only recommended fuels, lubricants, fluids and service parts conforming to specifications. Motorcraft parts are designed and built to provide the best performance in your vehicle.

PRECAUTIONS WHEN SERVICING YOUR VEHICLE

Be especially careful when inspecting or servicing your vehicle.

- Do not work on a hot engine.
- When the engine is running, make sure that loose clothing, jewelry or long hair does not get caught up in moving parts.
- Do not work on a vehicle with the engine running in an enclosed space, unless you are sure you have enough ventilation.
- Keep all lit cigarettes, open flames and other lit material away from the battery and all fuel related parts.

If you disconnect the battery, the engine must “relearn” its idle conditions before your vehicle will drive properly, as explained in *Battery* in this chapter.

Working with the engine off

1. Set the parking brake and ensure the gearshift is securely latched in P (Park).
2. Turn off the engine and remove the key.
3. Block the wheels to prevent the vehicle from moving unexpectedly.

Maintenance and care

Working with the engine on

1. Set the parking brake and ensure the gearshift is securely latched in P (Park).
2. Block the wheels to prevent the vehicle from moving unexpectedly.



Do not start your engine with the air cleaner removed and do not remove it while the engine is running.

OPENING THE HOOD

1. Inside the vehicle, pull the hood release handle located under the bottom of the instrument panel.
2. Go to the front of the vehicle and release the auxiliary latch that is located under the front center of the hood. Lift the hood until the lift cylinders hold it open.

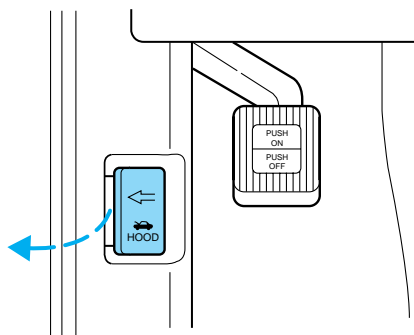

IDENTIFYING COMPONENTS IN THE ENGINE COMPARTMENT

Engine Compartment Component Locations

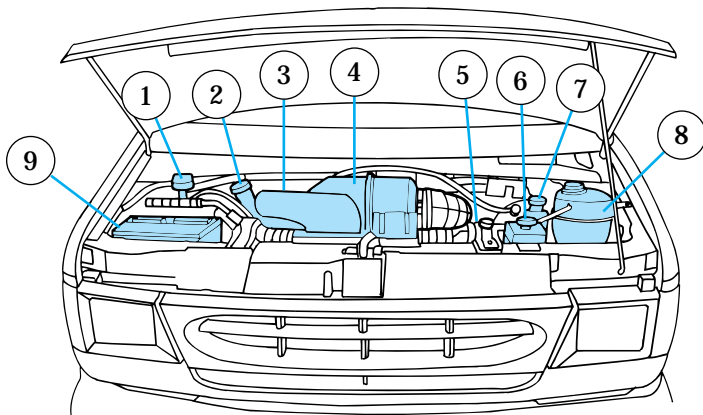

Maintenance and care

1. Windshield washer fluid reservoir
2. Engine oil filler
3. Automatic transmission fluid dipstick
4. Air filter assembly
5. Engine oil dipstick
6. Power steering fluid reservoir
7. Brake fluid reservoir
8. Engine coolant recovery reservoir
9. Battery

ENGINE OIL

Checking the engine oil

Check the engine oil each time you fuel your vehicle.

1. Make sure the vehicle is on level ground.
 2. Turn the engine off and wait a few minutes for the oil to drain into the oil pan.
 3. Set the parking brake and ensure the gearshift is securely latched in P (Park).
 4. Open the hood. Protect yourself from engine heat.
 5. Locate and carefully remove the engine oil level indicator (dipstick).
- 4.2L V6/5.4L V8/6.8L V10 engines

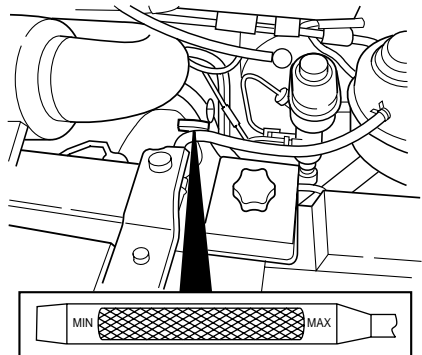

Maintenance and care

- 4.6L V8 engine

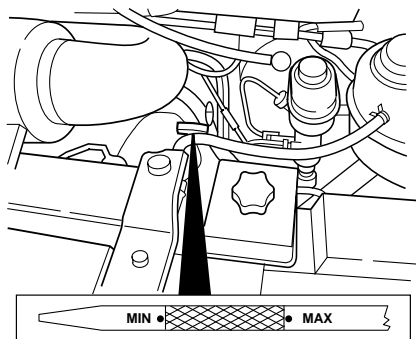

6. Wipe the indicator clean. Insert the indicator fully, then remove it again.

- If the oil level is **between the MIN and MAX marks** the oil level is acceptable. **DO NOT ADD OIL.**
- If the oil level is below the MIN mark, add enough oil to raise the level within the MIN-MAX range.

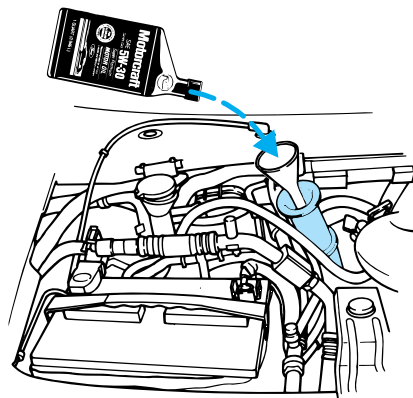

- Oil levels above the MAX mark may cause engine damage. Some oil must be removed from the engine by a service technician.

7. Put the indicator back in and ensure it is fully seated.

Maintenance and care

Adding engine oil

1. Check the engine oil. For instructions, refer to *Checking the engine oil* in this chapter.
2. If the fluid level is not within the normal range, add only certified engine oil of the preferred viscosity. Add engine oil through the oil filler cap. Remove the filler cap and use a funnel to pour oil in the opening.
3. Recheck the oil level. Make sure the oil level is not above the MAX mark on the dipstick.

Changing the engine oil and filter

Change your engine oil and filter according to the appropriate schedule listed in the “Service Guide”.

Ford production and aftermarket (Motorcraft) oil filters are designed for added engine protection and long life. If a replacement oil filter is used that does not meet Ford material and design specifications, startup engine noises or knock may be experienced.

It is recommended you use the appropriate Motorcraft oil filter (or another brand meeting Ford specifications) for your engine application.

Engine oil and filter recommendations

Look for this certification mark.

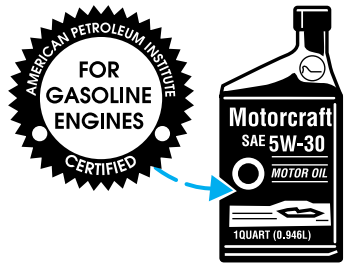

Ford oil specification is WSS-M2C153-G.

Use SAE 5W-30 motor oil certified for gasoline engines by the American Petroleum Institute.

Do not use supplemental engine oil additives, oil treatments or engine treatments. They are unnecessary and could, under certain conditions, lead to engine damage which is not covered by your warranty.

Change your engine oil and filter according to the appropriate schedule listed in the “Service Guide”.

Maintenance and care

Ford production and aftermarket (Motorcraft) oil filters are designed for added engine protection and long life. If a replacement oil filter is used that does not meet Ford material and design specifications, startup engine noises or knock may be experienced.

It is recommended you use the appropriate Motorcraft oil filter (or another brand meeting Ford specifications) for your engine application.

BRAKE FLUID

Checking and adding brake fluid

Brake fluid should be checked and refilled as needed at least once each year:

1. Clean the reservoir cap before removal to prevent dirt or water from entering the reservoir.
2. Visually inspect the fluid level.
3. If necessary, add brake fluid until the level reaches MAX. Do not fill above this line.
4. Use only a DOT 3 brake fluid certified to meet Ford specifications.

Refer to *Lubricant specifications* in the *Capacities and specifications* chapter.

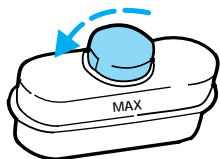
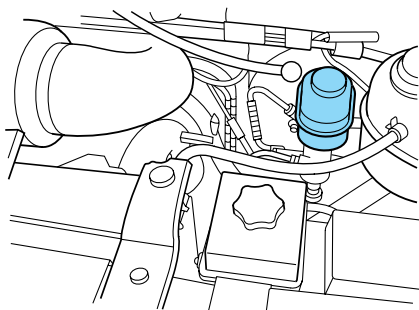

Brake fluid is toxic.



If you use a brake fluid that is not DOT 3, you will cause permanent damage to your brakes.



Do not let the reservoir for the master cylinder run dry. This may cause the brakes to fail.

Maintenance and care

WINDSHIELD WASHER FLUID

Checking and adding washer fluid

Check the washer fluid whenever you stop for fuel. The reservoir is highlighted with a  symbol.

If the level is low, add enough fluid to fill the reservoir. In very cold weather, do not fill the reservoir all the way.

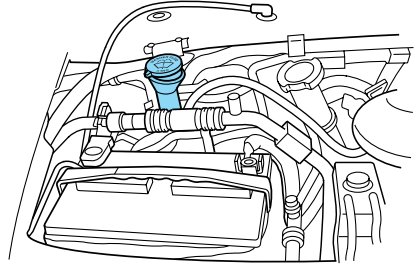

Do not put engine coolant in the container for the windshield washer fluid.

ENGINE COOLANT

Check the level of the engine coolant in the reservoir at least once a month. Be sure to read and understand *Precautions when servicing your vehicle* in this chapter.

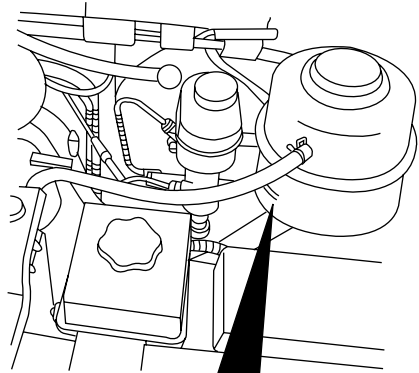

COLD FILL LEVEL 

If the engine coolant has not been checked for a long period of time, the engine coolant reservoir may eventually empty. If this occurs, add engine coolant to the reservoir. For more information on engine coolant

Maintenance and care

maintenance, refer to *Adding engine coolant* in this chapter.

Automotive fluids are not interchangeable; do not use engine coolant, antifreeze or windshield washer fluid outside of its specified function and vehicle location.

Adding engine coolant



Do not put engine coolant in the container for the windshield washer fluid.

If sprayed on the windshield, engine coolant could make it difficult to see through the windshield.

When the engine is cool, add a 50/50 mixture of engine coolant and water to the engine coolant recovery reservoir-DO NOT ADD DIRECTLY TO THE RADIATOR. Add straight water only in an emergency, but you should replace it with a 50/50 mixture of coolant and distilled water as soon as possible.

Check the coolant level in the coolant recovery reservoir the next few times you drive the vehicle. If necessary, add enough of a 50/50 mixture of coolant and water to bring the liquid level to the fill line on the reservoir.



Never remove the coolant recovery cap while the engine is running or hot.

If you must remove the coolant recovery cap, follow these steps to avoid personal injury:

1. Before you remove the cap, turn the engine off and let it cool.
2. When the engine is cool, wrap a thick cloth around the cap. Slowly turn cap counterclockwise until pressure begins to release.
3. Step back while the pressure releases.
4. When you are sure that all the pressure has been released, use the cloth to turn it counterclockwise and remove the cap.

Use Ford Premium Cooling System Fluid E2FZ-19549-AA (in Canada, Motorcraft CXC-8-B) or an equivalent premium engine coolant that meets Ford specification ESE-M97B44-A. Ford Premium Engine Coolant is an optimized formula that will protect all metals and rubber elastomers used in Ford cooling systems for four years or 80,000 km (50,000 miles).

Maintenance and care

Do not use alcohol or methanol antifreeze or any engine coolants mixed with alcohol or methanol antifreeze. Do not use supplemental coolant additives in your vehicle. These additives may harm your engine cooling system. The use of an improper coolant may void your warranty of your vehicle's engine cooling system.

Recycled engine coolant

Ford Motor Company recommends that Ford and Lincoln-Mercury dealers use recycled engine coolant produced by Ford-approved processes. Not all coolant recycling processes produce coolant which meets Ford specification ESE-M97B44-A, and use of such coolant may harm engine and cooling system components.



Always dispose of used automotive fluids in a responsible manner. Follow your community's regulations and standards for recycling and disposing of automotive fluids.

Coolant refill capacity

To find out how much fluid your vehicle's cooling system can hold, refer to *Refill capacities* in the *Capacities and specifications* chapter.

Have your dealer check the engine cooling system for leaks if you have to add more than a liter (quart) of engine coolant per month.

Severe winter climate

If you drive in extremely cold climates (less than -36°C [-34°F]), it may be necessary to increase the coolant concentration above 50%. Refer to the chart on the coolant container to ensure the coolant concentration in your vehicle is such that the coolant will not freeze at the temperature level in which you drive during winter months. Never increase the engine coolant concentration above 60%. Leave a 50/50 mixture of engine coolant and water in your vehicle year-round in non-extreme climates.

What you should know about fail-safe cooling (if equipped)



If the engine coolant supply is depleted, this feature allows the vehicle to be driven temporarily before incremental component damage is incurred. The "fail safe" distance depends on ambient temperatures, vehicle load and terrain.

Maintenance and care

How fail-safe cooling works

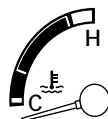
If the engine overheats, the engine will automatically switch to alternating cylinder operation. Each disabled cylinder acts as an air pump and cools the engine.



When this occurs, the engine coolant temperature gauge will move into the red area, the ,  and the service engine soon lights will illuminate.

The vehicle will still operate, but will have limited engine power and no air conditioning capability.

Continued operation will increase engine temperature and cause the engine to completely shut down. The vehicle will coast to a stop.

As the engine temperature cools, the engine may be re-started. Take your vehicle to a service facility as soon as possible to minimize engine damage.

When fail-safe mode is activated

- Pull off the road as soon as possible.
- Immediately turn the engine off to prevent severe engine damage.
- Wait for the engine to cool.
- Check the coolant level.

CHECKING AND ADDING POWER STEERING FLUID

Check the power steering fluid at least twice a year. If adding fluid is necessary, use only MERCON® ATF.

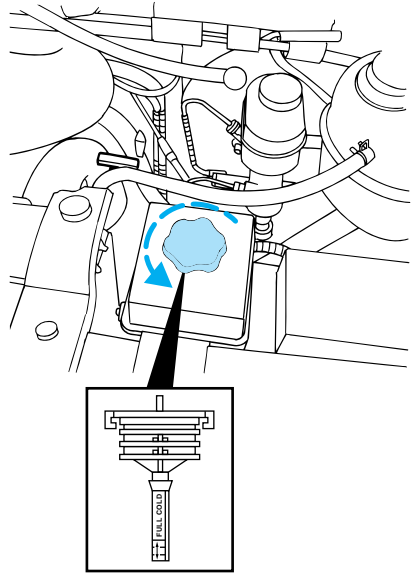

1. Start the engine and let it run until it reaches normal operating temperature (the engine coolant temperature gauge will be near the center of the NORMAL band).
2. While the engine idles, turn the steering wheel left and right several times.
3. Turn the engine off.
4. Check the fluid level on the dipstick. It should be between the arrows in the FULL HOT range. Do not add fluid if the level is within this range.
5. If the fluid is low, add fluid in small amounts, continuously checking the level until it reaches the FULL HOT range. Be sure to put the dipstick back in the reservoir.

Maintenance and care

TRANSMISSION FLUID

Checking and adding automatic transmission fluid

Follow the scheduled service intervals outlined in the “Service Guide”.

Before adding any fluid, make sure the correct type is used. The type of fluid used is normally indicated on the dipstick and/or dipstick handle and also in the *Lubricant specifications* section in the *Capacities and specifications* chapter.

An overfill condition of transmission fluid may cause shift and/or engagement concerns and/or possible damage.

Do not drive the vehicle if the fluid level is below the COLD (C) area on the dipstick and outside temperatures are above 10°C (50°F) (see figure to the right).



Your transmission does not use up fluid. However, it is recommended that you check the transmission fluid at least twice a year. The fluid level should be checked if the transmission is not working properly, i.e., if the transmission slips or shifts slowly or if you notice some sign of fluid leakage.

Transmission fluid should be checked at normal operating temperatures 66°C-77°C (150°F-170°F) on a level surface. The normal operating temperature can be reached after approximately 32 km (20 miles) of driving.

The transmission fluid should be in this range if at normal operating temperature (66°C-77°C [150°F-170°F]) (see figure to the right).

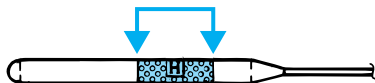

The transmission fluid should be in this range if at room temperature (10°C-35°C [50°F-95°F]) (see figure to the right).



If your vehicle has been operated for an extended period at high speeds, in city traffic during hot weather or pulling a trailer, the vehicle should be turned off for about 30 minutes to allow the fluid to cool before checking.

1. Park the vehicle on a level surface and engage the parking brake.

Maintenance and care

2. With the parking brake engaged and your foot on the brake pedal, start the engine and move the gearshift lever through all of the gear ranges. Allow sufficient time for each gear to engage.



3. Latch the gearshift lever in P (Park) and leave the engine running.

4. Remove the dipstick, wiping it clean with a clean, dry lint free rag.

5. Install the dipstick making sure it is fully seated in the filler tube.

6. Remove the dipstick and inspect the fluid level. The fluid level should be in the HOT (H) area on the dipstick.

7. If necessary, add fluid in 250 ml (1/2 pint) increments through the filler tube until the level is correct.

8. If an overfill occurs, excess fluid should be removed by a qualified technician.

An overfill condition of transmission fluid may cause shift and/or engagement concerns and/or possible damage.

If the fluid is above the hot area range after driving the vehicle approximately 30 km (20 miles), excess transmission fluid should be removed by a qualified technician.

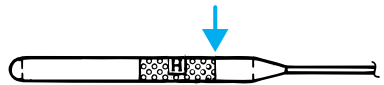

DRIVELINE UNIVERSAL JOINT AND SLIP YOKE

Your vehicle may be equipped with universal joints that require lubrication. If the original universal joints are replaced with universal joints equipped with grease fittings, lubrication will also be necessary.

Maintenance and care

BATTERY

Your vehicle may be equipped with a Superstart maintenance-free battery. If the original equipment battery needs replacing, it may be replaced with a low-maintenance battery. The low-maintenance battery normally does not require additional water during its life of service. However, for severe usage or in high temperature climates, check your battery electrolyte level, at least every 24 months or 40,000 km (24,000 miles). Keep the electrolyte in each cell up to the "level" indicator. Do not overfill the battery cells.

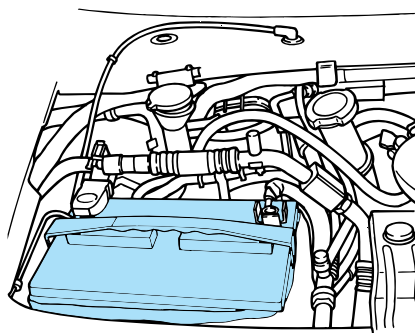

If the electrolyte level in the battery is low, you can add plain tap water to the battery, as long as you do not use hard water (water with a high alkali content). If possible, however, try to only fill the battery cells with distilled water. If the battery needs water often, have the charging system checked.

For longer, trouble-free operation, keep the top of the battery clean and dry. Also, make certain the battery cables are always tightly fastened to the battery terminals.

If you see any corrosion on the battery or terminals, remove the cables from the terminal(s) and clean with a wire brush. You can neutralize the acid with a solution of baking soda and water. Reinstall the cables when you are done cleaning them, and apply a small quantity of grease to the top of each battery terminal to help prevent corrosion.

If your battery has a cover/shield, make sure it is reinstalled after the battery is replaced.

Because your vehicle's engine is electronically controlled by a computer, some control conditions are maintained by power from the battery. When the battery is disconnected or a new battery is installed, the engine must relearn its idle conditions before your vehicle will drive properly. To begin this process:

1. Put the gearshift in P (Park), turn off all accessories and start the vehicle.
2. Let the engine idle for at least one minute.

Maintenance and care

3. The relearning process will automatically complete as you drive the vehicle.

- If you do not allow the engine to relearn its idle, the idle quality of your vehicle may be adversely affected until the idle is eventually relearned.
- If the battery has been disconnected or a new battery has been installed, the clock and the preset radio stations must be reset once the battery is reconnected.
- Always dispose of automotive batteries in a responsible manner. Follow your community's standards for disposal. Call your local recycling center to find out more about recycling automotive batteries.



Disconnecting dual batteries (if equipped)

The primary battery is located under the hood.

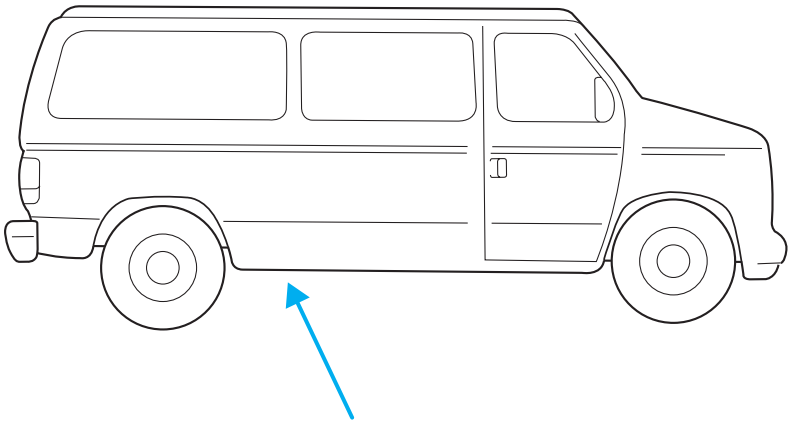

The auxiliary battery is located on the passenger side frame rail.

Maintenance and care

Gasoline engines

Disconnect:

1. Disconnect the primary battery ground cable.

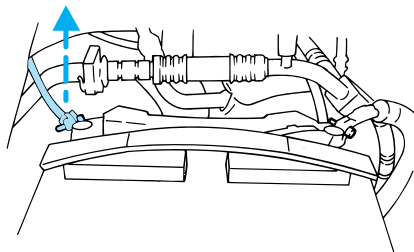

2. Disconnect the auxiliary battery frame ground.

Remove the ground bolt.

Pull the cable away from the frame and make sure that the cable does not contact the frame.

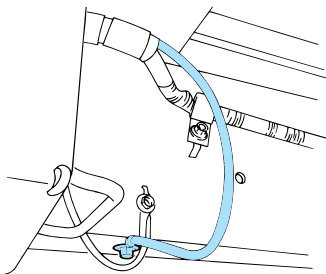

Connect:

1. Reconnect the auxiliary battery frame ground.

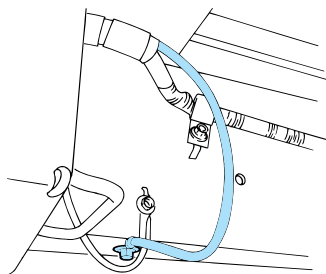

Maintenance and care

2. Reconnect the primary battery ground cable.

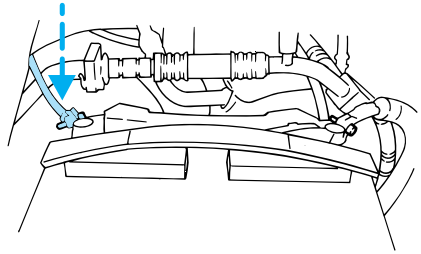

Diesel engines

Disconnect:



Secondary positive cable remains energized after disconnection. make sure the tool does not contact any ground surface.

1. Disconnect the secondary positive cable from the primary battery terminal.

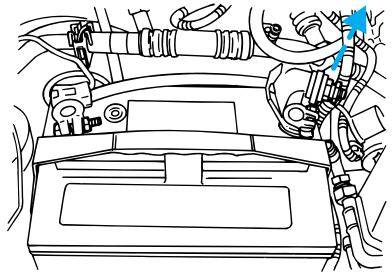

2. Wrap the secondary positive cable with a non-conductive material to insulate.

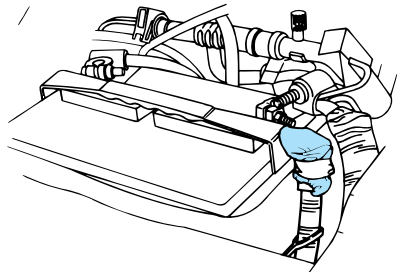

Maintenance and care

3. Disconnect the primary battery ground cable.
4. Disconnect the primary battery positive cable.

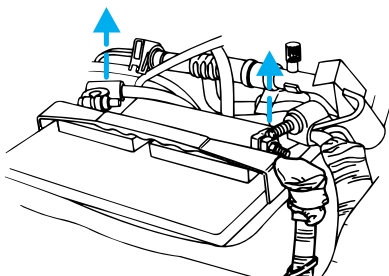

Connect:



Secondary positive cable remains energized after disconnection. make sure the tool does not contact any ground surface.

1. Reconnect the primary battery positive cable.
2. Reconnect the primary battery ground cable.

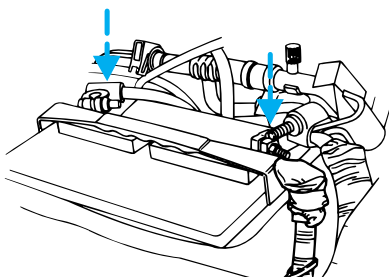

3. Unwrap the secondary positive cable and reconnect to the primary battery terminal.

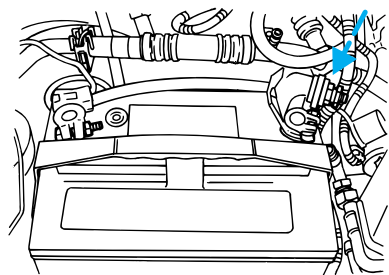

WINDSHIELD WIPER BLADES

Check the wiper blades at least twice a year or when they seem less effective. Substances such as tree sap and some hot wax treatments used by commercial car washes reduce the effectiveness of wiper blades.

Checking the wiper blades

If the wiper blades do not wipe properly, clean both the windshield and wiper blades using undiluted windshield wiper solution or a mild detergent. Rinse thoroughly with clean water. To avoid damaging the blades, do not use fuel, kerosene, paint thinner or other solvents.

Changing the wiper blades

When replacing wiper blade assemblies, always use a Motorcraft part or equivalent. To make replacing the wipers easy, turn the ignition to ACC, then turn the wipers on. When the wipers reach the vertical position, turn the ignition to LOCK.

To replace the wiper blades:

1. Pull the wiper arm away from the windshield and lock into the service position.
2. Turn the blade at an angle from the wiper arm. Push the lock pin with a screwdriver to release the blade and pull the wiper blade down toward the windshield to remove it from the arm.
3. Attach the new wiper to the wiper arm and press it into place until a click is heard.

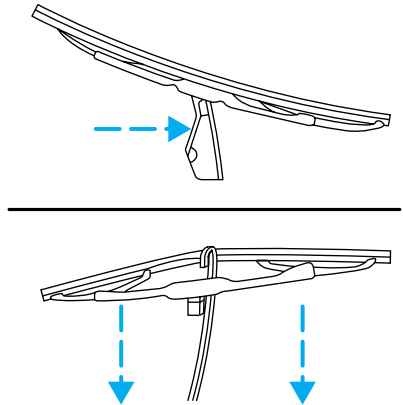

Maintenance and care

INFORMATION ABOUT TIRE QUALITY GRADES

New vehicles are fitted with tires that have their Tire Quality Grade (described below) molded into the tire's sidewall. These Tire Quality Grades are determined by standards that the United States Department of Transportation has set.

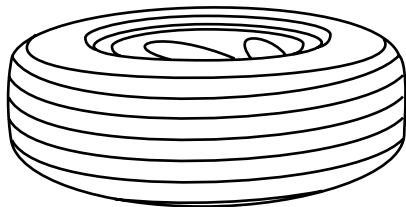

Tire Quality Grades apply to new pneumatic tires for use on passenger cars. They do not apply to deep tread, winter-type snow tires, space-saver or temporary use spare tires, tires with nominal rim diameters of 10 to 12 inches or limited production tires as defined in Title 49 Code of Federal Regulations Part 575.104(c)(2).

U.S. Department of Transportation-Tire quality grades: The U.S. Department of Transportation requires Ford to give you the following information about tire grades exactly as the government has written it.

Treadwear

The treadwear grade is a comparative rating based on the wear rate of the tire when tested under controlled conditions on a specified government test course. For example, a tire grade 150 would wear one and one-half (1 1/2) times as well on the government course as a tire grade 100. The relative performance of tires depends upon the actual conditions of their use, however, and may depart significantly from the norm due to variations in driving habits, service practices, and differences in road characteristics and climate.

Traction A B C

The traction grades, from highest to lowest are A, B, and C, and they represent the tire's ability to stop on wet pavement as measured under test surfaces of asphalt and concrete. A tire marked C may have poor traction performance.



The traction grade assigned to this tire is based on braking (straight ahead) traction tests and does not include cornering (turning) traction.

Maintenance and care

Temperature A B C

The temperature grades are A (the highest), B, and C, representing the tire's resistance to the generation of heat and its ability to dissipate heat when tested under controlled conditions on a specified indoor laboratory test wheel. Sustained high temperature can cause the material of the tire to degenerate and reduce tire life, and excessive temperature can lead to sudden tire failure. The grade C corresponds to a level of performance which all passenger car tires must meet under the Federal Motor Vehicle Safety Standard No. 109. Grades B and A represent higher levels of performance on the laboratory test wheel than the minimum required by law.



The temperature grade for this tire is established for a tire that is properly inflated and not overloaded. Excessive speed, underinflation, or excessive loading, either separately or in combination, can cause heat buildup and possible tire failure.

SERVICING YOUR TIRES

Checking the tire pressure

- Use an accurate tire pressure gauge.
- Check the tire pressure when tires are cold, after the vehicle has been parked for at least one hour or has been driven less than 5 km (3 miles).
- Adjust tire pressure to recommended specifications found on the Tire Pressure Label.



Improperly inflated tires can affect vehicle handling and can fail suddenly, possibly resulting in loss of vehicle control.

Tire rotation

Because your vehicle's tires perform different jobs, they often wear differently. To make sure your tires wear evenly and last longer, rotate them as indicated in the "Service Guide." If you notice that the tires wear unevenly, have them checked.

The following procedure applies to vehicles equipped with single rear wheels, if your vehicle is equipped with dual rear wheels it is recommended that only the front wheels be rotated (side to side).

Maintenance and care

- Four tire rotation

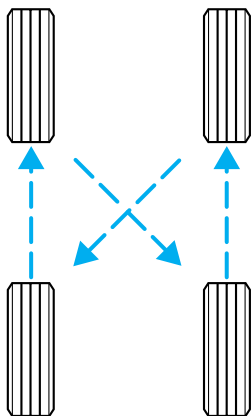

- Five tire rotation

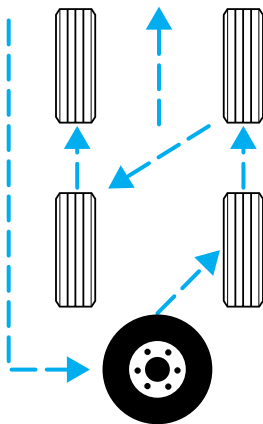

Maintenance and care

Replacing the tires

Replace the tires when the wear band is visible through the tire treads.

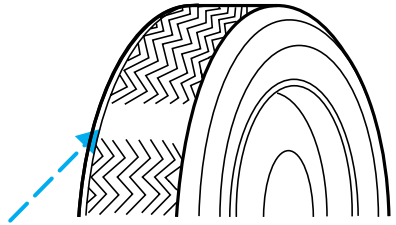

over.

Failure to follow these precautions may adversely affect the handling of the vehicle and make it easier to lose control and roll

Tires that are larger or smaller than your vehicle's original tires may also affect the accuracy of your speedometer.

SNOW TIRES AND CHAINS



Snow tires must be the same size and grade as the tires you currently have on your vehicle.

The tires on your vehicle have all weather treads to provide traction in rain and snow. However, in some climates, you may need to use snow tires and chains. If you need to use snow tires and chains, you must install steel wheels of the same size and specifications as those originally installed.

Follow these guidelines when using snow tires and chains:

- Use only SAE Class S chains.
- Install chains securely, verifying that the chains do not touch any wiring, brake lines or fuel lines.
- Drive cautiously. If you hear the chains rub or bang against your vehicle, stop and re-tighten the chains. If this does not work, remove the chains to prevent damage to your vehicle.
- If possible, avoid fully loading your vehicle.

Maintenance and care

- Do not use tire chains on aluminum wheels. Chains may chip the wheels.
- Remove the tire chains when they are no longer needed. Do not use tire chains on dry roads.
- The suspension insulation and bumpers will help prevent vehicle damage. Do not remove these components from your vehicle when using snow tires and chains.

WHAT YOU SHOULD KNOW ABOUT AUTOMOTIVE FUELS

Important safety precautions



Do not overfill the fuel tank. The pressure in an overfilled tank may cause leakage and lead to fuel spray and fire.



If you do not use the proper fuel cap, the pressure in the fuel tank can damage the fuel system or cause it to work improperly in a collision.



The fuel system may be under pressure. If the fuel cap is venting vapor or if you hear a hissing sound, wait until it stops before completely removing the cap.



Automotive fuels can cause serious injury or death if misused or mishandled.

Observe the following guidelines when handling automotive fuel:

- Extinguish all smoking materials and any open flames before fueling your vehicle.
- Always turn off the vehicle before fueling.
- Automotive fuels can be harmful or fatal if swallowed. If fuel is swallowed, call a physician immediately, even if no symptoms are immediately apparent. The toxic effects of fuel may not be visible for hours.

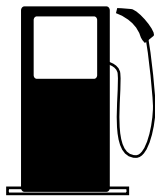

Maintenance and care

- Fuels can also be harmful if absorbed through the skin. If fuel is splashed on the skin, promptly remove contaminated clothing and wash skin thoroughly with soap and water.
- If fuel is splashed in the eyes, remove contact lenses, flush with water for 15 minutes and seek medical attention.
- Be particularly careful if you are taking “Antabuse” or other forms of disulfiram for the treatment of alcoholism. Breathing gasoline vapors or skin contact could cause an adverse reaction. Consult a physician immediately.

Choosing the right fuel

Use only UNLEADED FUEL. The use of leaded fuel is prohibited by law and could damage your vehicle.

Your vehicle was not designed to use fuel or fuel additives with metallic compounds, including manganese-based compounds containing MMT.

Vehicles certified to California emission standards (indicated on the underhood Vehicle Emissions Control Information label) are designed to operate on California reformulated gasolines. If California reformulated gasoline is not available when you refuel, your vehicle can be operated on non-California fuels. However, even though your engine will perform adequately on other gasolines, the performance of the emission control devices and systems may be adversely affected.

Repair of damage caused by using a fuel that your vehicle was not designed for may not be covered by your warranty.

Octane recommendations

Your vehicle is designed to use “Regular” unleaded with an (R+M)/2 octane rating of 87. We do not recommend gasolines labeled as “Regular” in high altitude areas that are sold with octane ratings of 86 or even less.

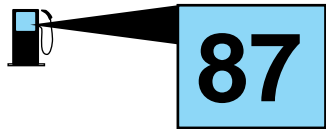

Do not be concerned if your vehicle sometimes knocks lightly. However, if it knocks heavily under most driving conditions on fuel with the recommended octane, see your dealer or a qualified service technician to prevent any engine damage.

Maintenance and care

Fuel quality

If you are experiencing starting, rough idle or hesitation driveability problems during a cold start, try a different brand of “Regular” gasoline. “Premium” gasoline is not recommended (particularly in the United States) because it may cause these problems to become more pronounced. If the problems persist, see your dealer or a qualified service technician.

The American Automobile Manufacturers Association (AAMA) issued a gasoline specification to provide information on high quality fuels that optimize the performance of your vehicle. We recommend the use of gasolines that meet the AAMA specification if they are available.

It should not be necessary to add any aftermarket products to your fuel tank if you continue to use a high-quality fuel.

Cleaner air

Ford approves the use of gasolines to improve air quality, including reformulated gasolines that contain oxygenates up to 10% ethanol or 15% MTBE.

Do not use gasolines containing methanol, which can damage critical fuel system components. Damage resulting from the use of methanol may not be covered by your warranty.

Running out of fuel

Avoid running out of fuel because this situation may have an adverse affect on modern powertrain components.

You may need to crank the engine several times before the system starts to pump fuel from the tank to the engine. If you run out of fuel, your Service Engine Soon light may come on. For more information on the Service Engine Soon light, refer to the *Instrumentation* chapter.

Calculating fuel economy

To accurately calculate your vehicle’s fuel economy:

1. Fill the tank completely and record the initial odometer reading.
2. Each time you fill the tank, record the amount of fuel added (in liters or gallons).
3. After at least three to five fuel tank fill-ups, fill the fuel tank and record the current mileage reading.

Maintenance and care

4. Use one of the following equations to calculate fuel economy.

Liters used $\times 100 \div$ Total kilometers traveled

Total miles traveled \div Total gallons used

Keep a record for at least one month. This will provide an accurate estimate of the vehicle's fuel economy.

EMISSION CONTROL SYSTEM

Your vehicle is equipped with various emission control components and a catalytic converter which will enable your vehicle to comply with applicable exhaust emission standards. To make sure that the catalytic converter and other emission control components continue to work properly:

- Use only unleaded fuel.
- Avoid running out of fuel.
- Do not turn off the ignition while your vehicle is moving, especially at high speeds.
- Have the services listed in your "Service Guide" performed according to the specified schedule.

The Scheduled Maintenance Services listed in the "Service Guide" are required because they are considered essential to the life and performance of your vehicle and to its emissions system.

If other than Ford, Motorcraft or Ford authorized parts are used for maintenance replacements or for service of components affecting emission control such non-Ford parts should be equivalent to genuine Ford Motor Company parts in performance and durability.



Do not park, idle, or drive your vehicle in dry grass or other dry ground cover. The emission system heats up the engine compartment and exhaust system, which can start a fire.

Watch for fluid leaks, strange odors, smoke, loss of oil pressure, the charging system warning light, the "Service Engine Soon" light or the temperature warning light. These events could indicate that the emission control system is not working properly.



If you smell exhaust fumes of any kind inside your vehicle, have the dealer inspect and fix your vehicle immediately. Do not drive if you smell exhaust fumes. These fumes are harmful and could kill you.

Maintenance and care

Do not make any unauthorized changes to your vehicle or engine. By law, vehicle owners and anyone who manufactures, repairs, services, sells, leases, trades vehicles, or supervises a fleet of vehicles are not permitted to intentionally remove an emission control device or prevent it from working. Information about your vehicle's emission system is on the Vehicle Emission Control Information Decal located on or near the engine. This decal identifies engine displacement and gives some tune up specifications.

Please consult your "Warranty Guide" for complete emission warranty information.

Readiness for inspection/maintenance (I/M) testing

In some localities, it may be a legal requirement to pass an I/M test of the on-board diagnostic (OBD-II) system. If your "check engine/service engine soon" light is on, reference the applicable light description in the *Warning Lights and Chimes* section of your owners guide. Your vehicle may not pass the I/M test with the "check engine/service engine soon" light on.

If the vehicle's powertrain system or its battery has just been serviced, the OBD-II system is reset to a "not ready for I/M test" condition. To ready the OBD-II system for I/M testing, a minimum of 30 minutes of city and highway driving is necessary as described below:

- First, at least 10 minutes of driving on an expressway or highway.
- Next, at least 20 minutes driving in stop and go, city type traffic with at least four idle periods.

Allow the vehicle to sit for at least eight hours without starting the engine. Then, start the engine and complete the above driving cycle. The engine must warm up to its normal operating temperature. Once started, do not turn off the engine until the above driving cycle is complete.

EXTERIOR BULBS

Replacing exterior bulbs

Check the operation of the following lamps frequently:

- Headlamps
- Tail lamps
- Brakelamps
- High-mount brakelamp

Maintenance and care

- Turn signals
- Backup lamps
- License plate lamp

Do not remove lamp bulbs unless they will be replaced immediately. If a bulb is removed for an extended period of time, contaminants may enter the lamp housings and affect performance.

Replacing headlamp bulbs (aerodynamic)



Handle a halogen headlamp bulb carefully and keep out of children's reach. Grasp the bulb only by its plastic base and do not touch the glass. The oil from your hand could cause the bulb to break the next time the headlamps are operated.

To remove the headlamp bulb:

1. Make sure headlamp switch is in OFF position.
2. Open the hood.
3. Push each clip tab toward the engine compartment and lift upward to the stop position.
4. Remove the headlamp assembly.

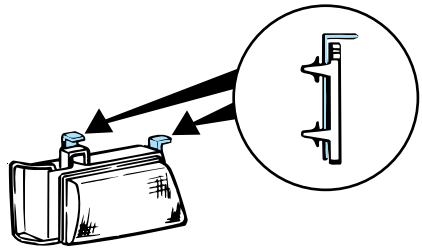

5. Disconnect the electrical connector from the bulb by pulling the connector rearward.

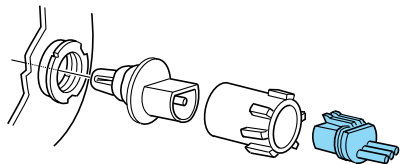

Maintenance and care

6. Remove the bulb retaining ring by rotating it counterclockwise (when viewed from the rear) about an eighth of a turn to free it from the bulb socket, and by sliding the ring off the plastic base. Keep the ring because it will be used again to retain the new bulb.

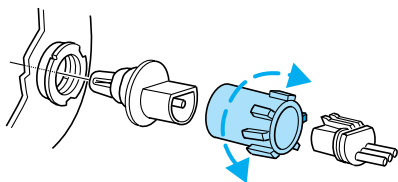

7. Remove the old bulb from its socket by gently pulling it straight back out of the socket. Do not turn the bulb while removing it.

To install the new bulb:

1. With the flat side of the bulb's plastic base facing upward, insert the glass end of the bulb into the socket. You may need to turn the bulb left or right to line up the grooves in the plastic base with the tabs in the socket. When the grooves are aligned, push the bulb into the socket until the plastic base contacts the rear of the socket.

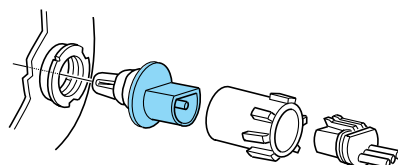

2. Slip the bulb retaining ring over the plastic base until it contacts the rear of the socket by rotating it clockwise until you feel a "stop".

3. Push the electrical connector into the rear of the plastic base until it snaps, locking it into position.

4. Turn the headlamps on and make sure they work properly. If the headlamp was correctly aligned before you changed the bulb, you should not need to align it again.

REPLACING THE INTERIOR BULBS

Check the operation of the following interior bulbs frequently:

- interior overhead lamp
- map lamp

Maintenance and care

USING THE RIGHT BULBS

Function	Number of bulbs	Trade number
Headlamps (low series)	2	H6054
Headlamps (high series)	2	9007
Park lamp and turn signal (front)	2	3157 NAK
Back-up lamps	2	3156 K
License plate lamps	1	186
Stop/tail/side marker lamp	2	3357 K
Turn lamp (rear)	2	3156 K
High-mount brakelamp	2	912
Cargo lamp	1	211-2
Dome lamp (standard)	1	912
Map/reading lamp	2	211-2
To replace all instrument panel lights - see your dealer		

AIMING THE HEADLAMPS

The alignment of your headlamps should be checked by a qualified service technician if:

1. Oncoming motorists frequently signal you to deactivate your high beams, and your high beams are not activated.
2. The headlamps do not seem to provide enough light for clear night vision.
3. The headlamp beams are pointed substantially away from a slightly down and to the right position.

CLEANING AND CARING FOR YOUR VEHICLE

Refer to the "Customer Assistance Guide" for a list of Ford-approved cleaners, polishes and waxes.

Maintenance and care

Washing your vehicle

Wash your vehicle regularly with cold or lukewarm water. Never use strong detergents or soap. If your vehicle is particularly dirty, use a quality car wash detergent. Always use a clean sponge, washing glove or similar device and plenty of water for best results. To avoid spots, avoid washing when the hood is still warm, immediately after or during exposure to strong sunlight.

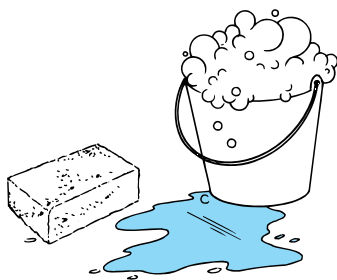

During winter months, it is especially important to wash the vehicle on a regular basis. Large quantities of dirt and road salt are difficult to remove and also cause damage to the vehicle. Remove any exterior accessories, such as antennas, before entering a car wash.

After washing, apply the brakes several times to dry them.

Waxing your vehicle

Wax when water stops beading on the surface. This could be every three or four months, depending on operating conditions.

Use only carnauba or synthetic-based waxes. Remove any bugs and tar before waxing vehicle. Use cleaning fluid or alcohol with a clean cloth to remove. Use tar remover to remove any tar spots.

Repairing paint chips

Minor scratches or paint damage from road debris may be repaired with touch-up paint, repair foil or aerosol paint spray from the Ford accessory line. Observe the application instructions on the products.

Remove particles such as bird droppings, tree sap, insect remains, tar spots, road salt and industrial fallout immediately.

Cleaning the wheels

Wash with the same detergent as the body of your vehicle. Do not use acid-based wheel cleaners, steel wool, fuel or strong detergents. Never use abrasives that will damage the finish of special wheel surfaces. Use a tar remover to remove grease and tar.

Maintenance and care

Cleaning the engine

Engines are more efficient when they are clean because grease and dirt buildup keep the engine warmer than normal. When washing:

- Take care when using a power washer to clean the engine. The high pressure fluid could penetrate the sealed parts and cause damage.
- Do not spray with cold water to avoid cracking the engine block or other engine components.

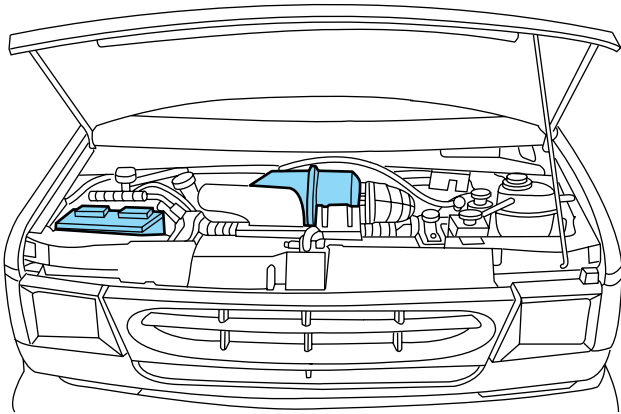

- Cover the highlighted areas to prevent water damage when cleaning the engine.
- Never wash or rinse the engine while it is running; water in the running engine may cause internal damage.

Cleaning plastic exterior parts

Use vinyl cleaner for routine cleaning. Clean with a tar remover if necessary. Do not clean plastic parts with thinners, solvents or petroleum-based cleaners.

Maintenance and care

Cleaning the exterior lamps

Wash with the same detergent as the exterior of your vehicle. Use glass cleaner or tar remover if necessary.

To avoid scratching the lamps, do not use a dry paper towel, chemical solvents or abrasive cleaners.

Cleaning the wiper blades

If the wiper blades do not wipe properly, clean the windshield and wiper blades with undiluted windshield wiper solution or a mild detergent. Rinse thoroughly with clean water. To avoid damaging the blades, do not use fuel, kerosene, paint thinner or other solvents.

Cleaning the instrument panel

Clean with a damp cloth, then dry with a dry cloth.

Avoid cleaner or polish that increases the gloss of the upper portion of the instrument panel. The dull finish in this area helps protect the driver from undesirable windshield reflection.

Cleaning the interior fabric

Remove dust and loose dirt with a whisk broom or a vacuum cleaner. Remove fresh spots immediately. Follow the directions that come with the cleaner.

Cleaning and maintaining the safety belts

Clean the safety belts with a mild soap solution recommended for cleaning upholstery or carpets. Do not bleach or dye the belts, because these actions may weaken the belt webbing.

Check the safety belt system periodically to make sure there are no nicks, wear or cuts. If your vehicle has been involved in an accident, refer to the *Safety belt maintenance* section in the *Seating and safety restraints* chapter.

Underbody

Flush the complete underside of vehicle frequently. Keep body drain holes unplugged. Inspect for road damage.

Inside windows

Use glass cleaner for the inside windows if they become fogged.

Capacities and specifications

MOTORCRAFT PART NUMBERS

Component	4.2L V6 engine	4.6L V8 engine	5.4L V8 engine	6.8L V10 engine
Air filter	FA-1632	FA-1632	FA-1632	FA-1632
Battery (standard)	BXT-65-650	BXT-65-650	BXT-65-650	BXT-65-650
Battery (optional)	BXT-65-750	BXT-65-750	BXT-65-750	BXT-65-750
Battery (auxiliary)	BH-65DC	BH-65DC	BH-65DC	BH-65DC
Fuel filter	FG-872	FG-872	FG-872	FG-872
Oil filter	FL-400-S	FL-820-S	FL-820-S	FL-820-S
PCV Valve	EV-152	EV-233	EV-233	EV-233
Spark plugs*	AGSF-34EE	AWSF-32PP	AWSF-22E	AWSF-22E

* Refer to Vehicle Emissions Control Information (VECI) decal for spark plug gap information.

REFILL CAPACITIES

Fluid	Ford Part Name	Application	Capacity
Brake fluid	High Performance DOT 3 Motor Vehicle Brake Fluid	All	Fill to line on reservoir
Engine oil (includes filter change)	Motorcraft 5W30 Super Premium Motor Oil	All	5.7L (6.0 quarts)
Engine coolant	Ford Extended Life Engine Coolant (DEX-COOL)	4.2L V6 engine	22.0L (23.2 quarts)
		4.6L V8 engine	23.7L (25.0 quarts)
		5.4L V8 engine	27.4L (29.0 quarts)
		6.8L V10 engine	29.0L (30.6 quarts)
Power steering fluid	Motorcraft MERCON® ATF	All	Keep in FULL range on dispstick

Capacities and specifications

Fluid	Ford Part Name	Application	Capacity
Rear axle ¹	Refer to footnote 4	Ford 8.8/9.75 inch conventional and Traction-Lok	2.6-2.7L (5.5-5.8 pints) ¹
		Dana 9.75 inch (M60-IU)	3.0L (6.3 pints) ²
		Dana 10.5 inch (M70-2U)	3.1L (6.6 pints) ²
		Dana 10.5 inch (M70-1HD)	3.5L (7.5 pints) ²
		Dana 11.25 inch (model 80)	3.5L (7.5 pints) ²
Fuel tank	N/A	All regular and extended length vans and wagons with 138 inch wheelbase	132.4L (35.0 gallons)
		138 inch wheelbase (except E-Super Duty)	140.0L (37.0 gallons)
		158 inch wheelbase (except E-Super Duty)	140.0L (37.0 gallons) ⁴
		176 inch wheelbase (except E-Super Duty)	140.0L (37.0 gallons)
		158 inch and 176 inch wheelbase (E-Super Duty)	208.0L (55 .0 gallons)

Capacities and specifications

Fluid	Ford Part Name	Application	Capacity
Transmission ³	Motorcraft MERCON®V ATF	Automatic (4R70W)	13.1L (13.9 quarts)
	Motorcraft MERCON® ATF	Automatic (E4OD)	15.0L (15.9 quarts)
Windshield washer fluid	Ultra-Clear Windshield Washer Concentrate	All	Fill to line on reservoir

If your vehicle's rear axle is filled with a synthetic rear axle lubricant it is considered lubricated for life. These lubricants do not need to be checked or changed unless a leak is suspected, service is required or the axle assembly has been submerged in water. The axle lubricant should be changed any time the rear axle has been submerged in water.

¹ Fill 6 mm to 14 mm (1/4 inch to 9/16 inch) below bottom of fill hole. Add 118 ml (4 oz.) of additive friction modifier C8AZ-19B546-A, Ford specification EST-M2C118-A, for complete refill of 8.8 inch and 9.75 inch Traction-Lok axles.

² Fill Dana rear axles to 6 mm to 19 mm (1/4 inch to 3/4 inch) below bottom of fill hole.

³ Always use dipstick to determine exact fluid requirement.

⁴ Ford conventional and Traction-Lok axles, Dana 80 axle (E-Super Duty) and Dana axles on E-350 vans/wagons with 4.10:1 ratio require Motorcraft SAE 75W140 Synthetic Rear Axle Lubricant (part number F1TZ-19580-B). Add 118 ml (4 oz.) of friction modifier C8AZ-19B546-A, Ford specification EST-M2C118-A. Dana conventional and limited-slip axles require Motorcraft SAE 80W90 Premium Rear Axle Lubricant. Add 177ml (6 oz.) of additive friction modifier C8AZ-19B546-A, Ford specification EST-M2C118-A.

Capacities and specifications

LUBRICANT SPECIFICATIONS

Item	Ford part name	Ford part number	Ford specification
Brake fluid	High Performance DOT 3 Motor Vehicle Brake Fluid	C6AZ-19542-AB	ESA-M6C25-A and DOT 3
Door weatherstrips	Silicone Lubricant	C0AZ-19553-AA and D7AZ-19553-AA	ESR-M13P4-A
Engine coolant	Ford Premium Cooling System Fluid	EFZ-19549-AA	ESE-M97B44-A
Engine oil (gasoline)	Motorcraft 5W-30 Super Premium Motor Oil	XO-5W30-QSP	WSS-M2C153-G with API Certification Mark
Engine oil (diesel)	Consult separate diesel engine owner's guide supplement		
Hinges, latches, Striker plates, fuel filler door hinge, and seat tracks	Multi-Purpose Grease	D0AZ-19584-AA or F5AZ-19G209-AA	ESB-M1C93-B or ESR-M1C159-A
Lock cylinders	Penetrating Lubricant	E8AZ-19501-B	none
Power steering fluid	Motorcraft MERCON® ATF	XT-2-QDX	MERCON®
Automatic transmission (E4OD)	Motorcraft MERCON® ATF	XT-2-QDX	MERCON®
Automatic transmission (4R70W)	Motorcraft MERCON®V ATF	XT-5-QM	MERCON®V
Disc brake caliper rails	Silicone Brake Caliper and Dielectric compound	D7AZ-19A331-A WA-10	ESE-M1C171-A

Capacities and specifications

Item	Ford part name	Ford part number	Ford specification
Parking brake assembly (E-Super Duty)	Motorcraft MERCON® Automatic Transmission Fluid	XT-2-QDX	MERCON®
Ford conventional and Traction-Lok axles ¹	Motorcraft SAE 75W140 High Performance Synthetic rear axle lubricant	F1TZ-19580-B	WSL-M2C192-A
Dana conventional and Traction-Lok axles ²	Motorcraft SAE 80W90 Premium rear axle lubricant	XY-80W90-QL	WSP-M2C197-A
Dana 80 Axle (E-Super Duty)	Motorcraft SAE 75W140 High Performance Synthetic rear axle lubricant	F1TZ-19580-B	WSL-M2C192-A
Dana Axle (E-350 van/wagon w/4.10 ratio)	Motorcraft SAE 75W140 High Performance Synthetic rear axle lubricant	F1TZ-19580-B	WSL-M2C192-A
Windshield washer fluid	Ultra-Clear Windshield Washer Concentrate	C9AZ-19550-AB	ESR-M17P5-A

¹ Add 118 ml (4 oz.) of EST-M2C118-A (friction modifier Part No. C8AZ-19B546-A) for complete refill of Ford Traction-Lok rear axles.

² Add 237 ml (6 oz.) of EST-M2C118-A (friction modifier Part No. C8AZ-19B546-A) for complete refill of Dana Traction-Lok rear axles.

Capacities and specifications

ENGINE DATA

Engine	4.2L V6 engine
Cubic inches	256
Horsepower	200 @ 4800 rpm
Torque	250 lbs.ft. @ 2800 rpm
Required fuel grade	87 octane
Firing order	1-4-2-5-3-6
Spark plug gap	1.3-1.4 mm (0.052-.056 inch)
Ignition system	EDIS
Compression ratio	9.0:1

Engine	4.6L V8 engine
Cubic inches	281
Horsepower	215 @ 4450 rpm
Torque	290 lbs.ft. @ 3250 rpm
Required fuel grade	87 octane
Firing order	1-3-7-2-6-5-4-8
Spark plug gap	1.3-1.4 mm (0.052-.056 inch)
Ignition system	EDIS
Compression ratio	9.0:1

Engine	5.4L V8 engine
Cubic inches	330
Horsepower	235 @ 4450 rpm
Torque	335 lbs.ft. @ 3000 rpm
Required fuel grade	87 octane
Firing order	1-3-7-2-6-5-4-8
Spark plug gap	1.3-1.4 mm (0.052-.056 inch)
Ignition system	EDIS
Compression ratio	9.0:1

Capacities and specifications

Engine	6.8L V10 engine
Cubic inches	415
Horsepower	265 @ 4250 rpm
Torque	405 lbs.ft. @ 2750 rpm
Required fuel grade	87 octane
Firing order	1-6-5-10-2-7-3-8-4-9
Spark plug gap	1.3-1.4 mm (0.052-.056 inch)
Ignition system	EDIS
Compression ratio	9.0:1

VEHICLE DIMENSIONS

Van/wagon models

	E-150	E-250	E-350
(1) Overall height	2 054.8 mm (80.9 in)	2 118.4 mm (83.4)	2 136.1 (84.1 in)
(2) Track front/rear	1 762.8 mm (69.4 in)/ 1 701.8 mm (67.0 in)		
(3) Overall width (excluding mirrors)	2 014.2 mm (79.3 in)		
(4) Wheelbase	3 505 mm (138 in)		
(5) Overall length	Regular van, 5 379.7 mm (211.8 in) Supervan, 5 892.8 mm (232.0 in)		

Capacities and specifications

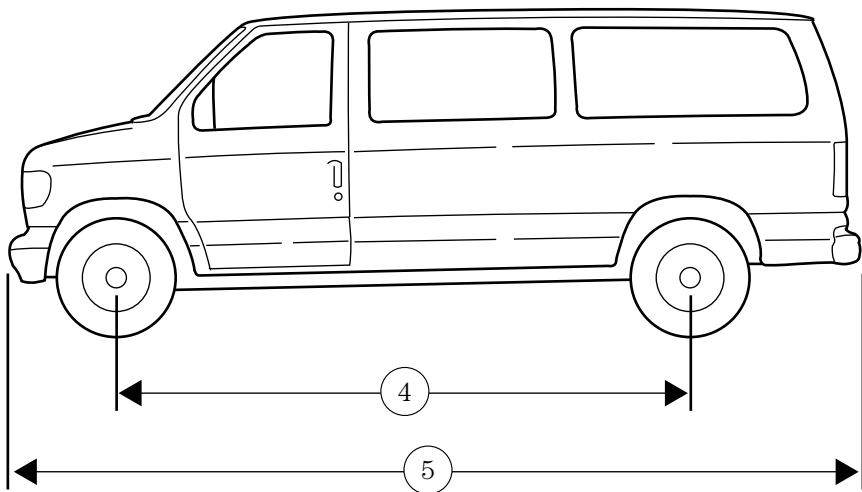
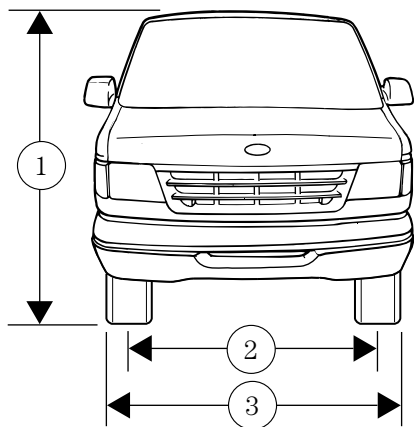

Capacities and specifications

Cutaway/commercial stripped chassis models

	E-250	E-350	E-Super Duty
(1) Overall height	Refer to Body Builder for specifications		
(2) Track front/rear	1 762.8 mm (69.4 in) 1 701.8 mm (67.0 in)	1 762.8 mm (69.4 in.)/SRW 1 701.8 mm (67.0 in.), DRW 1 859.3 mm (73.2 in.)	1 762.8 mm (69.4 in.)/1 973.6 mm (77.7 in.)
(3) Overall width (excluding mirrors)	Refer to Body Builder for specifications.		
(4) Wheelbase	3 149.6 mm (124 in)	3 505 mm (138 in.) 4 013 mm (158 in.) 4 470 mm (176 in.)	4 013 mm (158 in.) 4 470 mm (176 in.)
(5) Overall length	Refer to Body Builder for specifications.		

VEHICLE IDENTIFICATION NUMBER

Complete Ford built vehicles

The vehicle identification number is attached to your vehicle in the following places:

- On the metal tag attached to the top of the instrument panel on the driver's side.

Capacities and specifications

- On the safety compliance certification label. This label is required by the National Highway Traffic Safety Administration and is made of special material. If it is tampered with, it will be destroyed or a destruction pattern will appear.

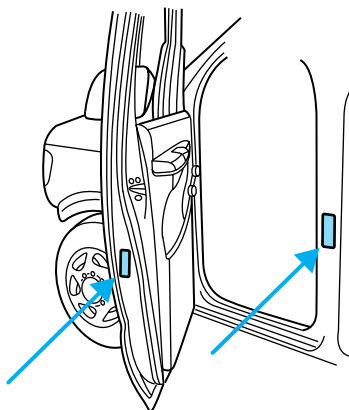

Incomplete vehicles

On completed derivations of incomplete vehicles, the safety compliance certification label is affixed at a location determined by a subsequent stage manufacturer of the completed vehicle. In these cases the completed vehicle is manufactured in two or more stages by two or more separate manufacturers.

Reporting safety defects

REPORTING SAFETY DEFECTS (U.S. ONLY)

If you believe that your vehicle has a defect that could cause a crash, or could cause injury or death, you should immediately inform the National Highway Traffic Safety Administration (NHTSA) in addition to notifying Ford Motor Company.



If NHTSA receives similar complaints, it may open an investigation, and if it finds that a safety defect exists in a group of vehicles, it may order a recall and remedy campaign. However, NHTSA cannot become involved in individual problems between you, your dealer or Ford Motor Company.

To contact NHTSA, you may either call the Auto Safety Hotline toll-free at 1-800-424-9393 (202-366-0123 in the Washington D.C. area) or write to:

NHTSA
U.S. Department of Transportation
400 Seventh Street
Washington D.C. 20590

You can also obtain other information about motor vehicle safety from the Hotline.

Index

Aiming headlamps	125	Controls	20
Air bag supplemental restraint system	46	Emission control system	121
and child safety seats	47	Engine	134
description	46	check engine temperature	
disposal	49	warning, message center	96
indicator light	48	service points	96
passenger air bag	47	Engine block heater	61
Air conditioning		Engine coolant	
manual heating and air		checking and adding	101,102
conditioning system	16,17,18	disposal	103
Anti-lock brake system (ABS)		refill capacities	103
description	64	Engine oil	97,99
Battery	108	changing oil and oil filter	99
voltage gauge	12	checking and adding	97,99
Brake fluid		Exhaust fumes	62
checking and adding	100	Fail safe cooling	103
Brakes	63	Fuel	
anti-lock	63	calculating fuel economy	120
anti-lock brake system (ABS)		improving fuel economy	76
warning light	63	octane rating	119
fluid, checking and adding	100	quality	120
Brake-shift interlock	65	running out of fuel	120
Break-in period	2	safety information relating	
Bulbs, replacing	122	to automotive fuels	118
headlamps	123	Fuel gauge	10
specifications	125	Fuel pump shut-off switch	77
Changing a tire	85	Fuse panels	
Child safety seats	51	instrument panel	79
Chime		power distribution box	82
headlamps on	9	Fuses	79
Cleaning your vehicle	125	Gauges, Mechanical	10
engine compartment	127	engine coolant temperature	
fabric	128	gauge	11
instrument panel	128	Hazard flashers	77
plastic parts	127	Headlamps	13
safety belts	128	daytime running lights	13
tail lamps	128	flashing	14
washing	126	high beam	13
waxing	126	Heating	14
wheels	126	High beams	
windows	128	indicator light	9

- Hood
 - release lever96
- Ignition
 - positions of the ignition21
- Instrument panel
 - lighting up panel and interior .14
- Jump-starting your vehicle ...91,93
 - attaching cables92
 - disconnecting cables93
- Keys
 - key in ignition chime9
- Lamps
 - interior lamps28,124
- Lights, warning and indicator
 - air bag8
 - anti-lock brakes (ABS)6
 - brake6
 - charging system8
 - engine oil pressure9
 - safety belt8
 - service engine soon6,7
 - turn signal indicator8
- Load limits
 - trailer towing69
- Lubricant specifications132
- Mirrors
 - side view mirrors (power)30
- Odometer12
- Overdrive27
- Panic alarm feature, remote
 - entry system31
- Parking brake64
- Parts (see Motorcraft parts) ...129
- Power door locks29
- Power steering
 - fluid, checking and adding ...105
- Refill capacities for fluids129
- Relays79,84
- Remote entry system30
 - illuminated entry33,34
 - locking/unlocking doors30,31
- replacement/additional
 - transmitters32
 - replacing the batteries31
- Reporting safety defects139
- Safety restraints
 - extension assembly44
 - for children49
 - lap and shoulder belts ..40,41,42
 - maintenance45
 - proper use39
 - warning light and chime ..9,44,45
- Safety seats for children
 - attaching with tether straps ...54
 - tether anchorage
 - hardware54,55,57
- Seats
 - adjusting the seat, manual34
 - adjusting the seat, power35
 - bench seat36,37
 - lumbar support36
 - quick release rear captain's
 - chair38,39
- Servicing your vehicle95
 - precautions when servicing95
- Snowplowing3
- Special notice
 - ambulance conversions3
 - diesel-powered vehicles3
- Speed control22
 - canceling a set speed25
 - resuming a set speed25
 - tap up/tap down23,24
 - turning off22
- Speedometer10
- Starting your vehicle59,61
- Tilt steering wheel26
- Tires114,115
 - changing85,86
 - checking the pressure115
 - replacing88,117
 - rotating115
 - snow tires and chains117

Index

- treadwear114
- Traction-lok rear axle107
- Trailer towing70
- tips76
- Transmission106
 - automatic operation ..65,66,67,68
 - fluid, checking and adding
(automatic)106
- Transmission control indicator
light8
- Trip odometer12
- Turn signal
 - lever21
- Vehicle Identification Number
(VIN)137
- Vehicle loading68
- Ventilating your vehicle62
- Warning chimes6
- Windows
 - power windows, operating29
- Windshield washer fluid and
wipers
 - checking and adding fluid101
 - checking and replacing wiper
blades113
 - operation26
- Wrecker towing94

Filling station information

Fuel information	Unleaded only - 87 octane
Fuel tank capacity	Refer to <i>Refill capacities</i> in the <i>Capacities and specifications</i> chapter.
Engine oil specifications	Use only oil displaying the American Petroleum Institute Certification Mark SAE 5W-30
Tire size and pressure	See Safety Compliance Certification Label on inside of driver door
Hood release location	Bottom left of driver side instrument panel
Fuel filler location	Left rear of vehicle

Free Manuals Download Website

<http://myh66.com>

<http://usermanuals.us>

<http://www.somanuals.com>

<http://www.4manuals.cc>

<http://www.manual-lib.com>

<http://www.404manual.com>

<http://www.luxmanual.com>

<http://aubethermostatmanual.com>

Golf course search by state

<http://golfingnear.com>

Email search by domain

<http://emailbydomain.com>

Auto manuals search

<http://auto.somanuals.com>

TV manuals search

<http://tv.somanuals.com>