

Contents

Before driving

Introduction	2
Instrumentation	4
Controls and features	17
Seating and safety restraints	48

Starting and driving

Starting	76
Driving	83
Roadside emergencies	131

Servicing

Maintenance and care	152
Capacities and specifications	205
Reporting safety defects	215
Index	216

All rights reserved. Reproduction by any means, electronic or mechanical including photocopying, recording or by any information storage and retrieval system or translation in whole or part is not permitted without written authorization from Ford Motor Company.

Introduction

ICONS

Indicates a warning. Read the following section on *Warnings* for a full explanation.



Indicates vehicle information related to recycling and other environmental concerns will follow.



Correct vehicle usage and the authorized disposal of waste cleaning and lubrication materials are significant steps towards protecting the environment.

WARNINGS

Warnings provide information which may reduce the risk of personal injury and prevent possible damage to others, your vehicle and its equipment.

BREAKING-IN YOUR VEHICLE

There are no particular breaking-in rules for your vehicle. During the first 1 600 km (1 000 miles) of driving, vary speeds frequently. This is necessary to give the moving parts a chance to break in.

If possible, you should avoid full use of the brakes for the first 1 600 km (1 000 miles).

INFORMATION ABOUT THIS GUIDE

The information found in this guide was in effect at the time of printing. Ford may change the

contents without notice and without incurring obligation.

SPECIAL NOTICES

Using your vehicle with a snowplow

For more information and guidelines for using your vehicle with a snowplow, refer to the *Driving* chapter.

Using your vehicle as an ambulance



Do not use this vehicle as an ambulance.

Your vehicle is not equipped with the Ford Ambulance Preparation package.

Notice to owners of utility type vehicles

Before you drive your vehicle, please read this Owner's Guide carefully. Your vehicle is not a passenger car. As with other vehicles of this type, failure to operate this vehicle correctly may result in loss of control or an accident.

Be sure to read *Driving off road* in the *Driving* chapter as well as the "Four Wheeling" supplement included with 4WD and utility type vehicles.

Instrumentation

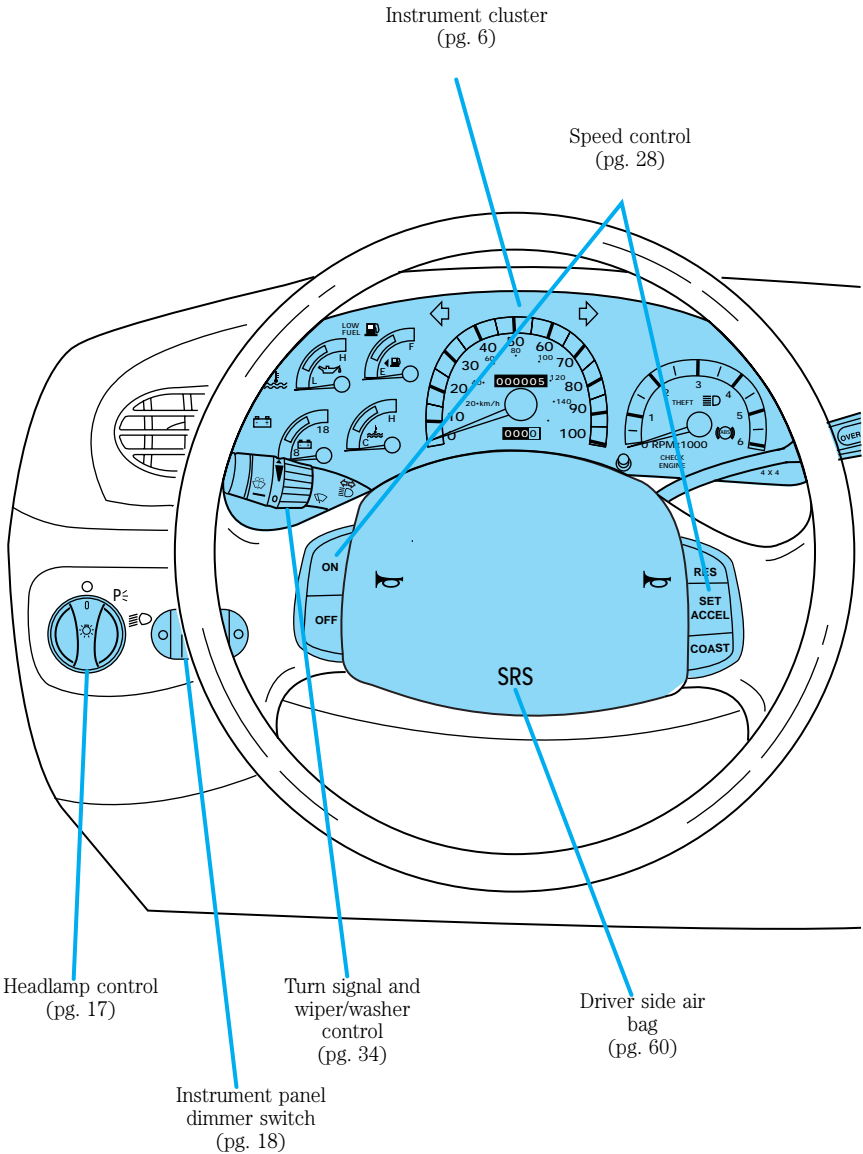

Instrumentation

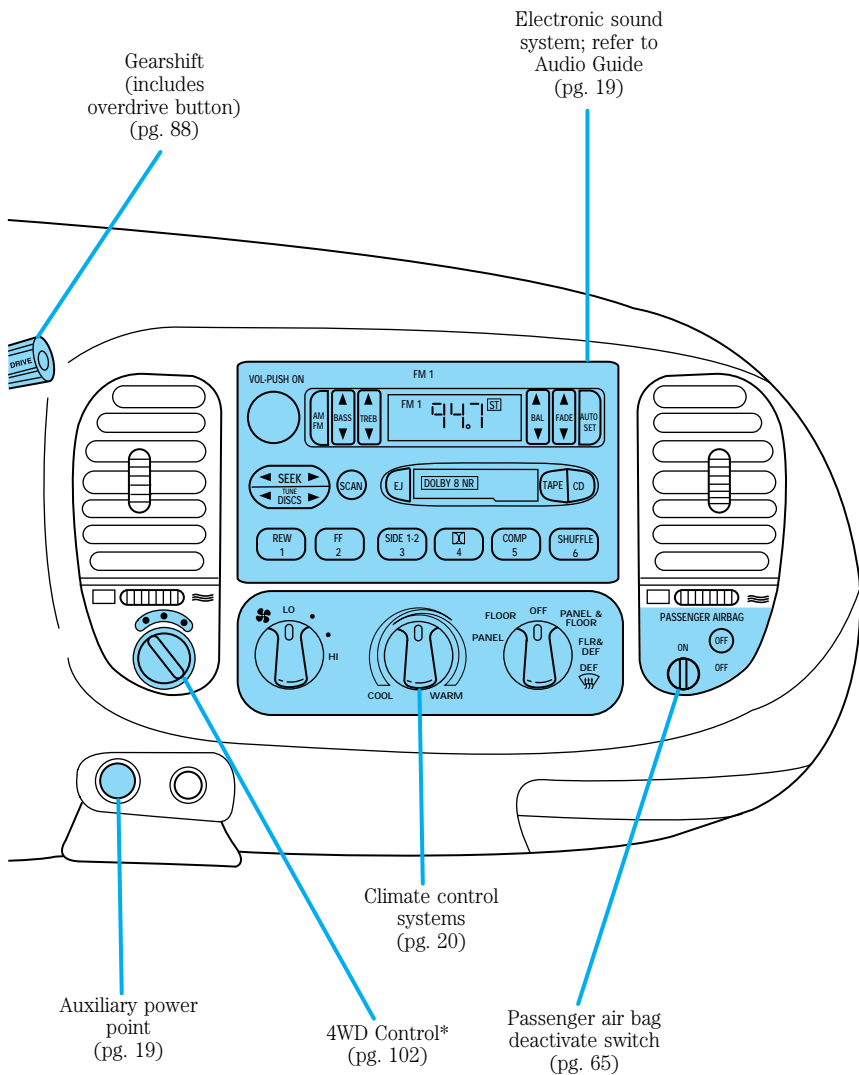

Instrumentation

WARNING LIGHTS AND CHIMES

Standard instrument cluster

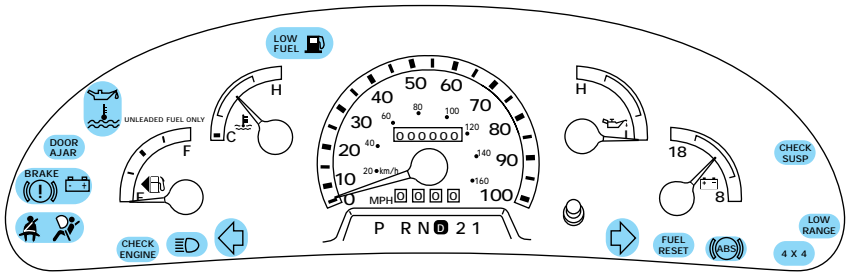

Optional instrument cluster

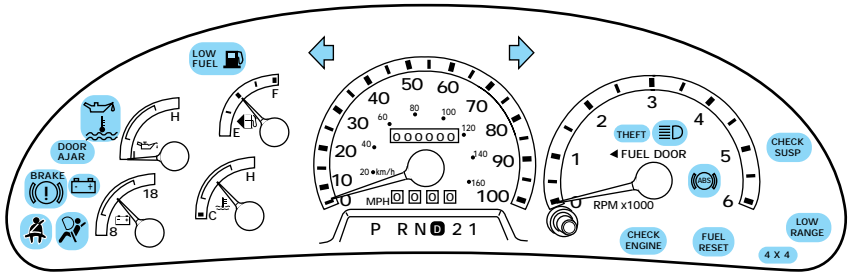

Low fuel

Illuminates when the fuel level is low. The lamp will also illuminate when the ignition key is turned to ON and the engine is off.



Check engine

Your vehicle is equipped with a computer that monitors the engine's emission control system. This system is commonly known as



the On Board Diagnostics System (OBD II). This OBD II system protects the environment by ensuring that your vehicle continues to meet government emission standards. The OBD II system also assists the service technician in properly servicing your vehicle.

The *Check Engine* indicator light illuminates when the ignition is first turned to the ON position to check the bulb. If it comes on after the engine is started, one of the engine's emission control systems may be malfunctioning. The light may illuminate without a driveability concern being noted. The vehicle will usually be drivable and will not require towing.

What you should do if the check engine light illuminates

Light turns on solid:

This means that the OBD II system has detected a malfunction.

Temporary malfunctions may cause your *Check Engine* light to illuminate. Examples are:

1. The vehicle has run out of fuel. (The engine may misfire or run poorly.)
2. Poor fuel quality or water in the fuel.
3. The fuel cap may not have been properly installed and securely tightened.

These temporary malfunctions can be corrected by filling the fuel tank

Instrumentation

with good quality fuel and/or properly installing and securely tightening the gas cap. After three driving cycles without these or any other temporary malfunctions present, the *Check Engine* light should turn off. (A driving cycle consists of a cold engine startup followed by mixed city/highway driving.) No additional vehicle service is required.

If the *Check Engine* light remains on, have your vehicle serviced at the first available opportunity.

Light is blinking:

Engine misfire is occurring which could damage your catalytic converter. You should drive in a moderate fashion (avoid heavy acceleration and deceleration) and have your vehicle serviced at the first available opportunity.



Under engine misfire conditions, excessive exhaust temperatures could damage the catalytic converter, the fuel system, interior floor coverings or other vehicle components, possibly causing a fire.

Air bag readiness

Momentarily illuminates when the ignition is turned ON. If the light fails to illuminate, continues to flash or remains on, have the system serviced immediately.



Safety belt

Momentarily illuminates when the ignition is turned ON to remind you to fasten your safety belts. For more information, refer to the *Seating and safety restraints* chapter.



Brake system warning

Momentarily illuminates when the ignition is turned on and the engine is off. Also illuminates when the parking brake is engaged. Illumination after releasing the parking brake indicates low brake fluid level.



Anti-lock brake system (ABS)

Momentarily illuminates when the ignition is turned on and the engine is off. If the light remains on, continues to flash or fails to illuminate, have the system serviced immediately.



Turn signal

Illuminates when the left or right turn signal or the hazard lights are turned on. If one or both of the indicators stay on continuously or flash faster, check for a burned-out turn signal bulb. Refer to *Exterior bulbs* in the *Maintenance and care* chapter.

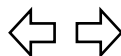

Instrumentation

High beams

Illuminates when the high beam headlamps are turned on.



Anti-theft system (if equipped)

Refer to *Perimeter alarm system* in the *Controls and features* chapter.



Charging system

Momentarily illuminates when the ignition is turned ON and the engine is off. The light also illuminates when the battery is not charging properly, requiring electrical system service.

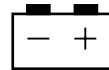

Oil pressure/Engine coolant

This light will come on when the key is in the ON position and the:

- engine coolant temperature is very high
- engine oil pressure is low

The light serves as a notice that a system needs your attention and to check the engine coolant temperature gauge and the engine oil pressure gauge.

Refer to *Engine coolant temperature gauge* and *Engine*

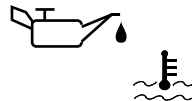

oil pressure gauge in this chapter for more information.

Four wheel drive low (if equipped)

Illuminates when four-wheel drive low is selected.

**LOW
RANGE**

Four wheel drive indicator (if equipped)

Illuminates when 4x4 range is selected.

4x4

Check air suspension (if equipped)

Illuminates briefly when the ignition is turned to the ON position and the engine is OFF. The light also illuminates when the air suspension system requires servicing.

For information, refer to *Air suspension system* in the *Driving* chapter.

**CHECK
SUSP**

Door ajar

Illuminates when the ignition switch is in the ON or START position and any door is open.

**DOOR
AJAR**

Instrumentation

Fuel reset

Illuminates when the ignition key is turned to the ON position and the fuel pump shut-off switch has been triggered. For more information, refer to *Fuel pump shut-off switch* in the *Roadside emergencies* chapter.

**FUEL
RESET**

Safety belt warning chime

Chimes to remind you to fasten your safety belts.

For information on the safety belt warning chime, refer to the *Seating and safety restraints* chapter.

Supplemental restraint system (SRS) warning chime

For information on the SRS warning chime, refer to the *Seating and safety restraints* chapter.

Key-in-ignition warning chime

Sounds when the key is left in the ignition in the OFF/LOCK or ACC position and either front door is opened.

Headlamps on warning chime

Sounds when the headlamps or parking lamps are on, the ignition is off (and the key is not in the ignition) and either front door is opened.

GAUGES

Standard instrument cluster gauges

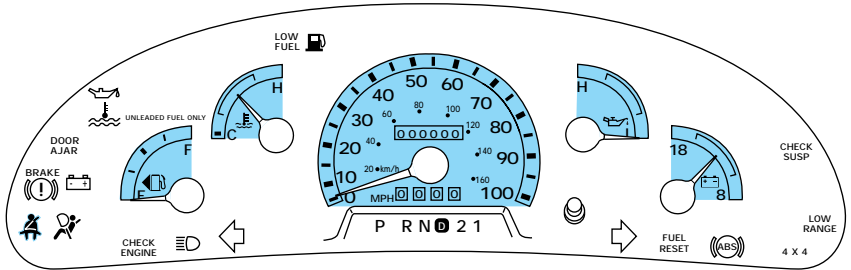

Optional instrument cluster gauges

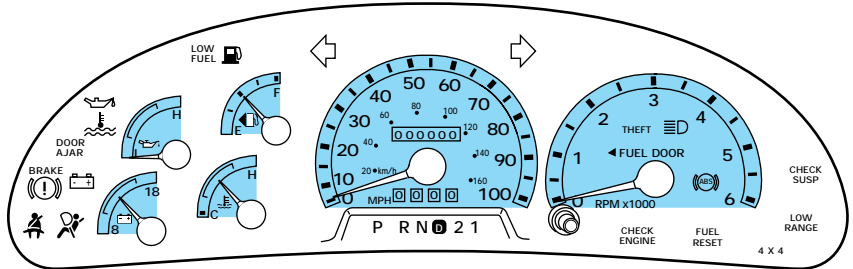

Fuel gauge

Displays approximately how much fuel is in the fuel tank (when the key is in the ON position). The fuel gauge may vary slightly when the vehicle is in motion. The ignition should be in the OFF position while the vehicle is being refueled. When the gauge first indicates empty, there is a small amount of reserve fuel in the tank.

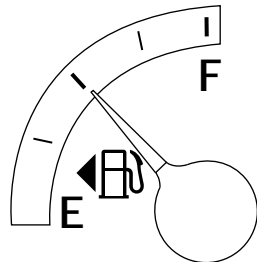

Instrumentation

When refueling the vehicle from empty indication, the amount of fuel that can be added will be less than the advertised capacity due to the reserve fuel.

Speedometer

Indicates the current vehicle speed.

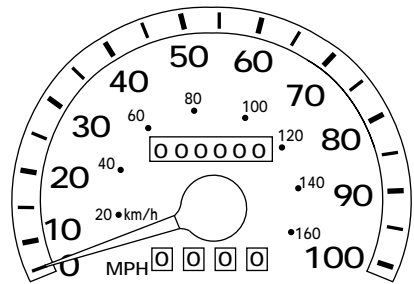

Engine coolant temperature gauge

Indicates the temperature of the engine coolant. At normal operating temperature, the needle remains within the normal area (the area between the “H” and “C”). If it enters the red section, the engine is overheating. Stop the vehicle, switch off the ignition and let the engine cool. Refer to *Engine coolant* in the *Maintenance and care* chapter.

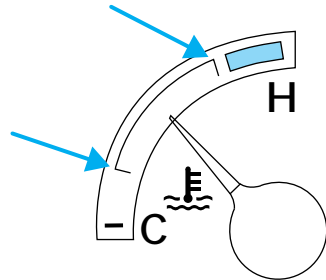

Never remove the coolant recovery cap while the engine is running or hot.

This gauge indicates the temperature of the engine coolant, not the coolant level. If the coolant

is not at its proper level or mixture, the gauge indication will not be accurate.

Odometer

Registers the total kilometers (miles) of the vehicle.

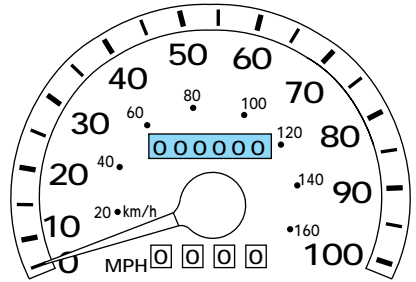

Trip odometer

Registers the kilometers (miles) of individual journeys. To reset, depress the control.

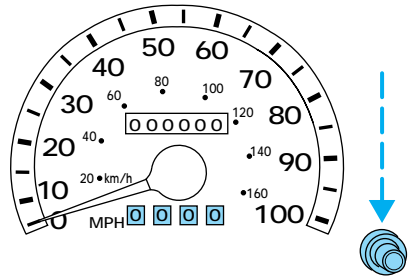

Tachometer

Indicates the engine speed in revolutions per minute.

Driving with your tachometer pointer continuously at the top of the scale may damage the engine.

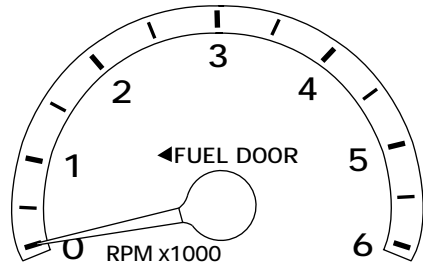

Instrumentation

Battery voltage gauge

This gauge shows the battery voltage when the ignition is in the ON position. If the pointer moves and stays outside the normal operating range (as indicated), have the vehicle's electrical system checked as soon as possible.

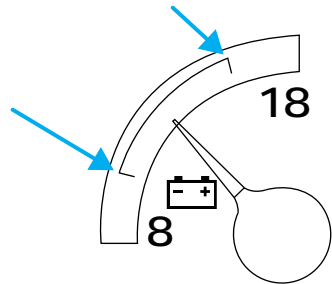

Engine oil pressure gauge

This shows the engine oil pressure in the system. Sufficient pressure exists as long as the needle remains in the normal range (the area between the "H" and "L").

If the gauge indicates low pressure, switch off the engine immediately. Check the oil level. Add oil if needed (refer to *Checking and adding engine oil* in the *Maintenance and care* chapter). If the oil level is correct, have your vehicle checked at your dealership or by a qualified technician.

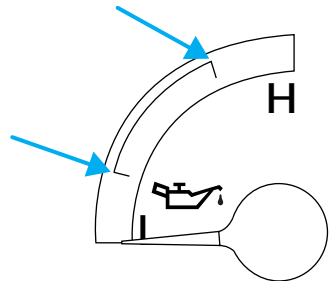

HEADLAMP CONTROL

Rotate the headlamp control to the desired position:

○ — OFF.

P≡ — Parking lamps on.

≡☉ — Headlamps on.

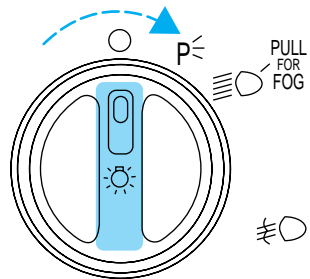

Foglamp control (if equipped)

The headlamp control also operates the foglamps. The foglamps can be turned on only when the headlamps are in the ≡☉ position.

Pull headlamp control towards you to turn foglamps on. The foglamp indicator light ≡☉ (located to the right of the control) will illuminate.

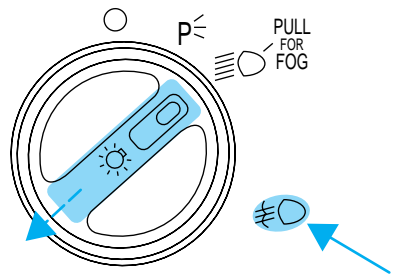

Daytime running light (Canadian vehicles only)

The daytime running light system turns the headlamps on, with a reduced light output, when:

- the vehicle is running
- the parking brake is released
- the headlamp system is in the OFF position

Controls and features



The Daytime Running Light (DRL) system will not illuminate the tail lamps and parking lamps. Turn on your headlamps at dusk. Failure to do so may result in a collision.

PANEL DIMMER CONTROL

Use to adjust the brightness of the instrument panel.

- Rotate up to brighten.
- Rotate down to dim.

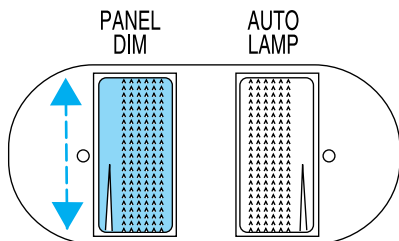

AUTOLAMP CONTROL (IF EQUIPPED)

The autolamp system provides light sensitive automatic on-off control of the exterior lights normally controlled by the headlamp control.

The autolamp system also keeps the lights on for a preselected period of time after the ignition switch is turned to OFF.

- To turn autolamps on, rotate the control up. The preselected time lapse is adjustable up to approximately three minutes by continuing to rotate the control upward.
- To turn autolamps off, rotate the control down until it clicks.

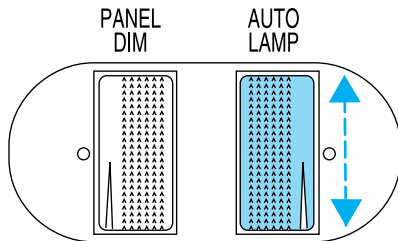

Controls and features

- A small LED illuminates next to the autolamp control to indicate that the headlamps have been turned on by the autolamps.
- Foglamps are not controlled by the autolamps. In order to turn on the foglamps, you must turn the lamp switch to the  position and pull for fog.

4WD CONTROL (IF EQUIPPED)

This control operates the 4WD. Refer to *Four-wheel drive (4WD) operation* in the *Driving* chapter for more information.

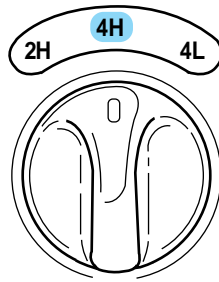

AUXILIARY POWER POINT

The auxiliary power point is located on the instrument panel.

Do not plug optional electrical accessories into the cigarette lighter. Use the powerpoint.

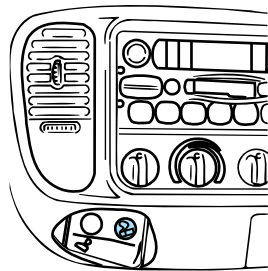

AUDIO SYSTEM

Refer to the “Audio Guide” for instructions on how to operate the audio system.

Controls and features

CLIMATE CONTROL SYSTEM

Heater only system (if equipped)



Fan speed control

Controls the volume of air circulated in the vehicle.



Temperature control knob

Controls the temperature of the airflow inside the vehicle. On heater-only systems, the air cannot be cooled below the outside temperature.



Mode selector control

Controls the direction of the airflow to the inside of the vehicle.

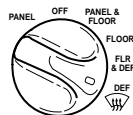

- PANEL-Distributes outside air through the instrument panel registers.
- OFF-Outside air is shut out and the fan will not operate.

Controls and features

- PANEL & FLOOR-Distributes outside air through the instrument panel registers and the floor ducts.
- FLOOR-Allows for maximum heating. Distributes outside air through the floor ducts.
- FLOOR & DEF-Distributes outside air through the floor ducts and the windshield defroster ducts.
- DEF  -Distributes outside air through the windshield defroster ducts. It can be used to clear ice or fog from the windshield.

Operating tips

- In humid weather, select  before driving. This will help to prevent your windshield from fogging. After a few minutes, select any desired position.
- To prevent humidity buildup inside the vehicle, don't drive with the climate control system in the OFF position.
- Don't put objects under the front seat that will interfere with the airflow to the back seats (if equipped).

Controls and features

- Remove any snow, ice or leaves from the air intake area (at the bottom of the windshield under the hood).
- When placing objects on top of your instrument panel, be careful to not place them over the defroster outlets. These objects can block airflow and reduce your ability to see through your windshield. Also, avoid placing small objects on top of your instrument panel. These objects can fall down into the defroster outlets and block airflow and possibly damage your climate control system.

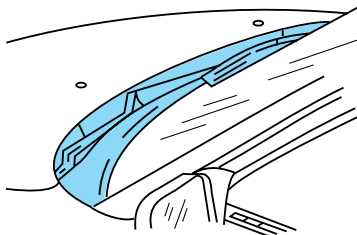

Manual heating and air conditioning system (if equipped)

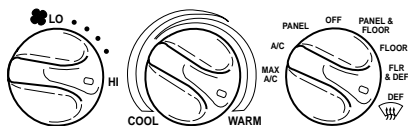

Fan speed control

Controls the volume of air circulated in the vehicle.

Controls and features



Temperature control knob

Controls the temperature of the airflow inside the vehicle.



Mode selector control

Controls the direction of the airflow to the inside of the vehicle.

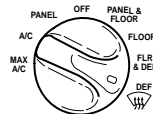

The air conditioning compressor will operate in all modes except PANEL and FLOOR. However, the air conditioning will only function if the outside temperature is about 10°C (50°F) or above.

Since the air conditioner removes considerable moisture from the air during operation, it is normal if clear water drips on the ground under the air conditioner drain while the system is working and even after you have stopped the vehicle.

Under normal conditions, your vehicle's climate control system should be left in any position other than MAX A/C or OFF when the

Controls and features

vehicle is parked. This allows the vehicle to “breathe” through the outside air inlet duct.

- **MAX A/C**-Uses recirculated air to cool the vehicle. MAX A/C is noisier than A/C but more economical and will cool the inside of the vehicle faster. Airflow will be from the instrument panel registers. This mode can also be used to prevent undesirable odors from entering the vehicle.
- **A/C**-Uses outside air to cool the vehicle. It is quieter than MAX A/C but not as economical. Airflow will be from the instrument panel registers.
- **PANEL**-Distributes outside air through the instrument panel registers. However, the air will not be cooled below the outside temperature because the air conditioning does not operate in this mode.
- **OFF**-Outside air is shut out and the fan will not operate. For short periods of time only, use this mode to prevent undesirable odors from entering the vehicle.
- **PANEL & FLOOR**-Distributes outside air through the instrument panel registers and the floor ducts. Heating and air conditioning capabilities are provided in this mode. For added customer comfort, when the temperature control knob is anywhere in between the full

hot and full cold positions, the air distributed through the floor ducts will be slightly warmer than the air sent to the instrument panel registers.

- FLOOR-Allows for maximum heating by distributing outside air through the floor ducts. However, the air will not be cooled below the outside temperature because the air conditioning does not operate in this mode.
- FLR & DEF-Distributes outside air through the windshield defroster ducts and the floor ducts. Heating and air conditioning capabilities are provided in this mode. For added customer comfort, the air distributed through the floor ducts will be slightly warmer than the air sent to the windshield defroster ducts. If the temperature is about 10°C (50°F) or higher, the air conditioner will automatically dehumidify the air to prevent fogging.
- DEF  -Distributes outside air through the windshield defroster ducts. It can be used to clear ice or fog from the windshield. If the temperature is about 10°C (50°F) or higher, the air conditioner will automatically dehumidify the air to prevent fogging.

Controls and features

Operating tips

- In humid weather, select DEF  before driving. This will prevent your windshield from fogging. After a few minutes, select any desired position.
- To prevent humidity buildup inside the vehicle, don't drive with the climate control system in the OFF position.
- Don't put objects under the front seat that will interfere with the airflow to the back seats (if equipped).
- Remove any snow, ice or leaves from the air intake area (at the bottom of the windshield under the hood).
- If your vehicle has been parked with the windows closed during hot weather, the air conditioner will do a much faster job of cooling if you drive for two or three minutes with the windows open. This will force most of the hot, stale air out of the vehicle. Then operate your air conditioner as you would normally.
- When placing objects on top of your instrument panel, be careful to not place them over the defroster outlets. These objects can block airflow and

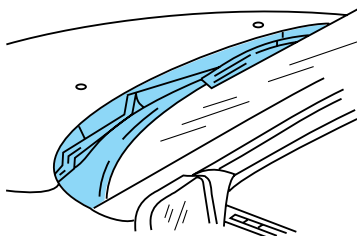

Controls and features

reduce your ability to see through your windshield. Also, avoid placing small objects on top of your instrument panel. These objects can fall down into the defroster outlets and block airflow and possibly damage your climate control system.

POSITIONS OF THE IGNITION

1. **ACCESSORY**, allows the electrical accessories such as the radio to operate while the engine is not running.
2. **LOCK**, locks the steering wheel, automatic transmission gearshift lever and allows key removal.
3. **OFF**, shuts off the engine and all accessories without locking the steering wheel.
4. **ON**, all electrical circuits operational. Warning lights illuminated. Key position when driving.
5. **START**, cranks the engine. Release the key as soon as the engine starts.

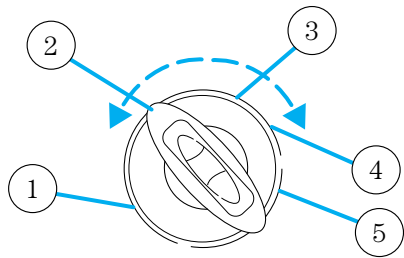

TURN SIGNAL CONTROL

- Push down to activate the left turn signal.
- Push up to activate the right turn signal.

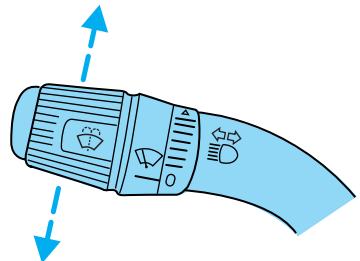

Controls and features

SPEED CONTROL (IF EQUIPPED)

To turn speed control on

- Press ON.

Vehicle speed cannot be controlled until the vehicle is traveling at or above 48 km/h (30 mph).

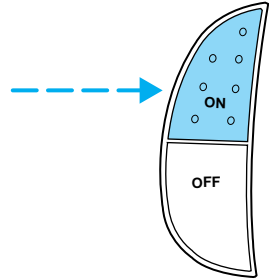

Do not use the speed control in heavy traffic or on roads that are winding, slippery, or unpaved.



Do not shift the gearshift lever into N (Neutral) with the speed control on.

To turn speed control off

- Press OFF or
- Turn off the vehicle ignition.

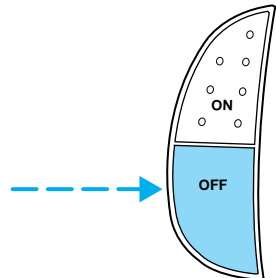

Once speed control is switched off, the previously programmed set speed will be erased.

To set a speed

- Press SET ACC/SET ACCEL.
For speed control to operate, the speed control must be ON and the vehicle speed must be greater than 48 km/h (30 mph).

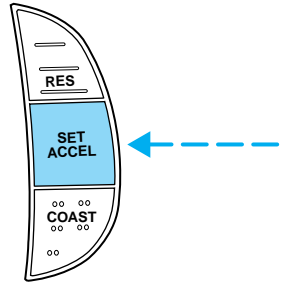

If you drive up or down a steep hill, your vehicle speed may vary momentarily slower or faster than the set speed. This is normal.

Speed control cannot reduce the vehicle speed if it increases above the set speed on a downhill. If your vehicle speed is faster than the set speed while driving on a downhill, you may want to shift to the next lower gear or apply the brakes to reduce your vehicle speed.

If your vehicle slows down more than 16 km/h (10 mph) below your set speed on an uphill, your speed control will disengage. This is normal. Pressing RES/RSM/RESUME will re-engage it.



Do not use the speed control in heavy traffic or on roads that are winding, slippery, or unpaved.

Controls and features

To set a higher set speed

- Press and hold SET ACC/SET ACCEL. Release the control when the desired vehicle speed is reached or
- Press and release SET ACC/SET ACCEL. Each press will increase the set speed by 1.6 km/h (1 mph) or
- Accelerate with your accelerator pedal, then press and release SET ACC/SET ACCEL.

You can accelerate with the accelerator pedal at any time during speed control usage. Releasing the accelerator pedal will return your vehicle to the previously programmed set speed.

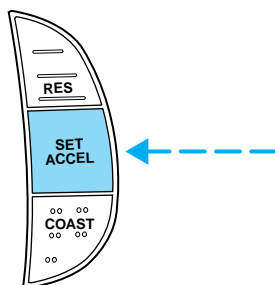

To set a lower set speed

- Press and hold CST/COAST. Release the control when the desired speed is reached or
- Press and release CST/COAST. Each press will decrease the set speed by 1.6 km/h (1 mph) or

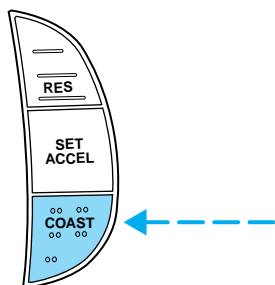

Controls and features

- Depress the brake pedal. When the desired vehicle speed is reached, press SET ACC/SET ACCEL.

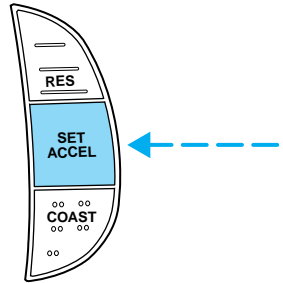

To disengage speed control

- Depress the brake pedal or

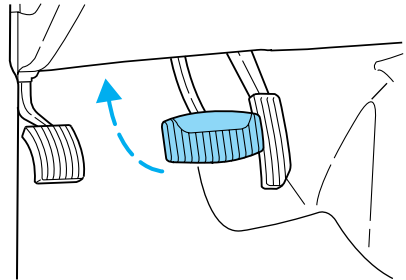

- Depress the clutch pedal (if equipped)

Disengaging the speed control will not erase the previously programmed set speed.

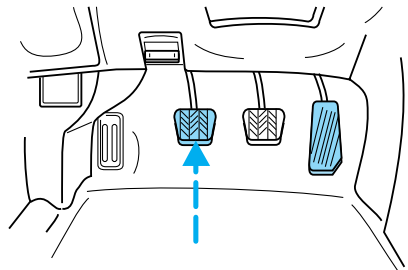

Controls and features

Pressing OFF will erase the previously programmed set speed.

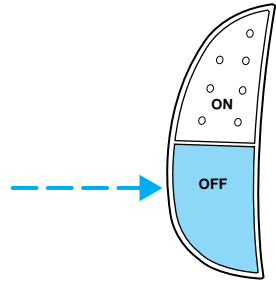

To return to a previously set speed

- Press RES/RSM/RESUME. For RES/RSM/RESUME to operate, the vehicle speed must be faster than 48 km/h (30 mph).

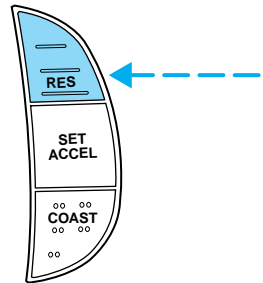

Controls and features

Pull the steering control toward you to move the steering wheel up or down. Hold the control while adjusting the wheel to the desired position, then release the control to lock the steering wheel in position.

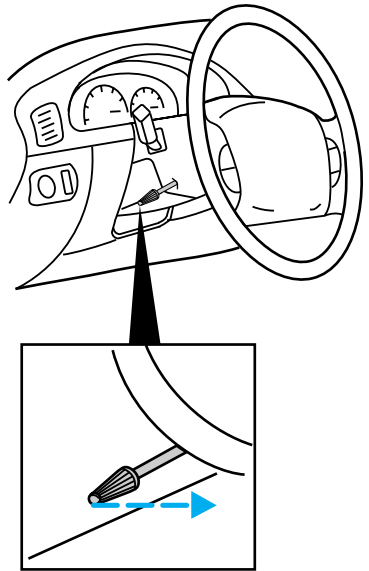

Never adjust the steering wheel when the vehicle is moving.

HAZARD FLASHER

For information on the hazard flasher control, refer to *Hazard lights control* in the *Roadside emergencies* chapter.

Controls and features

WINDSHIELD WIPER/WASHER CONTROLS

Rotate the windshield wiper control to the desired interval, low or high speed position.

The bars of varying length are for intermittent wipers. When in this position rotate the control upward for fast intervals and downward for slow intervals.

Push the control on the end of the stalk to activate washer. Push and hold for a longer wash cycle.

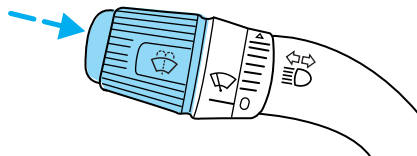
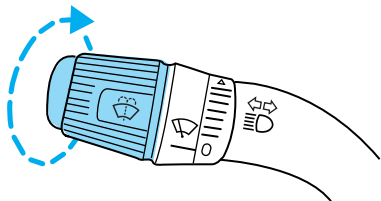

Speed dependent wipers (if equipped)

When the windshield wiper control is set on the intermittent settings, speed-sensitive front wipers automatically adjust as the vehicle's speed increases.

To activate or deactivate this feature do the following:

1. Both front doors must be securely closed.
2. Turn the ignition key to the ON position and then back to the OFF position.
3. Remove the key from the ignition and, within 30 seconds, press and hold the washer control at the end of the stem.

Controls and features

4. Within two seconds of pressing the washer control, put the key in the ignition.
5. Continue to press the washer control until a tone is heard, and release the washer control while the tone is sounding.

A confirmation sequence of tones will sound. One beep indicates that the feature is inactive, two beeps indicate that the feature is active.

HIGH BEAMS

Push forward to activate.

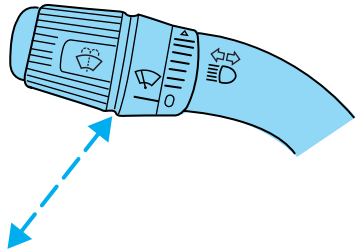

FLASH TO PASS

Pull back to activate and release to deactivate.

OVERDRIVE CONTROL

Activating overdrive

D (Overdrive) is the normal drive position for the best fuel economy.

Controls and features

The overdrive function allows automatic upshifts to second, third and fourth gear.

Deactivating overdrive

Press the transmission control at the end of the gearshift lever. The transmission control indicator light TCIL (OFF) will illuminate on the end of the gearshift lever

The transmission will operate in gears one through three. To return to normal overdrive mode, press the transmission control again. The TCIL (OFF) will no longer be illuminated.

When you shut off and re-start your vehicle, the transmission will automatically return to normal **D** (Overdrive) mode.

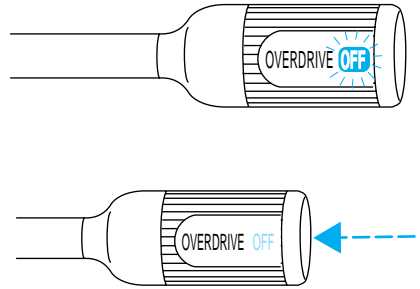

INTERIOR LAMPS

Map lamps (if equipped)

The map lamps and controls are located on the dome lamp. Press the controls on either side of each map lamp to activate the lamps.

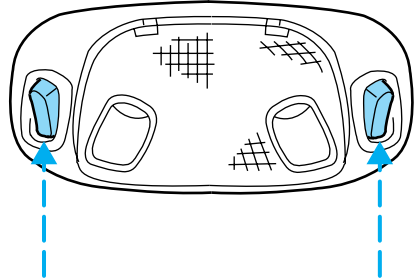

POWER WINDOWS (IF EQUIPPED)

Press and hold the rocker switches to open and close windows.

- Press the top portion of the rocker switch to close.

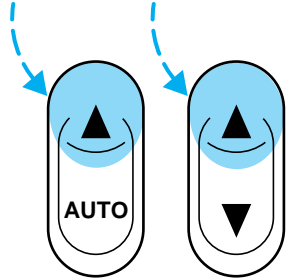

- Press the bottom portion of the rocker switch to open.

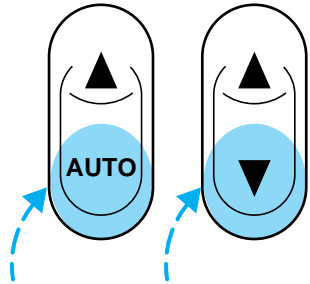

One touch down

- Press AUTO and release quickly. The window will open fully. Depress again to stop window operation.

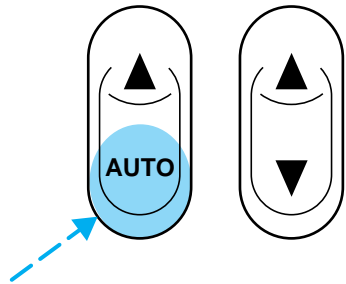

Controls and features

Accessory delay

With accessory delay, the window switches may be used for up to ten minutes after the ignition switch is turned to the OFF position or until either door is opened.

POWER DOOR LOCKS (IF EQUIPPED)

Press U to unlock all doors and L to lock all doors.

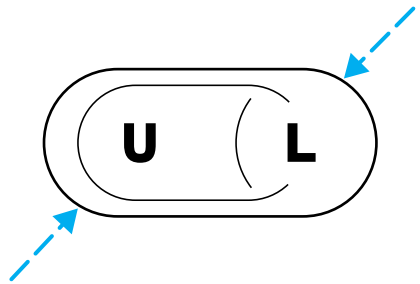

POWER SIDE VIEW MIRRORS (IF EQUIPPED)

To adjust your mirrors:

1. Select L to adjust the left mirror or R to adjust the right mirror.

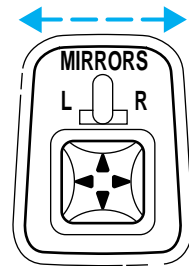

Controls and features

2. Move the control in the direction you wish to tilt the mirror.

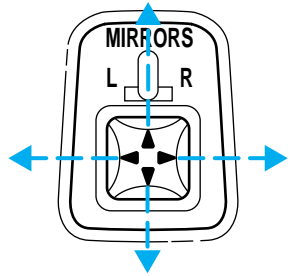

3. Return to the center position to lock mirrors in place.

TAILGATE LOCK (IF EQUIPPED)

Your vehicle is equipped with a tailgate lock designed to prevent theft of the tailgate.

- Insert ignition key and turn to the right to engage lock.
- Turn ignition key to the left to unlock.

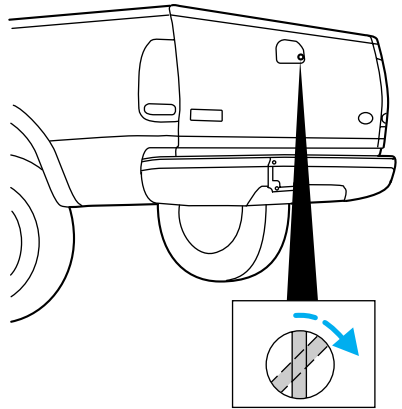

Controls and features

TAILGATE REMOVAL

Your tailgate is removable to allow more room for loading.

1. Lower the tailgate.
2. Use a screwdriver to pry the spring clip (on each connector) past the head of the support screw. Disconnect cable.
3. Disconnect the other cable.
4. Lift tailgate to a 45 degree angle.
5. Lift right side off of its hinge.
6. Lift left side off of its hinge.

To install, follow the removal procedures in reverse order.

PERIMETER ALARM SYSTEM (IF EQUIPPED)

Arming the system

When armed, this system will help protect your vehicle from unauthorized entry. When unauthorized entry occurs, the system will flash the parking lamps and the theft indicator lamp, and chirp the horn.

The system is ready to arm whenever the ignition is turned OFF. Any of the following actions will prearm the alarm system:

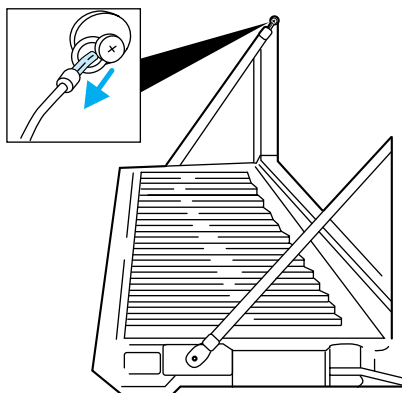

Controls and features

- Press the remote entry lock control
- Open a door and press the power door lock control to lock the doors

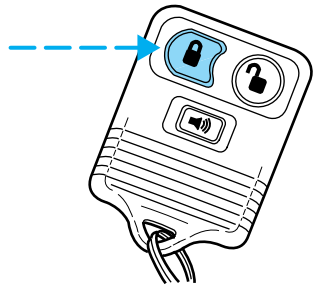

If a door is open, the system is prearmed and is waiting for the door to close. The theft indicator in the instrument panel will be lit continuously when the system is prearmed.

Once the doors are closed, the system will arm in 30 seconds.

When you press the lock control twice within 5 seconds, the horn will chirp once to let you know that the system is armed.

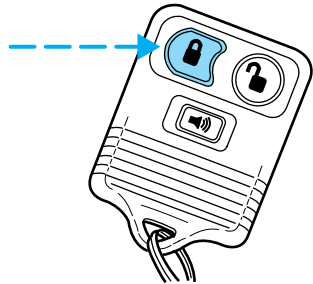

If the doors are not closed and you press the remote entry transmitter twice to confirm the doors are locked, the horn will chirp twice to warn you that the system is not arming.

Disarming the system

You can disarm the system by any of the following actions:

Controls and features

- Unlock the doors by using your remote entry transmitter.
- Unlock the doors with a key. Turn the key full travel (toward the front of the vehicle) to make sure the alarm disarms.
- Turn ignition to ACC or ON.

- Press the panic control on the remote entry transmitter. This will disarm the system only if the alarm is sounding.

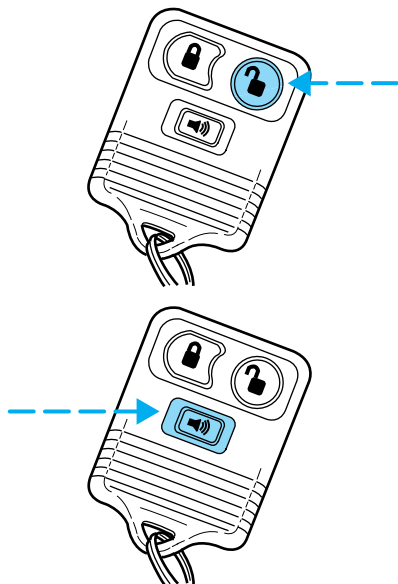

REMOTE ENTRY SYSTEM (IF EQUIPPED)

The remote entry system allows you to lock or unlock all vehicle doors without a key.

The remote entry features only operate with the ignition in the OFF position.

Controls and features

Unlocking the doors

Press this control to unlock the driver door. The interior lamps will illuminate.

Press the control a second time within five seconds to unlock all doors.

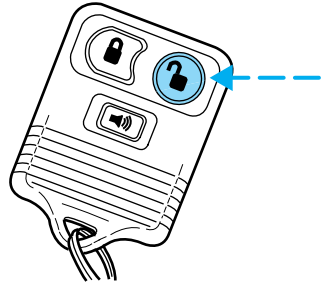

Locking the doors

Press this control to lock all doors.

To confirm all doors are closed and locked, press the control a second time within five seconds. The doors will lock again, the horn will chirp and the lamps will flash.

If any of the doors are ajar, the horn will make two quick chirps, reminding you to properly close all doors.

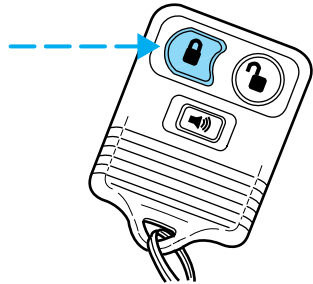

Sounding a panic alarm

Press this control to activate the alarm.

To deactivate the alarm, press the control again or turn the ignition to ACC or ON.

This device complies with part 15 of the FCC rules and with RS-210 of Industry Canada. Operation is subject to the following two conditions: (1) This device may not cause harmful interference,

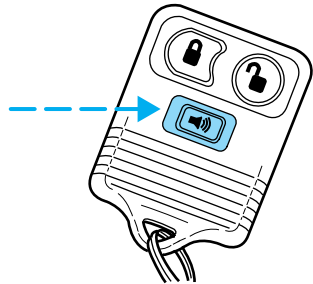

Controls and features

and (2) This device must accept any interference received, including interference that may cause undesired operation.

Changes or modifications not expressly approved by the party responsible for compliance could void the user's authority to operate the equipment.

Autolock

This feature automatically locks all doors when:

- all vehicle doors are closed
- the ignition switch is in the ON position
- you shift into or through R (Reverse)
- the brake pedal is released.

Relock

The autolock feature repeats when:

- any door is opened and closed
- the brake pedal is released.

Deactivating/activating the autolock feature

Before following the procedure, make sure that the ignition is OFF and all vehicle doors are closed.

You must complete steps 1-5 within 30 seconds or the procedure will have to be repeated. If the procedure needs to be repeated, you must wait 30 seconds.

1. Turn the ignition key to ON.

2. Press the power door unlock control three times.
3. Turn the ignition key from ON to OFF.
4. Press the power door unlock control three times.
5. Turn the ignition back to ON. The horn will chirp.
6. Press the unlock control, then press the lock control. The horn will chirp once if autolock was deactivated or twice (one short and one long chirp) if autolock was activated.
7. Turn the ignition to OFF. The horn will chirp once to confirm the procedure is complete.

Replacing the battery

The transmitter is powered by one coin type three-volt lithium battery CR2032 or equivalent. Typical operating range will allow you to be up to 10 meters (33 feet) away from your vehicle. A decrease in operating range can be caused by:

- battery weakness due to time and use
- weather conditions
- nearby radio towers
- structures around the vehicle
- other vehicles parked next to the vehicle

To replace the battery:

1. Twist a thin coin between the two halves of the transmitter near

Controls and features

the key ring. DO NOT TAKE THE FRONT PART OF THE TRANSMITTER APART.

2. Place the positive (+) side of new battery in the same orientation. Refer to the diagram inside the transmitter unit.
3. Snap the two halves back together.

Replacing lost transmitters

Take all your vehicle's transmitters to your dealer for reprogramming if:

- a transmitter is lost or
- you want to purchase additional transmitters (up to four may be programmed).

To reprogram the transmitters, place the key in the ignition and switch from OFF to ON five times in rapid succession (within 10 seconds). After doors lock/unlock, press any button on all transmitters (up to four). When completed, switch the ignition to OFF.

All transmitters must be programmed at the same time.

Reprogramming transmitters

To reprogram all transmitters, place the key in the ignition and switch from OFF to ON eight times in a row (within 10 seconds). After doors lock/unlock, press any button on all transmitters (up to

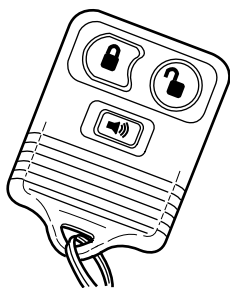

four). When completed, switch the ignition to OFF.

All transmitters must be reprogrammed at the same time.

Illuminated entry

The interior lamps illuminate when the remote entry system is used to unlock the door(s) or sound the personal alarm.

The system automatically turns off after 25 seconds or when the ignition is turned to the START or ACC position. The dome lamp switch (if equipped) must **not** be set to the OFF position for the illuminated entry system to operate.

The inside lights will not turn off if:

- they have been turned on with the dimmer control or
- any door is open.

Battery saver will shut off the interior lamps 40 minutes after the last door is closed.

Seating and safety restraints

SEATING

Full bench seat (if equipped)

- Lift the release bar to move the seat forward or backward. Ensure that the seat is relatched into place.
- Push down the release lever to quickly fold the seatback forward.

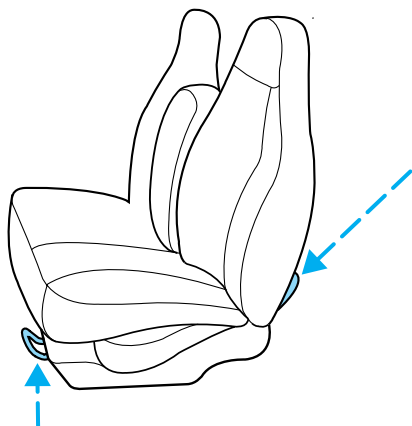

60/40 split bench seat (if equipped)

- Lift the release bar to move the seat forward or backward. Ensure the seat is relatched into place.
- Pull the seatback handle up to recline the seat.
- Push down the release lever located on the back of the seat to quickly fold the seatback forward.

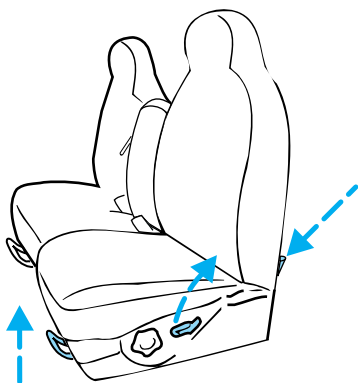

Seating and safety restraints

Captain's chair (if equipped)

- Lift the release bar to move the seat forward or rearward. Make sure that the seat is relatched into place.
- Pull the seatback handle up to recline the seat.
- Push the release lever down to quickly fold the seatback forward.

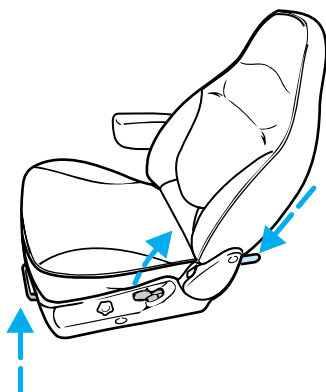

Adjusting the front power seat (if equipped)



Never adjust the driver's seat or seatback when the vehicle is moving.



Do not pile cargo higher than the seatbacks to avoid injuring people in a collision or sudden stop.



Always drive and ride with your seatback upright and the lap belt snug and low across the hips.

Seating and safety restraints

Press to raise or lower the front portion of the seat cushion.

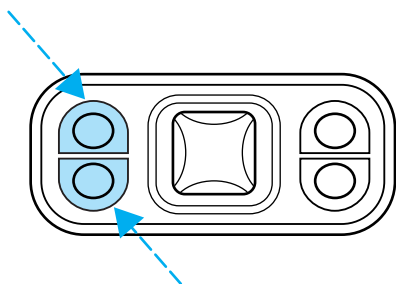

Press to raise or lower the rear portion of the seat cushion.

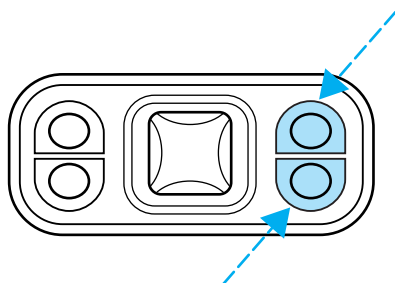

Press the control to move the seat forward, backward, up or down.

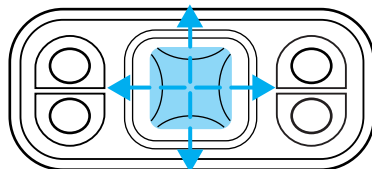

Using the manual lumbar support

Turn the lumbar support control counterclockwise to increase firmness.

Turn the lumbar support control clockwise to increase softness.

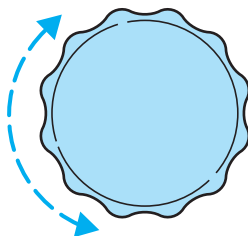

Seating and safety restraints

60/40 Split Rear Seat (if equipped)

When folded down, the rear seats provide a “load floor” for additional storage space. To fold down the rear seats:

- Pull the straps to lower the seat cushions.
- Store the center safety belt in the opening on the seat back.

When returning the seats to their normal position:

- Clear the load floor before folding the seat up.
- Make sure the seat cushion is latched into place.
- Remove the center safety belt from its stowed position.

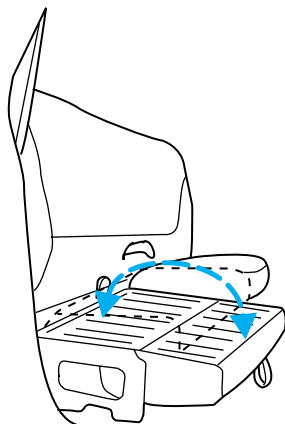

Check to assure that 60/40 Split rear seat cushion is latched by pulling up and forward on lap belt buckles.

SAFETY RESTRAINTS

Safety restraints precautions



Always drive and ride with your seatback upright and the lap belt snug and low across the hips.

Seating and safety restraints



To prevent the risk of injury, make sure children sit where they can be properly restrained.



Never let a passenger hold a child on his or her lap while the vehicle is moving. The passenger cannot protect the child from injury in a collision.



All occupants of the vehicle, including the driver, should always wear their safety belts.



It is extremely dangerous to ride in a cargo area, inside or outside of a vehicle. In a collision, people riding in these areas are more likely to be seriously injured or killed. Do not allow people to ride in any area of your vehicle that is not equipped with seats and safety belts. Be sure everyone in your vehicle is in a seat and using a safety belt properly.

Seating and safety restraints

 Each seating position in your vehicle has a specific safety belt assembly which is made up of one buckle and one tongue that are designed to be used as a pair. 1) Use the shoulder belt on the outside shoulder only. Never wear the shoulder belt under the arm. 2) Never swing it around your neck over the inside shoulder. 3) Never use a single belt for more than one person.

Combination lap and shoulder belts

1. To fasten, insert the tongue into the slot in the buckle.

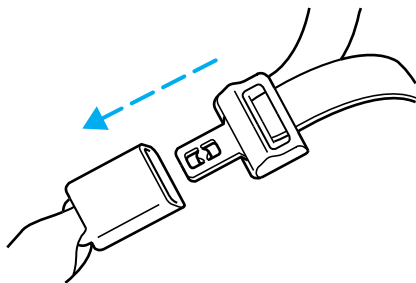

2. To unfasten, push the red release button and remove the tongue from the buckle.

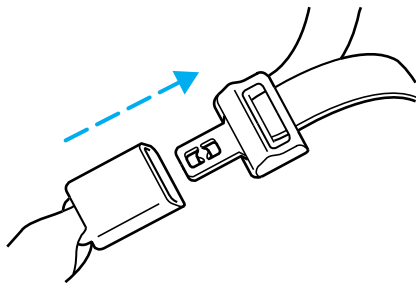

The front and rear outboard safety restraints in the vehicle are

Seating and safety restraints

combination lap and shoulder belts. The front and rear seat passenger outboard safety belts have two types of locking modes described below:

Vehicle sensitive mode

The vehicle sensitive mode is the normal retractor mode, allowing free shoulder belt length adjustment to your movements and locking in response to vehicle movement. For example, if the driver brakes suddenly or turns a corner sharply, or the vehicle receives an impact of 8 km/h (5 mph) or more, the combination safety belts will lock to help reduce forward movement of the driver and passengers.

The front seat belt system can also be made to lock manually by quickly pulling on the shoulder belt. Rear seat belts (if equipped) cannot be made to lock up by pulling quickly on the belt.

Automatic locking mode

In this mode, the shoulder belt is automatically pre-locked. The belt will still retract to remove any slack in the shoulder belt.

The automatic locking mode is not available on the driver safety belt.

When to use the automatic locking mode

- When a tight lap/shoulder fit is desired.

Seating and safety restraints

- **Anytime** a child safety seat is installed in the vehicle. Refer to *Safety Restraints for Children* or *Safety Seats for Children* later in this chapter.

How to use the automatic locking mode

- Buckle the combination lap and shoulder belt.

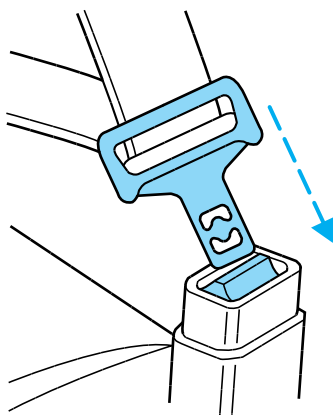

- Grasp the shoulder portion and pull downward until the entire belt is extracted.



- Allow the belt to retract. As the belt retracts, you will hear a clicking sound. This indicates the safety belt is now in the automatic locking mode.

Seating and safety restraints

How to disengage the automatic locking mode

Disconnect the combination lap/shoulder belt and allow it to retract completely to disengage the automatic locking mode and activate the vehicle sensitive (emergency) locking mode.

Front safety belt height adjustment

Your vehicle has safety belt height adjustments for the driver and front passenger. Adjust the height of the shoulder belt so the belt rests across the middle of your shoulder.

To lower the shoulder belt height, push the button and slide the height control down. To raise the height of the shoulder belt, slide the height adjuster up. Pull down on the height adjustment assembly to make sure it is locked in place.

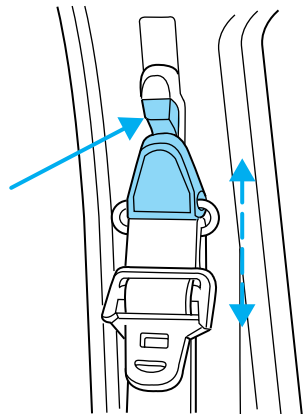

Position the shoulder belt height adjuster so that the belt rests across the middle of your shoulder. Failure to adjust the safety belt properly could reduce the effectiveness of the safety belt and increase the risk of injury in a collision.

Lap belts

Adjusting the lap belt

The lap belt does not adjust automatically. Adjust to fit snugly

Seating and safety restraints

and as low as possible around your hips. Do not wear the lap belt around your waist.

Insert the tongue into the correct buckle. To lengthen the belt, turn the tongue at a right angle to the belt and pull across your lap until it reaches the buckle. To tighten the belt, pull the loose end of the belt through the tongue until it fits snugly across the hips.

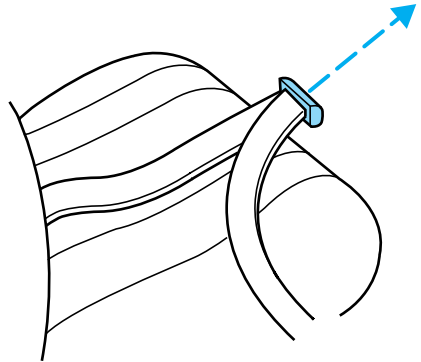

Shorten and fasten the belt when not in use.

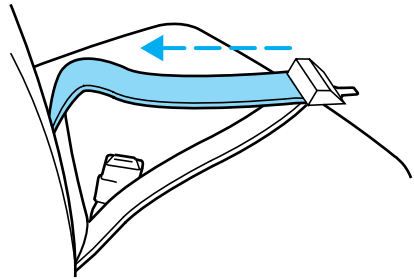

Safety belt extension assembly

If the safety belt assembly is too short, even when fully extended, 20 cm (8 inches) can be added to the safety belt assembly by adding a safety belt extension assembly (part number 611C22). Safety belt extension assemblies can be obtained from your dealer at no cost.

Use only extensions manufactured by the same supplier as the safety

Seating and safety restraints

belt. Manufacturer identification is located at the end of the webbing on the label. Also, use the safety belt extension only if the safety belt is too short for you when fully extended. Do not use extensions to change the fit of the shoulder belt across the torso.

Safety belt warning light and indicator chime

The seat belt warning light illuminates in the instrument cluster and a chime sounds to remind the occupants to fasten their safety belts.

Conditions of operation

If...	Then...
The driver's safety belt is not buckled before the ignition key is turned to ON...	The safety belt warning light illuminates for one to two minutes and the warning chime sounds for four to eight seconds.
The driver's safety belt is buckled while the indicator light is illuminated and the warning chime is sounding...	The safety belt warning light turns off.
The driver's safety belt is buckled before the ignition key is turned to ON...	The safety belt warning light remains off.

Safety belt maintenance

Check the safety belt systems periodically to make sure they work properly and are not damaged. Check the safety belts to make sure there are no nicks, wears or cuts. All safety belt

Seating and safety restraints

assemblies, including retractors, buckles, front seat belt buckle assemblies (slide bar)(if equipped), shoulder belt height adjusters (if equipped), child safety seat tether bracket assemblies (if equipped), and attaching hardware, should be inspected after a collision. Ford recommends that all safety belt assemblies used in vehicles involved in a collision be replaced. However, if the collision was minor and a qualified technician finds that the belts do not show damage and continue to operate properly, they do not need to be replaced. Safety belt assemblies not in use during a collision should also be inspected and replaced if either damage or improper operation is noted.



Failure to replace the safety belt assembly under the above conditions could result in severe personal injuries in the event of a collision.

Refer to *Cleaning and maintaining the safety belts* in the *Maintenance and care* section.

Seating and safety restraints

AIR BAG SUPPLEMENTAL RESTRAINT SYSTEM (SRS)

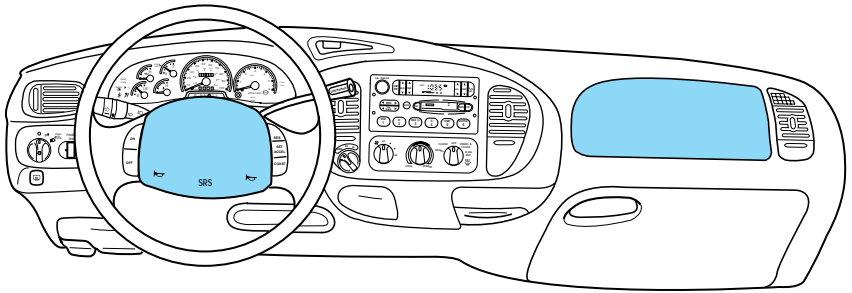

Important supplemental restraint system (SRS) precautions

The supplemental restraint system is designed to:

- work with the safety belt to protect the driver and right front passenger
- reduce certain upper body injuries

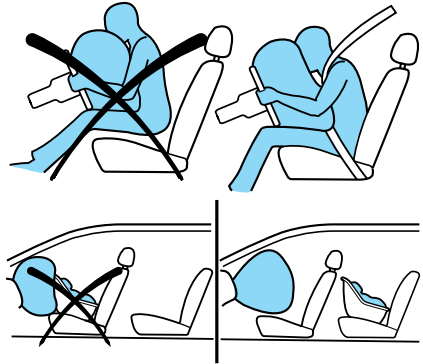

Failure to follow these instructions will affect the performance of the safety belts and increase the risk of personal injury.

Seating and safety restraints



The right front passenger air bag is not designed to restrain occupants in the center front seating position.



All occupants of the vehicle including the driver should always wear their safety belts even when air bag SRS is provided.



Do not place objects or mount equipment on or near the air bag cover on the steering wheel or in front seat areas that may come into contact with a deploying air bag. Failure to follow this instruction may increase the risk of personal injury in the event of a collision.



Do not attempt to service, repair, or modify the Air Bag Supplemental Restraint System or its fuses. See your Ford or Lincoln-Mercury dealer.

Children and air bags

For additional important safety information, read all information on safety restraints in this guide.

Children should always wear their safety belts. Failure to follow these instructions may increase the risk of injury in a collision.

Seating and safety restraints

 Air bag can kill or injure a child in a child seat. Child seats should never be placed in the front seats, unless passenger air bag switch is turned off. See *Passenger air bag deactivate switch*.

How does the air bag supplemental restraint system work?

The SRS is designed to activate when the vehicle sustains sufficient longitudinal deceleration.

The fact that the air bags did not inflate in a collision does not mean that something is wrong with the system. Rather, it means the forces were not of the type sufficient to cause activation.

The air bags inflate and deflate rapidly upon activation.

After air bag deployment, it is normal to notice a smoke-like, powdery residue or smell the burnt propellant. This may consist of cornstarch, talcum powder (to lubricate the bag) or sodium compounds (e.g., baking soda) that result from the combustion process that inflates the air bag. Small amounts of sodium hydroxide may be present which may irritate the skin and eyes, but none of the residue is toxic.

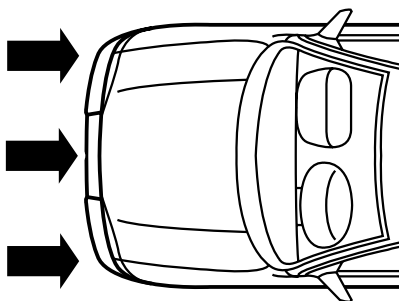

Seating and safety restraints



Several air bag system components get hot after inflation. Do not touch them after inflation.



If the air bag is inflated, **the air bag will not function again and must be replaced immediately.** If the air bag is not replaced, the unrepaired area will increase the risk of injury in a collision.

The SRS consists of:

- driver and passenger air bag modules (which include the inflators and air bags),
- one or more impact and safing sensors,
- a readiness light and tone
- and the electrical wiring which connects the components.

The diagnostic module monitors its own internal circuits and the supplemental air bag electrical system warning (including the impact sensors), the system wiring, the air bag system readiness light, the air bag back up power and the air bag ignitors.

Determining if the system is operational

The SRS uses a readiness light in the instrument cluster or a tone to indicate the condition of the system. Refer to the *Air bag readiness* section in the

Seating and safety restraints

Instrumentation chapter. Routine maintenance of the air bag is not required.

A difficulty with the system is indicated by one or more of the following:

- The readiness light will either flash or stay lit.
- The readiness light will not illuminate immediately after ignition is turned on.
- A series of five beeps will be heard. The tone pattern will repeat periodically until the problem and light are repaired.



If any of these things happen, even intermittently, have the SRS serviced at your dealership or by a qualified technician immediately. Unless serviced, the system may not function properly in the event of a collision.

Disposal of air bags and air bag equipped vehicles

For disposal of air bags or air bag equipped vehicles, see your local dealership or qualified technician. Air bags **MUST BE** disposed of by qualified personnel.

Seating and safety restraints

Passenger air bag deactivate switch

Your vehicle has a passenger air bag deactivate switch. This switch **MUST** be used to activate or deactivate the passenger air bag whenever a child seat is used in the right front or center front passenger seat position.

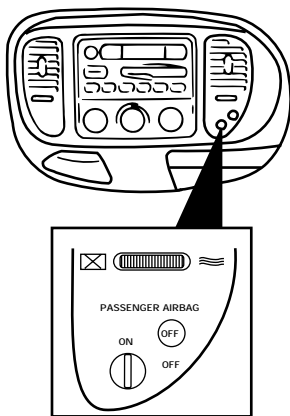

Keep the passenger air bag turned on unless there is a child seat installed in the front seat. When the passenger air bag switch is turned off, the passenger air bag will not inflate in a collision.

If the passenger air bag switch is turned off, it increases the likelihood of injury to forward facing occupants in the passenger seat.

Seating and safety restraints

Turning the passenger air bag off

1. Insert the ignition key, turn the switch to OFF and remove the key.
2. When the ignition is turned to the ON position the OFF light illuminates briefly, momentarily shuts off and then turns back on. This indicates that the passenger air bag is deactivated.

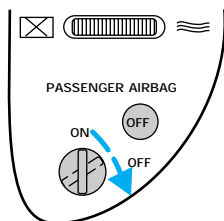

 If the light fails to illuminate when the passenger air bag switch is in the OFF position and the ignition switch is in ON, have the passenger air bag switch serviced at your Ford or Lincoln-Mercury dealer immediately.

 In order to avoid inadvertent deployment of the passenger air bag, always remove the ignition key from the passenger air bag deactivate switch.

Turning the passenger air bag back on

The passenger air bag remains OFF until you turn it back ON.

Seating and safety restraints

1. Insert the ignition key and turn the switch to ON.
2. The OFF light will briefly illuminate when the ignition is turned to On. This indicates that the passenger air bag is operational.

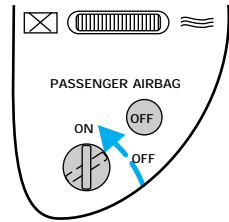

If the light is illuminated when the passenger air bag switch is in the ON position and the ignition switch is in ON, have the passenger air bag switch serviced at your Ford or Lincoln-Mercury dealer immediately.



Keep the passenger air bag turned on unless there is a child seat installed in the front seat. When the passenger air bag switch is turned off, the passenger air bag will not inflate in a collision.

Seating and safety restraints

SAFETY RESTRAINTS FOR CHILDREN

Important child restraint precautions

You are required by law to use safety restraints for children in the U.S. and Canada. If small children ride in your vehicle (generally children who are four years old or younger and who weigh 18 kg [40 lbs] or less), you must put them in safety seats made especially for children. Check your local and state or provincial laws for specific requirements regarding the safety of children in your vehicle.



Never let a passenger hold a child on his or her lap while the vehicle is moving. The passenger cannot protect the child from injury in a collision.

Always follow the instructions and warnings that come with any infant or child restraint you might use.

When possible, place children in the rear seat of your vehicle. Accident statistics suggest that children are safer when properly restrained in the rear seating positions than in the front seating position.

Children and safety belts

Children who are too large for child safety seats (as specified by your child safety seat manufacturer) should always wear safety belts.

Seating and safety restraints

Follow all the important safety restraint and air bag precautions that apply to adult passengers in your vehicle.

If the shoulder belt portion of a combination lap and shoulder belt can be positioned so it does not cross or rest in front of the child's face or neck, the child should wear the lap and shoulder belt. Moving the child closer to the center of the vehicle may help provide a good shoulder belt fit.

If the shoulder belt cannot be properly positioned:

- move the child to one of the seats with a lap belt only (if equipped)

OR

- if the child is the proper size, restrain the child in a safety seat.



Do not leave children, unreliable adults, or pets unattended in your vehicle.

To improve the fit of lap and shoulder belts on children who have outgrown child safety seats, Ford recommends use of a belt-positioning booster seat that is labelled as conforming to all Federal motor vehicle safety standards. Belt-positioning booster seats raise the child and provide a shorter, firmer seating cushion that encourages safer seating posture and better fit of lap and shoulder belts on the child.

Seating and safety restraints

A belt-positioning booster should be used if the shoulder belt rests in front of the child's face or neck, or if the lap belt does not fit snugly on both thighs, or if the thighs are too short to let the child sit all the way back on the seat cushion when the lower legs hang over the edge of the seat cushion. You may wish to discuss the special needs of your child with your pediatrician.

SAFETY SEATS FOR CHILDREN

Child and infant or child safety seats

Use a safety seat that is recommended for the size and weight of the child. Carefully follow all of the manufacturer's instructions with the safety seat you put in your vehicle. If you do not install and use the safety seat properly, the child may be injured in a sudden stop or collision.

When installing a child safety seat:

- Use the correct safety belt buckle for that seating position.
- Make sure the tongue is securely fastened in the buckle.
- Keep the buckle release button pointing up and away from the safety seat, with the tongue between the child seat and the release button, to prevent accidental unbuckling.

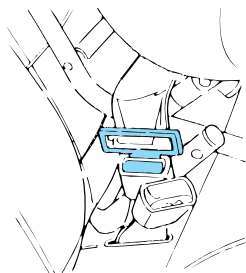

Seating and safety restraints

- Place seat back in upright position.
- Put the safety belt in the automatic locking mode. Refer to *Automatic locking mode*.

Ford recommends the use of a child safety seat having a top tether strap. Install the child safety seat in a seating position which is capable of providing a tether anchorage. For more information on top tether straps, refer to *Attaching safety seats with tether straps*.



Carefully follow all of the manufacturer's instructions included with the safety seat you put in your vehicle. If you do not install and use the safety seat properly, the child may be injured in a sudden stop or collision.

Installing child safety seats in combination lap and shoulder belt seating positions

1. Position the child safety seat in a seat with a combination lap and shoulder belt.

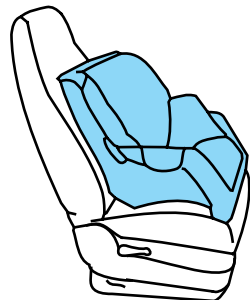

Seating and safety restraints



Air bag can kill or injure a child in a child seat. If you must use a forward-facing child seat in the front seat, move seat all the way back.

2. Pull down on the shoulder belt and then grasp the shoulder belt and lap belt together.

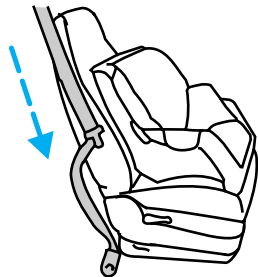

3. While holding the shoulder and lap belt portions together, route the tongue through the child seat according to the child seat manufacturer's instructions. Be sure the belt webbing is not twisted.

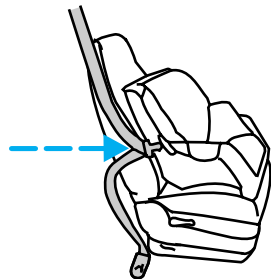

4. Insert the belt tongue into the proper buckle for that seating position until you hear and feel the latch engage. Make sure the tongue is latched securely by pulling on it.

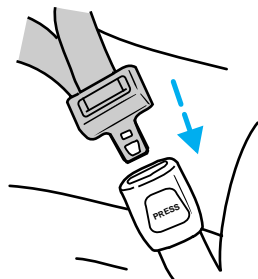

Seating and safety restraints

5. To put the retractor in the automatic locking mode, grasp the shoulder portion of the belt and pull downward until all of the belt is extracted and a click is heard.

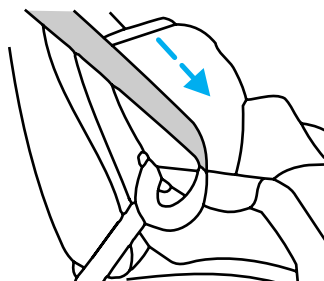

6. Allow the belt to retract. The belt will click as it retracts to indicate it is in the automatic locking mode.

7. Pull the lap belt portion across the child seat toward the buckle and pull up on the shoulder belt while pushing down with knee on the child seat.

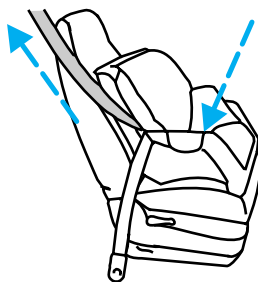

8. Allow the safety belt to retract to remove any slack in the belt.

9. Before placing the child in the seat, forcibly tilt the seat forward and back to make sure the seat is securely held in place.

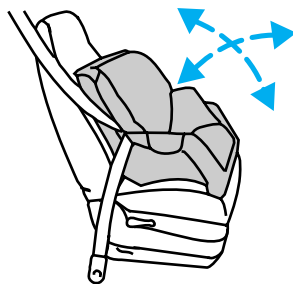

10. Try to pull the belt out of the retractor to make sure the retractor is in the automatic locking mode (you should not be

Seating and safety restraints

able to pull more belt out). If the retractor is not locked, unbuckle the belt and repeat steps two through nine.

Check to make sure the child seat is properly secured before each use.

Attaching safety seats with tether straps

Some manufacturers make safety seats that include a tether strap that goes over the back of the vehicle seat and attaches to an anchoring point. Other manufacturers offer the tether strap as an accessory. Contact the manufacturer of your child safety seat for information about ordering a tether strap.

Tether anchorage hardware

A tethered seat can be installed in the front seat. Put the tether strap over the seatback and attach it to an anchor bracket.

An anchor bracket can be installed on the rear edge of the front seat cushion.

The provision (attaching hole) is provided in the rear edge of the front passenger seat cushion frame. The anchor bracket must be installed using the instructions provided with the kit.

Tether anchorage hardware kits (part number 613D74) including instructions, may be obtained at no charge from any Ford or Lincoln-Mercury dealer.

Seating and safety restraints

If you have a SuperCab, attach the bracket to the inside of the back panel of your vehicle. Carefully follow the instructions provided with the kit.

If you have a SuperCab Ford recommends you attach tether safety seats in the rear seating position (if possible) with the tether strap attached to the tether anchorage bracket as shown in the instructions provided with the tether anchor kit.



Tighten the anchor according to specifications. Otherwise, the safety seat may not be properly secured and the child may be injured in a sudden stop or collision.

Starting

PREPARING TO START YOUR VEHICLE

Engine starting is controlled by the spark ignition system. This system meets all Canadian

Interference-Causing Equipment standard requirements regulating the impulse electrical field strength of radio noise.

When starting a fuel-injected engine, avoid pressing the accelerator before or during starting. Only use the accelerator when you have difficulty starting the engine. For more information on starting the vehicle, refer to *Starting the engine* in this chapter.



Extended idling at high engine speeds can produce very high temperatures in the engine and exhaust system, creating the risk of fire or other damage.



Do not park, idle, or drive your vehicle in dry grass or other dry ground cover. The emission system heats up the engine compartment and exhaust system, which can start a fire.



Do not start your vehicle in a closed garage or in other enclosed areas. Exhaust fumes can be toxic. Always open the garage door before you start the engine. See *Guarding against exhaust fumes* in this chapter for more instructions.



If you smell exhaust fumes inside your vehicle, have your dealer inspect your vehicle immediately. Do not drive if you smell exhaust fumes.

Important safety precautions

A computer system controls the engine's idle revolutions per minute (RPM). When the engine starts, the idle RPM runs faster to warm the engine. If the engine idle speed does not slow down automatically, have the vehicle checked. Do not allow the vehicle to idle for more than ten minutes.

Before starting the vehicle:

1. Make sure all vehicle occupants have buckled their safety belts. For more information on safety belts and their proper usage, refer to the *Seating and safety restraints* chapter.
2. Make sure the headlamps and vehicle accessories are off.

If starting a vehicle with an automatic transmission:

Starting

- Make sure the parking brake is set.

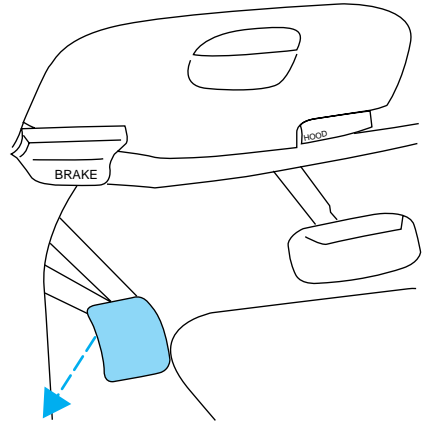

- Make sure the gearshift is in P (Park).

If starting a vehicle with a manual transmission:

- Make sure the parking brake is set.
- Push the clutch pedal to the floor.

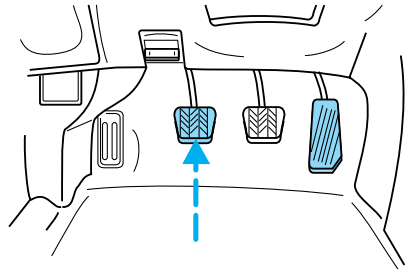

3. Turn the key to 4 (ON) without turning the key to 5 (START).

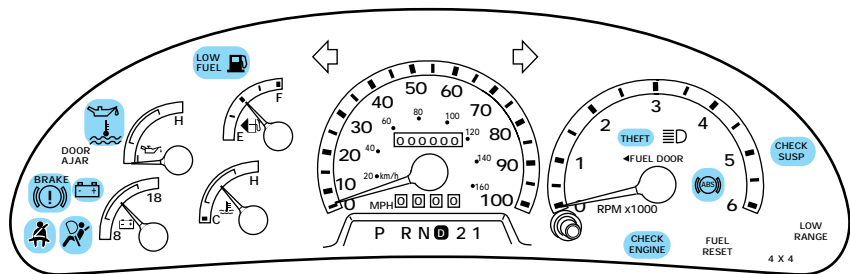
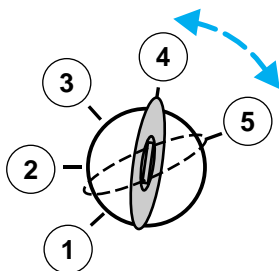

Make sure the corresponding lights illuminate briefly. If a light fails to illuminate, have the vehicle serviced.

- If the driver's safety belt is fastened, the light () will not illuminate.

Starting

STARTING THE ENGINE

1. Turn the key to 5 (START) without pressing the accelerator pedal and release as soon as the engine starts. The key will return to 4 (ON).

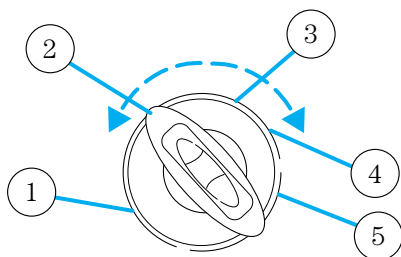

2. If the engine does not start within five seconds, wait ten seconds and try again. **If your vehicle is equipped with a 3.0L Vulcan engine**, and does not start in two attempts in ambient temperatures of -20°C (-4°F) and below, depress the accelerator approximately 1/3 of the way down and try again.

3. If the engine does not start in two attempts OR if the temperature is below -12°C (10°F), depress the accelerator and start the engine while holding the accelerator down. Release the accelerator when the engine starts.

4. After idling for a few seconds, apply the brake and release the parking brake.

Using the engine block heater (if equipped)

An engine block heater warms the engine coolant, which improves starting, warms up the engine faster and allows the heater-defroster system to respond

quickly. They are strongly recommended if you live in a region where temperatures reach -23°C (-10°F) or below.

For best results, plug the heater in at least three hours before starting the vehicle. Using the heater for longer than three hours will not harm the engine, so the heater can be plugged in the night before starting the vehicle.



To prevent electrical shock, do not use your heater with ungrounded electrical systems or two-pronged (cheater) adapters.

Guarding against exhaust fumes

Although odorless and colorless, carbon monoxide is present in exhaust fumes. Take precautions to avoid its dangerous effects.



If you ever smell exhaust fumes of any kind inside your vehicle, have your dealer inspect and fix your vehicle immediately. Do not drive if you smell exhaust fumes. These fumes are harmful and could kill you.

Have the exhaust and body ventilation systems checked whenever:

- the vehicle is raised for service

Starting

- the sound of the exhaust system changes
- the vehicle has been damaged in a collision

Important ventilating information

If the engine is idling while the vehicle is stopped in an open area for long periods of time, open the windows at least 2.5 cm (one inch).

Adjust the heating or air conditioning (if equipped) to bring in fresh air.

Improve vehicle ventilation by keeping all air inlet vents clear of snow, leaves and other debris.

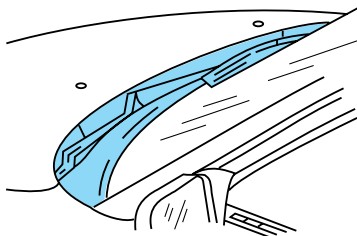

BRAKES

Your brakes are self-adjusting. Refer to the “Service Guide” for scheduled maintenance.

Occasional brake noise is normal and often does not indicate a performance concern with the vehicle’s brake system. In normal operation, automotive brake systems may emit occasional or intermittent squeal or groan noises when the brakes are applied. Such noises are usually heard during the first few brake applications in the morning; however, they may be heard at any time while braking and can be aggravated by environmental conditions such as cold, heat, moisture, road dust, salt or mud. If a “metal-to-metal,” “continuous grinding” or “continuous squeal” sound is present while braking, the brake linings may be worn-out and should be inspected by a qualified service technician.

Anti-lock brake system (ABS)

On vehicles equipped with an anti-lock braking system (ABS), a noise from the hydraulic pump motor and pulsation in the pedal may be observed during ABS braking events. Pedal pulsation coupled with noise while braking under panic conditions or on loose gravel, bumps, wet or snowy roads is normal and indicates proper functioning of the vehicle’s anti-lock brake system. If the vehicle has continuous vibration or

Driving

shudder while braking, felt mainly in the steering wheel, the vehicle most likely needs service.

The ABS operates by detecting the onset of wheel lock up during brake applications and compensating for this tendency. The front wheels are prevented from locking even when the brakes are firmly applied. The accompanying illustration depicts the advantage of an ABS equipped vehicle (on bottom) to a non-ABS equipped vehicle (on top) during hard braking.

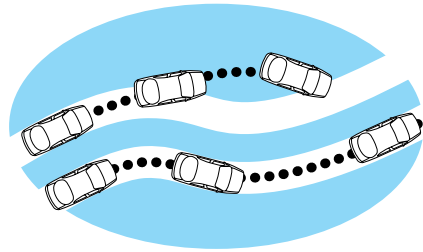

ABS warning lamp

The (ABS) warning lamp in the instrument cluster illuminates for about five seconds when starting the vehicle. If an ABS fault is detected, the light will remain on and your vehicle should be serviced as soon as possible.

Normal braking is still effective unless the BRAKE warning lamp is also illuminated.

Using ABS

- In an emergency or when maximum efficiency from the ABS is required, apply continuous full force on the brake. The ABS will be activated immediately, thus allowing you to retain full steering control of your vehicle and, providing

BRAKE
(!)

there is sufficient space, will enable you to avoid obstacles and bring the vehicle to a controlled stop.

- We recommend that you familiarize yourself with this braking technique. However, avoid taking any unnecessary risks.

Parking brake

Apply the parking brake whenever the vehicle is parked. To set the parking brake, press the parking brake pedal down until the pedal stops.

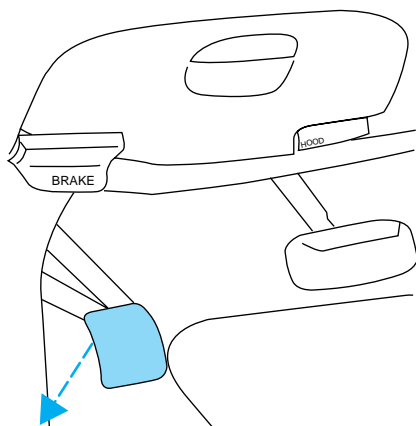

The BRAKE warning lamp in the instrument cluster illuminates and remains illuminated (when the ignition is turned ON) until the parking brake is released.

BRAKE
(!)

 Always set the parking brake fully and make sure that the gearshift is securely latched in P (Park) (automatic transmission) or in 1 (First) (manual transmission).

Driving

The parking brake is not designed to stop a moving vehicle. However, if the normal brakes fail, the parking brake can be used to stop your vehicle in an emergency. Since the parking brake applies only the rear brakes, the vehicle's stopping distance will be adversely affected.

Pull the release lever to release the brake. Driving with the parking brake on will cause the brakes to wear out quickly and reduce fuel economy.

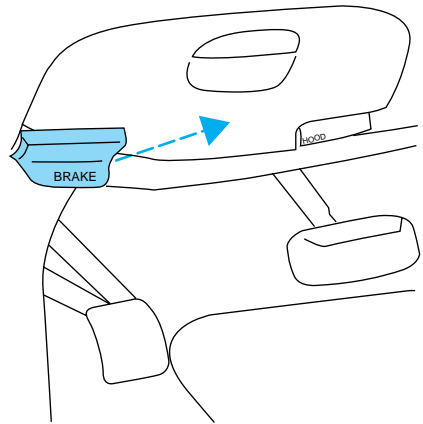

TRACTION-LOK AXLE (IF EQUIPPED)

This axle provides added traction on slippery surfaces, particularly when one wheel is on a poor traction surface. Under normal conditions, the Traction-Lok axle functions like a standard rear axle.

Extended use of other than the manufacturer's specified size tires on a Traction-Lok rear axle could result in a permanent reduction in effectiveness. This loss of effectiveness does not affect

normal driving and should not be noticeable to the driver.



To avoid injury, never run the engine with one wheel off the ground, such as when changing a tire.

AIR SUSPENSION SYSTEM (IF EQUIPPED)

The air suspension system is designed to improve ride, handling and general vehicle performance for static, on and off-road driving conditions.

- The load leveling feature of the air suspension automatically keeps the vehicle at a constant level if a load is added or removed from the vehicle.
- The height adjustment feature automatically controls the vehicle height over a range of approximately 5 cm (2 inches) based on vehicle speed, ignition position and selection of two or four-wheel drive modes.

Driving

The air suspension shut-off switch is located behind an access panel underneath the passenger side instrument panel.



On vehicles equipped with Air Suspension, turn OFF the Air Suspension switch prior to jacking, hoisting or towing your vehicle.

Normal vehicle operation does not require any action by the driver.

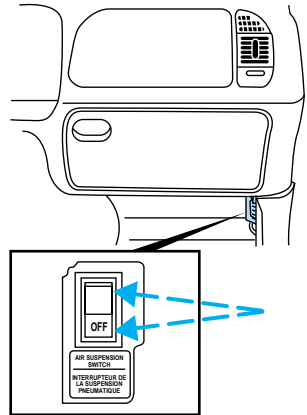

TRANSMISSION OPERATION

Automatic transmission operation

Brake-shift interlock

This vehicle is equipped with a brake-shift interlock feature that prevents the gearshift from being moved from P (Park) unless the brake pedal is depressed.

If you cannot move the gearshift out of P (Park) with the brake pedal depressed:

1. Apply the parking brake, turn ignition key to LOCK, then remove the key.
2. Insert the key and turn it to OFF. Apply the brake pedal and shift to N (Neutral).
3. Start the vehicle.

If it is necessary to use the above procedure to move the gearshift, it

is possible that a fuse has blown and the vehicle's brakelamps may not be operating properly. Refer to *Fuses and relays* in the *Roadside emergencies* chapter.



Do not drive your vehicle until you verify that the brakelamps are working.

If your vehicle gets stuck in mud or snow it may be rocked out by shifting from forward and reverse gears in a steady pattern. Press lightly on the accelerator in each gear.

Do not rock the vehicle for more than a few minutes. The transmission and tires may be damaged or the engine may overheat.



Always set the parking brake fully and make sure the gearshift is latched in P (Park). Turn off the ignition whenever you leave your vehicle.

Driving with a 4-speed automatic transmission

Understanding gearshift positions

Pull the gearshift lever towards you and downward to move the automatic gearshift.

Driving

 Hold the brake pedal down while you move the gearshift lever from position to position. If you do not hold the brake pedal down, your vehicle may move unexpectedly and injure someone.

P (Park)

Always come to a complete stop before shifting into P (Park). Make sure the gearshift is securely latched in P (Park).

R (Reverse)

With the gearshift in R (Reverse), the vehicle will move backward. Always come to a complete stop before shifting into and out of R (Reverse).

N (Neutral)

With the gearshift in N (Neutral), the vehicle can be started and is free to roll. Hold the brake pedal down while in this gear.

D (Overdrive)

The normal driving position for the best fuel economy. Transmission operates in gears one through four.

D (Overdrive) can be deactivated by pressing the transmission

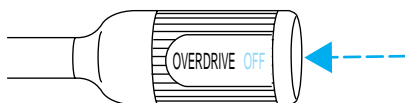

control switch on the end of the gearshift lever.

The transmission control indicator light (TCIL) (the word OFF) on the end of the gearshift lever will illuminate.

Drive – Not shown on the display. Activate by pressing the transmission control switch on the end of the gearshift lever with the gearshift in the **D** position. The TCIL (the word OFF) will illuminate on the gearshift lever. Transmission operates in gears one through three. **D** (Drive) provides more engine braking than **D** (Overdrive) and is useful when:

- driving with a heavy load
- towing a trailer up or down steep hills
- additional engine downhill braking is desired. If towing a trailer, refer to *Driving while you tow* in the *Towing a trailer* chapter.

To return to **D** (Overdrive) mode, press the transmission control switch. The TCIL (the word OFF) will no longer be illuminated.

Each time the vehicle is started, the transmission will automatically return to normal overdrive mode.

Every time the vehicle is shut off and restarted, you must press the transmission control switch to cancel overdrive operation if driving in overdrive is not desired.

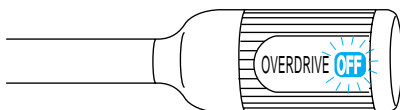

Driving

2 (Second)

Use 2 (Second) to start-up on slippery roads or to provide additional engine braking on downgrades.

1 (First)

Use 1 (Low) to provide maximum engine braking on steep downgrades. Upshifts can be made by shifting to 2 (Second) or to **D** (Overdrive). Selecting 1 (Low) at higher speeds causes the transmission to shift to a lower gear, and will shift to 1 (Low) after vehicle decelerates to the proper speed.



MANUAL TRANSMISSION OPERATION (IF EQUIPPED)

Using the clutch

Vehicles equipped with a manual transmission have a starter interlock that prevents cranking the engine unless the clutch pedal is fully depressed.

When starting a vehicle with a manual transmission, you must:

1. Put gearshift in N (Neutral).
2. Hold down brake pedal.
3. Depress clutch pedal.

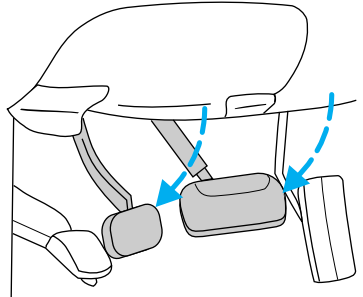
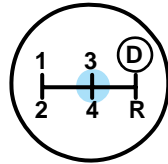

Driving

4. Turn ignition key to Start to start the engine and let it idle for a few seconds.
5. Release the brake pedal.
6. Release clutch slowly while pressing down slowly on the accelerator pedal.

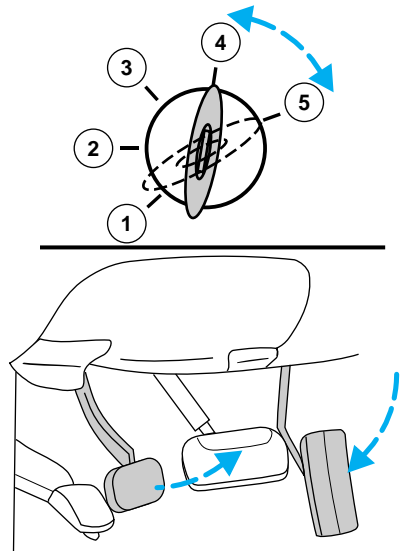

- Do not drive with your foot resting on the clutch pedal and do not use the clutch to hold your vehicle at a standstill while waiting on a hill. These actions will seriously reduce clutch life.

Recommended shift speeds

Upshift and downshift according to the following charts for your specific engine/drivetrain combination:

Upshifts when accelerating (recommended for best fuel economy)		
Shift from:	Transfer case position (if equipped)	
	2H or 4H	4L
1 - 2	14 km/h (9 mph)	5 km/h (3 mph)

Upshifts when accelerating (recommended for best fuel economy)		
2 - 3	32 km/h (20 mph)	11 km/h (7 mph)
3 - 4	50 km/h (31 mph)	19 km/h (12 mph)
4 - Ⓣ (Overdrive)	71 km/h (44 mph)	27 km/h (17 mph)

Upshifts when cruising (recommended for best fuel economy)		
Shift from:	Transfer case position (if equipped)	
	2H or 4H	4L
1 - 2	16 km/h (10 mph)	6 km/h (4 mph)
2 - 3	26 km/h (16 mph)	10 km/h (6 mph)
3 - 4	43 km/h (27 mph)	16 km/h (10 mph)
4 - Ⓣ (Overdrive)	68 km/h (42 mph)	26 km/h (16 mph)

Maximum downshift speeds		
Shift from:	Transfer case position (if equipped)	
	2H or 4H	4L
Ⓣ (Overdrive) - 4	88 km/h (55 mph)	34 km/h (21 mph)
4 - 3	72 km/h (45 mph)	27 km/h (17 mph)
3 - 2	56 km/h (35 mph)	21 km/h (13 mph)
2 - 1	32 km/h (20 mph)	11 km/h (7 mph)

Use 2H or 4H for 4WD equipped vehicles. Downshift at lower speeds when driving on slippery surfaces.

Driving

Parking your vehicle

1. Apply brake and shift into N (Neutral).

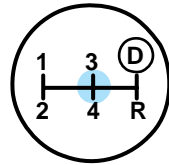
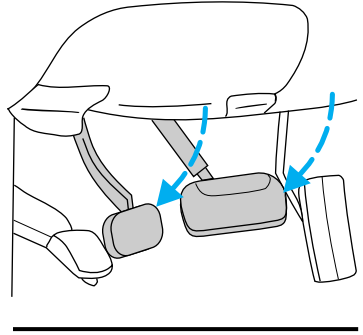

2. Set parking brake.
3. Shift into 1 (First).

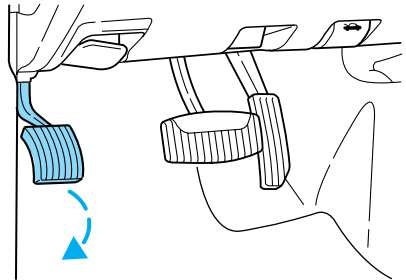

4. Turn ignition to Off.

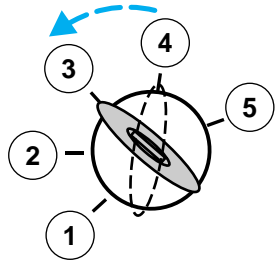

Do not park your vehicle in Neutral, it may move unexpectedly and injure someone. Use 1 (First) gear and set the parking brake fully.

Reverse

Make sure that your vehicle is at a complete stop before you shift into R (Reverse). Failure to do so may damage the transmission.

Put the gearshift in N (Neutral) and wait at least three seconds before shifting into R (Reverse).

You can shift into R (Reverse) only by moving the gearshift from left of 3 (Third) and 4 (Fourth) gears before you shift into R (Reverse). This is a special lockout feature that protects you from accidentally shifting into R (Reverse) when you downshift from **D** (Overdrive).

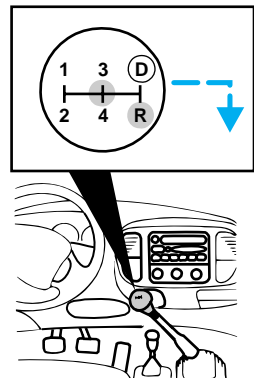

Driving

Removing key from ignition

- Turn the ignition key until it stops.
- Push the release lever forward and rotate the key towards you until it stops.
- Release the lever and remove the key from the ignition.

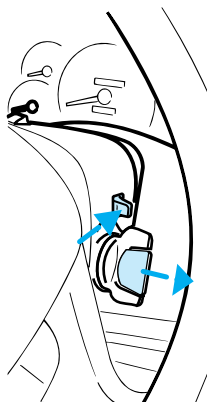

FOUR-WHEEL DRIVE (4WD) OPERATION (IF EQUIPPED)

When Four-wheel drive (4WD) is engaged, power is supplied to all four wheels through a transfer case. 4WD power can be selected when additional driving power is desired.

All utility-type vehicles and 4WD vehicles have special design and equipment features to make them capable of performing in a wide variety of off-road applications. Specific design characteristics give them higher centers of gravity than ordinary passenger cars.



Utility and four-wheel drive vehicles are **not** designed for cornering at speeds as high as passenger cars any more than low-slung sports cars are designed to perform satisfactorily under off-road conditions. Avoid sharp turns or abrupt maneuvers in these vehicles.

4WD operation is not recommended on dry pavement. Doing so could result in difficult disengagement of the transfer case, increased tire wear and decreased fuel economy.

4WD system indicator lights

The 4WD system indicator lights illuminate only under the following conditions. If these lights illuminate during normal driving, have your vehicle serviced.

- **4x4**—illuminates when the ignition is turned on or when 4H (4WD High) is selected.
- **LOW RANGE**—illuminates when the ignition is turned on and 4L (4WD Low) is selected.

4x4

LOW
RANGE

Using lever-operated 4WD system (if equipped)

2H (2WD High) – Power to rear axle only.

Driving

4H (4WD High) – Power to front and rear axles.

N (Neutral) – No power to either axle.

4L (4WD Low)– Power to front and rear axles at reduced speed.

Shifting from 2H (2WD High) to 4H (4WD High)

Move the transfer case lever to 4H (4WD High) at a stop or any forward speed up to 88 km/h (55 mph).

- At temperatures below 0°C (32°F), shifts from 2H (2WD High) to 4H (4WD High) should not be performed above 72 km/h (45 mph).
- Do not shift into 4H (4WD High) with the rear wheels slipping.

Shifting from 4H (4WD High) to 2H (2WD High)

Move the transfer case lever to 2H (2WD High) at a stop or any forward speed up to 88 km/h (55 mph).

Shifting from 4H (4WD High) to 4L (4WD Low)

1. Depress the brake.

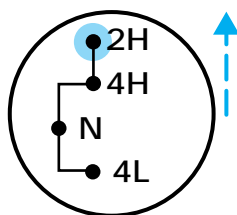
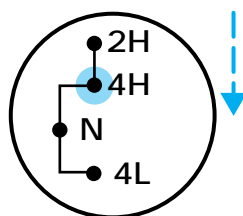

2. Place the gearshift lever in N (Neutral) (automatic transmission) or depress the clutch (manual transmission).

3. Pull the transfer case shift lever through N (Neutral) directly to 4H (4WD High) or 4L (4WD Low).

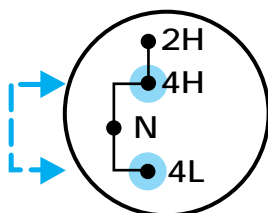

Shifting from N (Neutral) to 4H (4WD High) or 4L (4WD Low)

With the transfer case in N (Neutral) the vehicle is free to move with either the automatic transmission in P (Park) or with the manual transmission in any gear.

1. Stop the vehicle.
2. Depress the brake.
3. Place the gearshift in N (Neutral) (automatic transmission) or depress the clutch (manual transmission).

4. Place the transfer case lever in the desired gear.

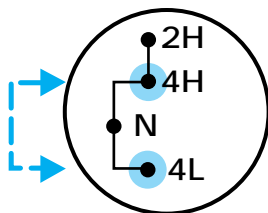

Using the N (Neutral) position

The transfer case neutral position overrides the

Driving

transmission and puts the vehicle in neutral regardless of transmission gearshift lever position. The vehicle can move forward or backwards. Make sure the parking brake is applied and the vehicle is never left unattended with the transfer case in neutral.

This position should only be used when towing the vehicle. Refer to *Wrecker towing* in the *Roadside emergencies* chapter.

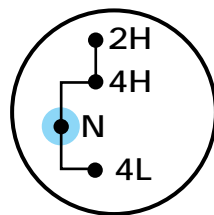

Do not leave the vehicle unattended with the transfer case in the N (Neutral) position. Always set the parking brake fully and turn off the ignition when leaving the vehicle.

Using the electronic shift 4WD system (if equipped)

Positions of the electronic shift system

2H (2WD High) – Power to rear axle only.

4H (4WD High) – Power delivered to front and rear axles for increased traction.

4L (4WD Low) – Power to front and rear axles at low speeds.

Shifting from 2H (2WD high) to 4H (4WD High)

Move the 4WD control to the 4H at a stop or up to 88 km/h (55 mph).

At temperatures below 0°C (32°F), shifts from 2H to 4H should not be performed above 72 km/h (45 mph).

- Do not shift into 4H with the rear wheels slipping.

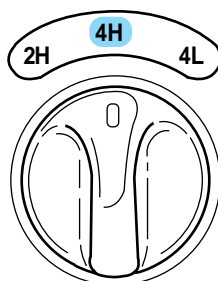

Shifting from 4H (4WD high) to 2H (2WD high)

Move the 4WD control to 2H at any forward speed.

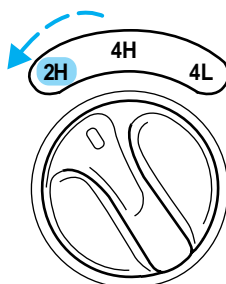

Shifting between 4H (4WD high) and 4L (4WD low)

1. Bring the vehicle to a stop.
2. Depress the brake.
3. Place the gearshift in N (Neutral) (automatic transmission) or depress the clutch (manual transmission).

Driving

4. Move the 4WD control to the 4H or 4L position.

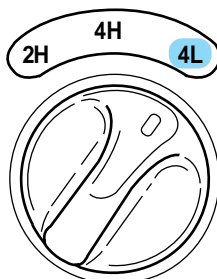

Driving off-road with 4WD

Your vehicle is specially equipped for driving on sand, snow, mud and rough terrain and has operating characteristics that are somewhat different from conventional vehicles, both on and off the road. The following information will help you learn to properly use 4WD.

When using 4WD, maintain steering wheel control at all times, especially in rough terrain. Since sudden changes in terrain can result in abrupt steering wheel motion, make sure you grip the steering wheel from the outside. Do not grip the spokes.

Drive cautiously to avoid vehicle damage from concealed objects such as rocks and stumps.

You should either know the terrain or examine maps of the area before driving. Map out your route before driving in the area. For more information on driving off-road, read the "Four Wheeling" supplement in your owner's portfolio.

If your vehicle gets stuck

If the vehicle is stuck, shift the transmission in a steady motion between forward and reverse gears. Allow the transmission to engage, then press lightly on the accelerator.



DO NOT rock the vehicle for more than a few minutes. The transmission and tires may be damaged or the engine can overheat.



Do not spin the wheels at over 35 mph (55 km/h). The tires may fail and injure a passenger or bystander.

Sand

When driving over sand, try to keep all four wheels on the most solid area of the trail. Do not reduce the tire pressures but shift to a lower gear and drive steadily through the terrain. Apply the accelerator slowly and avoid spinning the wheels.

Mud and water

If you must drive through high water, drive slowly. Traction or brake capability may be limited.

When driving through water, determine the depth; avoid water higher than the bottom of the hubs (if possible) and proceed slowly. If the ignition system gets wet, the vehicle may stall.

Driving

Once through water, always try the brakes. Wet brakes do not stop the vehicle as effectively as dry brakes. Drying can be improved by moving your vehicle slowly while applying light pressure on the brake pedal.

After driving through mud, clean off residue stuck to rotating driveshafts and tires. Excess mud stuck on tires and rotating driveshafts causes an imbalance that could damage drive components.

If the transmission and transfer case are submerged in water, their fluids should be checked and changed, if necessary.



Water intrusion into the transmission may damage the transmission.

If the rear axle is submerged in water, the rear axle lubricant should be checked and changed, if necessary. The rear axle is filled with a synthetic lubricant and does not normally require a lubricant change for the life of the vehicle. Rear axle lubricant quantities should not need to be checked unless a leak is suspected.

Driving on hill or slope terrain

When driving on a hill, avoid driving crosswise or turning on steep slopes. You could lose traction and slip sideways. Drive straight up, straight down or avoid the hill completely. Know the conditions on the other side of a

hill before driving over the crest.

When climbing a steep hill, start in a lower gear rather than downshifting to a lower gear from a higher gear once the ascent has started. This reduces strain on the engine and the possibility of stalling.

When descending a steep hill, avoid sudden braking. Rapid pumping of the brake pedal will help slow the vehicle and still maintain steering control.

When speed control is on and you are driving uphill, your vehicle speed may drop considerably, especially if you are carrying a heavy load.

If vehicle speed drops more than 15–25 km/h (8–14 mph), the speed control will cancel automatically. Resume speed with accelerator pedal.

If speed control cancels after climbing the hill, reset speed by pressing and holding the SET ACCEL button (to resume speeds over 50 km/h (30 mph)).

Automatic transmission may shift frequently while driving up steep grades. Eliminate frequent shifting by shifting out of **D** (Overdrive) into D (Drive).

Driving on snow and ice

A 4WD vehicle has advantages over 2WD vehicles in snow and ice but can skid like any other vehicle.

Driving

Avoid sudden applications of power and quick changes of direction on snow and ice. Apply the accelerator slowly and steadily when starting from a full stop.

When braking, apply the brakes as you normally would. In order to allow the anti-lock brake system (ABS) to operate properly, keep steady pressure on the brake pedal.

Allow more stopping distance and drive slower than usual. Consider using one of the lower gears.

VEHICLE LOADING

Before loading a vehicle, familiarize yourself with the following terms:

- **Base Curb Weight:** Weight of the vehicle including any standard equipment, fluids, lubricants, etc. It does not include passengers or aftermarket equipment.
- **Payload:** Combined maximum allowable weight of cargo, passengers and optional equipment. The payload equals the gross vehicle weight rating minus base curb weight.
- **GVW (Gross Vehicle Weight):** Base curb weight plus payload weight. The GVW is not a limit or a specification.
- **GVWR (Gross Vehicle Weight Rating):** Maximum total weight of the base vehicle, passengers, optional equipment and cargo. The GVWR is specific to each

vehicle and is listed on the Safety Compliance Label on the driver's door pillar.

- **GAWR (Gross Axle Weight Rating):** Carrying capacity for each axle system. The GAWR is specific to each vehicle and is listed on the Safety Compliance Label on the driver's door pillar.
- **GCWR (Gross Combined Weight Rating):** Maximum combined weight of towing vehicle (including passengers and cargo) and the trailer. The GCWR indicates the maximum loaded weight that the vehicle is allowed to tow.
- **Maximum Trailer Weight Rating:** Maximum weight of a trailer the vehicle is permitted to tow. The maximum trailer weight rating equals the vehicle curb weight for each engine/transmission combination, any required option weight for trailer towing and the weight of the driver from the GCWR for the towing vehicle.
- **Maximum Trailer Weight:** maximum weight of a trailer the loaded vehicle (including passengers and cargo) is permitted to tow. It is determined by subtracting the weight of the loaded trailer towing vehicle from the GCWR for the towing vehicle.
- **Trailer Weight Range:** Specified weight range that the

Driving

trailer must fall within that ranges from zero to the maximum trailer weight rating.

Remember to figure in the tongue load of your loaded trailer when figuring the total weight.



Do not exceed the GVWR or the GAWR specified on the Safety Compliance Certification Label.

Do not use replacement tires with lower weight capacities than the originals because they may lower the vehicle's GVWR and GAWR limitations. Replacement tires with a higher weight limit than the originals do not increase the GVWR and GAWR limitations.

Calculating the load your vehicle can carry/tow

1. Use the Safety Compliance Certification Label to find the axle code number and engine type for your vehicle.
2. Use the appropriate maximum gross combined weight rating (GCWR) chart to find the maximum GCWR for your type engine and rear axle ratio.
3. Weigh your vehicle as you customarily operate the vehicle without cargo. To obtain correct weights, try taking your vehicle to a shipping company or an inspection station for trucks.
4. Subtract your loaded vehicle weight from the maximum GCWR

on the following charts. This is the maximum trailer weight your vehicle can tow and must fall below the maximum shown under maximum trailer weight on the chart.

DRIVING THROUGH WATER

Do not drive quickly through standing water, especially if the depth is unknown. Traction or brake capability may be limited and if the ignition system gets wet, your engine may stall. Water may also enter your engine's air intake and severely damage your engine.

If driving through deep or standing water is unavoidable, proceed very slowly. Never drive through water that is higher than the bottom of the hubs (truck)/wheel rims (car).

Once through the water, always try the brakes. Wet brakes do not stop the vehicle as effectively as dry brakes. Drying can be improved by moving your vehicle slowly while applying light pressure on the brake pedal.

Driving

TOWING A TRAILER

Your vehicle may tow a class I, II or III trailer provided the maximum trailer weight is less than or equal to the maximum trailer weight listed for your engine and rear axle ratio on the following charts.

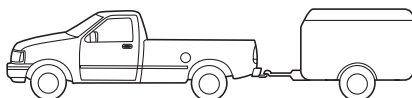

Your vehicle's load capacity is designated by weight, not by volume, so you cannot necessarily use all available space when loading a vehicle.

Towing a trailer places an additional load on your vehicle's engine, transmission, axle, brakes, tires and suspension. Inspect these components carefully after any towing operation.



Do not exceed the GVWR or the GAWR specified on the Safety Compliance Certification Label.



Towing trailers beyond the maximum recommended gross trailer weight could result in engine damage, transmission/axle damage, structural damage, loss of control, and personal injury.

Trailer towing tables

F-150 4x2 with automatic transmission

Engine	Rear axle ratio	Maximum GCWR-kg (lbs.)	Maximum trailer weight-kg (lbs.)
Regular Cab			
4.2L	3.08	4 077 (9 000)	2 177 (4 800)
4.2L	3.55	4 530 (10 000)	2 582 (5 800)
4.6L	3.08	4 530 (10 000)	2 582 (5 800)
4.6L	3.55	5 209 (11 500)	3 261 (7 200)
5.4L	3.08	4 983 (11 000)	2 948 (6 500)
5.4L	3.55	5 753 (12 700)	3 268 (8 000)
SuperCab			
4.2L	3.08	4 077 (9 000)	2 086 (4 600)
4.2L	3.55	4 530 (10 000)	2 540 (5 600)
4.6L	3.08	4 530 (10 000)	2 491 (5 500)
4.6L	3.55	5 209 (11 500)	3 171 (7 000)
5.4L	3.08	4 983 (11 000)	2 857 (6 300)
5.4L	3.55	4 983 (12 700)	3 628 (8 000)

Driving

F-150 4x2 manual transmission

Engine	Rear axle ratio	Maximum GCWR-kg (lbs.)	Maximum trailer weight-kg (lbs.)	Maximum frontal area of trailer-m (ft)
Regular Cab F-150				
4.2L	3.08	2 944 (6 500)	1 041 (2 300)	5.52 (60)
4.2L	3.55	3 533 (7 800)	1 630 (3 600)	5.52 (60)
4.6L	3.08	2 944 (6 500)	997 (2 200)	5.52 (60)
4.6L	3.55	3 533 (7 800)	1 587 (3 500)	5.52 (60)
SuperCab F-150				
4.2L	3.08	2 944 (6 500)	951 (2 100)	5.52 (60)
4.2L	3.55	3 533 (7 800)	1 540 (3 400)	5.52 (60)
4.6L	3.08	2 944 (6 500)	907 (2 000)	5.52 (60)
4.6L	3.55	3 533 (7 800)	1496 (3 300)	5.52 (60)

F-150 4x4 automatic transmission

Engine	Rear axle ratio	Maximum GCWR-kg (lbs.)	Maximum trailer weight-kg (lbs.)	Maximum frontal area of trailer-m (ft)
Regular Cab F-150				
4.2L	3.08	4 077 (9 000)	1 995 (4 400)	5.52 (60)
4.2L	3.55	4 530 (10 000)	2 449 (5 400)	5.52 (60)
4.6L	3.08	4 530 (10 000)	2 404 (5 300)	5.52 (60)
4.6L	3.55	5 209 (11 500)	3 084 (6 800)	5.52 (60)
5.4L	3.08	4 983 (11 000)	2 721 (6 000)	5.52 (60)
5.4L	3.55	5 753 (12 700)	3 492 (7 700)	5.52 (60)
SuperCab F-150				
4.6L	3.08	4 530 (10 000)	2 313 (5 100)	5.52 (60)

Driving

Engine	Rear axle ratio	Maximum GCWR-kg (lbs.)	Maximum trailer weight-kg (lbs.)	Maximum frontal area of trailer-m (ft)
4.6L	3.55	5 209 (11 500)	2 993 (6 600)	5.52 (60)
5.4L	3.08	4 983 (11 000)	2 721 (6 000)	5.52 (60)
5.4L	3.55	5 753 (12 700)	3 492 (7 700)	5.52 (60)

F-150 4x4 manual transmission

Trailer towing table (F-150 4x4 manual transmission)				
Engine	Rear axle ratio	Maximum GCWR-kg (lbs.)	Maximum trailer weight-kg (lbs.)	Maximum frontal area of trailer-m (ft)
Regular Cab F-150				
4.2L	3.08	2 944 (6 500)	861 (1 900)	5.52 (60)
4.2L	3.55	3 533 (7 800)	1 451 (3 200)	5.52 (60)
4.6L	3.08	2 944 (6 500)	816 (1 800)	5.52 (60)
4.6L	3.55	3 533 (7 800)	1 406 (3 100)	5.52 (60)
SuperCab F-150				
4.6L	3.08	2 944 (6 500)	771 (1 700)	5.52 (60)
4.6L	3.55	3 533 (7 800)	1 360 (3 000)	5.52 (60)

F-250 4x2 automatic transmission

Engine	Rear axle ratio	Maximum GCWR-kg (lbs.)	Maximum trailer weight-kg (lbs.)	Maximum frontal area of trailer-m (ft)
Regular Cab F-250				
4.6L	3.31	4 756 (10 500)	2 630 (5 800)	5.52 (60)

Driving

Engine	Rear axle ratio	Maximum GCWR-kg (lbs.)	Maximum trailer weight-kg (lbs.)	Maximum frontal area of trailer-m (ft)
4.6L	3.73	5 436 (12 000)	3 311 (7 300)	5.52 (60)
5.4L	3.31	5 436 (12 000)	3 265 (7 200)	5.52 (60)
5.4L	3.73	6 115 (13 500)	3 946 (8 600)	5.52 (60)
SuperCab F-250				
4.6L	3.31	4 756 (10 500)	2 585 (5 700)	5.52 (60)
4.6L	3.73	5 436 (12 000)	3 265 (7 200)	5.52 (60)
5.4L	3.31	5 436 (12 000)	3 220 (7 100)	5.52 (60)
5.4L	3.73	6 115 (13 500)	3 900 (8 600)	5.52 (60)

F-250 4x2 manual transmission

Engine	Rear axle ratio	Maximum GCWR-kg (lbs.)	Maximum trailer weight-kg (lbs.)	Maximum frontal area of trailer-m (ft)
Regular Cab F-250				
4.6L	3.31	3 261 (7 200)	1 179 (2 600)	5.52 (60)
4.6L	3.73	3 533 (7 800)	1 451 (3 200)	5.52 (60)
SuperCab F-250				
4.6L	3.31	3 261 (7 200)	1 133 (2 500)	5.52 (60)
4.6L	3.73	3 533 (7 800)	1 406 (3 100)	5.52 (60)

F-250 4x4 automatic transmission

Engine	Rear axle ratio	Maximum GCWR-kg (lbs.)	Maximum trailer weight-kg (lbs.)	Maximum frontal area of trailer-m (ft)
Regular Cab F-250				
4.6L	3.31	4 756 (10 500)	2 449 (5 400)	5.52 (60)
4.6L	3.73	5 436 (12 000)	3 129 (6 900)	5.52 (60)
5.4L	3.31	5 436 (12 000)	3 084 (6 800)	5.52 (60)
5.4L	3.73	6 115 (13 500)	3 764 (8 300)	5.52 (60)
SuperCab F-250				
4.6L	3.31	4 756 (10 500)	2 449 (5 400)	5.52 (60)
4.6L	3.73	5 436 (12 000)	3 129 (6 900)	5.52 (60)
5.4L	3.31	5 436 (12 000)	3 084 (6 800)	5.52 (60)
5.4L	3.73	6 115 (13 500)	3 764 (8 300)	5.52 (60)

F-250 4x4 manual transmission

Engine	Rear axle ratio	Maximum GCWR-kg (lbs.)	Maximum trailer weight-kg (lbs.)	Maximum frontal area of trailer-m (ft)
Regular Cab F-250				
4.6L	3.31	3 261 (7 200)	952 (2 100)	5.52 (60)
4.6L	3.73	3 533 (7 800)	1 224 (2 700)	5.52 (60)

Driving

Engine	Rear axle ratio	Maximum GCWR-kg (lbs.)	Maximum trailer weight-kg (lbs.)	Maximum frontal area of trailer-m (ft)
SuperCab F-250				
4.6L	3.31	3 261 (7 200)	952 (2 100)	5.52 (60)
4.6L	3.73	3 533 (7 800)	1 224 (2 700)	5.52 (60)

Preparing to tow

Use the proper equipment for towing a trailer, and make sure it is properly attached to your vehicle. See your dealer or a reliable trailer dealer if you require assistance.

Hitches

Do not use hitches that clamp onto the vehicle's bumper or attach to the axle. You must distribute the load in your trailer so that 10 to 15% of the total weight of the trailer is on the tongue.

Load equalizing hitch

When hooking up a trailer using a load equalizing hitch, always use the following procedure:

1. Park the unloaded vehicle on a level surface. With the ignition on and all doors closed, allow the vehicle to stand for several minutes so that it can level.
2. Turn the air suspension (if equipped) control to OFF.

3. Measure the height of a reference point on the front and rear bumpers at the center of the vehicle.
4. Attach the trailer to the vehicle and adjust the hitch equalizers so that the front bumper height is within 0–13 mm (0.5 in) of the reference point. After proper adjustment, the rear bumper should be no higher than in Step 3.
5. Turn the air suspension (if equipped) control to ON.



Adjusting an equalizing hitch so the rear bumper of the vehicle is lower or higher than it was unloaded will defeat the function of the load equalizing hitch and may cause unpredictable handling.

Safety chains

Always connect the trailer's safety chains to the vehicle. To connect the trailer's safety chains, cross the chains under the trailer tongue and allow slack for turning corners.

If you use a rental trailer, follow the instructions that the rental agency gives to you.

Trailer brakes

Electric brakes and manual, automatic or surge-type brakes are safe if installed properly and adjusted to the manufacturer's specifications. The trailer brakes

Driving

must meet local and Federal regulations.



Do not connect a trailer's hydraulic brake system directly to your vehicle's brake system. Your vehicle may not have enough braking power and your chances of having a collision greatly increase.

Trailer lamps

Trailer lamps are required on most towed vehicles. Make sure your trailer lamps conform to local and Federal regulations. See your dealer or trailer rental agency for proper instructions and equipment for hooking up trailer lamps.

Using a step bumper

The rear bumper is equipped with an integral hitch and requires only a ball with a 25.4 mm (one inch) shank diameter. The bumper has a 2 270 kg (5 000 lb.) trailer weight and 227 kg (500 lb.) tongue weight capability.

If it is necessary to relocate the trailer hitch ball position, a frame-mounted trailer hitch must be installed.

Driving while you tow

Do not drive faster than 88 km/h (55 mph) when towing a trailer.

Speed control may shut off if you are towing on long, steep grades.

When towing a trailer:

- Use D (Drive) or a lower gear when towing up or down steep hills. This will eliminate excessive downshifting and upshifting for optimum fuel economy and transmission cooling.
- Anticipate stops and brake gradually.

Servicing after towing

If you tow a trailer for long distances, your vehicle will require more frequent service intervals. Refer to the Severe Duty Schedule in your “Service Guide” for more information.

Trailer towing tips

- Practice turning, stopping and backing up in an area before starting on a trip to get the feel of the vehicle trailer combination. When turning, make wider turns so the trailer wheels will clear curbs and other obstacles.
- Allow more distance for stopping with a trailer attached.
- The trailer tongue weight should be 10–15% of the loaded trailer weight.
- After you have traveled 80 km (50 miles), thoroughly check your hitch, electrical connections and trailer wheel lug nuts.
- When stopped in traffic for long periods of time in hot weather, place the gearshift in P (Park)

Driving

(automatic transmissions) or 1 (First) (manual transmissions) and increase idle speed. This aids engine cooling and air conditioner efficiency.

- Vehicles with trailers should not be parked on a grade. If you must park on a grade, place wheel chocks under the trailer's wheels.

Launching or retrieving a boat

When backing down a ramp during boat launching or retrieval,

- Do not allow the static water level to rise above the bottom edge of the rear bumper and
- Do not allow waves to break higher than 15 cm (six inches) above the bottom edge of the rear bumper.

Exceeding these limits may allow water to enter critical vehicle components, adversely affecting driveability, emissions and reliability.

If the rear axle is submerged in water, the rear axle lubricant should be checked and changed, if necessary. The rear axle is filled with a synthetic lubricant and does not normally require a lubricant change for the life of the vehicle. Rear axle lubricant quantities should not need to be checked unless a leak is suspected.

Recreational towing (all wheels on the ground)

Follow these guidelines for your specific powertrain combination to tow your vehicle with all four wheels on the ground (such as behind a recreational vehicle).

These guidelines are designed to ensure that your transmission is not damaged due to insufficient lubrication.

2WD (manual and automatic transmissions)

1. Place transmission in N (Neutral).
2. Maximum speed is 56 km/h (35 mph).
3. Maximum distance is 80 km (50 miles).

If a distance of 80 km (50 miles) or a speed of 56 km/h (35 mph) must be exceeded, you must disconnect the rear driveshaft.

With the rear driveshaft disconnected, the maximum speed is 88 km/h (55 mph) and there are no mileage restrictions.

See your dealer for help with disconnecting the driveshaft.

4WD – Lever operated transfer case (manual and automatic transmissions)

1. Place transmission in P (Park).
2. Shift the transfer case to N (Neutral).

Driving

3. Lockout the center disconnect by capping off one of the front axle vacuum motor lines. See your Ford dealer for assistance.
4. Vehicle speed should not exceed 88 km/h (55 mph) and there are no mileage restrictions.

4WD – Electronic shift transfer case

1. Place transmission in N (Neutral).
2. Shift the transfer case to 2H (2WD high).
3. Lockout the center disconnect by capping off one of the front axle vacuum motor lines. See your dealer for assistance.
4. Maximum speed is 56 km/h (35 mph).
5. Maximum distance is 80 km (50 miles).

If a distance of 80 km (50 miles) or a speed of 56 km/h (35 mph) must be exceeded, you must disconnect the rear driveshaft. With the rear driveshaft disconnected, the maximum speed is 88 km/h (55 mph) and there are no mileage restrictions.

See your dealer for help with disconnecting the driveshaft.

SNOWPLOWING

Ford recommends the following specifications for low speed, personal use snow removal:

- F-150/F-250 4WD Regular Cab long wheelbase
- 4.6L or 5.4L engine
- Heavy duty service package
- Super engine cooling
- Heavy duty front suspension package
- Automatic transmission with auxiliary automatic transmission fluid cooling
- All-terrain tires

Do not install a snowplow and plow with your vehicle until it has been driven at least 800 km (500 miles).

Installing snowplow

Read the following instructions before installing a snowplow:

- Front GAWR must not exceed 63% of the GVW. Add ballast weight to the back of the vehicle, if necessary. Refer to the Safety Compliance Certification Label to find Front GAWR.
- The Front Axle Accessory Reserve Capacity and the Total Accessory Reserve Capacity listed on the bottom right of the Safety Compliance Certification Label will determine whether or not the addition of a snowplow will overload your vehicle.
- The weight of the snowplow and supporting components distributed to the front axle

Driving

must not exceed the front accessory reserve capacity.

- The total weight of the snowplow and aftermarket equipment must not exceed the Total Accessory Reserve Capacity.
- The weight of the installed snowplow and aftermarket equipment must not load the vehicle beyond the GAWR (front/rear) and GVWR listed on the Safety Compliance Certification Label.
- The total weight of the snowplow and aftermarket equipment must be considered part of the payload and must not exceed the Gross Combined Weight Rating (GCWR) for towing.
- Federal and most local regulations require additional exterior lamps for snowplow-equipped vehicles. Consult your dealer for additional information.
- After installing a snowplow to the vehicle, ensure the vehicle's front toe alignment and front ride height are within specification (reset if required). These specifications are located in the vehicle's Workshop Manual. Adherence to the toe, tire pressures and ride height specification is important for proper tire wear, ride, handling and headlight aim. Also,

maintain the engine oil and transmission fluid change intervals.



Do not exceed the GVWR or the GAWR specified on the Safety Compliance Certification Label.

Removing snowplow

Read the following instructions before removing a snowplow:

- After removing a snowplow from the vehicle, ensure the vehicle's front toe alignment and front ride height are within specification (reset if required). These specifications are located in the vehicle's Workshop Manual. Adherence to the toe and ride height specification is important for proper tire wear, ride, handling and headlight aim.

Snowplowing with your air bag equipped vehicle

Your vehicle is equipped with driver and passenger air bags. The air bags are designed to deploy in a collision with a solid barrier at a range of 13 to 23 km/h (8 to 14 mph) or a parked car at a range of 25 to 45 km/h (16 to 28 mph).



Careless or high speed driving while plowing snow which results in vehicle decelerations equivalent

Driving

to or greater than the air bag deployment impact speeds listed above can deploy the air bag. Such driving also increases the risk of accidents.



All occupants of the vehicle, including the driver, should always wear their safety belts.

Never remove or defeat the “tripping mechanisms” designed into the snow removal equipment by its manufacturer. Doing so may cause damage to the vehicle and the snow removal equipment as well as possible air bag deployment.



Do not attempt to service, repair, or modify the Air Bag Supplemental Restraint System or its fuses. See your Ford or Lincoln-Mercury dealer.

Engine temperature while plowing

When driving with a plow, your engine may run at a higher temperature than normal because the attached snowplow blade will restrict airflow to the radiator.

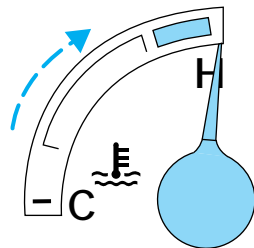

If you are driving more than 24 km (15 miles) at temperatures above freezing, angle the plow blade

either full left or full right to provide maximum airflow to the radiator.

If you are driving less than 24 km (15 miles) at speeds up to 64 km/h (40 mph) in cold weather, you will not need to worry about blade position to provide maximum airflow.

Transmission operation while plowing

- Shift transfer case to 4L (4WD Low) when plowing in small areas at speeds below 8 km/h (5 mph).
- Shift transfer case to 4H (4WD High) when plowing larger areas or light snow at higher speeds. Do not exceed 24 km/h (15 mph).
- Do not shift the transmission from a forward gear to R (Reverse) until the engine is at idle and the wheels are stopped.
- If the vehicle is stuck, shift the transmission in a steady motion between forward and reverse gears. Do not rock the vehicle for more than a few minutes. The transmission and tires may be damaged or the engine can overheat.



Do not spin the wheels at over 35 mph (55 km/h). The tires may fail and injure a passenger or bystander.

Driving

FUEL CONSUMPTION

Fuel economy can be improved by avoiding:

- lack of regular, scheduled maintenance
- excessive speed
- rapid acceleration
- extended idle

HAZARD LIGHTS CONTROL

Use only in an emergency to warn traffic of vehicle breakdown, approaching danger, etc. The hazard flashers can be operated when the ignition is off.

- The hazard lights control is located on top of the steering column.
- Depress hazard lights control to activate all hazard flashers simultaneously.
- Depress control again to turn the flashers off.

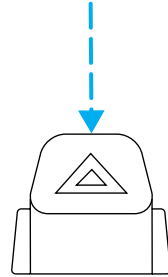

FUEL PUMP SHUT-OFF SWITCH

If the engine cranks but does not start after a collision, the fuel pump shut-off switch may have been activated. The shut-off switch is a device intended to stop the electric fuel pump when your vehicle has been involved in a substantial jolt.

1. Turn the ignition switch to the OFF position.
2. Check the fuel system for leaks.
3. If no fuel leak is apparent, reset the fuel pump shut-off switch by pushing in the button on the switch.
4. Turn the ignition switch to the ON position. Pause for a few seconds and return the key to the OFF position.

Roadside emergencies

5. Make a further check for leaks in the fuel system.

The fuel pump shut-off switch is located in the passenger's foot well, behind the kick panel.

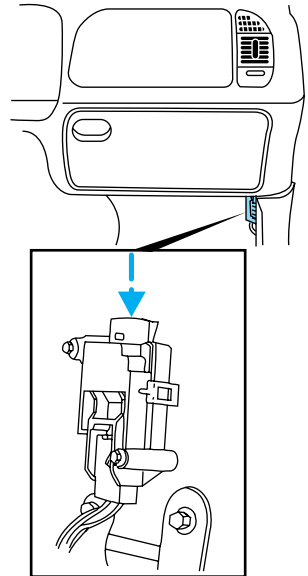

FUSES AND RELAYS

Fuses

If electrical components in the vehicle are not working, a fuse may have blown. Blown fuses are identified by a broken wire within the fuse. Check the appropriate fuses before replacing any electrical components.

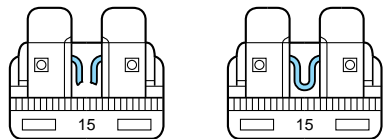

Roadside emergencies



Always replace a fuse with one that has the specified amperage rating. Using a fuse with a higher amperage rating can cause severe wire damage and could start a fire.

Standard fuse amperage rating and color

Fuse rating	Color
5 amp	Tan
7.5 amp	Brown
10 amp	Red
15 amp	Light blue
20 amp	Yellow
20 amp fuse link	Light blue
25 amp	Natural
30 amp	Light green
30 amp fuse link	Pink
40 amp fuse link	Green
50 amp fuse link	Red
60 amp fuse link	Yellow
80 amp fuse link	Black
100 amp fuse link	Dark blue

Passenger compartment fuse panel

The fuse panel is located below and to the left of the steering wheel by the brake pedal. Pull the panel cover outward to access the fuses.

To remove a fuse use the fuse puller tool provided on the fuse panel cover.

Roadside emergencies

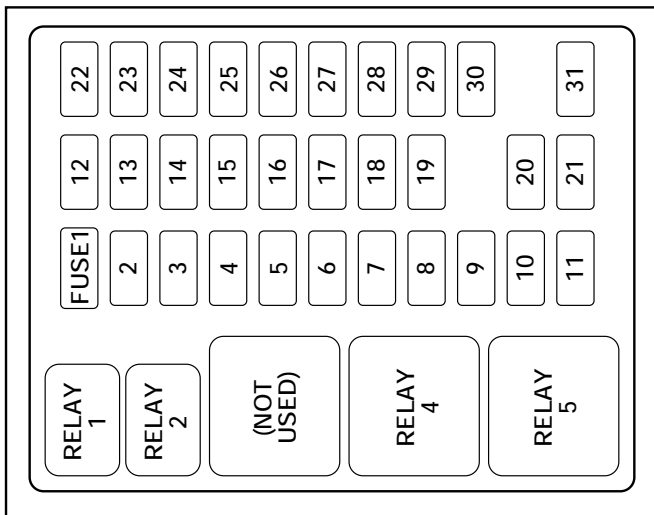

The fuses are coded as follows.

Fuse/Relay Location	Fuse Amp Rating	Description
1	15A	Flasher Relay
2	5A	Instrument Cluster
3	25A	Cigar Lighter
4	5A	Park Lamp Relay, Headlamp Relay, Autolamp Module Remote Anti-Theft Personality (RAP) Module, Power Mirror Switch

Roadside emergencies

Fuse/Relay Location	Fuse Amp Rating	Description
5	15A	Digital Transmission Range (DTR) Sensor (A/T), Backup Lamp Switch (M/T), Daytime Running Lights (DRL) Module, Speed Control Servo/Amplifier Assembly, Heater-A/C Control Assembly, Blend Door Actuator
6	5A	Shift Lock Actuator, Generic Electronic Module (GEM), Rear Air Suspension (RAS) Module
7	—	Not Used
8	5A	Radio, Main Light Switch, Remote Anti-Theft Personality (RAP) Module
9	—	Not Used
10	—	Not Used
11	30A	Washer Pump Relay, Wiper Run/Park Relay, Wiper Hi/LO Relay, Windshield Wiper Motor
12	5A	Data Link Connector (DLC)
13	15A	Rear Anti-Lock Brake System (RABS) Module, Brake On/Off (BOO) Switch, Brake Pressure Switch

Roadside emergencies

Fuse/Relay Location	Fuse Amp Rating	Description
14	15A	Battery Saver Relay, Interior Lamp Relay
15	5A	Generic Electronic Module (GEM)
16	20A	Instrument Cluster (W/O DRL), Daytime Running Lamps (DRL) Module, Hi-Beam Headlamps (Power supplied through Multi-Function Switch)
17	—	Not Used
18	5A	Park Lamp Relay, Trailer Electronic Brake Controller, Main Light Switch, Trailer Tow Run Relay, Front Park/Turn Lamps, License Lamps, Stop/Park/Turn Lamps, Tail/Side Marker Lamps (Power supplied through Main Light Switch)
19	10A	Instrument Cluster, Air Bag Diagnostic Monitor
20	5A	Powertrain Control Module (PCM), Generic Electronic Module (GEM)/Central Timer Module (CTM)

Roadside emergencies

Fuse/Relay Location	Fuse Amp Rating	Description
21	15A	Clutch Pedal Position (CPP) Switch (W/O RAP), Starter Interrupt Relay (W/RAP)
22	10A	Air Bag Diagnostic Monitor, Passive De-Activation (PAD) Module
23	10A	Trailer tow Battery Charge Relay, 4X4 Hub Solenoid, 4X2 Hub Solenoid, Flasher Relay, Shift on the Fly Relay
24	10A	Blower Relay
25	5A	4 Wheel Anti-Lock Brake System (4WABS) Module, 4WABS Relay
26	10A	Daytime Running Lamps (DRL) Module, Right Headlamp
27	5A	Main Light Switch, Fog Lamp Relay
28	10A	Left Headlamp
29	5A	Autolamp Module, Instrument Cluster, Transmission Control Switch (TCS), Brake Warning Resistor/Diode Assembly (W/RABS)

Roadside emergencies

Fuse/Relay Location	Fuse Amp Rating	Description
30	30A	Radio Noise Capacitor, Ignition Coil, PCM Power Diode
31	—	Not Used
Relay 1	—	Interior Lamp Relay
Relay 2	—	Battery Saver Relay
Not Used	—	Not Used
Relay 4	—	One Touch Down Relay
Relay 5	—	ACC Delay Relay

Power distribution box

The power distribution box is located in the engine compartment. The power distribution box contains high-current fuses that protect your vehicle's main electrical systems from overloads.



Always disconnect the battery before servicing high current fuses.



Always replace the cover to the Power Distribution Box before reconnecting the battery or refilling fluid reservoirs.

Roadside emergencies

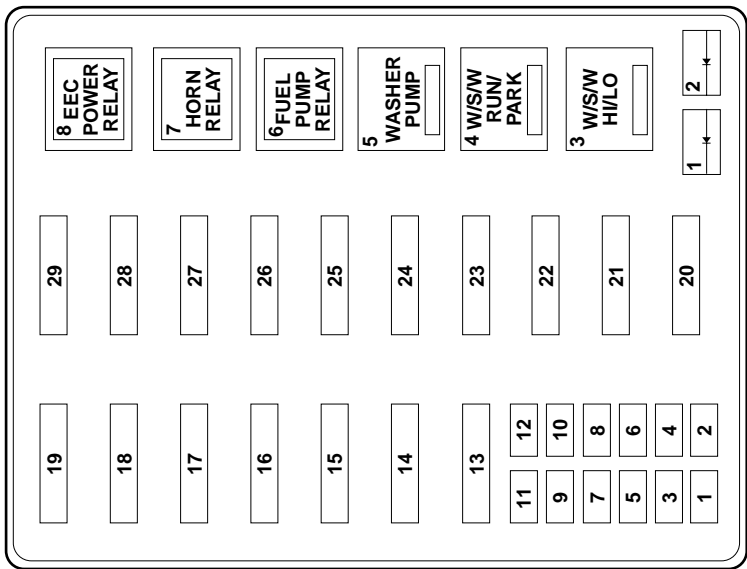

The high-current fuses are coded as follows.

Fuse/Relay Location	Fuse Amp Rating	Description
1	20A *	Trailer Tow Running Lamp Relay, Trailer Tow Backup Lamp Relay
2	10A*	Air Bag Diagnostic Monitor
3	15A*	All Unlock Relay, All Lock Relay, Driver Unlock Relay, LH Power Door Lock Switch, RH Power Door Lock Switch

Roadside emergencies

Fuse/Relay Location	Fuse Amp Rating	Description
4	15A*	Rear Air Suspension (RAS)
5	20A*	Horn Relay
6	15A*	Radio, Premium Sound Amplifier, CD Changer
7	15A*	Main Light Switch, Park Lamp Relay
8	30A*	Main Light Switch, Headlamp Relay, Multi-Function Switch
9	15A*	Daytime Running Lamps (DRL) Module, Fog Lamp Relay
10	25A*	Auxiliary Power Socket
11	—	Not Used
12	—	Not Used
13	—	Not Used
14	60A**/20A**	4 Wheel Anti-Lock Brake System (4WABS) Module/Ignition Switch (W/RABS Only)
15	50A**	Rear Air Suspension Compressor
16	40A**	Trailer Tow Battery Charge Relay, Engine Fuse Module (Fuse 2)
17	30A**	Shift on the Fly Relay, Transfer Case Shift Relay
18	30A**	Power Seat Control Switch
19	20A**	Fuel Pump Relay

Roadside emergencies

Fuse/Relay Location	Fuse Amp Rating	Description
20	50A**	Ignition Switch
21	50A**	Ignition Switch
22	50A**	Junction Box Fuse/Relay Panel Battery Feed
23	40A**	Blower Relay
24	30A**	PCM Power Relay, Engine Fuse Module (Fuse 1)
25	30A**	Junction Box Fuse/Relay Panel, ACC Delay Relay
26	—	Not Used
27	—	Not Used
28	30A**	Trailer Electronic Brake Controller
29	—	Not Used
*Mini fuses **Maxi fuses		

CHANGING THE TIRES

If you get a flat tire while driving, do not apply the brake heavily. Instead, gradually decrease your speed. Hold the steering wheel firmly and slowly move to a safe place on the side of the road.

Spare tire information

Your vehicle is equipped with a spare tire that may be used as a spare or a regular tire. The spare tire is not equipped with wheel trim. The wheel trim from the original wheel/tire may be used on the spare.

Roadside emergencies

If your vehicle is equipped with 4WD or AWD, a spare tire of a different size than the road tires should not be used. Such a tire could result in damage to driveline components and make the vehicle difficult to control.

Location of the spare tire and tools

The spare tire and tools for your vehicle are stowed in the following locations:

Tool	Location
Spare tire	Under the vehicle, just forward of the rear bumper
Jack, lug nut wrench	Under the seat
Jack handle	On top of the radiator support at the front of the engine compartment

Removing the spare tire

1. Insert the jack handle into the rear bumper opening.

The handle will stop moving and forward resistance to turning will be felt when properly engaged.

2. Turn the handle counterclockwise until tire is lowered to the ground, the tire can be slid rearward and the cable is slightly slack.

3. Remove the retainer from the spare tire.

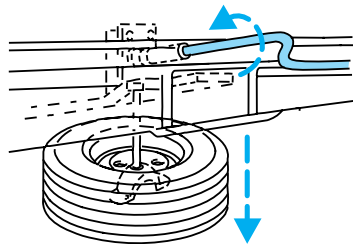

Stowing the spare

1. Lay the tire on the ground with the valve stem facing up.

Roadside emergencies

- Slide the wheel under the vehicle and install the retainer through the wheel center.
- Turn the jack handle clockwise until the tire is raised to its original position underneath the vehicle. The jack handle ratchets when the tire is raised to the stowed position. It will not allow you to overtighten.

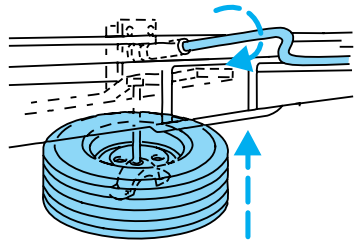

Tire change procedure

-  On vehicles equipped with Air Suspension, turn OFF the Air Suspension switch prior to jacking, hoisting or towing your vehicle.

Refer to the instruction sheet (located behind the interior trim access panel with the jack) for detailed tire change instructions.

- Park on a level surface, activate hazard flashers and set the parking brake.
- Place gearshift lever in P (Park).

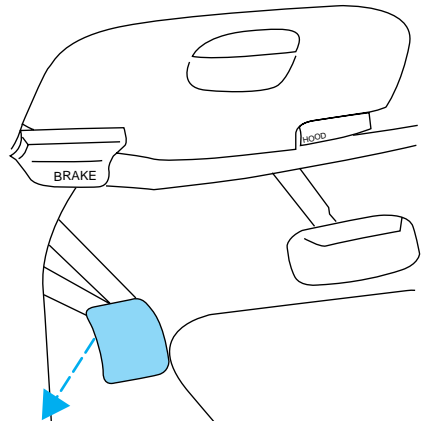

Roadside emergencies

3. Block the diagonally opposite wheel.
4. Obtain the spare tire and jack from their storage locations.
5. Use the tip of the lug wrench to remove any wheel trim.

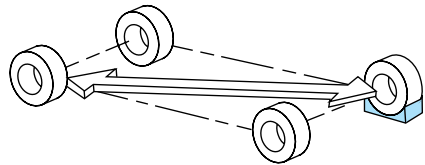

6. Loosen each wheel lug nuts one-half turn counterclockwise but do not remove them until the wheel is raised off the ground.

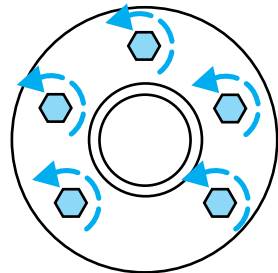

7. Turn OFF the air suspension switch (if equipped).
8. Position the jack according to the following guides and turn the jack handle clockwise until the wheel is completely off the ground.

When one of the rear wheels is off the ground, the transmission alone will not prevent the vehicle from moving or slipping off the jack, even if the transmission is in P (Park). To prevent the vehicle from moving when you change the tire, be sure that the parking brake is set and the diagonally opposite wheel is blocked. If the vehicle slips off the jack, someone could be seriously injured.

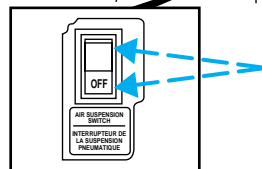
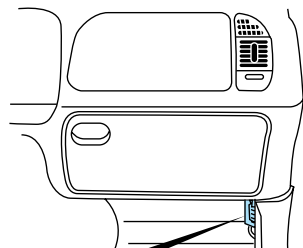

Roadside emergencies

- Front (4x2)

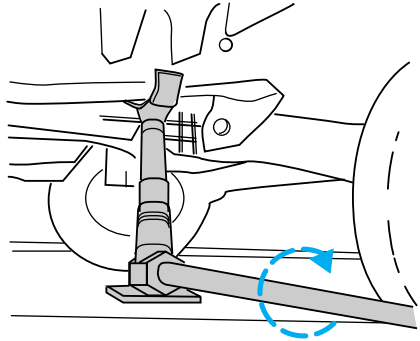

- Front (4x4)

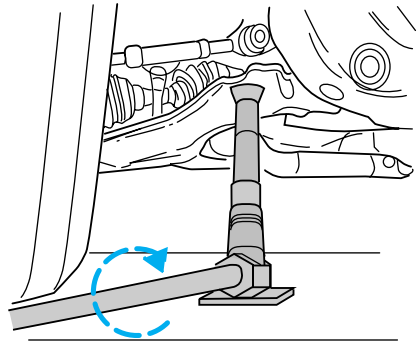

- Rear

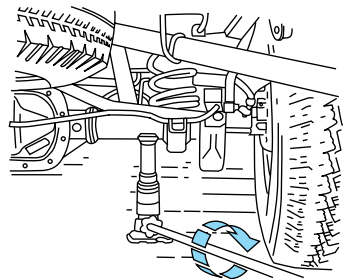

Roadside emergencies

- **Never use the front or rear differential as a jacking point.**

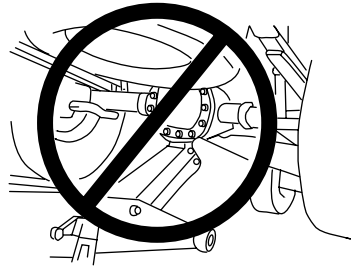

9. Remove the lug nuts with the lug wrench.
10. Replace the flat tire with the spare tire, making sure the valve stem is facing outward. Reinstall the lug nuts until the wheel is snug against the hub. Do not fully tighten the lug nuts until the wheel has been lowered.
11. Lower the wheel by turning the jack handle counterclockwise.

12. Remove the jack and fully tighten the lug nuts in the order shown.

13. Put flat tire, jack and lug wrench away. Make sure the jack is fastened so it does not rattle when you drive.

14. Unblock the wheels.

15. Turn on the air suspension switch (if equipped).

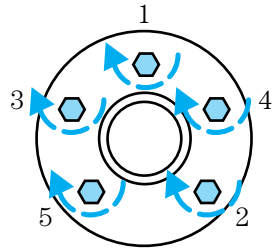

JUMP STARTING YOUR VEHICLE



The gases around the battery can explode if exposed to flames, sparks, or lit cigarettes. An explosion could result in injury or vehicle damage.



Do not push start your vehicle. You could damage the catalytic converter.



Batteries contain sulfuric acid which burns skin, eyes, and clothing.

Preparing your vehicle

Also see the label on the battery.

1. Use only a 12-volt supply to start your vehicle. If you connect your battery to a 24-volt power supply you can damage your starter, ignition system and other electrical components.
2. Do not disconnect the battery of the disabled vehicle as this could damage the vehicle's electrical system.
3. Park the booster vehicle close to the hood of the disabled vehicle making sure they **do not** touch. Set the parking brake on both vehicles and stay clear of the engine cooling fan and other moving parts.

Roadside emergencies

4. Check all battery terminals and remove any excessive corrosion before you attach the battery cables.
5. Turn the heater fan on in both vehicles to protect any electrical surges. Turn all other accessories off.

Connecting the jumper cables

1. Position the vehicles so that they do not touch one another.
2. Switch off the engine. Switch off any unnecessary electrical equipment.
3. Connect the positive (+) terminal of the discharged battery (1) to the positive (+) terminal of the booster battery (2).
4. Connect one end of the second lead to the negative (-) terminal of the booster battery (3) and the other end to a metal part of the engine to be started (4), not to the negative (-) terminal of the discharged battery.
5. Make sure that the jump leads are clear of moving parts of the engine.

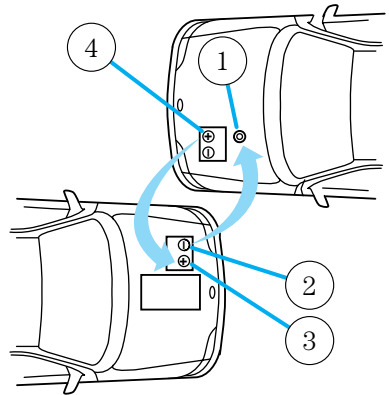

Do not connect the end of the second cable to the negative (-) terminal of the battery to be jumped. A spark may cause an explosion of the gases that surround the battery.

Roadside emergencies

Jump starting

1. Start the booster vehicle and run the engine at moderately increased speed.
2. Start the engine of the vehicle with the discharged battery.
3. Once the engine has been started, run both vehicles for a further three minutes before disconnecting the leads.

Removing the jumper cables

1. Remove the jumper cables in reverse order. Take the cable off the metallic surface (1) first, followed by the cable on the negative (-) booster battery terminal (2).
2. Remove the cable from the positive (+) terminal of the booster battery (3) and then the discharged battery (4).
3. After the disabled vehicle has been started, allow it to idle for a while so the engine can “relearn” its idle conditions.

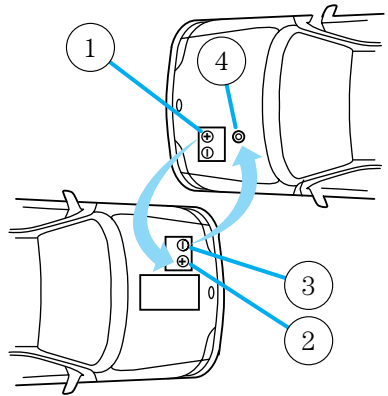

Roadside emergencies

WRECKER TOWING

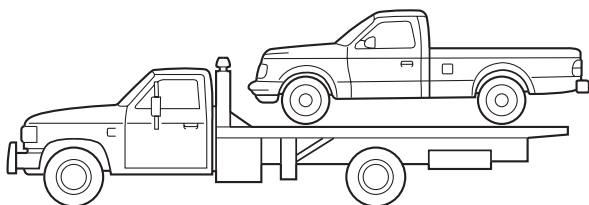
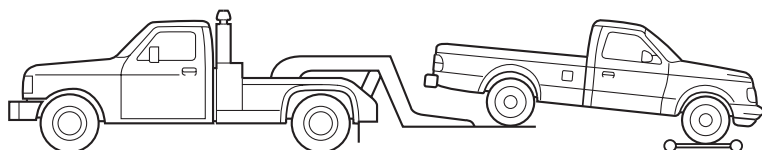
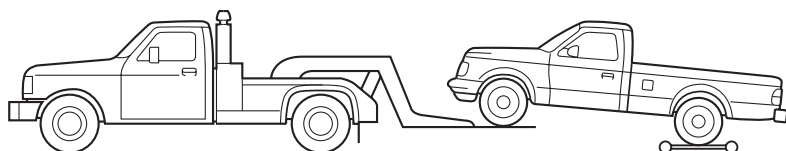

If you need to have your vehicle towed, contact a professional towing service or, if you are a member, your roadside assistance center.

On 4x2 vehicles, it is acceptable to tow the vehicle with the front wheels on the ground and the rear wheels off the ground.

On 4x4 vehicles, it is recommended that your vehicle be towed with a wheel lift or flatbed equipment.

Do not tow with slingbelt equipment. Ford Motor Company has not developed or approved a slingbelt towing procedure.

Roadside emergencies

When calling for a tow truck, tell the operator what kind of vehicle you have. A towing manual is available from Ford Motor Company for all authorized tow truck operators. Have your tow truck driver refer to this manual for proper hook-up and towing procedures for your vehicle.

Maintenance and care

SERVICE RECOMMENDATIONS

To help you service your vehicle:

- We highlight do-it-yourself items in the engine compartment for easy location.
- We provide a “Service Guide” which makes tracking routine service easy.

If your vehicle requires professional service, your dealership can provide necessary parts and service. Check your “Warranty Guide” to find out which parts and services are covered.

Use only recommended fuels, lubricants, fluids and service parts conforming to specifications. Motorcraft parts are designed and built to provide the best performance in your vehicle.

PRECAUTIONS WHEN SERVICING YOUR VEHICLE

Be especially careful when inspecting or servicing your vehicle.

- Do not work on a hot engine.



The cooling fan is automatic and may come on at any time. Always disconnect the negative terminal of the battery before working near the fan.

- When the engine is running, pay attention loose clothing, jewelry or long hair do not get caught up in moving parts.

- Do not work on a vehicle with the engine running in an enclosed space, unless you are sure you have enough ventilation.
- Keep all lit cigarettes, open flames and other lit material away from the battery and all fuel related parts.

If you disconnect the battery, the engine must “relearn” its idle conditions before your vehicle will drive properly, as explained in *Battery* in this chapter.

Working with the engine off

- Automatic transmission:
 1. Set the parking brake fully and ensure the gearshift is securely latched in P (Park).
 2. Turn off the engine and remove the key.
 3. Block the wheels to prevent the vehicle from moving unexpectedly.
- Manual transmission:
 1. Set the parking brake, depress the clutch and place the gearshift in 1 (First).
 2. Turn off the engine and remove the key.
 3. Block the wheels to prevent the vehicle from moving unexpectedly.

Maintenance and care

Working with the engine on

- Automatic transmission:
 1. Set the parking brake fully and ensure the gearshift is securely latched in P (Park).
 2. Block the wheels to prevent the vehicle from moving unexpectedly.



Do not start your engine with the air cleaner removed and do not remove it while the engine is running.

- Manual transmission:
 1. Set the parking brake, depress the clutch and place the gearshift in 1 (First).
 2. Block the wheels to prevent the vehicle from moving unexpectedly.

OPENING THE HOOD

1. Inside the vehicle, pull the hood release handle located under the bottom of the instrument panel.
2. Go to the front of the vehicle and release the auxiliary latch that is located under the front center of the hood. Lift the hood until the lift cylinders hold it open.

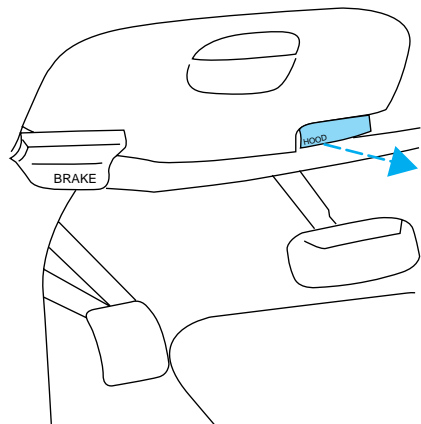

IDENTIFYING COMPONENTS IN THE ENGINE COMPARTMENT

4.2L engine

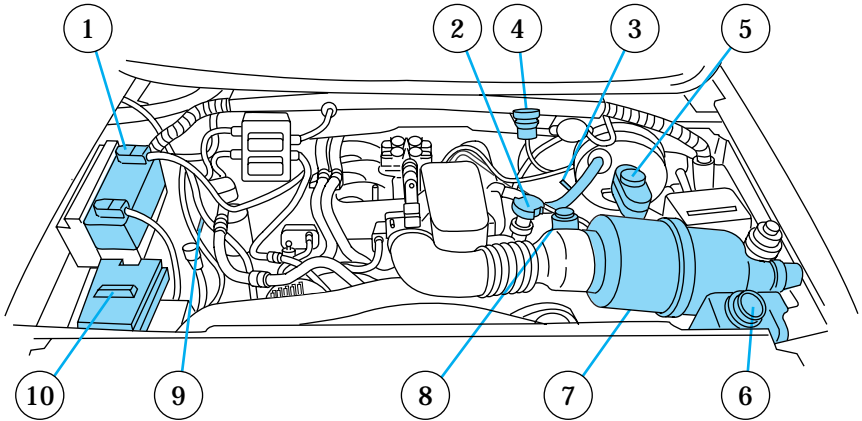

1. Battery
2. Engine oil filler
3. Engine oil dipstick
4. Clutch fluid reservoir (if equipped)
5. Brake fluid reservoir
6. Engine coolant recovery reservoir
7. Air filter assembly
8. Power steering fluid reservoir
9. Transmission fluid dipstick (automatic transmission only)
10. Windshield washer fluid reservoir

Maintenance and care

4.6L/5.4L engines

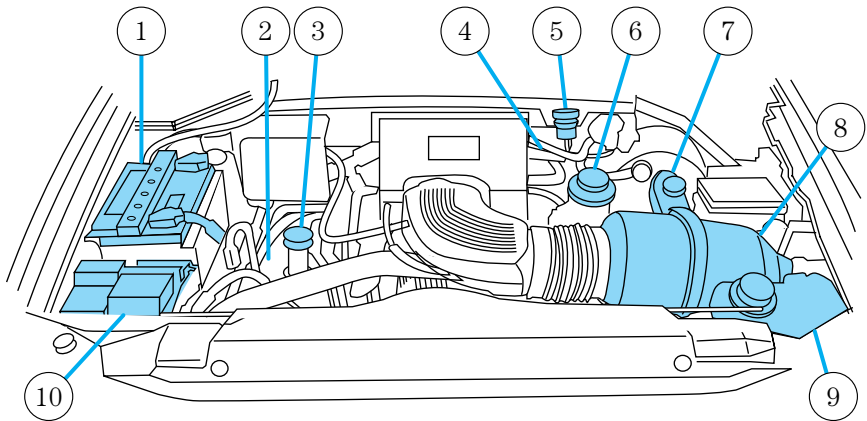

1. Battery
2. Automatic transmission fluid dipstick
3. Engine oil filler
4. Engine oil dipstick
5. Clutch fluid reservoir (if equipped)
6. Power steering fluid reservoir
7. Brake fluid reservoir
8. Air filter assembly
9. Engine coolant recovery reservoir
10. Windshield washer fluid reservoir

ENGINE OIL

Checking the engine oil

Check the engine oil each time you fuel your vehicle.

Maintenance and care

1. Make sure the vehicle is on level ground.
2. Turn the engine off and wait a few minutes for the oil to drain into the oil pan.
3. Set the parking brake and ensure the gearshift is securely latched in P (Park).
4. Open the hood. Protect yourself from engine heat.
5. Locate and carefully remove the engine oil level indicator (dipstick).

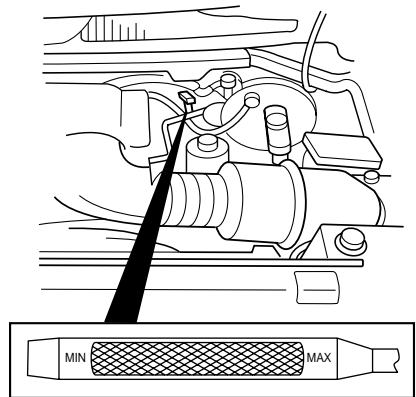

6. Wipe the indicator clean. Insert the indicator fully, then remove it again.

- If the oil level is **between the MIN and MAX marks**, the oil level is acceptable. **DO NOT ADD OIL.**

Maintenance and care

- If the oil level is below the MIN mark, add enough oil to raise the level within the MIN-MAX range.

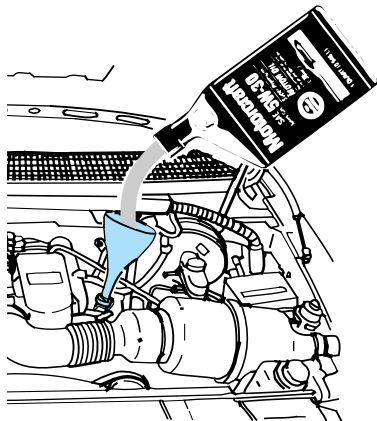

- Oil levels above the MAX mark may cause engine damage. Some oil must be removed from the engine by a service technician.
7. Put the indicator back in and ensure it is fully seated.

Checking the engine oil

Check the engine oil each time you fuel your vehicle.

1. Make sure the vehicle is on level ground.
2. Turn the engine off and wait a few minutes for the oil to drain into the oil pan.
3. Set the parking brake and ensure the gearshift is securely latched in P (Park) (automatic transmission) or 1 (First) (manual transmission).
4. Open the hood. Protect yourself from engine heat.

Maintenance and care

5. Locate and carefully remove the engine oil level indicator (dipstick).

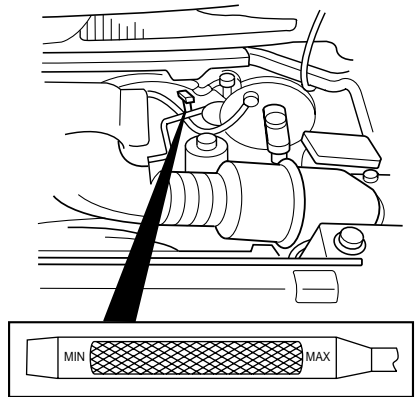

6. Wipe the indicator clean. Insert the indicator fully, then remove it again.

- If the oil level is **between the MIN and MAX marks**, the oil level is acceptable. **DO NOT ADD OIL.**
- If the oil level is below the MIN mark, add enough oil to raise the level within the MIN-MAX range.

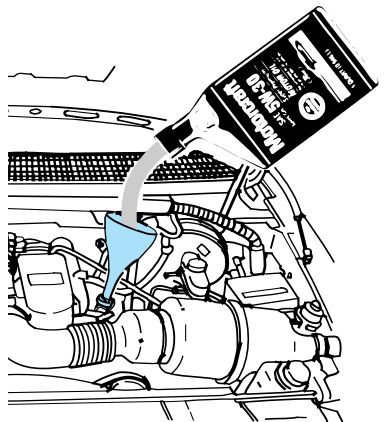

- Oil levels above the MAX mark may cause engine damage. Some

Maintenance and care

oil must be removed from the engine by a service technician.

7. Put the indicator back in and ensure it is fully seated.

Adding engine oil

1. Check the engine oil. For instructions, refer to *Checking the engine oil* in this chapter.
2. If the fluid level is not within the normal range, add only certified engine oil of the preferred viscosity. Add engine oil through the oil filler cap. Remove the filler cap and use a funnel to pour oil in the opening.
3. Recheck the oil level. Make sure the oil level is not above the MAX mark on the dipstick.

Engine oil recommendations

Look for this certification mark.

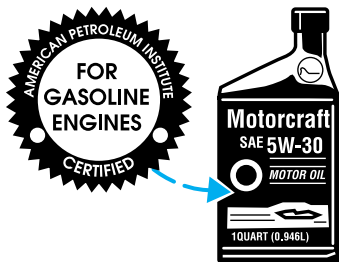

Ford oil specification is WSS-M2C153-G.

Use SAE 5W-30 motor oil certified for gasoline engines by the American Petroleum Institute.

Do not use supplemental engine oil additives, oil treatments or engine treatments. They are unnecessary

and could, under certain conditions, lead to engine damage which is not covered by your warranty.

Changing the engine oil and filter

Change your engine oil and filter according to the following mileage and time requirements, whichever occurs first:

- Normal Schedule – 8,000 km (5,000 miles) or six months.
- Severe Duty Schedule - 5,000 km (3,000 miles) or three months. Severe duty operation would include extensive idling, trailer towing, driving in severe dust and police, taxi or delivery service.

Ford production and aftermarket (Motorcraft) oil filters are designed for added engine protection and long life. If a replacement oil filter is used that does not meet Ford material and design specifications, startup engine noises or knock may be experienced.

It is recommended you use the appropriate Motorcraft oil filter (or another brand meeting Ford specifications) for your engine application.

Maintenance and care

BRAKE FLUID

Checking and adding brake fluid

Brake fluid should be checked and refilled as needed at least once each year:

1. Clean the reservoir cap before removal to prevent dirt or water from entering the reservoir.
2. Visually inspect the fluid level.
3. If necessary, add brake fluid until the level reaches MAX. Do not fill above this line.
4. Use only a DOT 3 brake fluid certified to meet Ford specifications. Refer to *Lubricant specifications* in the *Capacities and specifications* chapter.

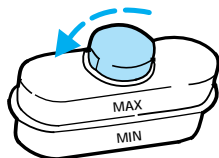
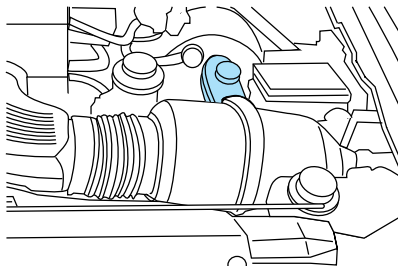

Brake fluid is toxic.



If you use a brake fluid that is not DOT 3, you will cause permanent damage to your brakes.



Do not let the reservoir for the master cylinder run dry. This may cause the brakes to fail.

CLUTCH FLUID (IF EQUIPPED)

During normal operation, the fluid level in the clutch reservoir will slowly rise. If the fluid level drops, maintain the fluid level at the step in the reservoir.

Use only a DOT 3 brake fluid designed to meet Ford specifications. Refer to *Capacities and specifications*.

1. Clean the reservoir cap before removal to prevent dirt and water from entering the reservoir.
2. Remove cap.
3. Add fluid until the level reaches the FULL line.

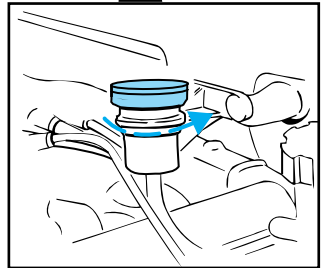
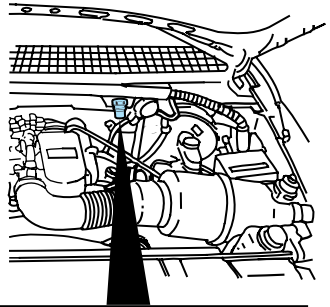

Maintenance and care

WINDSHIELD WASHER FLUID

Checking and adding washer fluid

Check the washer fluid whenever you stop for fuel. The reservoir is highlighted with a  symbol.

If the level is low, add enough fluid to fill the reservoir. In very cold weather, do not fill the reservoir all the way.

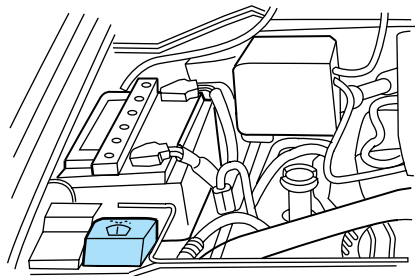

Do not put engine coolant in the container for the windshield washer fluid.

ENGINE COOLANT

Check the level of the coolant in the reservoir at least once a month. Be sure to read and understand *Precautions when servicing your vehicle* in this chapter.

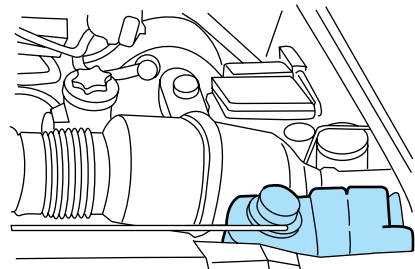

If the engine coolant has not been checked for a long period of time, the engine coolant reservoir may eventually empty. If this occurs, add engine coolant to the coolant reservoir. For more information on engine coolant maintenance, refer to *Adding engine coolant* in this chapter.

Automotive fluids are not interchangeable; do not use engine coolant, antifreeze or windshield washer fluid outside of its specified function and vehicle location.

Adding engine coolant



Do not put engine coolant in the container for the windshield washer fluid.

If sprayed on the windshield, engine coolant could make it difficult to see through the windshield.

When the engine is cool, add a 50/50 mixture of engine coolant and water to the engine coolant recovery reservoir-DO NOT ADD DIRECTLY TO THE RADIATOR. Add straight water only in an emergency, but you should replace it with a 50/50 mixture of coolant and distilled water as soon as possible.

Check the coolant level in the coolant recovery reservoir the next few times you drive the vehicle. If necessary, add enough of a 50/50 mixture of coolant and water to bring the liquid level to the fill line on the reservoir.



Never remove the coolant recovery cap while the engine is running or hot.

If you must remove the coolant recovery cap, follow these steps to avoid personal injury:

Maintenance and care

1. Before you remove the cap, turn the engine off and let it cool.
2. When the engine is cool, wrap a thick cloth around the cap. Slowly turn cap counterclockwise to the first stop.
3. Step back while the pressure releases.
4. When you are sure that all the pressure has been released, use the cloth to press the cap down, turn it counterclockwise and remove it.

Use Ford Premium Cooling System Fluid E2FZ-19549-AA (in Canada, Motorcraft CXC-8-B) or an equivalent premium engine coolant that meets Ford specification ESE-M97B44-A. Ford Premium Engine Coolant is an optimized formula that will protect all metals and rubber elastomers used in Ford cooling systems for four years or 80,000 km (50,000 miles).

Do not use alcohol or methanol antifreeze or any engine coolants mixed with alcohol or methanol antifreeze. Do not use supplemental coolant additives in your vehicle. These additives may harm your engine cooling system. The use of an improper coolant may void your warranty of your vehicle's engine cooling system.

Recycled engine coolant

Ford Motor Company recommends that Ford and Lincoln-Mercury dealers use recycled engine

coolant produced by Ford-approved processes. Not all coolant recycling processes produce coolant which meets Ford specification ESE-M97B44-A, and use of such coolant may harm engine and cooling system components.



Always dispose of used automotive fluids in a responsible manner. Follow your community's regulations and standards for recycling and disposing of automotive fluids.

Coolant refill capacity

To find out how much fluid your vehicle's cooling system can hold, refer to *Refill capacities* in the *Capacities and specifications* chapter.

Have your dealer check the engine cooling system for leaks if you have to add more than a liter (quart) of engine coolant per month.

Severe winter climate

If you drive in extremely cold climates (less than -36°C [-34°F]), it may be necessary to increase the coolant concentration above 50%. Refer to the chart on the coolant container to ensure the coolant concentration in your vehicle is such that the coolant will not freeze at the temperature level in which you drive during winter months. Never increase the engine coolant concentration above 60%.

Maintenance and care

Leave a 50/50 mixture of engine coolant and water in your vehicle year-round in non-extreme climates.

What you should know about fail-safe cooling (if equipped)

If the engine coolant supply is depleted, this feature allows the vehicle to be driven temporarily before incremental component damage is incurred. The “fail safe” distance depends on ambient temperatures, vehicle load and terrain.

How fail-safe cooling works

If the engine overheats, the engine will automatically switch from eight to alternating four cylinder operation. Each disabled cylinder acts as an air pump and cools the engine.

When this occurs, the engine coolant temperature gauge will move into the red area and the  light illuminates.

The service engine soon light will illuminate, indicating that vehicle service is required.

The vehicle will still operate, but will have limited engine power and no air conditioning capability.

Continued operation will increase engine temperature and cause the engine to completely shut down. The vehicle will coast to a stop.

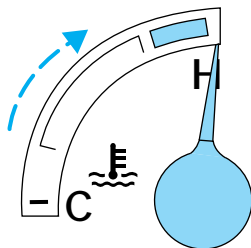

As the engine temperature cools, the engine may be re-started. Take your vehicle to a service facility as soon as possible to minimize engine damage.

When fail-safe mode is activated

- Pull off the road as soon as possible.
- Immediately turn the engine off to prevent severe engine damage.
- Wait for the engine to cool.
- Check the coolant level.

CHECKING AND ADDING POWER STEERING FLUID

Check the power steering fluid at least twice a year. If adding fluid is necessary, use only MERCON® ATF power steering fluid.

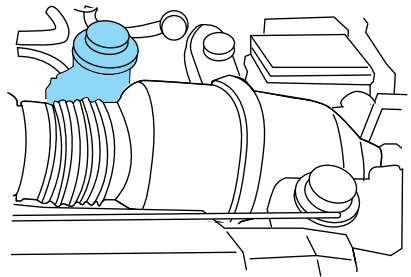

1. Start the engine and let it run until it reaches normal operating temperature (the engine coolant temperature gauge will be near the center of the NORMAL band).
2. While the engine idles, turn the steering wheel left and right several times.
3. Turn the engine off.

Maintenance and care

4. Check the fluid level in the reservoir. It should be between the MIN and MAX lines. Do not add fluid if the level is in this range.

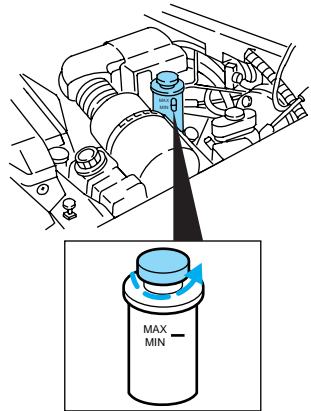

5. If the fluid is low, add fluid in small amounts, continuously checking the level until it reaches the range between the MIN and MAX lines. Be sure to put the cap back on the reservoir.

TRANSMISSION FLUID

Checking and adding automatic transmission fluid

Follow the scheduled service intervals outlined in the “Service Guide.”

Before adding any fluid, make sure the correct type is used. The type of fluid used is normally indicated on the dipstick and/or dipstick handle and also in the *Lubricant specifications* section in the *Capacities and specifications* chapter.

An overfill condition of transmission fluid may cause shift and/or engagement

Maintenance and care

concerns and/or possible damage.

Do not drive the vehicle if the fluid level is below the hole at the bottom of the blade type dipstick (4R70W transmission) or below the COLD area on the bullet type dipstick (E4OD transmission) and outside temperatures are above 10°C (50°F) (see figure to the right).

Your transmission does not use up fluid. However, it is recommended that you check the transmission fluid at least twice a year. The fluid level should be checked if the transmission is not working properly, i.e., if the transmission slips or shifts slowly or if you notice some sign of fluid leakage.

Transmission fluid should be checked at normal operating temperatures 66°C-77°C (150°F-170°F) on a level surface. The normal operating temperature can be reached after approximately 32 km (20 miles) of driving.

The transmission fluid should be in this range if at normal operating temperature (66°C-77°C [150°F-170°F]) (see figure to the right).

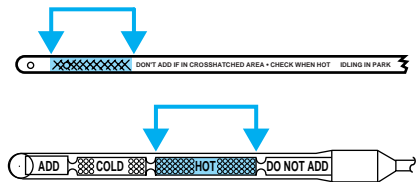
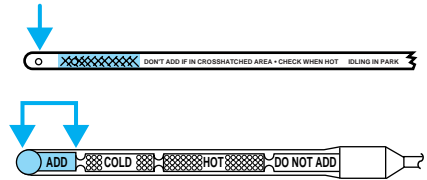

Maintenance and care

The transmission fluid should be in this range if at room temperature (10°C-35°C [50°F-95°F]) (see figure to the right).

If your vehicle has been operated for an extended period at high speeds, in city traffic during hot weather or pulling a trailer, the vehicle should be turned off for about 30 minutes to allow the fluid to cool before checking.

1. Park the vehicle on a level surface and engage the parking brake.

2. With the parking brake engaged and your foot on the brake pedal, start the engine and move the gearshift lever through all of the gear ranges. Allow sufficient time for each gear to engage.

3. Latch the gearshift lever in P (Park) and leave the engine running.

4. Remove the dipstick, wiping it clean with a clean, dry lint free rag.

5. Install the dipstick making sure it is fully seated in the filler tube.

6. Remove the dipstick and inspect the fluid level. The fluid level should be in the crosshatched area on the dipstick.

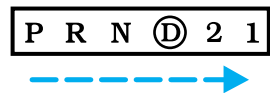
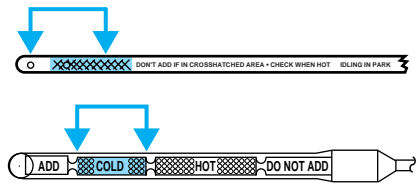

- If necessary, add fluid in .25L (1/2 pint) increments through the filler tube until the level is correct.
- If an overfill occurs, excess fluid should be removed by a qualified technician.

An overfill condition of transmission fluid may cause shift and/or engagement concerns and/or possible damage.

If the fluid level is above the top notch of the hot range after driving the vehicle for approximately 30 km (20 miles), excess fluid should be removed by a qualified technician.

Checking and adding manual transmission fluid

- Clean the filler plug.
- Remove the filler plug and inspect the fluid level.

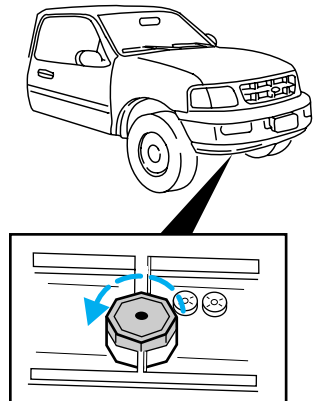
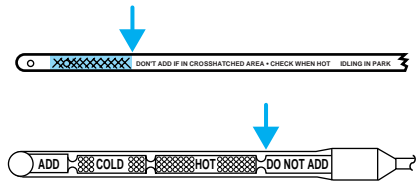

Maintenance and care

3. Fluid level should be at bottom of the opening.
4. Add enough fluid through the filler opening so that the fluid level is at the bottom of the opening.
5. Install and tighten the fill plug.

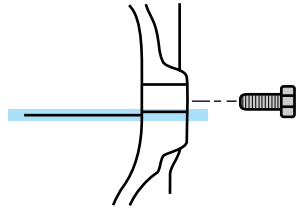

Use only fluid that meets Ford specifications. Refer to the *Capacities and specifications* chapter.

Checking and adding transfer case fluid

1. Clean the filler plug.
2. Remove the filler plug and inspect the fluid level.

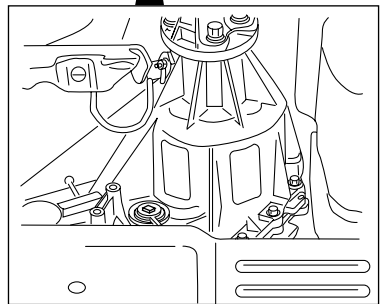
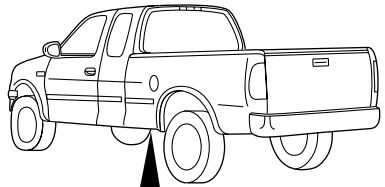

Maintenance and care

3. Add only enough fluid through the filler opening so that the fluid level is at the bottom of the opening.

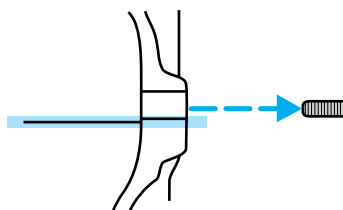

Use only fluid that meets Ford specifications. Refer to the *Capacities and specifications* chapter.

DRIVELINE UNIVERSAL JOINT AND SLIP YOKE

The universal joints standard with your vehicle do not require lubrication. If the original universal joints are replaced with universal joints equipped with grease fittings, lubrication will be necessary.

BATTERY

Your vehicle may be equipped with a Motorcraft maintenance-free battery. If the original equipment battery needs replacing, it may be replaced with a low-maintenance battery. The low-maintenance battery normally does not require additional water during its life of service. However, for severe usage or in high temperature climates, check your battery electrolyte level, at least every 24 months or 40,000 km (24,000 miles). Keep

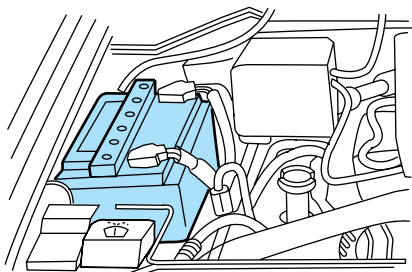

Maintenance and care

the electrolyte in each cell up to the “level” indicator. Do not overfill the battery cells.

If the electrolyte level in the battery is low, you can add plain tap water to the battery, as long as you do not use hard water (water with a high alkali content). If possible, however, try to only fill the battery cells with distilled water. If the battery needs water often, have the charging system checked.

For longer, trouble-free operation, keep the top of the battery clean and dry. Also, make certain the battery cables are always tightly fastened to the battery terminals.

If you see any corrosion on the battery or terminals, remove the cables from the terminal(s) and clean with a wire brush. You can neutralize the acid with a solution of baking soda and water. Reinstall the cables when you are done cleaning them, and apply a small quantity of grease to the top of each battery terminal to help prevent corrosion.

If your battery has a cover/shield, make sure it is reinstalled after the battery is replaced.

Because your vehicle’s engine is electronically controlled by a computer, some control conditions are maintained by power from the battery. When the battery is disconnected or a new battery is installed, the engine must relearn

its idle conditions before your vehicle will drive properly. To begin this process:

1. Put the gearshift in P (Park) (automatic transmissions) or the neutral position (manual transmissions), turn off all accessories and start the vehicle.
 2. Let the engine idle for at least one minute.
 3. The relearning process will automatically complete as you drive the vehicle.
- If you do not allow the engine to relearn its idle, the idle quality of your vehicle may be adversely affected until the idle is eventually relearned.
 - If the battery has been disconnected or a new battery has been installed, the clock and the preset radio stations must be reset once the battery is reconnected.
 - Always dispose of automotive batteries in a responsible manner. Follow your communities standards for disposal. Call your local recycling center to find out more about recycling automotive batteries.



WINDSHIELD WIPER BLADES

Check the wiper blades at least twice a year or when they seem less effective. Substances such as tree sap and some hot wax

Maintenance and care

treatments used by commercial car washes reduce the effectiveness of wiper blades.

Checking the wiper blades

If the wiper blades do not wipe properly, clean both the windshield and wiper blades using undiluted windshield wiper solution or a mild detergent. Rinse thoroughly with clean water. To avoid damaging the blades, do not use fuel, kerosene, paint thinner or other solvents.

Changing the wiper blades

When replacing wiper blade assemblies, always use a Motorcraft part or equivalent. To make replacing the wipers easy, turn the ignition to ACC, then turn the wipers on. When the wipers reach the vertical position, turn the ignition to LOCK.

To replace the wiper blades:

1. Pull the wiper arm away from the windshield and lock into the service position.
2. Turn the blade at an angle from the wiper arm. Push the lock pin with a screwdriver to release the blade and pull the wiper blade down toward the windshield to remove it from the arm.
3. Attach the new wiper to the wiper arm and press it into place until a click is heard.

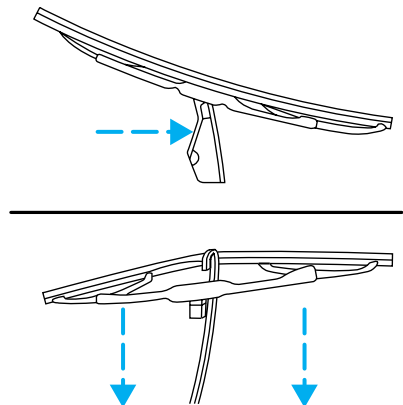

INFORMATION ABOUT TIRE QUALITY GRADES

New vehicles are fitted with tires that have their Tire Quality Grade (described below) molded into the tire's sidewall. These Tire Quality Grades are determined by standards that the United States Department of Transportation has set.

Tire Quality Grades apply to new pneumatic tires for use on passenger cars. They do not apply to deep tread, winter-type snow tires, space-saver or temporary use spare tires, tires with nominal rim diameters of 10 to 12 inches or limited production tires as defined in Title 49 Code of Federal Regulations Part 575.104(c)(2).

U.S. Department of Transportation-Tire quality

grades: The U.S. Department of Transportation requires Ford to give you the following information about tire grades exactly as the government has written it.

Treadwear

The treadwear grade is a comparative rating based on the wear rate of the tire when tested under controlled conditions on a specified government test course. For example, a tire grade 150 would wear one and one-half (1 1/2) times as well on the government course as a tire grade 100. The relative performance of

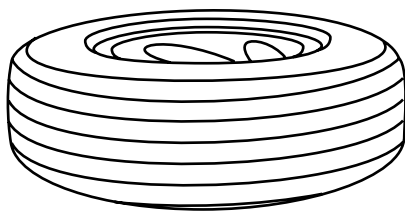

Maintenance and care

tires depends upon the actual conditions of their use, however, and may depart significantly from the norm due to variations in driving habits, service practices, and differences in road characteristics and climate.

Traction A B C

The traction grades, from highest to lowest are A, B, and C, and they represent the tire's ability to stop on wet pavement as measured under test surfaces of asphalt and concrete. A tire marked C may have poor traction performance.



The traction grade assigned to this tire is based on braking (straight ahead) traction tests and does not include cornering (turning) traction.

Temperature A B C

The temperature grades are A (the highest), B, and C, representing the tire's resistance to the generation of heat and its ability to dissipate heat when tested under controlled conditions on a specified indoor laboratory test wheel. Sustained high temperature can cause the material of the tire to degenerate and reduce tire life, and excessive temperature can lead to sudden tire failure. The grade C corresponds to a level of performance which all passenger car tires must meet under the

Federal Motor Vehicle Safety Standard No. 109. Grades B and A represent higher levels of performance on the laboratory test wheel than the minimum required by law.



The temperature grade for this tire is established for a tire that is properly inflated and not overloaded. Excessive speed, underinflation, or excessive loading, either separately or in combination, can cause heat buildup and possible tire failure.

SERVICING YOUR TIRES

Checking the tire pressure

- Use an accurate tire pressure gauge.
- Check the tire pressure when tires are cold, after the vehicle has been parked for at least one hour or has been driven less than 5 km (3 miles).
- Adjust tire pressure to recommended specifications found on the Safety Compliance Certification Label.



Improperly inflated tires can affect vehicle handling and can fail suddenly, possibly resulting in loss of vehicle control.

Maintenance and care

Tire rotation

Because your vehicle's tires perform different jobs, they often wear differently. To make sure your tires wear evenly and last longer, rotate them as indicated in the "Service Guide." If you notice that the tires wear unevenly, have them checked.

- Four tire rotation

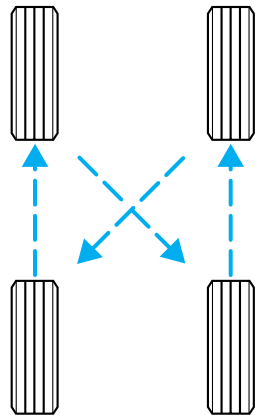

- Five tire rotation

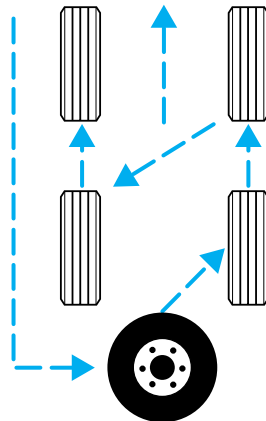

Replacing the tires

Replace the tires when the wear band is visible through the tire treads.

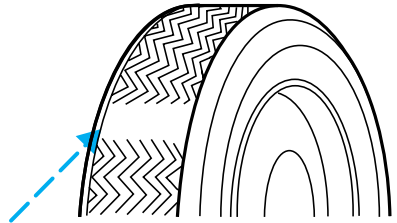

Failure to follow these precautions may adversely affect the handling of the vehicle and make it easier to lose control and roll over.

Tires that are larger or smaller than your vehicle's original tires may also affect the accuracy of your speedometer.

SNOW TIRES AND CHAINS



Snow tires must be the same size and grade as the tires you currently have on your vehicle.

The tires on your vehicle have all weather treads to provide traction in rain and snow. However, in some climates, you may need to use snow tires and chains. If you need to use snow tires and chains, you must install steel wheels of the same size and specifications as those originally installed.

Maintenance and care

Follow these guidelines when using snow tires and chains:

- Use only SAE Class S chains.
- Install chains securely, verifying that the chains do not touch any wiring, brake lines or fuel lines.
- Drive cautiously. If you hear the chains rub or bang against your vehicle, stop and re-tighten the chains. If this does not work, remove the chains to prevent damage to your vehicle.
- If possible, avoid fully loading your vehicle.
- Do not use tire chains on aluminum wheels. Chains may chip the wheels.
- Remove the tire chains when they are no longer needed. Do not use tire chains on dry roads.
- The suspension insulation and bumpers will help prevent vehicle damage. Do not remove these components from your vehicle when using snow tires and chains.

WHAT YOU SHOULD KNOW ABOUT AUTOMOTIVE FUELS

Important safety precautions



Do not overfill the fuel tank. The pressure in an overfilled tank may cause leakage and lead to fuel spray and fire.

Maintenance and care

 If you do not use the proper fuel cap, the pressure in the fuel tank can damage the fuel system or cause it to work improperly in a collision.

 The fuel system may be under pressure. If the fuel cap is venting vapor or if you hear a hissing sound, wait until it stops before completely removing the cap.

 Automotive fuels can cause serious injury or death if misused or mishandled.

Observe the following guidelines when handling automotive fuel:

- Extinguish all smoking materials and any open flames before fueling your vehicle.
- Always turn off the vehicle before fueling.
- Automotive fuels can be harmful or fatal if swallowed. If fuel is swallowed, call a physician immediately, even if no symptoms are immediately apparent. The toxic effects of fuel may not be visible for hours.
- Fuels can also be harmful if absorbed through the skin. If fuel is splashed on the skin,

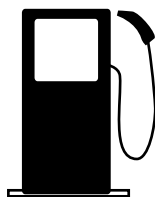

Maintenance and care

promptly remove contaminated clothing and wash skin thoroughly with soap and water.

- If fuel is splashed in the eyes, remove contact lenses, flush with water for 15 minutes and seek medical attention.
- Be particularly careful if you are taking “Antabuse” or other forms of disulfiram for the treatment of alcoholism. Breathing gasoline vapors or skin contact could cause an adverse reaction. Consult a physician immediately.

Choosing the right fuel

Use only UNLEADED FUEL. The use of leaded fuel is prohibited by law and could damage your vehicle.

Your vehicle was not designed to use fuel or fuel additives with metallic compounds, including manganese-based compounds containing MMT.

Vehicles certified to California emission standards (indicated on the underhood Vehicle Emissions Control Information label) are designed to operate on California reformulated gasolines. If California reformulated gasoline is not available when you refuel, your vehicle can be operated on non-California fuels. However, even though your engine will perform adequately on other gasolines, the performance of the emission

control devices and systems may be adversely affected.

Repair of damage caused by using a fuel that your vehicle was not designed for may not be covered by your warranty.

Octane recommendations

Your vehicle is designed to use regular unleaded with an (R+M)/2 octane rating of 87. We do not recommend gasolines labeled as “regular” in high altitude areas that are sold with octane ratings of 86 or even less.

Do not be concerned if your vehicle sometimes knocks lightly. However, if it knocks heavily under most driving conditions on fuel with the recommended octane, see your dealer or a qualified service technician to prevent any engine damage.

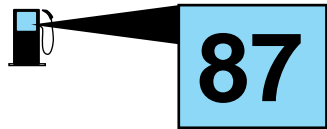

Fuel quality

If you are experiencing starting, rough idle or hesitation problems try a different brand of fuel. If the condition persists, see your dealer or a qualified service technician.

The American Automobile Manufacturers Association (AAMA) issued a gasoline specification to provide information on high quality fuels that optimize the performance of your vehicle. We recommend the use of gasolines that meet the AAMA specification if they are available.

Maintenance and care

It should not be necessary to add any aftermarket products to your fuel tank if you continue to use a high-quality fuel.

Cleaner air

Ford approves the use of gasolines to improve air quality, including reformulated gasolines that contain oxygenates up to 10% ethanol or 15% MTBE.

Do not use gasolines containing methanol, which can damage critical fuel system components. Damage resulting from the use of methanol may not be covered by your warranty.

Calculating fuel economy

To accurately calculate your vehicle's fuel economy:

1. Fill the tank completely and record the initial odometer reading.
2. Each time you fill the tank, record the amount of fuel added (in liters or gallons).
3. After at least three to five fuel tank fill-ups, fill the fuel tank and record the current mileage reading.
4. Use one of the following equations to calculate fuel economy.

Liters used \times 100 \div Total kilometers traveled

Total miles traveled \div Total gallons used

Keep a record for at least one month. This will provide an accurate estimate of the vehicle's fuel economy.

EMISSION CONTROL SYSTEM

Your vehicle is equipped with various emission control components and a catalytic converter which will enable your vehicle to comply with applicable exhaust emission standards. To make sure that the catalytic converter and other emission control components continue to work properly:

- Use only unleaded fuel.
- Avoid running out of fuel.
- Do not turn off the ignition while your vehicle is moving, especially at high speeds.
- Have the services listed in your "Service Guide" performed according to the specified schedule.

The Scheduled Maintenance Services listed in the "Service Guide" are required because they are considered essential to the life and performance of your vehicle and to its emissions system.

If other than Ford, Motorcraft or Ford authorized parts are used for maintenance replacements or for service of components affecting emission control such non-Ford parts should be equivalent to genuine Ford Motor Company

Maintenance and care

parts in performance and durability.



Do not park, idle, or drive your vehicle in dry grass or other dry ground cover. The emission system heats up the engine compartment and exhaust system, which can start a fire.

Watch for fluid leaks, strange odors, smoke, loss of oil pressure, the charging system warning light, the “Check Engine” light or the temperature warning light. These events could indicate that the emission control system is not working properly.



If you smell exhaust fumes of any kind inside your vehicle, have the dealer inspect and fix your vehicle immediately. Do not drive if you smell exhaust fumes. These fumes are harmful and could kill you.

Do not make any unauthorized changes to your vehicle or engine. By law, vehicle owners and anyone who manufactures, repairs, services, sells, leases, trades vehicles, or supervises a fleet of vehicles are not permitted to intentionally remove an emission control device or prevent it from working. Information about your vehicle's emission system is on the Vehicle Emission Control Information Decal located on or near the engine. This decal

identifies engine displacement and gives some tune up specifications.

Please consult your “Warranty Guide” for complete emission warranty information.

Readiness for inspection/maintenance (I/M) testing

In some localities, it may be a legal requirement to pass an I/M test of the on-board diagnostic (OBD-II) system. If your “check engine/service engine soon” light is on, reference the applicable light description in the *Warning Lights and Chimes* section of your owners guide. Your vehicle may not pass the I/M test with the “check engine/service engine soon” light on.

If the vehicle’s powertrain system or its battery has just been serviced, the OBD-II system is reset to a “not ready for I/M test” condition. To ready the OBD-II system for I/M testing, a minimum of 30 minutes of city and highway driving is necessary as described below:

- First, at least 10 minutes of driving on an expressway or highway.
- Next, at least 20 minutes driving in stop and go, city type traffic with at least four idle periods.

Allow the vehicle to sit for at least eight hours without starting the engine. Then, start the engine and

Maintenance and care

complete the above driving cycle. The engine must warm up to its normal operating temperature. Once started, do not turn off the engine until the above driving cycle is complete.

EXTERIOR BULBS

Replacing exterior bulbs

Check the operation of the following lamps frequently:

- headlamps
- foglamps (if equipped)
- high-mount brakelamp
- brakelamps
- turn signals
- license plate lamp
- tail lamps
- back-up lamps

Do not remove lamp bulbs unless they can be replaced immediately with new ones. If a bulb is removed for an extended period of time, contaminants may enter the lamp housings and affect lamp performance.

Replacing headlamp bulbs



Handle a halogen headlamp bulb carefully and keep out of children's reach. Grasp the bulb only by its plastic base and do not touch the glass. The oil from your hand could cause the bulb to break the next time the headlamps are operated.

1. Make sure that the headlamp control is in the OFF position.
2. Open the hood.
3. At the back of the headlamp, pull clips rearward and up (about $\frac{3}{4}$ ") to release the headlamp assembly.
4. Slide headlamp assembly forward and off of guide ribs to expose the back of the bulb and wiring connector.
5. Remove the electrical connector from the bulb by grasping the wire and pulling it rearward.
6. Remove bulb retainer ring by turning it counterclockwise about $\frac{1}{4}$ turn, then slide the ring off the plastic base.
7. Without turning, carefully pull bulb assembly out of headlamp assembly.

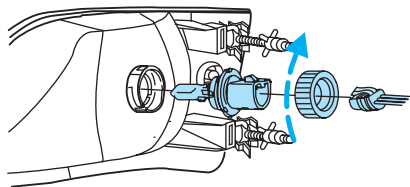
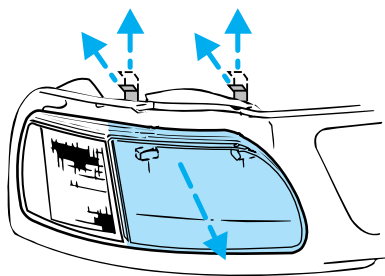

Maintenance and care

8. Insert the glass end of the new bulb into the headlamp assembly socket. When the grooves in the plastic base are aligned, push the bulb into the socket until the plastic base contacts the rear of the socket.
9. Slip bulb retaining ring over the plastic base and lock the ring into the socket by turning it clockwise until you feel a “stop.”
10. Push the electrical connector into the rear of the plastic base until it “snaps.”
11. Straighten alignment pins, making them parallel with the outer edges of the attachment standoff.
12. Carefully insert the headlamp assembly into the vehicle making sure the alignment pins are inserted into the proper holes and into the guide ribs.
13. Hold the headlamp assembly snugly against the vehicle and push down on the clips to lock the lamp into position.

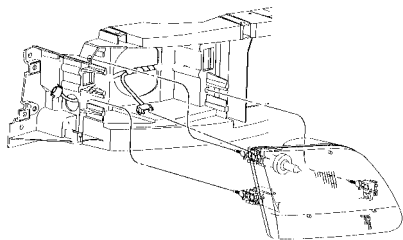

Replacing parking lamp/turn signal bulbs

1. Remove screw from the top of lamp assembly.
2. Disengage lamp assembly (it has a snap fit).

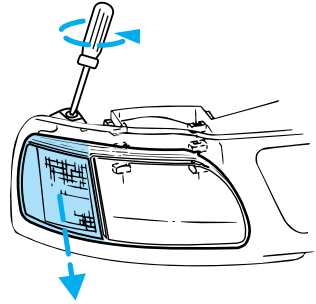

3. Remove the electrical connector from the bulb by grasping the wire and pulling it rearward.
4. Remove bulb retainer ring by turning it counterclockwise about 1/4 turn, then slide the ring off the plastic base.
5. Without turning, carefully pull bulb assembly out of parking lamp assembly.

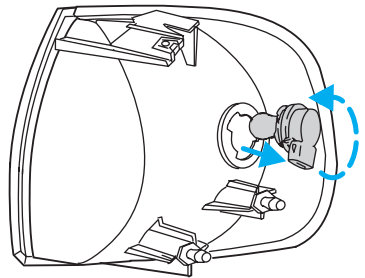

6. Insert the glass end of the new bulb into the parking lamp assembly socket. When the grooves in the plastic base are aligned, push the bulb into the socket until the plastic base contacts the rear of the socket.
7. Slip bulb retaining ring over the plastic base and lock the ring into the socket by turning it clockwise until you feel a "stop."
8. Push the electrical connector into the rear of the plastic base until it "snaps."

Maintenance and care

9. Align top and bottom ribs of parking lamp assembly with corresponding slots on front of vehicle.
10. Push gently until parking lamp assembly seats (you will hear a snap).
11. Replace screw removed in step 1.

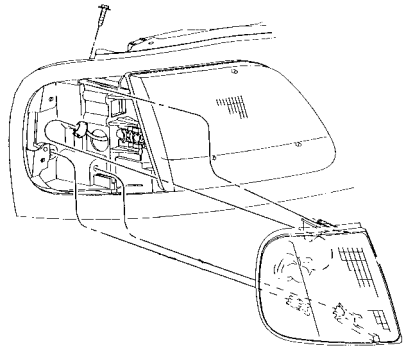

Replacing foglamp bulbs

1. Disconnect the electrical connector from the back of the foglamp assembly.
2. Twist, then pull the bulb from the foglamp assembly.
3. Install the new bulb.
4. Connect the electrical connector to the back of the foglamp assembly.

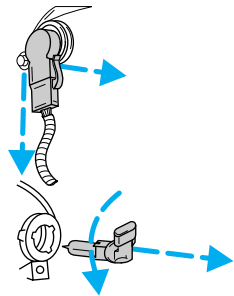

Replacing license plate lamp bulbs

The license plate bulbs are located under and behind the rear bumper. To change the license plate lamp bulbs:

1. Reach under and behind the rear bumper to locate the bulb connector.
2. Twist the connector counterclockwise $\frac{1}{4}$ turn and carefully pull to remove it.
3. Pull out the old bulb and press in the replacement bulb.
4. Replace the connector by placing it back into the assembly and turning it $\frac{1}{4}$ turn clockwise.

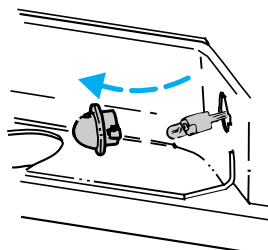

Using the right bulbs

Function	Number of bulbs	Trade number
Front park/turn lamps	2	3157 NAK
Fog lamps	2	9006
Headlamps	2	9007
Rear turn/sidemarker	2	3157 NAK
To replace all instrument panel lights - see your dealer		

AIMING THE HEADLAMPS

The alignment of your headlamps should be checked by a qualified service technician if:

Maintenance and care

- Oncoming motorists frequently signal you to deactivate your high beams, and your high beams are not activated.
- The headlamps do not seem to provide enough light for clear night vision.
- The headlamp beams are pointed substantially away from a slightly down and to the right position.

CLEANING AND CARING FOR YOUR VEHICLE

Refer to the “Customer Assistance Guide” for a list of Ford-approved cleaners, polishes and waxes.

Washing your vehicle

Wash your vehicle regularly with cold or lukewarm water. Never use strong detergents or soap. If your vehicle is particularly dirty, use a quality car wash detergent. Always use a clean sponge, washing glove or similar device and plenty of water for best results. To avoid spots, avoid washing when the hood is still warm, immediately after or during exposure to strong sunlight.

During winter months, it is especially important to wash the vehicle on a regular basis. Large quantities of dirt and road salt are difficult to remove and also cause damage to the vehicle. Remove any exterior accessories, such as

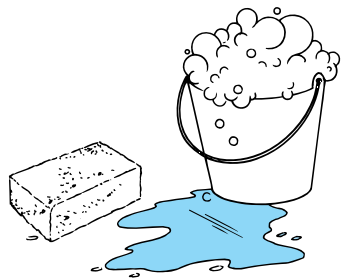

antennas, before entering a car wash.

After washing, apply the brakes several times to dry them.

Waxing your vehicle

Wax when water stops beading on the surface. This could be every three or four months, depending on operating conditions.

Use only carnauba or synthetic-based waxes. Remove any bugs and tar before waxing vehicle. Use cleaning fluid or alcohol with a clean cloth to remove. Use tar remover to remove any tar spots.

Repairing paint chips

Minor scratches or paint damage from road debris may be repaired with touch-up , paint repair foil or aerosol paint spray from the Ford accessory line. Observe the application instructions on the products.

Remove particles such as bird droppings, tree sap, insect remains, tar spots, road salt and industrial fallout immediately.

Cleaning the wheels

Wash with the same detergent as the body of your vehicle. Do not use acid-based wheel cleaners, steel wool, fuel or strong detergents. Never use abrasives that will damage the finish of special wheel surfaces. Use a tar remover to remove grease and tar.

Maintenance and care

Cleaning the engine

Engines are more efficient when they are clean because grease and dirt buildup keep the engine warmer than normal. When washing:

- Take care when using a power washer to clean the engine. The high pressure fluid could penetrate the sealed parts and cause damage.
- Do not spray with cold water to avoid cracking the engine block or other engine components.

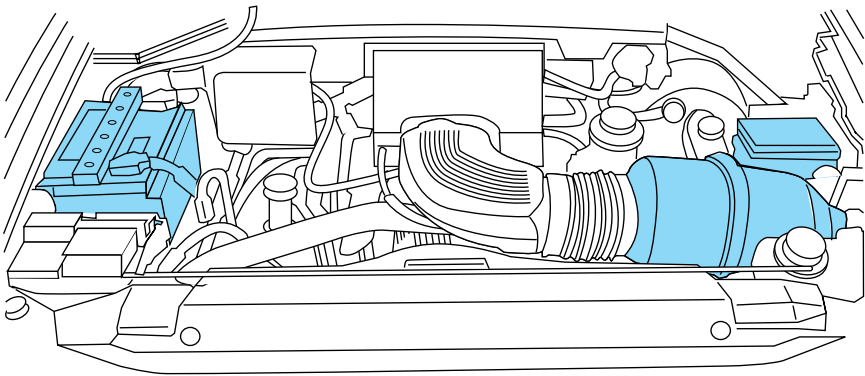

- Cover the highlighted areas to prevent water damage when cleaning the engine.
- Never wash or rinse the engine while it is running; water in the running engine may cause internal damage.

Cleaning plastic exterior parts

Use vinyl cleaner for routine cleaning. Clean with a tar remover if necessary. Do not clean plastic parts with thinners, solvents or petroleum-based cleaners.

Cleaning the exterior lamps

Wash with the same detergent as the exterior of your vehicle. Use glass cleaner or tar remover if necessary.

To avoid scratching the lamps, do not use a dry paper towel, chemical solvents or abrasive cleaners.

Cleaning the wiper blades

If the wiper blades do not wipe properly, clean the windshield and wiper blades with undiluted windshield wiper solution or a mild detergent. Rinse thoroughly with clean water. To avoid damaging the blades, do not use fuel, kerosene, paint thinner or other solvents.

Cleaning the instrument panel

Clean with a damp cloth, then dry with a dry cloth.

Avoid cleaner or polish that increases the gloss of the upper portion of the instrument panel. The dull finish in this area helps protect the driver from undesirable windshield reflection.

Cleaning the interior fabric

Remove dust and loose dirt with a whisk broom or a vacuum cleaner.

Maintenance and care

Remove fresh spots immediately. Follow the directions that come with the cleaner.

Cleaning and maintaining the safety belts

Clean the safety belts with a mild soap solution recommended for cleaning upholstery or carpets. Do not bleach or dye the belts, because these actions may weaken the belt webbing.

Check the safety belt system periodically to make sure there are no nicks, wear or cuts. If your vehicle has been involved in an accident, refer to the *Safety belt maintenance* section in the *Seating and safety restraints* chapter.

Cleaning leather seats (if equipped)

For routine cleaning, wipe the surface with a soft, damp cloth. For more thorough cleaning, wipe the surface with a mild soap.

If the leather cannot be completely cleaned using a mild soap and water solution, the leather may be cleaned using a commercially available cleaning product “Tanners Preserve Leather Cleaner” and a 3M “Type T” scrubbing pad by using the following steps;

The type of scrubbing pad is very critical because the common 3M “Scotch Brite” green pad is too aggressive and

will damage the leather surface

- Spray a small amount of the leather cleaner on the pad and rub the area to be cleaned with the pad using a circular motion. Only clean 1/4 of the area at a time. For heavily soiled areas, spray the cleaner directly onto the leather (two squirts should be adequate) and rub with the pad. Repeat if necessary.
- Use a soft, damp cloth to remove the loosened dirt and foam.
- Dry with a soft cloth.

Do not use household cleaners, glass cleaner, alcohol solutions or cleaner intended for vinyl, rubber or plastics. These products can damage the leather.

In some instances, color or dye transfer can occur when wet clothing (wool, denim, leathers or other non-colorfast garments) comes in contact with leather upholstery. If this occurs, the leather should be cleaned immediately to avoid permanent staining.

“Tanners Preserve Leather Cleaner” (product number AS-300) is available from “First Brands” by calling 1-800-726-1001. This product may also be available at many local automotive after market stores.

3M “Type T” Clean And Finish Scrubbing Pads (UPC

Maintenance and care

04011-01276) are available through your local 3M distributor. Call 1-800-742-9649 for the nearest distributor in your area.

PART NUMBER	PART NAME
(Obtain Locally)	Tanners Preserve Leather Cleaner
(Obtain Locally)	3M "Type T" Clean and Finish Scrubbing Pads

Capacities and specifications

MOTORCRAFT PART NUMBERS

Component	4.2L engine	4.6L engine	5.4L engine
Spark plugs-platinum*	AGSF-34EE	AWSF-32PP	AWSF-22E
Air filter	FA-1632	FA-1632	FA-1632
Fuel filter	FG-872	FG-872	FG-872
Oil filter	FL-400-S	FL-820-S	FL-820-S
PCV valve	EV-152	EV-98	EV-233
Battery (manual transmission)	BXT-59	BXT-59	BXT-59
Battery (automatic transmission)	BXT-65-750	BXT-65-750	BXT-65-750

Refer to Vehicle Emissions Control Information (VECI) decal for spark plug gap information.

REFILL CAPACITIES

Fluid	Ford Part Name	Application	Capacity
Front axle	Motorcraft SAE 75W90 Front Axle Lubricant	4x4 vehicles	1.8-2.0L (3.5-3.7 pints)
Rear axle ^{1, 4}	Motorcraft SAE 75W140 Synthetic Rear Axle Lubricant	F-150	2.6-2.7L (5.5-5.8 pints)

Capacities and specifications

Fluid	Ford Part Name	Application	Capacity
Rear axle ^{2,4}	Motorcraft SAE 75W140 Synthetic Rear Axle Lubricant	F-250	3.3-3.8L (7.5-8.0 pints) ⁵
Brake fluid	Ford High Performance DOT 3 Brake Fluid	All	Fill to line in reservoir
Engine coolant	Ford Premium Cooling System Fluid	4.2L w/o A/C	14.9L (15.7 quarts)
		4.2L with A/C	16.4L (17.3 quarts)
		4.6L and 5.4L w/o A/C	16.9L (17.9 quarts)
		4.6L and 5.4L with A/C	18.4L (19.4 quarts)
Engine oil (includes filter change)	Motorcraft 5W30 Super Premium Motor Oil	All	5.7L (6.0 quarts)
Fuel tank	N/A	4x4 Reg. Cab	92.7L (24.5 gallons)
		4x2 Regular Cab and all SuperCab	94.6L (25.0 gallons)
		Long Wheelbase	113.6L (30.0 gallons)
Power steering fluid	Motorcraft MERCON® ATF	All	Fill to line in reservoir
Transfer case fluid ³	Motorcraft MERCON® ATF	4 x 4 vehicles	1.9L (2.0 quarts)

Capacities and specifications

Fluid	Ford Part Name	Application	Capacity
Transmission fluid	Motorcraft MERCON® ATF	5-speed manual ⁴	3.5L (3.75 quarts)
		Automatic-E4OD (4x2)	15.0L (15.9 quarts)
	Automatic-E4OD (4x4)	15.5L (16.4 quarts)	
	Motorcraft MERCON® V ATF	Automatic-4R70W	13.1L (13.9 quarts)
Windshield washer fluid	Ultra-Clear Windshield Concentrate	All	4.0L (4.25 quarts)

Your vehicle's rear axle is equipped with synthetic rear axle lubricant. Rear axles containing synthetic lubricant are lubricated for life. These lubricants do not need to be checked or changed unless a leak is suspected, service required or the axle assembly has been submerged in water. The axle lubricant should be changed any time the rear axle has been submerged in water.

¹Add 118 ml (4 oz.) of additive friction modifier C8AZ-19B546-A, Ford specification EST-M2C118-A, for complete fill of 8.8 inch and 9.75 inch axles.

²Add 236 ml (8 oz.) of additive Friction Modifier C8AZ-19B546-A, Ford Specification EST-M2C118-A, for complete fill of 10.25 inch axles.

³Fill to bottom of filler hole.

Capacities and specifications

⁴Fill to 6 mm (3/8 inch) below bottom of filler hole.

⁵In-vehicle refill: approximately 3.1L (6.5 pints).

LUBRICANT SPECIFICATIONS

Fluid	Ford part name or equivalent	Ford part number	Ford specification
Front axle	75W90 Gear Lube	XY-75W90-QL	WSP-M2C201-A
Rear axle	Motorcraft SAE 75W140 High Performance Synthetic Rear Axle Lube ¹	F1TZ-19580-B	WSL-M2C192-A
Brake fluid and clutch fluid	High Performance DOT 3 Motor Vehicle Brake Fluid	C6AZ-19542-AB	ESA-M6C25-A and DOT 3
Engine coolant	For Premium Cooling System Fluid	E2FZ-19549-AA or B	ESE-M97B44-A
Engine oil	Motorcraft 5W30 Super Premium Motor Oil	XO-5W30-BSP or QSP	WSS-M2C153-G and API Certification Mark
Grease; body hinges, latches and manual seat tracks.	Multi-Purpose Grease	DOAZ-19584-AA or D7AZ-19584-AA	ESB-M1C93-A or ESB-M1C106-B

Capacities and specifications

Fluid	Ford part name or equivalent	Ford part number	Ford specification
Grease; transmission /steering/parking brake linkages and pivots. Brake and clutch pedal shaft.	Premium Long-Life Grease	XG-1-C	ESA-M1C75-B
Power steering fluid, transfer case fluid and transmission fluid (manual)	Motorcraft MERCON® ATF	XT-2-BDX or QDX	MERCON®
Automatic transmission (E4OD)	Motorcraft MERCON® ATF	XT-2-BDX-QDX	MERCON®
Automatic transmission (4R70W)	Motorcraft MERCON® V ATF	XT-5-QM	MERCON® V
Windshield washer fluid	Ultra-clear windshield washer concentrate	C9AZ-19550-AC or BC	ESR-M17P5-A

¹ You must add 4-ounces of additive friction modifier C8AZ-19B546-A, Ford specification EST-M2C118-A to the rear axle whenever the axle has been serviced.

Capacities and specifications

ENGINE DATA

Engine	4.2L engine	4.6L engine	5.4L engine
Cubic inches	256	281	330
Horsepower	205 @ 4440 rpm	220 @ 4500 rpm	235 @ 4250 rpm
Torque	255 lb. ft. @ 3000 rpm	290 lb. ft. @ 3250 rpm	330 lb. ft. @ 3000 rpm
Required fuel grade	87 octane	87 octane	87 octane
Firing order	1-4-2-5-3-6	1-3-7-2-6-5-4-8	1-3-7-2-6-5-4-8
Spark plug gap	1.3-1.4 mm (0.052-.056 inch)	1.3-1.4 mm (0.052-.056 inch)	1.3-1.4 mm (0.052-.056 inch)
Ignition system	EDIS	EDIS	Coil on plug
Compression ratio	9.2:1	9.0:1	9.0:1

VEHICLE DIMENSIONS

Styleside

Dimension	Body Style			
	Regular Cab 4x2	Regular Cab 4x4	Super Cab 4x2	Super Cab 4x4
(1) Overall length	5 135 mm (202.2 in) (SWB) 5 588 mm (220.8 in) (LWB)	5 135 mm (202.2 in) (SWB) 6 070 mm (239.3 in) (LWB)	5 588 mm (220.8 in) (SWB) 6 096 mm (240.9 in) (LWB)	5 638 mm (222.3 in) (SWB) 6 096 mm (240.9 in) (LWB)
(2) Overall width	1 991 mm (78.4 in)	2 019 mm (79.5 in)	1 991 mm (78.4 in)	2 019 mm (79.5 in)

Capacities and specifications

Dimension	Body Style			
	Regular Cab 4x2	Regular Cab 4x4	Super Cab 4x2	Super Cab 4x4
(3) Overall height	1 846 mm (72.7 in) (SWB) 1838 mm (72.4 in) (LWB)	1 917 mm (75.5 in) (SWB) 1 907 mm (75.1 in) (LWB)	1 846 mm (72.7 in) (SWB) 1 838 mm (72.4 in) (LWB)	1 917 mm (75.5 in) (SWB) 1 907mm (75.1 in) (LWB)
(4) Wheel base	3 022 mm (119.9 in) (SWB) 3 505 mm (138.5 in) (LWB)	3 048 mm (120.2 in) (SWB) 3 505 mm (138.8 in) (LWB)	3 505 mm (138.5 in) (SWB) 3 987 mm (157.1 in) (LWB)	3 505 mm (138.8 in) (SWB) 3 987 mm (157.4 in) (LWB)
(5) Track front/rear	1 661 mm (65.4 in)/1 661 mm (65.4 in)	1 661 mm (65.4 in)/1 661 mm (65.4 in)	1 661 mm (65.4 in)/1 661 mm (65.4 in)	1 661 mm (65.4 in)/1 661 mm (65.4 in)

Flareside

Dimension	Body Style			
	Regular Cab 4x2	Regular Cab 4x4	Super Cab 4x2	Super Cab 4x4
(1) Overall length	5 229 mm (205.9 in)	5 267 mm (207.4 in)	5 702 mm (224.5 in)	5 740 mm (226.0 in)
(2) Overall width	2 009 mm (79.1 in)	2 026 mm (79.8 in)	2 009 mm (79.1 in)	2 026 mm (79.8 in)
(3) Overall height	1 846 mm (72.7 in)	1 917 mm (75.5 in)	1 846 mm (72.7 in)	1 917 mm (75.5 in)
(4) Wheel base	3 045 mm (119.9 in)	3 053 mm (120.2 in)	3 517 mm (138.5 in)	3 525 mm (138.8 in)
(5) Track front/rear	1 661 mm (65.4 in)	1 661 mm (65.4 in)	1 661 mm (65.4 in)	1 661 mm (65.4 in)

Capacities and specifications

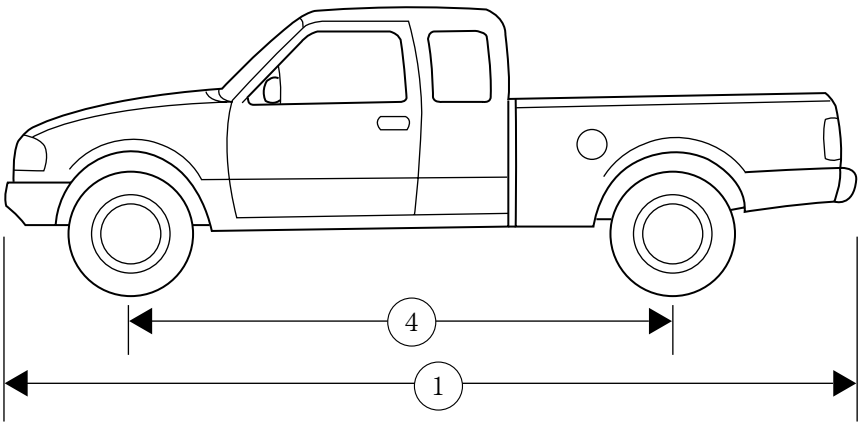
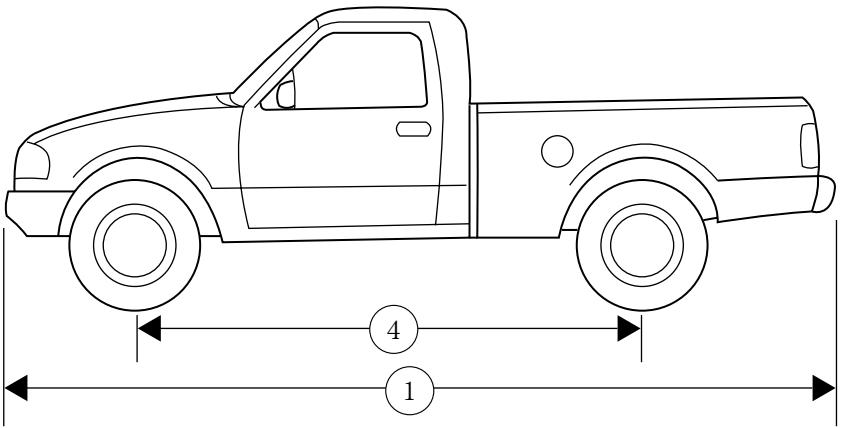

Capacities and specifications

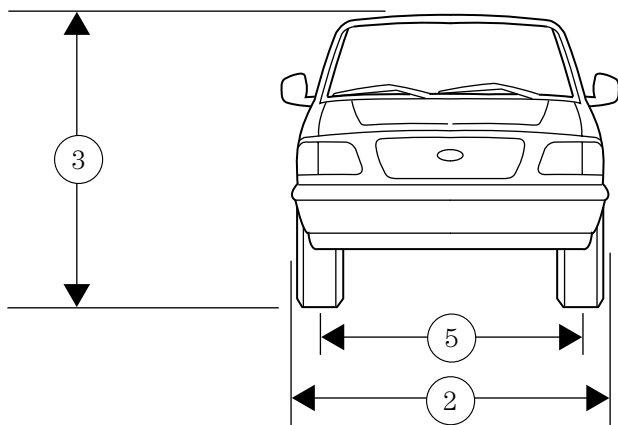

IDENTIFYING YOUR VEHICLE

Vehicle identification plate

The vehicle identification plate is located on the front panel of the engine compartment. This plate bears technical information on your vehicle and identifies various components.

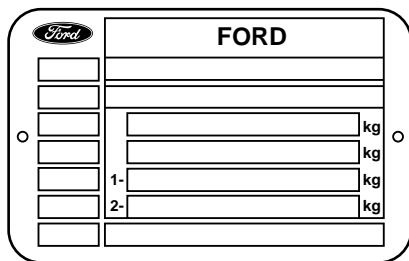

Capacities and specifications

Vehicle identification number

The vehicle identification number is attached to a metal tag and is located on the driver side instrument panel.

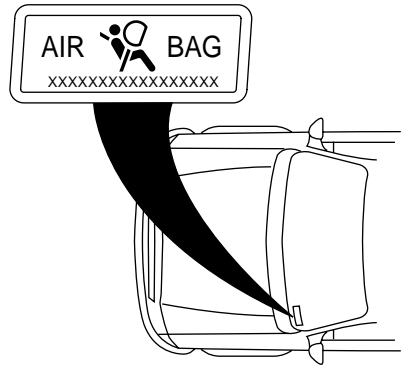

Engine number

The engine number (the last eight numbers of the vehicle identification number) is stamped on the engine block, transmission, frame and transfer case (if so equipped).

REPORTING SAFETY DEFECTS (U.S. ONLY)

If you believe that your vehicle has a defect that could cause a crash, or could cause injury or death, you should immediately inform the National Highway Traffic Safety Administration (NHTSA) in addition to notifying Ford Motor Company.



If NHTSA receives similar complaints, it may open an investigation, and if it finds that a safety defect exists in a group of vehicles, it may order a recall and remedy campaign. However, NHTSA cannot become involved in individual problems between you, your dealer or Ford Motor Company.

To contact NHTSA, you may either call the Auto Safety Hotline toll-free at 1-800-424-9393 (202-366-0123 in the Washington D.C. area) or write to:

NHTSA

U.S. Department of Transportation
400 Seventh Street
Washington D.C. 20590

You can also obtain other information about motor vehicle safety from the Hotline.

Index

- Air bag supplemental restraint system60
 - and child safety seats61
 - description60
 - disposal64
 - indicator light63
 - passenger air bag62,65,66
- Air conditioning
 - manual heating and air conditioning system22,23,26
- Air suspension
 - description87
 - warning light11
- Ambulance packages3
- Anti-lock brake system (ABS)
 - description84
- Anti-theft system40
- Battery175
 - voltage gauge16
- Brake fluid
 - checking and adding162
- Brakes83
 - anti-lock83
 - anti-lock brake system (ABS)
 - warning light84
 - fluid, checking and adding162
- Brake-shift interlock88
- Break-in period2
- Bulbs, replacing192
 - headlamps193
 - specifications197
- Changing a tire141
- Child safety seats70
- Chime
 - headlamps on12
- Cleaning your vehicle198
 - engine compartment200
 - fabric201
 - instrument panel201
 - plastic parts201
 - safety belts202
 - tail lamps201
 - washing198
 - waxing199
 - wheels199
- Clutch
 - fluid163
- Controls19
- Daytime running light system ...17
- Driving under special conditions105
 - high water105
 - slippery roads106,107
- Emission control system189
- Engine210
 - check engine temperature warning, message
 - center155,156
 - service points155
 - Engine block heater80
 - Engine coolant
 - checking and adding164,165
 - disposal166
 - refill capacities167
 - Engine oil156,160
 - changing oil and oil filter161
 - checking and adding156,158,160
- Exhaust fumes81
- Fail safe cooling168
- Foglamps196,197
- Four-Wheel Drive vehicles98
 - control trac19,102
 - indicator light99
 - lever operated electric shift99
- Fuel
 - calculating fuel economy188
 - improving fuel economy130
 - octane rating187
 - quality187
 - safety information relating to automotive fuels184
- Fuel gauge13
- Fuel pump shut-off switch131

- Fuse panels
 - instrument panel133
 - power distribution box138
- Fuses132,133
- Gauges, Mechanical13
 - engine coolant temperature gauge14
- Hazard flashers131
- Headlamps
 - autolamp system18
 - flashing35
 - high beam35
 - turning on and off17
- Heating20
- High beams
 - indicator light10
- Hood
 - release lever154
- Ignition
 - positions of the ignition27
 - removing the key98
- Instrument panel
 - lighting up panel and interior18
- Jump-starting your vehicle147,149
 - attaching cables148
 - disconnecting cables149
- Keyless entry system
 - autolock44
- Keys
 - key in ignition chime12
- Lamps
 - interior lamps36
 - map lamps36
 - parking lamps195
- Lights, warning and indicator
 - air bag8
 - anti-lock brakes (ABS)9
 - anti-theft10
 - brake9
 - charging system10
 - check engine6,7
 - door ajar11
 - engine oil pressure10
 - four-wheel drive11
 - fuel reset6,12
 - safety belt9
 - turn signal indicator9
- Load limits
 - trailer towing110
- Lubricant specifications205,208
- Manual transmission92
 - shift speeds94,96,97
- Mirrors
 - side view mirrors (power)38
- Odometer15
- Off road driving, 4-wheel drive 104
- Overdrive35,36
- Panic alarm feature, remote entry system43
- Parking brake85
- Parts (see Motorcraft parts)205
- Power door locks38
- Power steering
 - fluid, checking and adding169
- Recreational towing, all wheels
 - on the ground123
- Relays132
- Remote entry system42
 - illuminated entry47
 - locking/unlocking doors43
 - replacement/additional transmitters46
 - replacing the batteries45
- Reporting safety defects215
- Safety restraints
 - automatic locking mode (retractor)54,55,56
 - extension assembly57
 - for children68
 - lap and shoulder belts53,54
 - maintenance58
 - proper use51

Index

- warning light and chime12,58
- Safety seats for children
 - attaching with tether straps74
 - automatic locking mode (retractor)71
 - tether anchorage hardware74
- Seats48
 - adjusting the seat, manual49
 - adjusting the seat, power49
 - bench (60-40 split)48,51
 - bench seat48
 - lumbar support50
- Servicing your vehicle152
 - precautions when servicing ...152
- Snowplowing3,124,125,127
- Special notice
 - utility-type vehicles3
- Speed control28
 - canceling a set speed31
 - resuming a set speed32
 - tap up/tap down30
 - turning off28
- Speedometer14
- Starting your vehicle76,77,80
- Tachometer
 - mechanical cluster15
- Tailgate39
 - removing40
- Tires179,181
 - checking the pressure181
 - replacing183
 - rotating182
 - snow tires and chains183
 - treadwear179
- Traction-lok rear axle86,175
- Trailer towing112,113,114,115,116,117
 - tips121
- Transaxle
 - fluid, checking and adding (manual)173
- Transfer case
 - fluid checking174
- Transmission170
 - automatic operation ..88,89,90,92
 - fluid, checking and adding (automatic)170
- Trip odometer15
- Turn signal
 - lever27
- Vehicle headlamp aiming device (VHAD)197
- Vehicle Identification Number (VIN)214
- Vehicle loading108
- Ventilating your vehicle82
- Warning chimes6
- Windows
 - accessory delay38
 - power windows, operating37
- Windshield washer fluid and wipers
 - checking and adding fluid164
 - checking and replacing wiper blades177
 - operation34
- Wrecker towing150

Filling station information

Recommended fuel	Unleaded fuel only - 87 octane
Fuel tank capacity-4 x 4 regular cab	92.7L (24.5 gallons)
Fuel tank capacity-4 x 2 vehicles and 4 x 4 SuperCab	94.6L (25 gallons)
Fuel tank capacity-Long wheelbase	113.6L (30 gallons)
Engine oil (with filter change)	Use Motorcraft 5W30 Super Premium Motor Oil, Ford Specification WSS-M2C153-G
Tire size and pressure	Refer to Tire Pressure Decal on passenger's door panel
Hood release	Pull handle under the left side of the instrument panel
Oil capacity (with filter change)	5.7L (6.0 quarts)
Coolant capacity-4.2L without A/C	14.9L (15.7 quarts)
Coolant capacity-4.2L with A/C	16.4L (17.3 quarts)
Coolant capacity-4.6L and 5.4L without A/C	16.9L (17.9 quarts)
Coolant capacity-4.6L and 5.4L with A/C	18.4L (19.4 quarts)
Power steering fluid capacity	Fill to line in reservoir
Automatic transmission fluid capacity-4R70W	13.1L (13.9 quarts)
Automatic transmission fluid capacity-E4OD (4 x 2)	15.0L (15.9 quarts)
Automatic transmission fluid capacity-E4OD (4 x 4)	15.5L (16.4 quarts)

Free Manuals Download Website

<http://myh66.com>

<http://usermanuals.us>

<http://www.somanuals.com>

<http://www.4manuals.cc>

<http://www.manual-lib.com>

<http://www.404manual.com>

<http://www.luxmanual.com>

<http://aubethermostatmanual.com>

Golf course search by state

<http://golfingnear.com>

Email search by domain

<http://emailbydomain.com>

Auto manuals search

<http://auto.somanuals.com>

TV manuals search

<http://tv.somanuals.com>