

Contents

Before driving

Introduction	2
Instrumentation	4
Controls and features	16
Seating and safety restraints	63

Starting and driving

Starting	83
Driving	88
Roadside emergencies	108

Servicing

Maintenance and care	126
Capacities and specifications	177
Reporting safety defects	185
Index	186

All rights reserved. Reproduction by any means, electronic or mechanical including photocopying, recording or by any information storage and retrieval system or translation in whole or part is not permitted without written authorization from Ford Motor Company.

Copyright © 1998 Ford Motor Company

Introduction

ICONS

Indicates a safety alert.
Read the following
section on *Warnings*.



Indicates vehicle
information related to
recycling and other
environmental
concerns will follow.



Correct vehicle usage and the authorized disposal of
waste cleaning and lubrication materials are
significant steps towards protecting the
environment.

Indicates a message
regarding child safety
restraints. Refer to
*Seating and safety
restraints* for more information.



Indicates that this
Owner Guide contains
information on this
subject. Please refer to
the Index to locate the appropriate section which
will provide you more information.



WARNINGS

Warnings provide information which may reduce the
risk of personal injury and prevent possible damage
to others, your vehicle and its equipment.

BREAKING-IN YOUR VEHICLE

There are no particular breaking-in rules for your
vehicle. During the first 1 600 km (1 000 miles) of
driving, vary speeds frequently. This is necessary to
give the moving parts a chance to break in.

Introduction

INFORMATION ABOUT THIS GUIDE

The information found in this guide was in effect at the time of printing. Ford may change the contents without notice and without incurring obligation.

SPECIAL NOTICES

Notice to owners of Cobra vehicles

Before you drive your vehicle, be sure to read the "SVT Cobra Owner's Guide Supplement." This book contains important operation and maintenance information.

Instrumentation

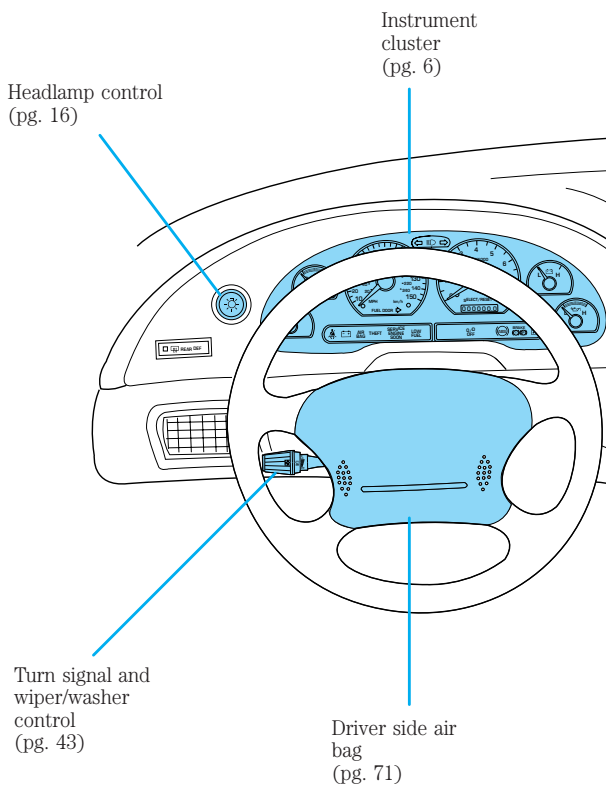

Instrumentation

Electronic
sound system
(pg. 21)

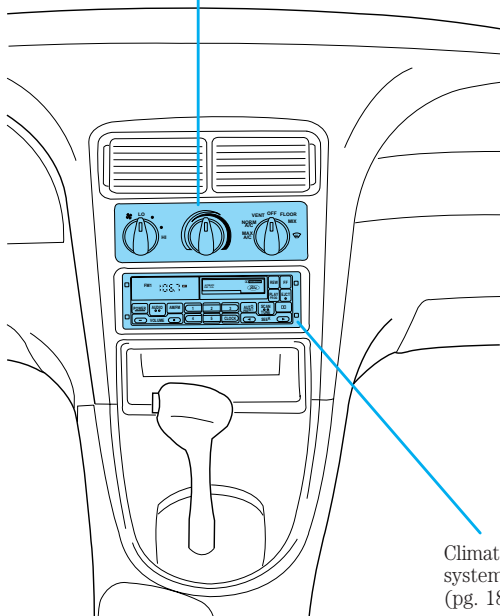

Climate control
systems
(pg. 18)

Instrumentation

WARNING LIGHTS AND CHIMES

Base instrument cluster

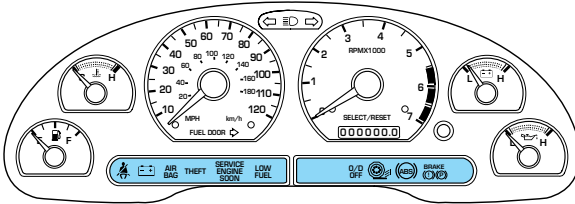

Optional instrument cluster

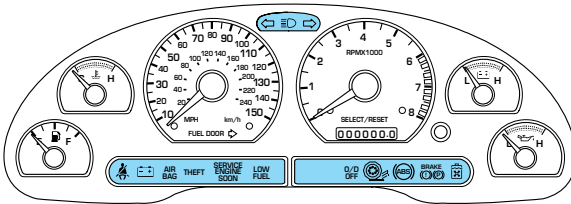

Turn signal

Illuminates when the left or right turn signal or the hazard lights are turned on. If one or both of the indicators stay on continuously or flash faster, check for a burned-out turn signal bulb. Refer to *Exterior bulbs* in the *Maintenance and care* chapter.



Instrumentation

High beams

Illuminates when the high beam headlamps are turned on.



Safety belt

Momentarily illuminates when the ignition is turned to the ON position to remind you to fasten your safety belts. For more information, refer to the *Seating and safety restraints* chapter.



Charging system

Illuminates when the ignition is turned to the ON position and the engine is off. The light also illuminates when the battery is not charging properly, requiring electrical system service.



Air bag readiness

Momentarily illuminates when the ignition is turned ON. If the light fails to illuminate, continues to flash or remains on, have the system serviced immediately.



Anti-theft system

Refer to *SecuriLock™ passive anti-theft system* in the *Controls and features* chapter.



Instrumentation

Service engine soon

Your vehicle is equipped with a computer that monitors the engine's emission control system. This

SERVICE
ENGINE
SOON

system is commonly known as the On Board Diagnostics System (OBD II). The OBD II system protects the environment by ensuring that your vehicle continues to meet government emission standards. The OBD II system also assists the service technician in properly servicing your vehicle.

The *Service Engine Soon* indicator light illuminates when the ignition is first turned to the ON position to check the bulb. If it comes on after the engine is started, one of the engine's emission control systems may be malfunctioning. The light may illuminate without a driveability concern being noted. The vehicle will usually be drivable and will not require towing.

What you should do if the Service Engine Soon light illuminates

Light turns on solid:

This means that the OBD II system has detected a malfunction.

Temporary malfunctions may cause your *Service Engine Soon* light to illuminate. Examples are:

1. The vehicle has run out of fuel. (The engine may misfire or run poorly.)
2. Poor fuel quality or water in the fuel.
3. The fuel cap may not have been properly installed and securely tightened.

These temporary malfunctions can be corrected by filling the fuel tank with good quality fuel and/or properly installing and securely tightening the gas cap. After three driving cycles without these or any other temporary malfunctions present, the *Service Engine Soon* light should turn off. (A driving cycle

Instrumentation

consists of a cold engine startup followed by mixed city/highway driving.) No additional vehicle service is required.

If the *Service Engine Soon* light remains on, have your vehicle serviced at the first available opportunity.

Light is blinking:

Engine misfire is occurring which could damage your catalytic converter. You should drive in a moderate fashion (avoid heavy acceleration and deceleration) and have your vehicle serviced at the first available opportunity.



Under engine misfire conditions, excessive exhaust temperatures could damage the catalytic converter, the fuel system, interior floor coverings or other vehicle components, possibly causing a fire.

Low fuel

Illuminates as an early reminder of a low fuel condition indicated on the fuel gauge. The

light comes on when there is approximately 1/16th of a tank indicated on the fuel gauge (refer to *Fuel Gauge* in this chapter for more information). The ignition must be in the ON position for this lamp to illuminate. The lamp will also illuminate for several seconds after the ignition is turned to the ON position regardless of the fuel level.

**LOW
FUEL**

O/D off (if equipped)

Illuminates when the transmission control switch has been pushed. When the light

is on, the transmission does not shift into overdrive. If the light does not come on when the transmission

**O/D
OFF**

Instrumentation

control switch is depressed or if the light flashes when you are driving, have your vehicle serviced.

Traction Control™ active

This light momentarily illuminates when the ignition is turned to ON. It also illuminates when the Traction Control™ system begins applying and releasing the brakes and adjusting the engine characteristics to limit a wheelspin condition. It will be lit for a minimum of four seconds or for the duration of the Traction Control™ event.



For more information, refer to the *Driving* chapter.

Anti-lock brake system (ABS)

Momentarily illuminates when the ignition is turned to the ON position and the engine is off. If the light remains on, continues to flash or fails to illuminate, have the system serviced immediately. With the ABS light on, the anti-lock brake system is disabled and normal braking is still effective unless the brake warning light also remains illuminated with parking brake released.



Brake system warning

Momentarily illuminates when the ignition is turned to the ON position and the engine is off. If brake warning lamp does not illuminate at this time, seek service immediately. Also illuminates when the parking brake is engaged. Illumination after releasing the parking brake indicates low brake fluid level and the brake system should be inspected immediately.

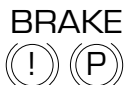

Check coolant

Illuminates when the coolant level in the coolant reservoir is low and more needs to be



added. This lamp will also illuminate when the ignition is turned to ON and the engine is off. For more information on adding engine coolant, refer to *Engine coolant* in the *Maintenance and care* chapter.

Safety belt warning chime

Chimes to remind you to fasten your safety belts.

For information on the safety belt warning chime, refer to the *Seating and safety restraints* chapter.

Supplemental restraint system (SRS) warning chime

For information on the SRS warning chime, refer to the *Seating and safety restraints* chapter.

Key-in-ignition warning chime

Sounds when the key is left in the ignition in the OFF/LOCK or ACC position and the driver's door is opened.

Headlamps on warning chime

Sounds when the headlamps or parking lamps are on, the ignition is off (and the key is not in the ignition) and the driver's door is opened.

Instrumentation

GAUGES

Base instrument cluster gauges

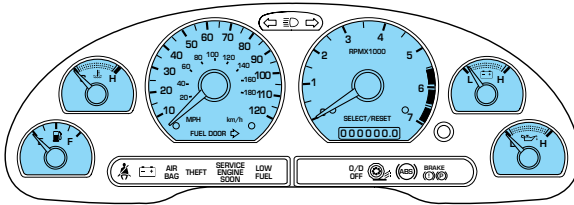

Optional instrument cluster gauges

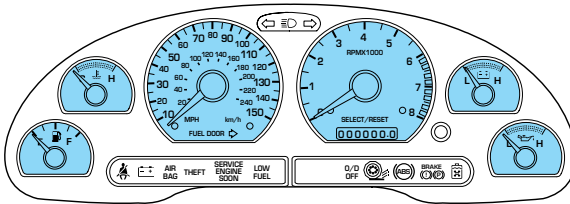

Fuel gauge

Displays approximately how much fuel is in the fuel tank (when the key is in the ON



position). The fuel gauge may vary slightly when the vehicle is in motion. The ignition should be in the OFF position while the vehicle is being refueled. When the gauge first indicates empty, there is a small amount of reserve fuel in the tank. When refueling the vehicle from empty indication, the amount of fuel that can be added will be less than the advertised capacity due to the reserve fuel.

Instrumentation

Engine coolant temperature gauge

Indicates the temperature of the engine coolant. At normal operating



temperature, the needle remains within the normal area (the area between the “H” and “C”). If it enters the red section, the engine is overheating. Stop the vehicle as soon as safely possible, switch off the engine immediately and let the engine cool. Refer to *Engine coolant* in the *Maintenance and care* chapter.



Never remove the coolant reservoir cap while the engine is running or hot.

This gauge indicates the temperature of the engine coolant, not the coolant level. If the coolant is not at its proper level the gauge indication will not be accurate.

Speedometer

Indicates the current vehicle speed.

- Base instrument cluster

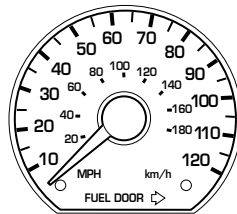

- Optional instrument cluster

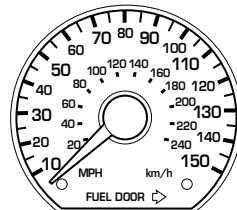

Instrumentation

Odometer

Registers the total kilometers (miles) of the vehicle.

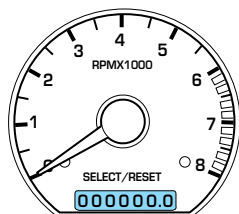

Tachometer

Indicates the engine speed in revolutions per minute.

Driving with your tachometer pointer at the top of the scale or in the red zone may damage the engine.

- Base instrument cluster

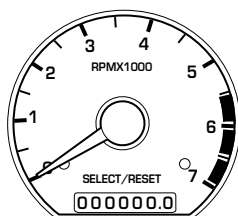

- Standard instrument cluster

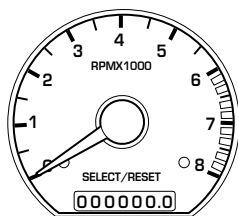

Instrumentation

Trip odometer

Registers the kilometers (miles) of individual journeys. Press the reset button until a “T” appears in the display (this represents the trip mode). Press and hold the button for 2.5 seconds to reset.

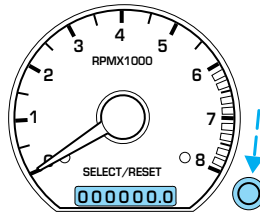

Battery voltage gauge

This gauge shows the battery voltage when the ignition is in the ON position. If the pointer moves and stays outside the normal operating range (as indicated), have the vehicle's electrical system checked as soon as possible.

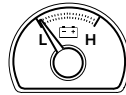

Engine oil pressure gauge

This shows the engine oil pressure in the system. Sufficient pressure exists as long as the needle remains in the normal range (the area between the “L” and “H”).



If the gauge indicates low pressure, stop the vehicle as soon as safely possible and switch off the engine immediately. Check the oil level. Add oil if needed (refer to *Engine oil* in the *Maintenance and care* chapter). If the oil level is correct, have your vehicle checked at your dealership or by a qualified technician.

Controls and features

HEADLAMP CONTROL

- Pull the headlamp control toward you to the first position to turn on the parking lamps, tail lamps, license plate lamps and marker lamps.
- Pull the headlamp control toward you to the outer position to turn on the headlamps (in addition to the previous lamps).

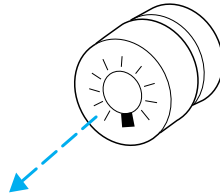

Daytime running lamps (DRL) (if equipped)

Turns the headlamps on with a reduced output. To activate:

- the ignition must be turned on
- the headlamp control is in the OFF or Parking lamps position
- the high beam headlamps must be turned off
- the parking brake is released



Always remember to turn on your headlamps at dusk or during inclement weather. The Daytime Running Light (DRL) System does not activate your tail lamps and generally may not provide adequate lighting during these conditions. Failure to activate your headlamps under these conditions may result in a collision.

Controls and features

PANEL DIMMER CONTROL

To adjust the brightness of the instrument panel:

- Rotate clockwise/ counterclockwise when the headlamp control is in the parking lamp or low-beam position.

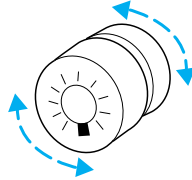

To turn on the courtesy lamps:

- Rotate fully counterclockwise.

REAR WINDOW DEFROSTER (IF EQUIPPED)

The rear defroster control is located on the instrument panel.



Press the rear defroster control to clear the rear window of thin ice and fog.

- The small LED will illuminate when the rear defroster is activated.

The ignition must be in the ON position to operate the rear window defroster.

The defroster turns off automatically after 10 minutes or when the ignition is turned to the OFF position. To manually turn off the defroster before ten minutes have passed, push the control again.

Controls and features

CLIMATE CONTROL SYSTEM

Manual heating and air conditioning system

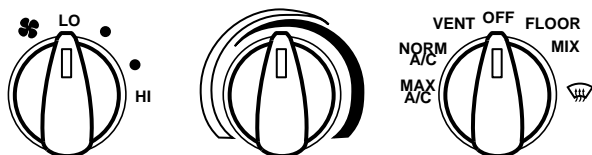

Fan speed control

Controls the volume of air circulated in the vehicle.



Temperature control knob

Controls the temperature of the airflow inside the vehicle.



Mode selector control

Controls the direction of the airflow to the inside of the vehicle.



The air conditioning compressor will operate in all modes except VENT and FLR. However, the air conditioning will only function if the outside temperature is about 10°C (50°F) or above.

Since the air conditioner removes considerable moisture from the air during operation, it is normal if clear water drips on the ground under the air conditioner drain while the system is working and even after you have stopped the vehicle.

Controls and features

Under normal conditions, your vehicle's climate control system should be left in any position other than MAX A/C or OFF when the vehicle is parked. This allows the vehicle to "breathe" through the outside air inlet duct.

- **MAX A/C**-Uses recirculated air to cool the vehicle. MAX A/C is noisier than NORM A/C but more economical and will cool the inside of the vehicle faster. Airflow will be from the instrument panel registers. This mode can also be used to reduce undesirable odors from entering the vehicle.
- **NORM A/C**-Uses outside air to cool the vehicle. It is quieter than MAX A/C but not as economical. Airflow will be from the instrument panel registers.
- **VENT**-Distributes outside air through the instrument panel registers. However, the air will not be cooled below the outside temperature because the air conditioning does not operate in this mode.
- **OFF**-Outside air is shut out and the fan will not operate. For short periods of time only, use this mode to prevent undesirable odors from entering the vehicle.
- **FLR**-Allows for maximum heating by distributing outside air through the floor ducts. However, the air will not be cooled below the outside temperature because the air conditioning does not operate in this mode.
- **MIX**-Distributes outside air through the windshield defroster ducts and the floor ducts. Heating and air conditioning capabilities are provided in this mode. For added customer comfort, when the temperature control knob is anywhere in between the full hot and full cold positions, the air distributed through the floor ducts will be slightly warmer than the air sent to the windshield defroster ducts. If the temperature

Controls and features

is about 10°C (50°F) or higher, the air conditioner will automatically dehumidify the air to reduce fogging.

-  - Distributes outside air through the windshield defroster ducts. It can be used to clear ice or fog from the windshield. If the temperature is about 10°C (50°F) or higher, the air conditioner will automatically dehumidify the air to reduce fogging.

Operating tips

- In humid weather, select  before driving. This will prevent your windshield from fogging. After a few minutes, select any desired position.
- To reduce humidity buildup inside the vehicle, don't drive with the climate control system in the OFF position.
- Don't put objects under the front seat that will interfere with the airflow to the back seats.
- Remove any snow, ice or leaves from the air intake area (at the bottom of the windshield).

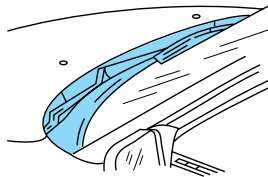

- If your vehicle has been parked with the windows closed during hot weather, the air conditioner will do a much faster job of cooling if you drive for two or three minutes with the windows open. This will force most of the hot, stale air out of the vehicle. Then operate your air conditioner as you would normally.
- When placing objects on top of your instrument panel, be careful to not place them over the defroster outlets. These objects can block airflow and reduce your ability to see through your windshield. Also, avoid placing small objects on top of your instrument panel. These objects can fall down into the defroster outlets and block airflow and possibly damage your climate control system.

Controls and features

USING YOUR AUDIO SYSTEM

AM/FM Stereo/Cassette/Premium Sound

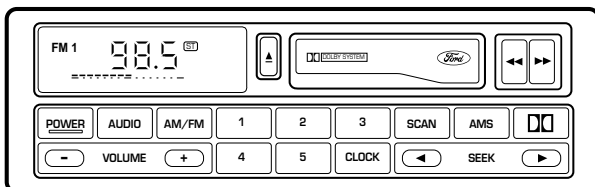

Power control

Press the control to turn the audio system on or off.

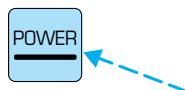

Volume control

Press the control to raise or lower volume.



If the volume is set above a certain level and the ignition is turned off, the volume will come back on at a “nominal” listening level when the ignition switch is turned back on. If you wish to maintain your preset volume level, turn the audio system off with the power control before switching off the ignition.

AM/FM select

The AM/FM select control works in radio mode and allows you to select AM or FM frequency bands.



Press the control to switch between AM, FM1 or FM2 memory preset stations.

Tune adjust in radio mode

Tune adjust allows you to tune in a particular radio station. You can manually locate the



Controls and features

station by using the Automatic Music Search (AMS) button.

- Press the AMS control until the display shows TUNE.
- Press and release either ◀ or ▶ on the SEEK control to change to the next frequency up or down.
- Press and hold down ◀ or ▶ to quickly move through the frequencies.

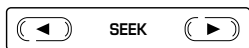

Seek function

The seek function control works in radio or tape mode.

Seek function in radio mode

- Press ◀ to find the next listenable station down the frequency band.
- Press ▶ to find the next listenable station up the frequency band.

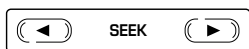

Seek function in tape mode

The Automatic Music Search (AMS) feature allows you to quickly locate the beginning of the tape selection being played or to skip to the next selection.



- Press the AMS control.
- Press ◀◀ to listen to the previous selection on the tape.
- Press ▶▶ to listen to the next selection on the tape.

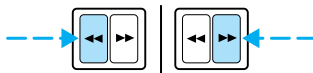

The tape deck stops and returns to play mode when the AMS circuit senses a blank section on the tape.

Controls and features

In order to ensure proper operation of the AMS feature, the tape **MUST** have a blank section of at least 4 seconds duration between programs.

Scan function

The scan function works in radio mode.

A rectangular button with the word "SCAN" in bold, uppercase letters.

- Press the SCAN button to activate the scan mode. The radio scans up the frequency band, stopping on each listenable station for approximately a five-second sampling.
- Press the SCAN button a second time to deactivate the feature.

Radio station memory preset

The radio is equipped with five station memory preset controls. These controls can be used to select up to five preset AM stations and ten FM stations (five in FM1 and five in FM2).

Setting memory preset stations

1. Select the frequency band with the AM/FM select control.

A rectangular button with the text "AM/FM" in bold, uppercase letters. A dashed blue arrow points to the right side of the button.

AM/FM

2. Select a station. Refer to *Tune adjust* or *Seek function* for more information on selecting a station.

3. Press and hold a memory preset control until the sound returns, indicating the station is held in memory on the control you selected.



Repeat the steps for each station memory preset button you want to set.

If the battery is disconnected, the memory preset stations will need to be reset.

Controls and features

Bass adjust

The bass adjust control allows you to increase or decrease the audio system's bass output.

- Push the AUDIO control repeatedly until the display reads BASS.
- Press (+) or (-) on the volume control to increase or decrease bass output.



Treble adjust

The treble adjust control allows you to increase or decrease the audio system's treble output.

- Push the AUDIO control repeatedly until the display reads TREB.
- Press (+) or (-) on the volume control to increase or decrease treble output.



Speaker balance adjust

Speaker sound distribution can be adjusted between the right and left speakers.

- Push the AUDIO control repeatedly until the display reads BAL.
- Press the (+) side of the volume control to shift sound to the right speakers.
- Press the (-) side of the volume control to shift sound to the left speakers.

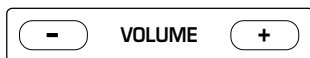

Controls and features

Speaker fade adjust

Speaker sound distribution can be adjusted between the front and rear speakers.

- Push the AUDIO control repeatedly until the display reads FADE.
- Press the (+) side of the volume control to shift sound to the front speakers.
- Press the (-) side of the volume control to shift sound to the rear speakers.



Tape play select

Insert a tape to begin tape play.

Push only slightly when inserting a cassette tape (with the open edge to the right). A cassette deck loading mechanism pulls the tape in the rest of the way.

Rewind/fast forward

The rewind and fast forward controls work in tape mode.

Rewind/fast forward function in tape mode

- Press ◀◀ to rewind the tape. Play will continue once the beginning of the tape is reached or rewind is stopped.
- Press ▶▶ to fast forward the tape. Once the end of the tape is reached, tape direction reverses and the opposite side of the tape plays.

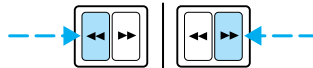

Controls and features

Tape eject

Press the control to press and eject a tape.

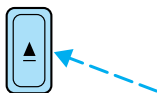

Dolby® noise reduction

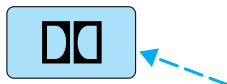

Dolby® noise reduction manufactured under license from Dolby Laboratories Licensing Corporation operates only in tape mode. Dolby® reduces the amount of hiss and static during tape playback.

Press the  button to activate (and deactivate) Dolby® noise reduction.



Setting the clock

Press the CLOCK control while simultaneously depressing the SEEK control.

- Press  to set the hours.
- Press  to set the minutes.



Controls and features

AM/FM Stereo/Cassette/MACH 460 Sound System® with Premium AM/FM Stereo Cassette

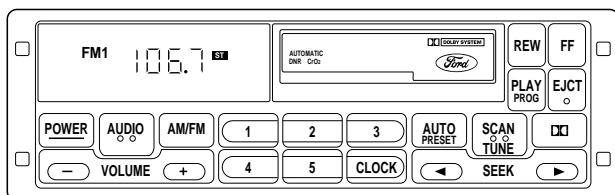

Power control

Press the control to turn the audio system on or off.



Volume control

Press the control to raise or lower volume.



If the volume is set above a certain level and the ignition is turned off, the volume will come back on at a “nominal” listening level when the ignition switch is turned back on. If you wish to maintain your preset volume level, turn the audio system off with the power control before switching off the ignition.

AM/FM select

The AM/FM select control works in radio mode and allows you to select AM or FM frequency bands.



Press the control to switch between AM, FM1 or FM2 memory preset stations.

Controls and features

Tune adjust

Tune adjust works in radio mode and allows you to manually tune in a particular radio station.



- Press the SCAN/TUNE button twice.
- The display reads TUNE.

Press the SEEK control to move up or down through the frequencies.



- Press ◀ to move down or ▶ to move up the frequency band.
- Press and hold down ◀ or ▶ to quickly move through the frequencies.

Seek function

The seek function control works in radio or tape mode.

Seek function in radio mode

This feature allows you to automatically select listenable stations up or down the frequency band.



- Press ◀ to find the next listenable station down the frequency band.
- Press ▶ to find the next listenable station up the frequency band.

Seek function in tape mode

This feature allows you to locate the beginning of the tape selection being played or to skip to the next selection.



- Press ◀ to listen to the previous selection on the tape.

Controls and features

- Press ► to listen to the next selection on the tape.

Scan function

The scan function works in radio, tape and CD mode (if equipped).

Scan function in radio mode

This feature allows you to scan the frequency band, stopping on each listenable station for approximately a five-second sampling.



- Press the SCAN/TUNE button to enter the scan mode.
- This display reads SCN.

Use the SEEK button to scan up or down the frequency band.



- Press ◀ to find the next listenable station down the frequency band.
- Press ► to find the next listenable station up the frequency band.

Scan function in tape mode

This feature allows you to scan the tape currently playing, stopping on each selection for approximately an eight-second sampling.



- Press the SCAN/TUNE button to enter the scan mode.
- The display reads SCN.

Use the SEEK button to scan the desired direction on the tape.



- Press ◀ to scan previous selections.

Controls and features

- Press  to scan forward selections.

Press the SCAN/TUNE button again to stop the scan mode on the current selection.

Radio station memory preset

The radio is equipped with five station memory preset controls. These controls can be used to select up to five preset AM stations and ten FM stations (five in FM1 and five in FM2).

Setting memory preset stations

1. Select the frequency band with the AM/FM select control.



2. Select a station. Refer to *Seek function* for more information on selecting a station.

3. Press and hold a memory preset control until the sound returns, indicating the station is held in memory on the control you selected.



If the battery is disconnected, the memory preset stations will need to be reset.

Bass adjust

The bass adjust control allows you to increase or decrease the audio system's bass output.

- Push the AUDIO control repeatedly until the display reads BASS.
- Press (+) or (-) on the volume control to increase or decrease bass output.



Treble adjust

The treble adjust control allows you to increase or decrease the audio system's treble output.

Controls and features

- Push the AUDIO control repeatedly until the display reads TREB.
- Press (+) or (-) on the volume control to increase or decrease treble output.



Speaker balance adjust

Speaker sound distribution can be adjusted between the right and left speakers.

- Push the AUDIO control repeatedly until the display reads BAL.
- Press the (+) side of the volume control to shift sound to the right speakers.
- Press the (-) side of the volume control to shift sound to the left speakers.



Speaker fade adjust

Speaker sound distribution can be adjusted between the front and rear speakers.

- Push the AUDIO control repeatedly until the display reads FADE.
- Press the (+) side of the volume control to shift sound to the front speakers.
- Press the (-) side of the volume control to shift sound to the rear speakers.



Tape play select

Insert a cassette tape into the cassette deck.

Controls and features

Push only slightly when inserting a cassette tape (with the open edge to the right). A cassette deck loading mechanism pulls the tape in the rest of the way.

Press PLAY to begin cassette tape play.



Rewind/fast forward function in tape mode

Press the control to rewind the tape.



Play will continue once the beginning of the tape is reached or rewind is stopped.

Press the control to fast forward the tape.



Once the end of the tape is reached, tape direction reverses and the opposite side of the tape plays.

Tape eject

Press the control to stop and eject a tape.



Dolby® noise reduction

Dolby® noise reduction manufactured under license from Dolby Laboratories Licensing Corporation operates only in tape mode. Dolby® reduces the amount of hiss and static during tape playback.



Press the  button to activate (and deactivate) Dolby® noise reduction.

Controls and features

Setting the clock

Press the CLOCK control while simultaneously depressing the SEEK control.

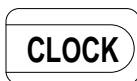

- Press ◀ to set the hours.
- Press ▶ to set the minutes.

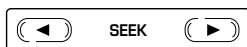

Premium AM/FM Stereo Single CD Radio/Premium Sound or MACH 460 Sound System® with Single CD Radio

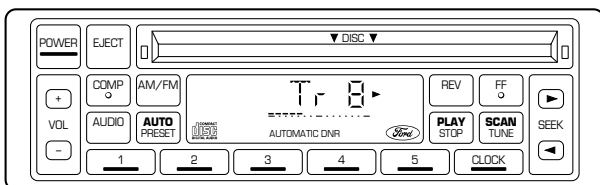

Power control

Press the control to turn the audio system on or off.

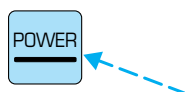

Volume control

Press the control to raise or lower volume.

If the volume is set above a certain level and the ignition is turned off, the volume will come back on at a “nominal” listening level when the ignition switch is turned back on. If you wish to maintain your preset volume level, turn the audio system off with the power control before switching off the ignition.

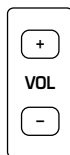

Controls and features

AM/FM select

The AM/FM select control works in radio mode and allows you to select AM or FM frequency bands.



Press the control to switch between AM, FM1 or FM2 memory preset stations.



Tune adjust

The tune control works in radio mode.

Tune adjust in radio mode

- Press the SCAN/TUNE control twice.



- Within approximately five seconds, press and release either  or  on the SEEK button to change to the next frequency up or down.





- Press and hold down  or  to quickly move through the frequencies.

Seek function

The seek function control works in radio mode.

Seek function in radio mode

- Press  to find the next listenable station down the frequency band.
- Press  to find the next listenable station up the frequency band.



Controls and features

Scan function



The scan function works in radio mode.



Scan function with compact disc radio

- Press the SCAN/TUNE control once.



- Push  on the SEEK control to hear a brief sampling of listenable stations up the frequency band.
- Push  to hear a brief sampling of listenable stations down the frequency band.



Setting memory preset stations

1. Select the frequency band with the AM/FM select control.



2. Select a station. Refer to *Tune adjust* or *Seek function* for more information on selecting a station.



3. Press and hold a memory preset control until the sound returns, indicating the station is held in memory on the control you selected.

If the battery is disconnected, the memory preset stations will need to be reset.

Automatic memory store (if equipped)

Automatic memory store allows you to set strong radio stations without losing your original manually

Controls and features

set preset stations. This feature is helpful on trips when you travel between cities with different radio stations.

Starting automatic memory store

1. Select a frequency using the AM/FM select control.



2. Press the AUTO PRESET control.



3. When the first six strong stations are filled, the station stored in memory preset control 1 will start playing.

If there are less than six strong stations available on the frequency band, the remaining memory preset controls will all store the last strong station available.

Deactivating automatic memory store

To deactivate automatic memory store and return to your audio system's manually set memory stations, press the AUTO PRESET control again.

Speaker balance adjust

Speaker sound distribution can be adjusted between the right and left speakers.

- Push the AUDIO control repeatedly until the display reads BAL.
- Press the (+) side of the volume control to shift sound to the right speakers.
- Press the (-) side of the volume control to shift sound to the left speakers.

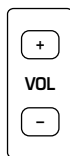

Controls and features

Speaker fade adjust

Speaker sound distribution can be adjusted between the front and rear speakers.

- Push the AUDIO control repeatedly until the display reads FADE.
- Press the (+) side of the volume control to shift sound to the front speakers.
- Press the (-) side of the volume control to shift sound to the rear speakers.

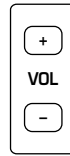

Reverse/fast forward in CD mode

- Press the control for less than three seconds for slow reverse.
- Press the control for more than three seconds for fast reverse.
- Press the control for less than three seconds for slow forward action.
- Press the control for more than three seconds for fast forward action.



CD eject

Press the control to stop and eject a CD.

If a disc is ejected from the CD player but is not removed within approximately 10 seconds, the player will automatically reload the disc for storage (unless the disc is automatically ejected because it was inserted upside down, in which case the disc will not be automatically reloaded).

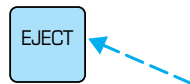

Controls and features

Compression feature

Compression adjust brings soft and loud CD passages together for a more consistent listening level.

Press the COMP control to activate and deactivate compression adjust.

The effect of the feature varies with the music content.

Setting the clock

Press the CLOCK control while simultaneously depressing the SEEK control.

- Press ◀ to set the hours.
- Press ▶ to set the minutes.

CLOCK



SEEK



Single Disc CD Player (if equipped)

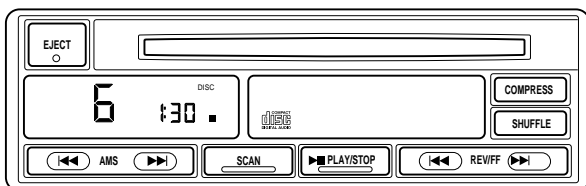

Power and volume control

The compact disc player operates when the audio system is on and a CD is inserted (label side up).

The volume is controlled by the VOLUME control on the audio system.

Controls and features

Play function

The system enters the PLAY mode when a CD is loaded, label side up, into the disc opening.

The PLAY indicator will illuminate. The CD automatically loads into the unit and begins play at the beginning of the first track. When the CD reaches the end, the disc player automatically returns to the beginning of the CD and resumes play.



Stop function

Press the PLAY/STOP control to temporarily stop CD play. The stop indicator illuminates

and operation returns to the radio or tape mode. Press the control again to resume CD play.



Scan function

Press the SCAN control to enter the scan mode. The CD player will begin scanning the

CD, stopping on each listenable track for approximately eight seconds. This continues until you press the SCAN control a second time or eject the CD. While in the scan mode, the display flashes SCAN.



Reverse/fast forward

To quickly search for a particular

point in a selection, press the right side of the REV/FF control (to fast forward) or the left side (to reverse). If you hold down the desired function for longer than a few seconds, the process will speed up. Release the button when you have reached the desired point of the CD.



Controls and features

If you hold down the fast forward control until the end of the CD is reached, the display will show the end time of the last track and the sound will be muted. When the fast forward control is released, the player will resume play at the beginning of the first track.

AMS control

The AMS (Automatic Music Search) control on your CD player

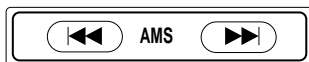

allows you to quickly find a particular selection on the disc. Press the left side of the AMS control to locate a previous selection, or the right side to locate a later selection.

Compression feature

Press the COMPRESS control to activate (and deactivate) compression adjust. Compression



adjust brings soft and loud CD passages together for a more consistent listening level.

Shuffle feature

The shuffle feature plays all tracks on the current CD in random order.



Press the SHUFFLE control to start this feature. Random order play will continue until the control is pressed again.

Eject

Push the EJECT control to stop CD play, eject the CD, and resume radio or tape operation.

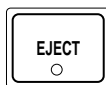

Controls and features

Troubleshooting the CD player (if equipped)



The laser beam used in the compact disc player is harmful to the eyes. Do not attempt to disassemble the case.

If sound skips:

- You may be traveling on a rough road, playing badly scratched discs or the disc may be dirty. Skipping will not scratch the discs or damage the player.

If your changer does not work, it may be that:

- A disc is already loaded where you want to insert a disc.
- The disc is inserted with the label surface downward.
- The disc is dusty or defective.
- The player's internal temperature is above 60°C (140°F). Allow the player to cool down before operating.
- A disc with format and dimensions not within industry standards is inserted.

Cleaning compact discs

Inspect all discs for contamination before playing. If necessary, clean discs only with an approved CD cleaner and wipe from the center out to the edge. Do not use circular motion.

CD and CD player care

- Handle discs by their edges only. Never touch the playing surface.
- Do not expose discs to direct sunlight or heat sources for extended periods of time.
- Do not insert more than one disc into the slot of the CD player.

Controls and features

Cleaning cassette player (if equipped)

Clean the tape player head with a cassette cleaning cartridge after ten to twelve hours of play in order to maintain the best sound and operation.

Cassette and cassette player care

- Use only cassettes that are 90 minutes long or less.
- Do not expose tapes to direct sunlight, high humidity, extreme heat or extreme cold. Allow tapes that may have been exposed to extreme temperatures to reach a moderate temperature before playing.
- Tighten very loose tapes by inserting a finger or pencil into the hole and turning the hub.
- Remove loose labels before inserting tapes.
- Do not leave tapes in the cassette player for a long time when not being played.

Radio frequency information

The Federal Communications Commission (FCC) and the Canadian Radio and Telecommunications Communications (CRTC) establish the frequencies AM and FM stations may use for their broadcasts. Allowable frequencies are:

AM 530, 540–1600, 1610 kHz

FM 87.9, 88.1–107.1, 107.9 MHz

Not all frequencies are used in a given area.

Radio reception factors

Three factors can affect radio reception:

- **Distance/strength.** The further an FM signal travels, the weaker it is. The listenable range of the average FM station is approximately 40 km (24 miles). This range can be affected by “signal modulation.” Signal modulation is a process radio stations use to increase their strength/volume relative to other stations.

Controls and features

- **Terrain.** Hills, mountains and tall buildings between your vehicle's antenna and the radio station signal can cause FM reception problems. Static can be caused on AM stations by power lines, electric fences, traffic lights and thunderstorms. Moving away from an interfering structure (out of its "shadow") returns your reception to normal.
- **Station overload.** Weak signals are sometimes captured by stronger signals when you pass a broadcast tower. A stronger signal may temporarily overtake a weaker signal and play while the weak station frequency is displayed.

The audio system automatically switches to single channel reception if it will improve the reception of a station normally received in stereo.

Audio system warranties and service

Refer to the "Warranty Guide" for audio system warranty information.

If service is necessary, see your dealer or a qualified technician.

TURN SIGNAL CONTROL

- Push down to activate the left turn signal.
- Push up to activate the right turn signal.

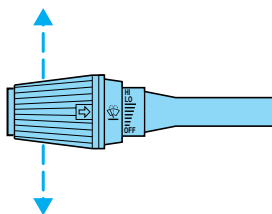

WINDSHIELD WIPER/WASHER CONTROLS

Rotate the windshield wiper control to the desired interval, low or high speed position.

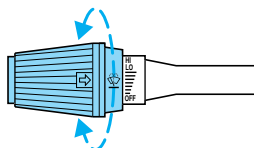

Controls and features

The bars of varying length are for intermittent wipers. When in this position rotate the control upward for fast intervals and downward for slow intervals.

Push the control on the end of the stalk to activate washer. Push and hold for a longer wash cycle. The washer will automatically shut off after ten seconds of continuous use.

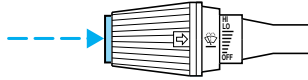

Mist Function

To operate the Mist function of the windshield wipers, push and release the windshield washer control quickly. The wipers will cycle one or two times.

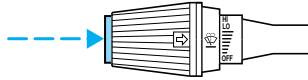

HIGH BEAMS

Push forward to activate.

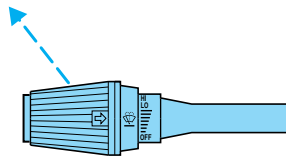

FLASH TO PASS

Pull toward you to activate and release to deactivate.

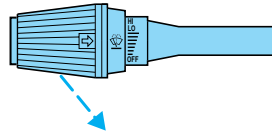

Controls and features

POSITIONS OF THE IGNITION

1. **ACCESSORY**, allows the electrical accessories such as the radio to operate while the engine is not running.

2. **LOCK**, locks the steering wheel, automatic transmission gearshift lever and allows key removal.

3. **OFF**, shuts off the engine and all accessories without locking the steering wheel.

4. **ON**, all electrical circuits operational. Warning lights illuminated. Key position when driving.

5. **START**, cranks the engine. Release the key as soon as the engine starts.

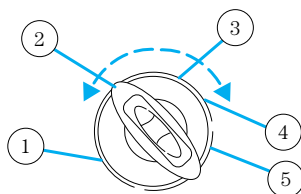

TILT STEERING WHEEL (IF EQUIPPED)

Pull the tilt steering control toward you to move the steering wheel up or down.

Hold the control while adjusting the wheel to the desired position, then release the control to lock the steering wheel in position.

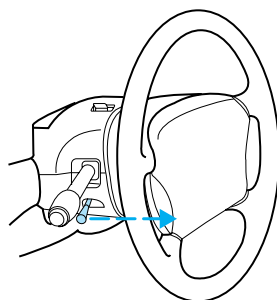

Never adjust the steering wheel when the vehicle is moving.

Controls and features

SPEED CONTROL

To turn speed control on

- Press ON.

Vehicle speed cannot be controlled until the vehicle is traveling at or above 48 km/h (30 mph).

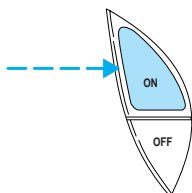

Do not use the speed control in heavy traffic or on roads that are winding, slippery, or unpaved.



Do not shift the gearshift lever into N (Neutral) with the speed control on.

To turn speed control off

- Press OFF or
- Turn off the vehicle ignition.

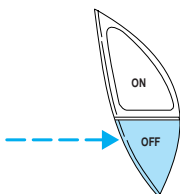

Once speed control is switched off, the previously programmed set speed will be erased.

To set a speed

- Press SET/SET ACC/SET ACCEL. For speed control to operate, the speed control must be ON and the vehicle speed must be greater than 48 km/h (30 mph).

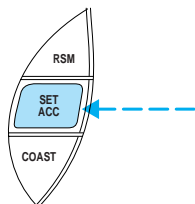

Controls and features

If you drive up or down a steep hill, your vehicle speed may vary momentarily slower or faster than the set speed. This is normal.

Speed control cannot reduce the vehicle speed if it increases above the set speed on a downhill. If your vehicle speed is faster than the set speed while driving on a downhill, you may want to shift to the next lower gear or apply the brakes to reduce your vehicle speed.

If your vehicle slows down more than 16 km/h (10 mph) below your set speed on an uphill, your speed control will disengage. This is normal. Pressing RES/RSM/RESUME will re-engage it.



Do not use the speed control in heavy traffic or on roads that are winding, slippery, or unpaved.

To set a higher set speed

- Press and hold SET/SET ACC/SET ACCEL. Release the control when the desired vehicle speed is reached or
- Press and release SET/SET ACC/SET ACCEL. Each press will increase the set speed by 1.6 km/h (1 mph) or
- Accelerate with your accelerator pedal. When the desired vehicle speed is reached, press and release SET/SET ACC/SET ACCEL.

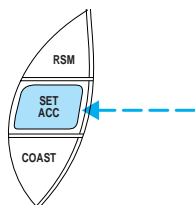

You can accelerate with the accelerator pedal at any time during speed control usage. Releasing the accelerator pedal will return your vehicle to the previously programmed set speed.

Controls and features

To set a lower set speed

- Press and hold CST/COAST. Release the control when the desired speed is reached or
- Press and release CST/COAST. Each press will decrease the set speed by 1.6 km/h (1 mph) or
- Depress the brake pedal. When the desired vehicle speed is reached, press SET/SET ACC/SET ACCEL.

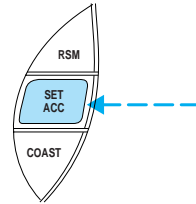
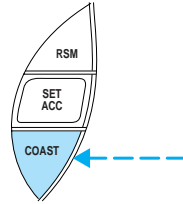

To disengage speed control

- Depress the brake pedal or
 - Depress the clutch pedal (if equipped)
- Disengaging the speed control will not erase the previously programmed set speed.

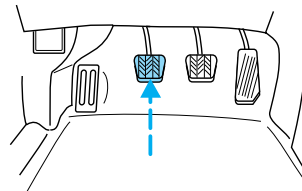
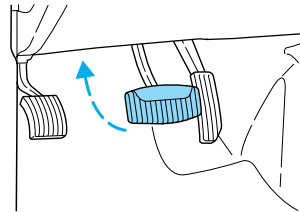

Controls and features

Pressing OFF will erase the previously programmed set speed.

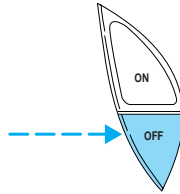

To return to a previously set speed

- Press RES/RSM/RESUME. For RES/RSM/RESUME to operate, the vehicle speed must be faster than 48 km/h (30 mph).

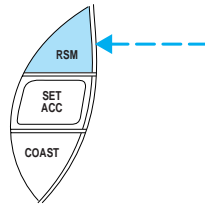

INTERIOR LAMPS

Map lamps (if equipped)

If equipped with a convertible top the map lamps and controls are located on the rearview mirror. Press the controls on either side of each map lamp to activate the lamps.

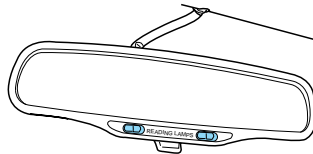

Controls and features

POWER WINDOWS (IF EQUIPPED)

Press and hold the rocker switches to open and close windows.

- Press the top portion of the rocker switch to close.
- Press the bottom portion of the rocker switch to open.

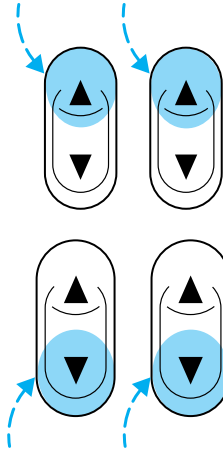

Express down

To make the driver window open fully without holding the window control, press the driver window control completely down and release quickly. Depress again to stop window operation.

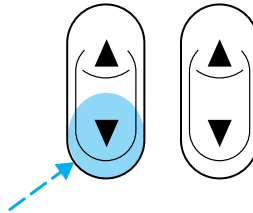

Window lock

The window lock feature allows only the driver to operate the power windows.

To lock out all the window controls except for the driver's press the control. Press the control again to restore the window controls.

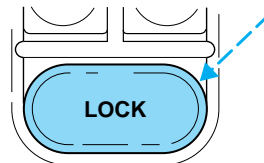

Controls and features

POWER DOOR LOCKS

Press U to unlock all doors and L to lock all doors.

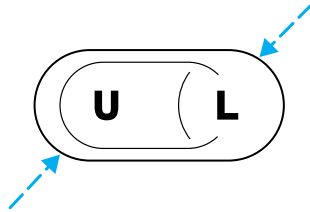

POWER SIDE VIEW MIRRORS (IF EQUIPPED)

To adjust your mirrors:

1. Select ◀ to adjust the left mirror or ▶ to adjust the right mirror.
2. Move the control in the direction you wish to tilt the mirror.

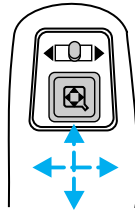

3. Return to the center position to lock mirrors in place.

POSITIVE RETENTION FLOOR MAT (IF EQUIPPED)

Position the floor mat so that the eyelet is over the pointed end of the retention post and rotate forward to lock in. Make sure that the mat does not interfere with the operation of the accelerator or the brake pedal. To remove the floor mat, reverse the installation procedure.

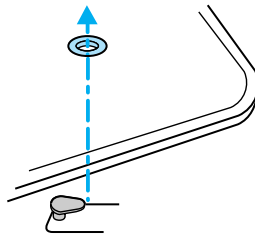

Controls and features

CENTER CONSOLE

Your vehicle may be equipped with a variety of console features. These include:

- dual cupholders
- auxiliary power point
- coin holder slots (if equipped)
- foglamp control (if equipped)
- convertible top control (if equipped)



Use only soft cups in the cupholder. Hard objects can injure you in a collision.

Foglamp control (if equipped)

Turn on the parking lamps or the low-beam headlamps. Press the top portion of the foglamp control, located on the center console, to activate the foglamps. The foglamp LED will illuminate when the foglamps are on.



Press the bottom portion of the foglamp control to deactivate the foglamps.

Auxiliary power point

The power point is an additional power source for electrical accessories.

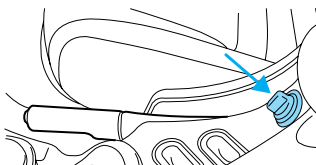

Controls and features

Convertible (If equipped)

Do not store articles behind rear seat. Articles stored in the convertible top stowage compartment may break the rear glass window when the top is lowered.

Lowering the convertible top

The convertible top can be lowered with the side windows either up or down.

The convertible top will not operate unless the parking brake is engaged. Do not lower the top while the vehicle is moving because the top may be severely damaged. Also, do not lower the top when the top material is wet.

To lower the convertible top:

1. Bring vehicle to a complete stop. Engage the parking brake. Key must be in the ON position.
2. Check the convertible top stowage compartment behind the rear seat to be sure it is empty and ready to receive the top.
3. Unclamp the top from the windshield header at both the right and left sides by pulling each clamp rearward until the hook in the windshield header is free. The clamps are flush with the header when in the closed position.
4. Close the windshield header clamps immediately after disengagement, to avoid cutting the top material and to permit installation of the vinyl boot.
5. If the top has not been lowered for some time and sticks to the windshield header, push the front of the top up slightly with your hand to loosen it.

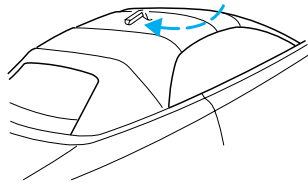

Controls and features

6. Push the convertible top switch on the console in front of the armrest and hold until the top is completely stored.

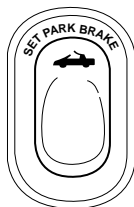

7. Disengage the parking brake.

Installation of the boot

1. Insert boot tongue into groove located on rear seat.

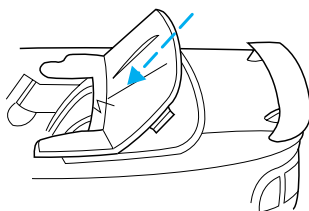

2. Push boot forward until rear attachment engages under molding.

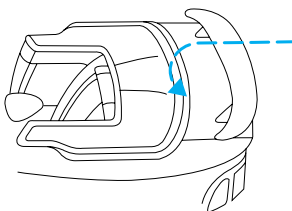

3. Push forward flap of boot until both clips engage under trim panel edge. Repeat on other side of vehicle.

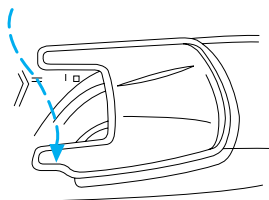

Controls and features

4. Tuck side attachments under molding. Repeat on other side of vehicle.

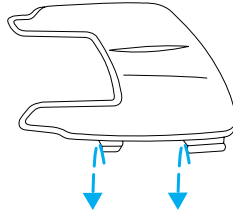

5. Push and pull front of boot to ensure tongue is engaged into groove.

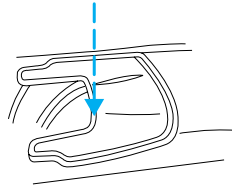

6. Removal

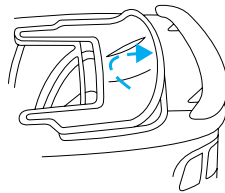

Raising the convertible top

The convertible top will not operate unless the parking brake is engaged. Do not raise the top while the vehicle is moving because the top may be severely damaged.

To raise the convertible top:

1. Bring the vehicle to a complete stop. Engage the parking brake. Key must be in the ON position.
2. Remove the boot cover and store it in the luggage compartment.
3. Lower the front and rear side windows.
4. Push the convertible top button, holding it until the top unfolds and moves forward toward the windshield header.

Controls and features

5. Open both top clamps before the top meets the windshield header
6. Continue to use the top motor to raise the top until it has reached the fully closed position flush to the header.
7. The two pins under the forward edge of the top should seat themselves in the matching holes in the header.
8. To fasten both clamps securely, push the clamp handles into the header on the top until they are flush with the header. Pulling down on the header at the center grip while closing the latches may assist in fastening the clamps.
9. Raise the front and rear side windows.
10. Disengage the parking brake.

REMOTE ENTRY SYSTEM

The remote entry system allows you to:

- lock or unlock all vehicle doors without a key.
- open the trunk.
- activate the panic alarm.
- confirms that the vehicle is locked with a short “beep” from the horn.

The remote entry features only operate with the ignition in the OFF position.

Unlocking the doors

Press this control to unlock the driver's door. The interior lamps will illuminate.

With the all-door remote entry system, press the control a second time within three seconds to unlock the passenger door.

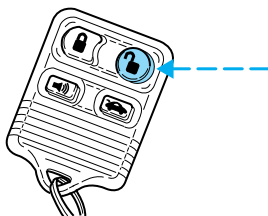

Controls and features

Locking the doors

Press this control to lock all doors.

To confirm all doors are closed and locked, press the control a second time within three seconds. The doors will lock again, the horn will chirp and the lamps will flash.

If any of the doors are ajar, the horn will make two quick chirps and the chime may sound, reminding you to properly close all doors.

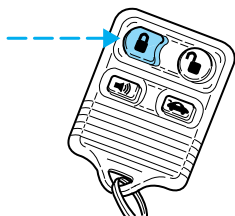

Opening the trunk

Press the control once to open the trunk.

Ensure that the trunk is closed and latched before driving your vehicle. Failure to latch the trunk may cause objects to fall out of the trunk or block the rear view.

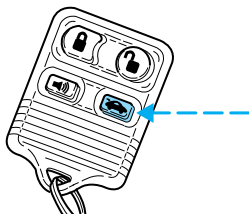

Sounding a panic alarm

Press this control to activate the alarm.

To deactivate the alarm, press the control again or turn the ignition to ACC or ON.

This device complies with part 15 of the FCC rules and with RS-210 of Industry Canada. Operation is subject to the following two conditions: (1) This device may not cause harmful interference, and (2) This device must accept any interference received, including interference that may cause undesired operation.

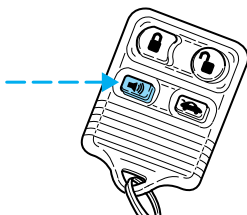

Controls and features

Changes or modifications not expressly approved by the party responsible for compliance could void the user's authority to operate the equipment.

Illuminated entry

The interior lamps illuminate when the remote entry system is used to unlock the door(s) or sound the personal alarm.

The system automatically turns off after 25 seconds or when the ignition is turned to the START/RUN or ACC position. The dome lamp control (if equipped) must **not** be set to the OFF position for the illuminated entry system to operate.

The inside lights will not turn off if:

- they have been turned on with the dimmer control or
- any door is open.

The battery saver will shut off the interior lamps 30 minutes after the ignition has been turned to the OFF position, 10 minutes after if the door is left open, and 30 minutes after if the trunk is left open or the dome lamp switch is left on.

Replacing lost transmitters

Take all your vehicle's transmitters to your dealer if service is required.

If you purchase additional transmitters (up to four may be programmed), perform the following procedure:

To reprogram the transmitters, place the key in the ignition and turn from OFF to ON eight times in rapid succession (within 10 seconds) ending in ON.



Controls and features

After doors lock/unlock, press any control on all transmitters (up to four). With each control press of the transmitters, the door should cycle (lock/unlock) to confirm programming. When completed, turn the ignition to OFF. The door locks should cycle (lock/unlock) one last time to confirm completion of programming.

All transmitters must be programmed at the same time.

Replacing the batteries

The transmitter is powered by two coin type three-volt lithium batteries. Typical operating range will allow you to be up to 10 meters (33 feet) away from your vehicle. A decrease in operating range can be caused by:

- weather conditions
- nearby radio towers
- structures around the vehicle
- other vehicles parked next to the vehicle

To replace the batteries:

1. Twist a thin coin between the two halves of the transmitter near the key ring. **DO NOT TAKE THE FRONT PART OF THE TRANSMITTER APART.**

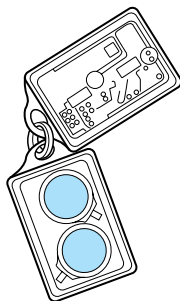

2. Place the positive (+) side of new batteries down. Refer to the diagram inside the transmitter unit.

3. Snap the two halves back together.

Controls and features

SECURILOCK™ PASSIVE ANTI-THEFT SYSTEM

The SecuriLock™ passive anti-theft system provides an advanced level of vehicle theft protection. Your vehicle's engine can only be started with the two special SecuriLock™ electronically coded keys provided with your vehicle. Each time you start your vehicle, the SecuriLock™ key is read by the SecuriLock™ passive anti-theft system. If the SecuriLock™ key identification code matches the code stored in the SecuriLock™ anti-theft system, the vehicle's engine is allowed to start. If the SecuriLock™ key identification code does not match the code stored in the system or if a SecuriLock™ key is not detected (vehicle theft situation), the vehicle's engine will not operate.

The SecuriLock™ passive anti-theft system is not compatible with aftermarket remote start systems. Use of these systems may result in vehicle starting problems and a loss of security protection. Large metallic objects or devices such as the Mobil Speedpass™ on the same key ring as your SecuriLock™ key may cause vehicle starting problems. These objects and devices cannot damage the SecuriLock™ key, but can cause a momentary problem if they are too close to the key when starting the engine. If a problem occurs, turn ignition off and restart the engine with all other objects on the key ring held away from the SecuriLock™ ignition key.

Spare SecuriLock™ keys can be purchased from your dealership and programmed to your SecuriLock™ passive anti-theft system. Refer to *Programming spare SecuriLock™ keys* for more information.

If one or both of your SecuriLock™ keys are lost or stolen and you want to ensure the lost or stolen key will not operate your vehicle, bring your vehicle and all available SecuriLock™ keys to your dealership for reinitialization.

Controls and features

Theft indicator

The theft indicator on the instrument cluster will operate as follows:

- When the ignition is OFF, the theft indicator will flash briefly every 2 seconds to indicate the SecuriLock™ system is protecting your vehicle.
- When the ignition is turned to RUN or START, the theft indicator will light for 3 seconds and then go out. If the theft indicator stays on for an extended period of time or flashes rapidly, have the system serviced by your dealership or a qualified technician.

Programming spare SecuriLock™ keys

Spare SecuriLock™ keys can be purchased from your dealership and programmed to your SecuriLock™ passive anti-theft system (up to a total of 8 keys). Your dealership can program your new SecuriLock™ key(s) to your vehicle or you can do it yourself using the following simple procedure. To program a new SecuriLock™ key yourself, you will need two previously programmed SecuriLock™ keys (keys that already operate your vehicle's engine). If two previously programmed SecuriLock™ keys are not available (one or both of your original keys were lost or stolen), you must bring your vehicle to your dealership to have the spare SecuriLock™ key(s) programmed.

Procedure to program spare SecuriLock™ keys to your vehicle

New SecuriLock™ keys must have the correct mechanical key cut for your vehicle.

Conventional (non-SecuriLock™) keys **cannot** be programmed to your vehicle.

You will need to have two previously programmed SecuriLock™ keys and the new unprogrammed SecuriLock™ key readily accessible for the procedure. Please read and understand the entire procedure before you begin.

Controls and features

1. Insert the first previously programmed SecuriLock™ key into the ignition and turn the ignition from OFF to RUN (maintain ignition in RUN for at least one second).
2. Turn ignition to OFF and remove the first SecuriLock™ key from the ignition.
3. Within five seconds of turning the ignition to OFF, insert the second previously programmed SecuriLock™ key into the ignition and turn the ignition from OFF to RUN (maintain ignition in RUN for at least one second but no more than 5 seconds).
4. Turn the ignition to OFF and remove the second SecuriLock™ key from the ignition.
5. Within 10 seconds of turning the ignition to OFF, insert the unprogrammed SecuriLock™ key (new key) into the ignition and turn the ignition from OFF to RUN (maintain ignition in RUN for at least one second). This step will program your new SecuriLock™ key.
6. To program additional SecuriLock™ key(s), repeat this procedure from step 1.

If the programming procedure was successful, the new SecuriLock™ key(s) will start the vehicle's engine. The theft indicator (located on the instrument cluster) will light for three seconds and then go out.

If the programming procedure was not successful, the new SecuriLock™ key(s) will not operate the vehicle's engine. The theft indicator will flash on and off. Wait at least one minute and then repeat the procedure from step 1. If failure repeats, bring your vehicle to your dealership to have the spare SecuriLock™ key(s) programmed.

Seating and safety restraints

SEATING

Adjustable head restraints (if equipped)

Your vehicle's seats may be equipped with head restraints which are vertically adjustable. The purpose of these head restraints is to help limit head motion in the event of a rear collision. To properly adjust your head restraints, lift the head restraint so that it is located directly behind your head or as close to that position as possible. Refer to the following to raise and lower the head restraints.

The head restraints can be moved up and down.

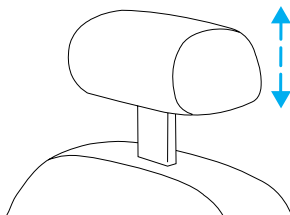

Adjusting the front manual seat



Never adjust the driver's seat or seatback when the vehicle is moving.



Do not pile cargo higher than the seatbacks to avoid injuring people in a collision or sudden stop.



Always drive and ride with your seatback upright and the lap belt snug and low across the hips.

Seating and safety restraints

Lift handle to move seat forward or backward.

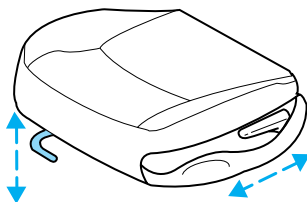

Pull lever up to adjust seatback.

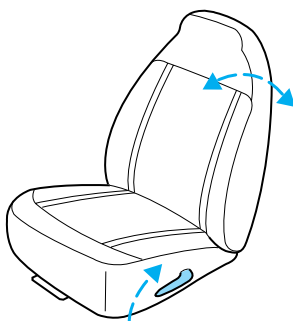

Adjusting the front power seat (if equipped)



Never adjust the driver's seat or seatback when the vehicle is moving.



Do not pile cargo higher than the seatbacks to avoid injuring people in a collision or sudden stop.



Always drive and ride with your seatback upright and the lap belt snug and low across the hips.

Seating and safety restraints

Press to raise or lower the front portion of the seat cushion.

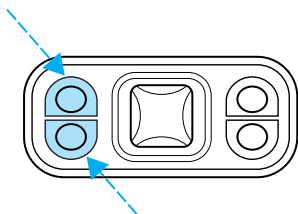

Press to raise or lower the rear portion of the seat cushion.

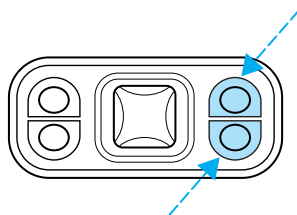

Press the control to move the seat forward, backward, up or down.

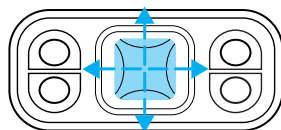

Rear seat entry/exit

Use the seatback release to fold the back of the front seat forward for rear seat passenger entry or exit. This release handle is located on the lower outboard back of the seat. The seatback locks automatically when returned to the normal position.

Using the power lumbar support (if equipped)

The power lumbar control is located on the outboard side of the seat.

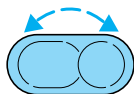

Press one side of the control to adjust firmness.

Press the other side of the control to adjust softness.

Seating and safety restraints

Using the manual lumbar support (if equipped)

The lumbar control is located on the inboard side of the driver's seatback.

Move the control up to increase firmness and down to decrease firmness.

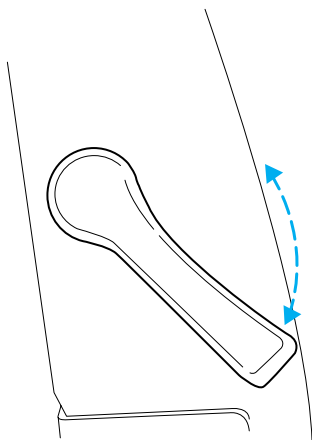

2nd seat/Split-folding rear seat (if equipped)

One or both rear seatbacks can be folded down to provide additional cargo space.

To lower the seatback(s) from inside the vehicle, pull tab to release seat back and then fold seatback down.

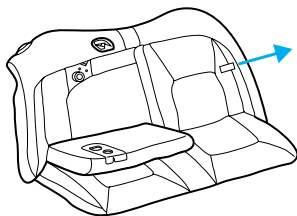

When raising the seatback(s), make sure you hear the seat latch into place.

SAFETY RESTRAINTS

Safety restraints precautions



Always drive and ride with your seatback upright and the lap belt snug and low across the hips.

Seating and safety restraints



To prevent the risk of injury, make sure children sit where they can be properly restrained.



Never let a passenger hold a child on his or her lap while the vehicle is moving. The passenger cannot protect the child from injury in a collision.



All occupants of the vehicle, including the driver, should always properly wear their safety belts, even when an air bag SRS is provided.



It is extremely dangerous to ride in a cargo area, inside or outside of a vehicle. In a collision, people riding in these areas are more likely to be seriously injured or killed. Do not allow people to ride in any area of your vehicle that is not equipped with seats and safety belts. Be sure everyone in your vehicle is in a seat and using a safety belt properly.



Each seating position in your vehicle has a specific safety belt assembly which is made up of one buckle and one tongue that are designed to be used as a pair. 1) Use the shoulder belt on the outside shoulder only. Never wear the shoulder belt under the arm. 2) Never swing the safety belt around your neck over the inside shoulder. 3) Never use a single belt for more than one person.

Seating and safety restraints

Combination lap and shoulder belts

1. Insert the belt tongue into the proper buckle (the buckle closest to the direction the tongue is coming from) until you hear a snap and feel it latch. Make sure the tongue is securely fastened in the buckle.

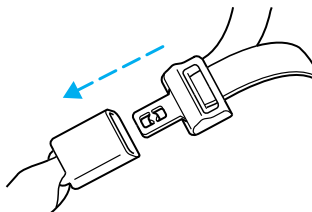

2. To unfasten, push the release button and remove the tongue from the buckle.

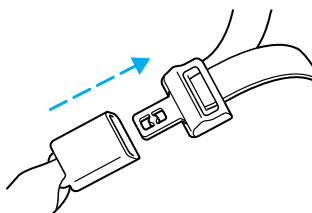

The front and rear outboard safety restraints in the vehicle are combination lap and shoulder belts. The front and rear seat passenger outboard safety belts have two types of locking modes described below:

Vehicle sensitive mode

The vehicle sensitive mode is the normal retractor mode, allowing free shoulder belt length adjustment to your movements and locking in response to vehicle movement. For example, if the driver brakes suddenly or turns a corner sharply, or the vehicle receives an impact of 8 km/h (5 mph) or more, the combination safety belts will lock to help reduce forward movement of the driver and passengers.

Automatic locking mode

In this mode, the shoulder belt is automatically pre-locked. The belt will still retract to remove any slack in the shoulder belt.

The automatic locking mode is not available on the driver safety belt.

Seating and safety restraints

When to use the automatic locking mode

- When a tight lap/shoulder fit is desired.
- **Anytime** a child safety seat is installed in a passenger front or outboard rear seating position (if equipped). Refer to *Safety Restraints for Children* or *Safety Seats for Children* later in this chapter.

How to use the automatic locking mode

- Buckle the combination lap and shoulder belt.

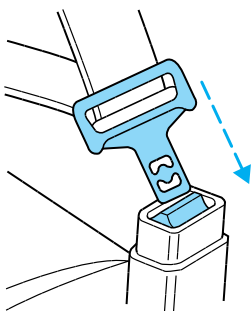

- Grasp the shoulder portion and pull downward until the entire belt is extracted.



- Allow the belt to retract. As the belt retracts, you will hear a clicking sound. This indicates the safety belt is now in the automatic locking mode.

How to disengage the automatic locking mode

Disconnect the combination lap/shoulder belt and allow it to retract completely to disengage the automatic locking mode and activate the vehicle sensitive (emergency) locking mode.

Seating and safety restraints

Safety belt extension assembly

If the safety belt assembly is too short, even when fully extended, 20 cm (8 inches) can be added to the safety belt assembly by adding a safety belt extension assembly (part number 611C22). Safety belt extension assemblies can be obtained from your dealer at no cost.

Use only extensions manufactured by the same supplier as the safety belt. Manufacturer identification is located at the end of the webbing on the label. Also, use the safety belt extension only if the safety belt is too short for you when fully extended. Do not use extensions to change the fit of the shoulder belt across the torso.

Safety belt warning light and indicator chime

The seat belt warning light illuminates in the instrument cluster and a chime sounds to remind the occupants to fasten their safety belts.

Conditions of operation

If...	Then...
The driver's safety belt is not buckled before the ignition switch is turned to the ON position...	The safety belt warning light illuminates for one to two minutes and the warning chime sounds for four to eight seconds.
The driver's safety belt is buckled while the indicator light is illuminated and the warning chime is sounding...	The safety belt warning light and warning chime turn off.
The driver's safety belt is buckled before the ignition switch is turned to the ON position...	The safety belt warning light will turn on for three seconds and then turn off. The indicator chime will remain off.

Seating and safety restraints

Safety belt maintenance

Inspect the safety belt systems periodically to make sure they work properly and are not damaged. Inspect the safety belts to make sure there are no nicks, wears or cuts, replacing if necessary. All safety belt assemblies, including retractors, buckles, front seat belt buckle assemblies (slide bar)(if equipped), shoulder belt height adjusters (if equipped), child safety seat tether bracket assemblies (if equipped), and attaching hardware, should be inspected after a collision. Ford recommends that all safety belt assemblies used in vehicles involved in a collision be replaced. However, if the collision was minor and a qualified technician finds that the belts do not show damage and continue to operate properly, they do not need to be replaced. Safety belt assemblies not in use during a collision should also be inspected and replaced if either damage or improper operation is noted.



Failure to inspect and if necessary replace the safety belt assembly under the above conditions could result in severe personal injuries in the event of a collision.

Refer to *Cleaning and maintaining the safety belts* in the *Maintenance and care* section.

AIR BAG SUPPLEMENTAL RESTRAINT SYSTEM (SRS)

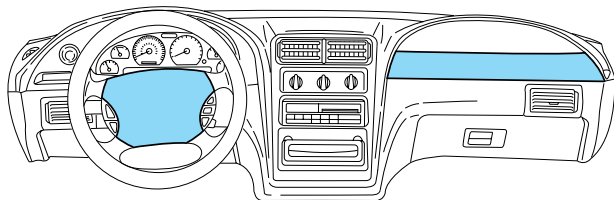

Seating and safety restraints

Important supplemental restraint system (SRS) precautions

The supplemental restraint system is designed to work with the safety belt to help protect the driver and right front passenger from certain upper body injuries.

Air bags DO NOT inflate slowly or gently and the risk of injury from a deploying air bag is greatest close to the trim covering the air bag module.

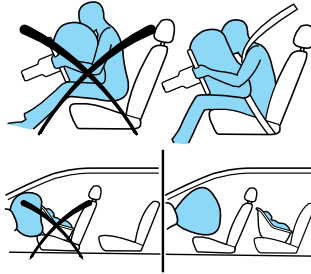

All occupants of the vehicle including the driver should always properly wear their safety belts even when air bag SRS is provided.



Always transport children 12 years old and under in the back seat and always use appropriate child restraints.



NHTSA recommends a minimum distance of at least 25 cm (ten [10] inches) between an occupant's chest and the air bag module.

Steps you can take to properly position yourself away from the airbag:

- Move your seat to the rear as far as you can while still reaching the pedals comfortably.
- Recline the seat slightly (one or two degrees) from the upright position.

Seating and safety restraints



Do not put anything on or over the air bag module. Placing objects on or over the air bag inflation area may cause those objects to be propelled by the air bag into your face and torso causing serious injury.



Do not attempt to service, repair, or modify the Air Bag Supplemental Restraint System or its fuses. See your Ford or Lincoln-Mercury dealer.

Children and air bags

For additional important safety information, read all information on safety restraints in this guide.

Children must always be properly restrained. Accident statistics suggest that children are safer when properly restrained in the rear seating

positions than in the front seating position. Failure to follow these instructions may increase the risk of injury in a collision.

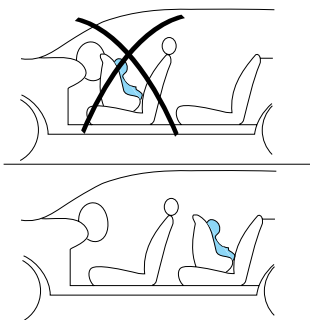

Air bags can kill or injure a child in a child seat. **NEVER** place a rear-facing child seat in front of an active air bag. If you must use a forward-facing child seat in the front seat, move the seat all the way back.

Seating and safety restraints

How does the air bag supplemental restraint system work?

The air bag SRS is designed to activate when the vehicle sustains sufficient longitudinal deceleration sufficient to cause the sensors to close an electrical circuit that initiates air bag inflation.

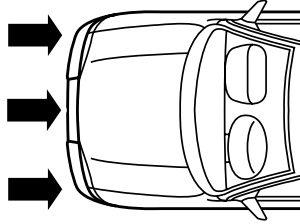

The fact that the air bags did not inflate in a collision does not mean that something is wrong with the system. Rather, it means the forces were not of the type sufficient to cause activation. Air bags are designed to inflate in frontal and near-frontal collisions, not rollover, side-impact, or rear-impacts.

The air bags inflate and deflate rapidly upon activation. After air bag deployment, it is normal to notice a smoke-like, powdery residue or smell the burnt propellant. This may consist of cornstarch, talcum powder (to lubricate the bag) or sodium compounds (e.g., baking soda) that result from the combustion process that inflates the air bag. Small amounts of sodium hydroxide may be present which may irritate the skin and eyes, but none of the residue is toxic.



While the system is designed to help reduce serious injuries, it may also cause minor burns, abrasions, swelling or temporary hearing loss. Because air bags must inflate rapidly and with considerable force,

Seating and safety restraints

there is the risk of death or serious injuries such as fractures, facial and eye injuries or internal injuries, particularly to occupants who are not properly restrained or are otherwise out of position at the time of air bag deployment. Thus, it is extremely important that occupants be properly restrained as far away from the air bag module as possible while maintaining vehicle control.



Several air bag system components get hot after inflation. Do not touch them after inflation.



If the air bag is deployed, **the air bag will not function again and must be replaced immediately.** If the air bag is not replaced, the unrepaired area will increase the risk of injury in a collision.

The SRS consists of:

- driver and passenger air bag modules (which include the inflators and air bags),
- one or more impact and safing sensors,
- a readiness light and tone
- and the electrical wiring which connects the components.

The diagnostic module monitors its own internal circuits and the supplemental air bag electrical system warning (including the impact sensors), the system wiring, the air bag system readiness light, the air bag back up power and the air bag ignitors.

Determining if the system is operational

The SRS uses a readiness light in the instrument cluster or a tone to indicate the condition of the system. Refer to the *Air bag readiness* section in the *Instrumentation* chapter. Routine maintenance of the air bag is not required.

Seating and safety restraints

A difficulty with the system is indicated by one or more of the following:

- The readiness light will either flash or stay lit.
- The readiness light will not illuminate immediately after ignition is turned on.
- A series of five beeps will be heard. The tone pattern will repeat periodically until the problem and light are repaired.

AIR
BAG

If any of these things happen, even intermittently, have the SRS serviced at your dealership or by a qualified technician immediately. Unless serviced, the system may not function properly in the event of a collision.

Disposal of air bags and air bag equipped vehicles

For disposal of air bags or air bag equipped vehicles, see your local dealership or qualified technician. Air bags **MUST BE** disposed of by qualified personnel.

SAFETY RESTRAINTS FOR CHILDREN

See the following sections for directions on how to properly use safety restraints for children. Also see *Air Bag Supplemental Restraint System (SRS)* in this chapter for special instructions about using air bags.

Important child restraint precautions

You are required by law to use safety restraints for children in the U.S. and Canada. If small children ride in your vehicle (generally children who are four years old or younger and who weigh 18 kg [40 lbs] or less), you must put them in safety seats made especially for children. Check your local and state or provincial laws for specific requirements regarding the safety of children in your vehicle.

Seating and safety restraints



Never let a passenger hold a child on his or her lap while the vehicle is moving. The passenger cannot protect the child from injury in a collision.

Always follow the instructions and warnings that come with any infant or child restraint you might use.

When possible, place children in the rear seat of your vehicle. Accident statistics suggest that children are safer when properly restrained in the rear seating positions than in the front seating position.

Children and safety belts

If the child is the proper size, restrain the child in a safety seat.

Children who are too large for child safety seats (as specified by your child safety seat manufacturer) should always wear safety belts.

Follow all the important safety restraint and air bag precautions that apply to adult passengers in your vehicle.

If the shoulder belt portion of a combination lap and shoulder belt can be positioned so it does not cross or rest in front of the child's face or neck, the child should wear the lap and shoulder belt. Moving the child closer to the center of the vehicle may help provide a good shoulder belt fit.



Do not leave children, unreliable adults, or pets unattended in your vehicle.

To improve the fit of lap and shoulder belts on children who have outgrown child safety seats, Ford recommends use of a belt-positioning booster seat that is labelled as conforming to all Federal motor vehicle safety standards. Belt-positioning booster

Seating and safety restraints

seats raise the child and provide a shorter, firmer seating cushion that encourages safer seating posture and better fit of lap and shoulder belts on the child.

A belt-positioning booster should be used if the shoulder belt rests in front of the child's face or neck, or if the lap belt does not fit snugly on both thighs, or if the thighs are too short to let the child sit all the way back on the seat cushion when the lower legs hang over the edge of the seat cushion. You may wish to discuss the special needs of your child with your pediatrician.

SAFETY SEATS FOR CHILDREN



Child and infant or child safety seats

Use a safety seat that is recommended for the size and weight of the child. Carefully follow all of the manufacturer's instructions with the safety seat you put in your vehicle. If you do not install and use the safety seat properly, the child may be injured in a sudden stop or collision.

Seating and safety restraints

When installing a child safety seat:

- Review and follow the information presented in the *Air Bag Supplemental Restraint System* section in this chapter.
- Use the correct safety belt buckle for that seating position.
- Insert the belt tongue into the proper buckle until you hear a snap and feel it latch. Make sure the tongue is securely fastened in the buckle.
- Keep the buckle release button pointing up and away from the safety seat, with the tongue between the child seat and the release button, to prevent accidental unbuckling.
- Place seat back in upright position.
- Put the safety belt in the automatic locking mode. Refer to *Automatic locking mode* (passenger side front and outboard rear seating positions)(if equipped).

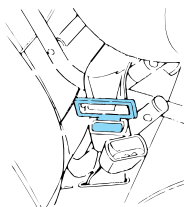

Ford recommends the use of a child safety seat having a top tether strap. Install the child safety seat in a seating position which is capable of providing a tether anchorage. For more information on top tether straps, refer to *Attaching safety seats with tether straps*.



Carefully follow all of the manufacturer's instructions included with the safety seat you put in your vehicle. If you do not install and use the safety seat properly, the child may be injured in a sudden stop or collision.

Seating and safety restraints

Installing child safety seats in combination lap and shoulder belt seating positions

1. Position the child safety seat in a seat with a combination lap and shoulder belt.

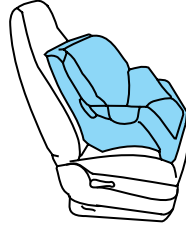

An air bag can kill or injure a child in a child seat. If you must use a forward-facing child seat in the front seat, move seat all the way back.



Children 12 and under should be properly restrained in the rear seat whenever possible.

2. Pull down on the shoulder belt and then grasp the shoulder belt and lap belt together.

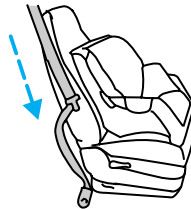

3. While holding the shoulder and lap belt portions together, route the tongue through the child seat according to the child seat manufacturer's instructions. Be sure the belt webbing is not twisted.

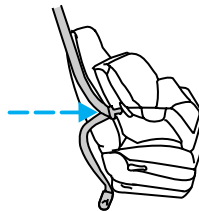

Seating and safety restraints

4. Insert the belt tongue into the proper buckle (the buckle closest to the direction the tongue is coming from) for that seating position until you hear a snap and feel the latch engage. Make sure the tongue is latched securely by pulling on it.

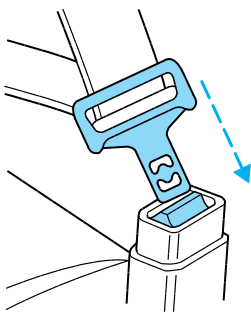

5. To put the retractor in the automatic locking mode, grasp the shoulder portion of the belt and pull downward until all of the belt is extracted and a click is heard.

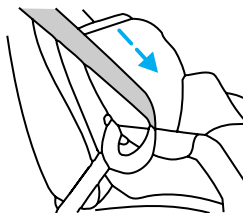

6. Allow the belt to retract. The belt will click as it retracts to indicate it is in the automatic locking mode.

7. Pull the lap belt portion across the child seat toward the buckle and pull up on the shoulder belt while pushing down with your knee on the child seat.

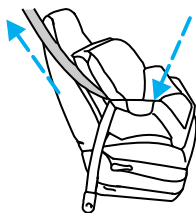

8. Allow the safety belt to retract to remove any slack in the belt.

9. Before placing the child in the seat, forcibly tilt the seat forward and back to make sure the seat is securely held in place.

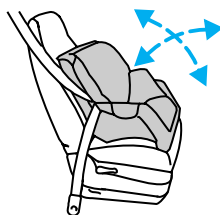

Seating and safety restraints

10. Try to pull the belt out of the retractor to make sure the retractor is in the automatic locking mode (you should not be able to pull more belt out). If the retractor is not locked, unbuckle the belt and repeat steps two through nine.

Check to make sure the child seat is properly secured before each use.

Attaching safety seats with tether straps

Some manufacturers make safety seats that include a tether strap that goes over the back of the vehicle seat and attaches to an anchoring point. Other manufacturers offer the tether strap as an accessory. Contact the manufacturer of your child safety seat for information about ordering a tether strap.

Tether anchorage hardware

Attachment holes (at each rear seating position) have been provided in your vehicle to attach anchor hardware, if required. Tether anchorage hardware kits (part number 613D74) including instructions, may be obtained at no charge from any Ford or Lincoln-Mercury dealer. All vehicles built for sale in Canada include a tether anchor hardware kit.

Be sure to follow the child safety seat manufacturer's instructions.



Tighten the anchor according to specifications. Otherwise, the safety seat may not be properly secured and the child may be injured in a sudden stop or collision.

Starting

PREPARING TO START YOUR VEHICLE

Engine starting is controlled by the ignition system. This system meets all Canadian Interference-Causing Equipment standard requirements regulating the impulse electrical field strength of radio noise.

When starting a fuel-injected engine, avoid pressing the accelerator before or during starting. Only use the accelerator when you have difficulty starting the engine. For more information on starting the vehicle, refer to *Starting the engine* in this chapter.



Extended idling at high engine speeds can produce very high temperatures in the engine and exhaust system, creating the risk of fire or other damage.



Do not park, idle, or drive your vehicle in dry grass or other dry ground cover. The emission system heats up the engine compartment and exhaust system, which can start a fire.



Do not start your vehicle in a closed garage or in other enclosed areas. Exhaust fumes can be toxic. Always open the garage door before you start the engine. See *Guarding against exhaust fumes* in this chapter for more instructions.



If you smell exhaust fumes inside your vehicle, have your dealer inspect your vehicle immediately. Do not drive if you smell exhaust fumes.

Starting

Important safety precautions

A computer system controls the engine's idle revolutions per minute (RPM). When the engine starts, the idle RPM runs faster to warm the engine. If the engine idle speed does not slow down automatically, have the vehicle checked. Do not allow the vehicle to idle for more than ten minutes at high engine RPM.

Before starting the vehicle:

1. Make sure all vehicle occupants have buckled their safety belts. For more information on safety belts and their proper usage, refer to the *Seating and safety restraints* chapter.
2. Make sure the headlamps and vehicle accessories are off.

If starting a vehicle with an automatic transmission:

- Make sure the parking brake is set.

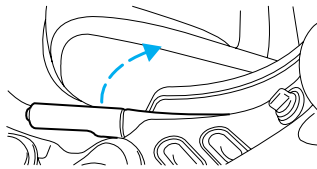

- Make sure the gearshift is in P (Park).

If starting a vehicle with a manual transmission:

- Make sure the parking brake is set.
- Push the clutch pedal to the floor.

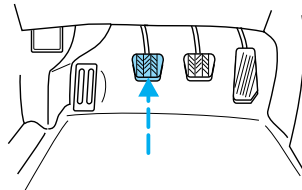

Starting

3. Turn the key to 4 (ON) without turning the key to 5 (START).

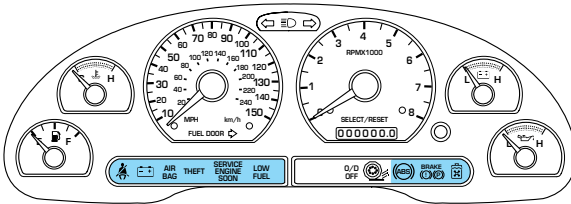
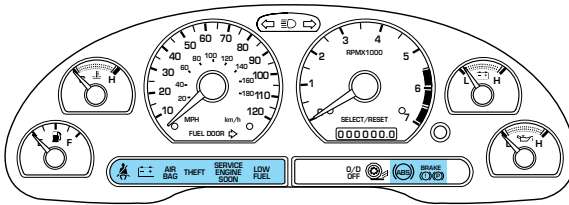
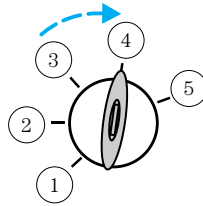

Make sure the corresponding lights illuminate briefly. If a light fails to illuminate, have the vehicle serviced.

- If the driver's safety belt is fastened, the  light may not illuminate.

Starting

STARTING THE ENGINE

1. Turn the key to 5 (START) without pressing the accelerator pedal and release as soon as the engine starts. The key will return to 4 (ON).

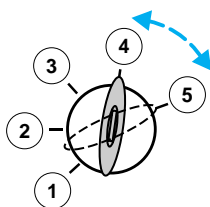

2. If the temperature is above -12°C (10°F) and the engine does not start within five seconds on the first try, turn the key to OFF, wait ten seconds and try again.

3. If the temperature is below -12°C (10°F) and the engine does not start in fifteen seconds on the first try, turn the key OFF and wait ten seconds and try again. If the engine does not start in two attempts, depress the accelerator and start the engine while holding the accelerator down to the floor. Release the accelerator when the engine starts.

4. After idling for a few seconds, apply the brake and release the parking brake.

Using the engine block heater (if equipped)

An engine block heater warms the engine coolant, which improves starting, warms up the engine faster and allows the heater-defroster system to respond quickly. Use of an engine block heater is strongly recommended if you live in a region where temperatures reach -23°C (-10°F) or below.

For best results, plug the heater in at least three hours before starting the vehicle. Using the heater for longer than three hours will not harm the engine, so the heater can be plugged in the night before starting the vehicle.



To prevent electrical shock, do not use your heater with ungrounded electrical systems or two-pronged (cheater) adapters.

Starting

Guarding against exhaust fumes

Although odorless and colorless, carbon monoxide is present in exhaust fumes. Take precautions to avoid its dangerous effects.



If you ever smell exhaust fumes of any kind inside your vehicle, have your dealer inspect and fix your vehicle immediately. Do not drive if you smell exhaust fumes. These fumes are harmful and could kill you.

Have the exhaust and body ventilation systems checked whenever:

- the vehicle is raised for service.
- the sound of the exhaust system changes.
- the vehicle has been damaged in a collision.



Engine exhaust, some of its constituents, and certain vehicle components contain or emit chemicals known to the State of California to cause cancer, and birth defects or other reproductive harm.

Important ventilating information

If the engine is idling while the vehicle is stopped in an open area for long periods of time, open the windows at least 2.5 cm (one inch).

Adjust the heating or air conditioning (if equipped) to bring in fresh air.

Improve vehicle ventilation by keeping all air inlet vents clear of snow, leaves and other debris.

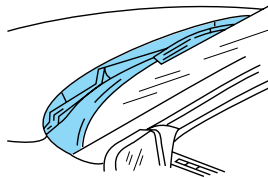

Driving

BRAKES

Your service brakes are self-adjusting. Refer to the scheduled maintenance guide for scheduled maintenance.

Occasional brake noise is normal and often does not indicate a performance concern with the vehicle's brake system. In normal operation, automotive brake systems may emit occasional or intermittent squeal or groan noises when the brakes are applied. Such noises are usually heard during the first few brake applications in the morning; however, they may be heard at any time while braking and can be aggravated by environmental conditions such as cold, heat, moisture, road dust, salt or mud. If a "metal-to-metal," "continuous grinding" or "continuous squeal" sound is present while braking, the brake linings may be worn-out and should be inspected by a qualified service technician.

Anti-lock brake system (ABS) (if equipped)

On vehicles equipped with an anti-lock braking system (ABS), a noise from the hydraulic pump motor and pulsation in the pedal may be observed during ABS braking events. Pedal pulsation coupled with noise while braking under panic conditions or on loose gravel, bumps, wet or snowy roads is normal and indicates proper functioning of the vehicle's anti-lock brake system. The ABS performs a self-check at 17 km/h (10 mph) after you start the engine and begin to drive away. A brief mechanical noise may be heard during this test. This is normal. If a malfunction is found, the ABS warning light will come on. If the vehicle has continuous vibration or shudder in the steering wheel while braking, the vehicle should be inspected by a qualified service technician.

The ABS operates by detecting the onset of wheel lockup during brake applications and compensating for this tendency. The wheels are prevented from locking even when the brakes are firmly applied. The accompanying illustration depicts the advantage of an ABS equipped vehicle (on bottom) to a non-ABS equipped vehicle (on top) during hard braking with loss of front braking traction.

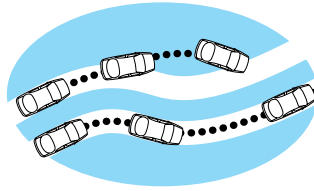

ABS warning lamp

The (ABS) warning lamp in the instrument cluster momentarily illuminates when the ignition is turned on and the engine is off. If the light does not illuminate momentarily at start up, remains on or continues to flash, the ABS needs to be serviced.

With the ABS light on, the anti-lock brake system is disabled and normal braking is still effective unless the brake warning light also remains illuminated with parking brake released. (If your brake warning lamp illuminates, have your vehicle serviced immediately).

BRAKE



Using ABS

- In an emergency or when maximum efficiency from the ABS is required, apply continuous full force on the brake. The ABS will be activated immediately, thus allowing you to retain full steering control of your vehicle and, providing there is sufficient space, will enable you to avoid obstacles and bring the vehicle to a controlled stop.
- The Anti-Lock system does not decrease the time necessary to apply the brakes or always reduce

Driving

stopping distance. Always leave enough room between your vehicle and the vehicle in front of you to stop.

- We recommend that you familiarize yourself with this braking technique. However, avoid taking any unnecessary risks.

Hydraulic brake booster system (Hydroboost)

The Hydroboost system receives fluid pressure from the power steering pump to provide power assist during braking.

The sound of the pump operating may be heard by the driver, but this is a normal characteristic of the system.

For Hydroboost-equipped vehicles operating under normal conditions, the noise of the fluid flowing through the booster may be heard whenever the brake is applied. This condition is normal. Vehicle service is not required.

If braking performance or pedal response becomes very poor, even when the pedal is strongly depressed, it may indicate the presence of air in the hydraulic system or leakage of fluid. Stop the vehicle safely as soon as possible and seek service immediately.

Parking brake

Apply the parking brake whenever the vehicle is parked. To set the parking brake, apply the brake pedal and pull the handle up as far as possible.

The BRAKE warning lamp in the instrument cluster illuminates and remains illuminated (when the ignition is turned ON) until the parking brake is released.

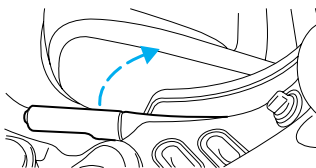

BRAKE



Driving

The parking brake is not recommended to stop a moving vehicle. However, if the normal brakes fail, the parking brake can be used to stop your vehicle in an emergency. Since the parking brake applies only the rear brakes, the vehicle's stopping distance will increase greatly and the handling of your vehicle will be adversely affected.



Always set the parking brake fully and make sure that the gearshift is securely latched in P (Park) (automatic transmission) or in 1 (First) (manual transmission).

Your brake handle may need to be pulled up slightly to release pressure before pushing in the button.

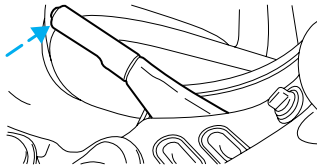

Push the button on the end of the parking brake and push the handle down as far as possible to release the brake. Driving with the parking brake on will cause the brakes to wear out quickly and reduce fuel economy.

TRACTION CONTROL™ (IF EQUIPPED)

Your vehicle may be equipped with the optional Traction Control™ system. This system helps you maintain the stability and steerability of your vehicle. It is especially useful on slippery and/or hilly road surfaces. The system operates by detecting and controlling wheel spin. The system borrows many of the electronic and mechanical elements already present in the anti-lock braking system (ABS).

Wheel-speed sensors allow excess rear wheel spin to be detected by the Traction Control™ portion of the ABS computer. Any excessive wheel spin is controlled by automatically applying and releasing the rear brakes in conjunction with engine torque reductions. Engine torque reduction is realized via

Driving

the fully electronic spark and fuel injection systems. This process is very sensitive to driving conditions and very fast acting. The rear wheels “search” for optimum traction several times a second and adjustments are made accordingly.

The Traction Control™ system will allow your vehicle to make better use of available traction on slippery surfaces. The system is a driver aid which makes your vehicle easier to handle primarily on snow, ice covered and gravel roads.

During Traction Control™ operation, the traction control active light will illuminate, you may hear an electric motor type of sound coming from the engine compartment and the engine will not “rev-up” when you push further on the accelerator. This is normal system behavior.

The Traction Control™ on/off switch, located in front of the gearshift, illuminates when the system is OFF. The Traction Control™ system will revert to the ON position every time the ignition is turned OFF and ON.

If you should become stuck in snow or ice or on a very slippery road surface, try switching the Traction Control™ system off. This may allow excess wheel spin to “dig” the vehicle out and enable a successful “rocking” maneuver.

STEERING

Your vehicle is equipped with power steering. Power steering uses energy from the engine to help steer the vehicle.

To prevent damage to the power steering pump:

- Never hold the steering wheel to the extreme right or the extreme left for more than a few seconds when the engine is running.
- Do not operate the vehicle with a low power steering pump fluid level.

If the power steering system breaks down (or if the engine is turned off), you can steer the vehicle manually, but it takes more effort.

If the steering wanders or pulls, the condition could be caused by any of the following:

- underinflated tire(s) on any wheel(s)
- high crown in center of road
- high crosswinds
- wheels out of alignment
- loose or worn components in steering linkage

AUTOMATIC TRANSMISSION OPERATION (IF EQUIPPED)

Brake-shift interlock

This vehicle is equipped with a brake-shift interlock feature that prevents the gearshift from being moved from P (Park) unless the brake pedal is depressed.

If you cannot move the gearshift out of P (Park) with the brake pedal depressed:

1. Apply the parking brake, turn ignition key to LOCK, then remove the key.
2. Insert the key and turn it to OFF. Apply the brake pedal and shift to N (Neutral).
3. Start the vehicle.

If it is necessary to use the above procedure to move the gearshift, it is possible that a fuse has blown or the vehicle's brakelamps are not operating properly. Refer to *Fuses and relays* in the *Roadside emergencies* chapter.



Do not drive your vehicle until you verify that the brakelamps are working.

If your vehicle gets stuck in mud or snow it may be rocked out by shifting from forward and reverse gears, stopping between shifts, in a steady pattern.

Driving

Press lightly on the accelerator in each gear.

Do not rock the vehicle for more than a few minutes. The transmission and tires may be damaged or the engine may overheat.



Always set the parking brake fully and make sure the gearshift is latched in P (Park). Turn off the ignition whenever you leave your vehicle.



If the parking brake is fully released, but the brake warning lamp remains illuminated, the brakes may not be working properly. See your dealer or a qualified service technician.

Driving with a 4-speed automatic transmission (if equipped)

Understanding gearshift positions

Pull the gearshift lever towards you and downward to move the automatic gearshift.



Hold the brake pedal down while you move the gearshift lever from P (Park) to another position. If you do not hold the brake pedal down, your vehicle may move unexpectedly and injure someone.

Driving

P (Park)

Always come to a complete stop before shifting into P (Park). Make sure the gearshift is securely latched in P (Park). This position locks the transmission and prevents the rear wheels from turning.

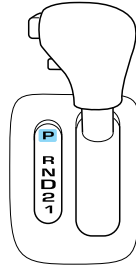

Always set the parking brake fully and make sure the gearshift is securely latched in P (Park).



Never leave your vehicle unattended while it is running.

R (Reverse)

With the gearshift in R (Reverse), the vehicle will move backward. Always come to a complete stop before shifting into and out of R (Reverse).

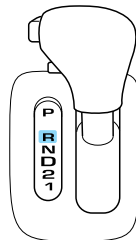

Driving

N (Neutral)

With the gearshift in N (Neutral), the vehicle can be started and is free to roll. Hold the brake pedal down while in this gear.

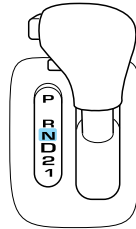

D (Overdrive)

The normal driving position for the best fuel economy. Transmission operates in gears one through four.

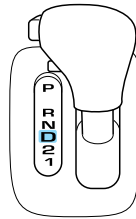

D (Overdrive) can be deactivated by pressing the transmission control switch on the end of the gearshift lever.

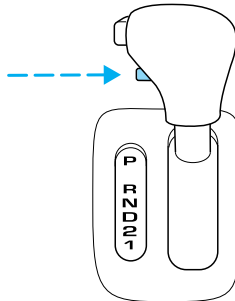

The transmission control indicator light (TCIL) will illuminate on the instrument cluster.

**O/D
OFF**

Drive – Not shown on the display. Activate by pressing the transmission control switch on the end of the gearshift lever with the gearshift in the **D** position. The O/D OFF indicator will illuminate on the instrument cluster. Transmission operates in

gears one through three. **D** (Drive) provides more engine braking than **D** (Overdrive) and is useful when:

- driving with a heavy load
- towing a trailer up or down steep hills
- additional engine braking is desired. If towing a trailer, refer to *Driving while you tow* in the *Trailer Towing* chapter.

To return to **D** (Overdrive) mode, press the transmission control switch. The O/D OFF indicator will no longer be illuminated.

Each time the vehicle is started, the transmission will automatically return to normal overdrive mode.

Every time the vehicle is shut off and restarted, you must press the transmission control switch to cancel overdrive operation if driving in overdrive is not desired.

2 (Second)

Use 2 (Second) to start-up on slippery roads or to provide additional engine braking on downgrades.

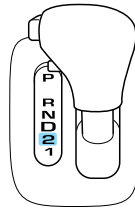

1 (First)

Use 1 (Low) to provide maximum engine braking on steep downgrades. Upshifts can be made by shifting to 2 (Second) or to **D** (Overdrive).

Selecting 1 (Low) at higher speeds causes the transmission to shift to a lower gear, and will shift to 1 (Low) after vehicle decelerates to the proper speed.

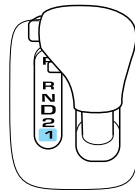

Driving

MANUAL TRANSMISSION OPERATION (IF EQUIPPED)

Using the clutch

Vehicles equipped with a manual transmission have a starter interlock that prevents cranking the engine unless the clutch pedal is fully depressed.

When starting a vehicle with a manual transmission, you must:

1. Put gearshift in N (Neutral).
2. Hold down brake pedal.
3. Depress clutch pedal.

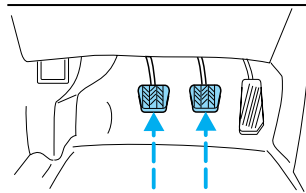
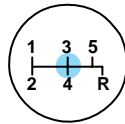

4. Turn ignition to position 5 (START) to start the engine, let the engine idle for a few seconds, then shift into gear.

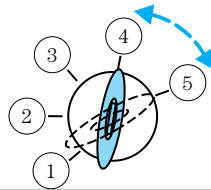

5. Release the brake pedal.
6. Release clutch slowly while pressing down slowly on the accelerator pedal.

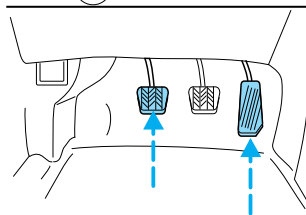

- Do not drive with your foot resting on the clutch pedal and do not use the clutch to hold your vehicle at a standstill while waiting on a hill. These actions will seriously reduce clutch life.

Recommended shift speeds

Do not downshift into 1 (first) when your vehicle is moving faster than 24 km/h (15 mph). This will damage the clutch.

Upshift and downshift according to the following chart:

Upshifts when accelerating (recommended for best fuel economy)	
Shift from:	
1 - 2	18 km/h (11 mph)
2 - 3	31 km/h (19 mph)
3 - 4	48 km/h (30 mph)
4 - 5	64 km/h (40 mph)

Parking your vehicle

1. Disengage the clutch, apply brake and shift into N (Neutral).

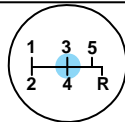
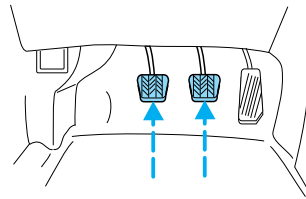

2. Set parking brake.
3. Shift into 1 (First).

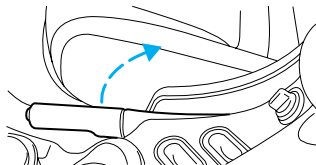

Driving

4. Turn the ignition key to position 3 (OFF).

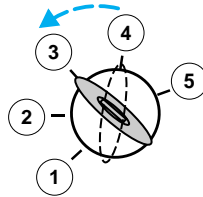

Do not park your vehicle in Neutral, it may move unexpectedly and injure someone. Use 1 (First) gear and set the parking brake fully.

Reverse

You can shift into R (Reverse) only by moving the gearshift to the right of 5 (Fifth) gear before you shift into R (Reverse). This is a feature that protects you from accidentally shifting into R (Reverse) when you downshift from 5 (Fifth).

Make sure that your vehicle is at a complete stop before you shift into R (Reverse). Failure to do so may damage the transmission.

To shift into R (Reverse):

1. Bring your vehicle to a complete stop.
2. Push the clutch pedal all the way to the floor.
3. Move the gearshift all the way to the right and pull it back into R (Reverse).
4. Slowly release the clutch pedal.

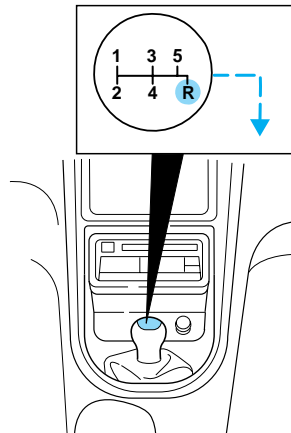

If R (Reverse) is not engaged, continue to push the clutch pedal in while you put the

gearshift back into Neutral. Then, release the clutch pedal for a moment and repeat steps 2 through 4.

Removing key from ignition

- Turn the ignition key to position 3 (OFF).
- Push the release lever forward and rotate the key towards you and remove.

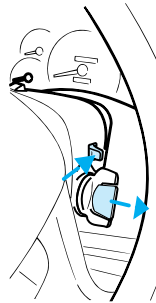

TRACTION-LOK AXLE (IF EQUIPPED)

This axle provides added traction on slippery surfaces, particularly when one wheel is on a poor traction surface. Under normal conditions, the Traction-Lok axle functions like a standard rear axle.

Extended use of other than the manufacturer's specified size tires on a Traction-Lok rear axle could result in a permanent reduction in effectiveness. This loss of effectiveness does not affect normal driving and should not be noticeable to the driver.



To avoid injury, never run the engine with one wheel off the ground, such as when changing a tire.

VEHICLE LOADING

Before loading a vehicle, familiarize yourself with the following terms:

- **Base Curb Weight:** Weight of the vehicle including any standard equipment, fluids, lubricants, etc. It does not include passengers or aftermarket equipment.

Driving

- **Payload:** Combined maximum allowable weight of cargo, passengers and optional equipment. The payload equals the gross vehicle weight rating minus base curb weight.
- **GVW (Gross Vehicle Weight):** Base curb weight plus payload weight. The GVW is not a limit or a specification.
- **GVWR (Gross Vehicle Weight Rating):** Maximum total weight of the base vehicle, passengers, optional equipment and cargo. The GVWR is specific to each vehicle and is listed on the Safety Compliance Label on the driver's door pillar.
- **GAWR (Gross Axle Weight Rating):** Carrying capacity for each axle system. The GAWR is specific to each vehicle and is listed on the Safety Compliance Label on the driver's door pillar.
- **GCW (Gross Combined Weight):** The combined weight of the towing vehicle (including passengers and cargo) and the trailer.
- **GCWR (Gross Combined Weight Rating):** Maximum combined weight of towing vehicle (including passengers and cargo) and the trailer. The GCWR indicates the maximum loaded weight that the vehicle is designed to tow.
- **Maximum Trailer Weight Rating:** Maximum weight of a trailer the vehicle is permitted to tow. The maximum trailer weight rating is determined by subtracting the vehicle curb weight for each engine/transmission combination, any required option weight for trailer towing and the weight of the driver from the GCWR for the towing vehicle.
- **Maximum Trailer Weight:** Maximum weight of a trailer the loaded vehicle (including passengers and cargo) is permitted to tow. It is determined by subtracting the weight of the loaded trailer towing vehicle from the GCWR for the towing vehicle.

Driving

- **Trailer Weight Range:** Specified weight range that the trailer must fall within that ranges from zero to the maximum trailer weight rating.

Remember to figure in the tongue load of your loaded trailer when figuring the total weight.



Do not exceed the GVWR or the GAWR specified on the Safety Compliance Certification Label.

Do not use replacement tires with lower load carrying capacities than the originals because they may lower the vehicle's GVWR and GAWR limitations. Replacement tires with a higher limit than the originals do not increase the GVWR and GAWR limitations.

The Certification Label, found on the inside pillar of the driver's door, lists several important vehicle weight rating limitations. Before adding any additional equipment, refer to these limitations. If you are adding weight to the front of your vehicle, (potentially including weight added to the cab), the weight added should not exceed the Front Axle Reserve Capacity (FARC). Additional frontal weight may be added to the front axle reserve capacity provided you limit your payload in other ways (i.e. restrict the number of passengers or amount of cargo carried).

You may add equipment throughout your vehicle if the total weight added is equal to or less than the Total Axle Reserve Capacity (TARC) weight. You should NEVER exceed the Total Axle Reserve Capacity.

Always ensure that the weight of passengers, cargo and equipment being carried is within the weight limitations that have been established for your vehicle including both Gross Vehicle Weight and Front and Rear Gross Axle Weight Rating limits. Under no circumstance should these limitations be exceeded. Exceeding any vehicle weight rating

Driving

limitation could result in serious damage to the vehicle and/or personal injury.

TRAILER TOWING

Your vehicle is capable of towing a trailer up to 454 kg (1 000 lbs.) gross trailer weight with a maximum tongue load of 45 kg (100 lbs.). Do not tow a trailer until your vehicle has been driven at least 800 km (500 miles).

Towing a trailer places an additional load on your vehicle's engine, transmission, axles, brakes, tires and suspension. Inspect these components carefully after towing.



Do not exceed the GVWR or the GAWR specified on the Safety Compliance Certification Label.



Towing trailers beyond the maximum recommended gross trailer weight could result in engine damage, transmission/axle damage, structural damage, loss of control, and personal injury.

Preparing to tow

Use the proper equipment for towing a trailer, and make sure it is properly attached to your vehicle. See your dealer or a reliable trailer dealer if you require assistance.

Safety chains

Always connect the trailer's safety chains to the vehicle. To connect the trailer's safety chains, cross the chains under the trailer tongue and allow slack for turning corners.

If you use a rental trailer, follow the instructions that the rental agency gives to you.

Do not attach safety chains to the bumper.

Trailer brakes

Electric brakes and manual, automatic or surge-type brakes are safe if installed properly and adjusted to the manufacturer's specifications. The trailer brakes must meet local and Federal regulations.



Do not connect a trailer's hydraulic brake system directly to your vehicle's brake system. Your vehicle may not have enough braking power and your chances of having a collision greatly increase.

The braking system of the tow vehicle is rated for operation at the GVWR not GCWR.

Trailer lamps

Trailer lamps are required on most towed vehicles. Make sure your trailer lamps conform to local and Federal regulations. See your dealer or trailer rental agency for proper instructions and equipment for hooking up trailer lamps.

Driving while you tow

Do not drive faster than 88 km/h (55 mph) when towing a trailer.

Speed control may shut off if you are towing on long, steep grades.

When towing a trailer:

- Use a lower gear when towing up or down steep hills. This will eliminate excessive downshifting and upshifting for optimum fuel economy and transmission cooling.
- Anticipate stops and brake gradually.

Exceeding the GCWR rating may cause internal transmission damage and void your warranty coverage.

Driving

Servicing after towing

If you tow a trailer for long distances, your vehicle will require more frequent service intervals. Refer to your Scheduled Maintenance guide for more information.

Trailer towing tips

- Practice turning, stopping and backing up in an area before starting on a trip to get the feel of the vehicle trailer combination. When turning, make wider turns so the trailer wheels will clear curbs and other obstacles.
- Allow more distance for stopping with a trailer attached.
- The trailer tongue weight should be 10% of the loaded trailer weight.
- After you have traveled 80 km (50 miles), thoroughly check your hitch, electrical connections and trailer wheel lug nuts.
- When stopped in traffic for long periods of time in hot weather, place the gearshift in P (Park) and increase idle speed. This aids engine cooling and air conditioner efficiency.
- Vehicles with trailers should not be parked on a grade. If you must park on a grade, place wheel chocks under the trailer's wheels.

DRIVING THROUGH WATER

Do not drive quickly through standing water, especially if the depth is unknown. Traction or brake capability may be limited and if the ignition system gets wet, your engine may stall. Water may also enter your engine's air intake and severely damage your engine.

If driving through deep or standing water is unavoidable, proceed very slowly. Never drive through water that is higher than the bottom of the hubs.

Driving

Once through the water, always try the brakes. Wet brakes do not stop the vehicle as effectively as dry brakes. Drying can be improved by moving your vehicle slowly while applying light pressure on the brake pedal.

Driving through deep water where the transmission is submerged may allow water into the transmission and cause internal transmission damage.

Roadside emergencies

HAZARD FLASHER

Use only in an emergency to warn traffic of vehicle breakdown, approaching danger, etc. The hazard flashers can be operated when the ignition is off.

- The hazard lights control is located on top of the steering column.
- Depress hazard lights control to activate all hazard flashers simultaneously.
- Depress control again to turn the flashers off.

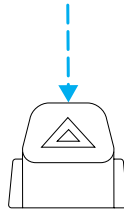

FUEL PUMP SHUT-OFF SWITCH

After a collision, if the engine cranks but does not start, the fuel pump shut-off switch may have been activated. The shut-off switch is a device intended to stop the electric fuel pump when your vehicle has been involved in a substantial jolt.

1. Turn the ignition to the OFF position.
2. Check the fuel system for leaks.
3. If no fuel leak is apparent, reset the fuel pump shut-off switch by pushing in the reset button.
4. Turn the ignition to the ON position. Pause for a few seconds and return the key to the OFF position.
5. Make a further check for leaks in the fuel system.

Roadside emergencies

The fuel pump shut-off switch is located on the left side of the trunk behind the trunk liner.

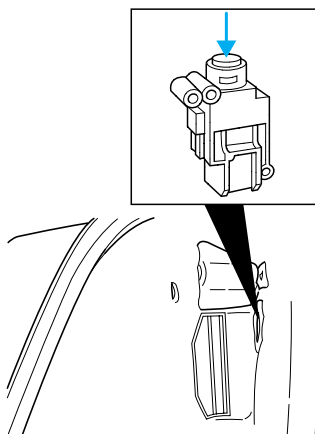

FUSES AND RELAYS

Fuses

If electrical components in the vehicle are not working, a fuse may have blown. Blown fuses are identified by a broken wire within the fuse. Check the appropriate fuses before replacing any electrical components.

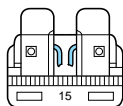

Always replace a fuse with one that has the specified amperage rating. Using a fuse with a higher amperage rating can cause severe wire damage and could start a fire.

Roadside emergencies

Standard fuse amperage rating and color

COLOR					
Fuse Rating	Mini Fuses	Standard Fuses	Maxi Fuses	Cartridge Maxi Fuses	Fuse Link Cartridge
2A	Grey	Grey	—	—	—
3A	Violet	Violet	—	—	—
4A	Pink	Pink	—	—	—
5A	Tan	Tan	—	—	—
7.5A	Brown	Brown	—	—	—
10A	Red	Red	—	—	—
15A	Blue	Blue	—	—	—
20A	Yellow	Yellow	Yellow	Blue	Blue
25A	Natural	Natural	—	—	—
30A	Green	Green	Green	Pink	Pink
40A	—	—	Orange	Green	Orange
50A	—	—	Red	Red	Red
60A	—	—	Blue	—	Yellow
70A	—	—	Tan	—	Brown
80A	—	—	Natural	—	Black

Passenger compartment fuse panel

The fuse panel is located below and to the left of the steering wheel by the brake pedal. Remove the panel cover to access the fuses.

To remove a fuse use the fuse puller tool provided on the fuse panel cover.

Roadside emergencies

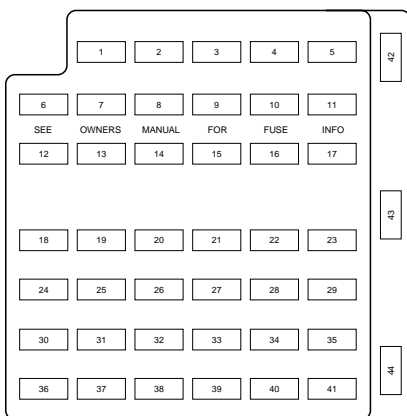

The fuses are coded as follows:

Fuse/Relay Location	Fuse Amp Rating	Description
1	20A	Cigar Lighter
2	20A	Engine Controls
3	—	Not Used
4	10A	RH Low Beam Headlamp
5	15A	Instrument Cluster, Traction Control Switch
6	20A	Starter Motor Relay
7	15A	GEM, Interior Lamps
8	20A	Engine Controls
9	—	Not Used
10	10A	LH Low Beam Headlamp
11	15A	Back-up Lamps
12	—	Not Used
13	15A	Electronic Flasher
14	—	Not Used

Roadside emergencies

Fuse/Relay Location	Fuse Amp Rating	Description
15	15A	Power Lumbar
16	—	Not Used
17	15A	Speed Control Servo, Shift Lock Actuator
18	15A	Electronic Flasher
19	15A	Power Mirror Switch, GEM, Anti-Theft Relay, Power Door Locks, Door Ajar Switches
20	15A	Convertible Top Switch
21	5A	Instrument Cluster and Engine Control Memory
22	—	Not Used
23	15A	A/C Clutch, Defogger Switch
24	30A	Climate Control Blower Motor
25	25A	Luggage Compartment Lid Release
26	30A	Wiper/Washer Motor, Wiper Relays
27	25A	Radio
28	15A	GEM, Overdrive Cancel Switch
29	15A	ABS Module
30	15A	DRL Module
31	10A	Data Link Connector
32	15A	Radio, CD Player, GEM
33	15A	Stop Lamp Switch, Speed Control Deactivation Switch

Roadside emergencies

Fuse/Relay Location	Fuse Amp Rating	Description
34	20A	Instrument Cluster, CCRM, Data Link Connector, Securilock Transceiver Module
35	15A	Shift Lock Actuator, PCM, Speed Control Servo, ABS Module
36	15A	Airbag Control Module
37	10A	Adjustable Illumination
38	20A	Highbeams
39	5A	GEM
40	—	Not Used
41	15A	Brake Lamp
42	—	Not Used
43	20A CB	Power Windows
44	—	Not Used

Power distribution box

The power distribution box is located in the engine compartment. The power distribution box contains high-current fuses that protect your vehicle's main electrical systems from overloads.



Always disconnect the battery before servicing high current fuses.

Roadside emergencies



Always replace the cover to the Power Distribution Box before reconnecting the battery or refilling fluid reservoirs.

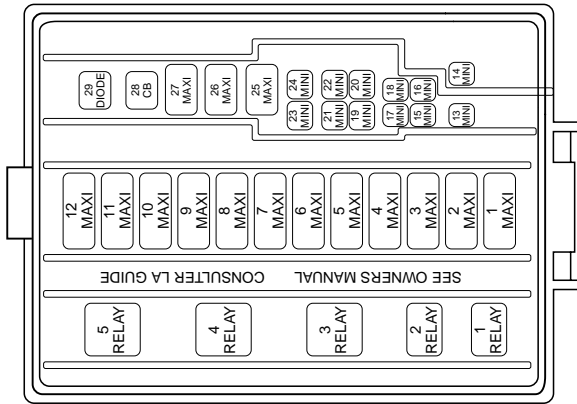

The high-current fuses are coded as follows.

Fuse/Relay Location	Fuse Amp Rating	Description
Relay 1	—	Fog Lamp Interrupt
Relay 2	—	Int. Wiper
Relay 3	—	Wiper HI/LO
Relay 4	—	Starter
Relay 5	—	Fog Lamps
1	50A** (4.6L), 30A CB (3.8L)	Electric Cooling Fan Motor
2	30A**	Headlamps
3	40A**	Starter Motor Relay, Ignition Switch
4	40A**	Ignition Switch
5	40A**	Ignition Switch
6	40A**	Instrument Cluster, PCM

Roadside emergencies

Fuse/Relay Location	Fuse Amp Rating	Description
7	30A**	Secondary Air Injection (3.8L only)
8	50A**	ABS Module
9	20A**	Auxiliary Power Point
10	30A**	Parklamps
11	30A**	Rear Window Defrost Control
12	40A**	Power Windows, Power Locks
13	—	Not Used
14	20A*	Fuel Pump
15	10A*	Radio
16	20A*	Horn
17	20A*	Anti-Lock Brake System
18	25A*	Power Seats
19	—	Not Used
20	20A*	Generator
21	—	Not Used
22	—	Not Used
23	—	Not Used
24	20A*	A/C Pressure (3.8L only)
25	—	Not Used
26	30A**	PCM
27	20A**	DRL Module, Foglamp Relay
28	25A CB	Convertible Top
* Mini Fuses ** Maxi Fuses		

CHANGING THE TIRES

If you get a flat tire while driving, do not apply the brake heavily. Instead, gradually decrease your speed. Hold the steering wheel firmly and slowly move to a safe place on the side of the road.

Roadside emergencies

Temporary spare tire information

Your vehicle may have a temporary spare tire. The temporary spare tire for your vehicle is labeled as such. It is smaller than a regular tire and is designed for emergency use only. Replace this tire with a full-size tire as soon as possible.



If you use the temporary spare tire continuously or do not follow these precautions, the tire could fail, causing you to lose control of the vehicle, possibly injuring yourself or others.

When driving with the temporary spare tire **do not:**

- exceed 80 km/h (50 mph) under any circumstances
- load the vehicle beyond maximum vehicle load rating listed on the Safety Compliance Label
- tow a trailer
- use tire chains
- drive through an automatic car wash, because of the vehicle's reduced ground clearance
- try to repair the temporary spare tire or remove it from its wheel
- use the wheel for any other type of vehicle

Tire change procedure



To prevent the vehicle from moving when you change a tire, be sure the parking brake is set, then block (in both directions) the wheel that is diagonally opposite (other side and end of the vehicle) to the tire being changed.



If the vehicle slips off the jack, you or someone else could be seriously injured.

Roadside emergencies

1. Park on a level surface, activate hazard flashers and set parking brake.

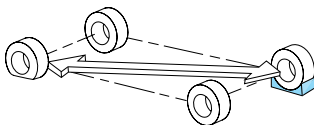

2. Place gearshift lever in P (Park) or R (manual transmission), turn engine OFF, and block the diagonally opposite wheel.

3. Remove the spare tire, jack and lug wrench.

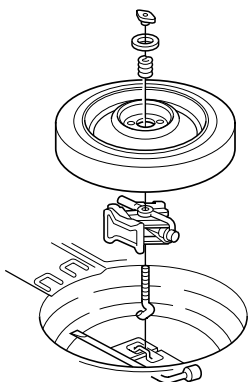

4. Loosen each wheel lug nut one-half turn counterclockwise but do not remove them until the wheel is raised off the ground.

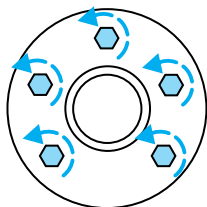

5. Put the jack in the jack notch next to the tire you are changing. Turn the jack handle clockwise until the wheel is completely off the ground.

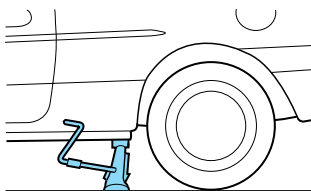

Roadside emergencies

Never use the rear differential as a jacking point.



To lessen the risk of personal injury, do not put any part of your body under the vehicle while changing a tire. Do not start the engine when your vehicle is on the jack. The jack is only meant for changing the tire.

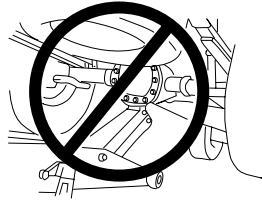

6. Remove the lug nuts with the lug wrench.

7. Replace the flat tire with the spare tire, making sure the valve stem is facing outward. Reinstall lug nuts until the wheel is snug against the hub. Do not fully tighten the lug nuts until the wheel has been lowered.

If you are using a temporary tire, the lug nut washers will not appear to be flush with the rim. This is normal when using the temporary spare tire only.

8. Lower the wheel by turning the jack handle counterclockwise.

9. Remove the jack and fully tighten the lug nuts in the order shown.

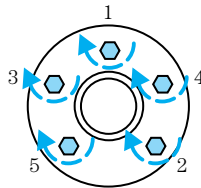

10. Put flat tire, jack and lug wrench away. Make sure jack is fastened so it does not rattle when you drive.

11. Unblock the wheels.

Roadside emergencies

12. If using a mini-spare tire, turn off the traction control switch.

Anti-theft lug nuts (if equipped)

If your vehicle is equipped with this feature, one of the lug nuts on each wheel



must be removed and replaced with a special key. The key and registration card are attached to the lug wrench and stored with the spare tire. If you lose the key, send the registration card to the manufacturer (not the dealer) to get a replacement key. If the lug wrench/lug nut key assembly is lost, see your nearest Ford or Lincoln/Mercury dealer who has access to the master set of keys. **Do not use an impact wrench with the anti-theft key.**

Removing the anti-theft lug nut

1. Insert the key over the locking lug nut. Make sure you hold the key square to the lug nut. If you hold the key at an angle, you could damage the key and the lug nut.
2. Place the lug nut wrench over the lug nut key and apply pressure on the key with the wrench.
3. Turn the wrench in a counterclockwise direction to remove the lug nut.

Reinstalling the anti-theft lug nut

1. Insert the key over the locking lug nut.
2. Place the lug nut wrench over the lug nut key and apply pressure on the key with the wrench.
3. Install the lug nut.

Roadside emergencies

JUMP STARTING YOUR VEHICLE



The gases around the battery can explode if exposed to flames, sparks, or lit cigarettes. An explosion could result in injury or vehicle damage.



Do not push start your vehicle. You could damage the catalytic converter.



Batteries contain sulfuric acid which can burn skin, eyes, and clothing, if contacted.

Do not attempt to push start your vehicle. Automatic transmissions do not have push-start capability.

Preparing your vehicle

- 1. Use only a 12-volt supply to start your vehicle.**
2. Do not disconnect the battery of the disabled vehicle as this could damage the vehicle's electrical system.
3. Park the booster vehicle close to the hood of the disabled vehicle making sure the two vehicles **do not** touch. Set the parking brake on both vehicles and stay clear of the engine cooling fan and other moving parts.
4. Check all battery terminals and remove any excessive corrosion before you attach the battery cables. Ensure that vent caps are tight and level.
5. Turn the heater fan on in both vehicles to protect any electrical surges. Turn all other accessories off.

Roadside emergencies

Connecting the jumper cables

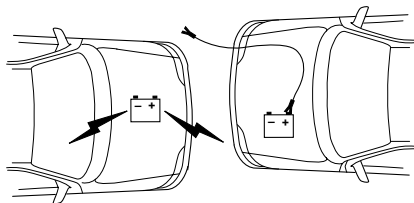

1. Connect the positive (+) booster cable to the positive (+) terminal of the discharged battery.

Note: In the illustrations, *lightning bolts* are used to designate the assisting (boosting) battery.

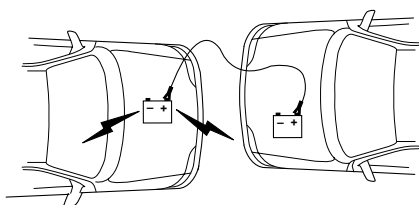

2. Connect the other end of the positive (+) cable to the positive (+) terminal of the assisting battery.

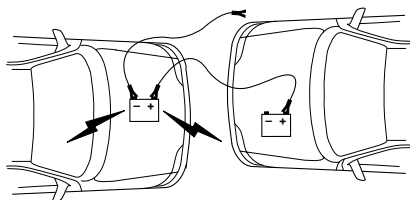

3. Connect the negative (-) cable to the negative (-) terminal of the assisting battery.

Roadside emergencies

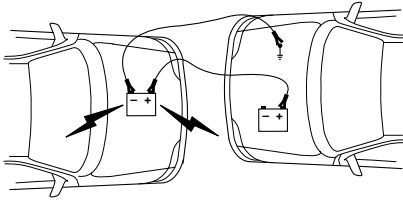

4. Make the final connection of the negative (-) cable to an exposed metal part of the stalled vehicle's engine, away from the battery and the carburetor.

The preferred locations of an exposed metal part (to *ground* the circuit) are the alternator mounting brackets or an engine lifting *eye*. **Do not** use fuel lines, engine rocker covers or the intake manifold as *grounding* points.



Do not connect the end of the second cable to the negative (-) terminal of the battery to be jumped. A spark may cause an explosion of the gases that surround the battery.

5. Be sure that the cables are clear of fan blades, belts and other moving parts of both engines.

Jump starting

1. Start the engine of the booster vehicle and run the engine at moderately increased speed.
2. Start the engine of the disabled vehicle.
3. Once the disabled vehicle has been started, run both engines for a further three minutes before disconnecting the jumper cables.

Roadside emergencies

Removing the jumper cables

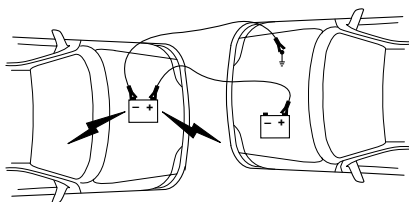

Remove the jumper cables in the reverse order that they were connected.

1. Remove the jumper cable from the *ground* metal surface.

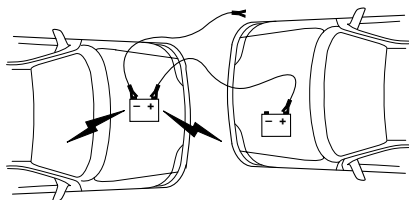

2. Remove the jumper cable on the negative (-) connection of the booster vehicle's battery.

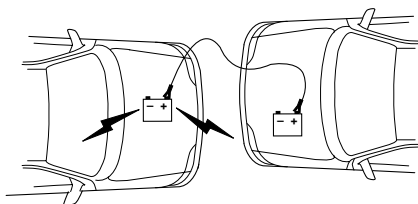

3. Remove the jumper cable from the positive (+) terminal of the booster vehicle's battery.

Roadside emergencies

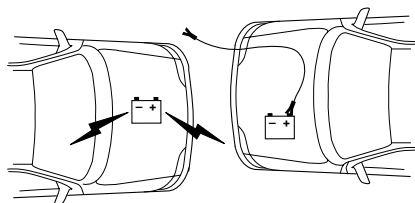

4. Remove the jumper cable from the positive (+) terminal of the disabled vehicle's battery.

After the disabled vehicle has been started and the jumper cables removed, allow it to idle for several minutes so the engine computer can *relearn* its idle conditions.

WRECKER TOWING

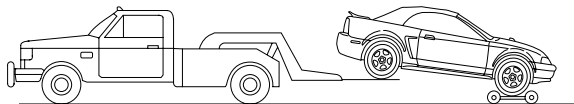
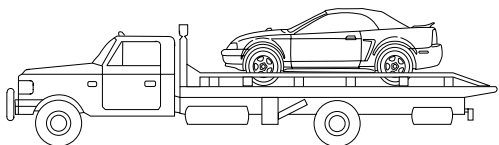

If you need to have your vehicle towed, contact a professional towing service or, if you are a member, your roadside assistance center.

Roadside emergencies

It is recommended that your vehicle be towed with a wheel lift or flatbed equipment.

However, on Mustang and Mustang GT models, a slingbelt with T-hooks can also be used.

Do not tow Cobra or Convertible models with a slingbelt. Ford Motor Company has not approved a slingbelt towing procedure for these vehicles.

If your vehicle is to be towed from the rear using wheel lift equipment or a slingbelt, the front wheels must be placed on a dolly to prevent damage to the front fascia (bumper).

A towing manual is available from Ford Motor Company for all authorized tow truck operators. Have your tow truck driver refer to this manual for proper hook-up and towing procedures for your vehicle.

Maintenance and care

SERVICE RECOMMENDATIONS

To help you service your vehicle:

- We highlight do-it-yourself items in the engine compartment for easy location.
- We provide a Scheduled Maintenance Guide which makes tracking routine service easy.

If your vehicle requires professional service, your dealership can provide necessary parts and service. Check your “Warranty Guide” to find out which parts and services are covered.

Use only recommended fuels, lubricants, fluids and service parts conforming to specifications. Motorcraft parts are designed and built to provide the best performance in your vehicle.

PRECAUTIONS WHEN SERVICING YOUR VEHICLE

Be especially careful when inspecting or servicing your vehicle.

- Do not work on a hot engine.
- When the engine is running, keep loose clothing, jewelry or long hair away from moving parts.
- Do not work on a vehicle with the engine running in an enclosed space, unless you are sure you have enough ventilation.
- Keep all lit cigarettes, open flames and other lit material away from the battery and all fuel related parts.

If you disconnect the battery, the engine must “relearn” its idle conditions before your vehicle will drive properly, as explained in the *Battery* section in this chapter.

Maintenance and care

Working with the engine off

- Automatic transmission:
 1. Set the parking brake and ensure the gearshift is securely latched in P (Park).
 2. Turn off the engine and remove the key.
 3. Block the wheels to prevent the vehicle from moving unexpectedly.
- Manual transmission:
 1. Set the parking brake.
 2. Depress the clutch and place the gearshift in 1 (First).
 3. Turn off the engine and remove the key.
 4. Block the wheels to prevent the vehicle from moving unexpectedly.

Working with the engine on

- Automatic transmission:
 1. Set the parking brake and ensure the gearshift is securely latched in P (Park).
 2. Block the wheels to prevent the vehicle from moving unexpectedly.



Do not start your engine with the air cleaner removed and do not remove it while the engine is running.

- Manual transmission:
 1. Set the parking brake, depress the clutch and place the gearshift in N (Neutral).
 2. Block the wheels to prevent the vehicle from moving unexpectedly.



Do not start your engine with the air cleaner removed and do not remove it while the engine is running.

Maintenance and care

OPENING THE HOOD

1. Inside the vehicle, pull the hood release handle located under the bottom left corner of the instrument panel.

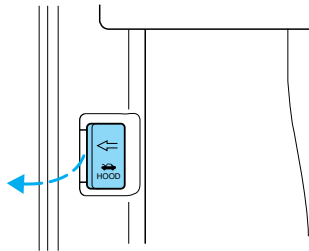

2. Go to the front of the vehicle and release the auxiliary latch that is located under the front center of the hood.

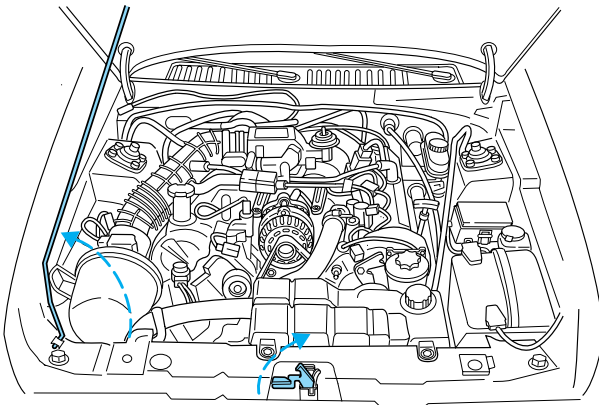

3. Lift the hood and secure it with the prop rod.

Maintenance and care

IDENTIFYING COMPONENTS IN THE ENGINE COMPARTMENT

3.8L OHV V6 engine

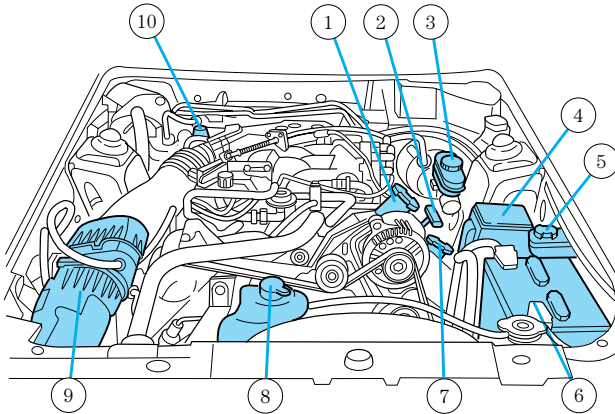

1. Engine oil filler cap
2. Engine oil dipstick
3. Brake fluid reservoir
4. Power distribution box
5. Windshield washer fluid reservoir
6. Battery
7. Power steering fluid reservoir
8. Engine coolant reservoir
9. Air filter assembly
10. Automatic transmission fluid dipstick (if equipped)

Maintenance and care

4.6L SOHC V8 engine

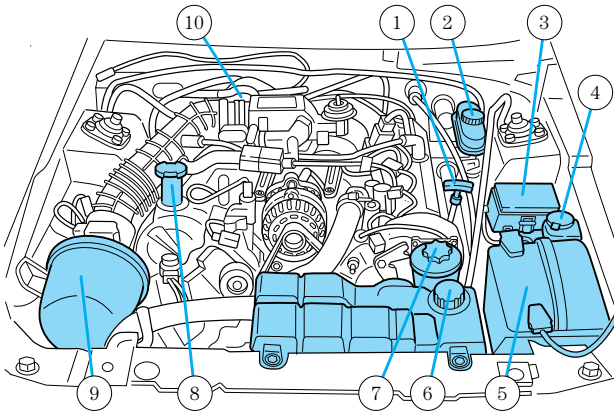

1. Engine oil dipstick
2. Brake fluid reservoir
3. Power distribution box
4. Windshield washer fluid reservoir
5. Battery
6. Engine coolant reservoir
7. Power steering fluid reservoir
8. Engine oil filler cap
9. Air filter assembly
10. Automatic transmission fluid dipstick (if equipped)

ENGINE OIL

Checking the engine oil

Refer to the Scheduled Maintenance Guide for the appropriate intervals for checking the engine oil.

1. Make sure the vehicle is on level ground.

Maintenance and care

2. Turn the engine off and wait a few minutes for the oil to drain into the oil pan.
 3. Set the parking brake and ensure the gearshift is securely latched in P (Park) (automatic transmissions) or 1 (First) (manual transmissions).
 4. Open the hood. Protect yourself from engine heat.
 5. Locate and carefully remove the engine oil level indicator (dipstick).
- 3.8L OHV V6 engine

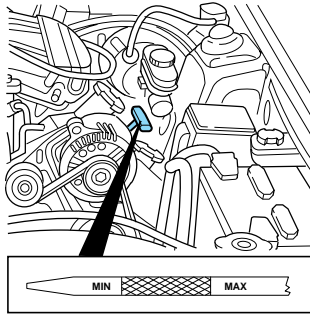

- 4.6L SOHC V8 engine

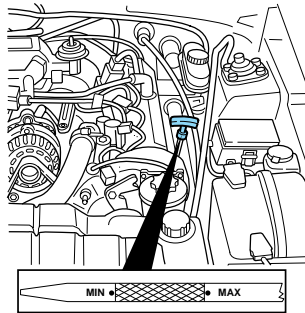

6. Wipe the indicator clean. Insert the indicator fully, then remove it again.
- If the oil level is **between the MIN—MAX marks**, the oil level is acceptable. **DO NOT ADD OIL.**

Maintenance and care

- If the oil level is below the MIN mark, add enough oil to raise the level within the MIN—MAX range.

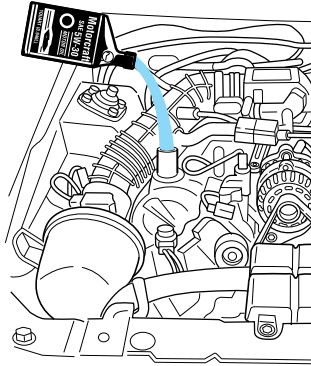

- Oil levels above the MAX mark may cause engine damage. Some oil must be removed from the engine by a service technician.

7. Put the indicator back in and ensure it is fully seated.

Adding engine oil

1. Check the engine oil. For instructions, refer to *Checking the engine oil* in this chapter.
2. If the engine oil level is not within the normal range, add only certified engine oil of the recommended viscosity. Remove the engine oil filler cap and use a funnel to pour the engine oil into the opening.
3. Recheck the engine oil level. Make sure the oil level is not above the F in FULL mark on the dipstick.

Maintenance and care

Engine oil and filter recommendations

Look for this certification mark.

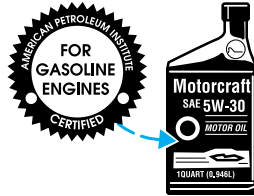

Ford oil specification is WSS-M2C153-G.

Use SAE 5W-30 motor oil certified for gasoline engines by the American Petroleum Institute.

Do not use supplemental engine oil additives, oil treatments or engine treatments. They are unnecessary and could, under certain conditions, lead to engine damage which is not covered by your warranty.

Change your engine oil and filter according to the appropriate schedule listed in the Scheduled Maintenance Guide.

Ford production and aftermarket (Motorcraft) oil filters are designed for added engine protection and long life. If a replacement oil filter is used that does not meet Ford material and design specifications, startup engine noises or knock may be experienced.

It is recommended you use the appropriate Motorcraft oil filter (or another brand meeting Ford specifications) for your engine application.

BRAKE FLUID

Checking and adding brake fluid

Brake fluid should be checked and refilled as needed. Refer to the Scheduled Maintenance Guide for the service interval schedules:

Maintenance and care

- 3.8L OHV V6 engine

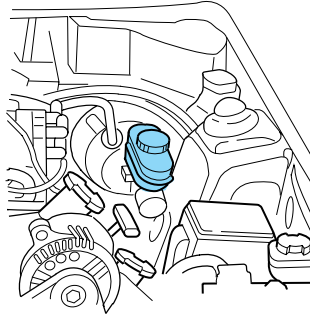

- 4.6L SOHC V8 engine

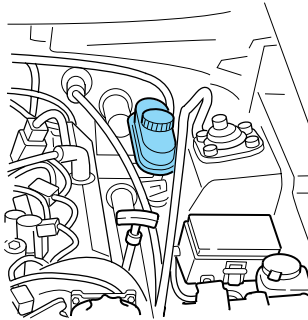

1. Clean the reservoir cap before removal to prevent dirt or water from entering the reservoir.
2. Visually inspect the fluid level.
3. If necessary, add brake fluid until the level reaches MAX. Do not fill above this line.
4. Use only a DOT 3 brake fluid certified to meet Ford specifications. Refer to *Lubricant specifications* in the *Capacities and specifications* chapter.

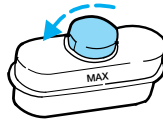

Brake fluid is toxic.

Maintenance and care



If you use a brake fluid that is not DOT 3, you will cause permanent damage to your brakes.



Do not let the reservoir for the master cylinder run dry. This may cause the brakes to fail.

CLUTCH ADJUSTMENT (IF EQUIPPED)

Check the clutch adjustment. Refer to the Scheduled Maintenance Guide for the service interval schedules.

The clutch on your vehicle is operated by a cable. As necessary, adjust the clutch as described below.

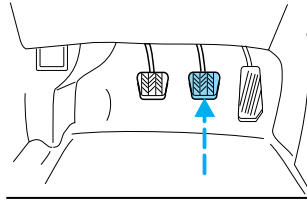

1. Turn the engine off and shift into 1 (First).
2. Put your foot under the clutch pedal and gently pull it up until the pedal stops.
3. Push the clutch pedal down slowly. You will hear a click as the clutch adjusts itself.

Maintenance and care

WINDSHIELD WASHER FLUID

Checking and adding washer fluid

Check the washer fluid whenever you stop for fuel. The reservoir is highlighted with a  symbol.

If the level is low, add enough fluid to fill the reservoir. In very cold weather, do not fill the reservoir all the way.

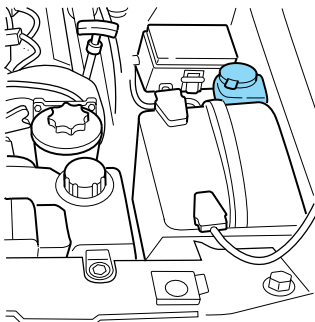

Do not put engine coolant in the container for the windshield washer fluid.

Maintenance and care

ENGINE COOLANT

- 3.8L OHV V6 engine

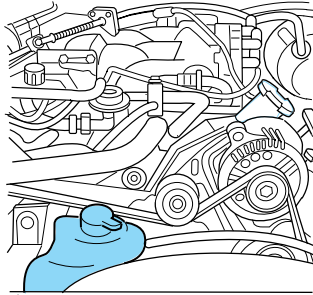

- 4.6L V8 engine

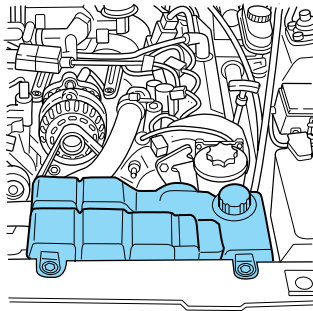

Check the level of the engine coolant in the reservoir. Refer to the Scheduled Maintenance Guide for service interval schedules. Be sure to read and understand *Precautions when servicing your vehicle* in this chapter.

If the engine coolant has not been checked at the recommended interval, the engine coolant reservoir may become empty. If this occurs, add engine coolant to the coolant reservoir. For more information on engine coolant maintenance, refer to *Adding engine coolant* in this chapter.

Automotive fluids are not interchangeable; do not use engine coolant, antifreeze or windshield washer fluid outside of its specified function and vehicle location.

Maintenance and care

Adding engine coolant



Do not put engine coolant in the container for the windshield washer fluid.

Do not mix conventional green coolant, orange coolant or recycled coolants together in your vehicle. Use only the type of coolant that your vehicle was originally equipped with. If you are unsure which type of coolant your vehicle requires, contact your local dealer.

If sprayed on the windshield, engine coolant could make it difficult to see through the windshield.

When the engine is cool, add a 50/50 mixture of engine coolant and water to the engine coolant reservoir—DO NOT ADD DIRECTLY TO THE RADIATOR. Add straight water only in an emergency, but you should replace it with a 50/50 mixture of coolant and distilled water as soon as possible.

Check the coolant level in the coolant reservoir the next few times you drive the vehicle. If necessary, add enough of a 50/50 mixture of coolant and water to bring the liquid level to the fill line on the reservoir.



Never remove the coolant reservoir cap while the engine is running or hot.

If you must remove the coolant reservoir cap, follow these steps to avoid personal injury:

1. Before you remove the cap, turn the engine off and let it cool.
2. When the engine is cool, wrap a thick cloth around the cap. Slowly turn cap counterclockwise until pressure begins to release.
3. Step back while the pressure releases.
4. When you are sure that all the pressure has been released, use the cloth to turn it counterclockwise and remove the cap.

Maintenance and care

Change your engine coolant according to the appropriate schedule listed in the Scheduled Maintenance Guide.

Before adding engine coolant, check the color of the coolant in your vehicle.

For vehicles with green coolant, use Ford Premium Cooling System Fluid E2FZ-19549-AA (in Canada, Motorcraft CXC-8-B) or an equivalent premium engine coolant that meets Ford specification ESE-M97B44-A.

Do not add orange coolant or recycled coolant to your vehicle originally equipped with conventional green coolant.

For vehicles with orange coolant, use Ford Extended Life Engine Coolant F6AZ-19544-AA or a DEX-COOL® equivalent that meets Ford specification WSS-M97B44-D.

Do not add conventional green coolant or recycled coolant to your vehicle originally equipped with orange coolant.

Do not use alcohol or methanol antifreeze or any engine coolants mixed with alcohol or methanol antifreeze. Do not use supplemental coolant additives in your vehicle. These additives may harm your engine cooling system. The use of an improper coolant may void your warranty of your vehicle's engine cooling system.

Recycled engine coolant

Ford Motor Company recommends that Ford and Lincoln-Mercury dealers use recycled engine coolant produced by Ford-approved processes.

For vehicles with green coolant, not all coolant recycling processes produce coolant which meets Ford specification ESE-M97B44-A, and use of such coolant may harm engine and cooling system components.

Maintenance and care

For vehicles with orange coolant, no recycling process has been approved at this time and use of such coolant may harm engine and cooling system components.



Always dispose of used automotive fluids in a responsible manner. Follow your community's regulations and standards for recycling and disposing of automotive fluids.

Coolant refill capacity

To find out how much fluid your vehicle's cooling system can hold, refer to *Refill capacities* in the *Capacities and specifications* chapter.

Have your dealer check the engine cooling system for leaks if you have to add more than 1.0 liter (1.0 quart) of engine coolant per month.

Severe winter climate

If you drive in extremely cold climates (less than -36°C [-34°F]), it may be necessary to increase the coolant concentration above 50%. Refer to the chart on the coolant container to ensure the coolant concentration in your vehicle is such that the coolant will not freeze at the temperature level in which you drive during winter months. Never increase the engine coolant concentration above 60%. Leave a 50/50 mixture of engine coolant and water in your vehicle year-round in non-extreme climates.

CHECKING AND ADDING POWER STEERING FLUID

Check the power steering fluid. Refer to the Scheduled Maintenance Guide for the service interval schedules. If adding fluid is necessary, use only MERCON[®]V ATF.

Maintenance and care

If your vehicle is equipped with the 3.8L V6 engine, check the power steering fluid level with the engine at normal operating temperature.

1. Start the engine and let it run until it reaches normal operating temperature (the engine coolant temperature gauge indicator will be near the center of the normal area between H and C).

2. While the engine idles, turn the steering wheel left and right several times.

3. Turn the engine off.

4. Check the fluid level on the dipstick. It should be within the FULL HOT range. Do not add fluid if the level is within this range.

5. If the fluid is low, add fluid in small amounts, continuously checking the level until it reaches the correct operating range. Be sure to put the cap back on the reservoir.

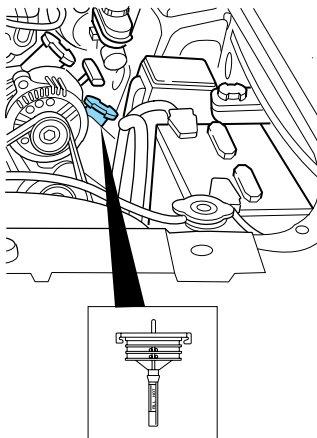

Maintenance and care

If your vehicle is equipped with a 4.6L V8 engine, check the power steering fluid level with the engine at ambient temperature. Allow at least one-half hour after driving for the power steering fluid to cool.

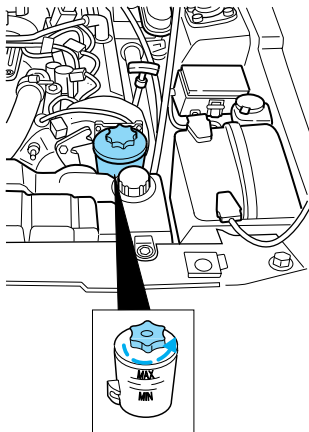

1. Start the engine and allow the engine to idle.
2. Turn the steering wheel left and right several times.
3. Turn the engine off.
4. Check the fluid level in the reservoir. It should be between the MIN and MAX lines. Do not add fluid if the level is within this range.
5. If the fluid is low, add fluid in small amounts, continuously checking the level until it reaches the correct operating range. Be sure to put the cap back on the reservoir.

TRANSMISSION FLUID

Checking automatic transmission fluid

Refer to your Scheduled Maintenance Guide for scheduled intervals for fluid checks and changes. Your transmission does not consume fluid. However, the fluid level should be checked if the transmission is not working properly, i.e., if the transmission slips or shifts slowly or if you notice some sign of fluid leakage.

Automatic transmission fluid expands when warmed. To obtain an accurate fluid check, drive the vehicle until it is at normal operating temperature (approximately 30 km [20 miles]). If your vehicle has

Maintenance and care

been operated for an extended period at high speeds, in city traffic during hot weather or pulling a trailer, the vehicle should be turned off for about 30 minutes to allow fluid to cool before checking.

1. Drive the vehicle 30 km (20 miles) or until it reaches normal operating temperature.
2. Park the vehicle on a level surface and engage the parking brake.
3. With the parking brake engaged and your foot on the brake pedal, start the engine and move the gearshift lever through all of the gear ranges. Allow sufficient time for each gear to engage.
4. Latch the gearshift lever in P (Park) and leave the engine running.
5. Remove the dipstick, wiping it clean with a clean, dry lint free rag.
6. Install the dipstick making sure it is fully seated in the filler tube.
7. Remove the dipstick and inspect the fluid level. The fluid should be in the designated area for normal operating temperature (H) or ambient temperature (C).

Low fluid level

Do not drive the vehicle if the fluid level is at the bottom of the



dipstick and the ambient temperature is above 10°C (50°F).

Correct fluid level

The transmission fluid should be checked at normal operating temperature 66°C-77°C (150°F-170°F) on a level surface. The normal operating temperature can be reached after approximately 30 km (20 miles) of driving.

You can check the fluid without driving if the ambient temperature is above 10°C (50°F). However, if fluid is added at this time, an overfill condition

Maintenance and care

could result when the vehicle reaches normal operating temperature.

The transmission fluid should be in this range if at normal operating temperature (66°C-77°C [150°F-170°F]).

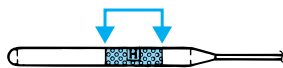

The transmission fluid should be in this range if at ambient temperature (10°C-35°C [50°F-95°F]).



High fluid level

Fluid levels above the safe range may result in transmission failure.

An overfill condition of transmission fluid may cause shift and/or engagement concerns and/or possible damage.

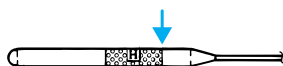

High fluid levels can be caused by an overheating condition.

Adjusting automatic transmission fluid levels

Before adding any fluid, make sure the correct type is used. The type of fluid used is normally indicated on the dipstick and/or dipstick handle and also in the *Lubricant specifications* section in the *Capacities and specifications* chapter.

Use of a non-approved automatic transmission fluid may cause internal transmission component damage.

If necessary, add fluid in 250 mL (1/2 pint) increments through the filler tube until the level is correct.

If an overfill occurs, excess fluid should be removed by a qualified technician.

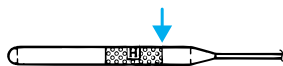

Maintenance and care

An overfill condition of transmission fluid may cause shift and/or engagement concerns and/or possible damage.

Checking and adding manual transmission fluid

1. Clean the filler plug.
2. Remove the filler plug and inspect the fluid level.

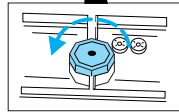
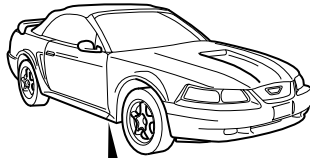

3. Fluid level should be at bottom of the opening.
4. Add enough fluid through the filler opening so that the fluid level is at the bottom of the opening.

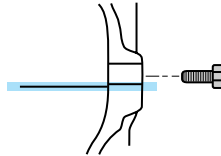

5. Install and tighten the fill plug securely.

Use only fluid that meets Ford specifications. Refer to the *Capacities and specifications* chapter.

Maintenance and care

BATTERY

Your vehicle is equipped with a Motorcraft maintenance-free battery which normally does not require additional water during its life of service.

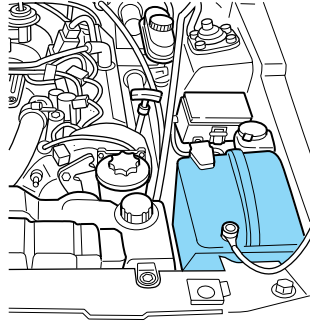

However, for severe usage or in high temperature climates, check the battery electrolyte level. Refer to the Scheduled Maintenance Guide for the service interval schedules.

Keep the electrolyte level in each cell up to the “level indicator”. Do not overfill the battery cells.

If the electrolyte level in the battery is low, you can add plain tap water to the battery, as long as you do not use hard water (water with a high mineral or alkali content). If possible, however, try to only fill the battery cells with distilled water. If the battery needs water often, have the charging system checked.

If your battery has a cover/shield, make sure it is reinstalled after the battery has been cleaned or replaced.

For longer, trouble-free operation, keep the top of the battery clean and dry. Also, make certain the battery cables are always tightly fastened to the battery terminals.

If you see any corrosion on the battery or terminals, remove the cables from the terminals and clean with a wire brush. You can neutralize the acid with a solution of baking soda and water.

Maintenance and care



Batteries normally produce explosive gases which can cause personal injury. Therefore, do not allow flames, sparks or lighted substances to come near the battery. When working near the battery, always shield your face and protect your eyes. Always provide proper ventilation.



When lifting a plastic-cased battery, excessive pressure on the end walls could cause acid to flow through the vent caps, resulting in personal injury and/or damage to the vehicle or battery. Lift the battery with a battery carrier or with your hands on opposite corners.



Keep batteries out of reach of children. Batteries contain sulfuric acid. Avoid contact with skin, eyes or clothing. Shield your eyes when working near the battery to protect against possible splashing of acid solution. In case of acid contact with skin or eyes, flush immediately with water for a minimum of 15 minutes and get prompt medical attention. If acid is swallowed, call a physician immediately.

Because your vehicle's engine is electronically controlled by a computer, some control conditions are maintained by power from the battery. When the battery is disconnected or a new battery is installed, the engine must relearn its idle and fuel trim strategy for optimum driveability and performance. To begin this process:

1. Set your parking brake.
2. Put the gearshift in P (Park) (automatic transmission) or the neutral position (manual transmission), turn off all accessories and start the engine.
3. Let the engine idle for at least one minute.

Maintenance and care

4. The relearning process will automatically complete as you drive the vehicle.

- The vehicle may need to be driven 16 km (10 miles) or more to relearn the idle and fuel trim strategy.
- If you do not allow the engine to relearn its idle trim, the idle quality of your vehicle may be adversely affected until the idle trim is eventually relearned.

If the battery has been disconnected or a new battery has been installed, the clock and the preset radio stations must be reset once the battery is reconnected.

- Always dispose of automotive batteries in a responsible manner. Follow your local authorized standards for disposal. Call your local authorized recycling center to find out more about recycling automotive batteries.

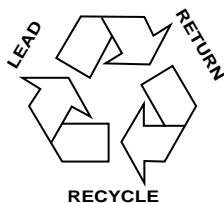

WINDSHIELD WIPER BLADES

Check the wiper blades at least twice a year or when they seem less effective. Substances such as tree sap and some hot wax treatments used by commercial car washes reduce the effectiveness of wiper blades.

Checking the wiper blades

If the wiper blades do not wipe properly, clean both the windshield and wiper blades using undiluted windshield wiper solution or a mild detergent. Rinse thoroughly with clean water. To avoid damaging the blades, do not use fuel, kerosene, paint thinner or other solvents.

Maintenance and care

Changing the wiper blades

To replace the wiper blades:

1. Pull the wiper arm away from the windshield and lock into the service position.

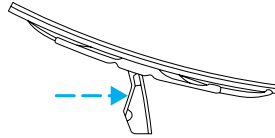

2. Turn the blade at an angle from the wiper arm. Push the lock pin manually to release the blade and pull the wiper blade down toward the windshield to remove it from the arm.

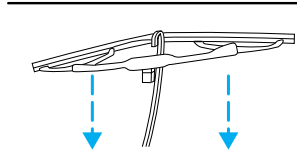

3. Attach the new wiper to the wiper arm and press it into place until a click is heard.

INFORMATION ABOUT TIRE QUALITY GRADES

New vehicles are fitted with tires that have their Tire Quality Grade (described below) molded into the tire's sidewall. These Tire Quality Grades are determined by standards that the

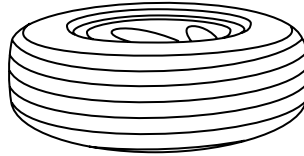

United States Department of Transportation has set.

Tire Quality Grades apply to new pneumatic tires for use on passenger cars. They do not apply to deep tread, winter-type snow tires, space-saver or temporary use spare tires, tires with nominal rim diameters of 10 to 12 inches or limited production tires as defined in Title 49 Code of Federal Regulations Part 575.104(c)(2).

U.S. Department of Transportation-Tire quality grades: The U.S. Department of Transportation requires Ford to give you the following information

Maintenance and care

about tire grades exactly as the government has written it.

Treadwear

The treadwear grade is a comparative rating based on the wear rate of the tire when tested under controlled conditions on a specified government test course. For example, a tire graded 150 would wear one and one-half (1 1/2) times as well on the government course as a tire graded 100. The relative performance of tires depends upon the actual conditions of their use, however, and may depart significantly from the norm due to variations in driving habits, service practices, and differences in road characteristics and climate.

Traction AA A B C

The traction grades, from highest to lowest are AA, A, B, and C. Those grades represent the tire's ability to stop on wet pavement as measured under controlled conditions on specified government test surfaces of asphalt and concrete. A tire marked C may have poor traction performance.



The traction grade assigned to this tire is based on straight-ahead braking traction tests, and does not include acceleration, cornering, hydroplaning or peak traction characteristics.

Temperature A B C

The temperature grades are A (the highest), B, and C, representing the tire's resistance to the generation of heat and its ability to dissipate heat when tested under controlled conditions on a specified indoor laboratory test wheel. Sustained high temperature can cause the material of the tire to degenerate and reduce tire life, and excessive temperature can lead to sudden tire failure. The grade C corresponds to a level of performance which all passenger car tires must meet under the Federal

Maintenance and care

Motor Vehicle Safety Standard No. 109. Grades B and A represent higher levels of performance on the laboratory test wheel than the minimum required by law.



The temperature grade for this tire is established for a tire that is properly inflated and not overloaded. Excessive speed, underinflation, or excessive loading, either separately or in combination, can cause heat buildup and possible tire failure.

SERVICING YOUR TIRES

Checking the tire pressure

- Use an accurate tire pressure gauge.
- Check the tire pressure when tires are cold, after the vehicle has been parked for at least one hour or has been driven less than 5 km (3 miles).
- Adjust tire pressure to recommended specifications found on the tire pressure label inside the glove compartment door.



Improperly inflated tires can affect vehicle handling and can fail suddenly, possibly resulting in loss of vehicle control.

Tire rotation

Because your vehicle's tires perform different jobs, they often wear differently. To make sure your tires wear evenly and last longer, rotate them as indicated in the Schedule maintenance guide. If you notice that the tires wear unevenly, have them checked.

Maintenance and care

- 15 or 16 inch four tire rotation

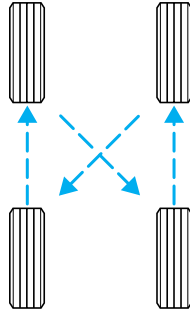

- 17 inch four tire rotation

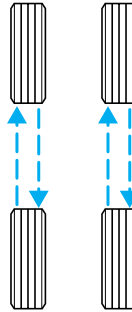

Replacing the tires

Replace the tires when the wear band is visible through the tire treads.

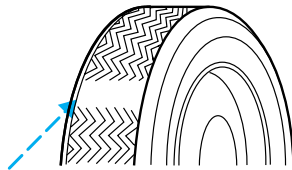

Failure to follow these precautions may adversely affect the handling of the vehicle and make it easier for the driver to lose control and roll over.

Maintenance and care

Tires that are larger or smaller than your vehicle's original tires may also affect the accuracy of your speedometer.

SNOW TIRES AND CHAINS



Driving too fast for conditions creates the possibility of loss of vehicle control. Driving at very high speeds for extended periods of time may result in damage to vehicle components.



Snow tires must be the same size and grade as the tires you currently have on your vehicle.

The tires on your vehicle have all weather treads to provide traction in rain and snow. However, in some climates, you may need to use snow tires and chains. Use chains on the tires only in an emergency or if the law requires them.

Follow these guidelines when using snow tires and chains:

- Chains may damage aluminum wheels.
- Use only Cable Type chains with size P225/55R16 or 245/45ZR17 tires. Use of SAE Class S chains may damage vehicle.
- SAE Class S chains may be used on P205/65R15 tires.
- Install chains securely, verifying that the chains do not touch any wiring, brake lines or fuel lines.
- Drive cautiously. If you hear the chains rub or bang against your vehicle, stop and re-tighten the chains. If this does not work, remove the chains to prevent damage to your vehicle.
- If possible, avoid fully loading your vehicle.
- Remove the tire chains when they are no longer needed. Do not use tire chains on dry roads.

Maintenance and care

- The suspension insulation and bumpers will help prevent vehicle damage. Do not remove these components from your vehicle when using snow tires and chains.

WHAT YOU SHOULD KNOW ABOUT AUTOMOTIVE FUELS

Important safety precautions



Do not overfill the fuel tank. The pressure in an overfilled tank may cause leakage and lead to fuel spray and fire.



If you do not use the proper fuel cap, the pressure in the fuel tank can damage the fuel system or cause it to work improperly in a collision.



The fuel system may be under pressure. If the fuel cap is venting vapor or if you hear a hissing sound, wait until it stops before completely removing the cap.



Automotive fuels can cause serious injury or death if misused or mishandled.

Observe the following guidelines when handling automotive fuel:

- Extinguish all smoking materials and any open flames before fueling your vehicle.
- Always turn off the vehicle before fueling.



Maintenance and care

- Automotive fuels can be harmful or fatal if swallowed. Fuel such as gasoline is highly toxic and if swallowed can cause death or permanent injury. If fuel is swallowed, call a physician immediately, even if no symptoms are immediately apparent. The toxic effects of fuel may not be visible for hours.
- Avoid inhaling fuel vapors. Inhaling too much fuel vapor of any kind can lead to eye and respiratory tract irritation. In severe cases, excessive or prolonged breathing of fuel vapor can cause serious illness and permanent injury.
- Avoid getting fuel liquid in your eyes. If fuel is splashed in the eyes, remove contact lenses (if worn), flush with water for 15 minutes and seek medical attention. Failure to seek proper medical attention could lead to permanent injury.
- Fuels can also be harmful if absorbed through the skin. If fuel is splashed on the skin and/or clothing, promptly remove contaminated clothing and wash skin thoroughly with soap and water. Repeated or prolonged skin contact with fuel liquid or vapor causes skin irritation.
- Be particularly careful if you are taking “Antabuse” or other forms of disulfiram for the treatment of alcoholism. Breathing gasoline vapors, or skin contact could cause an adverse reaction. In sensitive individuals, serious personal injury or sickness may result. If fuel is splashed on the skin, promptly wash skin thoroughly with soap and water. Consult a physician immediately if you experience an adverse reaction.

Fuel Filler Cap

Your fuel tank filler cap has an indexed design with a one-eighth turn on/off feature.

When fueling your vehicle:

1. Turn the engine off.

Maintenance and care

2. Carefully turn the filler cap counterclockwise 1/8 of a turn until it stops.
3. Pull to remove the cap from the fuel filler pipe.
4. To install the cap, align the tabs on the cap with the notches on the filler pipe.
5. Turn the filler cap clockwise 1/8 of a turn until it stops.

If the “Service Engine Soon/Check Engine” indicator comes on and stays on when you start the engine, the fuel filler cap may not be properly installed. Turn off the engine, remove the fuel filler cap and reinstall it being careful to align the cap properly.

If you must replace the fuel filler cap, replace it with a genuine Ford or Motorcraft part. The customer warranty may be void for any damage to the fuel tank or fuel system if a genuine Ford or Motorcraft fuel filler cap is not used.



The fuel system may be under pressure. If the fuel filler cap is venting vapor or if you hear a hissing sound, wait until it stops before completely removing the fuel filler cap. Otherwise, fuel may spray out and injure you or others.



If you do not use the proper fuel filler cap, the pressure in the fuel tank can damage the fuel system or cause it to work improperly in a collision.

Choosing the right fuel

Use only UNLEADED FUEL. The use of leaded fuel is prohibited by law and could damage your vehicle.

Do not use gasolines containing methanol. It can damage critical fuel systems components.

Vehicles certified to meet California emission standards (indicated on the underhood Vehicle

Maintenance and care

Emissions Control Information label) are designed to operate on California cleaner-burning, low-sulfur gasolines. If you have a California-certified vehicle and California cleaner-burning gasoline is not available when you refuel, your engine should perform adequately. However, the performance of the emission control devices and systems may be adversely affected. In New York and Massachusetts, which have adopted California's emission standards without requiring the sale of California cleaner-burning gasoline, repairs to correct the effects of using non-California fuel may not be covered by the emissions warranty.

Your vehicle was not designed to use fuel or fuel additives with metallic compounds, including manganese-based compounds containing (MMT).

Repairs to correct the effects of using a fuel for which your vehicle was not designed may not be covered by your warranty.

Octane recommendations

Your vehicle is designed to use "Regular" unleaded gasoline with an

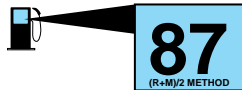

(R+M)/2 octane rating of 87. We do not recommend the use of gasolines labeled as "Regular" that are sold with octane ratings of 86 or lower in high altitude areas.

Do not be concerned if your engine sometimes knocks lightly. However, if it knocks heavily under most driving conditions while you are using fuel with the recommended octane rating, see your dealer or a qualified service technician to prevent any engine damage.

Fuel quality

If you are experiencing starting, rough idle or hesitation driveability problems during a cold start, try a different brand of "Regular" unleaded gasoline.

Maintenance and care

“Premium” unleaded gasoline is not recommended (particularly in the United States) because it may cause these problems to become more pronounced. If the problems persist, see your dealer or a qualified service technician.

The American Automobile Manufacturers Association (AAMA) issued a fuel specification to provide information on high quality fuels that optimize the performance of your vehicle. We recommend the use of fuels that meet the AAMA specification if they are available.

It should not be necessary to add any aftermarket products to your fuel tank if you continue to use a high-quality fuel.

Cleaner air

Ford approves the use of gasolines to improve air quality, including reformulated gasolines that contain oxygenates up to 10% ethanol or 15% MTBE.

Running out of fuel

Avoid running out of fuel because this situation may have an adverse affect on modern powertrain components.

If you have run out of fuel:

- You may need to crank the engine several times before the system starts to pump fuel from the tank to the engine.
- Your “Service Engine Soon” light may come on. For more information on the “Service Engine Soon” light, refer to the *Instrumentation* chapter.

Fuel Filter

Your vehicle is equipped with a fuel filter that is mounted on the underbody.

For fuel filter replacement, see your dealer or a qualified service technician. Refer to the Scheduled Maintenance Guide for the appropriate intervals for changing the fuel filter.

Maintenance and care

If you replace the fuel filter, replace it with an authorized Motorcraft part. The customer warranty may be void for any damage to the fuel system if an authorized Motorcraft fuel filter is not used.

ESSENTIALS OF GOOD FUEL ECONOMY

Measuring techniques

Your best source of information about actual fuel economy is you, the driver. You must gather information as accurately and consistently as possible. Fuel expense, frequency of fillups or fuel gauge readings are NOT accurate as a measure of fuel economy. We do not recommend taking fuel economy measurements during the first 1 600 km (1 000 miles) of driving (engine break-in period). You will get a more accurate measurement after 3 000 km–5 000 km (2 000 miles–3 000 miles).

The advertised fuel capacity of the fuel tank on your vehicle is equal to the rated refill capacity of the fuel tank as listed in the Refill Capacities chart in this “Owner Guide.” The advertised capacity is the amount of the Indicated Capacity and the Empty Reserve combined. Indicated Capacity is the difference in the amount of fuel in a full tank and a tank when the fuel gauge indicates empty. Empty Reserve is the small amount of usable fuel remaining in the fuel tank after the fuel gauge indicates empty.

The amount of Empty Reserve varies and should not be relied upon to increase driving range. When refueling your vehicle after the fuel gauge indicates empty, you might not be able to refuel the full amount of the advertised capacity of the fuel tank due to the empty reserve still present in the tank.

Maintenance and care

Filling the tank

For consistent results:

- Use the same filling rate setting (low — medium — high) each time the tank is filled.
- Allow three automatic click-offs when filling.
- Always use the recommended octane rating of a known quality gasoline, preferably a national brand.
- Use the same side of the same pump and have the vehicle facing the same direction each time you fill up.
- Have the vehicle loading and distribution the same every time.

Your results will be most accurate if your filling method is consistent.

Calculating fuel economy

1. Fill the fuel tank completely and record the initial odometer reading.
2. Each time you fill the tank, record the amount of fuel added (in liters or gallons).
3. After at least three to five tank fill-ups, fill the fuel tank and record the current kilometer (mileage) reading.
4. Follow one of the simple calculations in order to determine fuel economy:

Multiply liters used by 100, then divide by total kilometers traveled.

Divide total miles traveled by total gallons used.

Keep a record for at least one month and record the type of driving (city or highway). This will provide an accurate estimate of the vehicle's fuel economy. Additionally, keeping records during summer and winter will show how temperature impacts fuel economy. In general, lower temperatures give lower fuel economy.

Maintenance and care

Driving style — good driving and fuel economy habits

Give consideration to the lists that follow and you may be able to change a number of variables and improve your fuel economy.

Habits

- Smooth, moderate operation can yield up to 10% savings in fuel.
- Steady speeds without stopping will usually give the best fuel economy.
- Idling for long periods of time (greater than one minute) may waste fuel.
- Anticipate stopping; slowing down may eliminate the need to stop.
- Sudden or hard accelerations may reduce fuel economy.
- Slow down gradually.
- Drive at reasonable speeds (traveling at 105 km /h [65 mph] uses 15% more fuel than traveling at 88 km/h [55 mph]).
- Revving the engine before turning it off may reduce fuel economy.
- Use of the air conditioner or defroster may reduce fuel economy.
- Use of speed control (if equipped) may improve fuel economy. Speed control can help maintain a constant speed and reduce speed changes. You may want to turn off the speed control in hilly terrain as unnecessary shifting between third and fourth gears may occur and could result in reduced fuel economy.
- Warming up a vehicle on cold mornings is not required and may reduce fuel economy.
- Resting your foot on the brake pedal while driving may reduce fuel economy.

Maintenance and care

- Combine errands and minimize stop-and-go driving.

Maintenance

- Keep tires properly inflated and use only recommended size.
- Operating a vehicle with the wheels out of alignment will reduce fuel economy.
- Use recommended engine oil. Refer to *Lubricant Specifications*.
- Perform all regularly scheduled maintenance items. Follow the recommended maintenance schedule and owner maintenance checks found in your vehicle Scheduled Maintenance Guide.

Conditions

- Heavily loading a vehicle or towing a trailer may reduce fuel economy at any speed.
- Carrying unnecessary weight may reduce fuel economy (approximately 2 km/h [1 mpg] is lost for every 180 kg [400 lb] of weight carried).
- Adding certain accessories to your vehicle (for example bug deflectors, rollover/light bars, running boards, ski/luggage racks) may reduce fuel economy.
- Use of fuel blended with alcohol may lower fuel economy.
- Fuel economy may decrease with lower temperatures during the first 12–16 km (8–10 miles) of driving.
- Flat terrain driving improves fuel economy over hilly roads.
- Transmissions give their best fuel economy when operated in the top cruise gear and with steady pressure on the gas pedal.
- Close windows for high speed driving.

Maintenance and care

EPA window sticker

Every new vehicle should have the EPA window sticker. Contact your dealer if the window sticker is not supplied with your vehicle. The EPA window sticker should be your guide for the fuel economy comparisons with other vehicles.

It is important to note the box in the lower left corner of the window sticker. These numbers represent the Range of Km/L (MPG) expected on the vehicle, depending upon the driver's method of operation and conditions.

EMISSION CONTROL SYSTEM

Your vehicle is equipped with various emission control components and a catalytic converter which will enable your vehicle to comply with applicable exhaust emission standards. To make sure that the catalytic converter and other emission control components continue to work properly:

- Use only unleaded fuel.
- Avoid running out of fuel.
- Do not turn off the ignition while your vehicle is moving, especially at high speeds.
- Have the items listed in your Scheduled Maintenance Guide performed according to the specified schedule.

The scheduled maintenance items listed in the Scheduled Maintenance Guide are essential to the life and performance of your vehicle and to its emissions system.

If other than Ford, Motorcraft or Ford-authorized parts are used for maintenance replacements or for service of components affecting emission control, such non-Ford parts should be equivalent to genuine Ford Motor Company parts in performance and durability.

Maintenance and care



Do not park, idle, or drive your vehicle in dry grass or other dry ground cover. The emission system heats up the engine compartment and exhaust system, which can start a fire.

Illumination of the charging system warning light, “Service Engine Soon” light or the temperature warning light, fluid leaks, strange odors, smoke or loss of oil pressure, could indicate that the emission control system is not working properly.



Exhaust leaks may result in entry of harmful and potentially lethal fumes into the passenger compartment.

Do not make any unauthorized changes to your vehicle or engine. By law, vehicle owners and anyone who manufactures, repairs, items, sells, leases, trades vehicles, or supervises a fleet of vehicles are not permitted to intentionally remove an emission control device or prevent it from working.

Information about your vehicle’s emission system is on the Vehicle Emission Control Information Decal located on or near the engine. This decal identifies engine displacement and gives some tune up specifications.

Please consult your “Warranty Guide” for complete emission warranty information.

Readiness for inspection/maintenance (I/M) testing

In some localities, it may be a legal requirement to pass an I/M test of the on-board diagnostic (OBD-II) system. If your “Check Engine/Service Engine Soon” light is on, refer to the description in the *Warning Lights and Chimes* section of the *Instrumentation* chapter. Your vehicle may not pass the I/M test with the “Check Engine/Service Engine Soon” light on.

Maintenance and care

If the vehicle's powertrain system or its battery has just been serviced, the OBD-II system is reset to a "not ready for I/M test" condition. To ready the OBD-II system for I/M testing, a minimum of 30 minutes of city and highway driving is necessary as described below:

- First, at least 10 minutes of driving on an expressway or highway.
- Next, at least 20 minutes driving in stop-and-go, city-type traffic with at least four idle periods.

Allow the vehicle to sit for at least eight hours without starting the engine. Then, start the engine and complete the above driving cycle. The engine must warm up to its normal operating temperature. Once started, do not turn off the engine until the above driving cycle is complete.

EXTERIOR BULBS

Replacing exterior bulbs

Check the operation of the following lamps frequently:

- Headlamps
- Tail lamps
- Brakelamps
- High-mount brakelamp
- Turn signals
- Backup lamps
- License plate lamp

Do not remove lamp bulbs unless they will be replaced immediately. If a bulb is removed for an extended period of time, contaminants may enter the lamp housings and affect performance.

Maintenance and care

Replacing headlamp bulbs



Handle a halogen headlamp bulb carefully and keep out of children's reach. Grasp the bulb only by its plastic base and do not touch the glass. The oil from your hand could cause the bulb to break the next time the headlamps are operated.

To remove the headlamp bulb:

1. Make sure headlamp switch is in OFF position, then open the hood.

2. At the back of the headlamp, pull two retainer pins up to release the headlamp assembly.

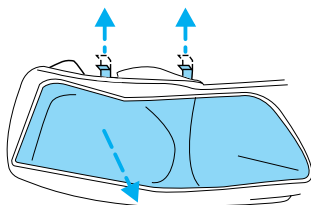

3. Pull headlamp assembly forward disengaging the lamp from the rear hidden snap retainers to expose the back of the bulb.

4. Release clip and disconnect the electrical connector from the bulb.

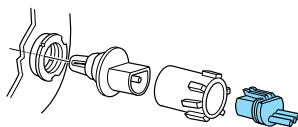

5. Remove the bulb retaining ring by rotating it counterclockwise (when viewed from the rear) about $\frac{1}{4}$ turn to free it from the bulb socket, and slide the ring off the plastic base. Keep the ring to retain the new bulb.

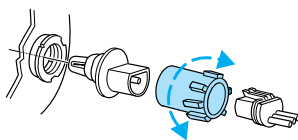

6. Without turning, remove the old bulb from the lamp assembly by gently pulling it straight out of the lamp assembly.

Maintenance and care

To install the new bulb:

1. With the flat side of the new bulb's plastic base facing upward, insert the glass end of the bulb into the lamp assembly. You may

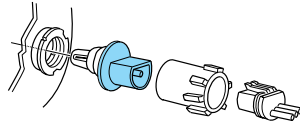

need to turn the bulb left or right to align the grooves in the plastic base with the tabs in the lamp assembly. When the grooves are aligned, push the bulb into the lamp assembly until the plastic base contacts the rear of the lamp assembly.

2. Install the bulb retaining ring over the plastic base until it contacts the rear of the socket by rotating clockwise until you feel a "stop."

3. Connect the electrical connector into the plastic base until it snaps, locking it into position.

4. Install the headlamp on vehicle by aligning the lamp with the rear snap retainer, push to seat and secure with two retainer pins.

5. Turn the headlamps on and make sure they work properly. If the headlamp was correctly aligned before you changed the bulb, you should not need to align it again.

Replacing front parking lamp/turn signal bulbs

1. Make sure the headlamp control is in the OFF position.

2. Open the hood.

3. At the back of the headlamp, pull two retainer pins up to release the headlamp assembly.

4. Pull headlamp assembly forward disengaging the lamp from the rear snap retainer to expose the back of the bulb.

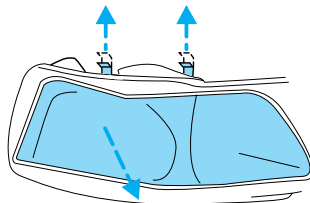

Maintenance and care

5. Rotate the bulb socket counterclockwise about $\frac{1}{4}$ turn and remove from lamp assembly.

6. Carefully pull the bulb straight out from the socket and push in the new bulb.

7. To complete installation, follow the removal procedure in reverse order.

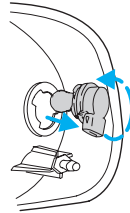

High-mount brakelamp bulbs

1. Open trunk.

2. Inside trunk, locate access hole under the luggage compartment door.

3. Remove the bulb socket by rotating it 45 degrees and pulling it out of the lamp assembly.

4. Carefully pull bulb straight out of socket and push in new bulb.

5. To complete installation, follow the removal procedure in reverse order.

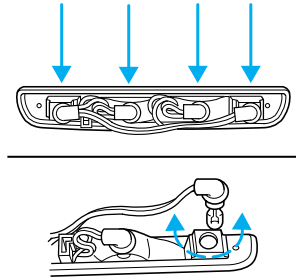

Replacing foglamp bulbs

The halogen bulb contains gas under pressure. The bulb may shatter if the glass envelope is scratched or if the bulb is dropped. Handle the bulb carefully. Grasp the bulb only by its base. Avoid touching the glass envelope.

Maintenance and care

1. Rotate the foglamp bulb counterclockwise and remove from foglamp (the rear side of the foglamp is shown).

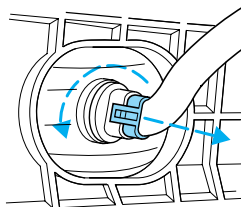

2. Disconnect the electrical connector from the foglamp bulb.

3. Connect the electrical connector to the new foglamp bulb.

4. Install the foglamp bulb in foglamp by rotating clockwise.

Replacing license plate lamp bulbs

To change the license plate bulbs:

1. Open trunk and remove bulb socket from the trunk lid by turning counterclockwise.

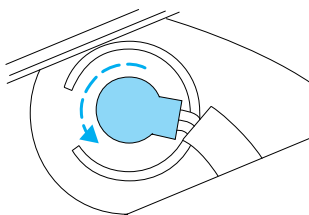

2. Pull the bulb straight out of the socket and push in the new bulb.

3. Install the bulb socket in trunk lid by turning clockwise.

Replacing tail lamp/backup bulbs

For bulb replacement, see a dealer or qualified technician.

Interior bulbs

Check the operation of the following interior bulbs frequently:

- interior overhead lamp
- map lamp

Maintenance and care

Map lamps

For bulb replacement, see a qualified service technician or your dealer.

Using the right bulbs

Function	Trade Number
Tail lamp, brakelamp, turn lamp	3157K
Park lamp, turn lamp, side marker (front)	3157NAK
Backup lamp	3156K
License plate lamp	168
High-mount brakelamp	906
Headlamps	9007
Luggage compartment lamp	906
Dome lamp	575
Map lamp	575
Visor vanity lamp	74
Glove compartment	194
Rearview mirror map lamps	192
Fog lamp	899
To replace all instrument panel lights - see your dealer.	

AIMING THE HEADLAMPS

The alignment of your headlamps should be checked if:

- Oncoming motorists frequently signal you to deactivate your high beams, and your high beams are not activated.
- The headlamps do not seem to provide enough light for clear night vision.
- The headlamp beams are pointed substantially away from a slightly down and to the right position.

Maintenance and care

Vertical aim adjustment

1. Park the vehicle on a level surface approximately 7.6 meters (25 feet) from a vertical wall or screen directly in front of it.

2. Measure the height from the center of your headlamp to the ground and mark an 2.4 meters (8 foot)

horizontal reference line on the vertical wall or screen at this height (a piece of masking tape works well). The center of the lamp is marked by a 3.0 mm circle on the headlamp lens.

3. Turn on the low beam headlamps to illuminate the wall or screen and open the hood.

4. On the wall or screen you will observe a distinct line of high intensity light. If this is not centered on the horizontal reference line, the beam will need to be adjusted.

5. Locate the vertical adjuster on each headlamp, then use a 6 mm wrench or screwdriver to turn the adjuster either counterclockwise (to adjust up) or clockwise (to adjust down) centering the light on the horizontal reference line.

6. HORIZONTAL AIM IS NOT REQUIRED FOR THIS VEHICLE AND IS NON-ADJUSTABLE.

7. Close the hood and turn off the lamps.

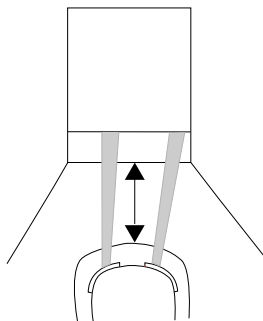

CLEANING AND CARING FOR YOUR VEHICLE

Refer to the “Customer Assistance Guide” for a list of Ford-approved cleaners, polishes and waxes.

Maintenance and care

Washing your vehicle

Wash your vehicle regularly with cold or lukewarm water. Never use strong detergents or soap. If your vehicle is particularly dirty, use a quality car wash detergent. Always use a clean sponge, washing glove or similar device and plenty of water for best results. To avoid spots, avoid washing when the hood is still warm, immediately after or during exposure to strong sunlight.

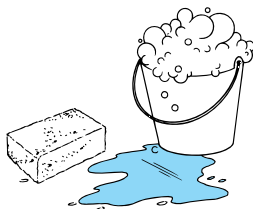

During winter months, it is especially important to wash the vehicle on a regular basis. Large quantities of dirt and road salt are difficult to remove and also cause damage to the vehicle.

Remove any exterior accessories, such as antennas, before entering a car wash. If you have wax applied to the vehicle at a commercial car wash, it is recommended that you clean the wiper blades and windshield as described in *Cleaning the wiper blades and windshield*.

After washing, apply the brakes several times to dry them.

Waxing your vehicle

Wax when water stops beading on the surface. This could be every three or four months, depending on operating conditions.

Use only carnauba or synthetic-based waxes. Use cleaning fluid or alcohol with a clean cloth to remove any bugs and tar before waxing vehicle. Use tar remover to remove any tar spots.

Avoid getting wax on the windshield. If you have wax applied at a commercial car wash, it is recommended that you clean the wiper blades and

Maintenance and care

windshield as described in *Cleaning the wiper blades and windshield*.

Repairing paint chips

Minor scratches or paint damage from road debris may be repaired with touch-up paint, repair foil or aerosol paint spray from the Ford accessory line. Observe the application instructions on the products.

Remove particles such as bird droppings, tree sap, insect remains, tar spots, road salt and industrial fallout immediately.

Cleaning the wheels

Wash with the same detergent as the body of your vehicle. Do not use acid-based or alcohol-based wheel cleaners, steel wool, fuel or strong detergents. Never use abrasives that will damage the finish of special wheel surfaces. Use a tar remover to remove grease and tar.

Cleaning the engine

Engines are more efficient when they are clean because grease and dirt buildup keep the engine warmer than normal. When washing:

- Take care when using a power washer to clean the engine. The high pressure fluid could penetrate the sealed parts and cause damage.
- Do not spray with cold water to avoid cracking the engine block or other engine components.

Maintenance and care

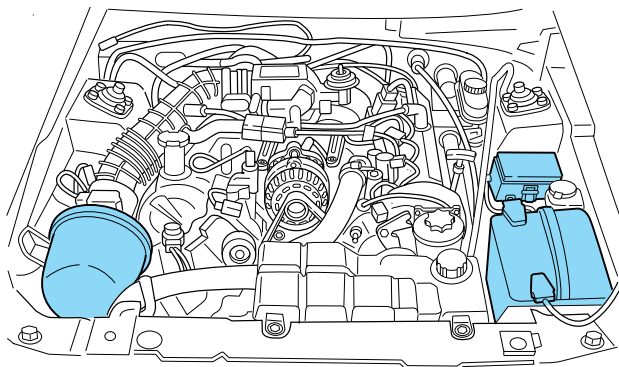

- Cover the highlighted areas to prevent water damage when cleaning the engine.
- Never wash or rinse the engine while it is running; water in the running engine may cause internal damage.

Cleaning plastic exterior parts

Use vinyl cleaner for routine cleaning. Clean with a tar remover if necessary. Do not clean plastic parts with thinners, solvents or petroleum-based cleaners.

Cleaning the exterior lamps

Wash with the same detergent as the exterior of your vehicle. Use glass cleaner or tar remover if necessary.

To avoid scratching the lamps, do not use a dry paper towel, chemical solvents or abrasive cleaners.

Cleaning the wiper blades and windshield

If the wiper blades do not wipe properly, clean the wiper blade rubber element with undiluted windshield washer solution or a mild detergent. To avoid damaging the blades, do not use fuel, kerosene, paint thinner or other solvents.

Maintenance and care

If the wiper still does not wipe properly, this could be caused by substances on the windshield such as tree sap and some hot wax treatments used by commercial car washes. Clean the outside of the windshield with a non-abrasive cleanser such as the non-abrasive Bon-Ami® powder. Rinse thoroughly with clean water. **Do not** use abrasive cleansers on glass as they may cause scratches. The windshield is clean if beads do not form when you rinse it with water. The windshield and wiper blades should be cleaned on a regular basis, and blades or rubber elements replaced when worn.

Cleaning the instrument panel

Clean with a damp cloth, then dry with a dry cloth.

Avoid cleaner or polish that increases the gloss of the upper portion of the instrument panel. The dull finish in this area helps protect the driver from undesirable windshield reflection.

Cleaning the interior fabric

Remove dust and loose dirt with a whisk broom or a vacuum cleaner. Remove fresh spots immediately. Do not use household or glass cleaners. These agents can stain and discolor the fabric. Use a mild soap and water solution if necessary.

Cleaning leather seats (if equipped)

To clean, simply use a soft cloth dampened with water and a mild soap. Wipe the leather again with a damp cloth to remove soap residue. Dry with a soft cloth. For tougher soiling concerns, Ford recommends using the leather cleaning kit F8AJ-19G253-AA, which is available from your Ford Dealer. This mild cleaner and special pad, cleans the leather and maintains its natural beauty. Follow the instructions on the cleaner label. Regular cleaning of your leather upholstery helps maintain its resiliency and color.

Maintenance and care

Do not use household cleaning products, alcohol solutions, solvents or cleaners intended for rubber, vinyl or plastics.

Cleaning and maintaining the safety belts

Clean the safety belts with a mild soap solution recommended for cleaning upholstery or carpets. Do not bleach or dye the belts, because these actions may weaken the belt webbing.

Check the safety belt system periodically to make sure there are no nicks, wear or cuts. If your vehicle has been involved in an accident, refer to the *Safety belt maintenance* section in the *Seating and safety restraints* chapter.

Inside windows

Use glass cleaner for the inside windows if they become fogged.

Convertible top and padded molding care

To avoid damage to the vinyl top and moldings, use only an approved Ford cleaner, or equivalent. Do not use stiff bristle brushes or abrasive materials or cleaners.

Hot waxes applied by commercial car washes can affect the cleanability of vinyl material.

Using high water pressure or wand-type car washes against the convertible top and windows may cause water leaks and possible seal damage.

Underbody

Flush the complete underside of vehicle frequently. Keep body drain holes unplugged. Inspect for road damage.

Capacities and specifications

MOTORCRAFT PART NUMBERS

Component	3.8L OHV V6 engine	4.6L SOHC V8 engine
Air filter	FA-1611	FA-1634
Fuel filter	FG-800A	FG-800A
Battery	BXT-59	BXT-59
Oil filter	FL-400S	FL-820S
PCV valve	EV-152	EV-98
Spark plugs*	AWSF-42EE**	AWSF-32PP***

* Refer to Vehicle Emissions Control Information (VECI) decal for spark plug gap information.

**If a spark plug is removed for inspection, it must be reinstalled in the same cylinder. Cylinders No. 1, 2 and 3 have an "EG" suffix. Cylinders No. 4, 5 and 6 have an "E" suffix. If a spark plug needs to be replaced, use only spark plugs with the same service part number suffix letter as shown on the engine decal.

*** If a spark plug is removed for inspection, it must be reinstalled in the same cylinder. Cylinders No. 1, 2, 3 and 4 have a "PG" suffix. Cylinders No. 5, 6, 7 and 8 have a "P" suffix. If a spark plug needs to be replaced, use only spark plugs with the same service part number suffix letter "PP" as shown on the engine decal.

Capacities and specifications

REFILL CAPACITIES

Fluid	Ford Part Name	Appli- cation	Capacity
Brake fluid	High Per- formance DOT 3 Motor Vehicle Brake Fluid	All	Fill to line on reservoir
Engine oil (includes filter change)	Motorcraft 5W30 Super Premium Motor Oil	All	4.7L (5.0 quarts)
Engine coolant ¹	See footnote	3.8L OHV V6 engine	11.2L (11.8 quarts)
		4.6L SOHC V8 engine	13.3L (14.1 quarts)
Power steering fluid	Motorcraft MER- CON [®] V ATF	3.8L OHV V6 engine	Keep in FULL HOT range on dispstick
		4.6L SOHC V8 engine	Fill to between MIN and MAX lines on reservoir
Rear axle lubricant ²	Motorcraft SAE 80W90 Premium Rear Axle Lubricant	Ford 7.5 inch con- ventional and Traction- Lok	1.5L (3.25 pints)
		Ford 8.8 inch con- ventional and Traction- Lok	1.7L (3.75 pints)

Capacities and specifications

Fluid	Ford Part Name	Application	Capacity
Fuel tank	N/A	All	58.7L (15.5 gallons)
Transmission fluid	Motorcraft MERCON®V ATF	Automatic with 3.8L OHV V6 engine	13.1L (13.9 quarts)
		Automatic with 4.6L SOHC V8 engine	12.0L (12.8 quarts)
	Motorcraft MERCON® ATF	Manual with 3.8L OHV V6 engine	2.6L (5.6 pints)
		Manual with 4.6L SOHC V8 engine ³	3.1L (6.6 pints)
Windshield washer fluid	Ultra-Clear Windshield Washer Concentrate	All	Fill to line on reservoir

¹ If your engine coolant is green in color, use Ford Premium Cooling System Fluid. If your coolant is orange in color, use Ford Extended Life Engine Coolant. Refer to *Adding engine coolant, in the Maintenance and Care chapter*.

² Rear axle lubricants do not need to be checked or changed unless a leak is suspected, service is required or the axle assembly has been submerged in water. The axle lubricant should be changed any time the rear axle has been submerged in water. Fill 6 mm to 14 mm (1/4 inch to 9/16 inch) below bottom of fill hole. Add 118 ml (4 oz.) of additive friction modifier C8AZ-19B546-A, Ford specification EST-M2C118-A for complete refill of Traction-Lok axles.

³ Service refill capacity is determined by filling the transmission to the bottom of the filler hole with the vehicle on a level surface.

Capacities and specifications

LUBRICANT SPECIFICATIONS

Item	Ford part name	Ford part number	Ford specification
Brake fluid	High Performance DOT 3 Motor Vehicle Brake Fluid	C6AZ-19542-AB	ESA-M6C25-A and DOT 3
Door weather-strips	Silicone Lubricant	F7AZ-19G208-BA and F5AZ-19553-AA	ESR-M13P4-A
Door latch, hood latch, auxiliary hood latch, door hinges, striker plates, seat tracks and fuel filler door hinge	Multi-Purpose Grease	D0AZ-19584-AA or F5AZ-19G209-AA	ESB-M1C93-B or ESR-M1C159-A
Engine coolant	Ford Premium Engine Coolant (green in color)	E2FZ-19549-AA	ESE-M97B44-A
	Ford Extended Life Engine Coolant (orange in color)	F6AZ-19544-AA	WSS-M97B44-D or DEX-COOL® equivalent
Engine oil	Motorcraft 5W30 Super Premium Motor Oil	XO-5W30-QSP	WSS-M2C153-G with API Certification Mark

Capacities and specifications

Item	Ford part name	Ford part number	Ford specification
Lock cylinders	Penetrating Lubricant	E8AZ-19501-B	none
Power steering fluid and convertible top fluid (if equipped)	Motorcraft MERCON [®] V ATF	XT-5-QM	MERCON [®] V
Rear axle lubricant	Motorcraft SAE 80W90 Premium Rear Axle Lubricant ¹	XY-80W90-QL	WSP-M2C197-A
Automatic transmission fluid	Motorcraft MERCON [®] V ATF	XT-5-QM	MERCON [®] V
Manual transmission fluid	Motorcraft MERCON [®] ATF	XT-2-QDX	MERCON [®]
Disc brake caliper rails	Silicone Brake Caliper and Dielectric compound	D7AZ-19A331-A (Motorcraft WA-10)	ESE-M1C171-A
Windshield washer fluid	Ultra-Clear Windshield Washer Concentrate	C9AZ-19550-AC	ESR-M17P5-A

¹ Add 118 ml (4 oz.) of additive friction modifier C8AZ-19B546-A, Ford specification EST-M2C118-A for complete refill of Traction-Lok axles.

Ford design rear axles contain a synthetic lubricant that does not require changing unless the axle has been submerged in water.

Capacities and specifications

ENGINE DATA

Engine	3.8L OHV V6 engine	4.6L SOHC V8 engine
Cubic inches	232	281
Horsepower	190 @ 5250 rpm	260 @ 5250 rpm
Torque	220 lb.-ft. @ 2750 rpm	302 lb.-ft. @ 4000 rpm
Recommended fuel	87 octane	87 octane
Firing order	1-4-2-5-3-6	1-3-7-2-6-5-4-8
Spark plug gap	1.3-1.4 mm (0.052- 00.056 inch)	1.3-1.4 mm (0.052- 00.056 inch)
Ignition system	EDIS	Coil on plug
Compression ratio	9.4:1	9.0:1

VEHICLE DIMENSIONS

Vehicle dimensions	Coupe mm (in)	Convertible mm (in)
(1) Overall length	4 653.3 (183.2)	4 653.3 (183.2)
(2) Overall width	1 856.7 (73.1)	1 856.7 (73.1)
(3) Overall height	1 353.8 (53.3) ¹	1 356.4 (53.4) ²
(4) Wheelbase	2 573.0 (101.3)	2 573.0 (101.3)
(5) Track - Front	1 534.2 (60.4) ³	1 534.2 (60.4) ³
(5) Track - Rear	1 539.2 (60.6) ⁴	1 539.2 (60.6) ⁴

¹ 1 358.9 mm (53.5 in) for Mustang GT

² 1 361.4 mm (53.6 in) for Mustang GT

³ 1 521.5 mm (59.9 in) for Mustang GT

⁴ 1 526.5 mm (60.1 in) for Mustang GT

Capacities and specifications

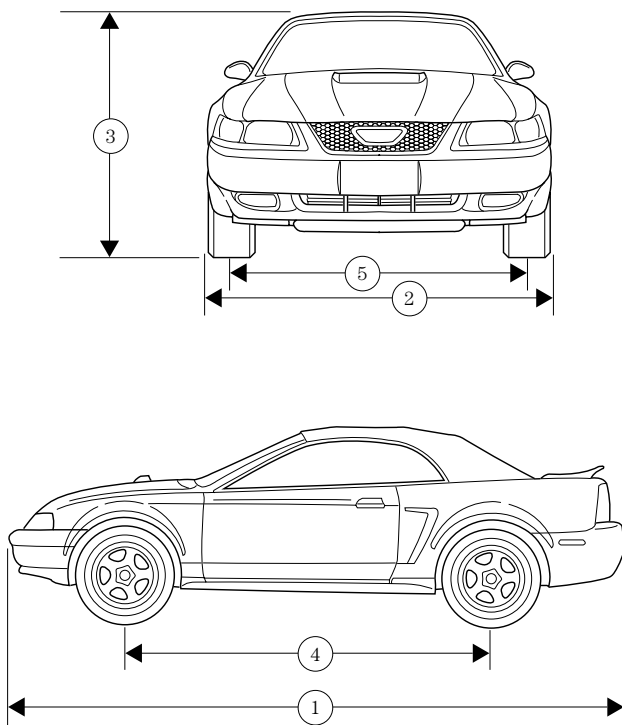

Capacities and specifications

IDENTIFYING YOUR VEHICLE

Safety compliance label

The National Highway Traffic Safety Administration Regulations require that a Safety Compliance Certification Label be affixed to a vehicle and prescribe where the Safety Compliance Certification Label may be located. The Safety Compliance Certification Label is located on the front door latch pillar on the driver's side.

MFD. BY FORD MOTOR CO. IN U.S.A.	
DATE: XXXXX	GVWR: XXXXX LB/ XXXXX KG
FGAWR: XXXXXX/XXXXXXXX	RGAWR: XXXXXX/XXXXXXXX
THIS VEHICLE CONFORMS TO ALL APPLICABLE FEDERAL MOTOR VEHICLE SAFETY STANDARDS IN EFFECT ON THE DATE OF MANUFACTURE SHOWN ABOVE.	
VIN: XXXXXXXXXXXXXXXXXXXX	TYPE: XXXXXXXXXXXXXXXXXXXX
	
MAXIMUM LOAD=OCCUPANTS + LUGGAGE=XXXXKG/XXXXLB	
OCCUPANTS: X TOTAL X FR X 2ND X RR OCCUPANTS LUGGAGE	
X XXXKG/XXXLB	
X XXXKG/XXXLB	
TIRE: XXXX/XXXXX XXX	XX XXXKG/XXXLB
X XXXKG/XXXLB	
PRESSURE (FR) XXX kPa/33 PSI COLD	
PRESSURE (RR) XXX kPa/33 PSI COLD	
TRAILER TOWING - SEE OWNER GUIDE	
EXT PNT: XXXXXX XXXXXX	RC: XX DSC: XXXX F0000
BAR INT TR TIPS R AXLE TR SPR T0000	
X XX XXX X XX X XXX	
UTC VFOHT-15294A10-GA	

Vehicle identification number

The vehicle identification number is attached to a metal tag and is located on the driver side instrument panel.



Engine number

The engine number (the last eight numbers of the vehicle identification number) is stamped on the engine block, transmission, frame and transfer case (if equipped).

Reporting safety defects

REPORTING SAFETY DEFECTS (U.S. ONLY)

If you believe that your vehicle has a defect that could cause a crash, or could cause injury or death, you should immediately inform the National Highway Traffic Safety



Administration (NHTSA) in addition to notifying Ford Motor Company.

If NHTSA receives similar complaints, it may open an investigation, and if it finds that a safety defect exists in a group of vehicles, it may order a recall and remedy campaign. However, NHTSA cannot become involved in individual problems between you, your dealer or Ford Motor Company.

To contact NHTSA, you may either call the Auto Safety Hotline toll-free at 1-800-424-9393 (202-366-0123 in the Washington D.C. area) or write to:

NHTSA
U.S. Department of Transportation
400 Seventh Street
Washington D.C. 20590

You can also obtain other information about motor vehicle safety from the Hotline.

Index

- Air bag supplemental restraint system 71
 - and child safety seats 73
 - description 72
 - disposal 76
 - indicator light 75
 - passenger air bag ... 74
- Automatic transmission
 - driving an automatic overdrive .. 94,95,96,97
- Axle
 - refill capacities 178
- Battery
 - voltage gauge 15
- Brakes 88,90
 - anti-lock 88,89
 - anti-lock brake system (ABS)
 - warning light 89
 - fluid, checking and adding 133
 - shift interlock 93
- Break-in period 2,3
- Child safety seats
 - attaching with tether straps 82
 - in rear seat 80
 - tether anchorage hardware 82
- Cleaning your vehicle 171
 - engine compartment 173
 - exterior 173,176
 - exterior lamps 174
 - interior 175
 - plastic parts 174
 - washing 172
 - waxing 172
 - wheels 173
 - windows 176
 - wiper blades 174
- Clutch
 - fluid 135
 - operation while driving 98
 - recommended shift speeds 99
- Console 52
- Controls
 - power seat 64
- Convertible 53
 - cleaning 176
 - installation of the boot 54
 - lowering the convertible top 53
 - raising the convertible top 55
- Coolant 139,140
 - checking and adding 138
 - refill capacities 140
- Defrost
 - rear window 17
- Emission control system 163
- Engine
 - coolant 137
 - idle speed control . 146
 - service points . 129,130
 - starting after a collision 108
- Engine block heater . 86
- Engine oil
 - checking and adding 132
 - dipstick 130
 - specifications . 130,133
- Exhaust fumes 87
- Floor mats 51

Index

- Fuel
 - choosing
 - the right fuel 156
 - comparisons with EPA
 - fuel economy
 - estimates 163
 - detergent in fuel ... 158
 - filling your vehicle
 - with fuel 154,155
 - gauge 12
 - quality 157
 - running
 - out of fuel 158
 - safety information
 - relating to automotive
 - fuels 154
- Fuses 109,110
- Gas mileage (see
- Fuel economy) 159
- 160,161,162
- Gauges 12
 - engine coolant
 - temperature gauge . 13
 - engine oil pressure
 - gauge 15
- Hazard flashers 108
- Head restraints 63
- Headlamps
 - aiming 170,171
 - bulb
 - specifications 170
 - high beam 7,44
 - warning chime 11
- Heating 18
 - heating and air
 - conditioning
 - system 18,20
- Hood 128
- Ignition 182
- Inspection/maintenance
- (I/M) testing 164
- Instrument panel 6
 - cleaning 175
- Keys
 - key in ignition
 - chime 11
 - positions of the
 - ignition 45
 - removing from the
 - ignition 101
- Lamps
 - daytime
 - running light 16
 - fog lamps 52
 - headlamps 16
 - headlamps, flash to
 - pass 44
 - instrument panel,
 - dimming 17
 - interior
 - lamps 49,169,170
 - replacing bulbs 165
 - 166,167,168,169
- Lane change indicator
- (see Turn signal) 43
- Lights, warning and
- indicator
 - air bag 7
 - anti-lock brakes
 - (ABS) 10
 - anti-theft 7
 - brake 10
 - charging system 7
 - check coolant 11
 - low fuel 9
 - overdrive off 9
 - safety belt 7
 - service engine soon .. 8
 - turn signal indicator . 6
- Lumbar support,
- seats 65,66
- Manual transmission
- reverse 100

Index

- Mirrors
 - side view mirrors (power) 51
- Motorcraft parts 158
- Octane rating 157
- Odometer 14
- Panic alarm feature, remote entry system 57
- Parking brake 90
- Power distribution box (see Fuses) 113
- Power door locks 51
- Power steering 92
 - fluid, checking and adding 140
- Radio 21,22,23,24,25,26,27,28,29,30,31,32,33,34,35,36,37,38,39,40,41,42,43
- Relays 109
- Remote entry system 56,60,61
 - illuminated entry ... 58
 - locking/unlocking doors 56,57
 - replacement/additional transmitters 58
 - replacing the batteries 59
- Safety belts (see Safety restraints) 11
- Safety restraints
 - cleaning the safety belts 71,176
 - extension assembly 70
 - for children 76,77
 - warning light and chime 11,70
- Seat belts (see Safety restraints) 66,68,69
- Seats 63
 - child safety seats ... 78
 - cleaning 175
- Seats-easy access/easyout feature 65
- Servicing your vehicle 126,127
- Spark plugs, specifications 177
- Special notice 3
- Specification chart, lubricants 180
- Speed control 46
- Speedometer 13
- Starting your vehicle 83,84,86
 - jump starting 120,121,122,123
- Steering wheel
 - tilting 45
- Tachometer 14
- Tires 149,150,151
 - changing 115,116
 - checking the pressure 151
 - replacing 152
 - rotating 151
 - snow tires and chains 153
 - tire grades 150
 - treadwear 150
- Towing
 - wrecker 124
- Traction control 91
 - active light 10
- Traction-lok rear axle 101
- Transmission 142
 - automatic operation 93
 - fluid, checking and adding (automatic) 142,143,144

Index

- fluid, checking and
 - adding (manual) ... 145
 - manual operation ... 98
- Trip odometer 15
- Trunk 57
- Vehicle dimensions . 182
- Vehicle Identification Number (VIN) 184
- Vehicle loading 101
 - 104,105,106
- Ventilating your vehicle 87
- Warning chimes 6
- Washer fluid 136
 - reservoir 136
- Water,
 - Driving through 106
- Wheels
 - anti-theft
 - lug nuts 119
- Windows 50
- Windshield washer fluid and wipers
 - checking and cleaning 148
 - operation 43
 - replacing wiper blades 149

Filling station information

Item	Information
Recommended fuel	Unleaded fuel only - 87 octane
Fuel tank capacity	58.7L (15.5 gallons)
Engine oil capacity (includes filter change)	4.7L (5.0 quarts). Use Motorcraft 5W30 Super Premium Motor Oil, Ford specification WSS-M2C153-G
Tire size and pressure	See label on inside of glove box door.
Hood release	Pull handle under the left side of the instrument panel.
Coolant capacity-3.8L OHV V6 engine ¹	11.2L (11.8 quarts)
Coolant capacity-4.6L SOHC V8 engine ¹	13.3L (14.1 quarts)
Power steering fluid capacity	Fill to line on reservoir or dipstick. Use Motorcraft MERCON®V ATF.
Manual transmission fluid capacity-3.8L OHV V6 engine	2.6L (5.6 pints). Use Motorcraft MERCON® ATF.
Manual transmission fluid capacity-4.6L SOHC V8 engine ²	3.1L (6.6 pints). Use Motorcraft MERCON® ATF.
Automatic transmission fluid capacity-3.8L OHV V6 engine ³	13.1L (13.9 quarts). Use Motorcraft MERCON®V ATF.
Automatic transmission fluid capacity-4.6L SOHC V8 engine ³	12.0L (12.8 quarts). Use Motorcraft MERCON®V ATF.

Filling station information

¹ If your engine coolant is green in color, use Ford Premium Cooling System Fluid. If your engine coolant is orange in color, use Ford Extended Life Engine Coolant. Refer to *Adding engine coolant, in the Maintenance and Care chapter*.

² Service refill capacity is determined by filling the transmission to the bottom of the filler hole with the vehicle on a level surface.

³ Ensure correct automatic transmission fluid is used for a specific application. Check the container to verify the fluid is MERCON® and/or MERCON®V approved. Some fluids have been approved as meeting both MERCON® and MERCON®V requirements and will be labeled as such. Fluids labeled as meeting only MERCON® or only MERCON®V requirements must not be used interchangeably. DO NOT mix MERCON® and MERCON®V. Transmission fluid requirements are indicated on the dipstick or on the dipstick handle. Refer to your Scheduled Maintenance Guide to determine the correct service interval.

Free Manuals Download Website

<http://myh66.com>

<http://usermanuals.us>

<http://www.somanuals.com>

<http://www.4manuals.cc>

<http://www.manual-lib.com>

<http://www.404manual.com>

<http://www.luxmanual.com>

<http://aubethermostatmanual.com>

Golf course search by state

<http://golfingnear.com>

Email search by domain

<http://emailbydomain.com>

Auto manuals search

<http://auto.somanuals.com>

TV manuals search

<http://tv.somanuals.com>