

## Contents

### Before driving

<b>Introduction</b>	<b>2</b>
---------------------	----------

<b>Instrumentation</b>	<b>6</b>
------------------------	----------

<b>Controls and features</b>	<b>18</b>
------------------------------	-----------

<b>Seating and safety restraints</b>	<b>74</b>
--------------------------------------	-----------

### Starting and driving

<b>Starting</b>	<b>108</b>
-----------------	------------

<b>Driving</b>	<b>112</b>
----------------	------------

<b>Roadside emergencies</b>	<b>136</b>
-----------------------------	------------

### Servicing

<b>Maintenance and care</b>	<b>158</b>
-----------------------------	------------

<b>Capacities and specifications</b>	<b>204</b>
--------------------------------------	------------

<b>Customer assistance</b>	<b>212</b>
----------------------------	------------

<b>Reporting safety defects</b>	<b>224</b>
---------------------------------	------------

<b>Index</b>	<b>225</b>
--------------	------------

All rights reserved. Reproduction by any means, electronic or mechanical including photocopying, recording or by any information storage and retrieval system or translation in whole or part is not permitted without written authorization from Ford Motor Company. Ford may change the contents without notice and without incurring obligation.

Copyright © 1999 Ford Motor Company

## Introduction

The following warning may be required by California law:

### **CALIFORNIA Proposition 65 Warning**



**WARNING:** Engine exhaust, some of its constituents, and certain vehicle components contain or emit chemicals known to the State of California to cause cancer and birth defects or other reproductive harm. In addition, certain fluids contained in vehicles and certain products of component wear contain or emit chemicals known to the State of California to cause cancer and birth defects or other reproductive harm.

### **ICONS**

Indicates a safety alert. Read the following section on *Warnings*.



Indicates vehicle information related to recycling and other environmental concerns will follow.



Correct vehicle usage and the authorized disposal of waste cleaning and lubrication materials are significant steps towards protecting the environment.

Indicates a message regarding child safety restraints. Refer to *Seating and safety restraints* for more information.



Indicates that this Owner Guide contains information on this subject. Please refer to the Index to locate the appropriate section which will provide you more information.



### **WARNINGS**

Warnings provide information which may reduce the risk of personal injury and prevent possible damage to others, your vehicle and its equipment.

## Introduction

### **BREAKING-IN YOUR VEHICLE**

There are no particular breaking-in rules for your vehicle. During the first 1 600 km (1 000 miles) of driving, vary speeds frequently. This is necessary to give the moving parts a chance to break in.

### **INFORMATION ABOUT THIS GUIDE**

The information found in this guide was in effect at the time of printing. Ford may change the contents without notice and without incurring obligation.

### **SPECIAL NOTICES**

#### **Notice to owners of diesel-powered vehicles**

Read the 7.3 Liter Power Stroke Direct Injection Turbo Diesel Owner's Guide Supplement for information regarding correct operation and maintenance of your diesel-powered light truck.

#### **Notice to owners of pickup trucks and utility type vehicles**



Utility vehicles have a significantly higher rollover rate than other types of vehicles.

Before you drive your vehicle, please read this Owner's Guide carefully. Your vehicle is not a passenger car. As with other vehicles of this type, failure to operate this vehicle correctly may result in loss of control or an accident.

Be sure to read *Driving off road* in the *Driving* chapter as well as the "Four Wheeling" supplement included with 4WD and utility type vehicles.

#### **Snowplowing**

The Excursion is not recommended for snowplow installation. Ford makes no representation as to the suitability of the Excursion for snowplowing, in particular regarding the potential for exceeding vehicle weight limits, airbag (SRS) deployment sensitivity, vehicle crash integrity, or powertrain durability. The Snowplow Package Option is not available.

## Introduction

These are some of the symbols you may see on your vehicle.

### Vehicle Symbol Glossary

Safety Alert		See Owner's Guide	
Fasten Safety Belt		Air Bag-Front	
Air Bag-Side		Child Seat	
Child Seat Installation Warning		Child Seat Tether Anchorage	
Brake System		Anti-Lock Brake System	
Brake Fluid - Non-Petroleum Based		Traction Control	
Master Lighting Switch		Hazard Warning Flasher	
Fog Lamps-Front		Fuse Compartment	
Fuel Pump Reset		Windshield Wash/Wipe	
Windshield Defrost/Demist		Rear Window Defrost/Demist	
Power Windows Front/Rear		Power Window Lockout	

## Introduction

### Vehicle Symbol Glossary

Child Safety Door  
Lock/Unlock



Interior Luggage  
Compartment Release  
Symbol



Panic Alarm



Engine Oil



Engine Coolant



Engine Coolant  
Temperature



Do Not Open When Hot



Battery



Avoid Smoking, Flames,  
or Sparks



Battery Acid



Explosive Gas



Fan Warning



Power Steering Fluid



Maintain Correct Fluid  
Level



Emission System



Engine Air Filter



Passenger Compartment  
Air Filter



Jack



## Instrumentation

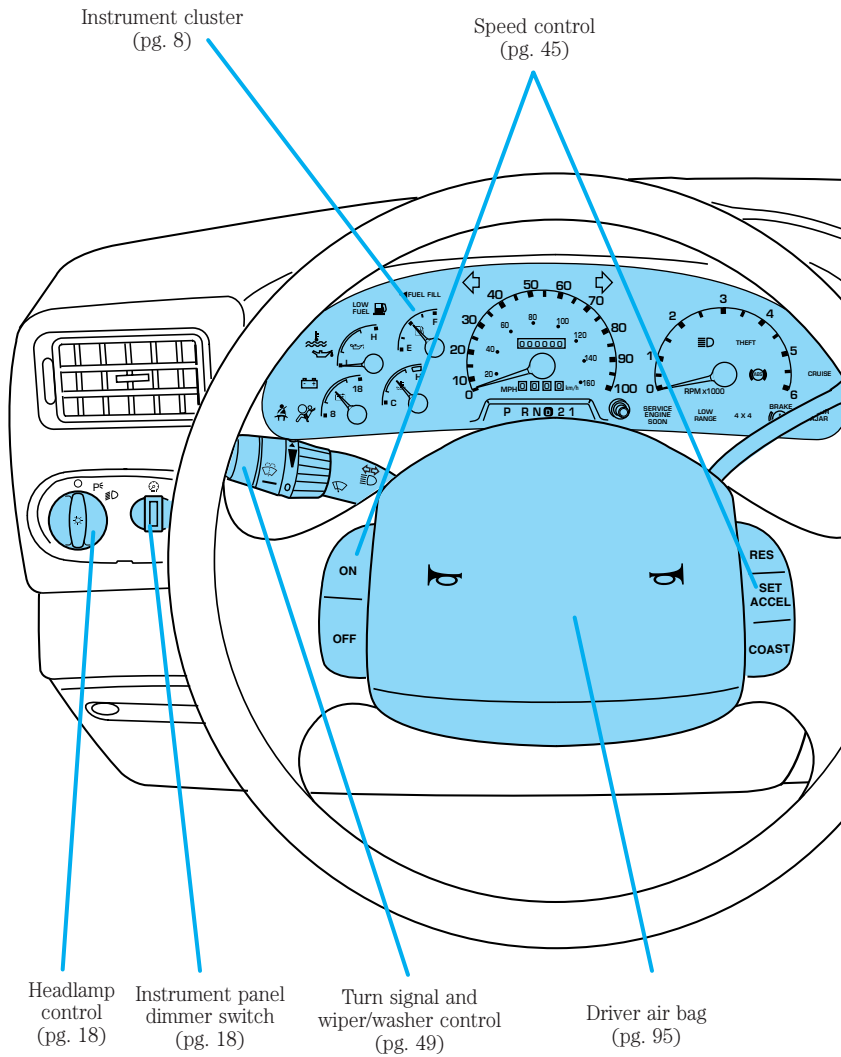

\* if equipped

## Instrumentation

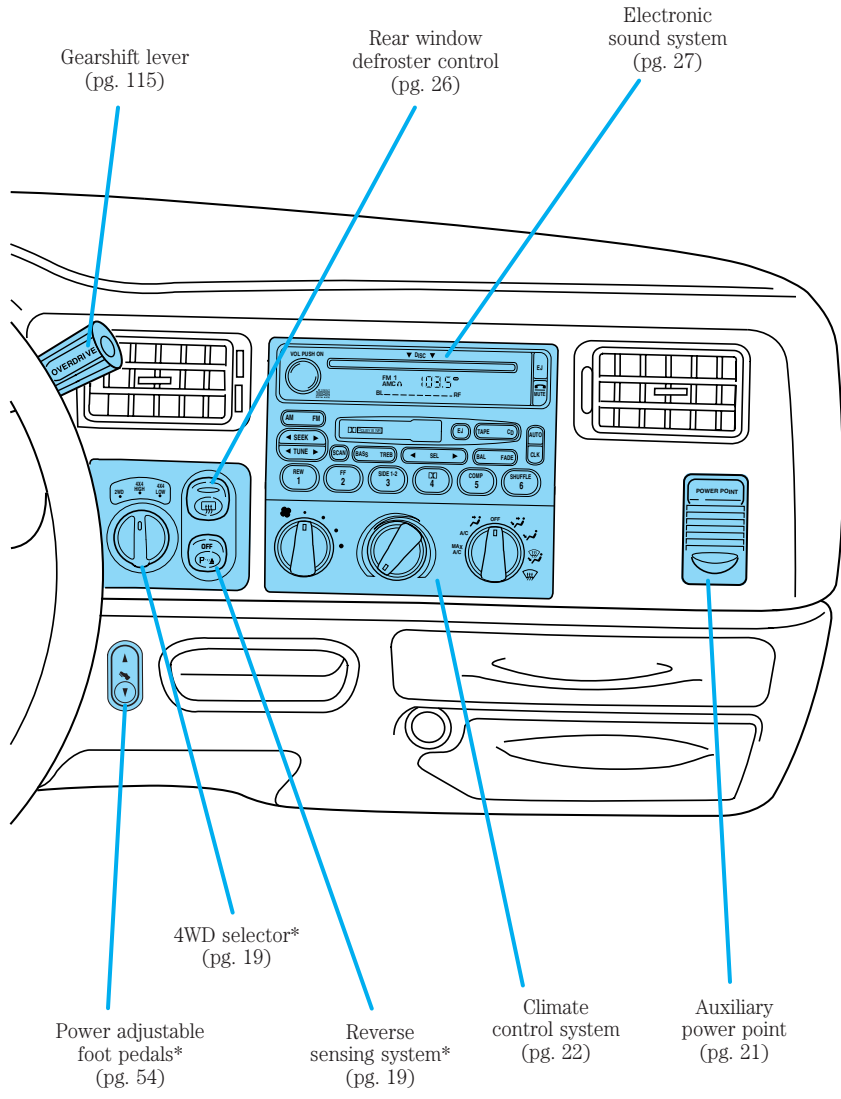

## Instrumentation

### WARNING LIGHTS AND CHIMES

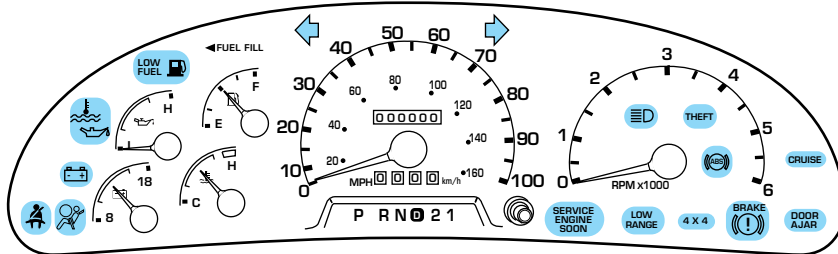

#### Low fuel

Illuminates as an early reminder of a low fuel condition indicated on the fuel gauge (refer to *Fuel Gauge* in this chapter for more information).



When refueling, after the light comes on, the amount of fuel that is added will be less than the advertised capacity since there is fuel still in the tank. The ignition must be in the ON position for this lamp to illuminate. The lamp will also illuminate for several seconds after the ignition is turned to the ON position regardless of the fuel level to ensure your bulb is working.

#### Service engine soon (California only)

Your vehicle is equipped with a computer that monitors the engine's emission control system. This system is commonly known as the On Board Diagnostics System (OBD II). This OBD II system protects the environment by ensuring that your vehicle continues to meet government emission standards. The OBD II system also assists the service technician in properly servicing your vehicle.



The *Service Engine Soon* indicator light illuminates when the ignition is first turned to the ON position to check the bulb. If it comes on after the engine is started, one of the engine's emission control systems may be malfunctioning. The light may illuminate without a driveability concern being noted. The vehicle will usually be drivable and will not require towing.



## Instrumentation

### **What you should do if the Service Engine Soon light illuminates**

#### **Light turns on solid:**

This means that the OBD II system has detected a malfunction.

Temporary malfunctions may cause your *Service Engine Soon* light to illuminate. Examples are:

1. The vehicle has run out of fuel. (The engine may misfire or run poorly.)
2. Poor fuel quality or water in the fuel.
3. The fuel cap may not have been properly installed and securely tightened.

These temporary malfunctions can be corrected by filling the fuel tank with high quality fuel of the recommended octane and/or properly installing and securely tightening the gas cap. After three driving cycles without these or any other temporary malfunctions present, the *Service Engine Soon* light should turn off. (A driving cycle consists of a cold engine startup followed by mixed city/highway driving.) No additional vehicle service is required.

If the *Service Engine Soon* light remains on, have your vehicle serviced at the first available opportunity.

#### **Light is blinking:**

Engine misfire is occurring which could damage your catalytic converter. You should drive in a moderate fashion (avoid heavy acceleration and deceleration) and have your vehicle serviced at the first available opportunity.



Under engine misfire conditions, excessive exhaust temperatures could damage the catalytic converter, the fuel system, interior floor coverings or other vehicle components, possibly causing a fire.

### **Service engine soon**

Your vehicle is equipped with a computer that monitors the engine's emission control system. This system is commonly known as the On Board Diagnostics System (OBD II). The OBD II system protects the environment by ensuring that your vehicle continues to meet

SERVICE  
ENGINE  
SOON

## Instrumentation

government emission standards. The OBD II system also assists the service technician in properly servicing your vehicle.

The *Service Engine Soon* indicator light illuminates when the ignition is first turned to the ON position to check the bulb. If it comes on after the engine is started, one of the engine's emission control systems may be malfunctioning. The light may illuminate without a driveability concern being noted. The vehicle will usually be drivable and will not require towing.

### **What you should do if the *Service Engine Soon* light illuminates**

#### **Light turns on solid:**

This means that the OBD II system has detected a malfunction.

Temporary malfunctions may cause your *Service Engine Soon* light to illuminate. Examples are:

1. The vehicle has run out of fuel. (The engine may misfire or run poorly.)
2. Poor fuel quality or water in the fuel.
3. The fuel cap may not have been properly installed and securely tightened.

These temporary malfunctions can be corrected by filling the fuel tank with high quality fuel of the recommended octane and/or properly installing and securely tightening the gas cap. After three driving cycles without these or any other temporary malfunctions present, the *Service Engine Soon* light should turn off. (A driving cycle consists of a cold engine startup followed by mixed city/highway driving.) No additional vehicle service is required.

If the *Service Engine Soon* light remains on, have your vehicle serviced at the first available opportunity.

#### **Light is blinking:**

Engine misfire is occurring which could damage your catalytic converter. You should drive in a moderate fashion (avoid heavy acceleration and deceleration) and have your vehicle serviced at the first available opportunity.



Under engine misfire conditions, excessive exhaust temperatures could damage the catalytic converter, the fuel system, interior floor coverings or other vehicle components, possibly causing a fire.

## Instrumentation

### Air bag readiness

Momentarily illuminates when the ignition is turned ON. If the light fails to illuminate, continues to flash or remains on, have the system serviced immediately.



### Transmission control indicator light (TCIL) (if equipped)

Illuminates when the Transmission Control Switch (TCS), refer to *Overdrive control* in the *Controls and Features* chapter, has been pushed turning the transmission overdrive function OFF. When the TCIL (the word OFF on the gear shift) light is on, the transmission does not operate in the overdrive mode, refer to the *Driving* chapter for transmission function and operation.

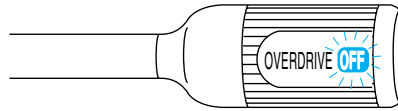

The light may also flash steadily if a transmission malfunction is detected. If the light does not come on when the Transmission Control Switch is depressed or if the light flashes steadily, have your vehicle serviced as soon as possible, damage to the transmission could occur.

### Safety belt

Momentarily illuminates when the ignition is turned to the ON position to remind you to fasten your safety belts. For more information, refer to the *Seating and safety restraints* chapter.



### Brake system warning

Momentarily illuminates when the ignition is turned to the ON position. Also illuminates if the parking brake is engaged. If the brake warning lamp does not illuminate at these times, seek service immediately. Illumination after releasing the parking brake indicates low brake fluid level and the brake system should be inspected immediately.



## Instrumentation

### Anti-lock brake system (ABS)

Momentarily illuminates when the ignition is turned to the ON position. If the light remains on, continues to flash or fails to illuminate, have the system serviced immediately. With the ABS light on, the anti-lock brake system is disabled and normal braking is still effective unless the brake warning light also remains illuminated with the parking brake released.



### Turn signal

Illuminates when the left or right turn signal or the hazard lights are turned on. If one or both of the indicators stay on continuously or flash faster, check for a burned-out turn signal bulb. Refer to *Exterior bulbs* in the *Maintenance and care* chapter.



### High beams

Illuminates when the high beam headlamps are turned on.



### Charging system

Illuminates when the ignition is turned to the ON position and the engine is off. The light also illuminates when the battery is not charging properly, requiring electrical system service.



### Four wheel drive indicator

Momentarily illuminates when the ignition is turned to the START position. Illuminates when 4x4 range is engaged. If the light continues to flash have the system serviced.



## Instrumentation

### Four wheel drive low

Momentarily illuminates when the ignition is turned to the START position. Illuminates when four-wheel drive low is engaged. If the light continues to flash have the system serviced.

**LOW  
RANGE**

### Door ajar

Illuminates when the ignition is in the ON or START position and any door is open.

**DOOR  
AJAR**

### Oil pressure/Engine coolant

This light will come on when the key is in the ON position and the:

- engine coolant temperature is very high
- engine oil pressure is low

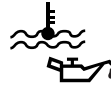

The light serves as a notice that a system needs your attention and to check the engine coolant temperature gauge and the engine oil pressure gauge.

Refer to *Engine coolant temperature gauge* and *Engine oil pressure gauge* in this chapter for more information.

### Speed control

This light comes on when either the COAST/SET or RES/ACCEL controls are pressed. It turns off when the cruise cancel control is pressed, the brake is applied or the ignition is turned to the OFF position.

**CRUISE**

### SecuriLock<sup>™</sup> anti-theft system

This light indicates the anti-theft alarm system is armed. Momentarily illuminates when the ignition is turned to ON/START. If the light fails to illuminate, continues to flash

**THEFT**

## Instrumentation

or remains on, have the system serviced. Refer to *SecuriLock™ passive anti-theft system* in the *Controls and features* chapter.

### Safety belt warning chime

Sounds to remind you to fasten your safety belts.

For information on the safety belt warning chime, refer to the *Seating and safety restraints* chapter.

### Supplemental restraint system (SRS) warning chime

For information on the SRS warning chime, refer to the *Seating and safety restraints* chapter.

### Key-in-ignition warning chime

Sounds when the ignition key is left in the ignition in the OFF/LOCK or ACC position and the driver's door is opened.

### Headlamps on warning chime

Sounds when the headlamps or parking lamps are on, the ignition in the OFF position (and the key is not in the ignition) and the driver's door is opened.

## GAUGES

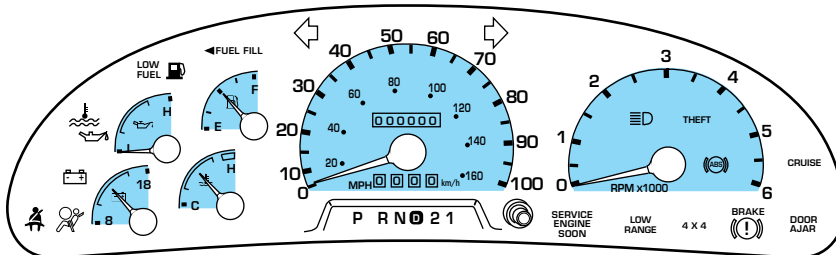

## Instrumentation

### Fuel gauge

Displays approximately how much fuel is in the fuel tank (when the key is in the ON position). The fuel gauge may vary slightly when the vehicle is in motion. The ignition should be in the OFF position while the vehicle is being refueled. When the gauge first indicates empty, there is a small amount of reserve fuel in the tank. When refueling the vehicle from an empty indication, the amount of fuel that can be added will be less than the advertised capacity due to the reserve fuel.

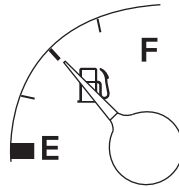

### Speedometer

Indicates the current vehicle speed.

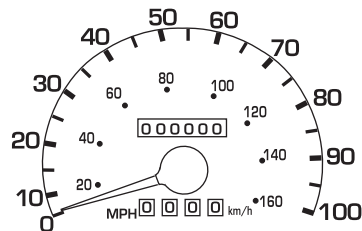

### Engine coolant temperature gauge

Indicates the temperature of the engine coolant. At normal operating temperature, the needle remains within the normal area (the area between the "H" and "C"). If it enters the red section, the engine is overheating. Stop the vehicle as soon as safely possible, switch off the engine immediately and let the engine cool. Refer to *Engine coolant* in the *Maintenance and care* chapter.

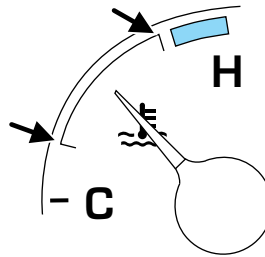

## Instrumentation



Never remove the coolant reservoir cap while the engine is running or hot.

This gauge indicates the temperature of the engine coolant, not the coolant level. If the coolant is not at its proper level the gauge indication will not be accurate.

### Odometer

Registers the total kilometers (miles) of the vehicle.

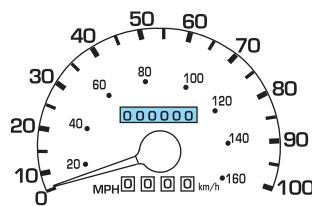

### Trip odometer

Registers the kilometers (miles) of individual journeys. To reset, depress the control.

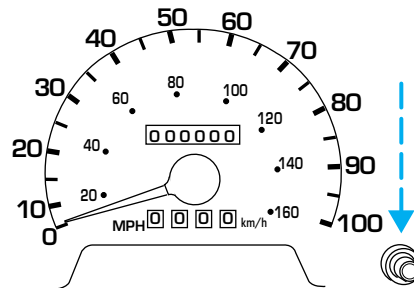



## Instrumentation

### Tachometer

Indicates the engine speed in revolutions per minute.

Driving with your tachometer pointer continuously at the top of the scale may damage the engine.

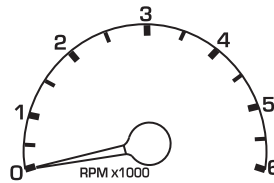

### Battery voltage gauge

This shows the battery voltage when the ignition is in the ON position. If the pointer moves and stays outside the normal operating range (as indicated), have the vehicle's electrical system checked as soon as possible.

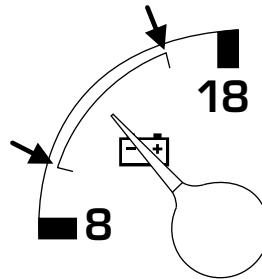

### Engine oil pressure gauge

This shows the engine oil pressure in the system. Sufficient pressure exists as long as the needle remains in the normal range (the area between the "L" and "H").

If the gauge indicates low pressure, stop the vehicle as soon as safely possible and switch off the engine immediately. Check the oil level. Add oil if needed (refer to *Engine oil* in the *Maintenance and care* chapter). If the oil level is correct, have your vehicle checked at your dealership or by a qualified technician.

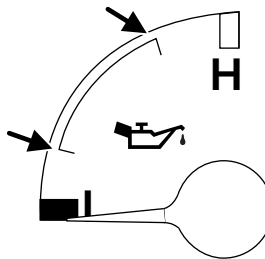

## Controls and features

### HEADLAMP CONTROL ☀️

Rotate the headlamp control to the first position to turn on the parking lamps. Rotate to the second position to also turn on the headlamps.

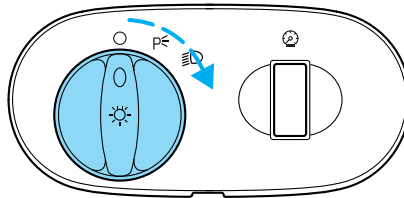

### Daytime running lamps (DRL) (if equipped)

Turns the headlamps on with a reduced output. To activate:

- the ignition must be in the ON position and
- the headlamp control is in the OFF or Parking lamps position.



Always remember to turn on your headlamps at dusk or during inclement weather. The Daytime Running Light (DRL) System does not activate your tail lamps and generally may not provide adequate lighting during these conditions. Failure to activate your headlamps under these conditions may result in a collision.

### PANEL DIMMER CONTROL 🧑

Use to adjust the brightness of the instrument panel during headlamp and parklamp operation.

- Rotate up to brighten.
- Rotate down to dim.
- Rotate to full up position (past detent) to turn on interior lamps.

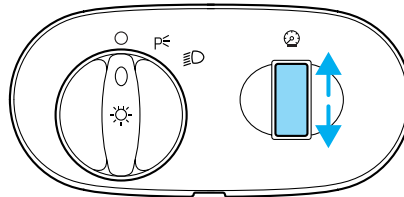

## Controls and features

### 4WD CONTROL (IF EQUIPPED)

This control operates the 4WD. Refer to the *Driving* chapter for more information.

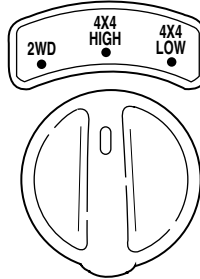

### Reverse sensing system (if equipped) P

The reverse sensing system (RSS) sounds a tone to warn the driver of obstacles near the rear bumper when the reverse gear is selected.



To help avoid personal injury, please read and understand the limitations on the reverse sensing system described below.

Reverse sensing is only an assist for some (generally large and fixed) objects when moving in reverse on a flat surface at “parking speeds” of approximately 6 km/h (4 mph) or less. The weather may also affect the function of RSS. RSS may have reduced performance, or be activated in inclement weather. It is the driver’s responsibility for ensuring that their path is clear when operating the vehicle.



To help avoid personal injury, always use caution when in reverse and when using the reverse sensing system.



This system is not designed to prevent contact with small or moving objects. The system is designed to provide a warning to assist the driver in detecting large stationary objects to avoid damaging the vehicle. The system may not detect smaller objects, particularly those close to the ground.

The RSS will assist the driver in detecting certain objects while the vehicle slowly moves in reverse at speeds less than 6 km/h (4 mph). The RSS is not effective at speeds greater than 6 km/h (4 mph) and may not detect certain angular or moving objects.

## Controls and features

The reverse sensing system detects obstacles within approximately 1.8 meters (5.9 ft.) of the rear bumper with a decreased coverage area at the outer corners of the bumper, (refer to the figures for approximate zone coverage areas). As you move closer to the obstacle, the rate of the tone increases. When the distance to the obstacle is less than 25.0 cm (10 in.), the tone will sound continuously. If the system detects a stationary or receding object further than 25.0 cm (10 in.) from the side of the vehicle, the tone will sound for only three seconds. Once the system detects an object approaching, the tone will sound again.

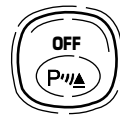
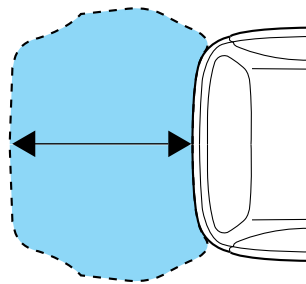
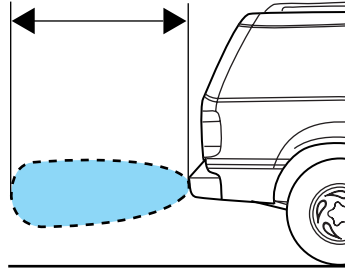

The reverse sensing system is automatically enabled when the gear selector is placed in R (Reverse) and the ignition is ON. A reverse sensing control allows the driver to disable the reverse sensing system when the ignition is ON, and the gear selector is in R (Reverse).

The OFF indicator remains illuminated when the system is disabled. The system defaults to ON every time the reverse gear is selected. Press the control to disable or enable the system.

The indicator will remain illuminated to indicate a failure of the reverse sensing system.

**Always keep the sensors (located on the rear bumper/fascia) free from dirt, snow and ice (do not clean the sensors with sharp objects). These elements may cause the system to operate inaccurately.**

**If the vehicle sustains damage to the rear bumper/fascia, leaving it misaligned or bent, the sensing zone may be altered causing inaccurate measurement of obstacles.**

## Controls and features

### AUXILIARY POWER POINT 12V

The power point is an additional power source for electrical accessories. Do not plug optional electrical accessories into the cigarette lighter. Use the powerpoint.

The maximum current draw of any single power point is 20 Amps. Exceeding this limit may result in a blown fuse.

There are up to four auxiliary power points in the following locations:

- Located on the instrument panel.

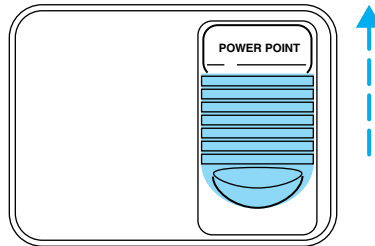

- Located on the back side of the center console (Accessible from the second row seats).

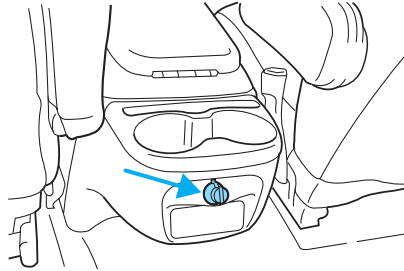

- Located in the left side storage compartment in the third row seating position.

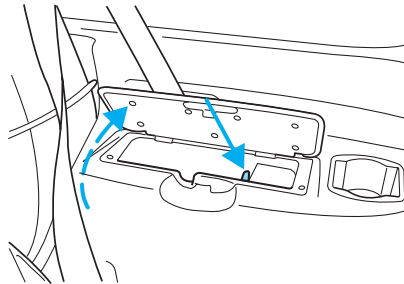

## Controls and features

- Located on the right trim panel in the rear cargo area.

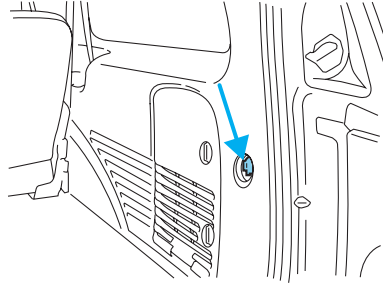

### CLIMATE CONTROL SYSTEM

#### Manual heating and air conditioning system



#### **Fan speed control**

Controls the volume of air circulated in the vehicle.



#### **Temperature control knob**

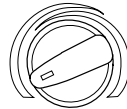

Controls the temperature of the airflow inside the vehicle.



#### **Mode selector control**

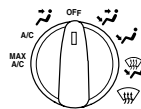



Controls the direction of the airflow to the inside of the vehicle.



The air conditioning compressor can operate in all modes except  and . However, the air conditioning will only function if the outside temperature is about 10°C (50°F) or higher.

## Controls and features

Since the air conditioner removes considerable moisture from the air during operation, it is normal if clear water drips on the ground under the air conditioner drain while the system is working and even after you have stopped the vehicle.

- MAX A/C-Uses recirculated air to cool the vehicle. MAX A/C is noisier than A/C but more economical and will cool the inside of the vehicle faster. Airflow will be from the instrument panel registers. This mode can also be used to prevent undesirable odors from entering the vehicle.
- A/C-Uses outside air to cool the vehicle. It is quieter than MAX A/C but not as economical. Airflow will be from the instrument panel registers.
-  (Panel)-Distributes outside air through the instrument panel registers. However, the air will not be cooled below the outside temperature because the air conditioning does not operate in this mode.
- OFF-Outside air is shut out and the fan will not operate. For short periods of time only, use this mode to prevent undesirable odors from entering the vehicle.
-  (Panel and floor)-Distributes outside air through the instrument panel registers and the floor ducts. Heating and air conditioning capabilities are provided in this mode. For added customer comfort, when the temperature control knob is anywhere in between the full hot and full cold positions, the air distributed through the floor ducts will be slightly warmer than the air sent to the instrument panel registers.
-  (Floor)-Allows for maximum heating by distributing outside air through the floor ducts. However, the air will not be cooled below the outside temperature because the air conditioning does not operate in this mode.
-  (Floor and defrost)-Distributes outside air through the windshield defroster ducts and the floor ducts. Heating and air conditioning capabilities are provided in this mode. For added customer comfort, the air distributed through the floor ducts will be slightly warmer than the air sent to the windshield defroster ducts. If the temperature is about 10°C (50°F) or higher, the air conditioner will automatically dehumidify the air to reduce fogging.
-  (Defrost)-Distributes outside air through the windshield defroster ducts. It can be used to clear ice or fog from the windshield. If the temperature is about 10°C (50°F) or higher, the air conditioner will automatically dehumidify the air to reduce fogging.

## Controls and features

### Operating tips

- In humid weather, select  before driving. This will reduce fogging on your windshield. After a few minutes, select any desired position.
- To prevent humidity buildup inside the vehicle, don't drive with the climate control system in the OFF or MAX A/C position.
- Don't put objects under the front seat that will interfere with the airflow to the rear seats (if equipped).
- Remove any snow, ice or leaves from the air intake area (at the bottom of the windshield under the hood).

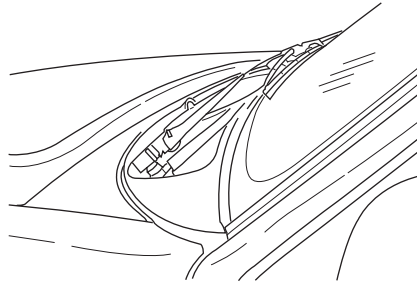

- If your vehicle has been parked with the windows closed during hot weather, the air conditioner will do a much faster job of cooling if you drive for two or three minutes with the windows open. This will force most of the hot, stale air out of the vehicle. Then operate your air conditioner as you would normally.
- Do not place objects over the defroster outlets. These objects can block airflow and reduce your ability to see through your windshield. Also, avoid placing small objects on top of your instrument panel. These objects can fall down into the defroster outlets and block airflow and possibly damage your climate control system.



Do not place objects on top of the instrument panel, as these objects may become projectiles in a collision or sudden stop.

### Auxiliary A/C-heater controls (if equipped)

The auxiliary A/C-heater feature provides increased capacity to quickly heat or cool the vehicle. Besides the driver's control panel for the front seat occupants, the second row auxiliary A/C-heater controls allow the rear passengers to control the temperature in the rear of the vehicle through a second control panel above the second row.



## Controls and features

Your auxiliary A/C controls are located in the overhead console.

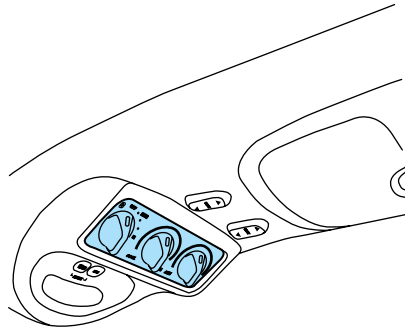

In order for the auxiliary A/C-heater controls to function, the driver's auxiliary A/C-heater control must be set to REAR.

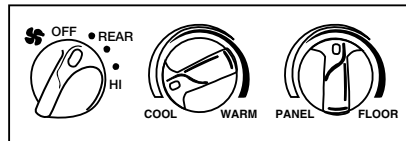

The instrument panel A/C - heater controls must be on in order for the auxiliary A/C-heater to operate.



When the auxiliary A/C-heater control is set to FLOOR, airflow only occurs from the third row seat floor vent located in the passenger's side rear quarter trim panel.

When the auxiliary A/C-heater control is set to PANEL, airflow occurs from the overhead 2nd and 3rd row registers.

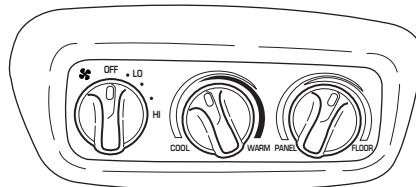

## Controls and features

Turn the fan speed control knob to the desired speed.

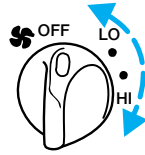

Turn the temperature control to the desired temperature.

If the front seat control panel is set to MAX A/C, only cool air will be provided because no heating is available in this mode. You can get warm or cool air through either the overhead registers or floor vent by turning the auxiliary mode selector:



- Far left for airflow to the overhead registers.
- Far right for airflow to the rear floor vent.
- Anywhere between PANEL and FLOOR to vary airflow between the outlets.



### REAR WINDOW DEFROSTER

The rear defroster control is located on the instrument panel.

Press the rear defroster control to clear the rear window of thin ice and fog.

- A small LED will illuminate when the rear defroster is activated.

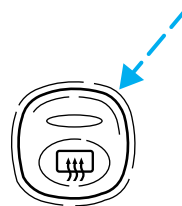

The ignition must be in the ON position to operate the rear window defroster.

The defroster turns off automatically after 10 minutes or when the ignition is turned to the OFF position. To manually turn off the defroster before 10 minutes have passed, push the control again.

## Controls and features

Activating the rear window defroster will also activate the heated mirrors (if equipped). For more information refer to *Heated Outside Mirrors* in this section.

### USING YOUR AUDIO SYSTEM

#### Premium AM/FM Stereo/Cassette/Single CD

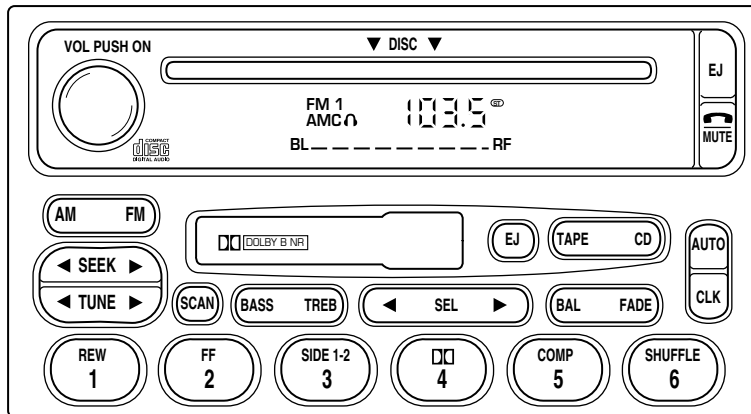

#### **Volume/power control**

Press the control to turn the audio system on or off.

Audio power can also be turned on by pressing the AM/FM select control or the tape/CD select control. Audio power is turned off by using the volume/power control.

#### **VOL - PUSH ON**

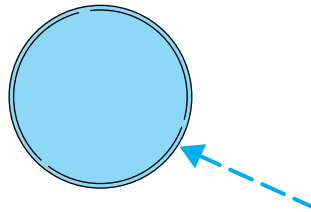

## Controls and features

Turn control to raise or lower volume.

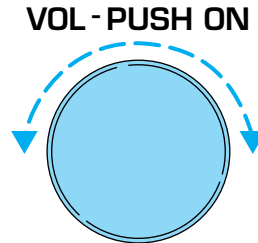

If the volume is set above a certain level and the ignition is turned off, the volume will come back on at a “nominal” listening level when the ignition switch is turned back on.

### ***AM/FM select***

The AM/FM select control works in radio, tape and CD modes.



### ***AM/FM select in radio mode***

This control allows you to select AM or FM frequency bands. Press the control to switch between AM, FM1 or FM2 memory preset stations.

### ***AM/FM select in tape mode***

Press this control to stop tape play and begin radio play.

### ***AM/FM select in CD or CD changer mode (if equipped)***

Press this control to stop CD play and begin radio play.

### ***Tune adjust***

The tune control works in radio or CD changer mode.

## Controls and features

### **Tune adjust in radio mode**

- Press ◀ to move to the next frequency down the band (whether or not a listenable station is located there). Hold the control to move through the frequencies quickly.
- Press ▶ to move to the next frequency up the band (whether or not a listenable station is located there). Hold for quick movement.

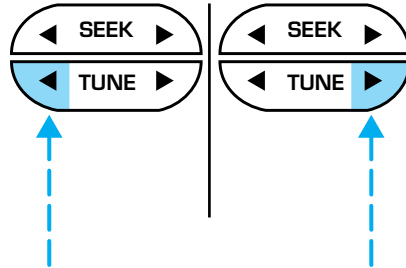

### **Tune adjust for CD changer (if equipped)**

- Press ◀ to select the previous disc in the CD changer. (Play will begin on the first track of the disc unless the CD changer is in shuffle mode. Refer to *Shuffle feature* for more information. Hold the control to continue reversing through the remaining discs.
- Press ▶ to select the next disc in the CD changer. Hold the control to fast-forward through the remaining discs.

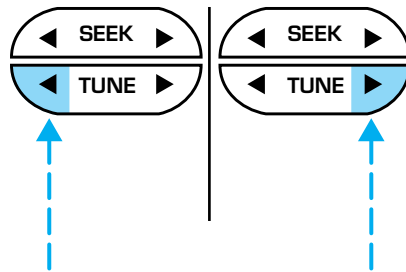

### **Seek function**

The seek function control works in radio, tape or CD mode.

## Controls and features

### Seek function in radio mode

- Press ◀ to find the next listenable station down the frequency band.
- Press ▶ to find the next listenable station up the frequency band.

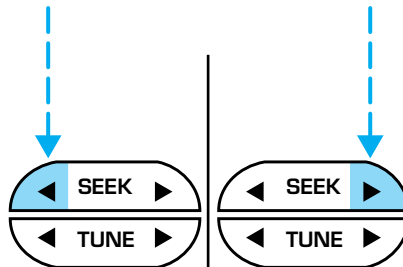

### Seek function in tape mode

- Press ◀ to listen to the previous selection on the tape.
- Press ▶ to listen to the next selection on the tape.

### Seek function for CD or CD changer (if equipped)

- Press ◀ to seek to the previous track of the current disc. If a selection has been playing for three seconds or more and you press ◀, the CD changer will replay that selection from the beginning.
- Press ▶ to seek forward to the next track of the current disc. After the last track has been completed, the first track of the current disc will automatically replay.

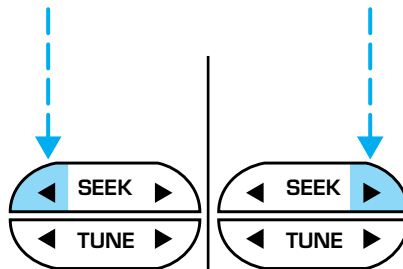

### Scan function

The scan function works in radio, tape or CD mode.



### Scan function in radio mode

Press the SCAN control to hear a brief sampling of all listenable stations on the frequency band. Press the control again to stop the scan mode.

## Controls and features

### **Scan function in tape mode**

Press the SCAN control to hear a short sampling of all selections on the tape. (The tape scans in a forward direction. At the end of the tape's first side, direction automatically reverses to the opposite side of the tape.) To stop on a particular selection, press the control again.

### **Scan function in CD or CD changer mode (if equipped)**

Press the SCAN control to hear a short sampling of all selections on the CD. (The CD scans in a forward direction, wrapping back to the first track at the end of the CD.) To stop on a particular selection, press the control again.

### **Radio station memory preset**

The radio is equipped with six station memory preset controls. These controls can be used to select up to six preset AM stations and twelve FM stations (six in FM1 and six in FM2).

### **Setting memory preset stations**



1. Select the frequency band with the AM/FM select control.
2. Select a station. Refer to *Tune adjust* or *Seek function* for more information on selecting a station.

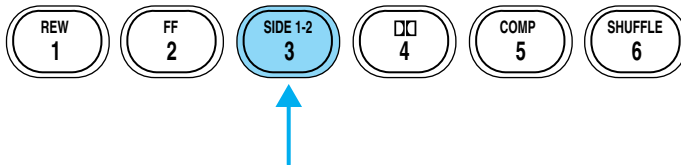

3. Press and hold a memory preset control until the sound returns, indicating the station is held in memory on the control you selected.

### **Autoset memory preset**

Autoset allows you to set strong radio stations without losing your original manually set preset stations. This feature is helpful on trips when you travel between cities with different radio stations.

## Controls and features

### Starting autose memory preset

1. Select a frequency using the AM/FM select controls.
2. Press the AUTO control.
3. When the first six strong stations are filled, the station stored in memory preset control 1 will start playing.

If there are less than six strong stations available on the frequency band, the remaining memory preset controls will all store the last strong station available.

These stations are temporarily stored in the memory preset controls (until deactivated) and are accessed in the same manner of your original presets.

To deactivate autose and return to your audio system's manually set memory stations, press the AUTO control again.

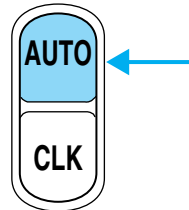

### Bass adjust

The bass adjust control allows you to increase or decrease the audio system's bass output.

Press the BASS control then press:

- ◀ to decrease the bass output and
- ▶ to increase the bass output.

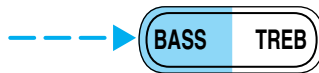

### Treble adjust

The treble adjust control allows you to increase or decrease the audio system's treble output.





## Controls and features

Press the TREB control then press:

- ◀ to decrease the treble output and
- ▶ to increase the treble output.

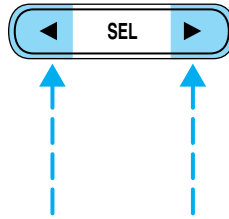

### **Speaker balance adjust**

Speaker sound distribution can be adjusted between the right and left speakers.

Press the BAL control then press:

- ◀ to shift sound to the left and
- ▶ to shift sound to the right.

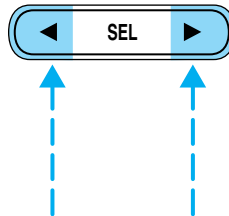

### **Speaker fade adjust**

Speaker sound can be adjusted between the front and rear speakers.

Press the FADE control then press:

- ▶ to shift the sound to the front and
- ◀ to shift the sound to the rear.

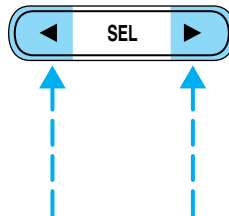

## Controls and features

### **Tape/CD select**

- To begin tape play (with a tape loaded into the audio system) while in the radio or CD mode, press the TAPE control. Press the button during rewind or fast forward to stop the rewind or fast forward function.
- To begin CD play (if CD(s) are loaded), press the CD control. The first track of the disc will begin playing. If returning from radio or tape mode, CD play will begin where it stopped last.



With the dual media audio system, press the CD control to toggle between single CD and CD changer play (if equipped).

### **Rewind**

The rewind control works in tape and CD modes.

- In tape mode, radio play will continue until rewind is stopped (with the TAPE control) or the beginning of the tape is reached.
- In CD mode, pressing the REW control rewinds the CD within the current track.

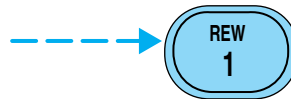

### **Fast forward**

The fast forward control works in tape and CD modes.

- In the tape mode, tape direction will automatically reverse when the end of the tape is reached.
- In CD mode, pressing the control fast forwards the CD within the current track.

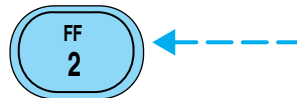

### **Tape direction select**

Press SIDE 1-2 to play the alternate side of a tape.

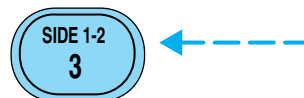

## Controls and features

### **Eject function**

Press the EJ control to stop and eject a tape.

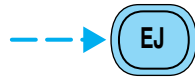

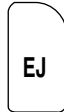

Press the EJ control to stop and eject a CD.

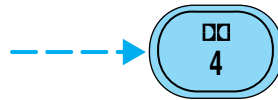

### **Dolby® noise reduction**

Dolby® noise reduction operates in tape mode. Dolby® noise reduction reduces the amount of hiss and static during tape playback.



Press the  control to activate (and deactivate) the Dolby® noise reduction.

Dolby® noise reduction is manufactured under license from Dolby® Laboratories Licensing Corporation. “Dolby®” and the double-D symbol  are trademarks of Dolby® Laboratories Licensing Corporation.

### **Compression adjust**

Compression adjust brings soft and loud CD passages together for a more consistent listening level.

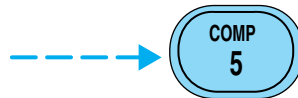

Press the COMP control to activate and deactivate compression adjust.

### **Shuffle feature**

The shuffle feature operates in CD mode (if equipped) and plays all tracks on the current disc in random order. If equipped with the CD changer, the shuffle feature continues to the next disc after all tracks on the current disc are played.

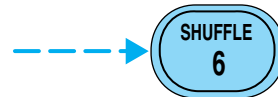

Press the SHUFFLE control to start this feature. Random order play will continue until the SHUFFLE control is pressed again.

## Controls and features

### Setting the clock

To set the hour, press and hold the CLK control and press SEEK:

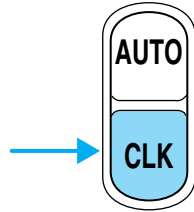

- ◀ to decrease hours and
- ▶ to increase hours.

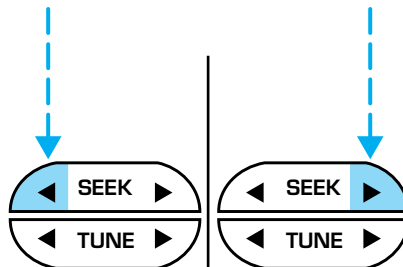

To set the minute, press and hold the CLK control and press TUNE:

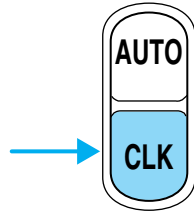

- ◀ to decrease minutes and
- ▶ to increase minutes.

If your vehicle has a separate clock module, (other than the digital radio display), the CLK button will not function in the above manner.

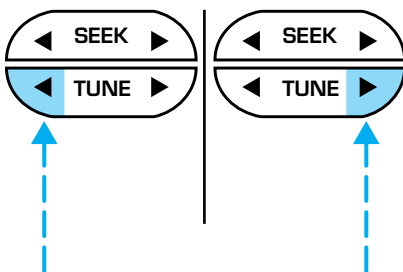

## Controls and features

The CLK button will allow you to switch between media display mode (radio station, stereo information, etc.) and clock display mode (time).

When in clock mode, the media information will display for 10 seconds, when the radio is turned on, and then revert to clock information. Anytime that the media is changed, (new radio station, etc.), the media information will again display for 10 seconds before reverting back to the clock. In media mode, the media information will always be displayed.

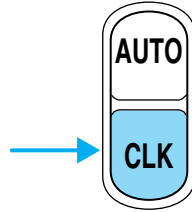

### Mute mode

Press the control to mute the playing media. Press the control again to return to the playing media.

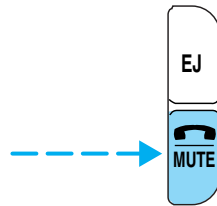

### Rear seat controls (if equipped)

The Rear Seat Controls (RSC) allow the rear seat passengers to operate the radio, tape, CD, or CD changer (if equipped).

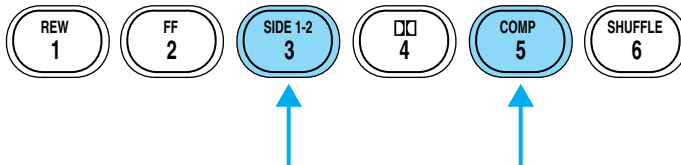
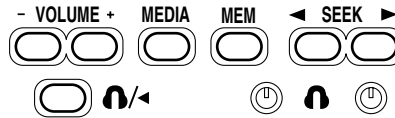

To turn on the rear seat controls, press the memory preset controls 3 and 5 at the same time. The  will appear in the radio display.

Pressing 3 and 5 at the same time again will turn the rear seat controls off.

## Controls and features

If there is a discrepancy between the rear seat and the front audio controls, (i.e, both trying to listen to the same playing media), the front audio system will receive the desired selection.

### Adjusting the volume

Press the + control to increase volume.



Press the — control to decrease volume.

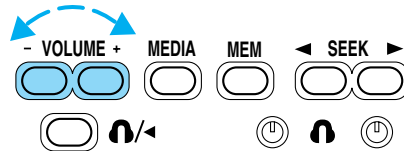

From the RSC controls, the speaker volume can not be set higher than the current volume radio setting. Once in headphone mode, the RSC volume controls will only change volume in the headphones to a desired level and will have no effect on the front speakers (muting the speakers will not mute the headphones).



### Using headphones/Personal Audio System

The Personal Audio System allows the rear seat passengers to listen to one media source (radio, tape, CD, or CD changer if equipped) while the front seat passengers listen to another. However, front and rear seat passengers can not listen to two different radio stations simultaneously.

Plug a 3.5 mm headphone (not included) into either one of the two  jacks. Press the  /  control to operate the headphones.

The rear speakers will cut out once the speaker on/off control is pressed. A soft audible sound may be heard from the rear speakers. The front speaker will remain playing for the front passengers. Press the  /  control again to deactivate the headphones (Personal Audio System).

### Media select

Push the MEDIA control to toggle between AM, FM1, FM2, tape, CD, or CD changer (if equipped).

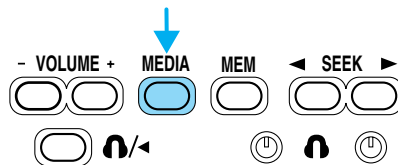

## Controls and features

### Memory preset control

Push the MEM control successively to allow rear seat passengers to scroll through the six memory presets in AM, FM1, or FM2.

Push the MEM control in CD changer mode (if equipped) to advance to the next disc.

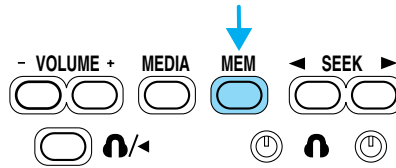

### Seek function

- Press ◀ to find the next listenable station down the frequency band.
- Press ▶ to find the next listenable station up the frequency band.

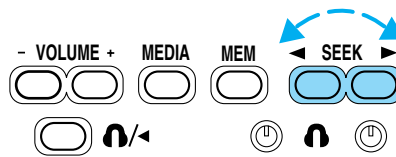

In tape mode, use the SEEK function to access the next ▶ or previous ◀ selection.

In CD or CD changer mode (if equipped), use the SEEK function to access the next ▶ or the previous ◀ selection.

### CD changer (if equipped)

The CD changer is either located in the center console of your vehicle.

1. Slide the door to access the CD changer magazine.

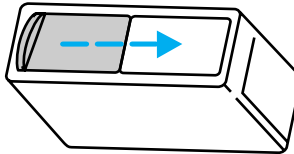

## Controls and features

2. Press  to eject the magazine.

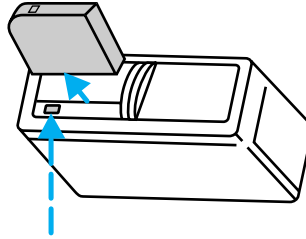

3. Turn the magazine (A) over.

4. Using the disc holder release knob (C), pull the disc holder (B) out of the magazine.

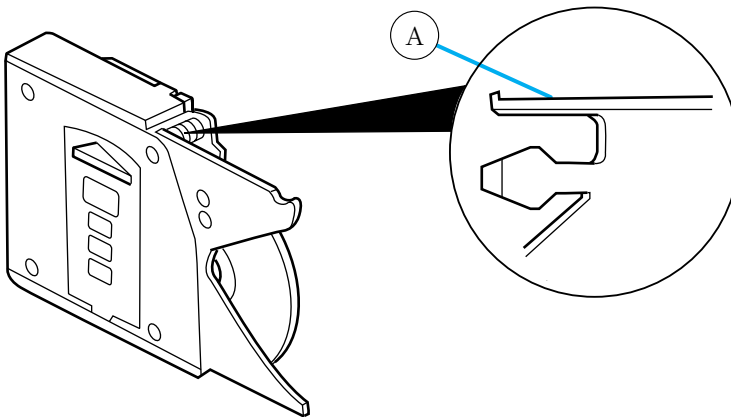
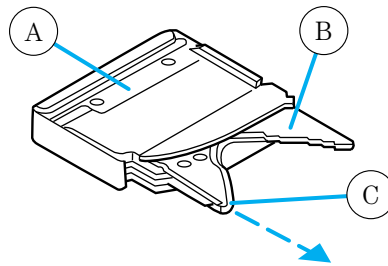

If you pull too hard on the disc holder, the disc holder may come completely out of the magazine. If this happens, reinsert the disc holder back into the magazine while pressing on the lever (A).



## Controls and features

5. Line up the CD with the groove of the disc holder. Ensure that the label on the CD faces downwards.

6. Press in on the disc holder until it locks securely into the magazine. If the disc holders are not fully locked into the magazine, the unit will not operate.

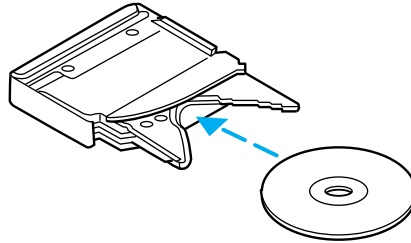

Ensure that the disc holder is evenly inserted and at the same level as the magazine (A). The unit will not operate if the disc holder is not inserted at the same level (B).

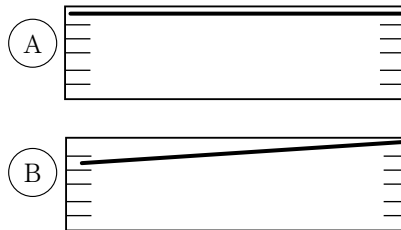

Radio power must be turned on to play the CDs in the changer. The magazine may be stored in the glove box when not being used.

The CD magazine may be inserted or ejected with the radio power off.

**ONLY** use the magazine supplied with the CD changer, other types will damage the unit.

Keep the CD changer door closed. Coins and foreign objects will damage the CD player and void your audio system warranty.

**Do not insert any promotional (odd shaped or sized) discs, or discs with removable labels into the CD changer as jamming may occur.**

### Troubleshooting the CD changer (if equipped)



The laser beam used in the compact disc player is harmful to the eyes. Do not attempt to disassemble the case.

If sound skips:

- You may be traveling on a rough road, playing badly scratched discs or the disc may be dirty. Skipping will not scratch the discs or damage the player.

## Controls and features

If your changer does not work, it may be that:

- A disc is already loaded where you want to insert a disc.
- The disc is inserted with the label surface downward.
- The disc is dusty or defective.
- The player's internal temperature is above 60°C (140°F). Allow the player to cool down before operating.
- A disc with format and dimensions not within industry standards is inserted.

### **Cleaning compact discs**

Inspect all discs for contamination before playing. If necessary, clean discs only with an approved CD cleaner and wipe from the center out to the edge. Do not use circular motion.

### **CD and CD changer care**

- Handle discs by their edges only. Never touch the playing surface.
- Do not expose discs to direct sunlight or heat sources for extended periods of time.
- Do not insert more than one disc into each slot of the CD changer magazine.

### **Cleaning cassette player (if equipped)**

Clean the tape player head with a cassette cleaning cartridge after 10 to 12 hours of play in order to maintain the best sound and operation.

### **Cassette and cassette player care**

- Use only cassettes that are 90 minutes long or less.
- Do not expose tapes to direct sunlight, high humidity, extreme heat or extreme cold. Allow tapes that may have been exposed to extreme temperatures to reach a moderate temperature before playing.
- Tighten very loose tapes by inserting a finger or pencil into the hole and turning the hub.
- Remove loose labels before inserting tapes.
- Do not leave tapes in the cassette player for a long time when not being played.

## Controls and features

### Radio frequency information

The Federal Communications Commission (FCC) and the Canadian Radio and Telecommunications Commission (CRTC) establish the frequencies AM and FM stations may use for their broadcasts. Allowable frequencies are:

AM 530, 540–1600, 1610 kHz

FM 87.7, 87.9–107.7, 107.9 MHz

Not all frequencies are used in a given area.

### Radio reception factors

Three factors can affect radio reception:

- **Distance/strength.** The further an FM signal travels, the weaker it is. The listenable range of the average FM station is approximately 40 km (24 miles). This range can be affected by “signal modulation.” Signal modulation is a process radio stations use to increase their strength/volume relative to other stations.
- **Terrain.** Hills, mountains and tall buildings between your vehicle’s antenna and the radio station signal can cause FM reception problems. Static can be caused on AM stations by power lines, electric fences, traffic lights and thunderstorms. Moving away from an interfering structure (out of its “shadow”) returns your reception to normal.
- **Station overload.** Weak signals are sometimes captured by stronger signals when you pass a broadcast tower. A stronger signal may temporarily overtake a weaker signal and play while the weak station frequency is displayed.

The audio system automatically switches to single channel reception if it will improve the reception of a station normally received in stereo.

### Audio system warranties and service

Refer to the “Warranty Guide” for audio system warranty information.

If service is necessary, see your dealer or a qualified technician.

## Controls and features

### POSITIONS OF THE IGNITION

1. ACCESSORY, allows the electrical accessories such as the radio to operate while the engine is not running.

2. LOCK, locks the steering wheel, automatic transmission gearshift lever and allows key removal.

3. OFF, shuts off the engine and all accessories without locking the steering wheel.

4. ON, all electrical circuits operational. Warning lights illuminated. Key position when driving.

5. START, cranks the engine. Release the key as soon as the engine starts.

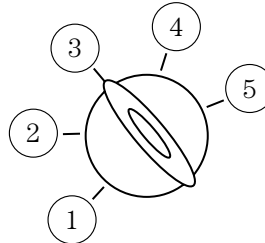

### TURN SIGNAL CONTROL ⇐⇒

- Push down to activate the left turn signal.
- Push up to activate the right turn signal.

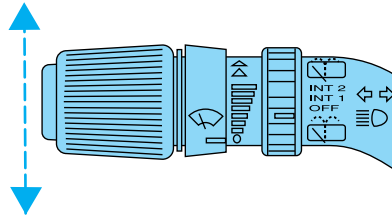

## Controls and features

### SPEED CONTROL

#### To turn speed control on

- Press ON.

Vehicle speed cannot be controlled until the vehicle is traveling at or above 48 km/h (30 mph).

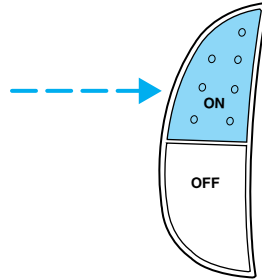

Do not use the speed control in heavy traffic or on roads that are winding, slippery, or unpaved.



Do not shift the gearshift lever into N (Neutral) with the speed control on.

#### To turn speed control off

- Press OFF or
- Turn off the vehicle ignition.

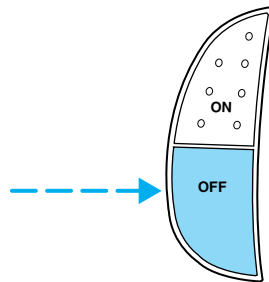

Once speed control is switched off, the previously programmed set speed will be erased.

## Controls and features

### To set a speed

- Press SET/SET ACC/SET ACCEL. For speed control to operate, the speed control must be ON and the vehicle speed must be greater than 48 km/h (30 mph).

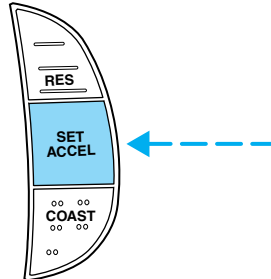

If you drive up or down a steep hill, your vehicle speed may vary momentarily slower or faster than the set speed. This is normal.

Speed control cannot reduce the vehicle speed if it increases above the set speed on a downhill. If your vehicle speed is faster than the set speed while driving on a downhill, you may want to shift to the next lower gear or apply the brakes to reduce your vehicle speed.

If your vehicle slows down more than 16 km/h (10 mph) below your set speed on an uphill, your speed control will disengage. This is normal. Pressing RES/RSM/RESUME will re-engage it.



Do not use the speed control in heavy traffic or on roads that are winding, slippery, or unpaved.

### To set a higher set speed

- Press and hold SET/SET ACC/SET ACCEL. Release the control when the desired vehicle speed is reached or
- Press and release SET/SET ACC/SET ACCEL to operate the Tap-Up function. Each press will increase the set speed by 1.6 km/h (1 mph) or
- Accelerate with your accelerator pedal. When the desired vehicle speed is reached, press and release SET/SET ACC/SET ACCEL.

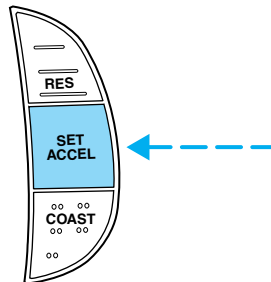

## Controls and features

You can accelerate with the accelerator pedal at any time during speed control usage. Releasing the accelerator pedal will return your vehicle to the previously programmed set speed.

### To set a lower set speed

- Press and hold CST/COAST.  
Release the control when the desired speed is reached or
- Press and release CST/COAST to operate the Tap-Down function.  
Each press will decrease the set speed by 1.6 km/h (1 mph) or

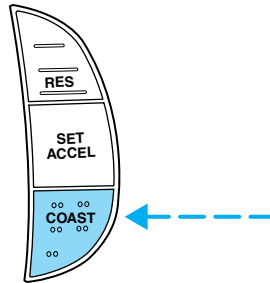

- Depress the brake pedal. When the desired vehicle speed is reached, press SET/SET ACC/ SET ACCEL.

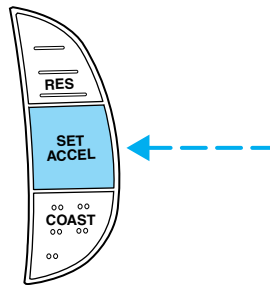

### To disengage speed control

- Depress the brake pedal.

Disengaging the speed control will not erase the previously programmed set speed.

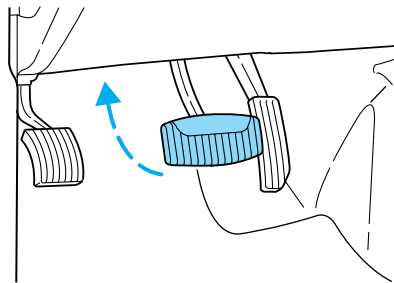

## Controls and features

Pressing OFF will erase the previously programmed set speed.

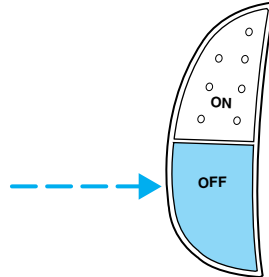

### To return to a previously set speed

- Press RES/RSM/RESUME. For RES/RSM/RESUME to operate, the vehicle speed must be faster than 48 km/h (30 mph).

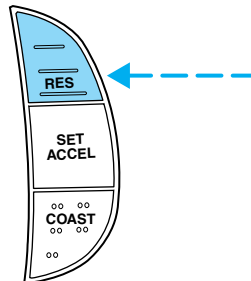



## Controls and features

### TILT STEERING WHEEL

Pull the tilt steering control toward you to move the steering wheel up or down. Hold the control while adjusting the wheel to the desired position, then release the control to lock the steering wheel in position.

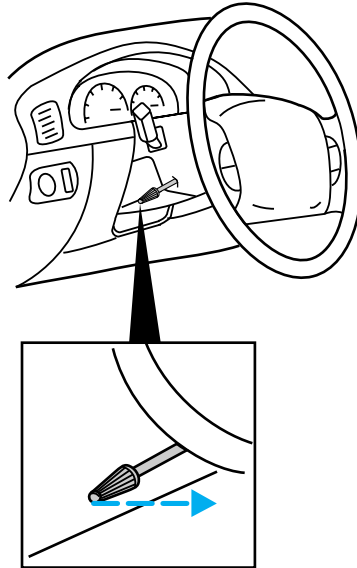

Never adjust the steering wheel when the vehicle is moving.

### HAZARD FLASHER

For information on the hazard flasher control, refer to *Hazard flasher* in the *Roadside emergencies* chapter.

### WINDSHIELD WIPER/WASHER CONTROLS

Rotate the windshield wiper control to the desired interval, low or high speed position.

The bars of varying length are for intermittent wipers. When in this position rotate the control upward for fast intervals and downward for slow intervals.

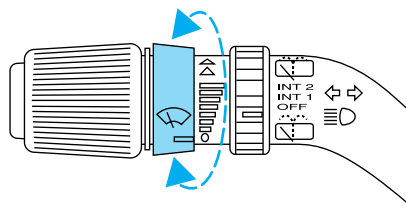

## Controls and features

Push (tap) the end of the stalk briefly for a single swipe (no wash). Push and hold for three swipes with wash. Push and hold for a longer wash (up to ten seconds).

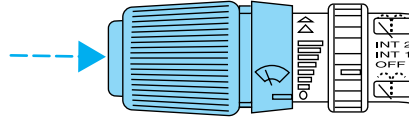

### Rear window wiper/washer controls

For rear wiper operation, rotate the rear window wiper and washer control to the desired position. Select:

INT 2 — One second interval rear wiper.

INT 1 — Ten second interval rear wiper.

OFF — Rear wiper and washer off.

For rear wash cycle, rotate (and hold as desired) the rear wiper/washer control to either  position.

From either position, the control will automatically return to the INT2 or OFF position.

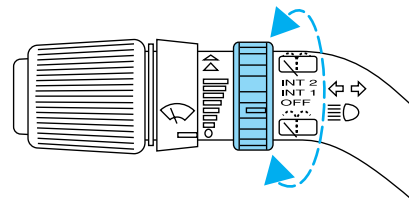

### Speed dependent wipers

When the windshield wiper control is set on the intermittent settings, speed-sensitive front wipers automatically adjust as the vehicle's speed changes.

### HIGH BEAMS

Push forward to activate.

Pull toward you to deactivate.

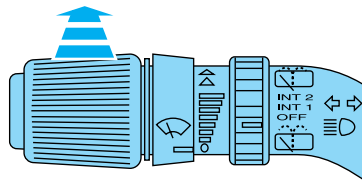

## Controls and features

### FLASH TO PASS

Pull toward you to activate and release to deactivate.

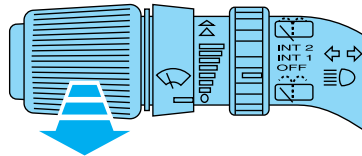

### OVERDRIVE CONTROL (IF EQUIPPED)

#### Activating overdrive

**D** (Overdrive) is the normal drive position for the best fuel economy. The overdrive function allows automatic upshifts and downshifts through all available gears.

#### Deactivating overdrive

Press the Transmission Control Switch (TCS) located on the end of the gearshift lever. The Transmission Control Indicator Light (TCIL) (the word OFF) will illuminate on the end of the gearshift lever.

The transmission will operate in all gears except overdrive. To return to normal overdrive mode, press the Transmission Control Switch again. The TCIL (the word OFF) will no longer be illuminated.

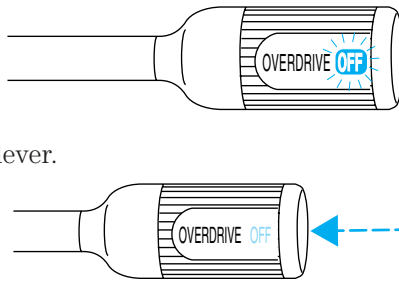

When you shut off and re-start your vehicle, the transmission will automatically return to normal **D** (Overdrive) mode.

For additional information about the gearshift lever and the transmission control switch operation refer to the *Automatic Transmission Operation* section of the *Driving* chapter.

## Controls and features

### POWER WINDOWS

Press and hold the rocker switches to open and close windows.

- Press the top portion of the rocker switch to close.

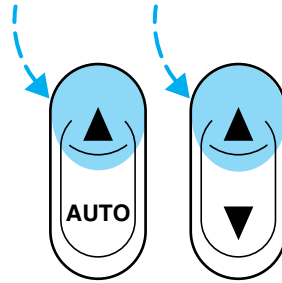

- Press the bottom portion of the rocker switch to open.

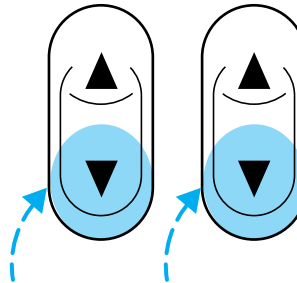

### One touch down

- Press AUTO completely down and release quickly. The driver's window will open fully. Depress again to stop window operation.

One touch down can be deactivated during operation by pushing up on the power window control.

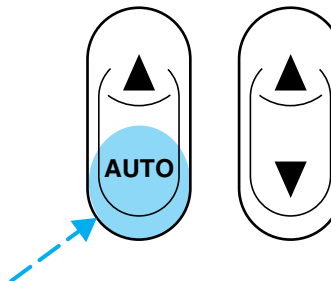

## Controls and features

### Window lock

The window lock feature allows only the driver to operate the power windows.

To lock out all the window controls except for the driver's press the left side of the control. Press the right side to restore the window controls.

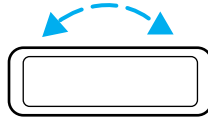

### Accessory delay (if equipped)

With accessory delay, the window switches may be used for up to ten minutes after the ignition switch is turned to the OFF position or until any door is opened.

### POWER DOOR LOCKS

Press U to unlock all doors and L to lock all doors.

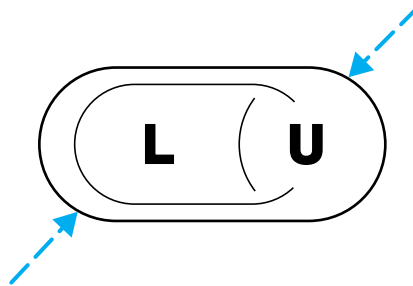

### CHILDPROOF DOOR LOCKS

When these locks are set, the rear doors cannot be opened from the inside. The rear doors can be opened from the outside when the doors are unlocked.

The childproof locks are located on rear edge of each rear door and must be set separately for each door. Setting the lock for one door will not automatically set the lock for both doors.

Move lock control up to engage the childproof lock. Move control down to disengage childproof locks.



## Controls and features

### POWER SIDE VIEW MIRRORS (IF EQUIPPED)

The ignition can be in any position to adjust the power side view mirrors.

To adjust your mirrors:

1. Select L to adjust the left mirror or R to adjust the right mirror.

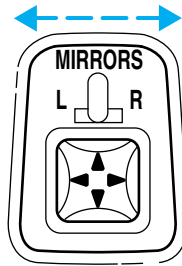

2. Move the control in the direction you wish to tilt the mirror.

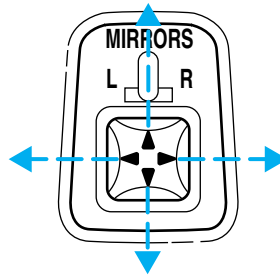

3. Return to the center position to lock mirrors in place.

## Controls and features

### Fold-away mirrors

Pull the side mirrors in carefully when driving through a narrow space, like an automatic car wash.

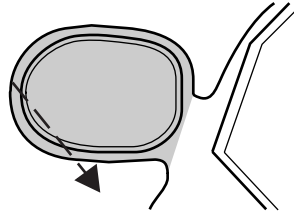

### Heated outside mirrors (if equipped)

Both mirrors are heated automatically to remove ice, mist and fog when the rear window defrost is activated.

Do not remove ice from the mirrors with a scraper or attempt to readjust the mirror glass if it is frozen in place. These actions could cause damage to the glass and mirrors.

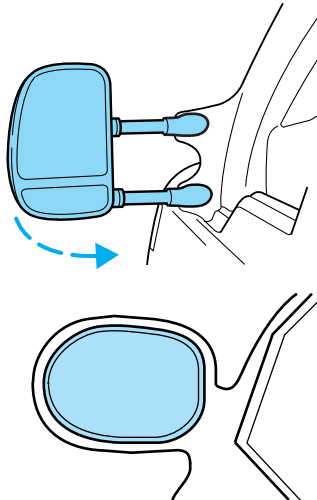

### OVERHEAD CONSOLE

The appearance of your vehicle's overhead console will vary according to your option package.

## Controls and features

### Forward storage bin (if equipped)

Press the release control to open the storage compartment. The door will open slightly and can be moved to full open.

The storage compartment may be used to secure sunglasses or a similar object.

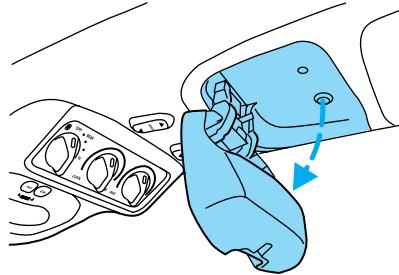

### Installing a garage door opener (if equipped)

The storage compartment can be converted to accommodate a variety of aftermarket garage door openers:

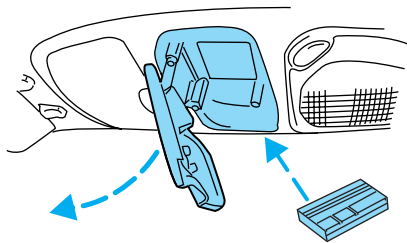

- Place Velcro<sup>®</sup> hook onto back side of aftermarket transmitter opposite of actuator control.
- Place transmitter into storage compartment, control down.
- Place the provided height adaptors onto the back of the storage bin door as needed.
- Press the storage compartment door to activate the transmitter.



## Controls and features

### Power quarter rear windows (if equipped)

Press the ▲ portion of the VENT control to open the power rear quarter windows.

Press the ▼ portion of the VENT control to close the power rear quarter windows.

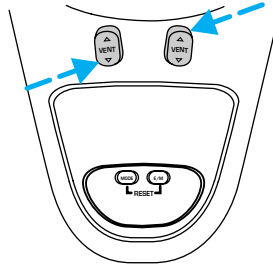

### Automatic dimming inside rear view mirror (if equipped)

Your vehicle is equipped with inside rear view mirror with an auto-dimming function. The electronic day/night mirror will change from the normal state to the non-glare state when bright lights (glare) reach the mirror. When the mirror detects bright light from front or behind, it will automatically adjust to minimize glare.

Press the control located on the bottom of the mirror to turn the mirror on or off. The mirror will automatically return to the normal state whenever the vehicle is placed in R (reverse) (when the mirror is on) to ensure a bright clear view when backing up.

Do not clean the housing or glass of any mirror with harsh abrasives, fuel or other petroleum-based cleaning products.

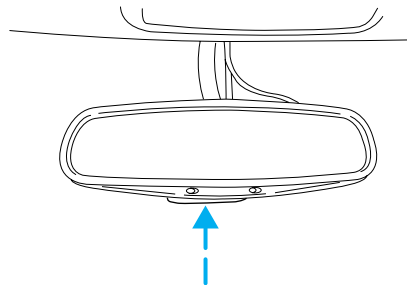

## Controls and features

### Illuminated visor mirror

To turn on the visor mirror lamps, lift the mirror cover.

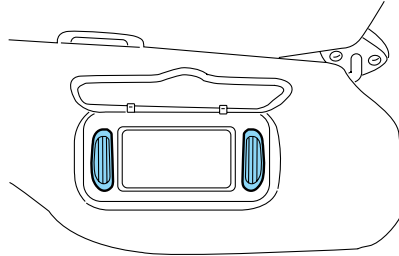

### TRIP COMPUTER (IF EQUIPPED)

The trip computer tells you about the condition of your vehicle through a constant monitor of vehicle systems. You may select display features on the trip computer for a display of status.

The appearance of your vehicle's trip computer may differ depending on your vehicle's option package, but the functions are the same.

The trip computer only operates with the ignition in the ON position. Trip computer features follow:

#### Selectable features

##### English/metric display

Press this control to change the trip computer display between metric and English units.

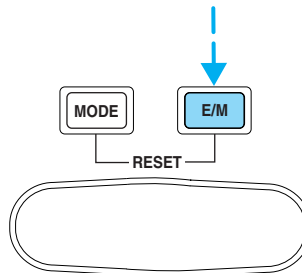

## Controls and features

### Mode control

Each press of the MODE control will display a different feature as follows:

**Average fuel economy.** The display will indicate the vehicle's average fuel economy in liters/100 km (or miles/gallon) since the average fuel economy was last reset.

If you calculate your average fuel economy by dividing liters of fuel used by 100 kilometers traveled (miles traveled by gallons used), your figure may be different than displayed for the following reasons:

- your vehicle was not perfectly level during fill-up
- differences in the automatic shut-off points on the fuel pumps at service stations
- variations in top-off procedure from one fill-up to another
- rounding of the displayed values to the nearest liter (gallon)

To reset the average fuel economy:

1. Press the MODE control repeatedly until average fuel economy is displayed (this is the only resettable display).

2. Press the E/M and MODE controls simultaneously. The display will illuminate the "AVG" indicator. While the indicator is lit, release both controls to reset the average fuel economy.

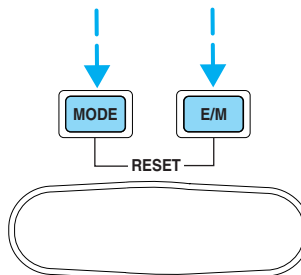
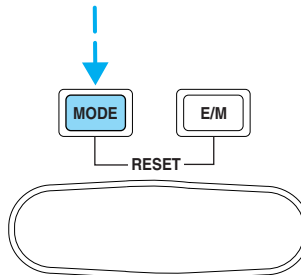

**Fuel range.** This displays the approximate number of kilometers (miles) left to drive before the fuel tank is empty. The indicated distance to empty may be inaccurate:

- with sustained, drastic changes in fuel economy (such as trailer towing), but will eventually recover.

## Controls and features

- if the vehicle is started while parked on an incline.
- if less than 30 liters (8 gallons) of fuel is added to the fuel tank.

The fuel range function will flash for five seconds at the following distances based on fuel remaining and fuel economy calculations:

- 80 km (50 miles)
- 40 km (25 miles)
- 16 km (10 miles)

### Outside air temperature

The temperature can be displayed in Centigrade or Fahrenheit by pressing the E/M control.

If the outside temperature falls below 3°C (38°F), the display will alternate from "ICE" to the outside temperature at a two second rate for one minute.

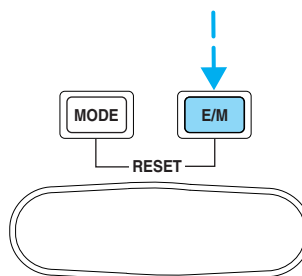

**Off.** In this mode the display is off.

### Compass

The compass display is contained in the overhead console. The vehicle heading is displayed as one of N, NE, E, SE, S, SW, W and NW.

The compass heading is displayed in average fuel economy modes, fuel range modes and temperature modes.

The compass reading may be affected when you drive near large buildings, bridges, power lines and powerful broadcast antenna. Magnetic or metallic objects placed in or on the vehicle may also affect compass accuracy. Adjustments may need to be made to the zone and calibration of the compass.

## Controls and features

### Compass zone adjustment

1. Determine which magnetic zone you are in for your geographic location by referring to the zone map.
2. Locate the trip computer on the overhead console.
3. Turn ignition to the ON position.

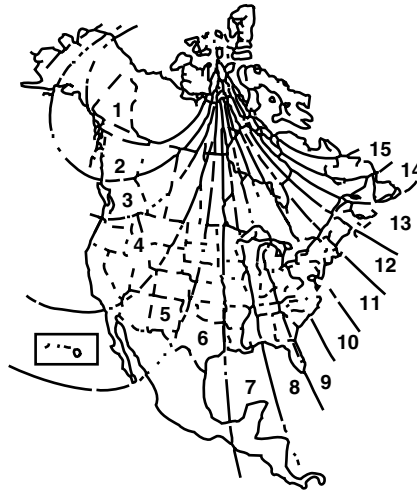

4. Press and hold both trip computer controls. After approximately four seconds, the trip computer will enter zone setting mode. Zone setting mode is indicated when the display lights the "ZONE" indicator.

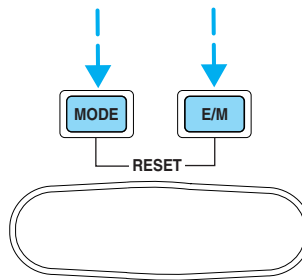

5. Release both controls. Subsequent pressing of either control will increment the zone. Press the control repeatedly until the correct zone setting for your geographic location is displayed on the trip computer.
6. To exit the zone setting mode and save the displayed zone in memory, release both controls for greater than five seconds.

## Controls and features

### Compass calibration adjustment

Perform this adjustment in an open area free from steel structures and high voltage lines.

For optimum calibration, turn off all electrical accessories (heater/air conditioning, wipers, etc.) and make sure all vehicle doors are shut.

1. Locate the trip computer located in the overhead console.
2. Start the vehicle.

3. Press and hold both trip computer controls. After approximately eight seconds, the trip computer will enter CAL mode. CAL mode is indicated when the display lights the "CAL" indicator.

4. Release both controls. The display will return to normal, except that the CAL indicator will remain lit until the compass is successfully calibrated.

5. Slowly drive the vehicle in a circle (less than 5 km/h [3 mph]) until the CAL indicator turns off. It may take up to five circles to complete calibration.

6. The compass is now calibrated.

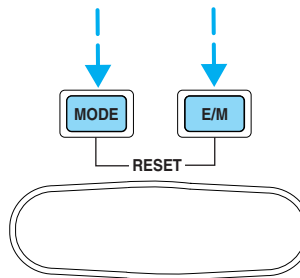

### INTERIOR LAMPS

#### Dome/Map lamps (if equipped)

The map lamps and controls are located on the dome lamp. Press the controls on either side of each map lamp to activate the lamps.

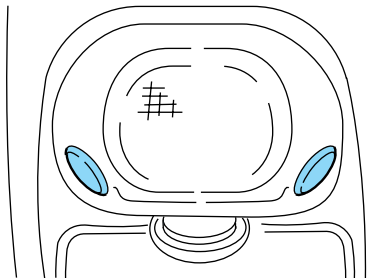

## Controls and features

### Rear courtesy/reading lamps

- Second row courtesy/reading lamp

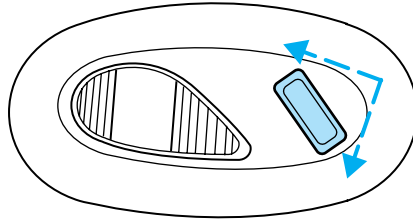

- Third row courtesy/reading lamp

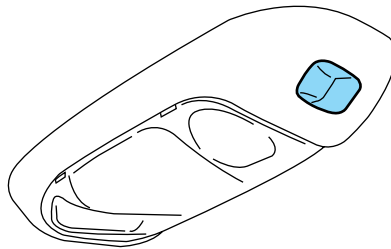

The courtesy lamps light when:

- any door is opened.
- the instrument panel dimmer switch is held up until the courtesy lamps come on.
- any of the remote entry controls are pressed and the ignition is OFF.

With the ignition key in the ACC or ON position, the reading lamps can be turned on by pressing the rocker control.

### Rear dome lamp

The dome lamp lights when:

- any door is opened.
- the instrument panel dimmer switch is held up until the courtesy lamps come on.
- any of the remote entry controls are pressed and the ignition is OFF.

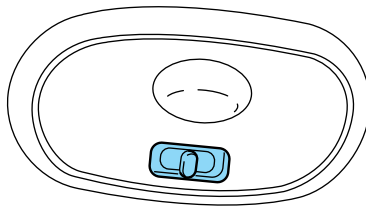

With the ignition key in the ACC or ON position, the rear dome lamp can be turned ON or OFF by sliding the control.

## Controls and features

### CENTER CONSOLE

Your vehicle may be equipped with a variety of console features. These include:

- Utility compartment
- Coin holder slots
- Pen holder
- Compact disc changer (if equipped)

 Use only soft cups in the cupholder. Hard objects can injure you in a collision.

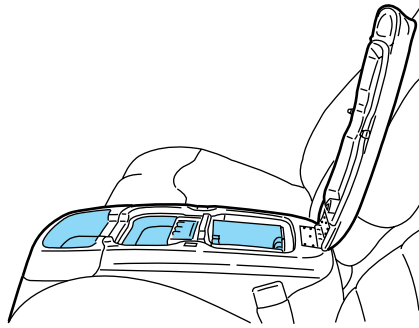

- Utility compartment
- Coin holder
- Pen holder
- Writing surface
- Space for lap-top computer

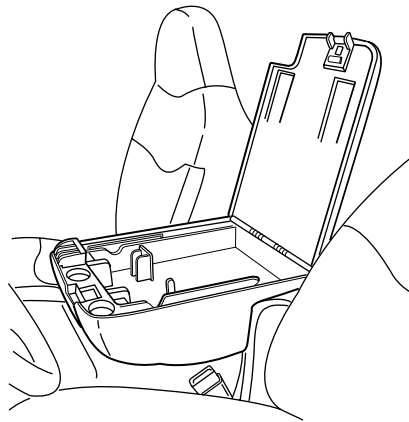

### REMOTE ENTRY SYSTEM

Your vehicle is equipped with a remote entry system which allows you to:

- unlock the vehicle doors without a key.
- lock all the vehicle doors without a key.
- activate the personal alarm.

The remote entry features only operate with the ignition in the OFF position.



## Controls and features

If there is any potential remote keyless entry problem with your vehicle, ensure **ALL key fobs** (remote entry transmitters) are brought to the dealership, to aid in troubleshooting.

### Unlocking the doors

Press this control to unlock the driver door. The interior lamps and running board lamps (if equipped) will illuminate.

Press the control a second time within three seconds to unlock all doors and liftgate.

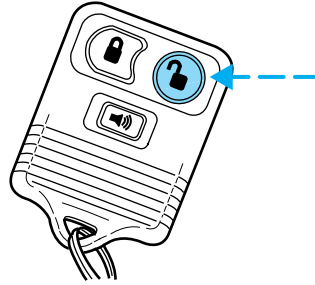

### Locking the doors

Press this control to lock all doors, liftgate or the driver's door.

To confirm doors are closed and locked, press this control a second time within three seconds. The door(s) will lock again, the horn will chirp once and the lamps will flash.

If any of the doors are open or ajar, the horn will make two quick chirps, reminding you to properly close the doors.

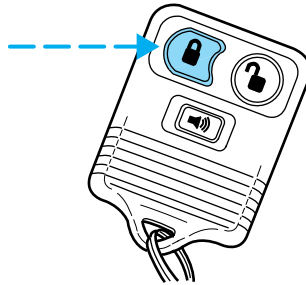

## Controls and features

### Sounding a panic alarm

Press this control to activate the alarm.

To deactivate the alarm, press the control again or turn the ignition to ACC or ON.

This device complies with part 15 of the FCC rules and with RS-210 of Industry Canada. Operation is subject to the following two conditions: (1) This device may not cause harmful interference, and (2) This device must accept any interference received, including interference that may cause undesired operation.

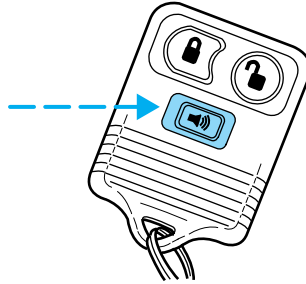

**Changes or modifications not expressly approved by the party responsible for compliance could void the user's authority to operate the equipment.**

### Replacing the battery

The remote transmitter is powered by one coin type three-volt lithium battery CR2032 or equivalent. Typical operating range will allow you to be up to 10 meters (33 feet) away from your vehicle. A decrease in operating range can be caused by:

- weather conditions
- nearby radio towers
- structures around the vehicle
- other vehicles parked next to the vehicle

## Controls and features

To replace the battery:

1. Twist a thin coin between the two halves of the transmitter near the key ring. **DO NOT TAKE THE FRONT PART OF THE TRANSMITTER APART.**

2. Place the positive (+) side of new battery in the same orientation. Refer to the diagram inside the transmitter unit.

3. Snap the two halves back together.

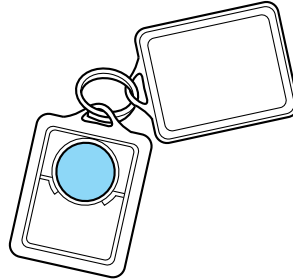

Replacement of the battery will **not** cause the remote transmitter to become deprogrammed from your vehicle. The remote transmitter should operate normally after battery replacement.

### Illuminated entry

The illuminated entry system will turn on the interior lights when the remote transmitter unlock control is pressed.

The illuminated entry system will turn off the interior lights if the ignition switch is turned to the ON position, or if the remote transmitter lock control is pressed, or after 25 seconds of illumination.

The inside lights will not turn off if:

- they have been turned on with the dimmer control or
- any door or liftgate is open.

The battery save feature will turn off the interior lights 45 minutes after the last door is closed, even if the dimmer control is on.

## Controls and features

### Replacing lost transmitters

If a remote transmitter has been lost and you would like to remove it from the vehicle's memory, or you would like to purchase additional remote transmitters and have them programmed to your vehicle:

- Take **all** your vehicle's transmitters to your dealer for programming, or
- Perform the programming procedure yourself

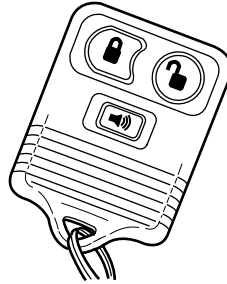

### Programming remote transmitters

It is necessary to have **all** (maximum of four — original and/or new) of your remote transmitters available prior to beginning this procedure.

To program the transmitters yourself:

- Insert a key in the ignition and turn from 3 (OFF) to 4 (ON) eight times in rapid succession (within 10 seconds) with the eighth turn ending in the 4 (ON) position. The doors will lock/unlock to confirm that programming mode has been entered.
- Within 20 seconds, program a remote transmitter by pressing any button on a transmitter. The doors will lock/unlock to confirm that the remote transmitter has been programmed. (If more than 20 seconds pass before pressing a remote transmitter button, the programming mode will exit and the procedure will have to be repeated.)
- Repeat the previous step to program additional remote transmitters. The doors will lock/unlock to confirm that each remote transmitter has been programmed.
- When you have completed programming the remote transmitters, turn the ignition to 3 (OFF) or wait 20 seconds. Again the doors will lock/unlock to confirm programming has been completed.

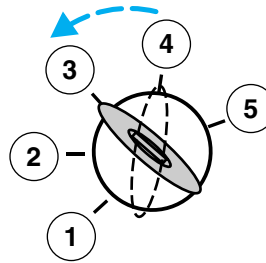

## Controls and features

### Keyless entry system

With the keyless entry keypad, you can:

- lock or unlock the vehicle doors without using the key.

Your vehicle has a factory set 5 digit code that operates the keyless entry system. You can also program your own 5 digit personal entry code. The factory-set code is located:

- on the owner's wallet card in the glove compartment

When pressing the controls on the keyless entry keypad, press the middle of the controls to ensure a good activation.

### Programming your own personal entry code

To program your own code:

1. Enter factory set code (keypad will illuminate when pressed).
2. Press 1/2 control within five seconds of step 1.

3. Enter your personal 5 digit code. Enter each digit within five seconds of previous one.

Do not set a code that includes five of the same number or presents them in sequential order. Thieves can easily figure out these types of codes.

Your personal code does not replace the permanent code that the dealership gave you. You can use either code to unlock your vehicle. If a second personal code is entered, the module will erase it in favor of the new code.

If you wish to erase your personal code, use the following instructions:

1. Enter factory set code.
2. Press 1/2 control within five seconds of step 1 and release.
3. Within five seconds of step 2, press and hold the 1/2 control for two seconds.

The system will now only respond to the factory set code.

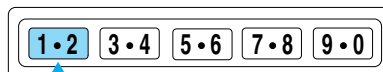
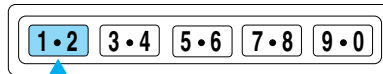

## Controls and features

### Unlocking the doors with the keyless entry system

To unlock the driver's door, enter either the factory-set code or personal code (each digit pressed within five seconds of the prior digit). The interior lamps will illuminate.

To unlock all doors, enter the factory-set code or personal code (driver door unlocks) and press the 3/4 control within five seconds.

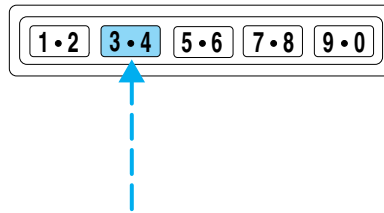

### Locking the doors with the keyless entry system

It is not necessary to first enter the factory or personal code prior to locking all doors. To lock all the doors:

- Press the 7/8 and the 9/0 control at the same time.

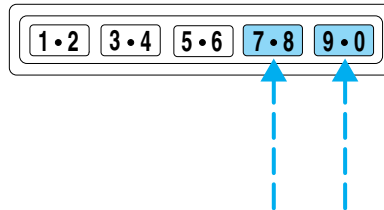

### SECURILOCK™ PASSIVE ANTI-THEFT SYSTEM

The SecuriLock™ passive anti-theft system provides an advanced level of vehicle theft protection. Your vehicle's engine can only be started with the two special SecuriLock™ electronically coded keys provided with your vehicle. Each time you start your vehicle, the SecuriLock™ key is read by the SecuriLock™ passive anti-theft system. If the SecuriLock™ key identification code matches the code stored in the SecuriLock™ anti-theft system, the vehicle's engine is allowed to start. If the SecuriLock™ key identification code does not match the code stored in the system or if a SecuriLock™ key is not detected (vehicle theft situation), the vehicle's engine will not operate.

If there is any potential SecuriLock™ anti-theft problem with your vehicle, ensure **ALL SecuriLock™ keys** for that vehicle are brought to the dealership, to aid in troubleshooting.

The SecuriLock™ passive anti-theft system is not compatible with aftermarket remote start systems. Use of these systems may result in

## Controls and features

vehicle starting problems and a loss of security protection. Large metallic objects, a second key or electronic devices used to purchase gasoline or similar items on the same key ring as the PATS ignition key may cause vehicle starting problems. If present, you need to keep these objects from touching the PATS ignition key while starting the engine. These objects cannot damage the PATS ignition key, but can cause a momentary problem if they are too close to the key during engine start. If a problem occurs, turn the ignition OFF and restart the engine with all other objects on the key ring held away from the ignition key. Check to make sure the encoded ignition key is an approved Ford encoded ignition key.

Spare SecuriLock™ keys can be purchased from your dealership and programmed to your SecuriLock™ passive anti-theft system. Refer to *Programming spare SecuriLock™ keys* for more information.

If one or both of your SecuriLock™ keys are lost or stolen and you want to ensure the lost or stolen key will not operate your vehicle, bring your vehicle and all available SecuriLock™ keys to your dealership for reinitialization.

### Theft indicator

The theft indicator on the instrument cluster will operate as follows:

- When the ignition is OFF, the theft indicator will flash briefly every two seconds to indicate the SecuriLock™ system is protecting your vehicle.
- When the ignition is turned to ON or START, the theft indicator will light for three seconds and then go out. If the theft indicator stays on for an extended period of time or flashes rapidly, have the system serviced by your dealership or a qualified technician.

### Programming spare SecuriLock™ keys

Spare SecuriLock™ keys can be purchased from your dealership and programmed to your SecuriLock™ passive anti-theft system (up to a total of eight keys). Your dealership can program your new SecuriLock™ key(s) to your vehicle or you can do it yourself using the following simple procedure. To program a new SecuriLock™ key yourself, you will need two previously programmed SecuriLock™ keys (keys that already operate your vehicle's engine). If two previously programmed SecuriLock™ keys are not available (one or both of your original keys were lost or stolen), you must bring your vehicle to your dealership to have the spare SecuriLock™ key(s) programmed.

## Controls and features

### Procedure to program spare SecuriLock™ keys to your vehicle

New SecuriLock™ keys must have the correct mechanical key cut for your vehicle.

Conventional (non-SecuriLock™) keys **cannot** be programmed to your vehicle.

You will need to have two previously programmed SecuriLock™ keys and the new unprogrammed SecuriLock™ key readily accessible for the procedure. Please read and understand the entire procedure before you begin.

1. Insert the first previously programmed SecuriLock™ key into the ignition and turn the ignition from OFF to ON (maintain ignition in ON for at least one second).
2. Turn ignition to OFF and remove the first SecuriLock™ key from the ignition.
3. Within five seconds of turning the ignition to OFF, insert the second previously programmed SecuriLock™ key into the ignition and turn the ignition from OFF to ON (maintain ignition in ON for at least one second but no more than five seconds).
4. Turn the ignition to OFF and remove the second SecuriLock™ key from the ignition.
5. Within 10 seconds of turning the ignition to OFF, insert the unprogrammed SecuriLock™ key (new key/valet key) into the ignition and turn the ignition from OFF to ON (maintain ignition in ON for at least one second). This step will program your new SecuriLock™ key.
6. To program additional SecuriLock™ key(s), repeat this procedure from step 1.

If the programming procedure was successful, the new SecuriLock™ key(s) will start the vehicle's engine. The theft indicator (located on the instrument cluster) will light for three seconds and then go out.

If the programming procedure was not successful, the new SecuriLock™ key(s) will not operate the vehicle's engine. The theft indicator will flash on and off. Wait at least one minute and then repeat the procedure from step 1. If failure repeats, bring your vehicle to your dealership to have the spare SecuriLock™ key(s) programmed.



## Controls and features

### CARGO NET (IF EQUIPPED)

The cargo net secures lightweight objects in the cargo area. Attach the net to the anchors provided. This net is not designed to restrain objects during a collision.

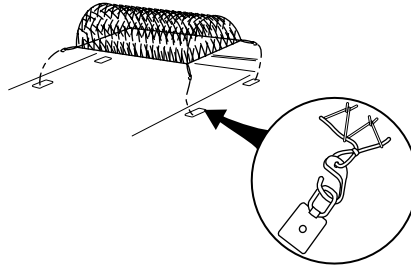

### TRIDOOR

The TriDoor area is intended for cargo storage only, not for passengers. You can open and close the TriDoors from outside the vehicle only. You cannot open the liftgate or cargo doors from inside the vehicle.

- To open the liftgate, unlock the liftgate (with the key, the key fob by pressing the UNLOCK button twice or power door locks) and pull up on the liftgate handle.
- To open the cargo doors, open the liftgate, then open right cargo door first, using the handle on top of the door, then open the left cargo door using the handle on the side of the door.
- To close and lock the liftgate and cargo doors, close the left cargo door first, then the right cargo door, then pull down and close the liftgate. Lock the TriDoor with the key, key fob or the power door lock button.

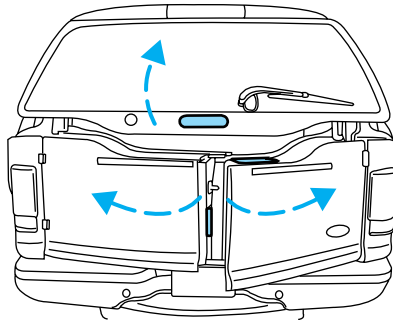

 The cargo doors and liftgate should be closed before driving your vehicle. Leaving the liftgate and/or the cargo doors open could cause serious damage to the TriDoors and its components as well as allowing carbon monoxide to enter the vehicle. If you must drive with the cargo doors and liftgate window open, keep the vents open so outside air comes into the vehicle.

## Seating and safety restraints

### SEATING

#### Full bench seat (if equipped)

- Lift the track release bar to move the seat forward or backward. Ensure that the seat is retracted into place.

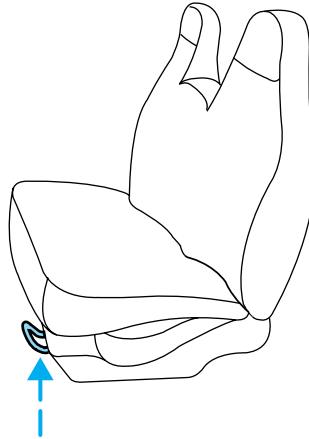

#### 60/40 split bench seat (if equipped)

- Lift the release bar to move the seat forward or backward. Ensure the seat is retracted into place.
- Pull the seatback handle up to recline the seat.

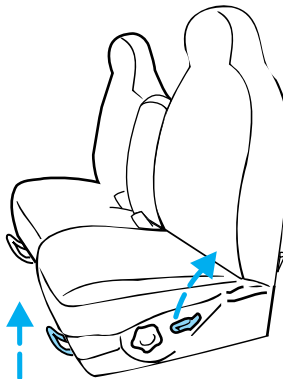

## Seating and safety restraints

### Captain's chair (if equipped)

- Lift the track release bar to move the seat forward or rearward. Make sure that the seat is re-latched into place.
- Pull the seatback handle up to recline the seat.

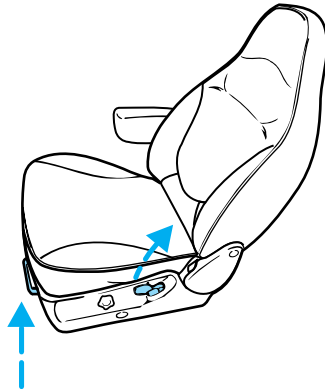

### Adjusting the front power seat (if equipped)



Never adjust the driver's seat or seatback when the vehicle is moving.



Do not pile cargo higher than the seatbacks to avoid injuring people in a collision or sudden stop.



Always drive and ride with your seatback upright and the lap belt snug and low across the hips.



Reclining the seatback can reduce the effectiveness of the seat's safety belt in the event of a collision.

The control is located on the outboard side of the seat cushion.

## Seating and safety restraints

Press front to raise or lower the front portion of the seat cushion.

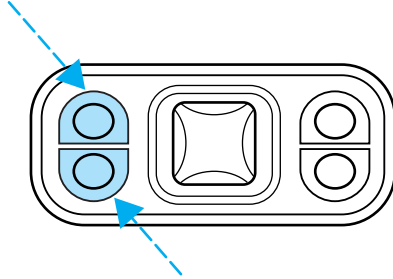

Press rear to raise or lower the rear portion of the seat cushion.

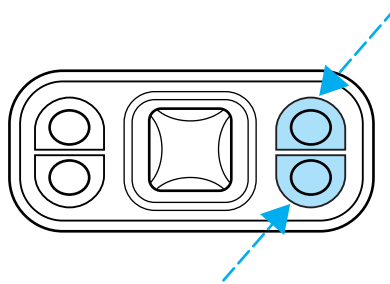

Press the control to move the seat forward, backward, up or down.

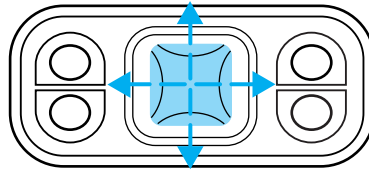

### Using the manual lumbar support

Turn the lumbar support control toward the front of vehicle to move the lumbar support forward for more direct support.

Turn the lumbar support control toward the rear of vehicle to move the lumbar support back for less direct support.

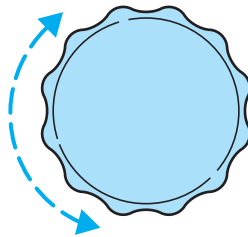

## Seating and safety restraints

### Heated seats (if equipped)

To operate the heated seats:

- Push control to activate.
- Push again to deactivate.

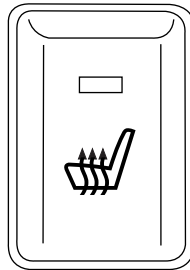

The indicator light will illuminate when activated.

### REAR SEATS

#### Head restraints (if equipped)

Your vehicle's seats may be equipped with head restraints which adjust up and down. The purpose of these head restraints is to help limit head motion in the event of a rear collision. To properly adjust your head restraints, lift the head restraint so that it is located directly behind your head or as close to that position as possible. Refer to the following to raise and lower the head restraints.

## Seating and safety restraints

The head restraints can be moved up and down.

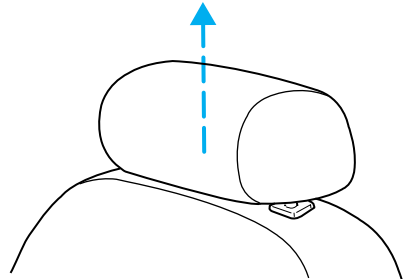

### Rear folding bench seat (if equipped)

#### ***Folding down rear seats into load floor***

Ensure that no objects such as books, purses or briefcases are on the floor in front of the second row seats before folding them down and insure the seat is fully latched rearward.

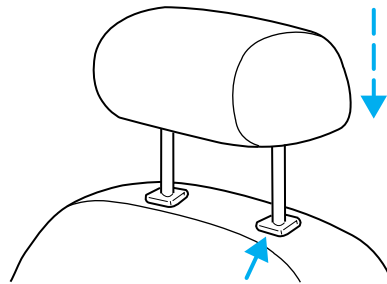

For assistance, refer to the label located on the seat side shield.

1. Lift strap to release seat cushion.

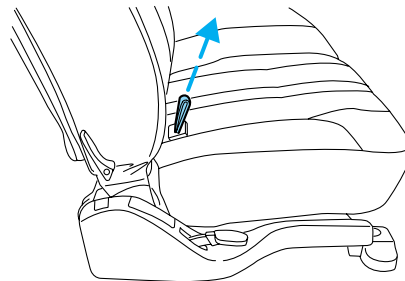

## Seating and safety restraints

2. Lift seat cushion up and rotate forward.

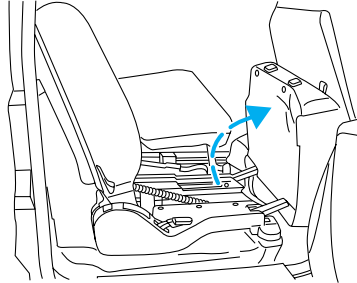

3. The headrest must be removed in order to fold the seatback down. Remove 2nd row seat headrest by pushing in both tabs while pulling up on headrest simultaneously.

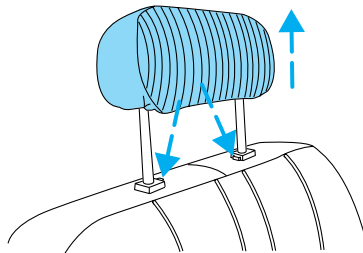

4. Stow headrest into the green caps found on the top of the seat cushion.

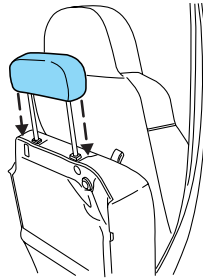

## Seating and safety restraints

5. Lift the lower seat control and flip the seatback down.

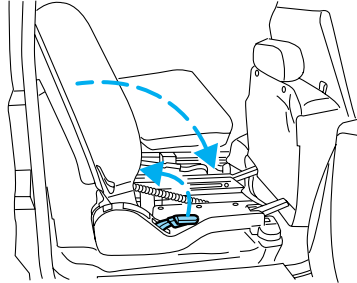

6. Lift up flap on seatback to release closeout panel.

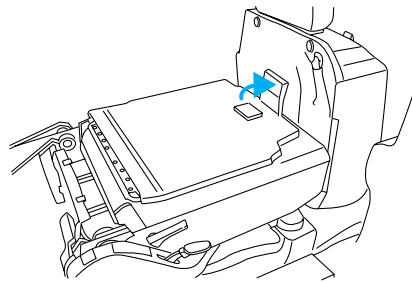

7. Rotate panel to closeout the space between the seatback and the floor.

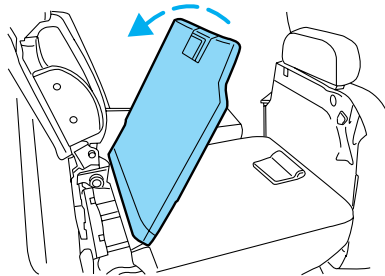

### ***Returning the seat to upright***



Insure the seat is pulled back to the locked position, whether the seat is occupied or empty. If not latched, the seat may cause injury during a sudden stop.

1. Rotate the closeout panel onto the seatback and secure with the retaining flap.



## Seating and safety restraints

2. Lift the lower seat control.
3. Pull up on the seatback while lifting the handle to lift the seatback into the upright position.

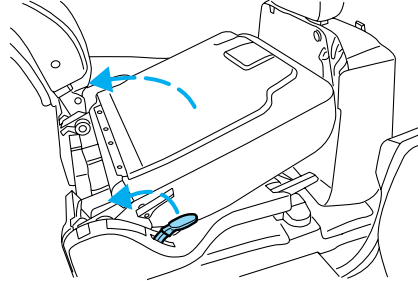

4. Remove headrest from storage position and return to 2nd row seatback. Push down headrest completely to secure.

### Reclining the seatback

Lift the control to adjust the seatback.

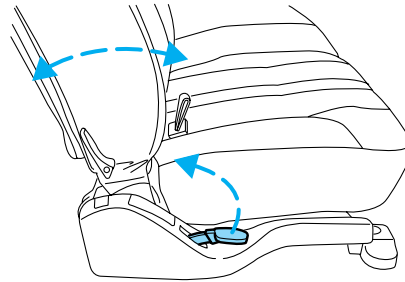

### THIRD ROW SEAT (IF EQUIPPED)

The third row seat is equipped with combination lap and shoulder belts in the outboard seating positions and a manual adjust tongue lap belt in the center seating position. For information on the proper operation of the safety restraints, refer to *Safety Restraints* in this chapter.

The third row seat may be removed from the vehicle for additional cargo space.

### ACCESSING THE THIRD ROW SEAT

Your vehicle is equipped with an easy entry second row seat feature which allows ready access to the third row seat. You may enter the third row seat through either rear side door.

## Seating and safety restraints

To reduce the risk of personal injury, the second row seat should not be left in the forward, E-Z entry position while the vehicle is in motion. Please ensure that the seat is in the upright, fully latched rearward position before putting the vehicle in motion. Refer to the warning label on the seat side shield.

1. Rotate the upper seat control rearward while pushing the seatback toward the front of the vehicle.

2. Push the seatback toward the front of the vehicle. This releases the seat track and the seat will move forward.

3. After entering the 3rd row seat, pull back the 2nd row seatback until it latches at full rearward position.

This will latch and lock the seatback and the seat track.

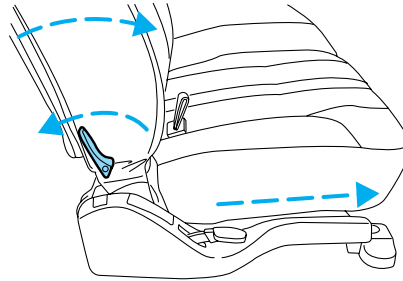

Insure the seat is pulled back to the locked position, whether the seat is occupied or empty. If not latched, the seat may cause injury during a sudden stop.

### FOLDING DOWN THE THIRD ROW SEAT

Pull the seat release lever located on the lower right side of the seatback while pushing the seatback down into the seat cushion. The seatback will latch into place.

Pull the seat release lever to return the seatback into the upright seating position.

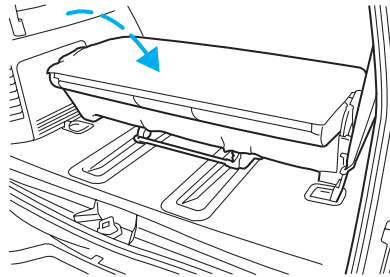

## Seating and safety restraints

### REMOVING THE THIRD ROW SEAT

From the rear of the vehicle, with the liftgate window and cargo doors open:

1. Pull the seat release lever located on the lower right side of the seatback while pushing the seatback down onto the seat cushion.

- The seatback will latch onto the cushion.

2. Lift the seat release bar located at the center of the seat near the floor to release the floor latches.

3. While pulling up on the release bar, lift the seat up and out of the floor tubs and roll seat rearward.

4. With assistance, lift the seat out of the vehicle.

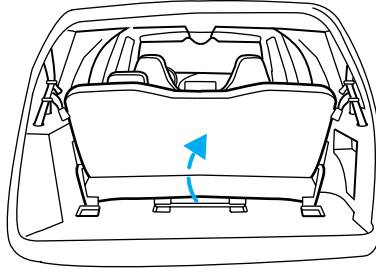

### INSTALLING THE THIRD ROW SEAT



Always latch the vehicle seat to the floor, whether the seat is occupied or empty. If not latched, the seat may cause injury during a sudden stop.



When reinstalling a rear seat in your vehicle it must be placed in its original position. Improper installation of the seat will prevent correct use of the safety belts and could increase the risk of injury. Refer to the warning label on the seat belt.

For proper latching, ensure that the floor tubs are clear of debris.

From the rear of the vehicle, with the liftgate open:

1. With assistance, lift the seat into the rear of the vehicle. Roll the seat forward and guide the front locators over the seat locator pins of the front floor tubs.

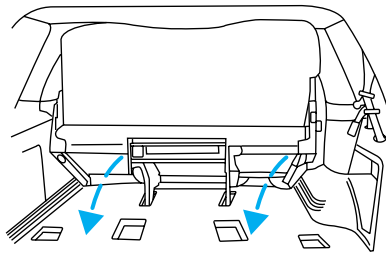

- When the rear of the seat is 10–13 cm (4–5 in) above the rear pins, let the seat drop. This will ensure that the seat will properly latch into the floor.

## Seating and safety restraints

2. Push up on the seat to verify that it is latched into the floor.
3. Verify that the safety belts can move freely on either side of the seat.

### SAFETY RESTRAINTS

#### Safety restraints precautions



Always drive and ride with your seatback upright and the lap belt snug and low across the hips.



To reduce the risk of injury, make sure children sit where they can be properly restrained.



Never let a passenger hold a child on his or her lap while the vehicle is moving. The passenger cannot protect the child from injury in a collision.



All occupants of the vehicle, including the driver, should always properly wear their safety belts, even when an air bag SRS is provided.



It is extremely dangerous to ride in a cargo area, inside or outside of a vehicle. In a collision, people riding in these areas are more likely to be seriously injured or killed. Do not allow people to ride in any area of your vehicle that is not equipped with seats and safety belts. Be sure everyone in your vehicle is in a seat and using a safety belt properly.



In a rollover crash, an unbelted person is significantly more likely to die than a person wearing a seat belt.



Each seating position in your vehicle has a specific safety belt assembly which is made up of one buckle and one tongue that are designed to be used as a pair. 1) Use the shoulder belt on the outside shoulder only. Never wear the shoulder belt under the arm. 2) Never swing the safety belt around your neck over the inside shoulder. 3) Never use a single belt for more than one person.

## Seating and safety restraints



Always transport children 12 years old and under in the back seat and always properly use appropriate child restraints.

### Combination lap and shoulder belts

1. Insert the belt tongue into the proper buckle (the buckle closest to the direction the tongue is coming from) until you hear a snap and feel it latch. Make sure the tongue is securely fastened in the buckle.

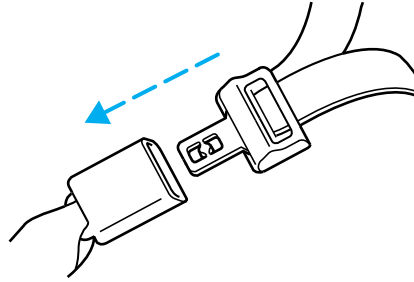

2. To unfasten, push the release button and remove the tongue from the buckle.

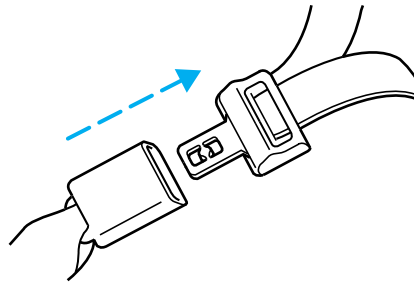

The front and rear outboard safety restraints in the vehicle are combination lap and shoulder belts. The front passenger and rear seat outboard safety belts have two types of locking modes described below:

### Vehicle sensitive mode

The vehicle sensitive mode is the normal retractor mode, allowing free shoulder belt length adjustment to your movements and locking in response to vehicle movement. For example, if the driver brakes suddenly or turns a corner sharply, or the vehicle receives an impact of approximately 8 km/h (5 mph) or more, the combination safety belts will lock to help reduce forward movement of the driver and passengers.

The seat belt system can also be made to lock manually by quickly pulling on the shoulder belt.

## Seating and safety restraints

### Automatic locking mode

In this mode, the shoulder belt is automatically pre-locked. The belt will still retract to remove any slack in the shoulder belt.

The automatic locking mode is not available on the driver safety belt.

### When to use the automatic locking mode

- **Anytime** a child safety seat is installed in a passenger front or outboard rear seating position (if equipped). Children 12 years old and under should be properly restrained in the rear seat whenever possible. Refer to *Safety Restraints for Children* or *Safety Seats for Children* later in this chapter.

### How to use the automatic locking mode

- Buckle the combination lap and shoulder belt.
- Grasp the shoulder portion and pull downward until the entire belt is extracted.

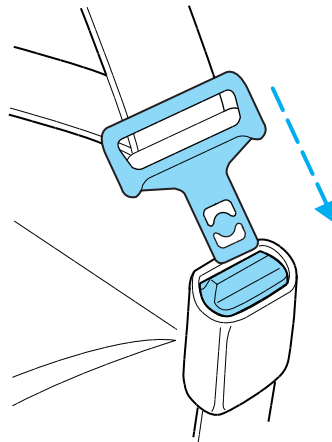

## Seating and safety restraints

- Allow the belt to retract. As the belt retracts, you will hear a clicking sound. This indicates the safety belt is now in the automatic locking mode.

### ***How to disengage the automatic locking mode***



Ford recommends that all safety belt assemblies and attaching hardware should be inspected by a qualified technician after any collision. Safety belt assemblies not in use during a collision should also be inspected and replaced if either damage or improper operation is noted.

Disconnect the combination lap/shoulder belt and allow it to retract completely to disengage the automatic locking mode and activate the vehicle sensitive (emergency) locking mode.

### **Energy Management Feature**

- This vehicle has a seat belt system with an energy management feature at the front outboard seating position to help further reduce the risk of injury in the event of a head-on collision.
- The front outboard seat belt system has a retractor assembly that is designed to pay out webbing in a controlled manner. This feature is designed to help reduce the belt force acting on the occupant's chest.



After any vehicle collision, the seat belt system at all outboard seating positions (except driver, which has no “automatic locking retractor” feature) must be checked by a qualified technician to verify that the “automatic locking retractor” feature for child seats is still functioning properly. In addition, all seat belts should be checked for proper function.



**BELT AND RETRACTOR ASSEMBLY MUST BE REPLACED** if the seat belt assembly “automatic locking retractor” feature or any other seat belt function is not operating properly when checked according to the procedures in Workshop Manual.



Failure to replace the Belt and Retractor assembly could increase the risk of injury in collisions.

## Seating and safety restraints

### Safety belt replacement label

The short plastic boot on the front safety belt at the passenger outboard anchor location covers a “Replace Belt” label on the safety belt.

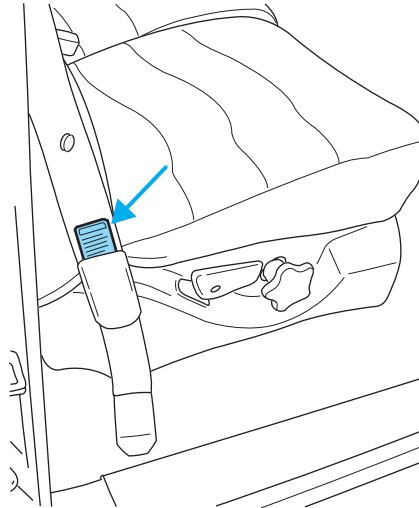

In the event of a collision, the colored label (REPLACE BELT) may become visible. If this occurs, *the safety belt must be replaced.*

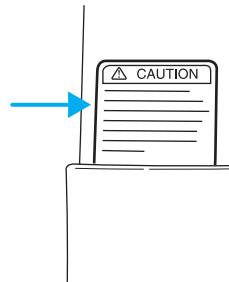

Whenever the yellow portion of the label is visible, the safety belt must be replaced.

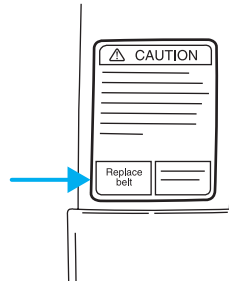



## Seating and safety restraints



Failure to follow these instructions will affect the performance of the safety belts and increase the risk of personal injury.

### Front and second row safety belt height adjustment

Your vehicle has safety belt height adjustments for the driver, front passenger and second row passengers. Adjust the height of the shoulder belt so the belt rests across the middle of your shoulder.

To lower the shoulder belt height, push the button down and slide the height adjuster down. To raise the height of the shoulder belt, slide the height adjuster up. Pull down on the height adjuster to make sure it is locked in place.

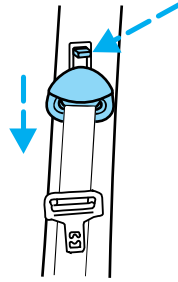

Position the shoulder belt height adjusters so that the belt rests across the middle of your shoulder. Failure to adjust the safety belt properly could reduce the effectiveness of the seat belt and increase the risk of injury in a collision.

### Lap belts

#### *Adjusting the lap belt*



The lap belt should fit snugly and as low as possible around the hips, not around the waist.

#### • 1st row and 3rd row (if equipped) center seating positions

The lap belt does not adjust automatically.

## Seating and safety restraints

Insert the tongue into the correct buckle (the buckle closest to the direction the tongue is coming from). To lengthen the belt, turn the tongue at a right angle to the belt and pull across your lap until it reaches the buckle. To tighten the belt, pull the loose end of the belt through the tongue until it fits snugly across the hips.

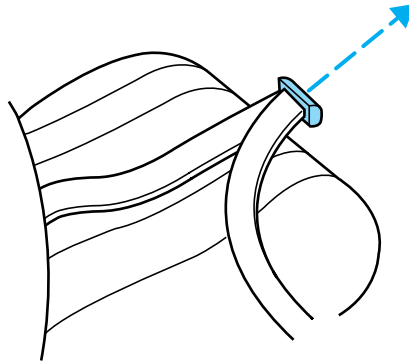

Shorten and fasten the belt when not in use.

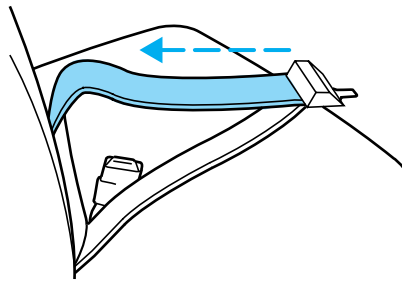

### • 2nd row center seating position (if equipped)

The lap belt will adjust automatically. To fasten, grasp the tongue, and with a continuous motion, pull out enough webbing to buckle the tongue into the correct buckle. If you did not pull out enough webbing to reach the buckle, allow the tongue to retract fully before trying to pull it out again.

### Safety belt extension assembly

If the safety belt assembly is too short, even when fully extended, 20 cm (8 inches) can be added to the safety belt assembly by adding a safety belt extension assembly (part number 611C22). Safety belt extension assemblies can be obtained from your dealer at no cost.

Use only extensions manufactured by the same supplier as the safety belt. Manufacturer identification is located at the end of the webbing on the label. Also, use the safety belt extension only if the safety belt is too short for you when fully extended. Do not use extensions to change the fit of the shoulder belt across the torso.

## Seating and safety restraints

### Safety belt warning light and indicator chime

The seat belt warning light illuminates in the instrument cluster and a chime sounds to remind the occupants to fasten their safety belts.

#### Conditions of operation

If...	Then...
The driver's safety belt is not buckled before the ignition switch is turned to the ON position...	The safety belt warning light illuminates 1-2 minutes and the warning chime sounds 4-8 seconds.
The driver's safety belt is buckled while the indicator light is illuminated and the warning chime is sounding...	The safety belt warning light and warning chime turn off.
The driver's safety belt is buckled before the ignition switch is turned to the ON position...	The safety belt warning light and indicator chime remain off.

#### Belt minder (if equipped)

The Belt Minder feature is a supplemental warning to the safety belt warning function. This feature provides additional reminders to the driver that the driver's safety belt is unbuckled by intermittently sounding a chime and illuminating the safety belt warning lamp in the instrument cluster.

If...	Then...
The driver's safety belt is not buckled before the vehicle has reached at least 5 km/h (3 mph) and 1-2 minutes have elapsed since the ignition switch has been turned to ON...	The Belt Minder feature is activated - the safety belt warning light illuminates and the warning chime sounds for 6 seconds every 30 seconds, repeating for approximately 5 minutes or until safety belt is buckled.
The driver's safety belt is buckled while the safety belt indicator light is illuminated and the safety belt warning chime is sounding...	The Belt Minder feature will not activate.
The driver's safety belt is buckled before the ignition switch is turned to the ON position...	The Belt Minder feature will not activate.

## Seating and safety restraints

The purpose of the Belt Minder is to remind occasional wearers to wear safety belts all of the time.

The following are reasons most often given for not wearing safety belts:  
(All statistics based on U.S. data)

Reasons given...	Consider...
"Crashes are rare events"	<b>36 700 crashes occur every day.</b> The more we drive, the more we are exposed to "rare" events, even for good drivers. <i>1 in 4 of us will be seriously injured in a crash during our lifetime.</i>
"I'm not going far"	<b>3 of 4</b> fatal crashes occur within <b>25</b> miles of home.
"Belts are uncomfortable"	Ford designs its safety belts to enhance comfort. If you are uncomfortable - try different positions for the safety belt upper anchorage and seatback which should be as upright as possible; this can improve comfort.
"I was in a hurry"	<b>Prime time for an accident.</b> Belt Minder reminds us to take a few seconds to buckle up.
"Seat belts don't work"	<b>Safety belts</b> , when used properly, <b>reduce risk of death</b> to front seat occupants by <b>45% in cars</b> , and by <b>60% in light trucks</b> .
"Traffic is light"	<b>Nearly 1 of 2 deaths occur in single-vehicle crashes</b> , many when no other vehicles are around.
"Belts wrinkle my clothes"	Possibly, but a serious crash can do much more than wrinkle your clothes, particularly if you are unbelted.
"The people I'm with don't wear belts"	Set the example, teen deaths occur 4 times more often in vehicles with TWO or MORE people. Children and younger brothers/sisters imitate behavior they see.
"I have an air bag"	Air bags offer greater protection when used with safety belts. Frontal airbags are not designed to inflate in rear and side crashes or rollovers.
"I'd rather be thrown clear"	Not a good idea. <b>People</b> who are <b>ejected are 40 times more likely to DIE</b> . Safety belts help prevent ejection, WE CAN'T "PICK OUR CRASH".

## Seating and safety restraints



Do not sit on top a buckled safety belt to avoid the Belt Minder chime. Sitting on the safety belt will increase the risk of injury in an accident. To disable (one-time) or deactivate the Belt Minder feature please follow the directions stated below.

### **One time disable**

Anytime the safety belt is buckled and then unbuckled during an ignition ON cycle, Belt Minder will be disabled for that ignition cycle only.

### **Deactivating/activating the belt minder feature**

*Read steps 1 - 9 thoroughly before proceeding with the deactivation/activation programming procedure.*

The Belt Minder feature can be deactivated/activated by performing the following procedure:

Before following the procedure, make sure that:

- the parking brake is set
- the gearshift is in P (Park) (automatic transmission).
- the ignition switch is in the OFF position
- all vehicle doors are closed
- the driver's safety belt is unbuckled
- the parklamps/headlamps are in OFF position (If vehicle is equipped with Autolamps, this will not affect the procedure.)



To reduce the risk of injury, do not deactivate/activate the Belt Minder feature while driving the vehicle.

1. Turn the ignition switch to the RUN (or ON) position. (DO NOT START THE ENGINE)
2. Wait until the safety belt warning light turns off. (Approximately 1–2 minutes)
  - Steps 3–5 must be completed within 60 seconds or the procedure will have to be repeated.
3. Buckle then unbuckle the safety belt three times, ending with the safety belt unbuckled. This can be done before or during Belt Minder warning activation.
4. Turn on the parklamps/headlamps, turn off the parklamps/headlamps.

## Seating and safety restraints

5. Buckle then unbuckle the safety belt three times, ending with the safety belt unbuckled.
  - After step 5 the safety belt warning light will be turned on for three seconds.
6. Within seven seconds of the safety belt warning light turning off, buckle then unbuckle the safety belt.
  - This will disable Belt Minder if it is currently enabled, or enable Belt Minder if it is currently disabled.
7. Confirmation of disabling Belt Minder is provided by flashing the safety belt warning light four times per second for three seconds.
8. Confirmation of enabling Belt Minder is provided by flashing the safety belt warning light four times per second for three seconds, followed by three seconds with the safety belt warning light off, then followed by flashing the safety belt warning light four times per second for three seconds again.
9. After receiving confirmation, the deactivation/activation procedure is complete.

### Safety belt maintenance

Inspect the safety belt systems periodically to make sure they work properly and are not damaged. Inspect the safety belts to make sure there are no nicks, wears or cuts, replacing if necessary. All safety belt assemblies, including retractors, buckles, front seat belt buckle assemblies, buckle support assemblies (slide bar-if equipped), shoulder belt height adjusters (if equipped), shoulder belt guide on seatback (if equipped), child safety seat tether bracket assemblies (if equipped), and attaching hardware, should be inspected after a collision. Ford recommends that all safety belt assemblies used in vehicles involved in a collision be replaced. However, if the collision was minor and a qualified technician finds that the belts do not show damage and continue to operate properly, they do not need to be replaced. Safety belt assemblies not in use during a collision should also be inspected and replaced if either damage or improper operation is noted.



Failure to inspect and if necessary replace the safety belt assembly under the above conditions could result in severe personal injuries in the event of a collision.

## Seating and safety restraints

Refer to *Cleaning and maintaining the safety belts* in the *Maintenance and care* section.

### AIR BAG SUPPLEMENTAL RESTRAINT SYSTEM (SRS)

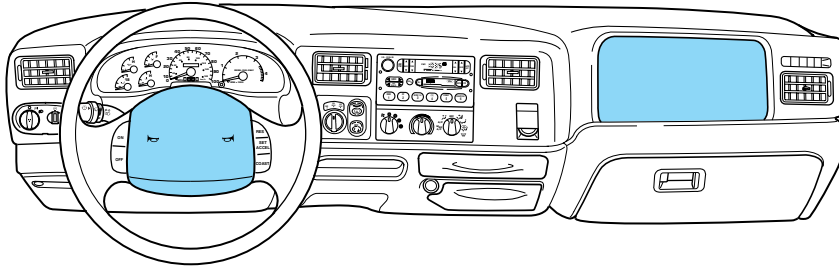

Your vehicle is equipped with a crash sensing and diagnostic module which records information about the air bag and sensor systems. In the event of a collision this module may save information related to the collision including information about the air bag system and impact severity. This information will assist Ford in the servicing of your vehicle and may help Ford better understand real world collisions and further improve the safety of future vehicles.

### Important supplemental restraint system (SRS) precautions

The supplemental restraint system is designed to work with the safety belt to help protect the driver and right front passenger from certain upper body injuries.

Air bags DO NOT inflate slowly or gently and the risk of injury from a deploying air bag is greatest close to the trim covering the air bag module.

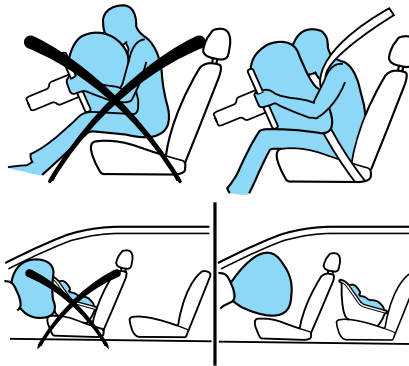

## Seating and safety restraints



All occupants of the vehicle, including the driver, should always properly wear their safety belts, even when an air bag SRS is provided.



Always transport children 12 years old and under in the back seat and always properly use appropriate child restraints.



National Highway Traffic Safety Administration (NHTSA) recommends a minimum distance of at least 25 cm (10 inches) between an occupant's chest and the driver air bag module.



Never place your arm over the air bag module as a deploying air bag can result in serious arm fractures or other injuries.

Steps you can take to properly position yourself away from the air bag:

- Move your seat to the rear as far as you can while still reaching the pedals comfortably.
- Recline the seat slightly (one or two degrees) from the upright position.



Do not put anything on or over the air bag module. Placing objects on or over the air bag inflation area may cause those objects to be propelled by the air bag into your face and torso causing serious injury.



Do not attempt to service, repair, or modify the Air Bag Supplemental Restraint System or its fuses. See your Ford or Lincoln-Mercury dealer.



## Seating and safety restraints

### Children and air bags

For additional important safety information, read all information on safety restraints in this guide.

Children must always be properly restrained. Accident statistics suggest that children are safer when properly restrained in the rear seating positions than in the front seating position. Failure to follow these instructions may increase the risk of injury in a collision.



Air bags can kill or injure a child in a child seat.

**NEVER** place a rear-facing child seat in front of an active air bag. If you must use a forward-facing child seat in the front seat, move the seat all the way back.

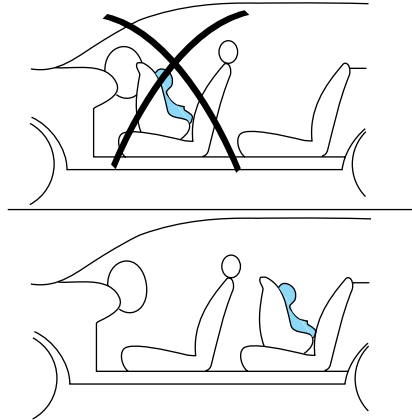

### How does the air bag supplemental restraint system work?

The air bag SRS is designed to activate when the vehicle sustains longitudinal deceleration sufficient to cause the sensors to close an electrical circuit that initiates air bag inflation.

The fact that the air bags did not inflate in a collision does not mean that something is wrong with the system. Rather, it means the forces were not of the type sufficient to cause activation.

Air bags are designed to inflate in frontal and near-frontal collisions, not rollover, side-impact, or rear-impacts unless the collision causes sufficient longitudinal deceleration.

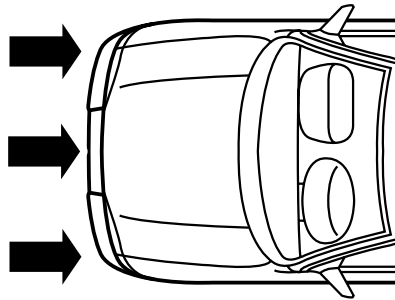

## Seating and safety restraints

The air bags inflate and deflate rapidly upon activation. After air bag deployment, it is normal to notice a smoke-like, powdery residue or smell the burnt propellant. This may consist of cornstarch, talcum powder (to lubricate the bag) or sodium compounds (e.g., baking soda) that result from the combustion process that inflates the air bag. Small amounts of sodium hydroxide may be present which may irritate the skin and eyes, but none of the residue is toxic.



While the system is designed to help reduce serious injuries, contact with a deploying air bag may also cause abrasions, swelling or temporary hearing loss. Because air bags must inflate rapidly and with considerable force, there is the risk of death or serious injuries such as fractures, facial and eye injuries or internal injuries, particularly to occupants who are not properly restrained or are otherwise out of position at the time of air bag deployment. Thus, it is extremely important that occupants be properly restrained as far away from the air bag module as possible while maintaining vehicle control.



Several air bag system components get hot after inflation. Do not touch them after inflation.



If the air bag is deployed, **the air bag will not function again and must be replaced immediately.** If the air bag is not replaced, the unrepaired area will increase the risk of injury in a collision.

The SRS consists of:

- driver and passenger air bag modules (which include the inflators and air bags),
- one or more impact and safing sensors,
- a readiness light and tone
- diagnostic module

## Seating and safety restraints

- and the electrical wiring which connects the components.

The diagnostic module monitors its own internal circuits and the supplemental air bag electrical system warning (including the impact sensors), the system wiring, the air bag system readiness light, the air bag back up power and the air bag ignitors.

### Determining if the system is operational

The SRS uses a readiness light in the instrument cluster or a tone to indicate the condition of the system. Refer to the *Air bag readiness* section in the *Instrumentation* chapter. Routine maintenance of the air bag is not required.

A difficulty with the system is indicated by one or more of the following:

- The readiness light will either flash or stay lit.
- The readiness light will not illuminate immediately after ignition is turned on.
- A series of five beeps will be heard. The tone pattern will repeat periodically until the problem and light are repaired.



If any of these things happen, even intermittently, have the SRS serviced at your dealership or by a qualified technician immediately. Unless serviced, the system may not function properly in the event of a collision.

### Disposal of air bags and air bag equipped vehicles (including pretensioners)

For disposal of air bags or air bag equipped vehicles, see your local dealership or qualified technician. Air bags MUST BE disposed of by qualified personnel.

### SAFETY RESTRAINTS FOR CHILDREN

See the following sections for directions on how to properly use safety restraints for children. Also see *Air Bag Supplemental Restraint System (SRS)* in this chapter for special instructions about using air bags.

## Seating and safety restraints

### Important child restraint precautions

You are required by law to use safety restraints for children in the U.S. and Canada. If small children ride in your vehicle (generally children who are four years old or younger and who weigh 18 kg [40 lbs] or less), you must put them in safety seats made especially for children. Check your local and state or provincial laws for specific requirements regarding the safety of children in your vehicle.



Never let a passenger hold a child on his or her lap while the vehicle is moving. The passenger cannot protect the child from injury in a collision.

Always follow the instructions and warnings that come with any infant or child restraint you might use.

When possible, always place children under age 12 in the rear seat of your vehicle. Accident statistics suggest that children are safer when properly restrained in the rear seating positions than in the front seating position.

### Children and safety belts

If the child is the proper size, restrain the child in a safety seat.

Children who are too large for child safety seats (as specified by your child safety seat manufacturer) should always wear safety belts.

Follow all the important safety restraint and air bag precautions that apply to adult passengers in your vehicle.

If the shoulder belt portion of a combination lap and shoulder belt can be positioned so it does not cross or rest in front of the child's face or neck, the child should wear the lap and shoulder belt. Moving the child closer to the center of the vehicle may help provide a good shoulder belt fit.



Do not leave children, unreliable adults, or pets unattended in your vehicle.

To improve the fit of lap and shoulder belts on children who have outgrown child safety seats, Ford recommends use of a belt-positioning booster seat that is labelled as conforming to all Federal motor vehicle safety standards. Belt-positioning booster seats raise the child and provide a shorter, firmer seating cushion that encourages safer seating posture and better fit of lap and shoulder belts on the child.

## Seating and safety restraints

A belt-positioning booster should be used if the shoulder belt rests in front of the child's face or neck, or if the lap belt does not fit snugly on both thighs, or if the thighs are too short to let the child sit all the way back on the seat cushion when the lower legs hang over the edge of the seat cushion. You may wish to discuss the special needs of your child with your pediatrician.

### SAFETY SEATS FOR CHILDREN



#### Child and infant or child safety seats

Use a safety seat that is recommended for the size and weight of the child. Carefully follow all of the manufacturer's instructions with the safety seat you put in your vehicle. If you do not install and use the safety seat properly, the child may be injured in a sudden stop or collision.

When installing a child safety seat:

- Review and follow the information presented in the *Air Bag Supplemental Restraint System* section in this chapter.
- Use the correct safety belt buckle for that seating position (the buckle closest to the direction the tongue is coming from).
- Insert the belt tongue into the proper buckle until you hear a snap and feel it latch. Make sure the tongue is securely fastened in the buckle.

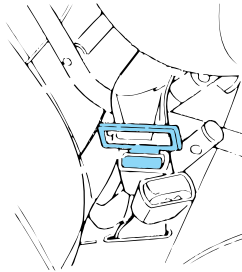

## Seating and safety restraints

- Keep the buckle release button pointing up and away from the safety seat, with the tongue between the child seat and the release button, to prevent accidental unbuckling.
- Place seat back in upright position.
- Put the safety belt in the automatic locking mode. Refer to *Automatic locking mode* (passenger side front and outboard rear seating positions) (if equipped).

Ford recommends the use of a child safety seat having a top tether strap. Install the child safety seat in a seating position which is capable of providing a tether anchorage. For more information on top tether straps, refer to *Attaching safety seats with tether straps*.



Carefully follow all of the manufacturer's instructions included with the safety seat you put in your vehicle. If you do not install and use the safety seat properly, the child may be injured in a sudden stop or collision.

### Installing child safety seats in combination lap and shoulder belt seating positions



Air bags can kill or injure a child in a child seat. **NEVER** place a rear-facing child seat in front of an active air bag. If you must use a forward-facing child seat in the front seat, move the seat all the way back.

1. Position the child safety seat in a seat with a combination lap and shoulder belt.

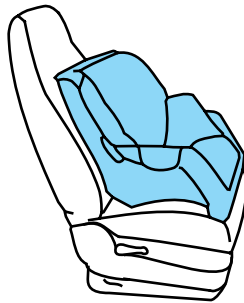

## Seating and safety restraints



Children 12 and under should be properly restrained in the rear seat whenever possible.

2. Pull down on the shoulder belt and then grasp the shoulder belt and lap belt together.

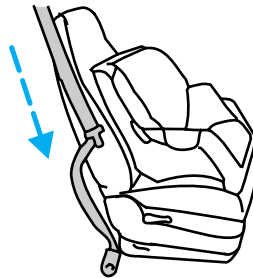

3. While holding the shoulder and lap belt portions together, route the tongue through the child seat according to the child seat manufacturer's instructions. Be sure the belt webbing is not twisted.

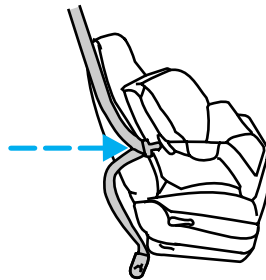

4. Insert the belt tongue into the proper buckle (the buckle closest to the direction the tongue is coming from) for that seating position until you hear a snap and feel the latch engage. Make sure the tongue is latched securely by pulling on it.

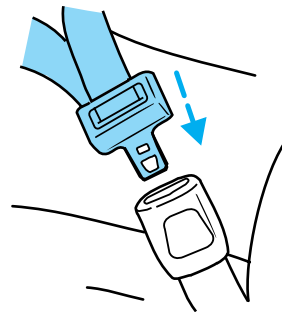

## Seating and safety restraints

5. To put the retractor in the automatic locking mode, grasp the shoulder portion of the belt and pull downward until all of the belt is extracted and a click is heard.

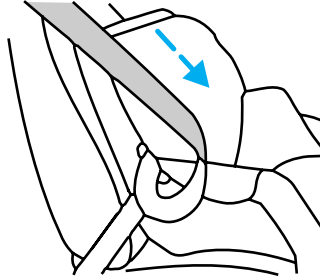

6. Allow the belt to retract. The belt will click as it retracts to indicate it is in the automatic locking mode.

7. Pull the lap belt portion across the child seat toward the buckle and pull up on the shoulder belt while pushing down with your knee on the child seat.

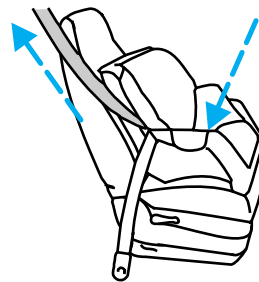

8. Allow the safety belt to retract to remove any slack in the belt.

9. Before placing the child in the seat, forcibly tilt the seat forward and back to make sure the seat is securely held in place.

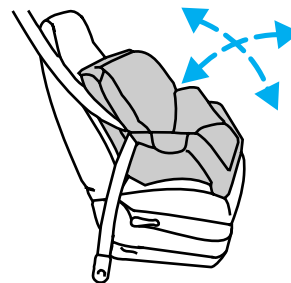

10. Try to pull the belt out of the retractor to make sure the retractor is in the automatic locking mode (you should not be able to pull more belt out). If the retractor is not locked, unbuckle the belt and repeat steps two through nine.

Check to make sure the child seat is properly secured before each use.



## Seating and safety restraints

### Attaching child safety seats with tether straps

Most new forward-facing child safety seats include a tether strap which goes over the back of the seat and hooks to an anchoring point. Tether straps are available as an accessory for many older safety seats. Contact the manufacturer of your child seat for information about ordering a tether strap.

The rear seats of your vehicle are equipped with built-in tether strap anchors located behind the seats as described below.

The tether anchors in your vehicle are either located under a cover marked with the tether anchor symbol (shown with title) or are recessed bars on the back side of the seatback.

The tether strap anchors in your vehicle are in the following positions (shown from top view):



Attach the tether strap only to the appropriate tether anchor as shown. The tether strap may not work properly if attached somewhere other than the correct tether anchor.

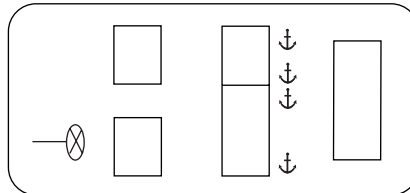

1. Position the child safety seat on the passenger seat cushion.
2. Route the child safety seat tether strap over the back of the seat.

For vehicles with adjustable head restraints, route the tether strap under the head restraint and between the head restraint posts, otherwise route the tether strap over the top of the seatback.

## Seating and safety restraints

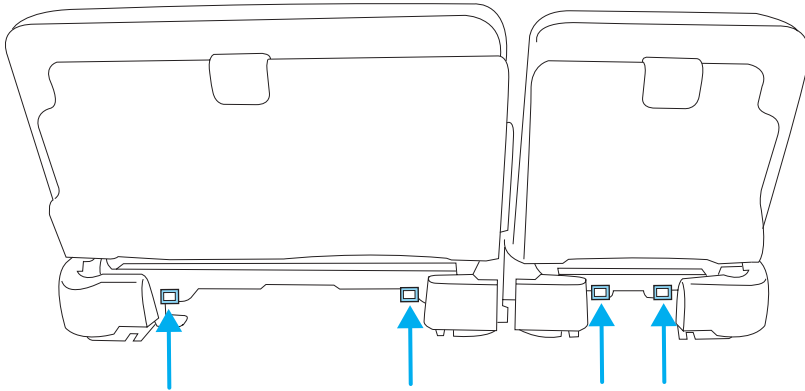

3. Locate the correct anchor for the selected seating position.

- The anchors are located under the seat frame.

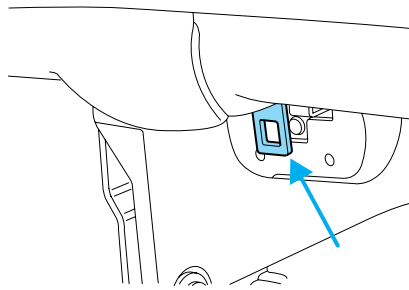

4. Clip the tether strap to the anchor as shown.

 If the tether strap is clipped incorrectly, the child safety seat may not be retained properly in the event of a collision.

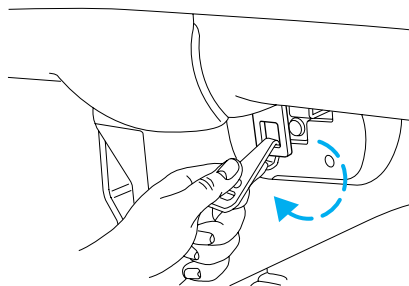

## Seating and safety restraints

5. Refer to the *Installing child safety seats in combination lap and shoulder belt seating positions* section of this chapter for further instructions to secure the child safety seat.
6. Tighten the child safety seat tether strap according to the manufacturer's instructions.



If the safety seat is not anchored properly, the risk of a child being injured in a collision greatly increases.

## Starting

### PREPARING TO START YOUR VEHICLE

Engine starting is controlled by the powertrain control system. This system meets all Canadian Interference-Causing Equipment standard requirements regulating the impulse electrical field strength of radio noise.

When starting a fuel-injected engine, avoid pressing the accelerator before or during starting. Only use the accelerator when you have difficulty starting the engine. For more information on starting the vehicle, refer to *Starting the engine* in this chapter.



Extended idling at high engine speeds can produce very high temperatures in the engine and exhaust system, creating the risk of fire or other damage.



Do not park, idle, or drive your vehicle in dry grass or other dry ground cover. The emission system heats up the engine compartment and exhaust system, which can start a fire.



Do not start your vehicle in a closed garage or in other enclosed areas. Exhaust fumes can be toxic. Always open the garage door before you start the engine. See *Guarding against exhaust fumes* in this chapter for more instructions.



If you smell exhaust fumes inside your vehicle, have your dealer inspect your vehicle immediately. Do not drive if you smell exhaust fumes.

### Important safety precautions

A computer system controls the engine's idle revolutions per minute (RPM). When the engine starts, the idle RPM runs faster to warm the engine. If the engine idle speed does not slow down automatically, have the vehicle checked. Do not allow the vehicle to idle for more than 10 minutes at high engine RPM.

Before starting the vehicle:

1. Make sure all vehicle occupants have buckled their safety belts. For more information on safety belts and their proper usage, refer to the *Seating and safety restraints* chapter.

## Starting

2. Make sure the headlamps and vehicle accessories are off.
3. Make sure the parking brake is set.
4. Make sure the gearshift is in P (Park).

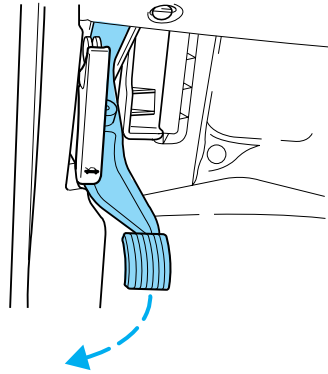

3. Turn the key to 4 (ON) without turning the key to 5 (START).

If there is difficulty in turning the key, firmly rotate the steering wheel left and right until the key turns freely. This condition may occur when:

- front wheels are turned
- front wheel is against the curb
- steering wheel is turned when getting in or out of the vehicle

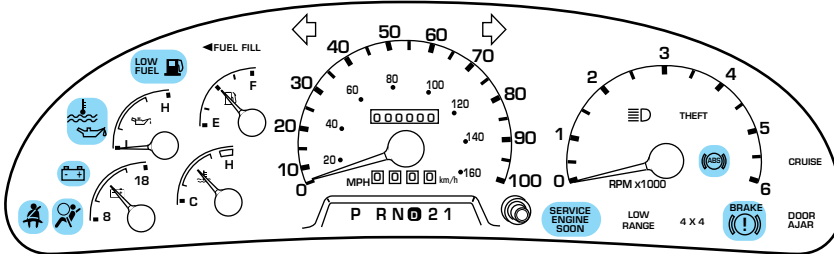
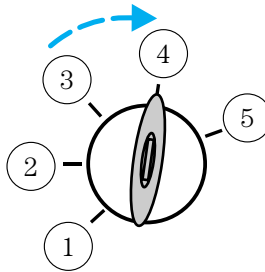

Make sure the corresponding lights illuminate briefly. If a light fails to illuminate, have the vehicle serviced.

- If the driver's safety belt is fastened, the  light may not illuminate.

## Starting

### STARTING THE ENGINE

1. Turn the key to 5 (START) without pressing the accelerator pedal and release as soon as the engine starts. The key will return to 4 (ON).

2. If the temperature is above  $-12^{\circ}\text{C}$  ( $10^{\circ}\text{F}$ ) and the engine does not start within five seconds on the first try, turn the key to OFF, wait 10 seconds and try again.

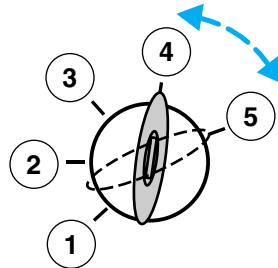

3. If the temperature is below  $-12^{\circ}\text{C}$  ( $10^{\circ}\text{F}$ ) and the engine does not start in 15 seconds on the first try, turn the key OFF and wait 10 seconds and try again. If the engine does not start in two attempts, press the accelerator pedal all the way to floor and hold. Turn the key to START position.

4. When the engine starts, release the key, then release the accelerator pedal gradually as the engine speeds up.

5. After idling for a few seconds, apply the brake and release the parking brake.

### Using the engine block heater (if equipped)

An engine block heater warms the engine coolant, which improves starting, warms up the engine faster and allows the heater-defroster system to respond quickly. Use of an engine block heater is strongly recommended if you live in a region where temperatures reach  $-23^{\circ}\text{C}$  ( $-10^{\circ}\text{F}$ ) or below.

For best results, plug the heater in at least three hours before starting the vehicle. Using the heater for longer than three hours will not harm the engine, so the heater can be plugged in the night before starting the vehicle.

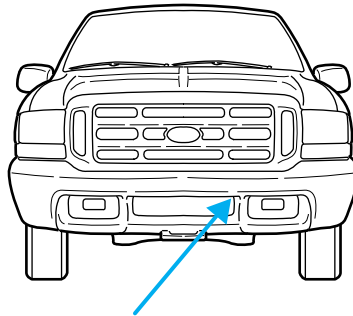

To prevent electrical shock, do not use your heater with ungrounded electrical systems or two-pronged (cheater) adapters.

## Starting

### Guarding against exhaust fumes

Although odorless and colorless, carbon monoxide is present in exhaust fumes. Take precautions to avoid its dangerous effects.



If you ever smell exhaust fumes of any kind inside your vehicle, have your dealer inspect and fix your vehicle immediately. Do not drive if you smell exhaust fumes. These fumes are harmful and could kill you.

Have the exhaust and body ventilation systems checked whenever:

- the vehicle is raised for service.
- the sound of the exhaust system changes.
- the vehicle has been damaged in a collision.



**WARNING:** Engine exhaust, some of its constituents, and certain vehicle components contain or emit chemicals known to the State of California to cause cancer and birth defects or other reproductive harm. In addition, certain fluids contained in vehicles and certain products of component wear contain or emit chemicals known to the State of California to cause cancer and birth defects or other reproductive harm.

### Important ventilating information

If the engine is idling while the vehicle is stopped in an open area for long periods of time, open the windows at least 2.5 cm (one inch).

Adjust the heating or air conditioning (if equipped) to bring in fresh air.

Improve vehicle ventilation by keeping all air inlet vents clear of snow, leaves and other debris.

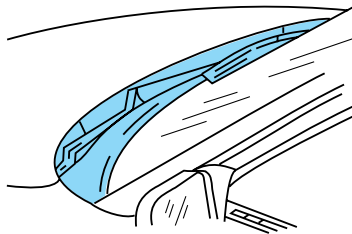

## Driving

### **BRAKES**

Your service brakes are self-adjusting. Refer to the scheduled maintenance guide for scheduled maintenance.

Occasional brake noise is normal and often does not indicate a performance concern with the vehicle's brake system. In normal operation, automotive brake systems may emit occasional or intermittent squeal or groan noises when the brakes are applied. Such noises are usually heard during the first few brake applications in the morning; however, they may be heard at any time while braking and can be aggravated by environmental conditions such as cold, heat, moisture, road dust, salt or mud. If a "metal-to-metal," "continuous grinding" or "continuous squeal" sound is present while braking, the brake linings may be worn-out and should be inspected by a qualified service technician.

### **Anti-lock brake system (ABS)**

On vehicles equipped with an anti-lock braking system (ABS), a noise from the hydraulic pump motor and pulsation in the pedal may be observed during ABS braking events. Pedal pulsation coupled with noise while braking under panic conditions or on loose gravel, bumps, wet or snowy roads is normal and indicates proper functioning of the vehicle's anti-lock brake system. The ABS performs a self-check after you start the engine and begin to drive away. A brief mechanical noise may be heard during this test. This is normal. If a malfunction is found, the ABS warning light will come on. If the vehicle has continuous vibration or shudder in the steering wheel while braking, the vehicle should be inspected by a qualified service technician.

The ABS operates by detecting the onset of wheel lockup during brake applications and compensates for this tendency. The wheels are prevented from locking even when the brakes are firmly applied. The accompanying illustration depicts the advantage of an ABS equipped vehicle (on bottom) to a non-ABS equipped vehicle (on top) during hard braking with loss of front braking traction.

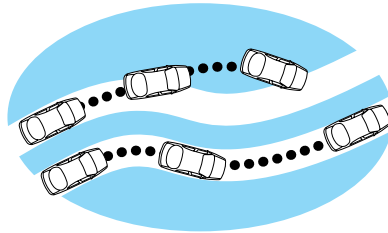



### ABS warning lamp (ABS)

The (ABS) warning lamp in the instrument cluster momentarily illuminates when the ignition is turned to the ON position. If the light does not illuminate momentarily at start up, remains on or continues to flash, the ABS needs to be serviced.

With the ABS light on, the anti-lock brake system is disabled and normal braking is still effective unless the brake warning light also remains illuminated with parking brake released. (If your brake warning lamp illuminates, have your vehicle serviced immediately.)

**BRAKE**  
(!)

### Using ABS

- In an emergency or when maximum efficiency from the ABS is required, apply continuous force on the brake. The ABS will be activated immediately, thus allowing you to retain full steering control of your vehicle and, providing there is sufficient space, will enable you to avoid obstacles and bring the vehicle to a controlled stop.
- The Anti-Lock system does not decrease the time necessary to apply the brakes or always reduce stopping distance. Always leave enough room between your vehicle and the vehicle in front of you to stop.
- We recommend that you familiarize yourself with this braking technique. However, avoid taking any unnecessary risks.

### Parking brake (P)

Apply the parking brake whenever the vehicle is parked. To set the parking brake, press the parking brake pedal down until the pedal stops.

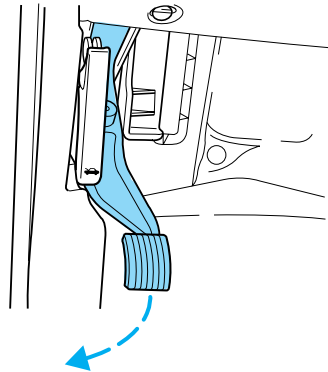

## Driving

The BRAKE warning lamp in the instrument cluster illuminates and remains illuminated (when the ignition is turned ON) until the parking brake is released.

**BRAKE**  
(!)

 Always set the parking brake fully and make sure that the gearshift is securely latched in P (Park) (automatic transmission) or in 1 (First) (manual transmission).

The parking brake is not recommended to stop a moving vehicle. However, if the normal brakes fail, the parking brake can be used to stop your vehicle in an emergency. Since the parking brake applies only the rear brakes, the vehicle's stopping distance will increase greatly and the handling of your vehicle will be adversely affected.

Pull the release lever to release the brake. Driving with the parking brake on will cause the brakes to wear out quickly and reduce fuel economy.

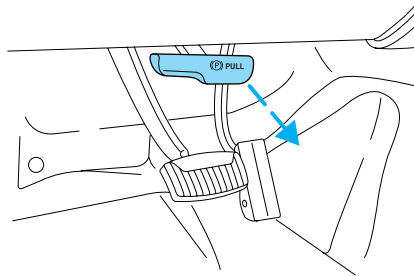

## STEERING YOUR VEHICLE

Your vehicle is equipped with power steering. Power steering uses energy from the engine to help steer the vehicle.

Never hold the steering wheel to the extreme right or the extreme left position for more than a few seconds when the engine is running. This action could damage the power steering pump.

If the amount of effort needed to steer your vehicle changes at a constant vehicle speed, have the power steering system checked. If the power steering system breaks down (or if the engine is turned off), you can steer the vehicle manually, but it takes more effort.

After any severe impact such as striking large potholes, sliding into curbs on icy roads or a collision involving the front end, have the front suspension and steering checked for possible damage.

## Driving

### PREPARING TO DRIVE YOUR VEHICLE



Utility vehicles have a significantly higher rollover rate than other types of vehicles.



In a rollover crash, an unbelted person is significantly more likely to die than a person wearing a seat belt.

Your vehicle has special design and equipment features to make it capable of performing in a wide variety of circumstances. These special design features, such as larger tires and increased ground clearance, give the vehicle a higher center of gravity than a passenger car.



Vehicles with a higher center of gravity such as utility and four-wheel drive vehicles handle differently than vehicles with a lower center of gravity. Utility and four-wheel drive vehicles are **not** designed for cornering at speeds as high as passenger cars any more than low-slung sports cars are designed to perform satisfactorily under off-road conditions. Avoid sharp turns, excessive speed and abrupt maneuvers in these vehicles. Failure to drive cautiously could result in an increased risk of vehicle rollover, personal injury and death.



Loaded vehicles, with a higher center of gravity, may handle differently than unloaded vehicles. Extra precautions, such as slower speeds and increased stopping distance, should be taken when driving a heavily loaded vehicle.

Your vehicle has the capability to haul more cargo than most passenger cars. Depending upon the type and placement of the load, hauling people and cargo may raise the center of gravity of the vehicle.

Use extra caution while becoming familiar with your vehicle. Know the capabilities and limitations of both you as a driver and your vehicle.

### AUTOMATIC TRANSMISSION OPERATION (IF EQUIPPED)

#### Brake-shift interlock

This vehicle is equipped with a brake-shift interlock feature that prevents the gearshift lever from being moved from P (Park) when the ignition is in the ON position unless brake pedal is depressed.

## Driving

If you cannot move the gearshift lever out of P (Park) with ignition in the ON position and the brake pedal depressed:

1. Apply the parking brake, turn ignition to the LOCK position, then remove the key.
2. Reinsert the key and turn the ignition to the OFF position.
3. Press and hold down the brake pedal and shift into N (Neutral).
4. Start the vehicle.

If it is necessary to use the above procedure to move the gearshift lever, it is possible that a fuse has blown or the vehicle's brakelamps are not operating properly. Refer to *Fuses and relays* in the *Roadside emergencies* chapter.



Do not drive your vehicle until you verify that the brakelamps are working.

If your vehicle gets stuck in mud or snow it may be rocked out by shifting from forward and reverse gears, stopping between shifts, in a steady pattern. Press lightly on the accelerator in each gear.

**Do not rock the vehicle for more than a few minutes. The transmission and tires may be damaged or the engine may overheat.**



Always set the parking brake fully and make sure the gearshift is latched in P (Park). Turn off the ignition whenever you leave your vehicle.



If the parking brake is fully released, but the brake warning lamp remains illuminated, the brakes may not be working properly. See your dealer or a qualified service technician.

### Driving with a 4-speed automatic transmission

#### ***Understanding gearshift positions***

To put your vehicle in gear, start the engine, depress the brake pedal, then move gearshift lever out of P (Park).

## Driving

 Hold the brake pedal down while you move the gearshift lever from P (Park) to another position. If you do not hold the brake pedal down, your vehicle may move unexpectedly and injure someone.

### **P (Park)**

Always come to a complete stop before shifting into P (Park). Make sure the gearshift lever is securely latched in P (Park). This position locks the transmission and prevents the rear wheels from turning.



 Always set the parking brake fully and make sure the gearshift lever is latched in P (Park). Turn off the ignition whenever you leave your vehicle.

### **R (Reverse)**

With the gearshift lever in R (Reverse), the vehicle will move backward. Always come to a complete stop before shifting into and out of R (Reverse).



### **N (Neutral)**

With the gearshift lever in N (Neutral), the vehicle can be started and is free to roll. Hold the brake pedal down while in this gear.



### **D (Overdrive)**

The normal driving position for the best fuel economy. Transmission operates in gears one through four.



 (Overdrive) can be deactivated by pressing the transmission control switch (TCS) on the end of the gearshift lever.

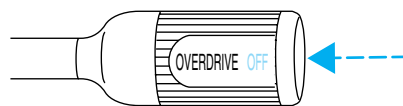

## Driving

The transmission control indicator light (TCIL) (the word OFF) on the end of the gearshift lever will illuminate.

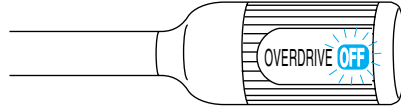

**Drive** – Not shown on the display. Activate by pressing the transmission control switch (TCS) on the end of the gearshift lever with the gearshift in the **D** position. The TCIL (the word OFF) will illuminate on the gearshift lever. Transmission operates in gears one through three. **D** (Drive) provides more engine braking than **D** (Overdrive) and is useful when:

- driving with a heavy load.
- towing a trailer up or down steep hills.
- additional engine downhill braking is desired. If towing a trailer, refer to *Driving while you tow* in the *Trailer towing* section.

To return to **D** (Overdrive) mode, press the transmission control switch (TCS). The TCIL (the word OFF) will no longer be illuminated.

Each time the vehicle is started, the transmission will automatically return to normal overdrive mode.

Every time the vehicle is shut off and restarted, you must press the transmission control switch to cancel overdrive operation if driving in overdrive is not desired.

### 2 (Second)

Use 2 (Second) to start-up on slippery roads or to provide additional engine braking on downgrades.



### 1 (First)

Use 1 (Low) to provide maximum engine braking on steep downgrades. Upshifts can be made by shifting to 2 (Second) or to **D** (Overdrive). Selecting 1 (Low) at higher speeds causes the transmission to shift to a lower gear, and will shift to 1 (Low) after vehicle decelerates to the proper speed.



### **Forced Downshifts**

To gain acceleration in **D** (Overdrive) or Drive (O/D OFF) when passing another vehicle, push the accelerator to the floor. The transmission will downshift to the appropriate gear: third, second or first gear.

### **Shift strategy (4R100 automatic transmission)**

To account for customer driving habits and conditions, your 4R100 automatic transmission electronically controls the shift quality by using an adaptive learning strategy. The adaptive learning strategy is maintained by power from the battery. When the battery is disconnected or a new battery is installed, the transmission must relearn its adaptive strategy. Optimal shifting will resume within a few hundred kilometers (miles) of operation.

**If the shift quality does not improve within a few hundred kilometers (miles) of operation, or if the downshifts and other throttle conditions do not function normally, see your dealer or a qualified service technician as soon as possible.**

### **POWER TAKE OFF (PTO)**

Your vehicle is not designed to be equipped with a Power Take Off (PTO). For PTO usage, a special transmission case, internal components and calibration are required. Ford Motor Company does not recommend the installation of a PTO system.

Damage resulting from the use of a PTO system may not be covered by your warranty.



Do not subject your Excursion to any auxiliary power take off applications as this could overheat the fuel tank and increase the risk of personal injury.

### **FOUR-WHEEL DRIVE (4WD) OPERATION (IF EQUIPPED)**



For important information regarding safe operation of this type of vehicle, see **Preparing to drive your vehicle** in this chapter.

When Four-wheel drive (4WD) is engaged, power is supplied to all four wheels through a transfer case. 4WD power can be selected when additional driving power is desired.

## Driving

If equipped with the Electronic Shift 4WD System, and the instrument panel control is moved to 4WD Low while the vehicle is moving, the system will not engage and no damage will occur to the 4WD system. Before 4WD Low can be engaged, the vehicle must be at a complete stop with the brake pedal depressed and the transmission in N (Neutral).

**4H or 4L operation is not recommended on dry pavement. Doing so could result in difficult disengagement of the transfer case, increased tire wear and decreased fuel economy.**

### Electronic shift on the fly (ESOF) 4x4 system

The 4WD system:

- provides 4x4 High engagement and disengagement while the vehicle is moving.
- is operated by a rotary control located on the instrument panel that allows you select 2WD, 4x4 High or 4x4 Low operation.
- uses hub locks that can be engaged and disengaged automatically by using a rotary control located on the instrument panel.
- automatic hub locks can be manually overridden by rotating the hub lock control from AUTO to LOCK. Automatic operation of the hub locks is recommended.
- **For proper operation, make sure that the arrow and the indicator dot on the hub are aligned.**

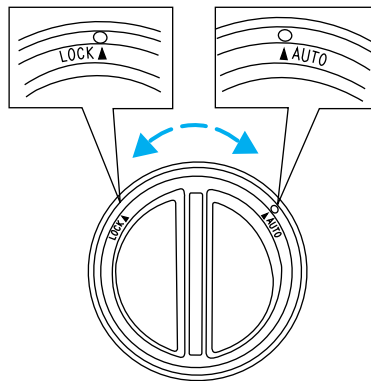

### 4WD system indicator lights

The 4WD system indicator lights illuminate only under the following conditions. If these lights illuminate when driving in 2WD, contact your Ford dealer as soon as possible.



- **4x4** -momentarily illuminates when the vehicle is started. Illuminates when 4x4 High or 4x4 LOW is engaged.
- **LOW RANGE** –momentarily illuminates when the vehicle is started. Illuminates when 4x4 Low is engaged.

**4x4**

**LOW  
RANGE**

### Using the electronic shift 4WD system

#### *Positions of the electronic shift system*

To prevent damage, the electronic shift 4WD system is designed to allow up to 45 seconds before the shift command is performed. In the event that conflicting shift commands are selected, allow up to 45 seconds for the shift command to be performed prior to reporting any shift concerns to your dealer.

**2WD (2WD High)** – Power to rear axle only.

**4x4 HIGH (4WD High)** – Power delivered to front and rear axles for increased traction.

**4x4 LOW (4WD Low)** – Power to front and rear axles at low speeds.

#### **Shifting from 2WD (2WD high) to 4x4 HIGH (4WD high)**

Rotate the 4WD control to the 4x4 HIGH position at speeds up to 88 km/h (55 mph).

- To prevent damage, the electronic shift 4WD system is designed to engage 4x4 HIGH (4WD high) when the vehicle is moving. If the 4x4 indicator light does not illuminate when shifting a vehicle that is stationary, start the vehicle moving. Once the vehicle is moving, 4x4 HIGH (4WD high) will engage and the 4x4 indicator will illuminate.

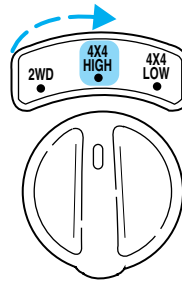

**Do not shift into 4x4 HIGH with the rear wheels slipping.**

## Driving

### **Shifting from 4x4 HIGH (4WD high) to 2WD (2WD high)**

Rotate the 4WD control to 2WD at any forward speed. Disengagement of the transfer case and front hubs may be delayed due to torque bind which is caused by driving on dry hard surfaces or performing tight turns while using the 4WD system.

- You **do not** need to operate the vehicle in R (Reverse) to disengage your front hubs.

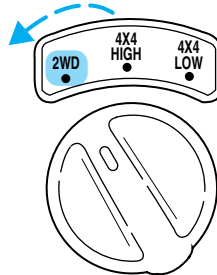

### **Shifting from 4x4 HIGH (4WD high) to 4x4 LOW (4WD low)**

1. Bring the vehicle to a complete stop.
2. Depress the brake.
3. Place the gearshift in N (Neutral).
4. Move the 4WD control to the 4x4 LOW position.
5. Hold the shift command until the LOW RANGE indicator light illuminates.
6. If the LOW RANGE indicator light **does not** illuminate after 15 seconds, start the vehicle moving, then repeat steps 1 through 5 before reporting any shift concerns to your dealer.

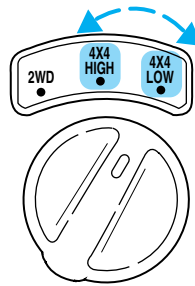

### **Shifting from 4x4 LOW (4WD low) to 4x4 HIGH (4WD high) or 2WD (2WD high)**

1. Bring the vehicle to a complete stop.
2. Depress the brake.
3. Place the gearshift in N (Neutral).

4. Move the 4WD control to the 4x4 HIGH (4WD high) or 2WD (2WD high) position.

5. Hold the shift command until the LOW RANGE indicator light shuts off.

6. If the LOW RANGE indicator light **does not** shut off after 15 seconds, start the vehicle moving, then repeat steps 1 through 5 before reporting any shift concerns to your dealer.

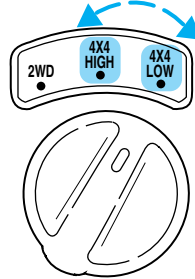

### Driving off-road with 4WD

Your vehicle is specially equipped for driving on sand, snow, mud and rough terrain and has operating characteristics that are somewhat different from conventional vehicles, both on and off the road.

Maintain steering wheel control at all times, especially in rough terrain. Since sudden changes in terrain can result in abrupt steering wheel motion, make sure you grip the steering wheel from the outside. Do not grip the spokes.

Drive cautiously to avoid vehicle damage from concealed objects such as rocks and stumps.

You should either know the terrain or examine maps of the area before driving. Map out your route before driving in the area. For more information on driving off-road, read the "Four Wheeling" supplement in your owner's portfolio.

### ***If your vehicle gets stuck***

If the vehicle is stuck it may be rocked out by shifting from forward and reverse gears, stopping between shifts, in a steady pattern. Press lightly on the accelerator in each gear.

**Do not rock the vehicle if the engine is not at normal operating temperature or damage to the transmission may occur.**

**Do not rock the vehicle for more than a few minutes or damage to the transmission and tires may occur or the engine may overheat.**

## Driving



Do not spin the wheels at over 56 km/h (35 mph). The tires may fail and injure a passenger or bystander.

### ***Sand***

When driving over sand, try to keep all four wheels on the most solid area of the trail. Do not reduce the tire pressures but shift to a lower gear and drive steadily through the terrain. Apply the accelerator slowly and avoid spinning the wheels.

### ***Mud and water***

If you must drive through high water, drive slowly. Traction or brake capability may be limited.

When driving through water, determine the depth; avoid water higher than the bottom of the hubs (if possible) and proceed slowly. If the ignition system gets wet, the vehicle may stall.

Once through water, always try the brakes. Wet brakes do not stop the vehicle as effectively as dry brakes. Drying can be improved by moving your vehicle slowly while applying light pressure on the brake pedal.

After driving through mud, clean off residue stuck to rotating driveshafts and tires. Excess mud stuck on tires and rotating driveshafts causes an imbalance that could damage drive components.

If the transmission, transfer case or front axle are submerged in water, their fluids should be checked and changed, if necessary.

### **Water intrusion into the transmission may damage the transmission.**

If the front or rear axle is submerged in water, the axle lubricant should be replaced.

### ***Driving on hilly or sloping terrain***

When driving on a hill, avoid driving crosswise or turning on steep slopes. You could lose traction and slip sideways. Drive straight up, straight down or avoid the hill completely. Know the conditions on the other side of a hill before driving over the crest.

When climbing a steep hill, start in a lower gear rather than downshifting to a lower gear from a higher gear once the ascent has started. This reduces strain on the engine and the possibility of stalling.

## Driving

When descending a steep hill, avoid sudden braking. Shift to a lower gear when added engine braking is desired.

When speed control is on and you are driving uphill, your vehicle speed may drop considerably, especially if you are carrying a heavy load.

If vehicle speed drops more than 16 km/h (10 mph), the speed control will cancel automatically. Resume speed with accelerator pedal.

If speed control cancels after climbing the hill, reset speed by pressing and holding the SET ACCEL button (to resume speeds over 50 km/h [30 mph]).

Automatic transmissions may shift frequently while driving up steep grades. Eliminate frequent shifting by shifting out of **D** (Overdrive) into a lower gear.

### ***Driving on snow and ice***

A 4WD vehicle has advantages over 2WD vehicles in snow and ice but can skid like any other vehicle.

Avoid sudden applications of power and quick changes of direction on snow and ice. Apply the accelerator slowly and steadily when starting from a full stop.

Apply the brakes as you normally would. Your 4WD vehicle is equipped with a Four Wheel Anti-lock Brake System (ABS). In order to allow the ABS to operate properly when braking, keep steady pressure on the brake pedal, do not pump the brakes.

When driving on snow or ice with either braking system, allow more stopping distance and drive slower than usual. Consider using one of the lower gears.

### **VEHICLE LOADING**

Before loading a vehicle, familiarize yourself with the following terms:

- **Base Curb Weight:** Weight of the vehicle including any standard equipment, fluids, lubricants, etc. It does not include passengers or aftermarket equipment.
- **Payload:** Combined maximum allowable weight of cargo, passengers and optional equipment. The payload equals the gross vehicle weight rating minus base curb weight.
- **GVW (Gross Vehicle Weight):** Base curb weight plus payload weight. The GVW is not a limit or a specification.

## Driving

- **GVWR (Gross Vehicle Weight Rating):** Maximum total weight of the base vehicle, passengers, optional equipment and cargo. The GVWR is specific to each vehicle and is listed on the Safety Certification Label on the driver's door pillar.
- **GAWR (Gross Axle Weight Rating):** Carrying capacity for each axle system. The GAWR is specific to each vehicle and is listed on the Safety Certification Label on the driver's door pillar.
- **GCW (Gross Combined Weight):** The combined weight of the towing vehicle (including passengers and cargo) and the trailer.
- **GCWR (Gross Combined Weight Rating):** Maximum combined weight of towing vehicle (including passengers and cargo) and the trailer. The GCWR indicates the maximum loaded weight that the vehicle is designed to tow.
- **Maximum Trailer Weight Rating:** Maximum weight of a trailer the vehicle is permitted to tow. The maximum trailer weight rating is determined by subtracting the vehicle curb weight for each engine/transmission combination, any required option weight for trailer towing and the weight of the driver from the GCWR for the towing vehicle.
- **Maximum Trailer Weight:** Maximum weight of a trailer the loaded vehicle (including passengers and cargo) is permitted to tow. It is determined by subtracting the weight of the loaded trailer towing vehicle from the GCWR for the towing vehicle.
- **Trailer Weight Range:** Specified weight range that the trailer must fall within that ranges from zero to the maximum trailer weight rating.

Remember to figure in the tongue load of your loaded trailer when figuring the total weight.



Do not exceed the GVWR or the GAWR specified on the certification label.

Do not use replacement tires with lower load carrying capacities than the originals because they may lower the vehicle's GVWR and GAWR limitations. Replacement tires with a higher limit than the originals do not increase the GVWR and GAWR limitations.

The Safety Certification Label, found on the driver's door pillar, lists several important vehicle weight rating limitations. Before adding any additional equipment, refer to these limitations. If you are adding weight

## Driving

to the front of your vehicle, (potentially including weight added to the cab), the weight added should not exceed the front axle reserve capacity (FARC). Additional frontal weight may be added to the front axle reserve capacity provided you limit your payload in other ways (i.e. restrict the number of passengers or amount of cargo carried).

You may add equipment throughout your vehicle if the total weight added is equal to or less than the total axle reserve capacity (TARC) weight. You should NEVER exceed the total axle reserve capacity.

Always ensure that the weight of passengers, cargo and equipment being carried is within the weight limitations that have been established for your vehicle including both gross vehicle weight and Front and rear gross axle weight rating limits. Under no circumstance should these limitations be exceeded. Exceeding any vehicle weight rating limitation could result in serious damage to the vehicle and/or personal injury.

### Special loading instructions for owners of pickup trucks and utility-type vehicles



For important information regarding safe operation of this type of vehicle, see the **Preparing to drive your vehicle** section in the **Driving** chapter of this owner guide.



Loaded vehicles, with a higher center of gravity, may handle differently than unloaded vehicles. Extra precautions, such as slower speeds and increased stopping distance, should be taken when driving a heavily loaded vehicle.

Your vehicle has the capability to haul more cargo and people than most passenger cars. Depending upon the type and placement of the load, hauling cargo and people may raise the center of gravity of the vehicle.

### Calculating the load your vehicle can carry/tow

1. Use the appropriate maximum gross combined weight rating (GCWR) chart to find the maximum GCWR for your type engine and rear axle ratio.
2. Weigh your vehicle as you customarily operate the vehicle without cargo. To obtain correct weights, try taking your vehicle to a shipping company or an inspection station for trucks.

## Driving

3. Subtract your loaded vehicle weight from the maximum GCWR on the following charts. This is the maximum trailer weight your vehicle can tow and must fall below the maximum shown under maximum trailer weight on the chart.

### DRIVING THROUGH WATER

Do not drive quickly through standing water, especially if the depth is unknown. Traction or brake capability may be limited and if the ignition system gets wet, your engine may stall. Water may also enter your engine's air intake and severely damage your engine.

If driving through deep or standing water is unavoidable, proceed very slowly. Never drive through water that is higher than the bottom of the hubs (for trucks) or the bottom of the wheel rims (for cars).

Once through the water, always try the brakes. Wet brakes do not stop the vehicle as effectively as dry brakes. Drying can be improved by moving your vehicle slowly while applying light pressure on the brake pedal.

**Driving through deep water where the transmission vent tube is submerged may allow water into the transmission and cause internal transmission damage.**

Your vehicle may tow a Conventional/Class IV trailer provided the maximum trailer weight is less than or equal to the maximum trailer weight listed for your engine and rear axle ratio on the following charts.

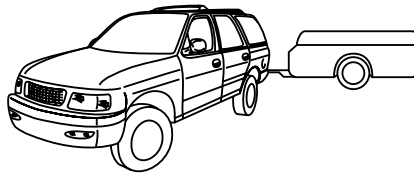

Your vehicle's load capacity is designated by weight, not by volume, so you cannot necessarily use all available space when loading a vehicle.

Towing a trailer places an additional load on your vehicle's engine, transmission, axle, brakes, tires and suspension. Inspect these components carefully after any towing operation.

**The hitch receiver was designed not to be removed. Any modification or removal of the hitch receiver compromises the safety benefit it was designed to provide.**



## Driving

4x2 w/automatic transmission			
Engine	Rear axle ratio	Maximum GCWR-kg (lbs.)	Maximum trailer weight-kg (lbs.)
5.4L	3.73	5 896 (13 000)	2 812 (6 200)
6.8L	3.73	7 711 (17 000)	4 536 (10 000)
6.8L	4.30	8 164 (18 000)	4 536 (10 000)

4x4 w/automatic transmission			
Engine	Rear axle ratio	Maximum GCWR-kg (lbs.)	Maximum trailer weight-kg (lbs.)
5.4L	4.10	6 577 (14 500)	3 265 (7 200)
6.8L	3.73	7 711 (17 000)	4 354 (9 600)
6.8L	4.30	8 164 (18 000)	4 536 (10 000)

**The frame mounted hitch receiver is non-removable.**

**Towing a Class IV trailer (extra heavy duty) 2 268–4 536 kg (5 001–10 000 lbs.) trailer weight requires a weight-distributing or fifth-wheel hitch.**



Do not exceed the GVWR or the GAWR specified on the certification label.



Towing trailers beyond the maximum recommended gross trailer weight could result in engine damage, transmission/axle damage, structural damage, loss of control, and personal injury.

### Trailer towing table

4x2 with automatic transmission			
Engine	Rear axle ratio	Maximum GCWR-kg (lbs.)	Maximum trailer weight-kg (lbs.)
5.4L	3.73	5 896 (13 000)	2 812 (6 200)
6.8L	3.73	7 711 (17 000)	4 536 (10 000)
6.8L	4.30	8 164 (18 000)	4 536 (10 000)
7.3L (Diesel)	3.73	8 164 (18 000)	4 536 (10 000)

## Driving

4x4 with automatic transmission			
Engine	Rear axle ratio	Maximum GCWR-kg (lbs.)	Maximum trailer weight-kg (lbs.)
5.4L	4.10	6 577 (14 500)	3 265 (7 200)
6.8L	3.73	7 711 (17 000)	4 354 (9 600)
6.8L	4.30	8 164 (18 000)	4 536 (10 000)
7.3L (Diesel)	3.73	8 164 (18 000)	4 536 (10 000)

**The frame mounted hitch receiver is non-removable.**

**Towing a Class IV trailer (extra heavy duty) 2 268–4 536 kg (5 001–10 000 lbs.) trailer weight requires a weight-distributing or fifth-wheel hitch.**

### Preparing to tow

Use the proper equipment for towing a trailer, and make sure it is properly attached to your vehicle. See your dealer or a reliable trailer dealer if you require assistance.

### Load equalizing hitch

When hooking up a trailer using a load equalizing hitch, always use the following procedure:

1. Park the unloaded vehicle on a level surface. With the ignition on and all doors closed, allow the vehicle to stand for several minutes so that it can level.
2. Measure the height of a reference point on the front and rear bumpers at the center of the vehicle.
3. Attach the trailer to the vehicle and adjust the hitch equalizers so that the front bumper height is within 0–13 mm (1/2 inch) of the reference point. After proper adjustment, the rear bumper should be no higher than in Step 3.



Adjusting an equalizing hitch so the rear bumper of the vehicle is lower or higher than it was unloaded will defeat the function of the load equalizing hitch and may cause unpredictable handling.

### Safety chains

Always connect the trailer's safety chains to the frame or hook retainers of the vehicle. To connect the trailer's safety chains, cross the chains under the trailer tongue and allow slack for turning corners.

If you use a rental trailer, follow the instructions that the rental agency gives to you.

**Attach safety chains to the hitch, not the bumper.**

### Trailer brakes

Electric brakes and manual, automatic or surge-type trailer brakes are safe if installed properly and adjusted to the manufacturer's specifications. The trailer brakes must meet local and Federal regulations.



Do not connect a trailer's hydraulic brake system directly to your vehicle's brake system. Your vehicle may not have enough braking power and your chances of having a collision greatly increase.

The braking system of the tow vehicle is rated for operation at the GVWR not GCWR.

### Trailer lamps

Trailer lamps are required on most towed vehicles. Make sure your trailer lamps conform to local and Federal regulations. See your dealer or trailer rental agency for proper instructions and equipment for hooking up trailer lamps.

### Using a step bumper

The rear bumper is equipped with an integral hitch and requires only a ball with a 25.4 mm (one inch) shank diameter. The bumper has a 2 270 kg (5 000 lb.) trailer weight and 227 kg (500 lb.) tongue weight capability.

If it is necessary to relocate the trailer hitch ball position, use the frame mounted hitch receiver.

### Driving while you tow

When towing a trailer:

- Ensure that you turn off your speed control. The speed control may shut off automatically when you are towing on long, steep grades.

## Driving

- Consult your local motor vehicle speed regulations for towing a trailer.
- Use a lower gear when towing up or down steep hills. This will eliminate excessive downshifting and upshifting for optimum fuel economy and transmission cooling.
- Anticipate stops and brake gradually.

**Exceeding the GCWR rating may cause internal transmission damage and void your warranty coverage.**

### ***Servicing after towing***

If you tow a trailer for long distances, your vehicle will require more frequent service intervals. Refer to your scheduled maintenance guide for more information.

### **Trailer towing tips**

- Practice turning, stopping and backing up before starting on a trip to get the feel of the vehicle trailer combination. When turning, make wider turns so the trailer wheels will clear curbs and other obstacles.
- Allow more distance for stopping with a trailer attached.
- The trailer tongue weight should be no more than 10–15% of the loaded trailer weight.
- After you have traveled 80 km (50 miles), thoroughly check your hitch, electrical connections and trailer wheel lug nuts.
- When stopped in traffic for long periods of time in hot weather, place the gearshift in P (Park) (automatic transmissions) or N (Neutral) (manual transmissions). This aids engine cooling and air conditioner efficiency.
- Vehicles with trailers should not be parked on a grade. If you must park on a grade, place wheel chocks under the trailer's wheels.

### **Launching or retrieving a boat**

When backing down a ramp during boat launching or retrieval,

- Do not allow the static water level to rise above the bottom edge of the rear bumper and
- Do not allow waves to break higher than 15 cm (6 inches) above the bottom edge of the rear bumper.
- Disconnect the trailer tow electrical connector to prevent blown fuses caused by water entering into your trailer's electrical wiring.

Exceeding these limits may allow water to enter critical vehicle components, adversely affecting driveability, emissions and reliability.

Replace front and rear axle lubricants anytime the axles have been submerged in water. Axle lubricant quantities are not to be checked unless a leak is suspected.

### **Recreational towing (all wheels on the ground)**

An example of recreational towing would be towing your vehicle behind a Motorhome. Follow these guidelines if you have the need for recreational towing your vehicle with all four wheels on the ground. These guidelines are designed to ensure that your transmission is not damaged.

#### **2WD vehicles (with automatic transmissions)**

- Place the transmission in N (Neutral)
- Maximum speed is 56 km (35 mph)
- Maximum distance is 80 km (50 miles)

If a distance of 80 km (50 miles) or a speed of 56 km (35 mph) must be exceeded, the drive shaft will have to be removed until the vehicle is being towed.

Ford recommends the driveshaft be removed/installed only by a qualified technician. See your local dealer for driveshaft removal/installation.

**Improper removal/installation of the driveshaft can cause transmission fluid loss, damage to the driveshaft and internal transmission components.**

#### **4WD vehicles electronic shift transfer case (with automatic transmissions)**

4x4 vehicles with electronic shift on the fly cannot be towed with any wheels on the ground.

### **LUGGAGE RACK**

Maximum load is 90 kg (200 lbs) on the roof rack structure, or 45 kg (100 lbs) on the roof panel slats, evenly distributed. If it is not possible to distribute the load, position it as far rearward as possible. Use adjustable tie down loops to secure the load.

## Driving

*To adjust the cross-bar position:*

1. Release the latch at both ends of the cross-bar (both cross-bars are adjustable).
2. Slide cross-bar to the desired location.
3. Tighten the latch at both ends of the cross-bar.

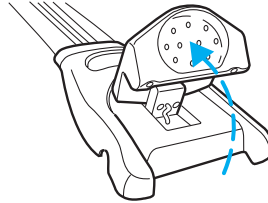

*To remove the cross-bar assembly from the roof rack side rails:*

1. Loosen the latch at both ends of the cross-bar (both cross-bars are adjustable).
2. Slide cross-bar to the end of the rail.
3. Slide the assemblies off the end.

## Driving

*To adjust the tie-downs:*

Use the adjustable tie downs to secure loads to the luggage carrier.

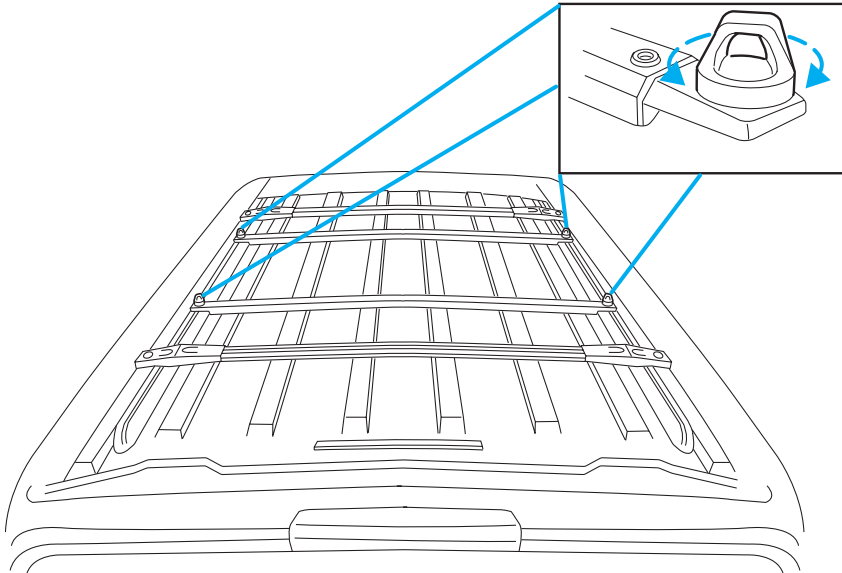

1. Loosen the slider knobs at each end of the cross rail.
2. Slide the crossbar to the desired placement. Ensure that both sides of the crossrails are even.
3. Tighten the slider knobs at both ends of the cross-bar.

## Roadside emergencies

### GETTING ROADSIDE ASSISTANCE

To fully assist you should you have a vehicle concern, Ford offers a complimentary roadside assistance program. This program is separate from the New Vehicle Limited Warranty. The service is available:

- 24-hours, seven days a week
- for the Basic warranty period (Canada) or New Vehicle Limited Warranty period (U.S.) of three years or 60,000 km (36,000 miles), whichever comes first on Ford and Mercury vehicles, and four years or 80,000 km (50,000 miles) on Lincoln vehicles

Roadside assistance will cover:

- changing a flat tire
- jump-starts
- lock-out assistance
- fuel delivery
- towing of your disabled vehicle to the nearest Ford dealership, or your selling dealer if within 25 kms (15.5 miles) of the nearest Ford Dealership (one tow per disablement). Even non-warranty related tows, like accidents or getting stuck in the mud or snow, are covered (some exclusions apply, such as impound towing or repossession).

### Using roadside assistance

Complete the roadside assistance identification card and place it in your wallet for quick reference. In the United States, this card is found in the Owner Guide portfolio in the glove compartment in Ford vehicles and is mailed to you if you own a Mercury or Lincoln. In Canada, it is found in the Roadside Assistance book in the glove compartment.

To receive roadside assistance in the United States for Ford or Mercury vehicles, call 1-800-241-3673 or if you own a Lincoln vehicle, call 1-800-521-4140. In Canada call 1-800-665-2006.

Should you need to arrange roadside assistance for yourself, Ford will reimburse a reasonable amount. To obtain information about reimbursement, call 1-800-241-3673 in the United States for Ford or Mercury vehicles; or if you own a Lincoln vehicle, call 1-800-521-4140. Call 1-800-665-2006 in Canada.



## Roadside emergencies

### Roadside coverage beyond basic warranty

In the United States, you may purchase additional roadside assistance coverage beyond this period through the Ford Auto Club by contacting your Ford or Lincoln Mercury dealer.

Similarly in Canada, you may purchase additional coverage beyond the basic coverage period by consulting the Ford Roadside Assistance Club brochure or by calling 1-877-294-CLUB (1-877-894-2582).

### HAZARD FLASHER

Use only in an emergency to warn traffic of vehicle breakdown, approaching danger, etc. The hazard flashers can be operated when the ignition is off.

- The hazard lights control is located on top of the steering column.
- Depress hazard lights control to activate all hazard flashers simultaneously.
- Depress control again to turn the flashers off.

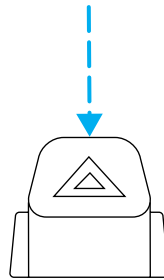

### RESETTING THE FUEL PUMP SHUT-OFF SWITCH

The fuel pump shut-off switch is a device intended to stop the electric fuel pump when your vehicle has been involved in a substantial jolt.

After a collision, if the engine cranks but does not start, the fuel pump shut-off switch may have been activated.

## Roadside emergencies

The fuel pump shut-off switch is located in the passenger's foot well, by the kick panel.

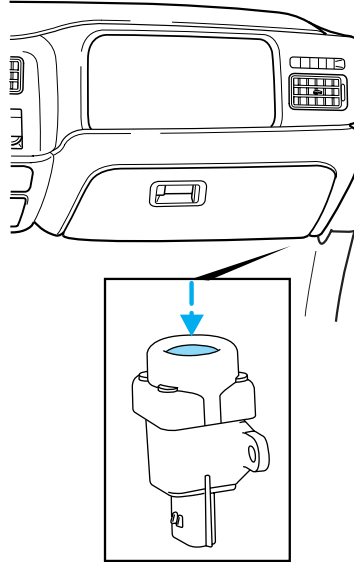

Use the following procedure to reset the fuel pump shut-off switch.

1. Turn the ignition to the OFF position.
2. Check the fuel system for leaks.
3. If no fuel leak is apparent, reset the fuel pump shut-off switch by pushing in on the reset button.
4. Turn the ignition to the ON position. Pause for a few seconds and return the key to the OFF position.
5. Make a further check for leaks in the fuel system.

## FUSES AND RELAYS

### Fuses

If electrical components in the vehicle are not working, a fuse may have blown. Blown fuses are identified by a broken wire within the fuse. Check the appropriate fuses before replacing any electrical components.

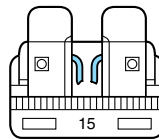

## Roadside emergencies



Always replace a fuse with one that has the specified amperage rating. Using a fuse with a higher amperage rating can cause severe wire damage and could start a fire.

### Standard fuse amperage rating and color

COLOR					
Fuse Rating	Mini Fuses	Standard Fuses	Maxi Fuses	Cartridge Maxi Fuses	Fuse Link Cartridge
2A	Grey	Grey	—	—	—
3A	Violet	Violet	—	—	—
4A	Pink	Pink	—	—	—
5A	Tan	Tan	—	—	—
7.5A	Brown	Brown	—	—	—
10A	Red	Red	—	—	—
15A	Blue	Blue	—	—	—
20A	Yellow	Yellow	Yellow	Blue	Blue
25A	Natural	Natural	—	—	—
30A	Green	Green	Green	Pink	Pink
40A	—	—	Orange	Green	Green
50A	—	—	Red	Red	Red
60A	—	—	Blue	—	Yellow
70A	—	—	Tan	—	Brown
80A	—	—	Natural	—	Black

### Passenger compartment fuse panel

The fuse panel is located below and to the left of the steering wheel by the brake pedal. Remove the panel cover to access the fuses.

## Roadside emergencies

To remove the fuse panel cover, turn the panel fasteners counterclockwise.

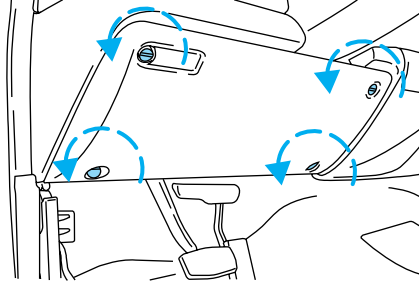

To remove a fuse use the fuse puller tool provided on the fuse panel cover.

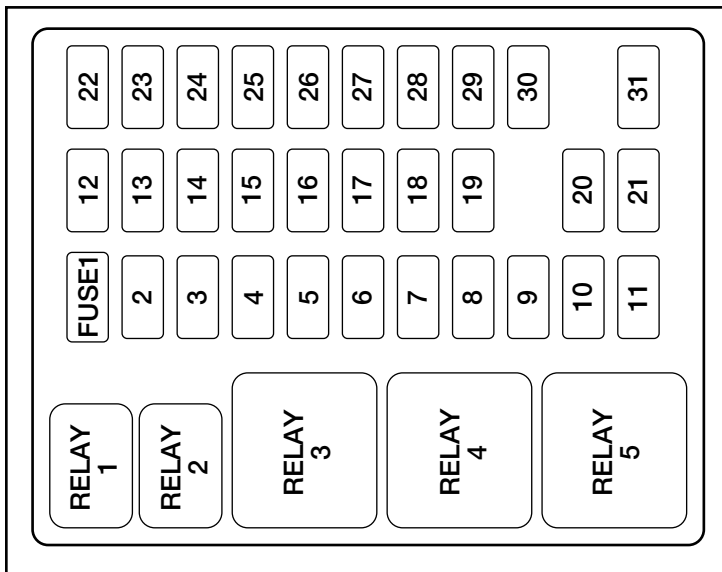
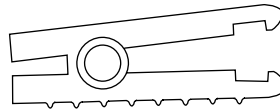

## Roadside emergencies

The fuses are coded as follows.

<b>Fuse/Relay Location</b>	<b>Fuse Amp Rating</b>	<b>Passenger Compartment Fuse Panel Description</b>
1	20A	Radio, Secondary Fusing for Audio Options
2	5A	Instrument Cluster, Powertrain Control Module (PCM) Keep Alive Memory, PATS LED
3	20A	Cigar Lighter, Data Link Connector
4	—	Not Used
5	10A	Ignition Run Power Feed (Customer Access)
6	15A	DRL, Brake Shift Interlock (BSI), ECM, Overhead Trip Computer (OTC), AUX A/C Components, Hazard Flasher, Speed Control, Vacuum Pump, Backup Lamps, Electronic Shift On The Fly Hublock Solenoid, Heated Seat
7	5A	Power Window/Lock Switch Illumination
8	5A	Headlamp Switch, LED/Radio
9	—	Not Used
10	—	Not Used
11	30A	Wiper Run/Park Relay Coil, Wiper Hi/LO Relay Coil, Washer Pump Relay Coils, Front Wiper Motor, Rear Wiper Motor Relay Coils
12	—	Not Used
13	20A	Stop Lamps, Center High-mount Stop Lamp/Hazard, Trailer Tow Stop Lamp, Speed Control
14	15A	Dome Lamp, Cargo Lamp, Courtesy Lamps, Running Boards, Power Mirrors, Vanity Mirrors, Map Lamps, Underhood Lamps, Glove Box Lamp, Power Windows (Delayed Accessory)
15	5A	Stop Lamp Switch (Logic), PATS, GEM
16	15A	Hi-beam Headlamps, Instrument Cluster (Hi-beam Indicator)

## Roadside emergencies

Fuse/Relay Location	Fuse Amp Rating	Passenger Compartment Fuse Panel Description
17	15A	Heated Mirrors, Rear Defroster "ON" indicator
18	10A	Rear Integrated Control Panel (RICP), CD Changer
19	10A	Instrument Cluster, GEM Module, Overdrive Cancel Switch, PATS/PATS Transiever, Idle Validation Switch (Diesel only)
20	15A	Starter Motor Relay, GEM, Radio (w/ Secondary)
21	5A	Radio Start Feed
22	10A	Air Bag Module, Blower Motor Relay Coil
23	—	Not Used
24	10A	A/C Clutch, Blend Door Actuator, Trailer Tow Battery Charge Relay Coil
25	5A	4-Wheel Anti-Lock Brake System (4WABS)
26	—	Not Used
27	—	Not Used
28	—	Not Used
29	5A	Instrument Cluster (Charge and Airbag Warning Lamps)
30	30A	PCM Relay Coil, Ignition Coil (Gasoline only), Fuel Heater (Diesel only), Wastegate Solenoid (Diesel only), Injector Driver Module Relay Coil (Diesel only)
31	—	Not Used
Relay 1	—	Interior Lamp Relay
Relay 2	—	Battery Saver Relay
Relay 3	—	Rear Defroster
Relay 4	—	Power Window One Touch Down Relay
Relay 5	—	Accessory Delay Relay

## Roadside emergencies

### Power distribution box

The power distribution box is located in the engine compartment. The power distribution box contains high-current fuses that protect your vehicle's main electrical systems from overloads.

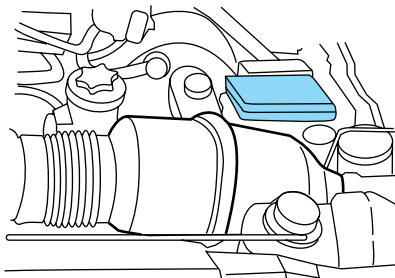

Always disconnect the battery before servicing high current fuses.



Always replace the cover to the Power Distribution Box before reconnecting the battery or refilling fluid reservoirs.

If the battery has been disconnected and reconnected, refer to the *Battery* section of the *Maintenance and care* chapter.

R03

## Roadside emergencies

The high-current fuses are coded as follows.

Fuse/Relay Location	Fuse Amp Rating	Power Distribution Box Description
1	20A*	Rear Wiper
2	10A*	Air Bag
3	15A*	Quarter Flip Window Motor
4	20A*	Trailer Tow Backup Lamps, Trailer Tow Park Lamps
5	20A*	Instrument Panel Auxiliary Power Point
6	10A*	Gasoline only-A/C (CASS) Diesel only-Alternator "A" Field
7	20A*	Floor Console Auxiliary Power Point
8	15A*	Park Lamps
9	20A*	Left Rear Quarter Auxiliary Power Point
10	30A*	Head Lamps
11	20A*	Cargo Auxiliary Power Point
12	15A*	DRL
13	10A*	Washer
14	15A*	Horn
15	—	Not Used
16	—	Not Used
17	—	Not Used
18	—	Not Used
19	20A* (Gasoline only) — (Diesel only)	Gasoline only-E40D/HEGO Diesel only-Not Used
20	7.5A*	Trailer Tow Stop /Turn LH
21	10A*	Left Headlamp
22	7.5A*	Trailer Tow Stop /Turn RH
23	10A*	Right Headlamp
24	20A* (Gasoline only) — (Diesel only)	Gasoline only-Engine Control Diesel only-Not Used



## Roadside emergencies

<b>Fuse/Relay Location</b>	<b>Fuse Amp Rating</b>	<b>Power Distribution Box Description</b>
101	50A**	Ignition Switch (B1 & B3)
102	30A**	Power Door Locks
103	40A**	Auxiliary Blower
104	30A**	Electronic Shift On The Fly (Transfer Case Motor)
105	50A**	Junction Box Battery Feed
106	— (Gasoline only) 30A** (Diesel only)	Gasoline only-Not Used Diesel only-Injector Driver Module
107	30A**	Heated Seats
108	30A**	Power Seats
109	40A**	Front Blower Motor
110	30A**	Trailer Tow Electronic Brake
111	—	Not Used
112	20A**	Fuel Pump
113	30A** (Gasoline only) 20A** (Diesel only)	PCM Power
114	—	Not Used
115	30A**	Trailer Tow Battery Charge
116	50A**	Ignition Switch (B4 & B5)
117	—	Not Used
118	40A**	Rear Defroster
201	—	Park Lamp
202	—	Fuel Pump
203	—	Not Used
204	—	Quarter Flip Window Motor
205	—	Rear Wiper
206	—	Rear Washer
207	—	Wiper Run/Park

## Roadside emergencies

Fuse/Relay Location	Fuse Amp Rating	Power Distribution Box Description
208	—	Wiper HI/LOW
209	—	Front Washer
301	—	Horn Relay
302	—	Gasoline only-A/C (CASS) Diesel only-Injector Driver Module Power Relay
303	—	Blower Motor
304	—	EEC Power
401	—	Not Used
501	—	Powertrain Control Module Diode
502	—	A/C Clutch Diode
503	—	Not Used
601	30A CB	Power Windows
602	60A**	Four Wheel Anti-Lock Brake Module
*Mini fuses **Maxi fuses		

### CHANGING THE TIRES

If you get a flat tire while driving, do not apply the brake heavily. Instead, gradually decrease your speed. Hold the steering wheel firmly and slowly move to a safe place on the side of the road.

### Spare tire information

Your vehicle may be equipped with a spare tire that can be used as either a spare or a regular tire. The spare tire is not equipped with wheel trim. The wheel trim from the original wheel/tire may be used on the spare.

**Your vehicle is equipped with 4WD, a spare tire of a different size than the road tires should not be used. Such a tire could result in damage to driveline components and make the vehicle difficult to control.**

## Roadside emergencies

### Location of the spare tire and tools

The spare tire and tools for your vehicle are stowed in the following locations:

Tool	Location
Spare tire	Mounted on the left rear quarter panel in the cargo area
Jack	In the rear cargo area stowage bin.
Jack handle and lug wrench	On top of the radiator support in the engine compartment

### Tire change procedure



To prevent the vehicle from moving when you change a tire, be sure the parking brake is set, then block (in both directions) the wheel that is diagonally opposite (other side and end of the vehicle) to the tire being changed.



If the vehicle slips off the jack, you or someone else could be seriously injured.

1. Park on a level surface, activate hazard flashers and set the parking brake.

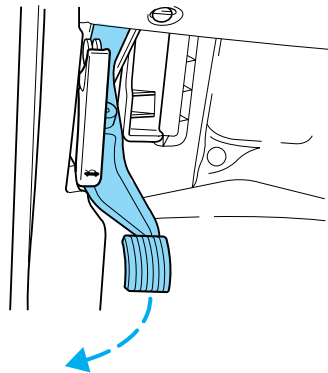

## Roadside emergencies

2. Turn engine OFF and block the diagonally opposite wheel (block not provided).

3. Remove the jack, jack handle, lug wrench and spare tire from the stowage locations.

4. Use the tip of the lug wrench to remove any wheel trim.

5. Loosen each wheel lug nut one-half turn counterclockwise but do not remove them until the wheel is raised off the ground.



When one of the rear wheels is off the ground, the transmission alone will not prevent the vehicle from moving or slipping off the jack, even if the transmission is in P (Park) (automatic transmission). To prevent the vehicle from moving when you change the tire, be sure that the parking brake is set and the diagonally opposite wheel is blocked.

6. Insert the hooked end of the jack handle into the jack and use the handle to slide the jack under the vehicle.

7. Position the jack according to the following guides:

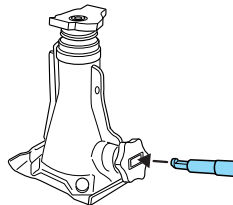
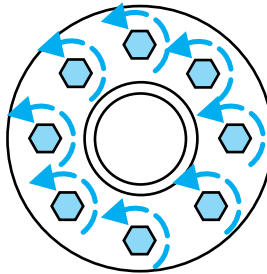
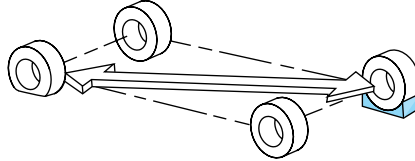

## Roadside emergencies

- Front passenger side (4x4)

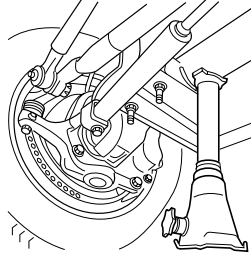

- Front driver side (4x4)

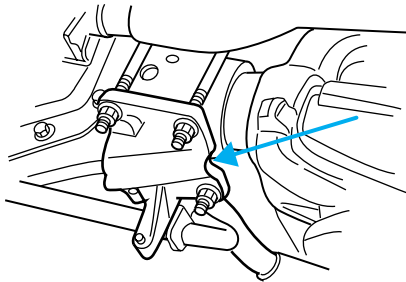

Make sure the jack fits into the notched area on the differential housing.

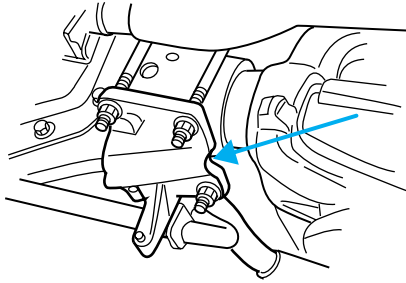

- Rear

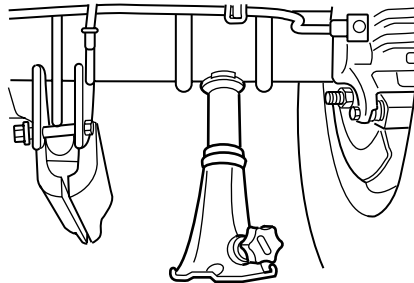

## Roadside emergencies

8. Turn the jack handle clockwise until the wheel is completely off the ground and high enough to install the spare tire.



To lessen the risk of personal injury, do not put any part of your body under the vehicle while changing a tire. Do not start the engine when your vehicle is on the jack. The jack is only meant for changing the tire.

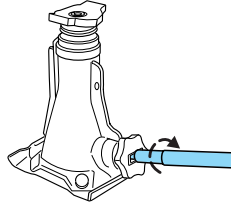

• **Never use the front or rear differential as a jacking point.**

9. Remove the lug nuts with the lug wrench.

10. Replace the flat tire with the spare tire, making sure the valve stem is facing outward. Reinstall the lug nuts until the wheel is snug against the hub. Do not fully tighten the lug nuts until the wheel has been lowered.

11. Lower the wheel by turning the jack handle counterclockwise.

12. Remove the jack and fully tighten the lug nuts in the order shown.

13. Stow the flat tire, jack, jack handle and lug wrench. Make sure the jack is securely fastened so it does not rattle when driving.

14. Unblock the wheels.

Retighten the lug nuts to the specified torque at 800 km (500 miles) after any wheel disturbance (rotation, flat tire, wheel removal, etc.).

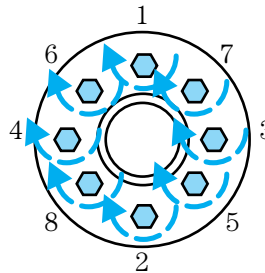



Bolt size	Wheel lug nut torque*	
	Nm	Lb-ft
M14 x 1.5	200-225	150-165

\* Torque specifications are for nut and bolt threads free of dirt and rust. Use only Ford recommended replacement fasteners.

## Roadside emergencies

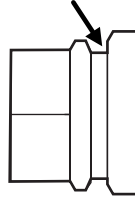
On all two-piece flat wheel nuts, apply one drop of motor oil between the flat washer and the nut. Do not apply motor oil to the wheel nut threads or the wheel stud threads.



 When a wheel is installed, always remove any corrosion, dirt or foreign materials present on the mounting surfaces of the wheel or the surface of the front disc brake hub and rotor that contacts the wheel. Installing wheels without correct metal-to-metal contact at the wheel mounting surfaces can cause the wheel nuts to loosen and the wheel to come off while the vehicle is in motion, resulting in loss of control.

### JUMP STARTING YOUR VEHICLE

 The gases around the battery can explode if exposed to flames, sparks, or lit cigarettes. An explosion could result in injury or vehicle damage.

 Do not push start your vehicle. You could damage the catalytic converter.

 Batteries contain sulfuric acid which can burn skin, eyes, and clothing, if contacted.

**Do not attempt to push start your vehicle. Automatic transmissions do not have push-start capability.**

## Roadside emergencies

### Preparing your vehicle

When the battery is disconnected or a new battery is installed, the transmission must relearn its adaptive strategy. As a result of this, the transmission may shift firmly. This operation is considered normal and will not effect function or durability of the transmission. Over time, the adaptive learning process will fully update transmission operation to its optimum shift feel.

1. **Use only a 12-volt supply to start your vehicle.**
2. Do not disconnect the battery of the disabled vehicle as this could damage the vehicle's electrical system.
3. Park the booster vehicle close to the hood of the disabled vehicle making sure the two vehicles **do not** touch. Set the parking brake on both vehicles and stay clear of the engine cooling fan and other moving parts.
4. Check all battery terminals and remove any excessive corrosion before you attach the battery cables. Ensure that vent caps are tight and level.
5. Turn the heater fan on in both vehicles to protect any electrical surges. Turn all other accessories off.

### Connecting the jumper cables

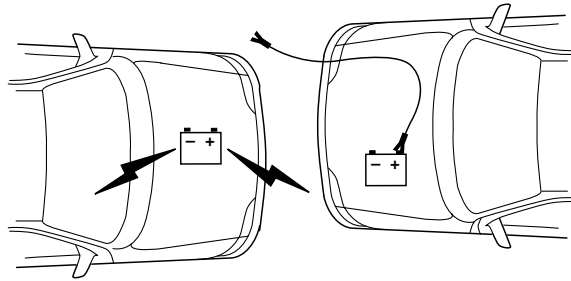

1. Connect the positive (+) booster cable to the positive (+) terminal of the discharged battery.

**Note:** In the illustrations, *lightning bolts* are used to designate the assisting (boosting) battery.



## Roadside emergencies

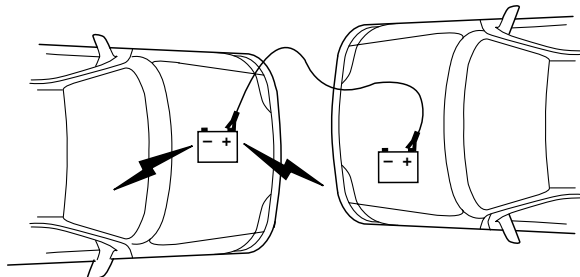

2. Connect the other end of the positive (+) cable to the positive (+) terminal of the assisting battery.

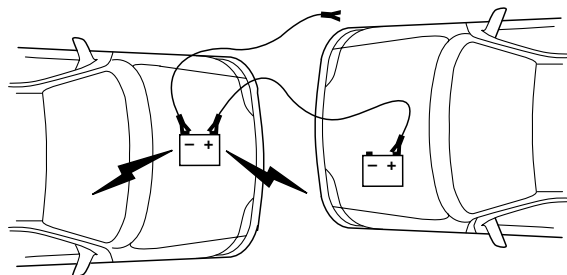

3. Connect the negative (-) cable to the negative (-) terminal of the assisting battery.

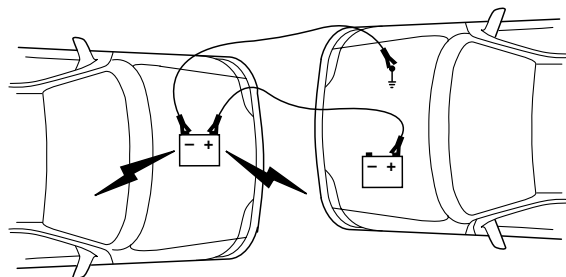

4. Make the final connection of the negative (-) cable to an exposed metal part of the stalled vehicle's engine, away from the battery and the carburetor/fuel injection system. **Do not** use fuel lines, engine rocker covers or the intake manifold as *grounding* points.

## Roadside emergencies



Do not connect the end of the second cable to the negative (-) terminal of the battery to be jumped. A spark may cause an explosion of the gases that surround the battery.

5. Ensure that the cables are clear of fan blades, belts, moving parts of both engines, or any fuel delivery system parts.

### Jump starting

1. Start the engine of the booster vehicle and run the engine at moderately increased speed.
2. Start the engine of the disabled vehicle.
3. Once the disabled vehicle has been started, run both engines for an additional three minutes before disconnecting the jumper cables.

### Removing the jumper cables

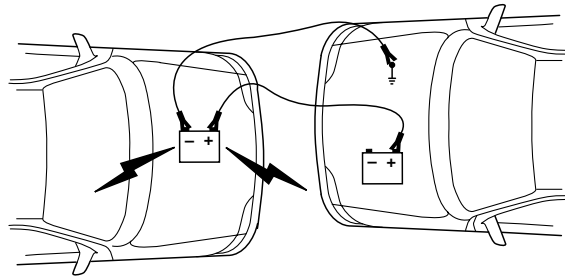

**Remove the jumper cables in the reverse order that they were connected.**

1. Remove the jumper cable from the *ground* metal surface.

## Roadside emergencies

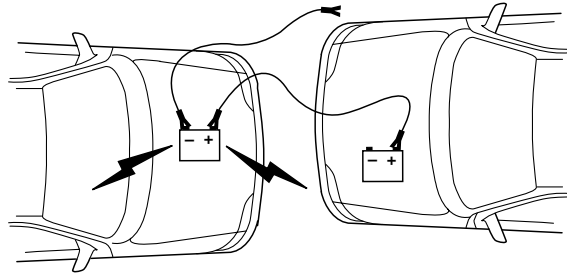

2. Remove the jumper cable on the negative (-) connection of the booster vehicle's battery.

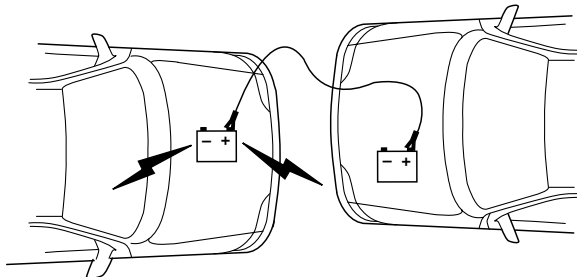

3. Remove the jumper cable from the positive (+) terminal of the booster vehicle's battery.

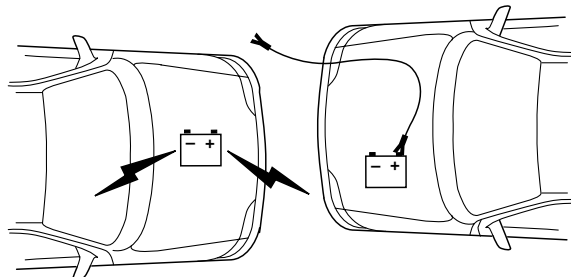

4. Remove the jumper cable from the positive (+) terminal of the disabled vehicle's battery.

## Roadside emergencies

After the disabled vehicle has been started and the jumper cables removed, allow it to idle for several minutes so the engine computer can *relearn* its idle conditions.

When the battery is disconnected or a new battery is installed, the transmission must relearn its adaptive strategy. As a result of this, the transmission may shift firmly. This operation is considered normal and will not effect function or durability of the transmission. Over time, the adaptive learning process will fully update transmission operation to its optimum shift feel.

## Roadside emergencies

### WRECKER TOWING

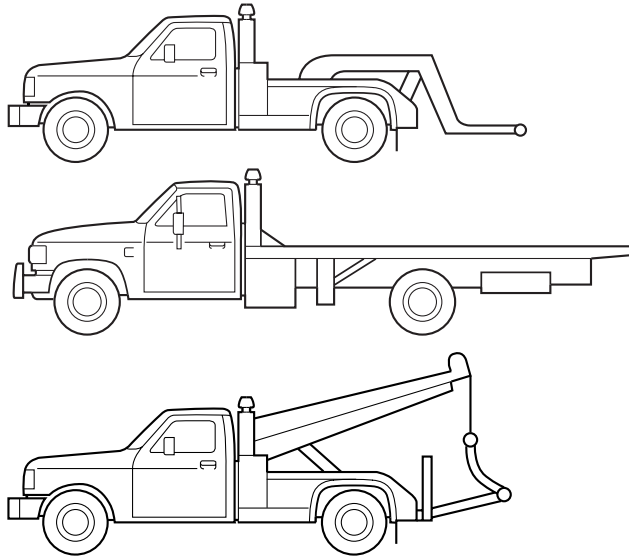

If you need to have your vehicle towed, contact a professional towing service or, if you are a member, your roadside assistance center.

On 4x2 vehicles, it is acceptable to tow the vehicle with the front wheels on the ground and the rear wheels off the ground using a wheel lift or a slingbelt with T-hooks.

On 4x4 vehicles, it is recommended that your vehicle be towed with a wheel lift or flatbed equipment with all the wheels off the ground. However, a slingbelt with T-hooks and a wheel dolly can also be used.

**If the vehicle is towed by other means or incorrectly, vehicle damage may occur.**

Ford Motor Company provides a towing manual for all authorized tow truck operators. Have your tow truck operator refer to this manual for proper hook-up and towing procedures for your vehicle.

## Maintenance and care

### SERVICE RECOMMENDATIONS

To help you service your vehicle:

- We highlight do-it-yourself items in the engine compartment for easy location.
- We provide a scheduled maintenance guide which makes tracking routine service easy.

If your vehicle requires professional service, your dealership can provide necessary parts and service. Check your “Warranty Guide” to find out which parts and services are covered.

Use only recommended fuels, lubricants, fluids and service parts conforming to specifications. Motorcraft parts are designed and built to provide the best performance in your vehicle.

### PRECAUTIONS WHEN SERVICING YOUR VEHICLE

Be especially careful when inspecting or servicing your vehicle.

- Do not work on a hot engine.
- When the engine is running, keep loose clothing, jewelry or long hair away from moving parts.
- Do not work on a vehicle with the engine running in an enclosed space, unless you are sure you have enough ventilation.
- Keep all lit cigarettes, open flames and other lit material away from the battery and all fuel related parts.

If you disconnect the battery, the engine must “relearn” its idle conditions before your vehicle will drive properly, as explained in the *Battery* section in this chapter.

#### Working with the engine off

1. Set the parking brake and ensure the gearshift is securely latched in P (Park).
2. Turn off the engine and remove the key.
3. Block the wheels to prevent the vehicle from moving unexpectedly.

#### Working with the engine on

1. Set the parking brake and ensure the gearshift is securely latched in P (Park).
2. Block the wheels to prevent the vehicle from moving unexpectedly.

## Maintenance and care



Do not start your engine with the air cleaner removed and do not remove it while the engine is running.

### OPENING THE HOOD

1. Inside the vehicle, pull the hood release handle located under the bottom left corner of the instrument panel.

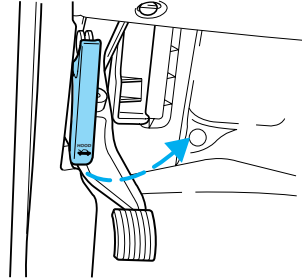

2. Go to the front of the vehicle and release the auxiliary latch located under the right center of the hood. Slide the handle to release the auxiliary latch.

3. Lift the hood until the lift cylinders hold it open.

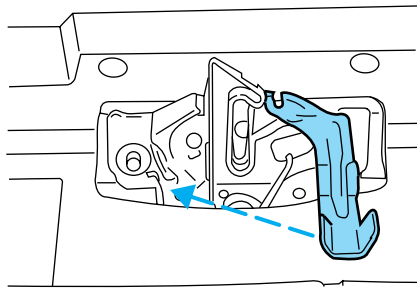

## Maintenance and care

### IDENTIFYING COMPONENTS IN THE ENGINE COMPARTMENT

#### 5.4L V8/6.8L V10 GASOLINE ENGINES

Refer to the *7.3 Liter Power Stroke Direct Injection Turbo Diesel Owner's Guide Supplement* for diesel engine component locations.

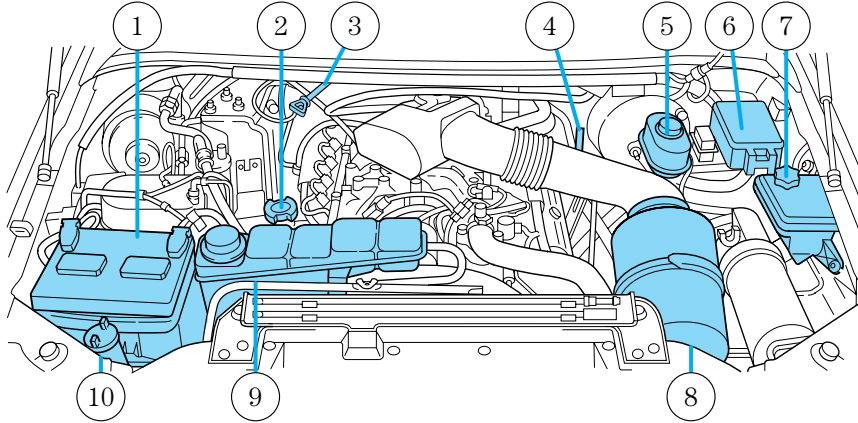

1. Battery
2. Engine oil filler cap
3. Transmission fluid dipstick
4. Engine oil dipstick
5. Brake fluid reservoir
6. Power distribution box
7. Power steering fluid reservoir
8. Air filter assembly
9. Engine coolant reservoir
10. Windshield washer fluid reservoir

#### ENGINE OIL

##### Checking the engine oil

Refer to the scheduled maintenance guide for the appropriate intervals for checking the engine oil.



## Maintenance and care

1. Make sure the vehicle is on level ground.
2. Turn the engine off and wait a few minutes for the oil to drain into the oil pan.
3. Set the parking brake and ensure the gearshift is securely latched in P (Park).
4. Open the hood. Protect yourself from engine heat.
5. Locate and carefully remove the engine oil level indicator (dipstick).



6. Wipe the indicator clean. Insert the indicator fully, then remove it again.

- If the oil level is **between the MIN and MAX marks**, the oil level is acceptable. **DO NOT ADD OIL.**
- If the oil level is below the MIN mark, add enough oil to raise the level within the MIN-MAX range.

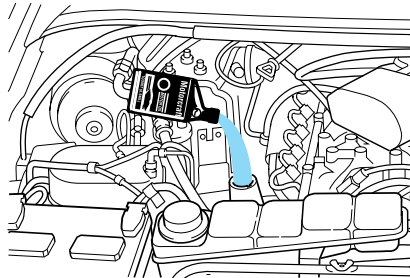

- Oil levels above the MAX mark may cause engine damage. Some oil must be removed from the engine by a service technician.

7. Put the indicator back in and ensure it is fully seated.

## Maintenance and care

### Adding engine oil

1. Check the engine oil. For instructions, refer to *Checking the engine oil* in this chapter.
2. If the engine oil level is not within the normal range, add only certified engine oil of the recommended viscosity. Remove the engine oil filler cap and use a funnel to pour the engine oil into the opening.
3. Recheck the engine oil level. Make sure the oil level is not above the MAX mark on the engine oil level indicator (dipstick).
4. Install the indicator and ensure it is fully seated.
5. Fully install the engine oil filler cap by turning the filler cap clockwise until three clicks are heard or until it is latched.

**To avoid possible oil loss, DO NOT operate the vehicle with the engine oil level indicator and/or the engine oil filler cap removed.**

### Engine oil and filter recommendations

Look for this certification trademark.

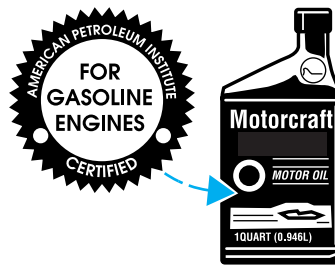

Use SAE 5W-30 motor oil certified for gasoline engines by the American Petroleum Institute (API).

Motor oil displaying the API certification trademark will meet all requirements for your vehicle's engine.

Ford oil specification is WSS-M2C153-G.

Do not use supplemental engine oil additives, oil treatments or engine treatments. They are unnecessary and could, under certain conditions, lead to engine damage which is not covered by your warranty.

Change your engine oil and filter according to the appropriate schedule listed in the scheduled maintenance guide.

Ford production and aftermarket (Motorcraft) oil filters are designed for added engine protection and long life. If a replacement oil filter is used

## Maintenance and care

that does not meet Ford material and design specifications, start-up engine noises or knock may be experienced.

It is recommended you use the appropriate Motorcraft oil filter (or another brand meeting Ford specifications) for your engine application.

### **BRAKE FLUID** (⚠)

#### **Checking and adding brake fluid—gasoline engine**

Brake fluid should be checked and refilled as needed. Refer to the scheduled maintenance guide for the service interval schedules.

1. Clean the reservoir cap before removal to prevent dirt or water from entering the reservoir.

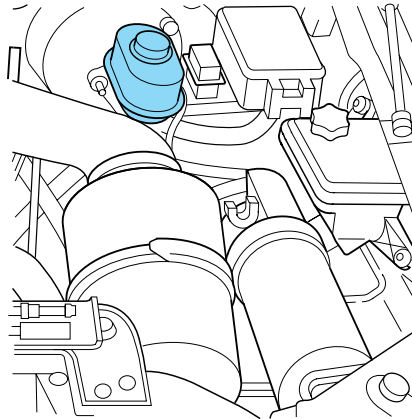

2. Visually inspect the fluid level.

3. If necessary, add brake fluid from a clean un-opened container until the level reaches MAX. Do not fill above this line.

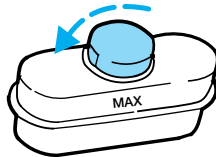

4. Use only a DOT 3 brake fluid certified to meet Ford specifications. Refer to *Lubricant specifications* in the *Capacities and specifications* chapter.



Brake fluid is toxic. If brake fluid contacts the eyes, flush eyes with running water for 15 minutes. Seek medical attention if irritation persists. If taken internally, drink water and induce vomiting. Seek medical attention immediately.

## Maintenance and care



If you use a brake fluid that is not DOT 3, you will cause permanent damage to your brakes.



Do not let the reservoir for the master cylinder run dry. This may cause the brakes to fail.

### Checking and adding brake fluid—diesel engine

Check and refill the Hydromax brake fluid reservoir using the following procedure. Refer to the scheduled maintenance guide for the service interval.

1. Clean the reservoir caps before removal to prevent dirt or water from entering the reservoir.
2. Visually inspect the fluid level.
3. If necessary, add brake fluid from a clean un-opened container until the level reaches MAX. Do not fill above this line.
4. Use only a DOT 3 brake fluid certified to meet Ford specifications. Refer to *Lubricant specifications* in the *Capacities and specifications* chapter.

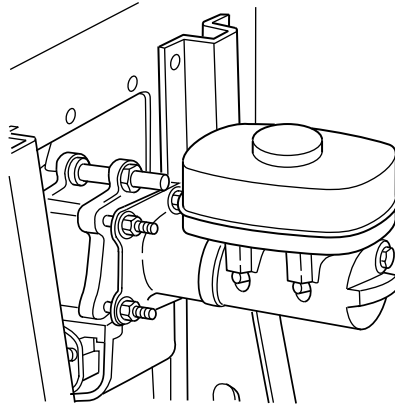

Brake fluid is toxic. If brake fluid contacts the eyes, flush eyes with running water for 15 minutes. Seek medical attention if irritation persists. If taken internally, drink water and induce vomiting. Seek medical attention immediately.



If you use a brake fluid that is not DOT 3, you will cause permanent damage to your brakes.



Do not let the reservoir for the master cylinder run dry. This may cause the brakes to fail.

## Maintenance and care

Brake system fluid should be replaced on a regular basis to maintain optimum braking performance, especially under heavy-duty driving conditions such as frequent steep grades or heavy loads. Refer to the scheduled maintenance guide for the service interval.

### WINDSHIELD WASHER FLUID

#### Checking and adding washer fluid

Check the washer fluid whenever you stop for fuel. The reservoir is highlighted with a  symbol.

If the level is low, add enough fluid to fill the reservoir. In very cold weather, do not fill the reservoir all the way.

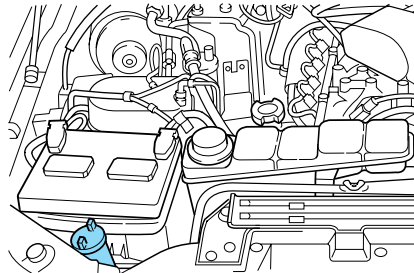

Only use a washer fluid that meets Ford specifications. Refer to *Lubricant specifications* in the *Capacities and specifications* chapter.

State or local regulations on volatile organic compounds may restrict the use of methanol, a common windshield washer antifreeze additive. Washer fluids containing non-methanol antifreeze agents should be used only if they provide cold weather protection without damaging the vehicle's paint finish, wiper blades or washer system.



Do not put washer fluid in the engine coolant reservoir. Washer fluid placed in the cooling system may harm engine and cooling system components.

#### Checking and adding washer fluid for the liftgate

Washer fluid for the liftgate is supplied by the same reservoir as the windshield.

### ENGINE COOLANT

#### Checking engine coolant

Your engine's cooling system has been factory-filled with a 50/50 mixture of distilled water and Ford Premium Engine Coolant E2FZ-19549-AA (in Canada, Motorcraft CXC-10), or an equivalent premium engine coolant that meets Ford specification ESE-M97B44-A.

## Maintenance and care

A **50/50 mixture** of distilled water and Ford Premium Engine Coolant provides:

- **maximum cooling system efficiency.**
- **freeze protection down to -36° C (-34° F).**
- **boiling protection up to 129° C (265° F).**
- **protection against rust and other forms of corrosion.**
- **an accurate temperature readout from the engine coolant gauge.**

**The engine coolant must be maintained at the correct fluid level and concentration to work properly. If the engine coolant fluid level and concentration is not maintained correctly, damage to the engine and cooling system may result.**

When the engine is cold, check the level of the engine coolant in the reservoir.

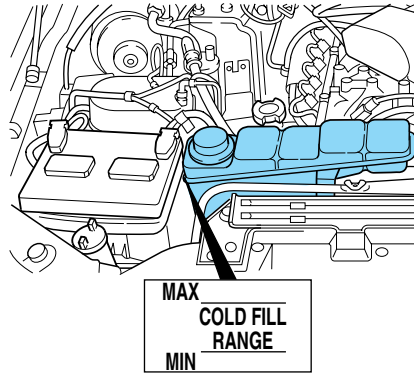

- The engine coolant should be at the “cold fill level” or within the “cold fill range” as listed on the engine coolant reservoir (depending upon application).
- Refer to the Scheduled Maintenance Guide for service interval schedules.
- Be sure to read and understand *Precautions when servicing your vehicle* in this chapter.

If the engine coolant has not been checked at the recommended interval, the engine coolant reservoir may become low or empty. If the reservoir is low or empty, add engine coolant to the reservoir. Refer to *Adding engine coolant* in this chapter.

## Maintenance and care



Automotive fluids are not interchangeable; do not use engine coolant, antifreeze or windshield washer fluid outside of its specified function and vehicle location.

### Adding engine coolant

Use only Ford Premium Engine Coolant E2FZ-19549-AA (in Canada, Motorcraft CXC-10) or a premium engine coolant that meets Ford specification ESE-M97B44-A.

- **DO NOT USE Ford Extended Life Engine Coolant F6AZ-19544-AA (orange in color).**
- **DO NOT USE a DEX-COOL® engine coolant or an equivalent engine coolant that meets Ford specification WSS-M97B44-D.**
- **DO NOT USE alcohol or methanol antifreeze or any engine coolants mixed with alcohol or methanol antifreeze.**
- **DO NOT USE supplemental coolant additives in your vehicle. These additives may harm your engine's cooling system.**
- **DO NOT MIX recycled coolant and conventional coolant together in your vehicle. Mixing of engine coolants may harm your engine's cooling system.**
- **The use of an improper coolant may harm engine and cooling system components and may void the warranty of your vehicle's engine cooling system. If you are unsure which type of coolant your vehicle requires, contact your local dealer.**



Do not put engine coolant in the windshield washer fluid reservoir. If engine coolant is sprayed onto the windshield, it could make it difficult to see through the windshield.

When the engine is cool, add a **50/50 mixture** of engine coolant and distilled water to the engine coolant reservoir, until the coolant is at the "cold fill level" or within the "cold fill range" as listed in the engine coolant reservoir (depending upon application).

- **NEVER increase the coolant concentration above 60%.**
- **NEVER decrease the coolant concentration below 40%.**
- **Engine coolant concentrations above 60% or below 40% will decrease the freeze protection characteristics of the engine coolant and may cause engine damage.**

## Maintenance and care

Plain water may be added in an emergency, but you **must** replace it with a 50/50 mixture of engine coolant and distilled water as soon as possible.

Check the coolant level in the reservoir before you drive your vehicle the next few times (with the engine cool). If necessary, add a **50/50 mixture** of engine coolant and distilled water to the engine coolant reservoir until the coolant level is at the “cold fill level” or within the “cold fill range” as listed on the reservoir (depending upon application).

Have your dealer check the engine cooling system for leaks if you have to add more than 1.0 liter (1.0 quart) of engine coolant per month.



To avoid scalding hot steam or coolant from being released from the engine cooling system, never remove the reservoir cap while the engine is running or hot. Failure to follow this warning may result in damage to the engine's cooling system and possible severe personal injury.

If you must remove the coolant cap, follow these steps to avoid personal injury:

1. Before you remove the cap, turn the engine off and let it cool.
2. When the engine is cool, wrap a thick cloth around the cap. Slowly turn cap counterclockwise until pressure begins to release.
3. Step back while the pressure releases.
4. When you are sure that all the pressure has been released, use the cloth to turn it counterclockwise and remove the cap.

### Recycled engine coolant

Ford Motor Company recommends the use of a recycled engine coolant produced by Ford-approved processes.

Not all coolant recycling processes produce coolant which meets Ford specification ESE-M97B44-A. Use of a recycled engine coolant which does not meet the Ford specification may harm engine and cooling system components.



Always dispose of used automotive fluids in a responsible manner. Follow your community's regulations and standards for recycling and disposing of automotive fluids.



## Maintenance and care

### Coolant refill capacity

To find out how much fluid your vehicle's cooling system can hold, refer to *Refill capacities* in the *Capacities and specifications* chapter.

Fill your engine coolant reservoir as outlined in *Adding engine coolant* in this chapter.

### Severe climates

If you drive in extremely cold climates (less than  $-36^{\circ}\text{C}$  [ $-34^{\circ}\text{F}$ ):

- **it may be necessary to increase the coolant concentration above 50%.**
- **NEVER increase the coolant concentration above 60%.**
- **increased engine coolant concentrations above 60% will decrease the overheat protection characteristics of the engine coolant and may cause engine damage.**
- **refer to the chart on the coolant container to ensure the coolant concentration in your vehicle will provide adequate freeze protection at the temperatures in which you drive in the winter months.**

If you drive in extremely hot climates:

- **it is still necessary to maintain the coolant concentration above 40%.**
- **NEVER decrease the coolant concentration below 40%.**
- **decreased engine coolant concentrations below 40% will decrease the corrosion protection characteristics of the engine coolant and may cause engine damage.**
- **decreased engine coolant concentrations below 40% will decrease the freeze protection characteristics of the engine coolant and may cause engine damage.**
- **refer to the chart on the coolant container to ensure the coolant concentration in your vehicle will provide adequate protection at the temperatures in which you drive.**

Vehicles driven year-round in non-extreme climates should use a 50/50 mixture of engine coolant and distilled water for optimum cooling system and engine protection.



## Maintenance and care

### What you should know about fail-safe cooling (if equipped)

If the engine coolant supply is depleted, this feature allows the vehicle to be driven temporarily before incremental component damage is incurred. The “fail-safe” distance depends on ambient temperatures, vehicle load and terrain.

#### How fail-safe cooling works

If the engine begins to overheat:

- the engine coolant temperature gauge will move to the red (hot) area.
- the  and  symbol will illuminate.
- the *Service Engine Soon* indicator light will illuminate.

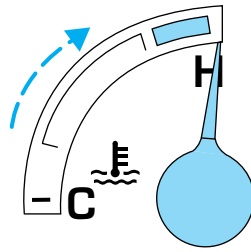

If the engine reaches a preset over-temperature condition, the engine will automatically switch to alternating cylinder operation. Each disabled cylinder acts as an air pump and cools the engine.

When this occurs the vehicle will still operate. However:

- the engine power will be limited.
- the air conditioning system will be disabled.

Continued operation will increase the engine temperature and the engine will completely shut down, causing steering and braking effort to increase.

Once the engine temperature cools, the engine can be re-started. Take your vehicle to a service facility as soon as possible to minimize engine damage.

#### When fail-safe mode is activated

You have limited engine power when in the fail-safe mode, so drive the vehicle with caution. The vehicle will not be able to maintain high-speed operation and the engine will run rough. Remember that the engine is capable of completely shutting down automatically to prevent engine damage, therefore:

1. Pull off the road as soon as safely possible and turn off the engine.
2. Arrange for the vehicle to be taken to a service facility.
3. If this is not possible, wait a short period for the engine to cool.
4. Check the coolant level and replenish if low.

## Maintenance and care



Never remove the coolant reservoir cap while the engine is running or hot.

5. Re-start the engine and take your vehicle to a service facility.



Driving the vehicle without repairing the engine problem increases the chance of engine damage. Take your vehicle to a service facility as soon as possible.

### CHECKING AND ADDING POWER STEERING FLUID

Check the power steering fluid. Refer to the scheduled maintenance guide for the service interval schedules. If adding fluid is necessary, use only MERCON® ATF.

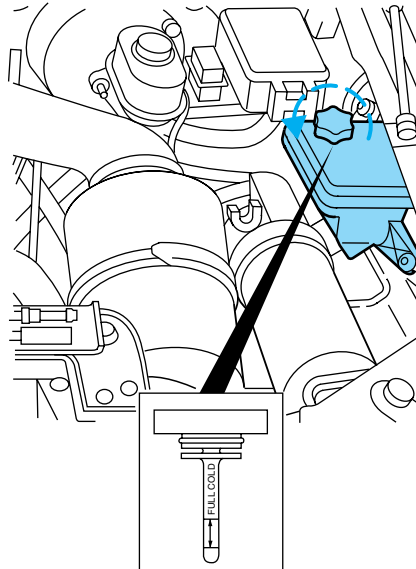

Check the fluid level when it is at ambient temperature, 20° – 80° F (-7° – 25° C):

1. Check the fluid level on the dipstick. It should be between the arrows in the FULL COLD range. Do not add fluid if the level is within this range.
2. If the fluid level is low, start the engine.

## Maintenance and care

3. While the engine idles, turn the steering wheel left and right several times.
4. Turn the engine off.
5. Recheck the fluid level on the dipstick. Do not add fluid if the level is between the arrows in the FULL COLD range.
6. If the fluid is low, add fluid in small amounts, continuously checking the level until it reaches the FULL COLD range. Be sure to put the dipstick back in the reservoir.

### TRANSMISSION FLUID

#### Checking automatic transmission fluid

Refer to your scheduled maintenance guide for scheduled intervals for fluid checks and changes. Your transmission does not consume fluid. However, the fluid level should be checked if the transmission is not working properly, i.e., if the transmission slips or shifts slowly or if you notice some sign of fluid leakage.

Automatic transmission fluid expands when warmed. To obtain an accurate fluid check, drive the vehicle until it is at normal operating temperature (approximately 30 km [20 miles]). If your vehicle has been operated for an extended period at high speeds, in city traffic during hot weather or pulling a trailer, the vehicle should be turned off for about 30 minutes to allow fluid to cool before checking.

1. Drive the vehicle 30 km (20 miles) or until it reaches normal operating temperature.
2. Park the vehicle on a level surface and engage the parking brake.
3. With the parking brake engaged and your foot on the brake pedal, start the engine and move the gearshift lever through all of the gear ranges. Allow sufficient time for each gear to engage.
4. Latch the gearshift lever in P (Park) and leave the engine running.
5. Remove the dipstick, wiping it clean with a clean, dry lint free rag. If necessary, refer to *Identifying components in the engine compartment* in this chapter for the location of the dipstick.
6. Install the dipstick making sure it is fully seated in the filler tube.
7. Remove the dipstick and inspect the fluid level. The fluid should be in the designated area for normal operating temperature or ambient temperature.

## Maintenance and care

### Low fluid level

Do not drive the vehicle if the fluid level is at the bottom of the dipstick and the ambient temperature is above 10°C (50°F).

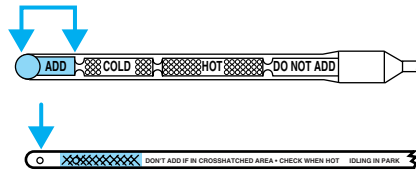

### Correct fluid level

The transmission fluid should be checked at normal operating temperature 66°C-77°C (150°F-170°F) on a level surface. The normal operating temperature can be reached after approximately 30 km (20 miles) of driving.

You can check the fluid without driving if the ambient temperature is above 10°C (50°F). However, if fluid is added at this time, an overfill condition could result when the vehicle reaches normal operating temperature.

The transmission fluid should be in this range if at normal operating temperature (66°C-77°C [150°F-170°F]).

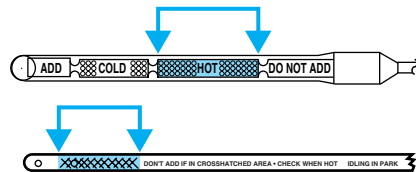

The transmission fluid should be in this range if at ambient temperature (10°C-35°C [50°F-95°F]).

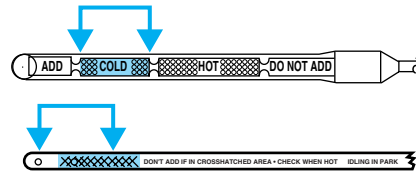

### High fluid level

Fluid levels above the safe range may result in transmission failure. An overfill condition of transmission fluid may cause shift and/or engagement concerns and/or possible damage.

High fluid levels can be caused by an overheating condition.

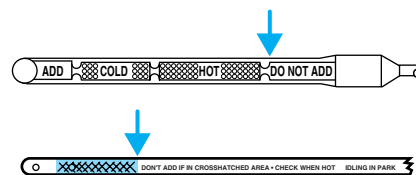

## Maintenance and care

### **Adjusting automatic transmission fluid levels**

Before adding any fluid, make sure the correct type is used. The type of fluid used is normally indicated on the dipstick and also in the *Lubricant specifications* section in the *Capacities and specifications* chapter.

**Use of a non-approved automatic transmission fluid may cause internal transmission component damage.**

If necessary, add fluid in 250 mL (1/2 pint) increments through the filler tube until the level is correct.

If an overfill occurs, excess fluid should be removed by a qualified technician.

**An overfill condition of transmission fluid may cause shift and/or engagement concerns and/or possible damage.**

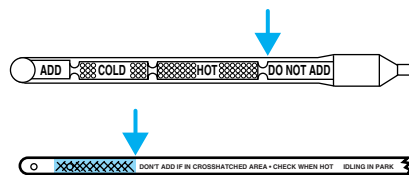

### **Checking and adding transfer case fluid (if equipped)**

1. Clean the filler plug.
2. Remove the filler plug and inspect the fluid level.

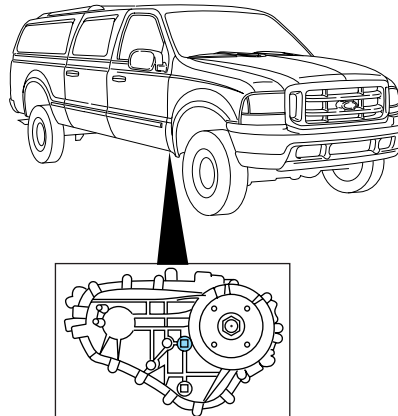

## Maintenance and care

3. Add only enough fluid through the filler opening so that the fluid level is at the bottom of the opening.

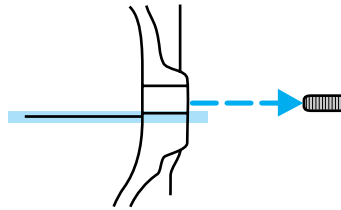

Use only fluid that meets Ford specifications. Refer to the *Capacities and specifications* chapter.

### **BATTERY**

Your vehicle is equipped with a Motorcraft maintenance-free battery which normally does not require additional water during its life of service.

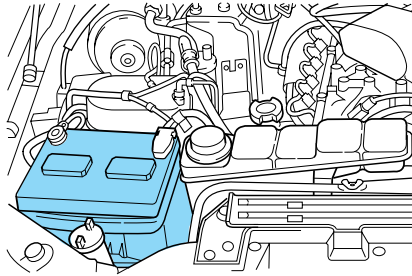

However, for severe usage or in high temperature climates, check the battery electrolyte level. Refer to the scheduled maintenance guide for the service interval schedules.

**Keep the electrolyte level in each cell up to the “level indicator”. Do not overfill the battery cells.**

If the electrolyte level in the battery is low, you can add plain tap water to the battery, as long as you do not use hard water (water with a high mineral or alkali content). If possible, however, try to only fill the battery cells with distilled water. If the battery needs water often, have the charging system checked.

**If your battery has a cover/shield, make sure it is reinstalled after the battery has been cleaned or replaced.**

## Maintenance and care

For longer, trouble-free operation, keep the top of the battery clean and dry. Also, make certain the battery cables are always tightly fastened to the battery terminals.

If you see any corrosion on the battery or terminals, remove the cables from the terminals and clean with a wire brush. You can neutralize the acid with a solution of baking soda and water.

When the battery is disconnected or a new battery installed, the transmission must learn its adaptive strategy. As a result of this, the transmission may shift firmly. This operation is considered normal and will fully update transmission operation to its optimum shift feel.



Batteries normally produce explosive gases which can cause personal injury. Therefore, do not allow flames, sparks or lighted substances to come near the battery. When working near the battery, always shield your face and protect your eyes. Always provide proper ventilation.



When lifting a plastic-cased battery, excessive pressure on the end walls could cause acid to flow through the vent caps, resulting in personal injury and/or damage to the vehicle or battery. Lift the battery with a battery carrier or with your hands on opposite corners.



Keep batteries out of reach of children. Batteries contain sulfuric acid. Avoid contact with skin, eyes or clothing. Shield your eyes when working near the battery to protect against possible splashing of acid solution. In case of acid contact with skin or eyes, flush immediately with water for a minimum of 15 minutes and get prompt medical attention. If acid is swallowed, call a physician immediately.



Battery posts, terminals and related accessories contain lead and lead compounds. **Wash hands after handling.**

Because your vehicle's engine is electronically controlled by a computer, some control conditions are maintained by power from the battery. When the battery is disconnected or a new battery is installed, the engine must relearn its idle and fuel trim strategy for optimum driveability and performance. To begin this process:



## Maintenance and care

1. With the vehicle at a complete stop, set the parking brake.
2. Put the gearshift in P (Park), turn off all accessories and start the engine.
3. Run the engine until it reaches normal operating temperature.
4. Allow the engine to idle for at least one minute.
5. Turn the A/C on and allow the engine to idle for at least one minute.
6. With your foot on the brake pedal and with the A/C on, put the vehicle in D (Drive) and allow the engine to idle for at least one minute.
7. Drive the vehicle to complete the relearning process.
  - The vehicle may need to be driven 16 km (10 miles) or more to relearn the idle and fuel trim strategy.
  - **If you do not allow the engine to relearn its idle trim, the idle quality of your vehicle may be adversely affected until the idle trim is eventually relearned.**

If the battery has been disconnected or a new battery has been installed, the clock must be reset once the battery is reconnected.

- Always dispose of automotive batteries in a responsible manner. Follow your local authorized standards for disposal. Call your local authorized recycling center to find out more about recycling automotive batteries.

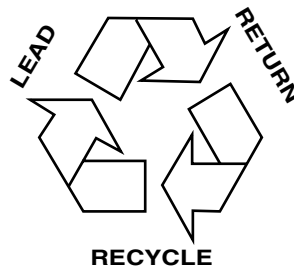

### AIR FILTER MAINTENANCE

Refer to the scheduled maintenance guide for the appropriate intervals for changing the air filter element.

When changing the air filter element, use only the Motorcraft air filter element listed. Refer to *Motorcraft Part Numbers* in the *Capacities and specifications* chapter.



Do not start your engine with the air cleaner removed and do not remove it while the engine is running.

## Maintenance and care

### Changing the air filter element

1. Loosen the clamp that secures the air filter element in place.

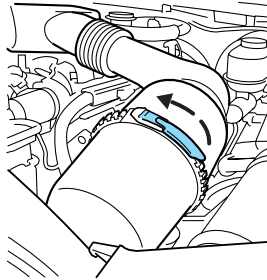

2. Carefully separate the two halves of the air filter housing.

3. Remove the air filter element from the open end of the air filter housing.

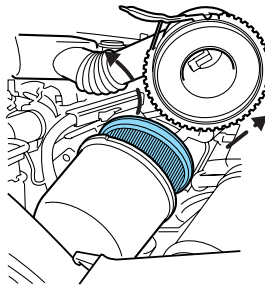

4. Install a new air filter element, ensuring the arrow on the top half of the air filter housing lines up with the notch on the bottom half of air filter housing. Be careful not to crimp the filter element edges between the air filter housing. This could cause filter damage and allow unmetered air to enter the engine if not properly seated.

5. Replace the two halves of the air filter housing and secure the clamp.

## Maintenance and care

### TRACTION-LOK AXLE (IF EQUIPPED)

This axle provides added traction on slippery surfaces, particularly when one wheel is on a poor traction surface. Under normal conditions, the Traction-Lok axle functions like a standard rear axle.

Extended use of other than the manufacturer's specified size tires on a Traction-Lok rear axle could result in a permanent reduction in effectiveness. This loss of effectiveness does not affect normal driving and should not be noticeable to the driver.



To avoid injury, never run the engine with one wheel off the ground, such as when changing a tire.

### WINDSHIELD WIPER BLADES

Check the wiper blades at least twice a year or when they seem less effective. Substances such as tree sap and some hot wax treatments used by commercial car washes reduce the effectiveness of wiper blades.

#### Checking the wiper blades

If the wiper blades do not wipe properly, clean both the windshield and wiper blades using undiluted windshield wiper solution or a mild detergent. Rinse thoroughly with clean water. To avoid damaging the blades, do not use fuel, kerosene, paint thinner or other solvents.

## Maintenance and care

### Changing the wiper blades

To replace the wiper blades:

1. Pull the wiper arm away from the windshield and lock into the service position.
2. Turn the blade at an angle from the wiper arm. Push the lock pin manually to release the blade and pull the wiper blade down toward the windshield to remove it from the arm.
3. Attach the new wiper to the wiper arm and press it into place until a click is heard.

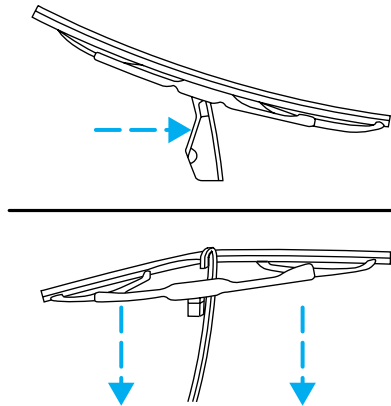

### REAR WINDOW WIPER BLADES

Refer to *Windshield Wiper Blades* in this section for more information on rear wiper blades.

### INFORMATION ABOUT UNIFORM TIRE QUALITY GRADING

New vehicles are fitted with tires that have a rating on them called Tire Quality Grades. The Quality grades can be found where applicable on the tire sidewall between tread shoulder and maximum section width. For example:

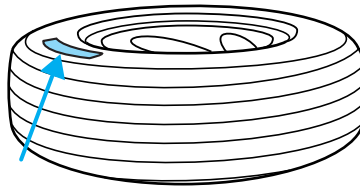

- **Treadwear 200 Traction AA Temperature A**

These Tire Quality Grades are determined by standards that the United States Department of Transportation has set.

Tire Quality Grades apply to new pneumatic tires for use on passenger cars. They do not apply to deep tread, winter-type snow tires, space-saver or temporary use spare tires, tires with nominal rim diameters of 10 to 12 inches or limited production tires as defined in Title 49 Code of Federal Regulations Part 575.104(c)(2).

## Maintenance and care

**U.S. Department of Transportation-Tire quality grades:** The U.S. Department of Transportation requires Ford to give you the following information about tire grades exactly as the government has written it.

### Treadwear

The treadwear grade is a comparative rating based on the wear rate of the tire when tested under controlled conditions on a specified government test course. For example, a tire graded 150 would wear one and one-half (1 1/2) times as well on the government course as a tire graded 100. The relative performance of tires depends upon the actual conditions of their use, however, and may depart significantly from the norm due to variations in driving habits, service practices, and differences in road characteristics and climate.

### Traction AA A B C

The traction grades, from highest to lowest are AA, A, B, and C. Those grades represent the tire's ability to stop on wet pavement as measured under controlled conditions on specified government test surfaces of asphalt and concrete. A tire marked C may have poor traction performance.



The traction grade assigned to this tire is based on straight-ahead braking traction tests, and does not include acceleration, cornering, hydroplaning or peak traction characteristics.

### Temperature A B C

The temperature grades are A (the highest), B, and C, representing the tire's resistance to the generation of heat and its ability to dissipate heat when tested under controlled conditions on a specified indoor laboratory test wheel. Sustained high temperature can cause the material of the tire to degenerate and reduce tire life, and excessive temperature can lead to sudden tire failure. The grade C corresponds to a level of performance which all passenger car tires must meet under the Federal Motor Vehicle Safety Standard No. 109. Grades B and A represent higher levels of performance on the laboratory test wheel than the minimum required by law.

## Maintenance and care



The temperature grade for this tire is established for a tire that is properly inflated and not overloaded. Excessive speed, underinflation, or excessive loading, either separately or in combination, can cause heat buildup and possible tire failure.

### SERVICING YOUR TIRES

#### Checking the tire pressure

- Use an accurate tire pressure gauge.
- Check the tire pressure when tires are cold, after the vehicle has been parked for at least one hour or has been driven less than 5 km (3 miles).
- Adjust tire pressure to recommended specifications found on the Certification Label.



Improperly inflated tires can affect vehicle handling and can fail suddenly, possibly resulting in loss of vehicle control.

#### Tire rotation

Because your vehicle's tires perform different jobs, they often wear differently. To make sure your tires wear evenly and last longer, rotate them as indicated in the scheduled maintenance guide. If you notice that the tires wear unevenly, have them checked.

- Four tire rotation

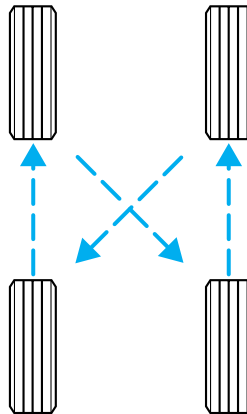

## Maintenance and care

- Five tire rotation

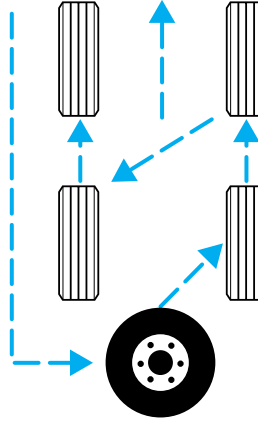

### Replacing the tires

Replace the tires when the wear band is visible through the tire treads.

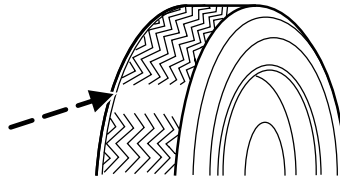

 When replacing full size tires, never mix radial bias-belted, or bias-type tires. Use only the tire sizes that are listed on the Certification Label. Make sure that all tires are the same size, speed rating, and load-carrying capacity. Use only the tire combinations recommended on the label. If you do not follow these precautions, your vehicle may not drive properly and safely.

 Make sure that all replacement tires are of the same size, type, load-carrying capacity and tread design (e.g., “All Terrain”, etc.), as originally offered by Ford.

## Maintenance and care



Do not replace your tires with “high performance” tires or larger size tires.



Failure to follow these precautions may adversely affect the handling of the vehicle and make it easier for the driver to lose control and roll over.

Tires that are larger or smaller than your vehicle’s original tires may also affect the accuracy of your speedometer.

### SNOW TIRES AND CHAINS



Snow tires must be the same size and grade as the tires you currently have on your vehicle.

The tires on your vehicle have all weather treads to provide traction in rain and snow. However, in some climates, you may need to use snow tires and chains. If you need to use chains, it is recommended that steel wheels (of the same size and specifications) be used as chains may chip aluminum wheels.

Follow these guidelines when using snow tires and chains:

- Use only SAE Class S chains.
- Install chains securely, verifying that the chains do not touch any wiring, brake lines or fuel lines.
- Drive cautiously. If you hear the chains rub or bang against your vehicle, stop and re-tighten the chains. If this does not work, remove the chains to prevent damage to your vehicle.
- If possible, avoid fully loading your vehicle.
- Remove the tire chains when they are no longer needed. Do not use tire chains on dry roads.
- The suspension insulation and bumpers will help prevent vehicle damage. Do not remove these components from your vehicle when using snow tires and chains.



## Maintenance and care

### WHAT YOU SHOULD KNOW ABOUT AUTOMOTIVE FUELS

#### Important safety precautions



Do not overfill the fuel tank. The pressure in an overfilled tank may cause leakage and lead to fuel spray and fire.



The fuel system may be under pressure. If the fuel filler cap is venting vapor or if you hear a hissing sound, wait until it stops before completely removing the fuel filler cap. Otherwise, fuel may spray out and injure you or others.



If you do not use the proper fuel filler cap, excessive pressure or vacuum in the fuel tank may damage the fuel system or cause the fuel cap to disengage in a collision, which may result in possible personal injury.



Automotive fuels can cause serious injury or death if misused or mishandled.



Gasoline may contain benzene, which is a cancer-causing agent.

Observe the following guidelines when handling automotive fuel:

- Extinguish all smoking materials and any open flames before fueling your vehicle.
- Always turn off the vehicle before fueling.
- Automotive fuels can be harmful or fatal if swallowed. Fuel such as gasoline is highly toxic and if swallowed can cause death or permanent injury. If fuel is swallowed, call a physician immediately, even if no symptoms are immediately apparent. The toxic effects of fuel may not be visible for hours.



## Maintenance and care

- Avoid inhaling fuel vapors. Inhaling too much fuel vapor of any kind can lead to eye and respiratory tract irritation. In severe cases, excessive or prolonged breathing of fuel vapor can cause serious illness and permanent injury.
- Avoid getting fuel liquid in your eyes. If fuel is splashed in the eyes, remove contact lenses (if worn), flush with water for 15 minutes and seek medical attention. Failure to seek proper medical attention could lead to permanent injury.
- Fuels can also be harmful if absorbed through the skin. If fuel is splashed on the skin and/or clothing, promptly remove contaminated clothing and wash skin thoroughly with soap and water. Repeated or prolonged skin contact with fuel liquid or vapor causes skin irritation.
- Be particularly careful if you are taking “Antabuse” or other forms of disulfiram for the treatment of alcoholism. Breathing gasoline vapors, or skin contact could cause an adverse reaction. In sensitive individuals, serious personal injury or sickness may result. If fuel is splashed on the skin, promptly wash skin thoroughly with soap and water. Consult a physician immediately if you experience an adverse reaction.



When refueling always shut the engine off and never allow sparks or open flames near the filler neck. Never smoke while refueling. Fuel vapor is extremely hazardous under certain conditions. Care should be taken to avoid inhaling excess fumes.



The flow of fuel through a fuel pump nozzle can produce static electricity, which can cause a fire if fuel is pumped into an ungrounded fuel container.

Use the following guidelines to avoid static build-up when filling an ungrounded fuel container:

- Place approved fuel container on the ground.
- DO NOT fill a fuel container while it is in the vehicle.
- Keep the fuel pump nozzle in contact with the fuel container while filling.
- DO NOT use a device that would hold the fuel pump handle in the fill position.

## Maintenance and care

### Choosing the right fuel

Use only UNLEADED FUEL. The use of leaded fuel is prohibited by law and could damage your vehicle.

Do not use fuel containing methanol. It can damage critical fuel system components.

Your vehicle was not designed to use fuel or fuel additives with metallic compounds, including manganese-based compounds containing MMT.

Repairs to correct the effects of using a fuel for which your vehicle was not designed may not be covered by your warranty.

### Octane recommendations

Your vehicle is designed to use “Regular” unleaded gasoline with tank (R+M)/2 octane rating of 87.

We do not recommend the use of gasolines labeled as “Regular” that

are sold with octane ratings of 86 or lower in high altitude areas.

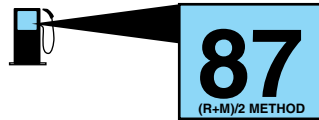

Do not be concerned if your engine sometimes knocks lightly. However, if it knocks heavily under most driving conditions while you are using fuel with the recommended octane rating, see your dealer or a qualified service technician to prevent any engine damage.

### Fuel quality

If you are experiencing starting, rough idle or hesitation driveability problems during a cold start, try a different brand of “Regular” unleaded gasoline. “Premium” unleaded gasoline is not recommended (particularly in the United States) because it may cause these problems to become more pronounced. If the problems persist, see your dealer or a qualified service technician.

It should not be necessary to add any aftermarket products to your fuel tank if you continue to use high quality fuel of the recommended octane rating. Aftermarket products could cause damage to the fuel system. Repairs to correct the effects of using an aftermarket product in your fuel may not be covered by your warranty.

Many of the world’s automakers issued the World-wide Fuel Charter that recommends gasoline specifications to provide improved performance and emission control system protection for your vehicle. Gasolines that meet the World-wide Fuel Charter should be used when available. Ask

## Maintenance and care

your fuel supplier about gasolines that meet the World-wide Fuel Charter. In Canada, look for fuels that display the Automaker's Choice Logo.

### Cleaner air

Ford approves the use of reformulated "cleaner-burning" gasolines to improve air quality. These gasolines may contain oxygenates up to 10% ethanol or 15% MTBE.

### Running out of fuel

Avoid running out of fuel because this situation may have an adverse affect on powertrain components.

If you have run out of fuel:

- You may need to cycle the ignition from OFF to ON several times after refueling, to allow the fuel system to pump the fuel from the tank to the engine.
- Your "Service Engine Soon" indicator may come on. For more information on the "Service Engine Soon" indicator, refer to the *Instrumentation* chapter.

### Fuel Filler Cap

Your fuel tank filler cap has an indexed design with a 1/8 turn on/off feature.

When fueling your vehicle:

1. Turn the engine off.
2. Carefully turn the filler cap counterclockwise 1/8 of a turn until it stops.
3. Pull to remove the cap from the fuel filler pipe.
4. To install the cap, align the tabs on the cap with the notches on the filler pipe.
5. Turn the filler cap clockwise 1/8 of a turn until it stops.

If the "Service Engine Soon/Check Engine" indicator comes on and stays on after you start the engine, the fuel filler cap may not be properly installed. Turn off the engine, remove the fuel filler cap, align the cap properly and reinstall it.

**If you must replace the fuel filler cap, replace it with a fuel filler cap that is designed for your vehicle. The customer warranty may**

## Maintenance and care

**be void for any damage to the fuel tank or fuel system if the correct genuine Ford or Motorcraft fuel filler cap is not used.**



The fuel system may be under pressure. If the fuel filler cap is venting vapor or if you hear a hissing sound, wait until it stops before completely removing the fuel filler cap. Otherwise, fuel may spray out and injure you or others.



If you do not use the proper fuel filler cap, excessive pressure or vacuum in the fuel tank may damage the fuel system or cause the fuel cap to disengage in a collision, which may result in possible personal injury.

### Fuel Filter

For fuel filter replacement, see your dealer or a qualified service technician. Refer to the scheduled maintenance guide for the appropriate intervals for changing the fuel filter.

**Replace the fuel filter with an authorized Motorcraft part. The customer warranty may be void for any damage to the fuel system if an authorized Motorcraft fuel filter is not used.**

## ESSENTIALS OF GOOD FUEL ECONOMY

### Measuring techniques

Your best source of information about actual fuel economy is you, the driver. You must gather information as accurately and consistently as possible. Fuel expense, frequency of fillups or fuel gauge readings are NOT accurate as a measure of fuel economy. We do not recommend taking fuel economy measurements during the first 1 600 km (1 000 miles) of driving (engine break-in period). You will get a more accurate measurement after 3 000 km–5 000 km (2 000 miles–3 000 miles).

### Filling the tank

The advertised fuel capacity of the fuel tank on your vehicle is equal to the rated refill capacity of the fuel tank as listed in the *Refill Capacities* section of the *Capacities and specifications* chapter.

The advertised capacity is the amount of the indicated capacity and the empty reserve combined. Indicated capacity is the difference in the amount of fuel in a full tank and a tank when the fuel gauge indicates

## Maintenance and care

empty. Empty reserve is the small amount of usable fuel remaining in the fuel tank after the fuel gauge indicates empty.

**The amount of empty reserve varies and should not be relied upon to increase driving range. When refueling your vehicle after the fuel gauge indicates empty, you might not be able to refuel the full amount of the advertised capacity of the fuel tank due to the empty reserve still present in the tank.**

For consistent results when filling the fuel tank:

- Use the same filling rate setting (low — medium — high) each time the tank is filled.
- Allow three automatic click-offs when filling (more than three clicks would overflow the tank).
- Always use fuel with the recommended octane rating.
- Use a known quality gasoline, preferably a national brand.
- Use the same side of the same pump and have the vehicle facing the same direction each time you fill up.
- Have the vehicle loading and distribution the same every time.

Your results will be most accurate if your filling method is consistent.

### Calculating fuel economy

1. Fill the fuel tank completely and record the initial odometer reading (in kilometers or miles).
2. Each time you fill the tank, record the amount of fuel added (in liters or gallons).
3. After at least three to five tank fill-ups, fill the fuel tank and record the current odometer reading.
4. Subtract your initial odometer reading from the current odometer reading.
5. Follow one of the simple calculations in order to determine fuel economy:

**Multiply liters used by 100, then divide by total kilometers traveled.**

**Divide total miles traveled by total gallons used.**

Keep a record for at least one month and record the type of driving (city or highway). This will provide an accurate estimate of the vehicle's fuel

## Maintenance and care

economy under current driving conditions. Additionally, keeping records during summer and winter will show how temperature impacts fuel economy. In general, lower temperatures give lower fuel economy.

### **Driving style — good driving and fuel economy habits**

Give consideration to the lists that follow and you may be able to change a number of variables and improve your fuel economy.

#### ***Habits***

- Smooth, moderate operation can yield up to 10% savings in fuel.
- Steady speeds without stopping will usually give the best fuel economy.
- Idling for long periods of time (greater than one minute) may waste fuel.
- Anticipate stopping; slowing down may eliminate the need to stop.
- Sudden or hard accelerations may reduce fuel economy.
- Slow down gradually.
- Driving at reasonable speeds (traveling at 88 km/h [55 mph] uses 15% less fuel than traveling at 105 km/h [65 mph]).
- Revving the engine before turning it off may reduce fuel economy.
- Using the air conditioner or defroster may reduce fuel economy.
- You may want to turn off the speed control in hilly terrain if unnecessary shifting between third and fourth gear occurs. Unnecessary shifting of this type could result in reduced fuel economy.
- Warming up a vehicle on cold mornings is not required and may reduce fuel economy.
- Resting your foot on the brake pedal while driving may reduce fuel economy.
- Combine errands and minimize stop-and-go driving.

#### ***Maintenance***

- Keep tires properly inflated and use only recommended size.
- Operating a vehicle with the wheels out of alignment will reduce fuel economy.
- Use recommended engine oil. Refer to *Lubricant Specifications*.

## Maintenance and care

- Perform all regularly scheduled maintenance items. Follow the recommended maintenance schedule and owner maintenance checks found in your vehicle scheduled maintenance guide.

### **Conditions**

- Heavily loading a vehicle or towing a trailer may reduce fuel economy at any speed.
- Carrying unnecessary weight may reduce fuel economy (approximately 0.4 km/L [1 mpg] is lost for every 180 kg [400 lb] of weight carried).
- Adding certain accessories to your vehicle (for example bug deflectors, rollbars/light bars, running boards, ski/luggage racks) may reduce fuel economy.
- Using fuel blended with alcohol may lower fuel economy.
- Fuel economy may decrease with lower temperatures during the first 12–16 km (8–10 miles) of driving.
- Driving on flat terrain offers improved fuel economy as compared to driving on hilly terrain.
- Transmissions give their best fuel economy when operated in the top cruise gear and with steady pressure on the gas pedal.
- Four-wheel-drive operation (if equipped) is less fuel efficient than two-wheel-drive operation.
- Close windows for high speed driving.

### **EPA window sticker**

Every new vehicle should have the EPA window sticker. Contact your dealer if the window sticker is not supplied with your vehicle. The EPA window sticker should be your guide for the fuel economy comparisons with other vehicles.

It is important to note the box in the lower left corner of the window sticker. These numbers represent the Range of L/100 km (MPG) expected on the vehicle under optimum conditions. Your fuel economy may vary depending upon the method of operation and conditions.

### **EMISSION CONTROL SYSTEM**

Your vehicle is equipped with various emission control components and a catalytic converter which will enable your vehicle to comply with applicable exhaust emission standards. To make sure that the catalytic



## Maintenance and care

converter and other emission control components continue to work properly:

- Use only the specified fuel listed.
- Avoid running out of fuel.
- Do not turn off the ignition while your vehicle is moving, especially at high speeds.
- Have the items listed in your scheduled maintenance guide performed according to the specified schedule.

The scheduled maintenance items listed in the scheduled maintenance guide are essential to the life and performance of your vehicle and to its emissions system.

If other than Ford, Motorcraft or Ford-authorized parts are used for maintenance replacements or for service of components affecting emission control, such non-Ford parts should be equivalent to genuine Ford Motor Company parts in performance and durability.



Do not park, idle, or drive your vehicle in dry grass or other dry ground cover. The emission system heats up the engine compartment and exhaust system, which can start a fire.

Illumination of the “Service Engine Soon” light, charging system warning light or the temperature warning light, fluid leaks, strange odors, smoke or loss of engine power, could indicate that the emission control system is not working properly.



Exhaust leaks may result in entry of harmful and potentially lethal fumes into the passenger compartment.

Do not make any unauthorized changes to your vehicle or engine. By law, vehicle owners and anyone who manufactures, repairs, services, sells, leases, trades vehicles, or supervises a fleet of vehicles are not permitted to intentionally remove an emission control device or prevent it from working. Information about your vehicle’s emission system is on the Vehicle Emission Control Information Decal located on or near the engine. This decal identifies engine displacement and gives some tune up specifications.

Please consult your “Warranty Guide” for complete emission warranty information.

## Maintenance and care

### Readiness for Inspection/Maintenance (I/M) testing

In some localities, it may be a legal requirement to pass an I/M test of the on-board diagnostics system. If your “Check Engine/Service Engine Soon” light is on, refer to the description in the *Warning Lights and Chimes* section of the *Instrumentation* chapter. Your vehicle may not pass the I/M test with the “Check Engine/Service Engine Soon” light on.

If the vehicle’s powertrain system or its battery has just been serviced, the on-board diagnostics system is reset to a “not ready for I/M test” condition. To ready the on-board diagnostics system for I/M testing, a minimum of 30 minutes of city and highway driving is necessary as described below:

- First, at least 10 minutes of driving on an expressway or highway.
- Next, at least 20 minutes driving in stop-and-go, city-type traffic with at least four idle periods.

Allow the vehicle to sit for at least eight hours without starting the engine. Then, start the engine and complete the above driving cycle. The engine must warm up to its normal operating temperature. Once started, do not turn off the engine until the above driving cycle is complete.

### BULBS

#### Replacing exterior bulbs

Check the operation of the following lamps frequently:

- Headlamps
- High-mount brakelamp
- Brakelamps
- Turn signals
- License plate lamp
- Tail lamps
- Back-up lamps

Do not remove lamp bulbs unless they can be replaced immediately with new ones. If a bulb is removed for an extended period of time, contaminants may enter the lamp housings and affect lamp performance.

## Maintenance and care

### Replacing headlamp bulbs

1. Make sure that the headlamp control is in the OFF position.
2. Open the hood.
3. Disconnect the electrical connector from the bulb by pulling rearward.
4. Remove bulb retainer ring by turning it counterclockwise about  $\frac{1}{4}$  turn, then slide the ring off the plastic base.
5. Without turning, carefully pull bulb out of headlamp assembly.

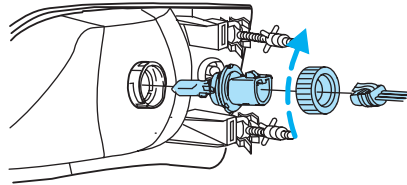

 Handle a halogen headlamp bulb carefully and keep out of children's reach. Grasp the bulb only by its plastic base and do not touch the glass. The oil from your hand could cause the bulb to break the next time the headlamps are operated.

6. Insert the glass end of the new bulb into the headlamp assembly. When the grooves in the plastic base are aligned, push the bulb into the lamp assembly until the plastic base contacts the rear of the lamp assembly.
7. Install bulb retaining ring over the plastic base and lock the ring into the socket by turning it clockwise until you feel a "stop."
8. Connect the electrical connector into the rear of the plastic base until it "snaps."

### Replacing front parking/turn signal bulbs

1. Make sure headlamp switch is in OFF position.
2. Open the hood.

## Maintenance and care

3. Remove the two screws and carefully disengage parking lamp/turn signal assembly from the vehicle.

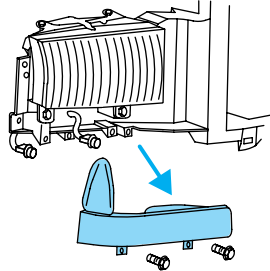

4. Rotate bulb socket counterclockwise about  $\frac{1}{4}$  turn and remove from lamp assembly.

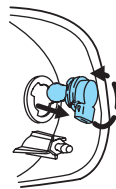

5. Carefully pull bulb straight out of the socket and push in the new bulb.

6. Install the bulb socket in lamp assembly by turning clockwise.

7. Align the lamp assembly on the vehicle.

8. Install two screws on parking lamp/turn signal assembly.

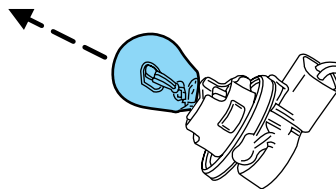

## Maintenance and care

### **Replacing tail lamp/turn/backup lamp bulbs**

The tail lamp/turn/backup lamp bulbs are located in the same portion of the tail lamp assembly, one just below the other. Follow the same steps to replace either bulb:

1. Remove the four screws and the lamp assembly from vehicle.

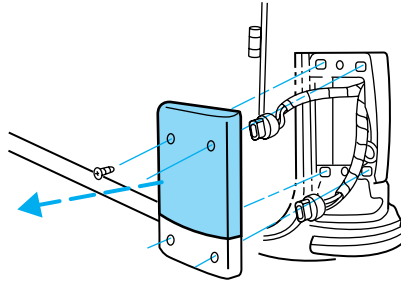

2. Rotate bulb socket counterclockwise about ¼ turn and remove from lamp assembly.

3. Carefully pull the bulb straight out of the socket and push in the new bulb.

4. Install the bulb socket in lamp assembly by turning clockwise.

5. Install the lamp assembly and secure with four screws.

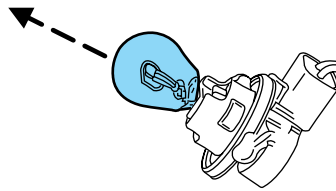

### **Replacing high-mount brakelamp bulbs**

To remove the brakelamp assembly:

1. Remove the two screws and lamp assembly from vehicle.

2. Remove the bulb socket from lamp assembly by rotating it 45 degrees.

3. Carefully pull bulb straight out of socket and push in the new bulb.

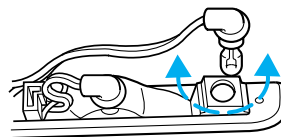
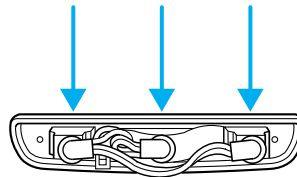

## Maintenance and care

To install the brakelamp assembly:

1. Install the bulb socket into the lamp assembly and rotate 45 degrees.
2. Install the lamp assembly on the vehicle and secure with two screws.

### **Replacing license plate lamp bulbs**

The license plate bulbs are located behind the rear bumper. To change the license plate lamp bulbs:

1. Reach behind the rear bumper to locate the bulb socket.
2. Twist the socket counterclockwise and remove.
3. Pull out the old bulb from socket and push in the new bulb.
4. Install the bulb socket in lamp assembly by turning it clockwise.

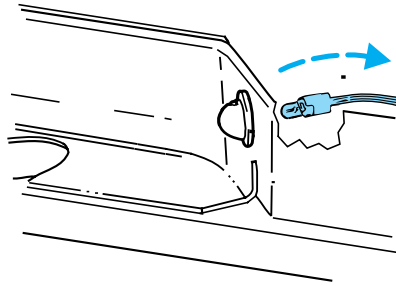

### **Interior bulbs**

Check the operation of the following interior bulbs frequently:

- dome lamps
- map lamps
- second row reading lamps
- third row reading lamp

For bulb replacement, see a qualified service technician or your dealer.

### **USING THE RIGHT BULBS**

Replacement bulbs are specified in the chart below. Headlamp bulbs must be marked with an authorized "D.O.T." for North America and an "E" for Europe to assure lamp performance, light brightness and pattern and safe visibility. The correct bulbs will not damage the lamp assembly or void the lamp assembly warranty and will provide quality bulb burn time.

## Maintenance and care

Function	Number of bulbs	Trade number
Headlamps	2	9007
Park/turn lamp	2	3157
Sidemarkers lamp	2	194
Tail/stop lamp	2	3157 K
Turn lamp (rear)	2	3156K
Backup lamp	2	3156K
High-mount brakelamp	3	912
Rear dome lamp	1	921
Map/dome lamp	2	578
Second row reading lamp	2	578
Third row reading lamp	2	211-2
License lamp	2	168
All replacement bulbs are clear in color except where noted.		
To replace all instrument panel lights - see your dealer		

### AIMING THE HEADLAMPS

The headlamps on your vehicle are properly aimed at the assembly plant. If your vehicle has been in an accident the alignment of your headlamps should be checked by a qualified service technician.

### CLEANING AND CARING FOR YOUR VEHICLE

Refer to the Customer Assistance chapter for a list of Ford-approved cleaners, polishes and waxes.

## Maintenance and care

### Washing your vehicle

Wash your vehicle regularly with cold or lukewarm water. Never use strong detergents or soap. If your vehicle is particularly dirty, use a quality car wash detergent. Always use a clean sponge, washing glove or similar device and plenty of water for best results. To avoid spots, avoid washing when the hood is still warm, immediately after or during exposure to strong sunlight.

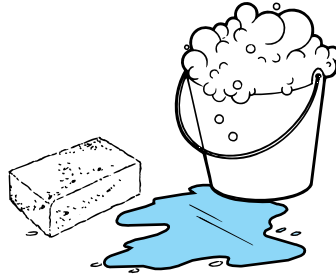

During winter months, it is especially important to wash the vehicle on a regular basis. Large quantities of dirt and road salt are difficult to remove and also cause damage to the vehicle.

Any gasoline spilled on the vehicle or deposits such as bird droppings should be washed and sponged off as soon as possible. Deposits not removed promptly can cause damage to the vehicle's paintwork.

Remove any exterior accessories (such as antennas) and fold in the side view mirrors before entering a car wash. If you have wax applied to the vehicle at a commercial car wash, it is recommended that you clean the wiper blades and windshield as described in *Cleaning the wiper blades and windshield*.

After washing, apply the brakes several times to dry them.

### Waxing your vehicle

Waxing your vehicle on a regular basis will reduce minor scratches and paint damage.

Wax when water stops beading on the surface. This could be every three or four months, depending on operating conditions.

Use only carnauba or synthetic-based waxes. Use a cleaning fluid with a clean cloth to remove any bugs before waxing your vehicle. Use tar remover to remove any tar spots.

Avoid getting wax on the windshield, or on any surfaces which appear coarse or bumpy. If you have wax applied at a commercial car wash, it is recommended that you clean the wiper blades and windshield as described in *Cleaning the wiper blades and windshield*.



## Maintenance and care

### Repairing paint chips

Minor scratches or paint damage from road debris may be repaired with the Ultra Touch Prep and Finishing Kit (#F7AZ-19K507-BA), Lacquer Touch-up Paint (#ALBZ-19500-XXXXA), or Exterior Acrylic Spray Lacquer (#ALAZ-19500-XXXXA) from the Ford Car Care Chemicals line. Please note that the part numbers (shown as XXXX above) will vary with your vehicle's specific coloring. Observe the application instructions on the products.

Remove particles such as bird droppings, tree sap, insect remains, tar spots, road salt and industrial fallout immediately.

### Cleaning the wheels

Wash with the same detergent as the body of your vehicle. Do not use acid-based or alcohol-based wheel cleaners, steel wool, fuel or strong detergents. Never use abrasives that will damage the finish of special wheel surfaces. Use a tar remover to remove grease and tar.

The brushes used in some automatic car washes may damage the finish on your wheels. Before going to a car wash, find out if the brushes are abrasive.

### Cleaning the engine

Engines are more efficient when they are clean because grease and dirt buildup keep the engine warmer than normal. When washing:

- Take care when using a power washer to clean the engine. The high pressure fluid could penetrate the sealed parts and cause damage.
- Do not spray with cold water to avoid cracking the engine block or other engine components.
- Never wash or rinse the engine while it is running; water in the running engine may cause internal damage.

### Cleaning non-painted plastic exterior parts

Use vinyl cleaner for routine cleaning. Clean with a tar remover if necessary. Do not clean plastic parts with thinners, solvents or petroleum-based cleaners.

## Maintenance and care

### Cleaning the exterior lamps

Wash with the same detergent as the exterior of your vehicle. If necessary, use a tar remover such as Ford Extra Strength Tar and Road Oil Remover (B7A-19520-AA).

To avoid scratching the lamps, do not use a dry paper towel, chemical solvents or abrasive cleaners.

### Cleaning the wiper blades, windshield and rear window

If the wiper blades do not wipe properly, clean the wiper blade rubber element with undiluted windshield washer solution or a mild detergent. To avoid damaging the blades, do not use fuel, kerosene, paint thinner or other solvents.

If the wiper still does not wipe properly, this could be caused by substances on the windshield or rear window such as tree sap and some hot wax treatments used by commercial car washes. Clean the outside of the windshield or rear window with a non-abrasive cleaner such as Ford Ultra-Clear Spray Glass Cleaner, (E4AZ-19C507-AA), available from your Ford Dealer. **Do not** use abrasive cleansers on glass as they may cause scratches. The windshield or rear window is clean if beads do not form when you rinse it with water. The windshield, rear window and wiper blades should be cleaned on a regular basis, and blades or rubber elements replaced when worn.

### Cleaning the instrument panel

Clean with a damp cloth, then dry with a dry cloth.

Avoid cleaner or polish that increases the gloss of the upper portion of the instrument panel. The dull finish in this area helps protect the driver from undesirable windshield reflection.



Do not use chemical solvents or strong detergents when cleaning the steering wheel or instrument panel to avoid contamination of the air bag system.

### Cleaning the instrument cluster lens

Clean with a damp cloth, then dry with a dry cloth.

Do not use household or glass cleaners as these may damage the lens.

## Maintenance and care

### **Cleaning the interior fabric**

Remove dust and loose dirt with a whisk broom or a vacuum cleaner. Remove fresh spots immediately. Do not use household or glass cleaners. These agents can stain and discolor the fabric. Use a mild soap and water solution if necessary.

### **Cleaning and maintaining the safety belts**

Clean the safety belts with a mild soap solution recommended for cleaning upholstery or carpets. Do not bleach or dye the belts, because these actions may weaken the belt webbing.

Check the safety belt system periodically to make sure there are no nicks, wear or cuts. If your vehicle has been involved in an accident, refer to the *Safety belt maintenance* section in the *Seating and safety restraints* chapter.

### **Cleaning leather seats (if equipped)**

To clean, simply use a soft cloth dampened with water and a mild soap. Wipe the leather again with a damp cloth to remove soap residue. Dry with a soft cloth. For tougher soiling concerns, Ford recommends using the Deluxe Leather Care Kit F8AZ-19G253-AA, which is available from your Ford Dealer. This mild cleaner and special pad, cleans the leather and maintains its natural beauty. Follow the instructions on the cleaner label. Regular cleaning of your leather upholstery helps maintain its resiliency and color.

**Do not use household cleaning products, alcohol solutions, solvents or cleaners intended for rubber, vinyl or plastics.**

## Capacities and specifications

### MOTORCRAFT PART NUMBERS

Component*	5.4L V8 engine	6.8L V10 engine
Air filter element	FA-1634	FA-1634
Fuel filter	FG-986B	FG-986B
Oil filter	FL-820-S	FL-820-S
PCV valve	EV-233	EV-233
Battery	BXT-65-750	BXT-65-750
Spark plugs-platinum**	AWSF-22E	AWSF-22E

\*Refer to the *7.3 Liter Power Stroke Direct Injection Turbo Diesel Owner's Guide Supplement* for Motorcraft diesel engine service part numbers.

\*\*Refer to Vehicle Emissions Control Information (VECI) decal for spark plug gap information.

### REFILL CAPACITIES

Fluid	Ford Part Name	Application	Capacity
Front axle	Motorcraft SAE 75W-90 Premium 4x4 Front Axle Lubricant	4X4 vehicles	1.8L (3.8 pints)
Rear axle <sup>1</sup>	Motorcraft SAE 75W-140 Synthetic Rear Axle Lubricant	All	3.3L (6.9 pints) <sup>2</sup>
Brake fluid	High Performance DOT 3 Motor Vehicle Brake Fluid	All	Fill to line on reservoir
Engine coolant- Gasoline engines <sup>3</sup>	Premium Engine Coolant	5.4L V8 engine	25L (26.4 quarts) <sup>4</sup>
		6.8L V10 engine	27.0L (28.5 quarts) <sup>4</sup>

## Capacities and specifications

Fluid	Ford Part Name	Application	Capacity
Engine coolant-Diesel engine	Refer to your 7.3L Diesel Supplement		
Engine oil (includes filter change)-Gasoline engines	Motorcraft SAE 5W-30 Super Premium Motor Oil	All	5.7L (6.0 quarts)
Engine oil (includes filter change)-Diesel engine	Refer to your 7.3L Diesel Supplement		
Fuel tank	N/A	All	166.6L (44.0 gallons)
Power steering fluid	Motorcraft MERCON® ATF	All	Fill to line on dipstick
Transfer case fluid (if equipped)	Motorcraft MERCON® ATF	4x4 vehicles	1.9L (2.0 quarts)
Transmission fluid <sup>5</sup>	Motorcraft MERCON® ATF	4x2 vehicles	16.1L (17.1 quarts) <sup>6</sup>
		4x4 vehicles	16.7L (17.7 quarts) <sup>6</sup>
Windshield washer fluid	Ultra-Clear Windshield Washer Concentrate	All	4.2L (1.1 gallons)

<sup>1</sup> Your vehicle's rear axle is filled with a synthetic lubricant. Axle lubricant quantities should not need to be checked unless a leak is suspected, service is required or the axle assembly has been submerged in water. The axle lubricant should be changed any time the rear axle has been submerged in water.

<sup>2</sup> Add 236 ml (8 oz.) of Additive Friction Modifier C8AZ-19B546-A or equivalent meeting Ford Specification EST-M2C118-A for complete refill of Traction-Lok axles.

## Capacities and specifications

Service refill capacities are determined by filling the rear axle to the bottom of the filler hole with the specified lubricant.

<sup>3</sup> Use Ford Premium Engine Coolant (green in color). DO NOT USE Ford Extended Life Engine Coolant (orange in color). Refer to *Adding engine coolant, in the Maintenance and Care chapter*.

<sup>4</sup> If equipped with auxiliary rear heater, add an additional 1.4 L (1.5 quarts).

<sup>5</sup> Ensure the correct automatic transmission fluid is used. Transmission fluid requirements are indicated on the dipstick or on the dipstick handle. Check the container to verify the fluid being added is of the correct type. Refer to your scheduled maintenance guide to determine the correct service interval.

Some transmission fluids may be labeled as dual usage, such as MERCON® and MERCON® V. These dual usage fluids are not to be used in an automatic transmission that requires use of the MERCON® type fluid. However, these dual usage fluids may be used in transmissions that require the MERCON® V type fluid.

**MERCON® and MERCON® V type fluids are not interchangeable. DO NOT mix MERCON® and MERCON® V. Use of a transmission fluid that indicates dual usage (MERCON® and MERCON® V) in an automatic transmission application requiring MERCON® may cause transmission damage. Use of any fluid other than the recommended fluid may cause transmission damage.**

<sup>6</sup> Indicates only approximate dry-fill capacity. Some applications may vary based on cooler size and if equipped with an in-tank cooler. The amount of transmission fluid and fluid level should be set by the indication on the dipstick's normal operating range.

## Capacities and specifications

### LUBRICANT SPECIFICATIONS

Item	Ford part name or equivalent	Ford part number	Ford specification
Front axle	Motorcraft SAE 75W-90 Premium 4x4 Front Axle Lubricant	XY-75W90-TQL	WSP-M2C201-A
Rear axle <sup>1</sup>	Motorcraft SAE 75W-140 High Performance Synthetic Rear Axle Lubricant	F1TZ-19580-B	WSL-M2C192-A
Brake fluid	High Performance DOT 3 Motor Vehicle Brake Fluid	C6AZ-19542-AB	ESA-M6C25-A and DOT 3
Engine coolant-Gasoline engines	Ford Premium Engine Coolant	E2FZ-19549-AA (in Canada, Motorcraft CXC-8-B)	ESE-M97B44-A
Engine coolant-Diesel engine	Refer to your 7.3L Diesel Supplement		
Engine oil-Gasoline engines	Motorcraft SAE 5W-30 Super Premium Motor Oil	XO-5W20-QSP	WSS-M2C153-G and API Certification Mark
Engine oil-Diesel engine	Refer to your 7.3L Diesel Supplement		

## Capacities and specifications

Item	Ford part name or equivalent	Ford part number	Ford specification
Hinges, latches, striker plates, fuel filler door hinge and seat tracks	Multi-Purpose Grease	DOAZ-19584-AA or F5AZ-19G209-AA	ESB-M1C93-B or ESR-M1C159-A
Transmission /steering/parking brake linkages and pivots, brake pedal shaft	Premium Long-Life Grease	XG-1-C or XG-1-K	ESA-M1C75-B
Power steering fluid and transfer case fluid (if equipped)	Motorcraft MERCON® ATF	XT-2-QDX	MERCON®
Automatic transmission <sup>2</sup>	Motorcraft MERCON® ATF	XT-2-QDX	MERCON®
Windshield washer fluid	Ultra-clear Windshield Washer Concentrate	C9AZ-19550-AC	ESR-M17P5-A

<sup>1</sup> Add 236 ml (8 oz.) of Additive Friction Modifier C8AZ-19B546-A or equivalent meeting Ford specification EST-M2C118-A for complete refill of Traction-Lok axles. Ford design rear axles contain a synthetic lubricant that does not require changing unless the axle has been submerged in water.

<sup>2</sup> Ensure the correct automatic transmission fluid is used. Transmission fluid requirements are indicated on the dipstick or on the dipstick handle. Check the container to verify the fluid being added is of the correct type. Refer to your scheduled maintenance guide to determine the correct service interval.



## Capacities and specifications

Some transmission fluids may be labeled as dual usage, such as MERCON® and MERCON® V. These dual usage fluids are not to be used in an automatic transmission that requires use of the MERCON® type fluid. However, these dual usage fluids may be used in transmissions that require the MERCON® V type fluid.

**MERCON® and MERCON® V type fluids are not interchangeable. DO NOT mix MERCON® and MERCON® V. Use of a transmission fluid that indicates dual usage (MERCON® and MERCON® V) in an automatic transmission application requiring MERCON® may cause transmission damage. Use of any fluid other than the recommended fluid may cause transmission damage.**

### ENGINE DATA

Engine*	5.4L V8 engine	6.8L V10 engine
Cubic inches	330	415
Required fuel	87 octane	87 octane
Firing order	1-3-7-2-6-5-4-8	1-6-5-10-2-7-3-8-4-9
Spark plug gap	1.3-1.4 mm (0.052-0.056 inch)	1.3-1.4 mm (0.052-0.056 inch)
Ignition system	Coil on plug	Coil on plug
Compression ratio	9.0:1	9.0:1

\*Refer to the *7.3 Liter Power Stroke Direct Injection Turbo Diesel Owner's Guide Supplement* for diesel engine information.

### VEHICLE DIMENSIONS

#### EXCURSION

Dimension	4x2 mm (in)	4x4 mm (in)
(1) Overall length	5 757 (226.7)	5 757 (226.7)
(2) Overall width	2 031 (80.0)	2 031 (80.0)
(3) Overall height	1 967 (77.4)	2 043 (80.4)
(4) Wheelbase	3 480 (137.0)	3 480 (137.0)
(5) Track (Front / Rear)	1 738 (68.4) / 1 729 (68.1)	1 738 (68.4) / 1 729 (68.1)

## Capacities and specifications

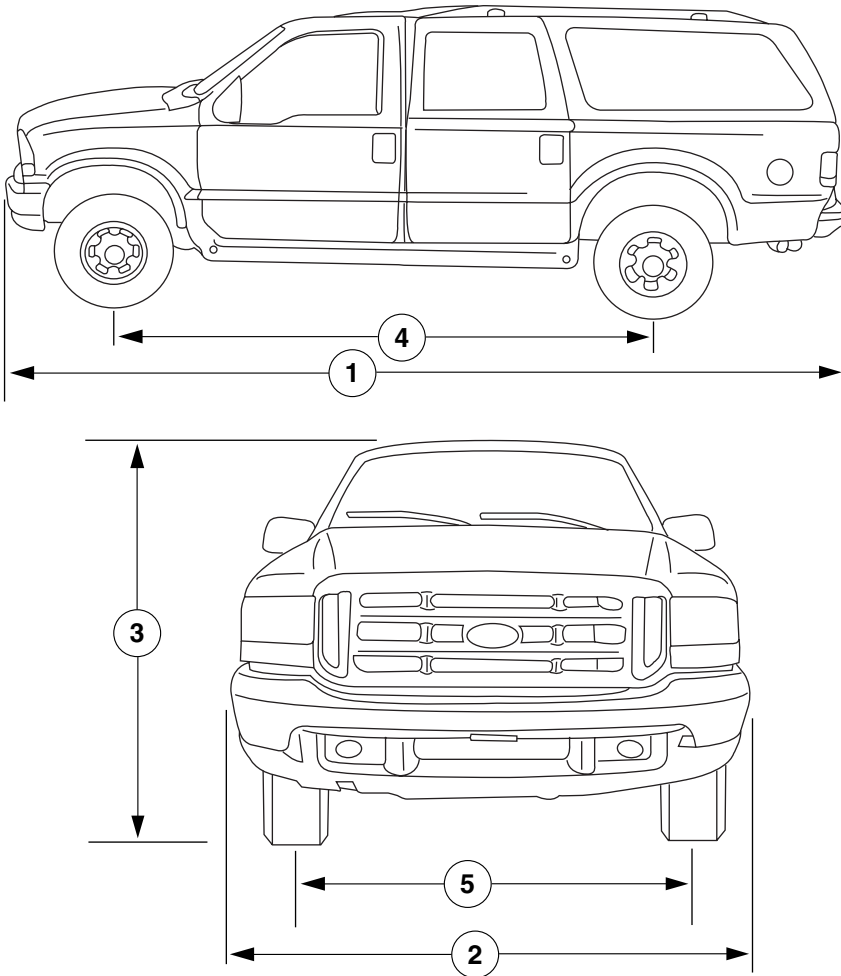

## Capacities and specifications

### IDENTIFYING YOUR VEHICLE

#### CERTIFICATION LABEL

The National Highway Traffic Safety Administration Regulations require that a Certification Label be affixed to a vehicle and prescribe where the Certification Label may be located. The Certification Label is located on the front door latch pillar on the driver's side.

<b>MFD. BY FORD MOTOR CO. IN U.S.A.</b>		
DATE: XXXXX	GVWR: XXXXX LB/ XXXXX KG	
FGAWR: XXXXX/XXXXXXXX	RGAWR: XXXXX/XXXXXXXX	
THIS VEHICLE CONFORMS TO ALL APPLICABLE FEDERAL MOTOR VEHICLE SAFETY STANDARDS IN EFFECT ON THE DATE OF MANUFACTURE SHOWN ABOVE.		
VIN: XXXXXXXXXXXXXXXXX	TYPE: XXXXXXXXXXXXXXX	
		
MAXIMUM LOAD=OCCUPANTS + LUGGAGE= XXXKG/XXXLB		
OCCUPANTS: X TOTAL X FR X 2ND X RR OCCUPANTS LUGGAGE		
XX XXXKG/XXXLB		
X XXXKG/XXXLB		
TIRE: XXXX/XXXXX XXX		
PRESSURE (FR) XXX kPa/33 PSI COLD		
PRESSURE (RR) XXX kPa/33 PSI COLD		
TRAILER TOWING: SEE OWNER GUIDE		
EXT PNT: XXXXX XXXXX	RC: XX   DSO: XXXX	F0000
BAR   INT TR   TP/PS   R   AXLE   TR   SPR	T0000	
X   XX   XXX   X   XX   X   XXXX		
UTC VFOHT-15294A10-GA		

#### VEHICLE IDENTIFICATION NUMBER

The vehicle identification number is attached to a metal tag and is located on the driver side instrument panel. (Please note that in the graphic XXXX is representative of your vehicle identification number.)

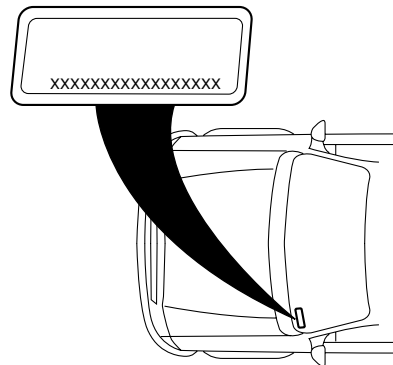

#### ENGINE NUMBER

The engine number (the last eight numbers of the vehicle identification number) is stamped on the engine block, transmission, frame and transfer case (if equipped).

## Customer assistance

### Ford Extended Service Plan

You can get more protection for your new car or light truck by purchasing Ford Extended Service Plan (Ford ESP) coverage. Ford ESP is an optional service contract which is backed by Ford Motor Company or Ford Motor Service Company (in the U.S.) and Ford of Canada (in Canada). It provides the following:

- benefits during the warranty period depending on the plan you purchase (such as: reimbursement for rentals; coverage for certain maintenance and wear items)
- protection against repair costs after your Bumper to Bumper Warranty expires

You may purchase Ford ESP from any participating Ford and Lincoln Mercury and Ford of Canada dealer. There are several plans available in various time, distance and deductible combinations which can be tailored to fit your own driving needs. Ford ESP also offers reimbursement benefits for towing and rental coverage. (In Hawaii, rules vary. See your dealer for details.)

When you buy Ford ESP, you receive Peace-of-Mind protection throughout the United States and Canada, provided by a network of more than 5,000 participating Ford or Lincoln Mercury and Ford of Canada dealers.

If you did not take advantage of the Ford Extended Service Plan at the time of purchasing your vehicle, you may still be eligible. Please contact your dealer for further information. Since this information is subject to change, please ask your dealer for complete details about Ford Extended Service Plan coverage options.

### Getting the service you need

#### At home

Ford Motor Company and Ford of Canada have authorized dealerships to service your vehicle. When you need warranty repairs your selling dealer would like you to return to it for that service, but you may also take your vehicle to another Ford Motor Company or Ford of Canada dealership authorized for warranty repairs. Certain warranty repairs require special training though, so not all dealers are authorized to perform all warranty repairs. That means that depending on the warranty repair needed, the vehicle may need to be taken to another dealer. If a particular dealership can not assist you, then contact the Customer Assistance Center.

## Customer assistance

If you have questions or concerns, or are unsatisfied with the service you are receiving, follow these steps:

1. Contact your Sales Representative or Service Advisor at your selling/servicing dealership.
2. If your inquiry or concern remains unresolved, contact the Sales Manager or Service Manager at the dealership.
3. If the inquiry or concern cannot be resolved at the dealership level, please contact the Ford Customer Assistance Center.

Ford Motor Company and Ford of Canada dealerships also carry quality parts and accessories, providing you with equipment reliability.

### Away from home

If you own a Ford or Mercury vehicle and are away from home when your vehicle needs service, or if you need more help than the dealership could provide, after following the steps described above, contact the Ford Customer Assistance Center to find an authorized dealership to help you. In the United States:

Ford Motor Company  
Customer Assistance Center  
16800 Executive Plaza Drive  
P.O. Box 6248  
Dearborn, Michigan 48121  
1-800-392-3673 (FORD)  
(TDD for the hearing impaired: 1-800-232-5952)

In Canada:  
Customer Assistance Centre  
Ford Motor Company of Canada, Limited  
P.O. Box 2000  
Oakville, Ontario L6J 5E4  
1-800-565-3673 (FORD)

## Customer assistance

If you own a Lincoln vehicle and are away from home when your vehicle needs service, or if you need more help than the dealership could provide, after following the steps described above, contact the Ford Customer Assistance Center to find an authorized dealership to help you. In the United States:

Ford Motor Company  
Customer Assistance Center  
16800 Executive Plaza Drive  
P.O. Box 6248  
Dearborn, Michigan 48121  
1-800-521-4140  
(TDD for the hearing impaired: 1-800-232-5952)

In Canada:  
Customer Assistance Centre  
Ford Motor Company of Canada, Limited  
P.O. Box 2000  
Oakville, Ontario L6J 5E4  
1-800-565-3673 (FORD)

In order to help you service your Ford or Lincoln Mercury vehicle, please have the following information available when contacting a Customer Assistance Center:

- Your telephone number (home and business)
- The name of the dealer and the city where the dealership is located
- The year and make of your vehicle
- The date of vehicle purchase
- The current odometer reading
- The vehicle identification number (VIN)

If you still have a complaint involving a warranty dispute, you may wish to contact the Dispute Settlement Board (U.S.) or the Canadian Motor Vehicle Arbitration Plan (CAMVAP), available in all of Canada (except Quebec).

In some states (in the U.S.) you must directly notify Ford in writing before pursuing remedies under your state's warranty laws. Ford is also allowed a final repair attempt in some states.

In the United States, a warranty dispute must be submitted to the Dispute Settlement Board before taking action under the Magnuson-Moss Warranty Act, or to the extent allowed by state law, before pursuing

## Customer assistance

replacement or repurchase remedies provided by certain state laws. This dispute handling procedure is not required prior to enforcing state created rights or other rights which are independent of the Magnuson-Moss Warranty Act or state replacement or repurchase laws.

### **THE DISPUTE SETTLEMENT BOARD (U.S. only)**

The Dispute Settlement Board is:

- an independent, third-party arbitration program for warranty disputes
- available free to owners and lessees of qualifying Ford Motor Company vehicles

The Dispute Settlement Board may not be available in all states. Ford Motor Company reserves the right to change eligibility limitations, modify procedures and/or to discontinue this service without notice and without incurring obligations per applicable state law.

### **What kinds of cases does the Board review?**

Unresolved warranty repair concerns or vehicle performance as designed concerns on Ford and Lincoln Mercury cars and Ford and Lincoln Mercury light trucks which are within the terms of any applicable written new vehicle warranty are eligible for review, except those involving:

- a non-Ford product
- a non-Ford dealership
- sales disputes between customer and dealer except those associated with warranty repairs or concerns with the vehicle's performance as designed
- a request for reimbursement of consequential expenses unless a service or product concern is being reviewed
- items not covered by the New Vehicle Limited Warranty (including maintenance and wear items)
- alleged personal injury/property damage claims
- cases currently in litigation
- vehicles not used primarily for family, personal or household purposes (except in states where the Dispute Settlement Board is required to review commercial vehicles)
- vehicles with non-U.S. warranties

## Customer assistance

Concerns are ineligible for review if the New Vehicle Limited Warranty has expired at receipt of your application and, in certain states eligibility is dependent upon the customer's possession of the vehicle.

Eligibility may differ according to state law. For example, see the unique brochures for California, West Virginia, Georgia and Wisconsin purchasers/lessees.

### **Board membership**

The Board consists of:

- three consumer representatives
- a Ford or Lincoln Mercury dealership representative

Consumer candidates for Board membership are recruited and trained by an independent consulting firm. The dealership Board member is chosen from Ford and Lincoln Mercury dealership management, recognized for their business leadership qualities.

### ***What the Board needs***

To have your case reviewed you must complete the application in the DSB brochure and mail it to the address provided on the application form. Some states will require you to use certified mail, with return receipt requested.

Your application is reviewed and, if it is determined to be eligible, you will receive an acknowledgment indicating:

- the file number assigned to your application
- the toll-free phone number of the DSB's independent administrator

Your dealership and a Ford Motor Company representative will then be asked to submit statements.

To properly review your case, the Board needs the following information:

- legible copies of all documents and maintenance or repair orders relevant to the case
- the year, make, model, and Vehicle Identification Number (VIN) listed on your vehicle ownership license
- the date of repair(s) and mileage at the time of occurrence(s)
- the current mileage
- the name of the dealer(s) who sold or serviced the vehicle
- a brief description of your unresolved concern



## Customer assistance

- a brief summary of the action taken by the dealer(s) and Ford Motor Company
- the names (if known) of all the people you contacted at the dealership(s)
- a description of the action you expect to resolve your concern

You will receive a letter of explanation if your application does not qualify for Board review.

### ***Oral presentations***

If you would like to make an oral presentation, indicate YES to question #6 on the application. While it is your right to make an oral presentation before the Board, this is not a requirement and the Board will decide the case whether or not an oral presentation is made. Oral presentation may be requested by the Board as well.

### ***Making a decision***

Board members review all available information related to each complaint, including oral presentations, and arrive at a fair and impartial decision. Board review may be terminated at any time by either party.

Every effort is made to decide the case within 40 days of the date that all requested information is received by the Board. Since the Board generally meets once a month, it may take longer for the Board to consider some cases.

After a case is reviewed, the Board mails you a decision letter and a form on which to accept or reject the Board's decision. The decisions of the Board are binding on Ford (and, in some cases, on the dealer) but not on consumers who are free to pursue other remedies available to them under state or federal law.

### **To Request a DSB Brochure/Application**

For a brochure/application, speak to your dealer or write/call to the Board at the following address/phone number:

Dispute Settlement Board  
P.O. Box 5120  
Southfield, MI 48086-5120  
1-800-428-3718

## Customer assistance

You may also contact the North American Customer Assistance Center at 1-800-392-3673 (Ford), TDD for the hearing impaired: 1-800-232-5952 or by writing to the Center at the following address:

Ford Motor Company  
Customer Assistance Center  
16800 Executive Plaza Drive  
P.O. Box 6248  
Dearborn, Michigan 48121

### **UTILIZING THE MEDIATION/ARBITRATION PROGRAM (CANADA ONLY)**

In those cases where you continue to feel that the efforts by Ford and the dealer to resolve a factory-related vehicle service concern have been unsatisfactory, Ford of Canada participates in an impartial third party mediation/arbitration program administered by the Canadian Motor Vehicle Arbitration Plan (CAMVAP).

The CAMVAP program is a straight-forward and relatively speedy alternative to resolve a disagreement when all other efforts to produce a settlement have failed. This procedure is without cost to you and is designed to eliminate the need for lengthy and expensive legal proceedings.

In the CAMVAP program, impartial third-party arbitrators conduct hearings at mutually convenient times and places in an informal environment. These impartial arbitrators review the positions of the parties, make decisions and, when appropriate, render awards to resolve disputes. CAMVAP decisions are fast, fair, and final; the arbitrator's award is binding both to you and Ford of Canada.

CAMVAP services are available in all territories and provinces, except Quebec. For more information, without charge or obligation, call your CAMVAP Provincial Administrator directly at 1-800-207-0685.

### **GETTING ASSISTANCE OUTSIDE THE U.S. AND CANADA**

Before exporting your vehicle to a foreign country, contact the appropriate foreign embassy or consulate. These officials can inform you of local vehicle registration regulations and where to find unleaded fuel.

If you cannot find unleaded fuel or can only get fuel with an anti-knock index lower than is recommended for your vehicle, contact a district or owner relations/customer assistance office.

## Customer assistance

The use of leaded fuel in your vehicle without proper conversion may damage the effectiveness of your emission control system and may cause engine knocking or serious engine damage. Ford Motor Company/Ford of Canada is not responsible for any damage caused by use of improper fuel.

In the United States, using leaded fuel may also result in difficulty importing your vehicle back into the U.S.

If your vehicle must be serviced while you are traveling or living in Central or South America, the Caribbean, or the Middle East, contact the nearest Ford dealership. If the dealership cannot help you, write or call:

FORD MOTOR COMPANY  
WORLDWIDE DIRECT MARKET OPERATIONS  
1555 Fairlane Drive  
Fairlane Business Park #3  
Allen Park, Michigan 48101  
U.S.A.  
Telephone: (313) 594-4857  
FAX: (313) 390-0804

If you are in another foreign country, contact the nearest Ford dealership. If the dealership employees cannot help you, they can direct you to the nearest Ford affiliate office.

If you buy your vehicle in North America and then relocate outside of the U.S. or Canada, register your vehicle identification number (VIN) and new address with Ford Motor Company Worldwide Direct Market Operations.

### **FORD CAR CARE PRODUCTS FOR YOUR VEHICLE**

Ford has many quality products available from your dealer to clean your vehicle and protect its finishes. These quality products have been specifically engineered to fulfill your automotive needs; they are custom designed to complement the style and appearance of your vehicle. Each product is made from high quality materials and that meet or exceed Ford's rigid specifications. For best results, use the following or products of equivalent quality:

Ford Custom Clearcoat Polish\*

Ford Custom Silicone Gloss Polish

Ford Custom Vinyl Protectant\* (not available in Canada)

Motorcraft Vinyl Conditioner (Canada only)

## Customer assistance

Ford Deluxe Leather and Vinyl Cleaner (not available in Canada)  
Motorcraft Vinyl Cleaner (Canada only)  
Ford Extra Strength Tar and Road Oil Remover\* (not available in Canada)  
Ford Extra Strength Upholstery Cleaner (Canada only)  
Ford Extra Strength Upholstery Cleaner (not available in Canada)  
Ford Metal Surface Cleaner  
Ford Multi-Purpose Cleaner\*  
Motorcraft Car Wash Concentrate  
Motorcraft Carlite Glass Cleaner  
Ford Spot and Stain Remover\*  
Ford Super Premium Tire and Trim Dressing  
Ford Triple Clean  
Ford Ultra-Clear Spray Glass Cleaner (not available in Canada)

\* May be sold with the Motorcraft name

### **FORD ACCESSORIES FOR YOUR VEHICLE**

A wide selection of Ford accessories are available for your vehicle through your local authorized Ford, Lincoln Mercury or Ford of Canada dealer. These quality accessories have been specifically engineered to fulfill your automotive needs; they are custom designed to complement the style and aerodynamic appearance of your vehicle. In addition, each accessory is made from high quality materials and meets or exceeds Ford's rigid engineering and safety specifications. Ford accessories are warranted for up to 12 months or 20 000 km (12 000 miles) on all cars and light trucks and 12 months with unlimited distance on medium/heavy duty trucks unless the accessory is installed on a new vehicle, then the warranty becomes the balance of the new vehicle's warranty or the accessories warranty, whichever is greater. See your dealer for complete warranty information and availability.

**Not all accessories are available for all models.**

#### **Vehicle Security**

Styled wheel protector locks  
Vehicle security systems  
Underbody Lighting

## Customer assistance

### **Comfort and convenience**

- Cargo organizers
- Cargo shades
- Cargo trays
- Dash trim
- Engine block heaters
- Battery warmer/blanket
- Cellular phone holder
- Electrochromatic compass mirror
- Electrochromatic compass mirror with temperature display
- Heat storage system
- Tire step

### **Travel equipment**

- Daytime running lights (DRL)
- Factory luggage rack adaptors
- Fog lights
- Framed luggage covers
- Heavy-duty battery
- Running boards
- Auto headlamp system with DRL
- Spare tire soft storage cover
- Seat back pack storage
- Multi sport track rider cross bars
- Multi sport track rider adaptors
- Soft luggage cover
- Speed control
- Towing mirrors
- Trailer hitch
- Trailer hitch bars and balls
- Trailer hitch wiring adaptor

## Customer assistance

### Protection and appearance equipment

Air bag anti-theft locks

Carpeted cargo mat

Door edge guards

Diamond plate splash guards

Car/truck covers

Cargo liners, interior

Carpet floor mats

Cleaners, waxes and polishes

Flat splash guards

Front end covers (full)

Hood deflectors

Locking gas cap

Lubricants and oils

Molded splash guards

Molded vinyl floor mats

Rear air deflectors

Side window air deflectors

Step bumpers

Touch-up paint

Universal floor mats

For maximum vehicle performance, keep the following information in mind when adding accessories or equipment to your vehicle:

- When adding accessories, equipment, passengers and luggage to your vehicle, do not exceed the total weight capacity of the vehicle or of the front or rear axle (GVWR or GAWR as indicated on the Safety compliance certification label). Consult your dealer for specific weight information.
- The Federal Communications Commission (FCC) and Canadian Radio Telecommunications Commission (CRTC) regulate the use of mobile communications systems - such as two-way radios, telephones and theft alarms - that are equipped with radio transmitters. Any such

## Customer assistance

equipment installed in your vehicle should comply with FCC or CRTC regulations and should be installed only by a qualified service technician.

- Mobile communications systems may harm the operation of your vehicle, particularly if they are not properly designed for automotive use or are not properly installed. When operated, such systems may cause the engine to stumble or stall or cause the transmission to be damaged or operate improperly. In addition, such systems may be damaged or their performance may be affected by operating your vehicle. (Citizens band [CB] transceivers, garage door openers and other transmitters with outputs of five watts or less will not ordinarily affect your vehicle's operation.)
- Ford cannot assume responsibility for any adverse effects or damage that may result from the use of such equipment.

### **ORDERING ADDITIONAL OWNER'S LITERATURE**

To order the publications in this portfolio:

Make checks payable to:

HELM, INCORPORATED  
P.O. Box 07150  
Detroit, Michigan 48207

**For a free publication catalog, order toll free: 1-800-782-4356**

Monday-Friday 8:00 a.m. - 6:00 p.m. EST,  
for credit card holders only

### **Obtaining a French owner's guide**

French Owner's Guides can be obtained from your dealer or by writing to Ford Motor Company of Canada, Limited, Service Publications, P.O. Box 1580, Station B, Mississauga, Ontario L4Y 4G3.

## Reporting safety defects

### REPORTING SAFETY DEFECTS (U.S. ONLY)

If you believe that your vehicle has a defect that could cause a crash, or could cause injury or death, you should immediately inform the National Highway Traffic Safety Administration (NHTSA) in addition to notifying Ford Motor Company.



If NHTSA receives similar complaints, it may open an investigation, and if it finds that a safety defect exists in a group of vehicles, it may order a recall and remedy campaign. However, NHTSA cannot become involved in individual problems between you, your dealer or Ford Motor Company.

To contact NHTSA, you may either call the Auto Safety Hotline toll-free at 1-800-424-9393 (202-366-0123 in the Washington D.C. area) or write to:

NHTSA  
U.S. Department of Transportation  
400 Seventh Street  
Washington D.C. 20590

You can also obtain other information about motor vehicle safety from the Hotline.



## Index

### A

- Accessory delay .....53
- Air bag supplemental restraint system .....95
  - and child safety seats .....97
  - description .....95
  - disposal .....99
  - driver air bag .....97
  - indicator light .....11, 99
  - operation .....97
  - passenger air bag .....97
- Air cleaner filter .....177–178, 204
- Air conditioning .....22
  - auxiliary heater and air conditioner .....24
- Antifreeze (see Engine coolant) .....165
- Anti-lock brake system (see Brakes) .....112–113
- Anti-theft system
  - warning light .....13
- Audio system (see Radio) .....27
- Automatic transmission
  - driving an automatic overdrive .....116
  - fluid, adding .....172
  - fluid, checking .....172
  - fluid, refill capacities .....204
  - fluid, specification .....209
- Auxiliary power point .....21
- Axle
  - lubricant specifications ..207, 209
  - refill capacities .....204
  - traction lok .....179

### B

- Battery .....175
  - acid, treating emergencies .....175
  - charging system warning light ...12
  - jumping a disabled battery ....151
  - maintenance-free .....175
  - replacement, specifications ...204
  - servicing .....175
  - voltage gauge .....17
- Belt minder .....91
- Brakes .....112
  - anti-lock .....112–113
  - anti-lock brake system (ABS) warning light .....12, 113
  - brake warning light .....11
  - fluid, checking and adding ....163
  - fluid, refill capacities .....204
  - fluid, specifications .....207, 209
  - lubricant specifications ..207, 209
  - parking .....113
  - shift interlock .....115
- Break-in period .....3

### C

- Capacities for refilling fluids ....204
- Cargo net .....73
- CD changer .....39
- Certification Label .....211
- Child safety restraints .....100
  - child safety belts .....100
- Child safety seats .....101
  - attaching with tether straps ..105
  - in front seat .....102
  - in rear seat .....102
- Cleaning your vehicle .....199
  - engine compartment .....201

## Index

- exterior .....201
  - exterior lamps .....202
  - instrument cluster lens .....202
  - instrument panel .....202
  - interior .....203
  - plastic parts .....201
  - safety belts .....203
  - washing .....200
  - waxing .....200
  - wheels .....201
  - wiper blades .....202
  - Climate control (see Air conditioning or Heating) .....22
  - Clock .....36
  - Compass, electronic .....60
    - calibration .....62
    - set zone adjustment .....61
  - Console .....64
    - overhead .....55–57
  - Controls
    - power seat .....75
  - Coolant
    - checking and adding .....165
    - refill capacities .....169, 204
    - specifications .....207, 209
  - Cruise control (see Speed control) .....45
  - Customer Assistance .....136
    - Ford accessories for your vehicle .....219
    - Ford Extended Service Plan ...212
    - Getting assistance outside the U.S. and Canada .....218
    - Getting roadside assistance ...136
    - Getting the service you need ..212
    - Ordering additional owner's literature .....223
    - The Dispute Settlement Board .....215
    - Utilizing the Mediation/ Arbitration Program .....218
- D**
- Daytime running lamps (see Lamps) .....18
  - Defrost
    - rear window .....26
  - Dipstick
    - automatic transmission fluid ...172
    - engine oil .....160
  - Doors
    - door ajar warning .....13
    - lubricant specifications .....207
  - Driving under special conditions .....123–124
    - sand .....124
    - snow and ice .....125
    - through water .....124, 128
- E**
- Emergencies, roadside
    - jump-starting .....151
  - Emission control system .....192
  - Engine .....209
    - check engine/service engine soon light .....8–9
    - cleaning .....201
    - coolant .....165
    - diesel .....3
    - fail-safe coolant .....170
    - idle speed control .....175
    - lubrication
      - specifications .....207, 209
      - refill capacities .....204
    - service points .....160
    - starting after a collision .....137

## Index

- Engine block heater .....110
- Engine oil .....160  
checking and adding .....160  
dipstick .....160  
filter, specifications .....162, 204  
recommendations .....162  
refill capacities .....204  
specifications .....207, 209
- Exhaust fumes .....111
- F**
- Fail safe cooling .....170
- Fluid capacities .....204
- Four-Wheel Drive vehicles ..13, 119  
control trac .....19  
description .....121  
driving off road .....123  
electronic shift .....19, 120–121  
indicator light .....12, 120  
preparing to drive your  
vehicle .....115
- Fuel .....185  
calculating fuel economy .....189  
cap .....188  
capacity .....204  
choosing the right fuel .....187  
comparisons with EPA fuel  
economy estimates .....192  
detergent in fuel .....188  
filling your vehicle  
with fuel .....185, 188–189  
filter, specifications .....189, 204  
fuel pump shut-off switch .....137  
gauge .....15  
improving fuel economy .....189  
low fuel warning light .....8  
octane rating .....187, 209  
quality .....187  
running out of fuel .....188  
safety information relating to  
automotive fuels .....185
- Fuses .....138–139
- G**
- Garage door opener .....56
- Gas cap (see Fuel cap) .....188
- Gas mileage  
(see Fuel economy) .....189
- Gauges .....14  
battery voltage gauge .....17  
engine coolant temperature  
gauge .....15  
engine oil pressure gauge .....17  
fuel gauge .....15  
odometer .....16  
speedometer .....15  
tachometer .....17  
trip odometer .....16
- GAWR (Gross  
Axle Weight Rating) .....125  
calculating .....127  
definition .....125  
driving with a heavy load .....125  
location .....125
- GVWR (Gross  
Vehicle Weight Rating) .....125  
calculating .....125, 127  
definition .....125  
driving with a heavy load .....125  
location .....125
- H**
- Hazard flashers .....137
- Head restraints .....77
- Headlamps .....18  
aiming .....199

## Index

- bulb specifications .....198
- daytime running lights .....18
- flash to pass .....51
- high beam .....12, 50
- replacing bulbs .....195
- turning on and off .....18
- warning chime .....14
- Heating .....22
  - heating and air conditioning system .....22
- Hood .....159
- I**
- Ignition .....44, 209
- Infant seats (see Safety seats) ..101
- Inspection/maintenance (I/M) testing .....194
- Instrument panel
  - cleaning .....202
  - cluster .....8, 202
  - lighting up panel and interior ...18
  - location of components .....8
- J**
- Jump-starting your vehicle .....151
- K**
- Keyless entry system
  - locking and unlocking doors ....70
  - programming entry code .....69
- Keys
  - key in ignition chime .....14
  - positions of the ignition .....44
- L**
- Lamps
  - autolamp system .....194
  - bulb replacement
    - specifications chart .....198
  - cargo lamps .....18
  - daytime running light .....18
  - headlamps .....18
  - headlamps, flash to pass .....51
  - instrument panel, dimming .....18
  - interior lamps .....62–63, 198
  - replacing
    - bulbs .....194–195, 197–198
- Lane change indicator (see Turn signal) .....44
- Liftgate .....73
- Lights, warning and indicator .....8
  - air bag .....11
  - anti-lock brakes (ABS) ....12, 113
  - anti-theft .....13
  - brake .....11
  - charging system .....12
  - check coolant .....13
  - cruise indicator .....13
  - door ajar .....13
  - engine oil pressure .....13
  - high beam .....12
  - low fuel .....8
  - safety belt .....11
  - service engine soon .....8–9
  - turn signal indicator .....12
- Load limits .....125
  - GAWR .....125
  - GVWR .....125
  - trailer towing .....125
- Loading instructions .....127

## Index

- Locks  
  childproof .....53  
  doors .....53  
Lubricant specifications ...207, 209  
Lumbar support, seats .....76–77
- M**
- Manual transmission  
  fluid capacities .....204  
  lubricant specifications .....209  
Message center .....58  
  english/metric button .....58  
  menu button .....59  
Mirrors .....58  
  automatic dimming rearview  
  mirror .....57  
  fold away .....55  
  heated .....55  
  side view mirrors (power) .....54  
Motorcraft parts .....189, 204
- O**
- Octane rating .....187  
Odometer .....16  
Oil (see Engine oil) .....160  
Overdrive .....51
- P**
- Panic alarm feature, remote  
  entry system .....66  
Parking brake .....113  
Parts (see Motorcraft parts) ....204  
Power distribution box  
  (see Fuses) .....143  
Power door locks .....53  
Power steering .....114  
  fluid, checking and adding ....171  
  fluid, refill capacity .....204  
  fluid, specifications .....207, 209  
Preparing to  
  drive your vehicle .....115
- R**
- Radio .....27  
Relays .....138  
Remote entry system .....64, 66  
  illuminated entry .....67  
  locking/unlocking doors .....65  
  panic alarm .....66  
  replacement/additional  
  transmitters .....68  
  replacing the batteries .....66  
Roof rack .....133
- S**
- Safety belts (see Safety  
  restraints) .....14, 84–87, 89  
Safety defects, reporting .....224  
Safety restraints .....84–87, 89  
  belt minder .....91  
  cleaning the safety belts ..94, 203  
  extension assembly .....90  
  for adults .....85–87  
  for children .....99–100  
  lap belt .....89  
  warning light  
  and chime .....11, 14, 91  
Safety seats for children .....101  
Seat belts  
  (see Safety restraints) .....84

## Index

- Seats .....74  
  child safety seats .....101  
  cleaning .....203
- SecuriLock passive  
anti-theft system .....70–72
- Servicing your vehicle .....158
- Snowplowing .....3
- Spark plugs,  
specifications .....204, 209
- Special notice .....3  
  diesel-powered vehicles .....3  
  utility-type vehicles .....3
- Specification chart,  
lubricants .....207, 209
- Speed control .....45
- Speedometer .....15
- Starting your vehicle .....108, 110  
  jump starting .....151
- Steering wheel  
  tilting .....49
- T**
- Tachometer .....17
- Tires .....146, 180–182  
  changing .....146–147  
  checking the pressure .....182  
  replacing .....183  
  rotating .....182  
  snow tires and chains .....184  
  tire grades .....181  
  treadwear .....181
- Towing .....182  
  recreational towing .....133  
  wrecker .....157
- Traction-lok rear axle .....179
- Transfer case  
  fluid checking .....174
- Transmission .....115  
  fluid, checking and adding  
  (automatic) .....172  
  fluid, refill capacities .....204  
  lubricant specifications ..207, 209
- Transmission control  
indicator light .....11
- Trip odometer .....16
- Turn signal .....12, 44
- V**
- Vehicle dimensions .....209
- Vehicle Identification  
Number (VIN) .....211
- Vehicle loading .....125
- Ventilating your vehicle .....111
- W**
- Warning chimes .....14
- Warning lights (see Lights) .....8
- Washer fluid .....165
- Water, Driving through .....128
- Windows  
  power .....52  
  rear wiper/washer .....50
- Windshield washer fluid and  
wipers  
  checking and adding fluid .....165  
  checking and cleaning ....179–180  
  liftgate reservoir .....165  
  operation .....49  
  replacing wiper blades .....180
- Wrecker towing .....157

## Filling station information

Item	Information
Required fuel	Unleaded fuel only - 87 octane
Fuel tank capacity	166.6L (44.0 gallons)
Engine oil-gasoline engines (includes filter change)	5.7L (6.0 quarts). Use Motorcraft SAE 5W-30 Super Premium Motor Oil, Ford specification WSS-M2C153-H.
Engine oil -diesel engine	Refer to your 7.3L Diesel Supplement.
Tire size and pressure	Refer to the label inside of driver's door.
Hood release	Pull handle under the left side of the instrument panel.
Coolant capacity (gasoline engines)	Refer to <i>Refill capacities</i> in the <i>Capacities and specifications</i> chapter.
Coolant capacity (diesel engine)	Refer to your 7.3L Diesel Supplement.
Power steering fluid capacity	Fill to line on dipstick. Use Motorcraft MERCON® ATF.
Automatic transmission fluid capacity (4x2 vehicles) <sup>1</sup>	16.1L (17.1 quarts). Use Motorcraft MERCON® ATF. <sup>2</sup>
Automatic transmission fluid capacity (4x4 vehicles) <sup>1</sup>	16.7L (17.7 quarts). Use Motorcraft MERCON® ATF. <sup>2</sup>
Windshield washer fluid	4.2L (1.1 gallons). Use Ultra-Clear Windshield Washer Concentrate.

<sup>1</sup> Ensure the correct automatic transmission fluid is used. Transmission fluid requirements are indicated on the dipstick or on the dipstick handle. Check the container to verify the fluid being added is of the correct type. Refer to your scheduled maintenance guide to determine the correct service interval.

Some transmission fluids may be labeled as dual usage, such as MERCON® and MERCON® V. These dual usage fluids are not to be used in an automatic transmission that requires use of the MERCON® type fluid. However, these dual usage fluids may be used in transmissions that require the MERCON® V type fluid.

**MERCON® and MERCON® V type fluids are not interchangeable. DO NOT mix MERCON® and MERCON® V. Use of a transmission**

## Filling station information

**fluid that indicates dual usage (MERCON® and MERCON® V) in an automatic transmission application requiring MERCON® may cause transmission damage. Use of any fluid other than the recommended fluid may cause transmission damage.**

<sup>2</sup> Indicates only approximate dry-fill capacity. Some applications may vary based on cooler size and if equipped with in-tank cooler. The amount of transmission fluid and fluid level should be set by the indication on the dipstick's normal operating range.



## Free Manuals Download Website

<http://myh66.com>

<http://usermanuals.us>

<http://www.somanuals.com>

<http://www.4manuals.cc>

<http://www.manual-lib.com>

<http://www.404manual.com>

<http://www.luxmanual.com>

<http://aubethermostatmanual.com>

Golf course search by state

<http://golfingnear.com>

Email search by domain

<http://emailbydomain.com>

Auto manuals search

<http://auto.somanuals.com>

TV manuals search

<http://tv.somanuals.com>