

Contents

Before driving

Introduction 2

Instrumentation 6

Controls and features 18

Seating and safety restraints 70

Starting and driving

Starting 100

Driving 106

Roadside emergencies 137

Servicing

Maintenance and care 158

Capacities and specifications 209

Customer assistance 218

Reporting safety defects 230

Index 231

All rights reserved. Reproduction by any means, electronic or mechanical including photocopying, recording or by any information storage and retrieval system or translation in whole or part is not permitted without written authorization from Ford Motor Company. Ford may change the contents without notice and without incurring obligation.

Copyright © 1999 Ford Motor Company

Introduction

The following warning may be required by California law:

CALIFORNIA Proposition 65 Warning



Engine exhaust, some of its constituents, and certain vehicle components contain or emit chemicals known to the State of California to cause cancer, or birth defects or other reproductive harm.

ICONS

Indicates a safety alert. Read the following section on *Warnings*.



Indicates vehicle information related to recycling and other environmental concerns will follow.



Correct vehicle usage and the authorized disposal of waste cleaning and lubrication materials are significant steps towards protecting the environment.

Indicates a message regarding child safety restraints. Refer to *Seating and safety restraints* for more information.



Indicates that this Owner Guide contains information on this subject. Please refer to the Index to locate the appropriate section which will provide you more information.



WARNINGS

Warnings provide information which may reduce the risk of personal injury and prevent possible damage to others, your vehicle and its equipment.

BREAKING-IN YOUR VEHICLE

There are no particular breaking-in rules for your vehicle. During the first 1 600 km (1 000 miles) of driving, vary speeds frequently. This is necessary to give the moving parts a chance to break in.

INFORMATION ABOUT THIS GUIDE

The information found in this guide was in effect at the time of printing. Ford may change the contents without notice and without incurring obligation.

SPECIAL NOTICES

Notice to owners of pickup trucks and utility type vehicles



Utility vehicles have a significantly higher rollover rate than other types of vehicles.

Before you drive your vehicle, please read this Owner's Guide carefully. Your vehicle is not a passenger car. As with other vehicles of this type, failure to operate this vehicle correctly may result in loss of control or an accident.

Be sure to read *Driving off road* in the *Driving* chapter as well as the "Four Wheeling" supplement included with 4WD and utility type vehicles.

Using your vehicle as a snowplow



Do not use this vehicle for snowplowing.

Using your vehicle as an ambulance



Do not use this vehicle as an ambulance.

Your vehicle is not equipped with the Ford Ambulance Preparation Package.

Electric vehicles

For information on operating your Electric Vehicle, also refer to the Electric Vehicle Owner's Guide Supplement.

Introduction

These are some of the symbols you may see on your vehicle.

Vehicle Symbol Glossary

Safety Alert		See Owner's Guide	
Fasten Safety Belt		Air Bag-Front	
Air Bag-Side		Child Seat	
Child Seat Installation Warning		Child Seat Tether Anchorage	
Brake System		Anti-Lock Brake System	
Brake Fluid - Non-Petroleum Based		Traction Control	
Master Lighting Switch		Hazard Warning Flasher	
Fog Lamps-Front		Fuse Compartment	
Fuel Pump Reset		Windshield Wash/Wipe	
Windshield Defrost/Demist		Rear Window Defrost/Demist	
Power Windows Front/Rear		Power Window Lockout	

Vehicle Symbol Glossary

Child Safety Door Lock/Unlock		Interior Luggage Compartment Release Symbol	
Panic Alarm		Engine Oil	
Engine Coolant		Engine Coolant Temperature	
Do Not Open When Hot		Battery	
Avoid Smoking, Flames, or Sparks		Battery Acid	
Explosive Gas		Fan Warning	
Power Steering Fluid		Maintain Correct Fluid Level	
Emission System		Engine Air Filter	
Passenger Compartment Air Filter		Jack	

Instrumentation

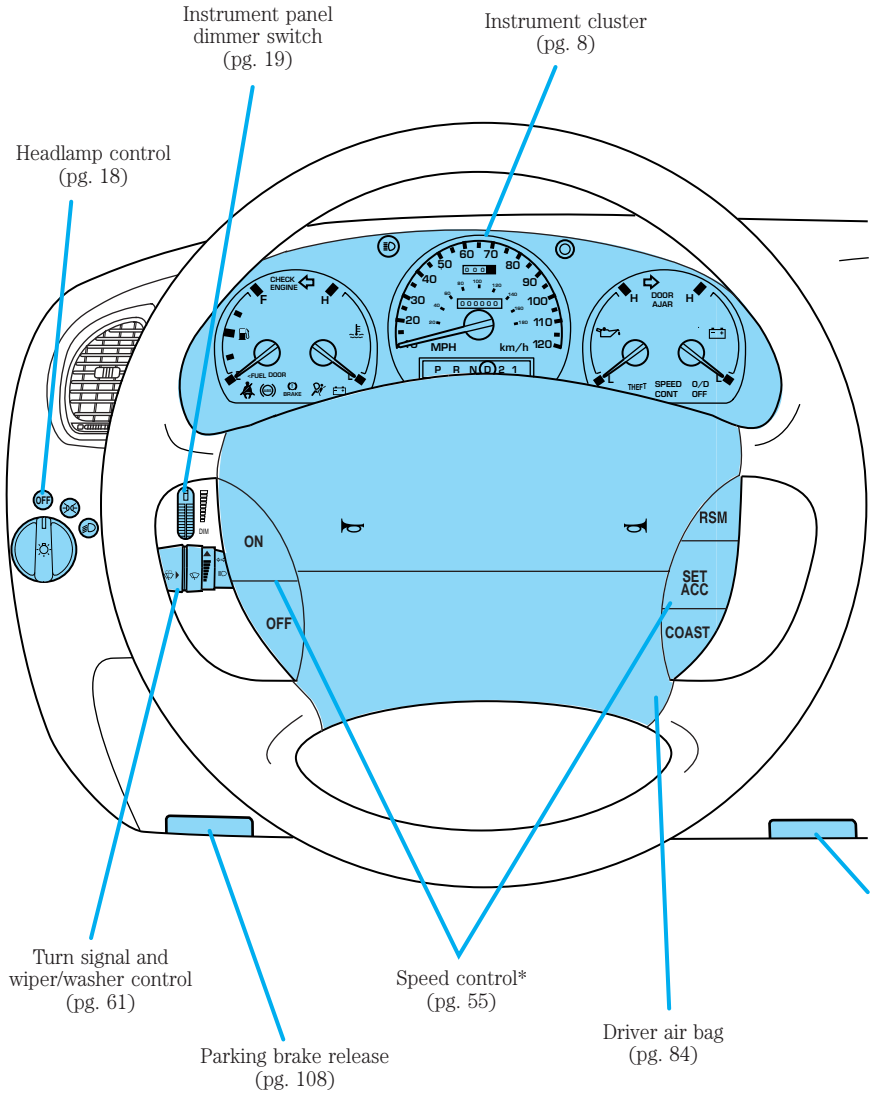

Instrumentation

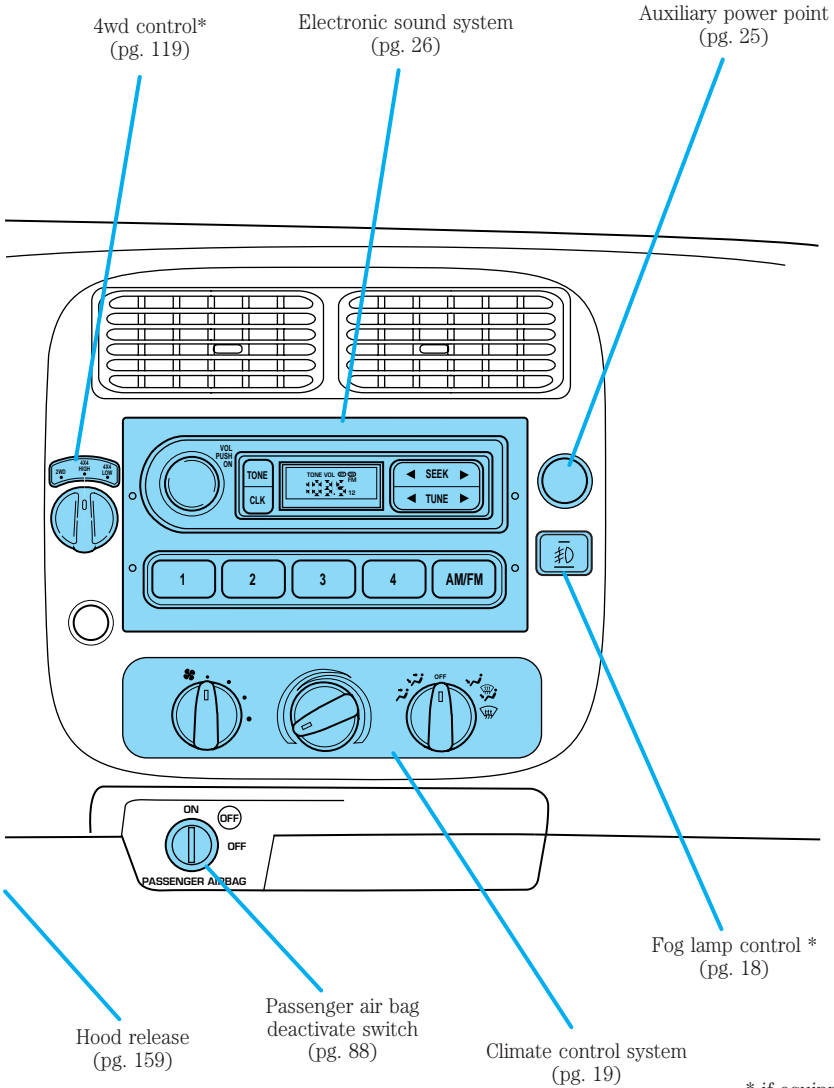

* if equipped

Instrumentation

WARNING LIGHTS AND CHIMES

Standard instrument cluster

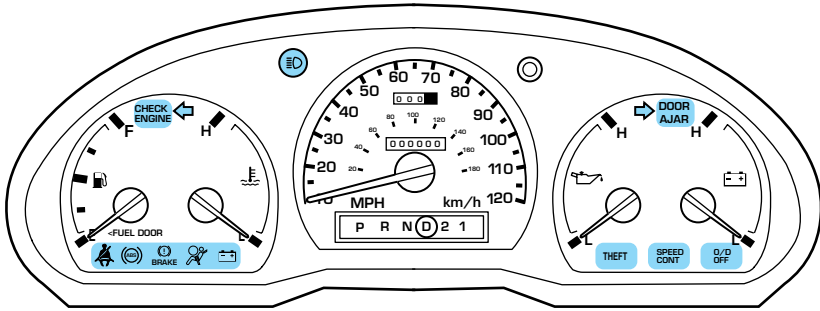

Optional instrument cluster

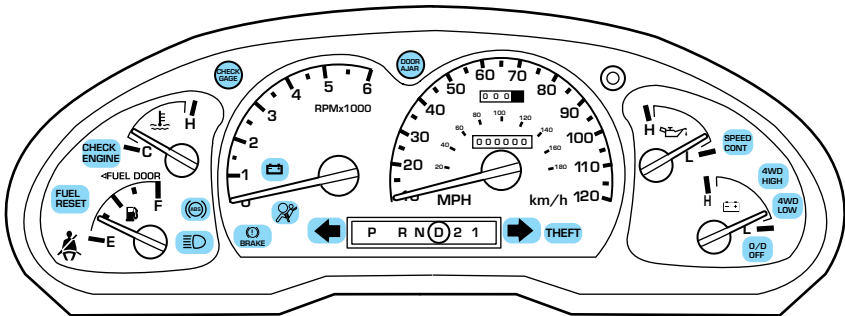

Check engine

Your vehicle is equipped with a computer that monitors the engine's emission control system. This system is commonly known as the On Board Diagnostics System (OBD II). This OBD II system protects the environment by ensuring that your vehicle continues to meet government emission standards. The OBD II system also assists the service technician in properly servicing your vehicle.

CHECK ENGINE

The *Check Engine* indicator light illuminates when the ignition is first turned to the ON position to check the bulb. If it comes on after the engine is started, one of the engine's emission control systems may be malfunctioning. The light may illuminate without a driveability concern being noted. The vehicle will usually be drivable and will not require towing.

What you should do if the check engine light illuminates

Light turns on solid:

This means that the OBD II system has detected a malfunction.

Temporary malfunctions may cause your *Check Engine* light to illuminate. Examples are:

1. The vehicle has run out of fuel. (The engine may misfire or run poorly.)
2. Poor fuel quality or water in the fuel.
3. The fuel cap may not have been properly installed and securely tightened.

These temporary malfunctions can be corrected by filling the fuel tank with high quality fuel of the recommended octane and/or properly installing and securely tightening the gas cap. After three driving cycles without these or any other temporary malfunctions present, the *Check Engine* light should turn off. (A driving cycle consists of a cold engine startup followed by mixed city/highway driving.) No additional vehicle service is required.

If the *Check Engine* light remains on, have your vehicle serviced at the first available opportunity.

Light is blinking:

Engine misfire is occurring which could damage your catalytic converter. You should drive in a moderate fashion (avoid heavy acceleration and deceleration) and have your vehicle serviced at the first available opportunity.



Under engine misfire conditions, excessive exhaust temperatures could damage the catalytic converter, the fuel system, interior floor coverings or other vehicle components, possibly causing a fire.

Instrumentation

Fuel reset (if equipped)

Illuminates when the ignition key is turned to the ON position and the fuel pump shut-off switch has been triggered. For more information, refer to *Fuel pump shut-off switch* in the *Roadside emergencies* chapter.

**FUEL
RESET**

Air bag readiness

Momentarily illuminates when the ignition is turned ON. If the light fails to illuminate, continues to flash or remains on, have the system serviced immediately.



Safety belt

Momentarily illuminates when the ignition is turned to the ON position to remind you to fasten your safety belts. For more information, refer to the *Seating and safety restraints* chapter.



Brake system warning

Momentarily illuminates when the ignition is turned to the ON position. Also illuminates if the parking brake is engaged. If the brake warning lamp does not illuminate at these times, seek service immediately. Illumination after releasing the parking brake indicates low brake fluid level and the brake system should be inspected immediately.

(!)
BRAKE

Anti-lock brake system (ABS)

Momentarily illuminates when the ignition is turned to the ON position. If the light remains on, continues to flash or fails to illuminate, have the system serviced immediately. With the ABS light on, the anti-lock brake system is disabled and normal braking is still effective unless the brake warning light also remains illuminated with the parking brake released.



Turn signal

Illuminates when the left or right turn signal or the hazard lights are turned on. If one or both of the indicators stay on continuously or flash faster, check for a burned-out turn signal bulb. Refer to *Exterior bulbs* in the *Maintenance and care* chapter.

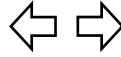

High beams

Illuminates when the high beam headlamps are turned on.



Anti-theft system (if equipped)

Refer to *SecuriLock™ passive anti-theft system* in the *Controls and features* chapter.



Charging system

Illuminates when the ignition is turned to the ON position and the engine is off. The light also illuminates when the battery is not charging properly, requiring electrical system service.

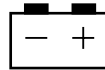

O/D off (if equipped)

Illuminates when the Transmission Control Switch (TCS), refer to *Overdrive control* in the *Controls and Features* chapter, has been



pushed turning the transmission overdrive function OFF. When the light is on, the transmission does not operate in the overdrive mode, refer to the *Driving* chapter for transmission function and operation.

The light may also flash steadily if a transmission malfunction is detected. If the light does not come on when the Transmission Control Switch is depressed or if the light flashes steadily, have your vehicle serviced as soon as possible, damage to the transmission could occur.

Instrumentation

Check gage (if equipped)

Illuminates when the engine coolant temperature is high, the engine oil pressure is low or the fuel gauge is at or near empty. The ignition must be in the ON position for this lamp to illuminate. The lamp will also illuminate when the ignition is turned to the ON position. Refer to *Engine coolant temperature gauge*, *Engine oil pressure gauge* or *Fuel gauge* in this chapter for more information.

**CHECK
GAGE**

Four wheel drive low (if equipped)

Momentarily illuminates when the ignition is turned to the START position. Illuminates when four-wheel drive low is engaged. If the light continues to flash have the system serviced.

**4WD
LOW**

Four wheel drive high (if equipped)

Momentarily illuminates when the ignition is turned to the START position. Illuminates when four-wheel drive high is engaged. If the light continues to flash have the system serviced.

**4WD
HIGH**

Door ajar

Illuminates when the ignition is in the ON or START position and any door is open.

**DOOR
AJAR**

Speed control

This light comes on when either the SET/ACCEL or RESUME controls are pressed. It turns off when the speed control OFF control is pressed, the brake is applied or the ignition is turned to the OFF position.

**SPEED
CONT**

Safety belt warning chime

Sounds to remind you to fasten your safety belts.

For information on the safety belt warning chime, refer to the *Seating and safety restraints* chapter.

Supplemental restraint system (SRS) warning chime

For information on the SRS warning chime, refer to the *Seating and safety restraints* chapter.

Key-in-ignition warning chime

Sounds when the key is left in the ignition in the OFF/LOCK or ACC position and the driver's door is opened.

Headlamps on warning chime

Sounds when the headlamps or parking lamps are on, the ignition is off (and the key is not in the ignition) and the driver's door is opened.

Instrumentation

GAUGES

Standard instrument cluster gauges

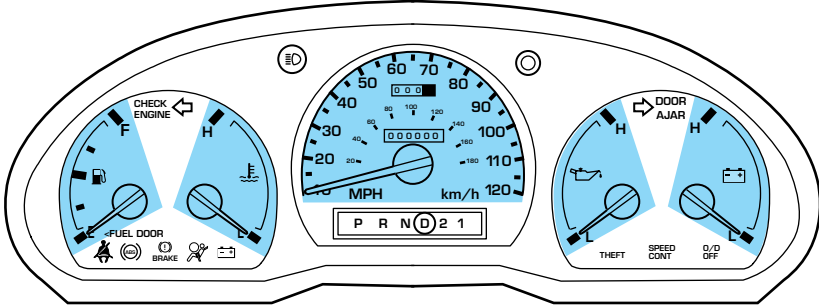

Optional instrument cluster gauges

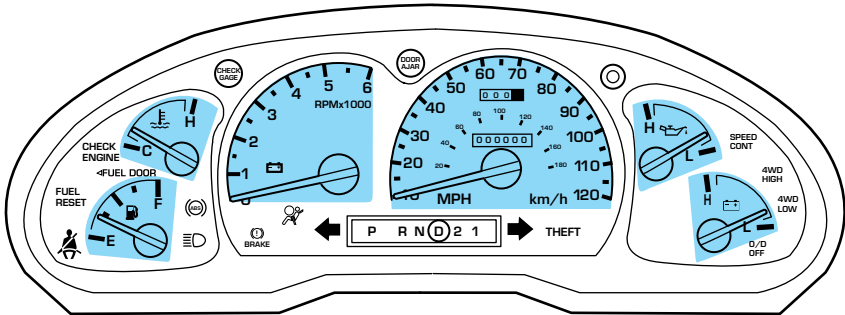

Fuel gauge

Displays approximately how much fuel is in the fuel tank (when the key is in the ON position). The fuel gauge may vary slightly when the vehicle is in motion. The ignition should be in the OFF position while the vehicle is being refueled. When the gauge first indicates empty, there is a small amount of reserve fuel in the tank. When refueling the

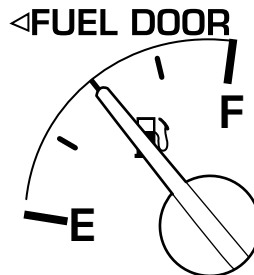

Instrumentation

vehicle from empty indication, the amount of fuel that can be added will be less than the advertised capacity due to the reserve fuel.

The FUEL DOOR icon and arrow indicates which side of the vehicle the fuel filler door is located.

Engine coolant temperature gauge

Indicates the temperature of the engine coolant. At normal operating temperature, the needle remains within the normal area (the area between the “H” and “C”). If it enters the red section, the engine is overheating. Stop the vehicle as soon as safely possible, switch off the engine immediately and let the engine cool. Refer to *Engine coolant* in the *Maintenance and care* chapter.

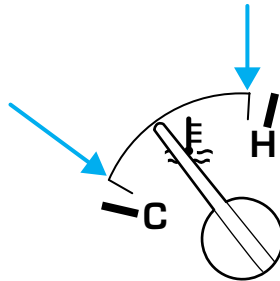

Never remove the coolant reservoir cap while the engine is running or hot.

This gauge indicates the temperature of the engine coolant, not the coolant level. If the coolant is not at its proper level the gauge indication will not be accurate.

Tachometer (if equipped)

Indicates the engine speed in revolutions per minute.

Driving with your tachometer pointer continuously at the top of the scale may damage the engine.

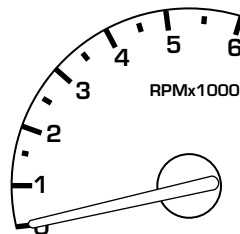

Instrumentation

Speedometer

Indicates the current vehicle speed.

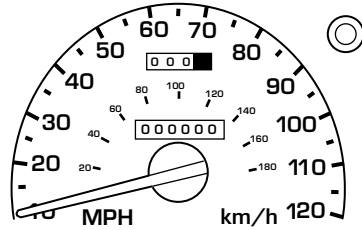

Odometer

Registers the total kilometers (miles) of the vehicle.

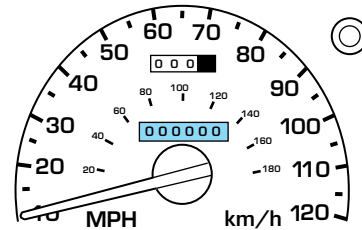

Trip odometer

Registers the kilometers (miles) of individual journeys. To reset, depress the control.

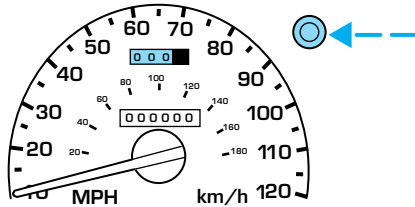

Engine oil pressure gauge

This shows the engine oil pressure in the system. Sufficient pressure exists as long as the needle remains in the normal range (the area between the “L” and “H”).

If the gauge indicates low pressure, stop the vehicle as soon as safely possible and switch off the engine immediately. Check the oil level.

Add oil if needed (refer to *Engine oil* in the *Maintenance and care*

chapter). If the oil level is correct, have your vehicle checked at your dealership or by a qualified technician.

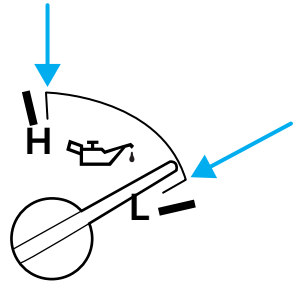

Battery voltage gauge

This shows the battery voltage when the ignition is in the ON position. If the pointer moves and stays outside the normal operating range (as indicated), have the vehicle's electrical system checked as soon as possible.

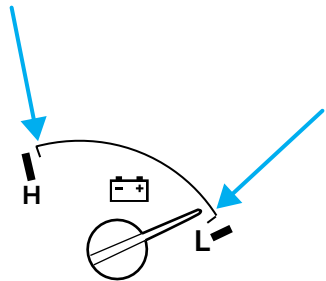

Controls and features

HEADLAMP CONTROL

Rotate the headlamp control to the first position to turn on the parking lamps. Rotate to the second position to also turn on the headlamps.

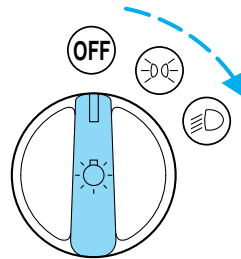

Foglamp control (if equipped)

Turn on the low-beam headlamps and press the foglamp control to activate the foglamps. The foglamp control will illuminate when the foglamps are on.

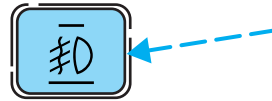

Press the foglamp control a second time to deactivate the foglamps.

Daytime running lamps (DRL) (if equipped)

Turns the headlamps on with a reduced output. To activate:

- the ignition must be in the ON position and
- the headlamp control is in the OFF or Parking lamps position.



Always remember to turn on your headlamps at dusk or during inclement weather. The Daytime Running Light (DRL) System does not activate your tail lamps and generally may not provide adequate lighting during these conditions. Failure to activate your headlamps under these conditions may result in a collision.

High beams

Push forward to activate.

Pull toward you to deactivate.

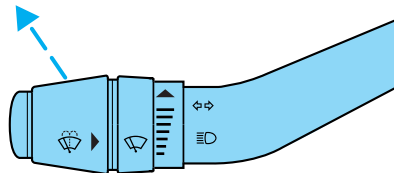

Controls and features

Flash to pass

Pull toward you to activate and release to deactivate.

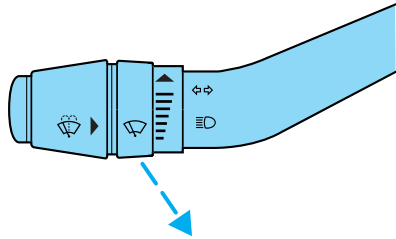

PANEL DIMMER CONTROL

Use to adjust the brightness of the instrument panel during headlamp and parklamp operation.

- Rotate up to brighten.
- Rotate down to dim.
- Rotate to full up position (past detent) to turn on interior lamps.

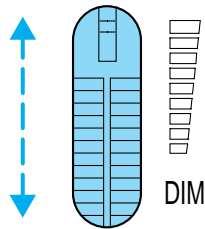

CLIMATE CONTROL SYSTEM

Heater only system (if equipped)

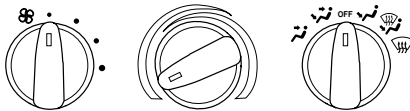

Fan speed control

Controls the volume of air circulated in the vehicle.

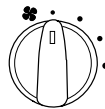

Controls and features

Temperature control knob



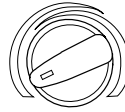

Controls the temperature of the airflow inside the vehicle. On heater-only systems, the air cannot be cooled below the outside temperature.



Mode selector control

Controls the direction of the airflow to the inside of the vehicle.



-  (Panel)-Distributes outside air through the instrument panel registers.
-  (Panel and floor)-Distributes outside air through the instrument panel registers and the floor ducts.
- OFF-Outside air is shut out and the fan will not operate.
-  (Floor)-Allows for maximum heating. Distributes outside air through the floor ducts.
-  (Floor and defrost)-Distributes outside air through the floor ducts and the windshield defroster ducts.
-  (Defrost)-Distributes outside air through the windshield defroster ducts. It can be used to clear ice or fog from the windshield.

Operating tips

- In humid weather, select  before driving. This will reduce fogging on your windshield. After a few minutes, select any desired position.
- To reduce humidity buildup inside the vehicle, don't drive with the climate control system in the OFF position.
- Don't put objects under the front seat that will interfere with the airflow to the rear seats (if equipped).

Controls and features

- Remove any snow, ice or leaves from the air intake area (at the bottom of the windshield under the hood).

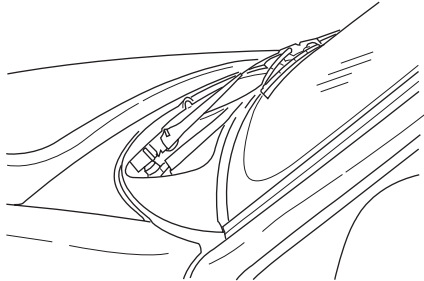

- Do not place objects over the defroster outlets. These objects can block airflow and reduce your ability to see through your windshield. Also, avoid placing small objects on top of your instrument panel. These objects can fall down into the defroster outlets and block airflow and possibly damage your climate control system.



Do not place objects on top of the instrument panel as these objects may become projectiles in a collision or sudden stop.

Manual heating and air conditioning system (if equipped)

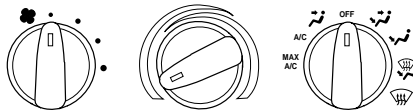

Fan speed control

Controls the volume of air circulated in the vehicle.



Temperature control knob

Controls the temperature of the airflow inside the vehicle.

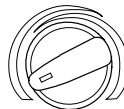



Controls and features

Mode selector control

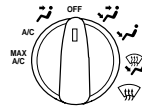

Controls the direction of the airflow to the inside of the vehicle.





The air conditioning compressor will operate in all modes except  and . However, the air conditioning will only function if the outside temperature is about 10°C (50°F) or higher.

Since the air conditioner removes considerable moisture from the air during operation, it is normal if clear water drips on the ground under the air conditioner drain while the system is working and even after you have stopped the vehicle.

Under normal conditions, your vehicle's climate control system should be left in any position other than MAX A/C or OFF when the vehicle is parked. This allows the vehicle to "breathe" through the outside air inlet duct. In snowy or dirty conditions, leave the mode selector in the OFF position.

- MAX A/C-Uses recirculated air to cool the vehicle. MAX A/C is noisier than A/C but more economical and will cool the inside of the vehicle faster. Airflow will be from the instrument panel registers. This mode can also be used to prevent undesirable odors from entering the vehicle.
- A/C-Uses outside air to cool the vehicle. It is quieter than MAX A/C but not as economical. Airflow will be from the instrument panel registers.
-  (Panel)-Distributes outside air through the instrument panel registers. However, the air will not be cooled below the outside temperature because the air conditioning does not operate in this mode.
- OFF-Outside air is shut out and the fan will not operate. For short periods of time only, use this mode to prevent undesirable odors from entering the vehicle.
-  (Panel and floor)-Distributes outside air through the instrument panel registers and the floor ducts. Heating and air conditioning capabilities are provided in this mode. For added customer comfort, when the temperature control knob is anywhere in between the full hot and full cold positions, the air distributed through the floor ducts will be slightly warmer than the air sent to the instrument panel registers.

Controls and features

-  (Floor)-Allows for maximum heating by distributing outside air through the floor ducts. However, the air will not be cooled below the outside temperature because the air conditioning does not operate in this mode.
-  (Floor and defrost)-Distributes outside air through the windshield defroster ducts and the floor ducts. Heating and air conditioning capabilities are provided in this mode. For added customer comfort, when the temperature control knob is anywhere in between the full hot and full cold positions, the air distributed through the floor ducts will be slightly warmer than the air sent to the windshield defrost ducts. If the temperature is about 10°C (50°F) or higher, the air conditioner will automatically dehumidify the air to reduce fogging.
-  (Defrost)-Distributes outside air through the windshield defroster ducts. It can be used to clear ice or fog from the windshield. If the temperature is about 10°C (50°F) or higher, the air conditioner will automatically dehumidify the air to reduce fogging.

Operating tips

- In humid weather, select  before driving. This will reduce fogging on your windshield. After a few minutes, select any desired position.
- To prevent humidity buildup inside the vehicle, do not drive with the climate control system in the OFF or MAX A/C position.
- Do not put objects under the front seat that will interfere with the airflow to the rear seats (if equipped).
- Remove any snow, ice or leaves from the air intake area (at the bottom of the windshield under the hood).

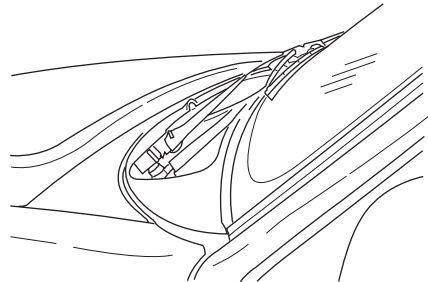

- If your vehicle has been parked with the windows closed during hot weather, the air conditioner will do a much faster job of cooling if you drive for two or three minutes with the windows open. This will force most of the hot, stale air out of the vehicle. Then operate your air conditioner as you would normally.

Controls and features

- Do not place objects over the defroster outlets. These objects can block airflow and reduce your ability to see through your windshield. Also, avoid placing small objects on top of your instrument panel. These objects can fall down into the defroster outlets and block airflow and possibly damage your climate control system.



Do not place objects on top of the instrument panel, as these objects may become projectiles in a collision or sudden stop.

4WD CONTROL (IF EQUIPPED)

This control operates the 4WD. Refer to the *Driving* chapter for more information.

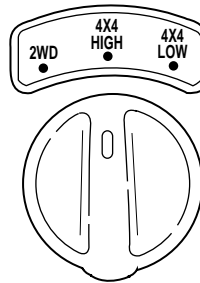

Controls and features

AUXILIARY POWER POINT 12V

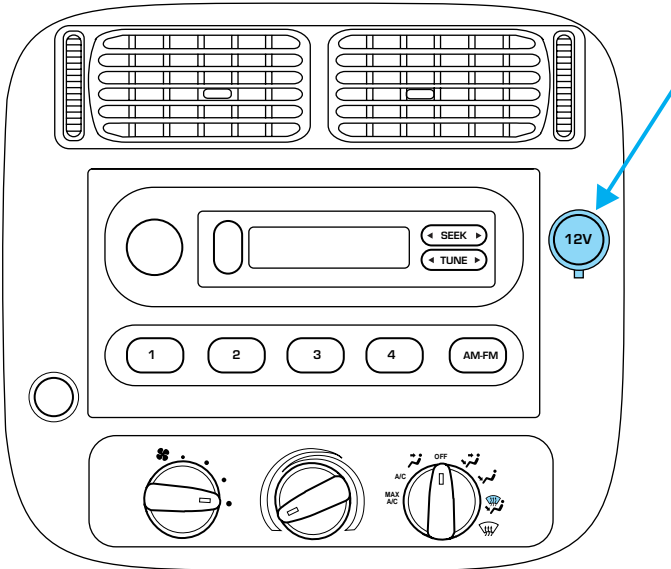

The auxiliary power point is located on the instrument panel. This outlet should be used in place of the cigarette lighter for optional electrical accessories.

PASSENGER AIR BAG ON/OFF SWITCH

This switch must be used to deactivate the passenger air bag whenever a child seat is used in the right front or center front passenger seat position. Refer to *Passenger air bag ON/OFF switch* in the *Seating and safety restraints* chapter.

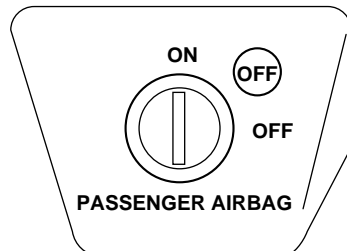

Controls and features

USING YOUR AUDIO SYSTEM

AM/FM Stereo

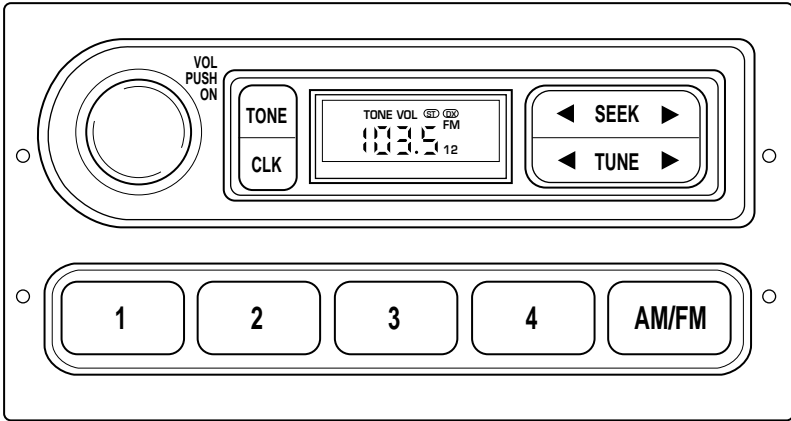

Volume/power control

Press the control to turn the audio system on or off.

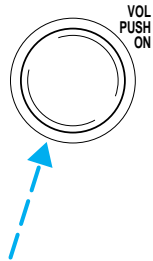

Turn the control to raise or lower volume.

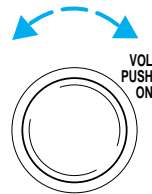

Controls and features

If the volume is set above a certain level and the ignition is turned off, the volume will come back on at a “nominal” listening level when the ignition switch is turned back on.

AM/FM select

The AM/FM select control works in radio mode.



AM/FM select in radio mode

This control allows you to select AM or FM frequency bands. Press the control to switch between AM, FM1 or FM2 memory preset stations.

Tune adjust

The tune control works in radio mode.

Tune adjust in radio mode

- Press ◀ to move to the next frequency down the band (whether or not a listenable station is located there). Hold the control to move through the frequencies quickly.
- Press ▶ to move to the next frequency up the band (whether or not a listenable station is located there). Hold for quick movement.



Seek function

The seek function control works in radio mode.

Seek function in radio mode

- Press ◀ to find the next listenable station down the frequency band.
- Press ▶ to find the next listenable station up the frequency band.

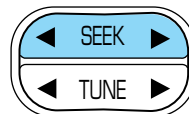

Controls and features

Radio station memory preset

The radio is equipped with four station memory preset controls. These controls can be used to select up to four preset AM stations and eight FM stations (four in FM1 and four in FM2).

Setting memory preset stations

1. Select the frequency band with the AM/FM select control.
2. Select a station. Refer to *Tune adjust* or *Seek function* for more information on selecting a station.
3. Press and hold a memory preset control until the sound returns, indicating the station is held in memory on the control you selected.



Bass adjust

The bass adjust control allows you to increase or decrease the audio system's bass output.

Press the TONE control once, then use the volume knob to adjust the desired level.

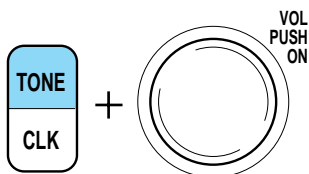

Treble adjust

The treble adjust control allows you to increase or decrease the audio system's treble output.

Press the TONE control twice, then use the volume knob to adjust the desired level.

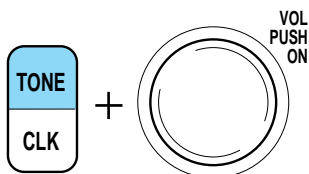

Controls and features

Speaker balance adjust

Speaker sound distribution can be adjusted between the right and left speakers.

Press the TONE control three times, then use the volume knob to adjust the desired level.

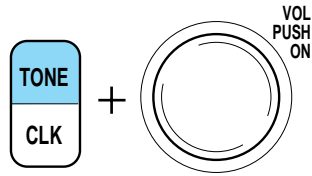

Speaker fade adjust (if equipped)

Speaker sound can be adjusted between the front and rear speakers.

Press the TONE control four times, then use the volume knob to adjust the desired level.

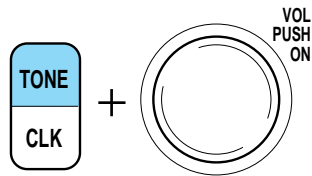

Setting the clock

Press CLK to toggle between listening frequencies and clock mode.

To set the hour, press and hold the CLK control until CLOCK SET appears in the display and press the SEEK control:



- ◀ to decrease hours and
- ▶ to increase hours.

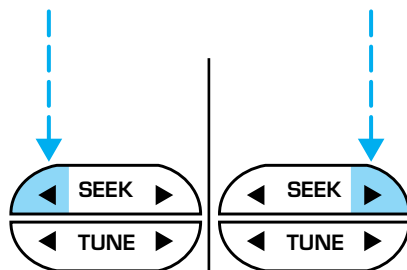

Controls and features

To set the minute, press and hold the CLK control until CLOCK SET appears in the display and press the TUNE control:

- ◀ to decrease minutes and
- ▶ to increase minutes.

The CLK control will allow you to switch between media display mode (radio station, stereo information, etc.) and clock display mode (time). When in clock mode, the media information will display for ten seconds, when the radio is turned on, and then revert to clock information. Anytime that the media is changed, (new radio station, etc.), the media information will again display for ten seconds before reverting back to the clock. In media mode, the media information will always be displayed.

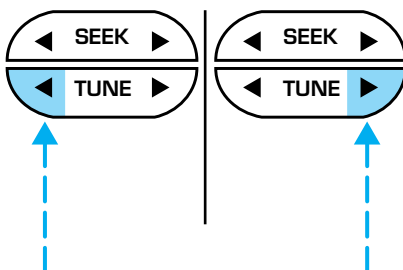

AM/FM stereo cassette

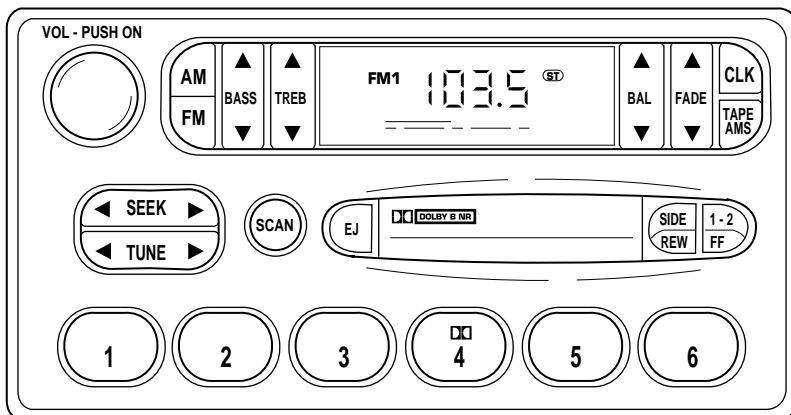

Controls and features

Volume/power control

Press the control to turn the audio system on or off.



Turn the control to raise or lower volume.



If the volume is set above a certain level and the ignition is turned off, the volume will come back on at a “nominal” listening level when the ignition switch is turned back on.

AM/FM select

The AM/FM select control works in radio and tape modes.

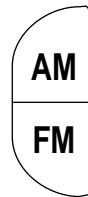

AM/FM select in radio mode

This control allows you to select AM or FM frequency bands. Press the AM control to select from AM selections, and press the FM control to select from FM1 or FM2 memory preset stations.

AM/FM select in tape mode

Press this control to stop tape play and begin radio play.

Controls and features

Tune adjust

The tune control works in radio mode.

Tune adjust in radio mode

- Press ◀ to move to the next frequency down the band (whether or not a listenable station is located there). Hold the control to move through the frequencies quickly.
- Press ▶ to move to the next frequency up the band (whether or not a listenable station is located there). Hold for quick movement.



Seek function

The seek function control works in radio mode.

Seek function in radio mode

- Press ◀ to find the next listenable station down the frequency band.
- Press ▶ to find the next listenable station up the frequency band.

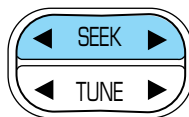

Scan function

The scan function works in radio mode.



Scan function in radio mode

Press the SCAN control to hear a brief sampling of all listenable stations on the frequency band. Press the SCAN control again to stop the scan mode.

Radio station memory preset

The radio is equipped with six station memory preset controls. These controls can be used to select up to six preset AM stations and twelve FM stations (six in FM1 and six in FM2).

Controls and features

Setting memory preset stations

1. Select the frequency band with the AM or the FM select control.
2. Select a station. Refer to *Tune adjust* or *Seek function* for more information on selecting a station.
3. Press and hold a memory preset control until the sound returns, indicating the station is held in memory on the control you selected.

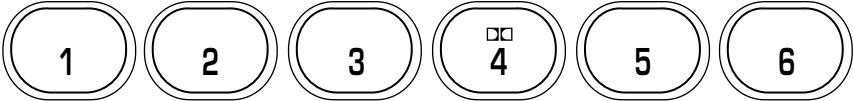

Bass adjust

The bass adjust control allows you to increase or decrease the audio system's bass output.

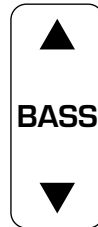

Treble adjust

The treble adjust control allows you to increase or decrease the audio system's treble output.



Controls and features

Speaker balance adjust

Speaker sound distribution can be adjusted between the right and left speakers.

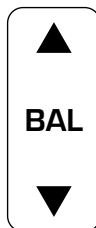

Speaker fade adjust

Speaker sound can be adjusted between the front and rear speakers.



Tape select

- To enter tape mode while in radio mode, press the TAPE AMS control.



Automatic Music Search

The Automatic Music Search feature allows you to quickly locate the beginning of the tape selection being played or to skip to the next selection.

To activate the feature, momentarily depress the TAPE AMS button.

Then, press either REW (for the beginning of the current selection) or FF (to advance to the next



Controls and features

selection). The tape deck stops and returns to play mode when the AMS circuit senses a blank section on the tape.

In order to ensure proper operation of the AMS feature, the tape **MUST** have a blank section of at least four seconds duration between programs.

Rewind

The rewind control works in tape mode.

To rewind in tape mode, press the REW control.

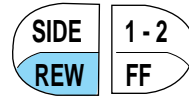

Fast forward

The fast forward control works in tape mode.

- In the tape mode, tape direction will automatically reverse when the end of the tape is reached.



Tape direction select

Press SIDE and 1-2 at the same time to play the alternate side of a tape.

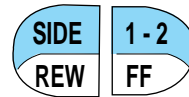

Eject function

Press the control to stop and eject a tape.



Dolby® noise reduction

Dolby® noise reduction operates only in tape mode. Dolby® noise reduction reduces the amount of hiss and static during tape playback.

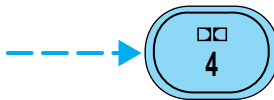

Press the  control to activate (and deactivate) Dolby® noise reduction.

Dolby® noise reduction is manufactured under license from Dolby® Laboratories Licensing Corporation. “Dolby®” and the double-D symbol are trademarks of Dolby Laboratories Licensing Corporation.

Controls and features

Setting the clock

Press CLK to toggle between listening frequencies and clock mode while in radio mode.

To set the hour, press and hold the CLK control and press the SEEK control:

- ◀ to decrease hours and
- ▶ to increase hours.

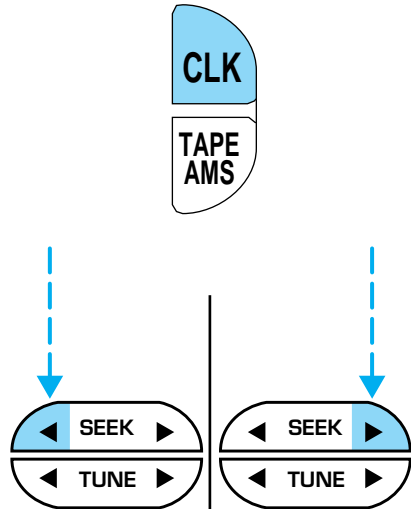

To set the minute, press and hold the CLK control and press the TUNE control:

- ◀ to decrease minutes and
- ▶ to increase minutes.

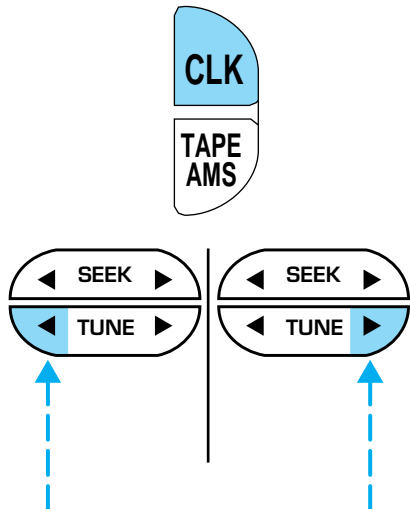

The CLK control will allow you to switch between media display mode (radio station, stereo information, etc.) and clock display mode (time).

Controls and features

When in clock mode, the media information will display for 10 seconds, when the radio is turned on, and then revert to clock information. Anytime that the media is changed, (new radio station, etc.), the media information will again display for 10 seconds before reverting back to the clock. In media mode, the media information will always be displayed.

AM/FM Stereo / Single CD Radio

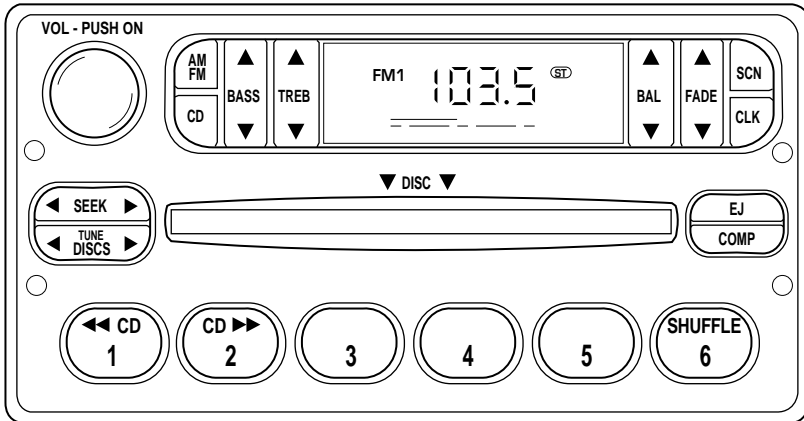

Volume/power control

Press the control to turn the audio system on or off.

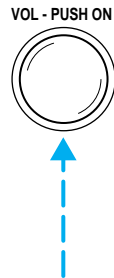

Controls and features

Turn the control to raise or lower volume.



If the volume is set above a certain level and the ignition is turned off, the volume will come back on at a “nominal” listening level when the ignition switch is turned back on.

AM/FM select

The AM/FM select control works in radio and CD modes.



AM/FM select in radio mode

This control allows you to select AM or FM frequency bands. Press the control to switch between AM, FM1 or FM2 memory preset stations.

AM/FM select in CD mode

Press this control to stop CD play and begin radio play.

Tune adjust

The tune control works in radio and CD changer mode (if equipped).

Tune adjust in radio mode



- Press ◀ to move to the next frequency down the band (whether or not a listenable station is located there). Hold the control to move through the frequencies quickly.



Controls and features

- Press  to move to the next frequency up the band (whether or not a listenable station is located there). Hold for quick movement.

Tune adjust for CD changer (if equipped)

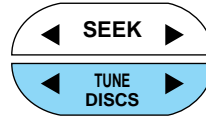

- Press  to select the previous disc in the CD changer. (Play will begin on the first track of the disc unless the CD changer is in shuffle mode. Refer to *Shuffle feature* for more information. Hold the control to continue reversing through the disc.
- Press  to select the next disc in the CD changer. Hold the control to fast-forward through the remaining discs.



Seek function



The seek function control works in radio or CD mode.

Seek function in radio mode

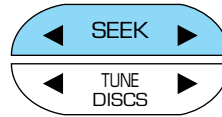
- Press  to find the next listenable station down the frequency band.
- Press  to find the next listenable station up the frequency band.



Seek function for CD mode

- Press  to seek to the previous track of the current disc. If a selection has been playing for three seconds or more and you press , the CD changer will replay that selection from the beginning.
- Press  to seek forward to the next track of the current disc. After the last track has been completed, the first track of the current disc will automatically replay.

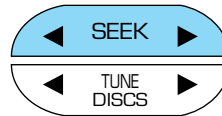

Scan function

The scan function works in radio or CD mode.



Controls and features

Scan function in radio mode

Press the SCAN control to hear a brief sampling of all listenable stations on the frequency band. Press the SCAN control again to stop the scan mode.

Scan function in CD mode

Press the SCAN control to hear a short sampling of all selections on the CD. (The CD scans in a forward direction, wrapping back to the first track at the end of the CD.) To stop on a particular selection, press the control again.

Bass adjust

The bass adjust control allows you to increase or decrease the audio system's bass output.

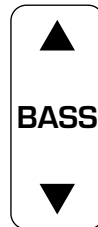

Treble adjust

The treble adjust control allows you to increase or decrease the audio system's treble output.



Speaker balance adjust

Speaker sound distribution can be adjusted between the right and left speakers.

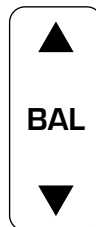

Controls and features

Speaker fade adjust

Speaker sound can be adjusted between the front and rear speakers.



CD select

- To begin CD play (if CD[s] are loaded), press the CD control. The first track of the disc will begin playing. After that, CD play will begin where it stopped last.

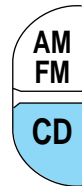

Rewind

The rewind control works in CD mode.

To rewind in CD mode, press the CD control (preset 1).

Press the control again to deactivate rewind mode.



Fast forward

The fast forward control works in CD mode.

To fast forward in CD changer mode, press the CD control (preset 2).

Press the control again to deactivate fast forward mode.



Eject function

Press the control to stop and eject a CD.



Controls and features

Compression feature

Compression adjust brings soft and loud CD passages together for a more consistent listening level.



Press the COMP control to activate and deactivate compression adjust.

Shuffle feature (if equipped with CD changer)

The shuffle feature operates in CD changer mode only and plays all tracks on the current disc in random order. The shuffle feature continues to the next disc after all tracks are played.



Press the SHUFFLE control to start this feature. Random order play will continue until the SHUFFLE control is pressed again.

Setting the clock

Press CLK to toggle between listening frequencies and clock mode while in radio mode.

To set the hour, press and hold the CLK control and press the SEEK control:



- ◀ to decrease hours and
- ▶ to increase hours.

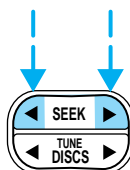

To set the minute, press and hold the CLK control and press the TUNE control:



Controls and features

- ◀ to decrease minutes and
- ▶ to increase minutes.

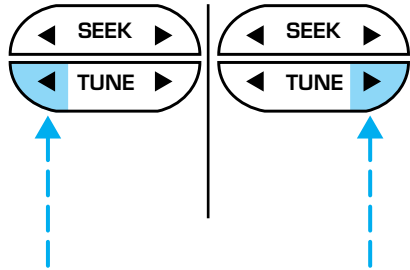

Premium AM/FM Stereo/Cassette/Single CD

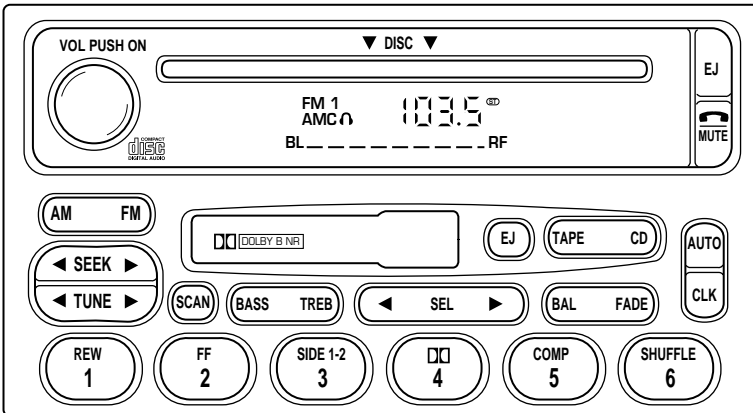

Volume/power control

Press the control to turn the audio system on or off.

Audio power can also be turned on by pressing the AM/FM select control or the tape/CD select control. Audio power is turned off by using the volume/power control.

VOL - PUSH ON

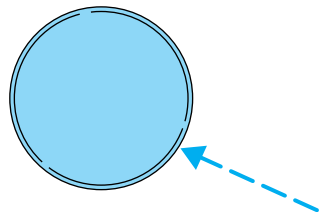

Controls and features

Turn control to raise or lower volume.

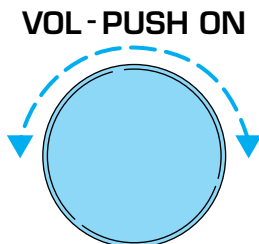

If the volume is set above a certain level and the ignition is turned off, the volume will come back on at a “nominal” listening level when the ignition switch is turned back on.

AM/FM select

The AM/FM select control works in radio, tape and CD modes.



AM/FM select in radio mode

This control allows you to select AM or FM frequency bands. Press the control to switch between AM, FM1 or FM2 memory preset stations.

AM/FM select in tape mode

Press this control to stop tape play and begin radio play.

Tune adjust

The tune control works in radio mode.

Tune adjust in radio mode

- Press ◀ to move to the next frequency down the band (whether or not a listenable station is located there). Hold the control to move through the frequencies quickly.
- Press ▶ to move to the next frequency up the band (whether or not a listenable station is located there). Hold for quick movement.

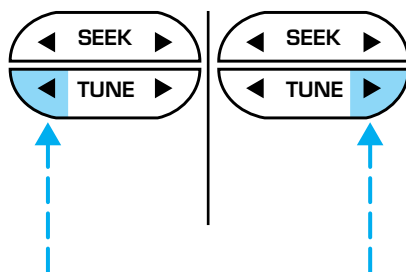

Controls and features

Seek function

The seek function control works in radio, tape or CD mode.

Seek function in radio mode

- Press ◀ to find the next listenable station down the frequency band.
- Press ▶ to find the next listenable station up the frequency band.

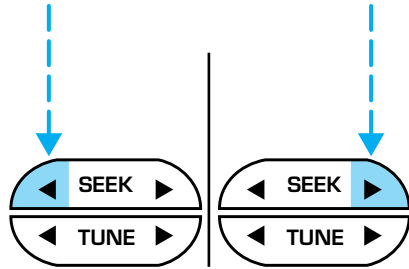

Seek function in tape mode

- Press ◀ to listen to the previous selection on the tape.
- Press ▶ to listen to the next selection on the tape.

Seek function in CD mode

- Press ◀ to seek to the previous track of the current disc.
- Press ▶ to seek forward to the next track of the current disc. After the last track has been completed, the first track of the current disc will automatically replay.

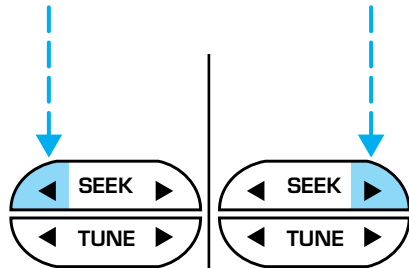

Scan function

The scan function works in radio, tape or CD mode.



Scan function in radio mode

Press the SCAN control to hear a brief sampling of all listenable stations on the frequency band. Press the control again to stop the scan mode.

Controls and features

Scan function in tape mode

Press the SCAN control to hear a short sampling of all selections on the tape. (The tape scans in a forward direction. At the end of the tape's first side, direction automatically reverses to the opposite side of the tape.) To stop on a particular selection, press the control again.

Scan function in CD mode

Press the SCAN control to hear a short sampling of all selections on the CD. (The CD scans in a forward direction, wrapping back to the first track at the end of the CD.) To stop on a particular selection, press the control again.

Radio station memory preset

The radio is equipped with six station memory preset controls. These controls can be used to select up to six preset AM stations and twelve FM stations (six in FM1 and six in FM2).

Setting memory preset stations



1. Select the frequency band with the AM/FM select control.
2. Select a station. Refer to *Tune adjust* or *Seek function* for more information on selecting a station.

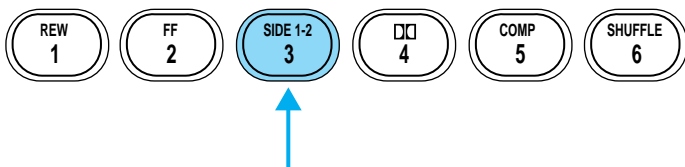

3. Press and hold a memory preset control until the sound returns, indicating the station is held in memory on the control you selected.

Autoset memory preset

Autoset allows you to set strong radio stations without losing your original manually set preset stations. This feature is helpful on trips when you travel between cities with different radio stations.

Controls and features

Starting autoselect memory preset

1. Select a frequency using the AM/FM select controls.
2. Press the AUTO control.
3. When the first six strong stations are filled, the station stored in memory preset control 1 will start playing.

If there are less than six strong stations available on the frequency band, the remaining memory preset controls will all store the last strong station available.

These stations are temporarily stored in the memory preset controls (until deactivated) and are accessed in the same manner of your original presets.

To deactivate autoselect and return to your audio system's manually set memory stations, press the AUTO control again.

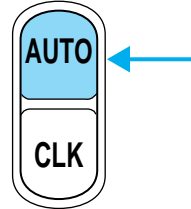

Bass adjust

The bass adjust control allows you to increase or decrease the audio system's bass output.

Press the BASS control then press:

- ◀ to decrease the bass output and
- ▶ to increase the bass output.

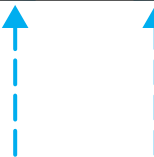
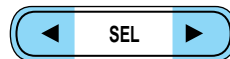
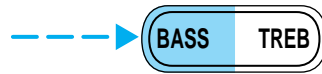

Treble adjust

The treble adjust control allows you to increase or decrease the audio system's treble output.



Controls and features

Press the TREB control then press:

- ◀ to decrease the treble output and
- ▶ to increase the treble output.

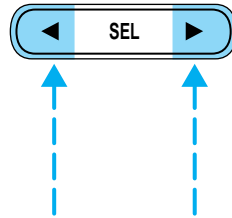

Speaker balance adjust

Speaker sound distribution can be adjusted between the right and left speakers.

Press the BAL control then press:

- ◀ to shift sound to the left and
- ▶ to shift sound to the right.

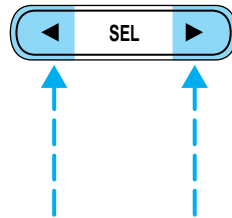

Speaker fade adjust

Speaker sound can be adjusted between the front and rear speakers.

Press the FADE control then press:

- ▶ to shift the sound to the front and
- ◀ to shift the sound to the rear.

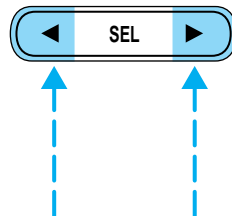

Controls and features

Tape select

- To begin tape play (with a tape loaded into the audio system) while in the radio or CD mode, press the TAPE control. Press the button during rewind or fast forward to stop the rewind or fast forward function.



Rewind

The rewind control works in tape and CD modes.

- In tape mode, radio play will continue until rewind is stopped (with the TAPE control) or the beginning of the tape is reached.
- In CD mode, pressing the REW control rewinds the CD within the current track.

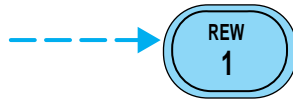

Fast forward

The fast forward control works in tape and CD modes.

- In the tape mode, tape direction will automatically reverse when the end of the tape is reached.
- In CD mode, pressing the control fast forwards the CD within the current track.

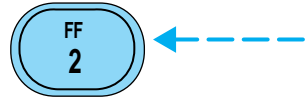

Tape direction select

Press SIDE 1-2 to play the alternate side of a tape.

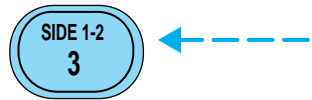

Eject function

Press the EJ control to stop and eject a tape.

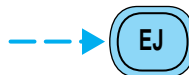

Controls and features

Press the EJ control to stop and eject a CD.

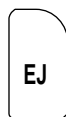

Dolby® noise reduction

Dolby® noise reduction operates in tape mode. Dolby® noise reduction reduces the amount of hiss and static during tape playback.

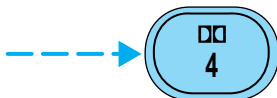

Press the  control to activate (and deactivate) the Dolby® noise reduction.

Dolby® noise reduction is manufactured under license from Dolby® Laboratories Licensing Corporation. “Dolby®” and the double-D symbol  are trademarks of Dolby® Laboratories Licensing Corporation.

Compression adjust

Compression adjust brings soft and loud CD passages together for a more consistent listening level.

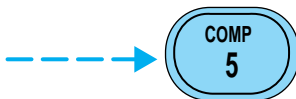

Press the COMP control to activate and deactivate compression adjust.

Shuffle feature

The shuffle feature operates in CD mode (if equipped) and plays all tracks on the current disc in random order. If equipped with the CD changer, the shuffle feature

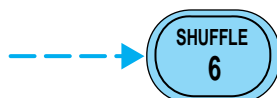

continues to the next disc after all tracks on the current disc are played.

Press the SHUFFLE control to start this feature. Random order play will continue until the SHUFFLE control is pressed again.

Controls and features

Setting the clock

To set the hour, press and hold the CLK control and press SEEK:

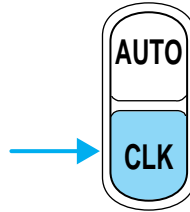

- ◀ to decrease hours and
- ▶ to increase hours.

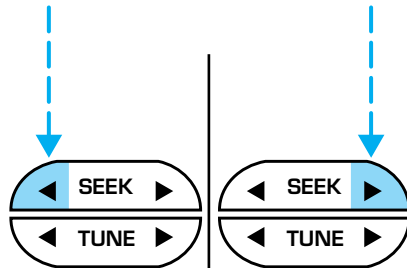

To set the minute, press and hold the CLK control and press TUNE:

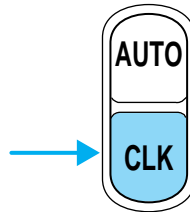

- ◀ to decrease minutes and
- ▶ to increase minutes.

If your vehicle has a separate clock module, (other than the digital radio display), the CLK button will not function in the above manner.

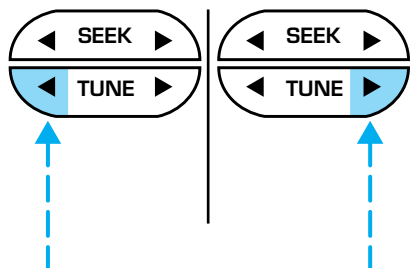

Controls and features

The CLK button will allow you to switch between media display mode (radio station, stereo information, etc.) and clock display mode (time).

When in clock mode, the media information will display for 10 seconds, when the radio is turned on, and then revert to clock information. Anytime that the media is changed, (new radio station, etc.), the media information will again display for 10 seconds before reverting back to the clock. In media mode, the media information will always be displayed.

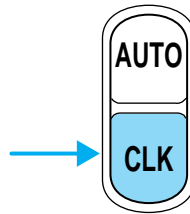

Mute mode

Press the control to mute the playing media. Press the control again to return to the playing media.

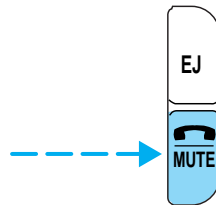

Cleaning compact discs

Inspect all discs for contamination before playing. If necessary, clean discs only with an approved CD cleaner and wipe the center out to the edge. Do not use circular motion.

Cleaning cassette player (if equipped)

Clean the tape player head with a cassette cleaning cartridge after 10 to 12 hours of play in order to maintain the best sound and operation.

Cassette and cassette player care

- Use only cassettes that are 90 minutes long or less.
- Do not expose tapes to direct sunlight, high humidity, extreme heat or extreme cold. Allow tapes that may have been exposed to extreme temperatures to reach a moderate temperature before playing.
- Tighten very loose tapes by inserting a finger or pencil into the hole and turning the hub.
- Remove loose labels before inserting tapes.

Controls and features

- Do not leave tapes in the cassette player for a long time when not being played.

Radio frequency information

The Federal Communications Commission (FCC) and the Canadian Radio and Telecommunications Commission (CRTC) establish the frequencies AM and FM stations may use for their broadcasts. Allowable frequencies are:

AM 530, 540–1600, 1610 kHz

FM 87.7, 87.9–107.7, 107.9 MHz

Not all frequencies are used in a given area.

Radio reception factors

Three factors can affect radio reception:

- **Distance/strength.** The further an FM signal travels, the weaker it is. The listenable range of the average FM station is approximately 40 km (24 miles). This range can be affected by “signal modulation.” Signal modulation is a process radio stations use to increase their strength/volume relative to other stations.
- **Terrain.** Hills, mountains and tall buildings between your vehicle’s antenna and the radio station signal can cause FM reception problems. Static can be caused on AM stations by power lines, electric fences, traffic lights and thunderstorms. Moving away from an interfering structure (out of its “shadow”) returns your reception to normal.
- **Station overload.** Weak signals are sometimes captured by stronger signals when you pass a broadcast tower. A stronger signal may temporarily overtake a weaker signal and play while the weak station frequency is displayed.

The audio system automatically switches to single channel reception if it will improve the reception of a station normally received in stereo.

Audio system warranties and service

Refer to the “Warranty Guide” for audio system warranty information.

If service is necessary, see your dealer or a qualified technician.

Controls and features

TURN SIGNAL CONTROL ⇐⇒

- Push down to activate the left turn signal.
- Push up to activate the right turn signal.

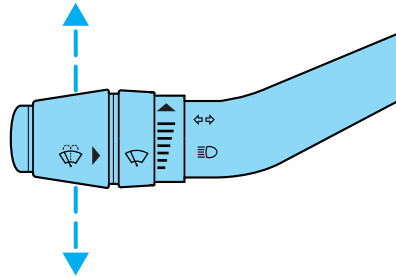

POSITIONS OF THE IGNITION

1. ACCESSORY, allows the electrical accessories such as the radio to operate while the engine is not running.

2. LOCK, locks the steering wheel, automatic transmission gearshift lever and allows key removal.

3. OFF, shuts off the engine and all accessories without locking the steering wheel.

4. ON, all electrical circuits operational. Warning lights illuminated. Key position when driving.

5. START, cranks the engine. Release the key as soon as the engine starts.

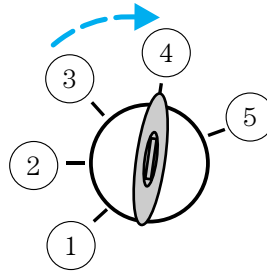

Controls and features

SPEED CONTROL (IF EQUIPPED)

To turn speed control on

- Press ON.

Vehicle speed cannot be controlled until the vehicle is traveling at or above 48 km/h (30 mph).

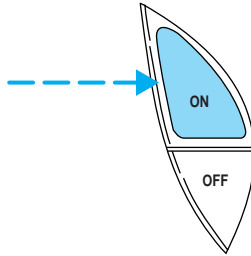

Do not use the speed control in heavy traffic or on roads that are winding, slippery, or unpaved.



Do not shift the gearshift lever into N (Neutral) with the speed control on.

To turn speed control off

- Press OFF or
- Turn off the vehicle ignition.

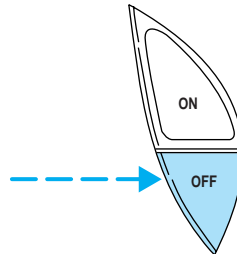

Once speed control is switched off, the previously programmed set speed will be erased.

Controls and features

To set a speed

- Press SET/SET ACC/SET ACCEL. For speed control to operate, the speed control must be ON and the vehicle speed must be greater than 48 km/h (30 mph).

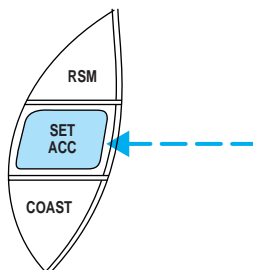

If you drive up or down a steep hill, your vehicle speed may vary momentarily slower or faster than the set speed. This is normal.

Speed control cannot reduce the vehicle speed if it increases above the set speed on a downhill. If your vehicle speed is faster than the set speed while driving on a downhill, you may want to shift to the next lower gear or apply the brakes to reduce your vehicle speed.

If your vehicle slows down more than 16 km/h (10 mph) below your set speed on an uphill, your speed control will disengage. This is normal. Pressing RES/RSM/RESUME will re-engage it.



Do not use the speed control in heavy traffic or on roads that are winding, slippery, or unpaved.

To set a higher set speed

- Press and hold SET/SET ACC/SET ACCEL. Release the control when the desired vehicle speed is reached or
- Press and release SET/SET ACC/SET ACCEL. Each press will increase the set speed by 1.6 km/h (1 mph) or
- Accelerate with your accelerator pedal. When the desired vehicle speed is reached, press and release SET/SET ACC/SET ACCEL.

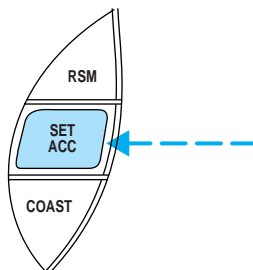

Controls and features

You can accelerate with the accelerator pedal at any time during speed control usage. Releasing the accelerator pedal will return your vehicle to the previously programmed set speed.

To set a lower set speed

- Press and hold CST/COAST. Release the control when the desired speed is reached or
- Press and release CST/COAST. Each press will decrease the set speed by 1.6 km/h (1 mph) or
- Depress the brake pedal. When the desired vehicle speed is reached, press SET/SET ACC/SET ACCEL.

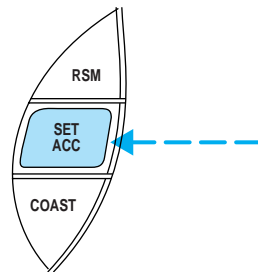
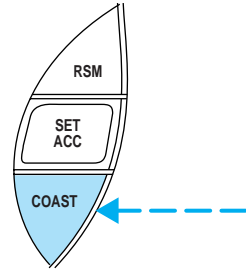

Controls and features

To disengage speed control

- Depress the brake pedal or

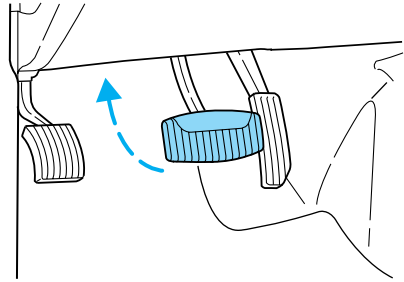

- Depress the clutch pedal (if equipped).

Disengaging the speed control will not erase the previously programmed set speed.

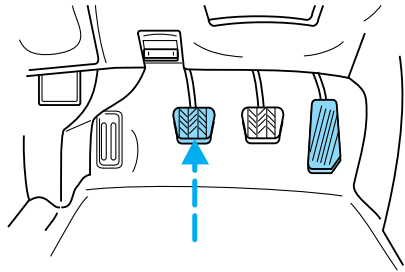

Pressing OFF will erase the previously programmed set speed.

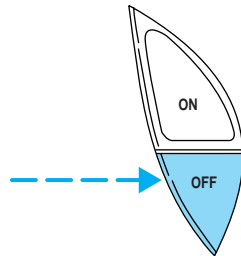

Controls and features

To return to a previously set speed

- Press RES/RSM/RESUME. For RES/RSM/RESUME to operate, the vehicle speed must be faster than 48 km/h (30 mph).

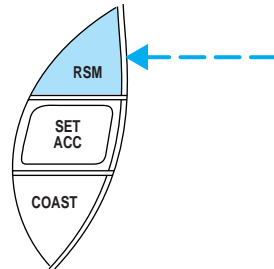

Indicator light (if equipped)

This light comes on when either the SET ACC/SET ACCEL or RES/RSM/RESUME controls are pressed. It turns off when the speed control OFF control is pressed, the brake is applied or the ignition is turned to the OFF position.

**SPEED
CONT**

OVERDRIVE CONTROL (IF EQUIPPED)

Activating overdrive

D (Overdrive) is the normal drive position for the best fuel economy. The overdrive function allows automatic upshifts and downshifts through all available gears.

Deactivating overdrive

Press the Transmission Control Switch (TCS) located on the end of the gearshift lever. The Transmission Control Indicator Light (TCIL) will illuminate on the instrument cluster.

The transmission will operate in all gears except overdrive. To return to normal overdrive mode, press the Transmission Control Switch again. The TCIL will no longer be illuminated.

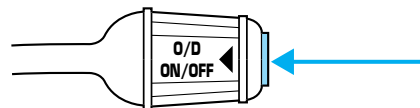
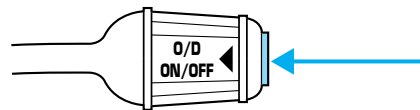

Controls and features

When you shut off and re-start your vehicle, the transmission will automatically return to normal **D** (Overdrive) mode.

For additional information about the gearshift lever and the transmission control switch operation refer to the *Automatic Transmission Operation* section of the *Driving* chapter.

TILT STEERING WHEEL (IF EQUIPPED)

Pull the tilt steering control toward you to move the steering wheel up or down. Hold the control while adjusting the wheel to the desired position, then release the control to lock the steering wheel in position.

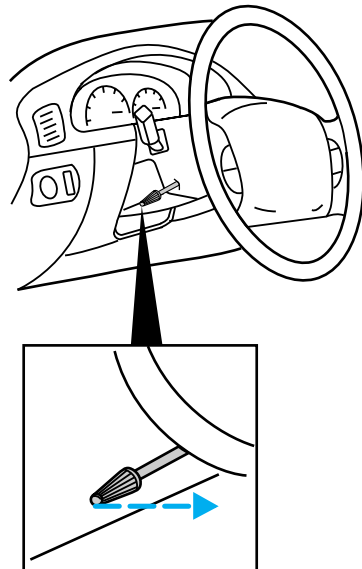

Never adjust the steering wheel when the vehicle is moving.

HAZARD FLASHER

For information on the hazard flasher control, refer to *Hazard flasher* in the *Roadside emergencies* chapter.

Controls and features

WINDSHIELD WIPER/WASHER CONTROLS

Rotate the windshield wiper control to the desired interval, low or high speed position.

The bars of varying length are for intermittent wipers. When in this position rotate the control upward for fast intervals and downward for slow intervals.

Push (tap) the end of the stalk briefly for a single swipe (no wash). Push and hold for three swipes with wash. Push and hold for a longer wash (up to ten seconds).

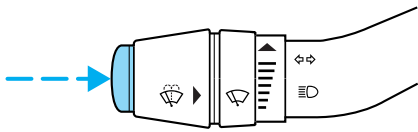
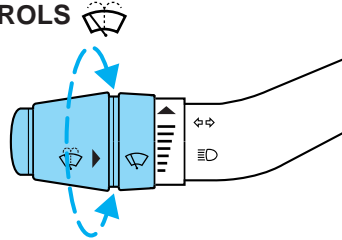

POWER WINDOWS (IF EQUIPPED)

Press and hold the rocker switches to open and close windows.

- Press the top portion of the rocker switch to close.

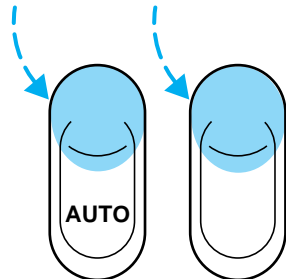

- Press the bottom portion of the rocker switch to open.

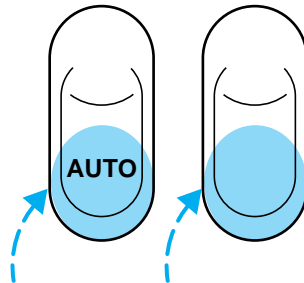

Controls and features

One touch down

- Press AUTO completely down and release quickly. The driver's window will open fully. Depress again to stop window operation.

One touch down can be deactivated during operation by pushing up on the power window control.

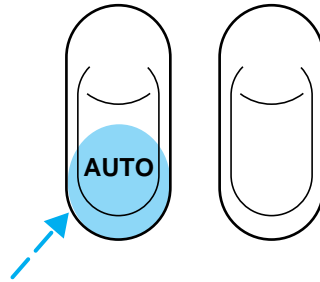

POWER DOOR LOCKS (IF EQUIPPED)

Press the top of the control to unlock all doors and the bottom to lock all doors.

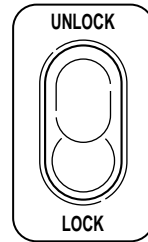

POWER SIDE VIEW MIRRORS (IF EQUIPPED)

To adjust your mirrors:

1. Select ◀ to adjust the left mirror or ▶ to adjust the right mirror.
2. Move the control in the direction you wish to tilt the mirror.

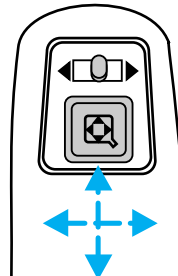

3. Return to the center position to lock mirrors in place.

Controls and features

CENTER CONSOLE (IF EQUIPPED)

Your vehicle may be equipped with a variety of console features. These include:

- Utility compartment with cassette/compact disc storage
- Cupholders
- Coin holder slots
- Flip up armrest
- Removable utility bag (if equipped)

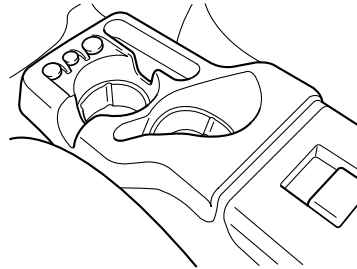

Use only soft cups in the cupholder. Hard objects can injure you in a collision.

CARGO AREA FEATURES

Cargo area shade (if equipped)

Your vehicle may be equipped with notches in the side trim panels that are used for a cargo area shade. See your dealer for more information.

REMOTE ENTRY SYSTEM (IF EQUIPPED)

The remote entry system allows you to lock or unlock all vehicle doors without a key.

The remote entry features only operate with the ignition in the OFF position.

If there is any potential remote keyless entry problem with your vehicle, ensure **ALL key fobs** (remote entry transmitters) are brought to the dealership, to aid in troubleshooting.

Controls and features

Unlocking the doors

Press this control to unlock the driver's door. The interior lamps will illuminate.

Press the control a second time within five seconds to unlock all doors.

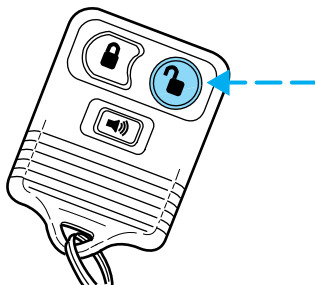

Locking the doors

Press this control to lock all doors.

To confirm all doors are closed and locked, press the control a second time within five seconds. The doors will lock again, the horn will chirp and the lamps will flash.

If any of the doors are ajar, the horn will make two quick chirps, reminding you to properly close all doors.

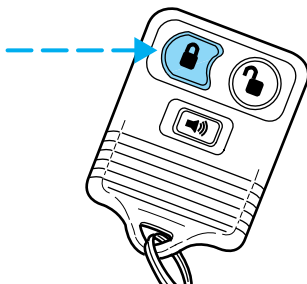

Sounding a panic alarm

Press this control to activate the alarm.

To deactivate the alarm, press the control again or turn the ignition to ACC or ON.

This device complies with part 15 of the FCC rules and with RS-210 of Industry Canada. Operation is subject to the following two conditions: (1) This device may not cause harmful interference, and (2) This device must accept any interference received, including interference that may cause undesired operation.

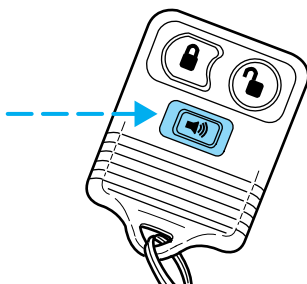

Controls and features

Changes or modifications not expressly approved by the party responsible for compliance could void the user's authority to operate the equipment.

Replacing the battery

The transmitter is powered by one coin type three-volt lithium battery CR2032 or equivalent. Typical operating range will allow you to be up to 10 meters (33 feet) away from your vehicle. A decrease in operating range can be caused by:

- weather conditions
- nearby radio towers
- structures around the vehicle
- other vehicles parked next to the vehicle

To replace the battery:

1. Twist a thin coin between the two halves of the transmitter near the key ring. **DO NOT TAKE THE FRONT PART OF THE TRANSMITTER APART.**
2. Place the positive (+) side of new battery in the same orientation. Refer to the diagram inside the transmitter unit.
3. Snap the two halves back together.

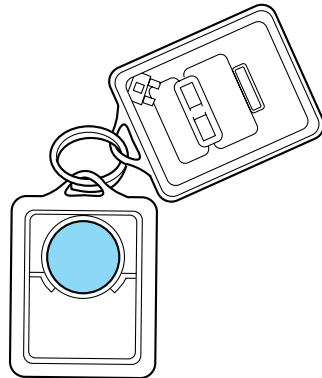

Controls and features

Replacing lost transmitters

If a remote transmitter has been lost and you would like to remove it from the vehicle's memory, or you would like to purchase additional remote transmitters and have them programmed to your vehicle:

- Take **all** your vehicle's transmitters to your dealer for programming, or
- Perform the programming procedure yourself

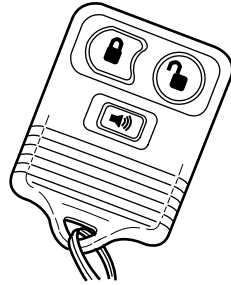

Programming remote transmitters

It is necessary to have **all** (maximum of four — original and/or new) of your remote transmitters available prior to beginning this procedure.

To program the transmitters yourself:

- Insert a key in the ignition and turn from 3 (OFF) to 4 (ON) eight times in rapid succession (within 10 seconds) with the eighth turn ending in the 4 (ON) position. The doors will lock/unlock to confirm that programming mode has been entered.
- Within 20 seconds, program a remote transmitter by pressing any button on a transmitter. The doors will lock/unlock to confirm that the remote transmitter has been programmed. (If more than 20 seconds pass before pressing a remote transmitter button, the programming mode will exit and the procedure will have to be repeated.)
- Repeat the previous step to program additional remote transmitters. The doors will lock/unlock to confirm that each remote transmitter has been programmed.
- When you have completed programming the remote transmitters, turn the ignition to 3 (OFF) or wait 20 seconds. Again the doors will lock/unlock to confirm programming has been completed.

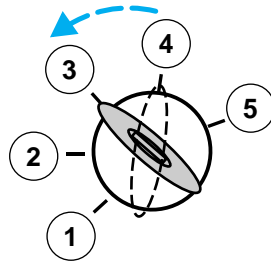

Controls and features

Illuminated entry

The interior lamps illuminate when the remote entry system is used to unlock the door(s) or sound the personal alarm.

The system automatically turns off after 25 seconds or when the ignition is turned to the RUN or ACC position. The dome lamp control (if equipped) must **not** be set to the OFF position for the illuminated entry system to operate.

The inside lights will not turn off if:

- they have been turned on with the dimmer control or
- any door is open.

The battery saver will shut off the interior lamps 40 minutes after the ignition has been turned to the OFF position.

SECURILOCK™ PASSIVE ANTI-THEFT SYSTEM (IF EQUIPPED)

The SecuriLock™ passive anti-theft system provides an advanced level of vehicle theft protection. Your vehicle's engine can only be started with the two special SecuriLock™ electronically coded keys provided with your vehicle. Each time you start your vehicle, the SecuriLock™ key is read by the SecuriLock™ passive anti-theft system. If the SecuriLock™ key identification code matches the code stored in the SecuriLock™ passive anti-theft system, the vehicle's engine is allowed to start. If the SecuriLock™ key identification code does not match the code stored in the system or if a SecuriLock™ key is not detected (vehicle theft situation), the vehicle's engine will not operate.

If there is any potential SecuriLock™ anti-theft problem with your vehicle, ensure **ALL SecuriLock™ keys** for that vehicle are brought to the dealership, to aid in troubleshooting.

The SecuriLock™ passive anti-theft system is not compatible with aftermarket remote start systems. Use of these systems may result in vehicle starting problems and a loss of security protection. Large metallic objects, electronic devices on the key chain that can be used to purchase gasoline or similar items, or a second key on the same key ring as the PATS ignition key may cause vehicle starting concern and record DTC's under certain conditions. If present, you need to keep these objects from touching the PATS ignition key while starting the engine. These objects and devices cannot damage the PATS ignition key, but can cause a momentary concern if they are too close to the key during engine start. If a problem occurs, turn ignition OFF and restart the engine with all

Controls and features

other objects on the key ring held away from the ignition key. Check to make sure the encoded ignition key is an approved Ford encoded ignition key.

Spare SecuriLock™ keys can be purchased from your dealership and programmed to your SecuriLock™ passive anti-theft system. Refer to *Programming spare SecuriLock™ keys* for more information.

If one or both of your SecuriLock™ keys are lost or stolen and you want to ensure the lost or stolen key will not operate your vehicle, bring your vehicle and all available SecuriLock™ keys to your dealership for reinitialization.

Theft indicator

The theft indicator on the instrument cluster will operate as follows:

- When the ignition is OFF, the theft indicator will flash briefly every two seconds to indicate the SecuriLock™ system is protecting your vehicle.
- When the ignition is turned to RUN or START, the theft indicator will light for three seconds and then go out. If the theft indicator stays on for an extended period of time or flashes rapidly, have the system serviced by your dealership or a qualified technician.

The Theft indicator is controlled by the *SecuriLock™ system*. During the 30 second prearm state, it is normal to see the theft indicator pulse brighter behind the constant glow.

Programming spare SecuriLock™ keys

Spare SecuriLock™ keys can be purchased from your dealership and programmed to your SecuriLock™ passive anti-theft system (up to a total of eight keys). Your dealership can program your new SecuriLock™ key(s) to your vehicle or you can do it yourself using the following simple procedure. To program a new SecuriLock™ key yourself, you will need two previously programmed SecuriLock™ keys (keys that already operate your vehicle's engine). If two previously programmed SecuriLock™ keys are not available (one or both of your original keys were lost or stolen), you must bring your vehicle to your dealership to have the spare SecuriLock™ key(s) programmed.

Controls and features

Procedure to program spare SecuriLock™ keys to your vehicle

New SecuriLock™ keys must have the correct mechanical key cut for your vehicle.

Conventional (non-SecuriLock™) keys **cannot** be programmed to your vehicle.

You will need to have two previously programmed SecuriLock™ keys and the new unprogrammed SecuriLock™ key readily accessible for the procedure. Please read and understand the entire procedure before you begin.

1. Insert the first previously programmed SecuriLock™ key into the ignition and turn the ignition from OFF to ON (maintain ignition in ON for at least one second).
2. Turn ignition to OFF and remove the first SecuriLock™ key from the ignition.
3. Within five seconds of turning the ignition to OFF, insert the second previously programmed SecuriLock™ key into the ignition and turn the ignition from OFF to ON (maintain ignition in ON for at least one second but no more than five seconds).
4. Turn the ignition to OFF and remove the second SecuriLock™ key from the ignition.
5. Within 10 seconds of turning the ignition to OFF, insert the unprogrammed SecuriLock™ key (new key/valet key) into the ignition and turn the ignition from OFF to ON (maintain ignition in ON for at least one second). This step will program your new SecuriLock™ key.
6. To program additional SecuriLock™ key(s), repeat this procedure from step 1.

If the programming procedure was successful, the new SecuriLock™ key(s) will start the vehicle's engine. The theft indicator (located on the instrument cluster) will light for three seconds and then go out.

If the programming procedure was not successful, the new SecuriLock™ key(s) will not operate the vehicle's engine. The theft indicator will flash on and off. Wait at least one minute and then repeat the procedure from step 1. If failure repeats, bring your vehicle to your dealership to have the spare SecuriLock™ key(s) programmed.

Seating and safety restraints

SEATING

Adjusting the front manual seat



Never adjust the driver's seat or seatback when the vehicle is moving.



Do not pile cargo higher than the seatbacks to reduce the risk of injuring people in a collision or sudden stop.



Always drive and ride with your seatback upright and the lap belt snug and low across the hips.



Reclining the seatback can reduce the effectiveness of the seat's safety belt in the event of a collision.

Lift handle to move seat forward or backward.

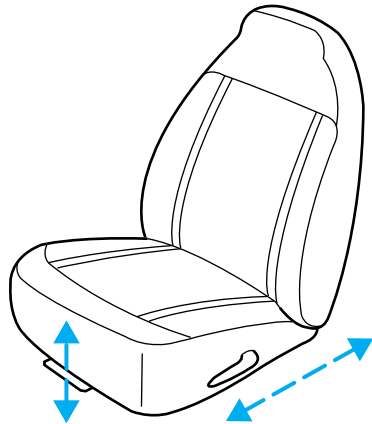

Seating and safety restraints

Pull lever up to adjust seatback.

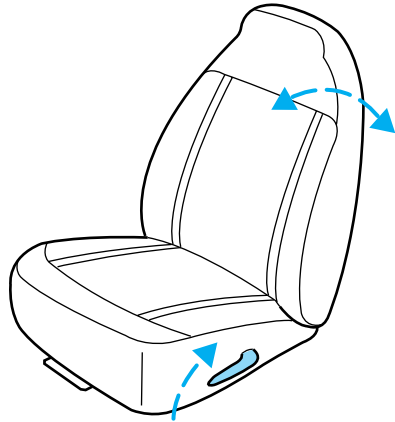

Using the manual lumbar support (if equipped)

Turn the lumbar support control clockwise to increase firmness.

Turn the lumbar support control counterclockwise to increase softness.

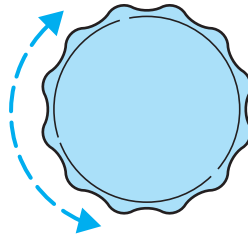

REAR SEATS

Center facing jump seat (2 door SuperCab) (if equipped)

To open, pull inboard and down on the seat handle.

To stow the seat, pull seat bottom back to the fully upright position.



Do not install a child seat in a center facing jump seat.

Seating and safety restraints

Center facing jump seat (4 door SuperCab) (if equipped)

To open, pull seat assembly down, then raise seatback.

To stow the seat, fold seat back down and raise seat assembly to the fully upright position.



Do not install a child seat in a center facing jump seat.

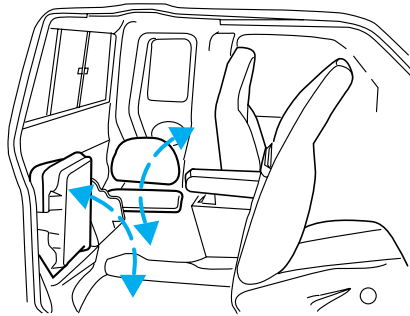

SAFETY RESTRAINTS

Safety restraints precautions



Always drive and ride with your seatback upright and the lap belt snug and low across the hips.



To reduce the risk of injury, make sure children sit where they can be properly restrained.



Never let a passenger hold a child on his or her lap while the vehicle is moving. The passenger cannot protect the child from injury in a collision.



All occupants of the vehicle, including the driver, should always properly wear their safety belts, even when an air bag SRS is provided.



It is extremely dangerous to ride in a cargo area, inside or outside of a vehicle. In a collision, people riding in these areas are more likely to be seriously injured or killed. Do not allow people to ride in any area of your vehicle that is not equipped with seats and safety belts. Be sure everyone in your vehicle is in a seat and using a safety belt properly.

Seating and safety restraints



In a rollover crash, an unbelted person is significantly more likely to die than a person wearing a seat belt.



Each seating position in your vehicle has a specific safety belt assembly which is made up of one buckle and one tongue that are designed to be used as a pair. 1) Use the shoulder belt on the outside shoulder only. Never wear the shoulder belt under the arm. 2) Never swing the safety belt around your neck over the inside shoulder. 3) Never use a single belt for more than one person.



On four-door SuperCab vehicles, do not open the rear door when the rear seat belt is still buckled.

Combination lap and shoulder belts

1. Insert the belt tongue into the proper buckle (the buckle closest to the direction the tongue is coming from) until you hear a snap and feel it latch. Make sure the tongue is securely fastened in the buckle.

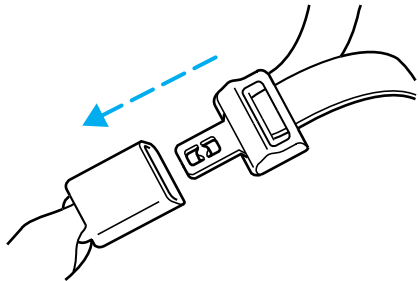

2. To unfasten, push the release button and remove the tongue from the buckle.

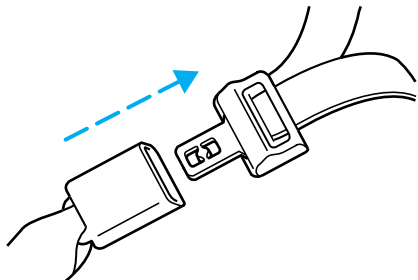

Seating and safety restraints

The front outboard safety restraints in the vehicle are combination lap and shoulder belts. The front passenger outboard safety belt has two types of locking modes described below:

Energy Management Feature

- This vehicle has a seat belt system with an energy management feature at the front outboard seating positions to help further reduce the risk of injury in the event of a head-on collision.
- This seat belt system has a retractor assembly that is designed to pay out webbing in a controlled manner. This feature is designed to help reduce the belt force acting on the occupant's chest.



After any vehicle collision, the seat belt system at all outboard seating positions (except driver, which has no “automatic locking retractor” feature) must be checked by a qualified technician to verify that the “automatic locking retractor” feature for child seats is still functioning properly. In addition, all seat belts should be checked for proper function.



BELT AND RETRACTOR ASSEMBLY MUST BE REPLACED if the seat belt assembly “automatic locking retractor” feature or any other seat belt function is not operating properly when checked according to the procedures in Workshop Manual.



Failure to replace the Belt and Retractor assembly could increase the risk of injury in collisions.

Vehicle sensitive mode

The vehicle sensitive mode is the normal retractor mode, allowing free shoulder belt length adjustment to your movements and locking in response to vehicle movement. For example, if the driver brakes suddenly or turns a corner sharply, or the vehicle receives an impact of approximately 8 km/h (5 mph) or more, the combination safety belts will lock to help reduce forward movement of the driver and passengers.

Automatic locking mode

In this mode, the shoulder belt is automatically pre-locked. The belt will still retract to remove any slack in the shoulder belt.

The automatic locking mode is not available on the driver safety belt.

Seating and safety restraints

When to use the automatic locking mode

- **Anytime** a child safety seat is installed in a passenger front or outboard rear seating position (if equipped). Children 12 years old and under should be properly restrained in the rear seat whenever possible. Refer to *Safety Restraints for Children* or *Safety Seats for Children* later in this chapter.

How to use the automatic locking mode

- Buckle the combination lap and shoulder belt.

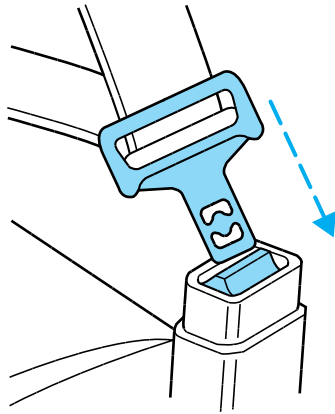

- Grasp the shoulder portion and pull downward until the entire belt is extracted.



- Allow the belt to retract. As the belt retracts, you will hear a clicking sound. This indicates the safety belt is now in the automatic locking mode.

Seating and safety restraints

How to disengage the automatic locking mode

Disconnect the combination lap/shoulder belt and allow it to retract completely to disengage the automatic locking mode and activate the vehicle sensitive (emergency) locking mode.



After any vehicle collision, the seat belt system at all outboard seating positions (except driver, which has no “automatic locking retractor” feature) must be checked by a qualified technician to verify that the “automatic locking retractor” feature for child seats is still functioning properly. In addition, all seat belts should be checked for proper function.



BELT AND RETRACTOR ASSEMBLY MUST BE REPLACED if the seat belt assembly “automatic locking retractor” feature or any other seat belt function is not operating properly when checked according to the procedures in Workshop Manual.



Failure to replace the Belt and Retractor assembly could increase the risk of injury in collisions.

Front safety belt height adjustment

Your vehicle has safety belt height adjustments for the driver and front passenger. Adjust the height of the shoulder belt so the belt rests across the middle of your shoulder.

Seating and safety restraints

- Regular Cab and 4-door Super Cab

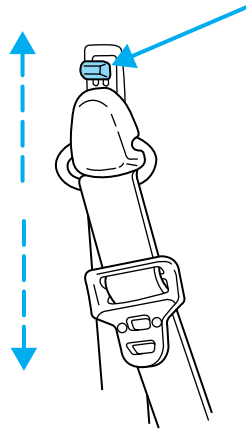

- 2-door SuperCab

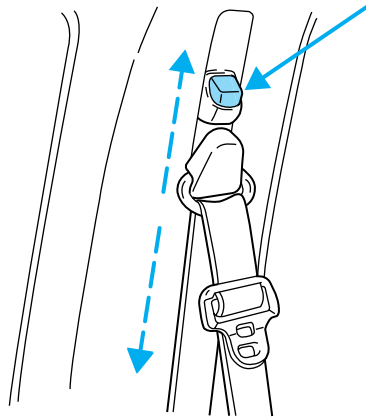

To lower the shoulder belt height, push the button and slide the height adjuster down. To raise the height of the shoulder belt, slide the height adjuster up. Pull down on the height adjuster to make sure it is locked in place.



Position the shoulder belt height adjusters so that the belt rests across the middle of your shoulder. Failure to adjust the safety belt properly could reduce the effectiveness of the seat belt and increase the risk of injury in a collision.

Seating and safety restraints

Lap belts

Adjusting the front center seat lap belt (if equipped)

The lap belt does not adjust automatically.



The lap belts should fit snugly and as low as possible around the hips, not around the waist.

Insert the tongue into the correct buckle (the buckle closest to the direction the tongue is coming from). To lengthen the belt, turn the tongue at a right angle to the belt and pull across your lap until it reaches the buckle. To tighten the belt, pull the loose end of the belt through the tongue until it fits snugly across the hips.

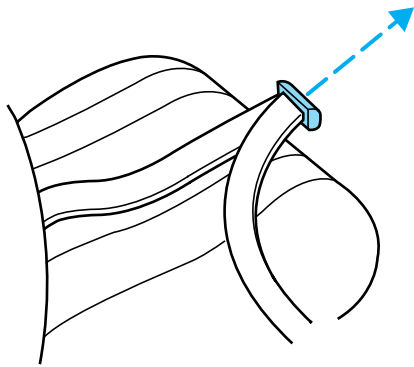

Shorten and fasten the belt when not in use.

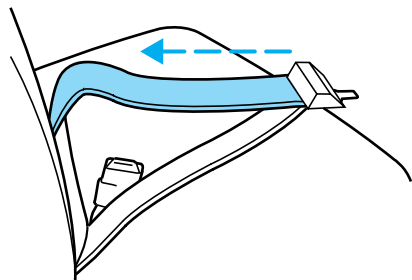

Adjusting the rear center facing jump seat lap belt (if equipped)

The lap belt will adjust automatically. To fasten, grasp the tongue, and with a continuous motion, pull out enough webbing to buckle the tongue into the correct buckle. If you did not pull out enough webbing to reach the buckle, allow the tongue to retract fully before trying to pull it out again.

Seating and safety restraints



The lap belts should fit snugly and as low as possible around the hips, not around the waist.

If you need to lengthen the belt, unfasten it and repeat the procedure above.

To unfasten the belt, push in the release button prior to opening the rear door.

Safety belt extension assembly

If the safety belt assembly is too short, even when fully extended, 20 cm (8 inches) can be added to the safety belt assembly by adding a safety belt extension assembly (part number 611C22). Safety belt extension assemblies can be obtained from your dealer at no cost.

Use only extensions manufactured by the same supplier as the safety belt. Manufacturer identification is located at the end of the webbing on the label. Also, use the safety belt extension only if the safety belt is too short for you when fully extended. Do not use extensions to change the fit of the shoulder belt across the torso.

Safety belt warning light and indicator chime

The seat belt warning light illuminates in the instrument cluster and a chime sounds to remind the occupants to fasten their safety belts.

Conditions of operation

If...	Then...
The driver's safety belt is not buckled before the ignition switch is turned to the ON position...	The safety belt warning light illuminates 1-2 minutes and the warning chime sounds 4-8 seconds.
The driver's safety belt is buckled while the indicator light is illuminated and the warning chime is sounding...	The safety belt warning light and warning chime turn off.
The driver's safety belt is buckled before the ignition switch is turned to the ON position...	The safety belt warning light and indicator chime remain off.

Seating and safety restraints

Belt minder (if equipped)

The Belt Minder feature is a supplemental warning to the safety belt warning function. This feature provides additional reminders to the driver that the driver's safety belt is unbuckled by intermittently sounding a chime and illuminating the safety belt warning lamp in the instrument cluster.

If...	Then...
The driver's safety belt is not buckled before the vehicle has reached at least 5 km/h (3 mph) and 1-2 minutes have elapsed since the ignition switch has been turned to ON...	The Belt Minder feature is activated - the safety belt warning light illuminates and the warning chime sounds for 6 seconds every 30 seconds, repeating for approximately 5 minutes or until safety belt is buckled.
The driver's safety belt is buckled while the safety belt indicator light is illuminated and the safety belt warning chime is sounding...	The Belt Minder feature will not activate.
The driver's safety belt is buckled before the ignition switch is turned to the ON position...	The Belt Minder feature will not activate.

The purpose of the Belt Minder is to remind occasional wearers to wear safety belts all of the time.

Seating and safety restraints

The following are reasons most often given for not wearing safety belts:
(All statistics based on U.S. data)

Reasons given...	Consider...
"Crashes are rare events"	36 700 crashes occur every day. The more we drive, the more we are exposed to "rare" events, even for good drivers. <i>1 in 4 of us will be seriously injured in a crash during our lifetime.</i>
"I'm not going far"	3 of 4 fatal crashes occur within 25 miles of home.
"Belts are uncomfortable"	Ford designs its safety belts to enhance comfort. If you are uncomfortable - try different positions for the safety belt upper anchorage and seatback which should be as upright as possible; this can improve comfort.
"I was in a hurry"	Prime time for an accident. Belt Minder reminds us to take a few seconds to buckle up.
"Seat belts don't work"	Safety belts , when used properly, reduce risk of death to front seat occupants by 45% in cars , and by 60% in light trucks .
"Traffic is light"	Nearly 1 of 2 deaths occur in single-vehicle crashes , many when no other vehicles are around.
"Belts wrinkle my clothes"	Possibly, but a serious crash can do much more than wrinkle your clothes, particularly if you are unbelted.
"The people I'm with don't wear belts"	Set the example, teen deaths occur 4 times more often in vehicles with TWO or MORE people. Children and younger brothers/sisters imitate behavior they see.
"I have an air bag"	Air bags offer greater protection when used with safety belts. Frontal airbags are not designed to inflate in rear and side crashes or rollovers.
"I'd rather be thrown clear"	Not a good idea, people who are ejected are 40 times more likely to DIE . Safety belts help prevent ejection, WE CAN'T "PICK OUR CRASH".



Do not sit on top of a buckled safety belt to avoid the Belt Minder chime. Sitting on the safety belt will increase risk of injury in an accident. To disable (one-time) or deactivate the Belt Minder feature please follow the directions stated below.

Seating and safety restraints

One time disable

Anytime the safety belt is buckled and then unbuckled during an ignition ON cycle, Belt Minder will be disabled for that ignition cycle only.

Deactivating/activating the belt minder feature

Read steps 1 - 9 thoroughly before proceeding with the deactivation/activation programming procedure.

The Belt Minder feature can be deactivated/activated by performing the following procedure:

Before following the procedure, make sure that:

- the parking brake is set
- the gearshift is in P (Park) (automatic transmission) or the neutral position (manual transmission).
- the ignition switch is in the OFF position
- all vehicle doors are closed
- the driver's safety belt is unbuckled
- the parklamps/headlamps are in OFF position (If vehicle is equipped with Autolamps, this will not affect the procedure.)



To reduce the risk of injury, do not deactivate/activate the Belt Minder feature while driving the vehicle.

1. Turn the ignition switch to the RUN (or ON) position. (DO NOT START THE ENGINE)
2. Wait until the safety belt warning light turns off. (Approximately 1–2 minutes)
 - Steps 3–5 must be completed within 60 seconds or the procedure will have to be repeated.
3. Buckle then unbuckle the safety belt three times, ending with the safety belt unbuckled. This can be done before or during Belt Minder warning activation.
4. Turn on the parklamps/headlamps, turn off the parklamps/headlamps.
5. Buckle then unbuckle the safety belt three times, ending with the safety belt unbuckled.
 - After step 5 the safety belt warning light will be turned on for three seconds.

Seating and safety restraints

6. Within seven seconds of the safety belt warning light turning off, buckle then unbuckle the safety belt.
 - This will disable Belt Minder if it is currently enabled, or enable Belt Minder if it is currently disabled.
7. Confirmation of disabling Belt Minder is provided by flashing the safety belt warning light four times per second for three seconds.
8. Confirmation of enabling Belt Minder is provided by flashing the safety belt warning light four times per second for three seconds, followed by three seconds with the safety belt warning light off, then followed by flashing the safety belt warning light four times per second for three seconds again.
9. After receiving confirmation, the deactivation/activation procedure is complete.

Safety belt maintenance

Inspect the safety belt systems periodically to make sure they work properly and are not damaged. Inspect the safety belts to make sure there are no nicks, wears or cuts, replacing if necessary. All safety belt assemblies, including retractors, buckles, front seat belt buckle assemblies, buckle support assemblies (slide bar-if equipped), shoulder belt height adjusters (if equipped), shoulder belt guide on seatback (if equipped), child safety seat tether bracket assemblies (if equipped), and attaching hardware, should be inspected after a collision. Ford recommends that all safety belt assemblies used in vehicles involved in a collision be replaced. However, if the collision was minor and a qualified technician finds that the belts do not show damage and continue to operate properly, they do not need to be replaced. Safety belt assemblies not in use during a collision should also be inspected and replaced if either damage or improper operation is noted.



Failure to inspect and if necessary replace the safety belt assembly under the above conditions could result in severe personal injuries in the event of a collision.

Refer to *Cleaning and maintaining the safety belts* in the *Maintenance and care* section.

Seating and safety restraints

AIR BAG SUPPLEMENTAL RESTRAINT SYSTEM (SRS)

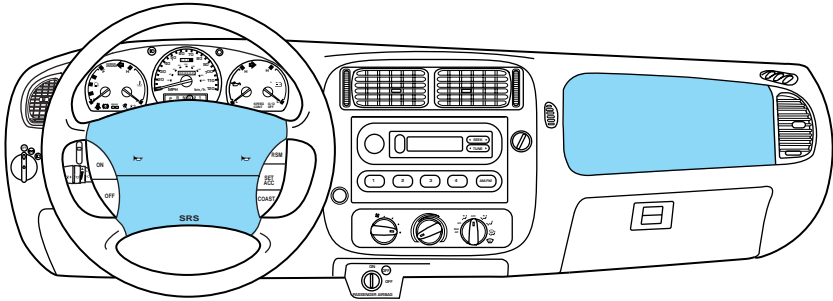

Your vehicle is equipped with a crash sensing and diagnostic module which records information about the air bag and sensor systems. In the event of a collision this module may save information related to the collision including information about the air bag system and impact severity. This information will assist Ford in the servicing of your vehicle and may help Ford better understand real world collisions and further improve the safety of future vehicles.

Important supplemental restraint system (SRS) precautions

The supplemental restraint system is designed to work with the safety belt to help protect the driver and right front passenger from certain upper body injuries.

Air bags DO NOT inflate slowly or gently and the risk of injury from a deploying air bag is greatest close to the trim covering the air bag module.

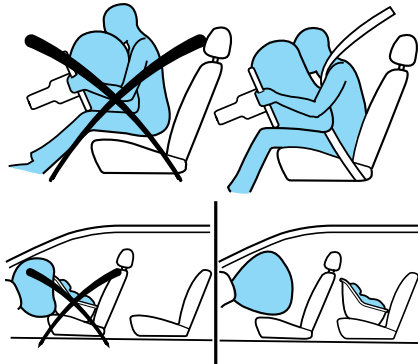

All occupants of the vehicle, including the driver, should always properly wear their safety belts, even when an air bag SRS is provided.

Seating and safety restraints



National Highway Traffic Safety Administration (NHTSA) recommends a minimum distance of at least 25 cm (10 inches) between an occupant's chest and the driver air bag module.



Never place your arm over the air bag module as a deploying air bag can result in serious arm fractures or other injuries.



Never place a rear facing infant seat in the front seat unless the passenger air bag is turned off.

Steps you can take to properly position yourself away from the airbag:

- Move your seat to the rear as far as you can while still reaching the pedals comfortably.
- Recline the seat slightly (one or two degrees) from the upright position.



Do not put anything on or over the air bag module. Placing objects on or over the air bag inflation area may cause those objects to be propelled by the air bag into your face and torso causing serious injury.



Do not attempt to service, repair, or modify the Air Bag Supplemental Restraint System or its fuses. See your Ford or Lincoln-Mercury dealer.

Children and air bags

For additional important safety information, read all information on safety restraints in this guide.

Children must always be properly restrained. Failure to follow these instructions may increase the risk of injury in a collision.



An infant in a rear-facing seat faces a high risk of serious or fatal injuries from a deploying passenger air bag. Rear facing infant seats should NEVER be placed in the front seats, unless the passenger air bag is turned off. See *Passenger air bag ON/OFF switch*.

Seating and safety restraints

How does the air bag supplemental restraint system work?

The air bag SRS is designed to activate when the vehicle sustains sufficient longitudinal deceleration.

The fact that the air bags did not inflate in a collision does not mean that something is wrong with the system. Rather, it means the forces were not of the type sufficient to cause activation. Air bags are designed to inflate in frontal and near-frontal collisions, not rollover, side-impact, or rear-impacts.

The air bags inflate and deflate rapidly upon activation. After air bag deployment, it is normal to notice a smoke-like, powdery residue or smell the burnt propellant. This may consist of cornstarch, talcum powder (to lubricate the bag) or sodium compounds (e.g., baking soda) that result from the combustion process that inflates the air bag. Small amounts of sodium hydroxide may be present which may irritate the skin and eyes, but none of the residue is toxic.

While the system is designed to help reduce serious injuries, it may also cause minor abrasions, swelling or temporary hearing loss. Because air bags must inflate rapidly and with considerable force, there is the risk of death or serious injuries such as fractures, facial and eye injuries or internal injuries, particularly to occupants who are not properly restrained or are otherwise out of position at the time of air bag deployment. Thus, it is extremely important that occupants be properly restrained as far away from the air bag module as possible while maintaining vehicle control.

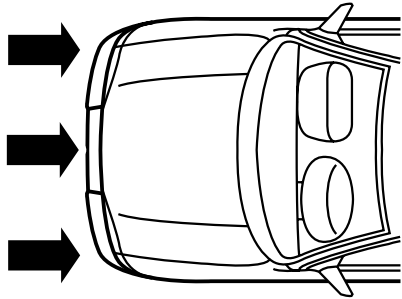

Seating and safety restraints



Several air bag system components get hot after inflation. Do not touch them after inflation.



If the air bag is deployed, **the air bag will not function again and must be replaced immediately.** If the air bag is not replaced, the unrepaired area will increase the risk of injury in a collision.

The SRS consists of:

- driver and passenger air bag modules (which include the inflators and air bags),
- one or more impact and safing sensors, passenger air bag deactivation switch and diagnostic monitor (RCM)
- a readiness light and tone,
- and the electrical wiring which connects the components.

The RCM (restraints control module) monitors its own internal circuits and the supplemental air bag electrical system warning (including the passenger air bag deactivation switch, the impact sensors, the system wiring, the air bag system readiness light, the air bag back up power and the air bag ignitors).

Determining if the system is operational

The SRS uses readiness lights in the instrument cluster and the passenger air bag deactivate switch or a tone to indicate the condition of the system. Refer to the *Air bag readiness* section in the *Instrumentation* chapter or *Passenger air bag deactivate switch* section in this chapter. Routine maintenance of the air bag is not required.

A difficulty with the system is indicated by one or more of the following:

- The readiness lights will either flash or stay lit.
- The readiness lights will not illuminate immediately after ignition is turned on.
- A series of five beeps will be heard. The tone pattern will repeat periodically until the problem and light are repaired.



Seating and safety restraints

If any of these things happen, even intermittently, have the SRS serviced at your dealership or by a qualified technician immediately. Unless serviced, the system may not function properly in the event of a collision.

Disposal of air bags and air bag equipped vehicles (including pretensioners)

For disposal of air bags or air bag equipped vehicles, see your local dealership or qualified technician. Air bags **MUST BE** disposed of by qualified personnel.

Passenger air bag ON/OFF switch



An air bag ON/OFF switch has been installed in this vehicle. Before driving, *always* look at the face of the switch to be sure the switch is in the proper position in accordance with these instructions and warnings. Failure to put the switch in a proper position can increase the risk of serious injury or death in a collision.

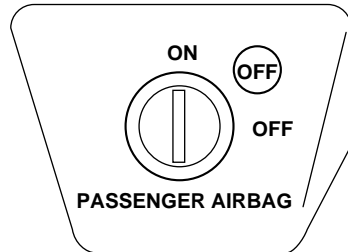

Turning the passenger air bag off

1. Insert the ignition key, turn the switch to OFF position and hold in OFF position while removing the key.
2. When the ignition is turned to the ON position the OFF light illuminates briefly, momentarily shuts off and then turns back on. This indicates that the passenger air bag is deactivated.

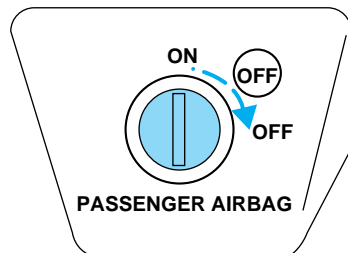

Seating and safety restraints



If the light fails to illuminate when the passenger air bag switch is in the OFF position and the ignition switch is in ON, have the passenger air bag switch serviced at your Ford or Lincoln-Mercury dealer immediately.



In order to avoid inadvertent activation of the switch, always remove the ignition key from the passenger air bag ON/OFF switch.

Turning the passenger air bag back on

The passenger air bag remains OFF until you turn it back ON.

1. Insert the ignition key and turn the switch to ON.
2. The OFF light will briefly illuminate when the ignition is turned to ON. This indicates that the passenger air bag is operational.

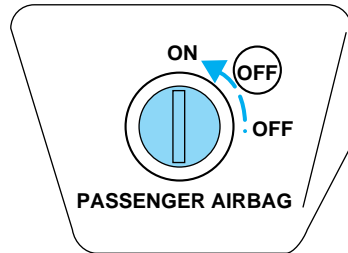

If the light is illuminated when the passenger air bag ON/OFF switch is in the ON position and the ignition switch is in ON, have the passenger air bag ON/OFF switch serviced at your Ford or Lincoln-Mercury dealer immediately.

The passenger side air bag should always be ON (the air bag OFF light should *not* be illuminated) unless the passenger is a person who meets the requirements stated either in Category 1, 2 or 3 of the NHTSA/Transport Canada deactivation criteria which follows.

Seating and safety restraints



The safety belts for the driver and right front passenger seating positions have been specifically designed to function together with the air bags in certain types of crashes. When you turn OFF your air bag, you not only lose the protection of the air bag, you also may reduce the effectiveness of your safety belt system, which was designed to work with the air bag. If you are not a person who meets the requirements stated in the NHTSA/Transport Canada deactivation criteria turning OFF the air bag can increase the risk of serious injury or death in a collision.



Always use safety belts and child restraints properly. If a child in a rear facing infant seat must be transported in front, the passenger air bag *must* be turned OFF. This is because the back of the infant seat is too close to the inflating air bag and the risk of a fatal injury to the infant when the air bag inflates is substantial.

The vast majority of drivers and passengers are much safer with an air bag than without. To do their job and reduce the risk of life threatening injuries, air bags must open with great force, and this force can pose a potentially deadly risk in some situations, particularly when a front seat occupant is not properly buckled up. The most effective way to reduce the risk of unnecessary air bag injuries without reducing the overall safety of the vehicle is to make sure all occupants are properly restrained in the vehicle, especially in the front seat. This provides the protection of safety belts and permits the air bags to provide the additional protection they were designed to provide. If you choose to deactivate your air bag, you are losing the very significant risk reducing benefits of the air bag and you are also reducing the effectiveness of the safety belts, because safety belts in modern vehicles are designed to work as a safety system with the air bags.

Read all air bag Warning labels in the vehicle as well as the other important air bag instructions and Warnings in this Owner's Guide.

NHTSA deactivation criteria (excluding Canada)

1. **Infant.** An infant (less than 1 year old) must ride in the front seat because:

- the vehicle has no rear seat;
- the vehicle has a rear seat too small to accommodate a rear-facing infant seat; or

Seating and safety restraints

- the infant has a medical condition which, according to the infant's physician, makes it necessary for the infant to ride in the front so that the driver can constantly monitor the child's condition.
2. **Child age 1 to 12.** A child age 1 to 12 must ride in the front seat because:
- the vehicle has no rear seat;
 - although children ages 1 to 12 ride in the rear seat(s) whenever possible, children ages 1 to 12 sometimes must ride in the front because no space is available in the rear seat(s) of the vehicle; or
 - the child has a medical condition which, according to the child's physician, makes it necessary for the child to ride in the front seat so that the driver can constantly monitor the child's condition.
3. **Medical condition.** A passenger has a medical condition which, according to his or her physician:
- causes the passenger air bag to pose a special risk for the passenger; and
 - makes the potential harm from the passenger air bag in a crash greater than the potential harm from turning OFF the air bag and allowing the passenger, even if belted, to hit the dashboard or windshield in a crash.



This vehicle has special energy management safety belts for the driver and/or right front passenger. These particular belts are specifically designed to work with air bags to help reduce the risk of injury in a collision. The energy management safety belt is designed to give or release additional belt webbing in some accidents to reduce concentration of force on an occupant's chest and reduce the risk of certain bone fractures and injuries to underlying organs. In a crash, if the air bag is turned OFF, this energy management safety belt might permit the person wearing the belt to move forward enough to incur a serious or fatal injury. The more severe the crash, and the heavier the occupant, the greater the risk is. Be sure the air bag is turned ON for any person who does not qualify under the NHTSA deactivation criteria.

Seating and safety restraints

Transport Canada deactivation criteria (Canada Only)

1. **Infant:** An infant (less than 1 year old) must ride in the front seat because:
 - my vehicle has no rear seat;
 - the rear seat in my vehicle cannot accommodate a rear-facing infant seat; or
 - the infant has a medical condition which, according to the infant's physician, makes it necessary for the infant to ride in the front seat so that the driver can monitor the infant's condition.
2. **Child age 12 or under:** A child age 12 or under must ride in the front seat because:
 - my vehicle has no rear seat;
 - although children age 12 and under ride in the rear seat whenever possible, children age 12 and under have no option but to sometimes ride in the front seat because rear seat space is insufficient; or
 - the child has a medical condition that, according to the child's physician, makes it necessary for the child to ride in the front seat so that the driver can monitor the child's condition.
3. **Medical condition:** A passenger has a medical condition that, according to his or her physician:
 - poses a special risk for the passenger if the air bag deploys; and
 - makes the potential harm from the passenger air bag deployment greater than the potential harm from turning OFF the air bag and experiencing a crash without the protection offered by the air bag



This vehicle has special energy management safety belts for the driver and/or right front passenger. These particular belts are specifically designed to work with air bags to help reduce the risk of injury in a collision. The energy management safety belt is designed to give or release additional belt webbing in some accidents to reduce concentration of force on an occupant's chest and reduce the risk of certain bone fractures and injuries to underlying organs. In a crash, if the air bag is turned OFF, this energy management safety belt might permit the person wearing the belt to move forward enough to incur a serious or fatal injury. The more severe the crash, and the heavier the occupant, the greater the risk is. Be sure the air bag is turned ON for any person who does not qualify under the Transport Canada deactivation criteria.

Seating and safety restraints

SAFETY RESTRAINTS FOR CHILDREN

See the following sections for directions on how to properly use safety restraints for children. Also see *Air Bag Supplemental Restraint System (SRS)* in this chapter for special instructions about using air bags.

Important child restraint precautions

You are required by law to use safety restraints for children in the U.S. and Canada. If small children ride in your vehicle (generally children who are four years old or younger and who weigh 18 kg [40 lbs] or less), you must put them in safety seats made especially for children. Check your local and state or provincial laws for specific requirements regarding the safety of children in your vehicle.



Never let a passenger hold a child on his or her lap while the vehicle is moving. The passenger cannot protect the child from injury in a collision.

Always follow the instructions and warnings that come with any infant or child restraint you might use.

When possible, always place children under age 12 in the rear seat of your vehicle. Accident statistics suggest that children are safer when properly restrained in the rear seating positions than in the front seating positions.



Do not install a child seat in a center facing jump seat.

Children and safety belts

If the child is the proper size, restrain the child in a safety seat.

Children who are too large for child safety seats (as specified by your child safety seat manufacturer) should always wear safety belts.

Follow all the important safety restraint and air bag precautions that apply to adult passengers in your vehicle.

If the shoulder belt portion of a combination lap and shoulder belt can be positioned so it does not cross or rest in front of the child's face or neck, the child should wear the lap and shoulder belt. Moving the child closer to the center of the vehicle may help provide a good shoulder belt fit.

Seating and safety restraints



Do not leave children, unreliable adults, or pets unattended in your vehicle.

To improve the fit of lap and shoulder belts on children who have outgrown child safety seats, Ford recommends use of a belt-positioning booster seat that is labelled as conforming to all Federal motor vehicle safety standards. Belt-positioning booster seats raise the child and provide a shorter, firmer seating cushion that encourages safer seating posture and better fit of lap and shoulder belts on the child.

A belt-positioning booster should be used if the shoulder belt rests in front of the child's face or neck, or if the lap belt does not fit snugly on both thighs, or if the thighs are too short to let the child sit all the way back on the seat cushion when the lower legs hang over the edge of the seat cushion. You may wish to discuss the special needs of your child with your pediatrician.

SAFETY SEATS FOR CHILDREN



Child and infant or child safety seats

Use a safety seat that is recommended for the size and weight of the child. Carefully follow all of the manufacturer's instructions with the safety seat you put in your vehicle. If you do not install and use the safety seat properly, the child may be injured in a sudden stop or collision.

Seating and safety restraints

When installing a child safety seat:

- Review and follow the information presented in the *Air Bag Supplemental Restraint System* section in this chapter.
- Use the correct safety belt buckle for that seating position (the buckle closest to the direction the tongue is coming from).
- Insert the belt tongue into the proper buckle until you hear a snap and feel it latch. Make sure the tongue is securely fastened in the buckle.
- Keep the buckle release button pointing up and away from the safety seat, with the tongue between the child seat and the release button, to prevent accidental unbuckling.
- Place seat back in upright position.
- Put the safety belt in the automatic locking mode. Refer to *Automatic locking mode* (passenger side front and outboard rear seating positions) (if equipped).

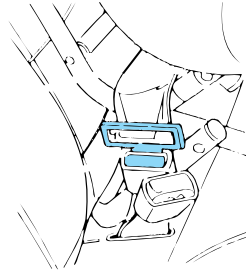

Ford recommends the use of a child safety seat having a top tether strap. Install the child safety seat in a seating position which is capable of providing a tether anchorage. For more information on top tether straps, refer to *Attaching safety seats with tether straps*.



Carefully follow all of the manufacturer's instructions included with the safety seat you put in your vehicle. If you do not install and use the safety seat properly, the child may be injured in a sudden stop or collision.

Seating and safety restraints

Installing child safety seats in combination lap and shoulder belt seating positions

1. Position the child safety seat in a seat with a combination lap and shoulder belt.

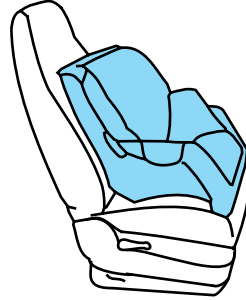

An air bag can kill or injure a child in a child seat. If you must use a forward-facing child seat in the front seat, move seat all the way back.



An air bag can kill or injure a child in a child seat. Child seats should never be placed in the front seats, unless passenger air bag switch is turned off, See **Passenger air bag deactivation switch**.



Rear facing child seats should NEVER be placed in the front seats unless the passenger airbag switch is turned off.

2. Pull down on the shoulder belt and then grasp the shoulder belt and lap belt together.

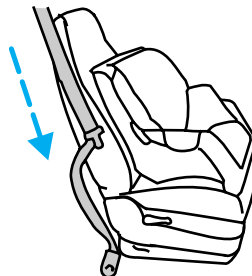

Seating and safety restraints

3. While holding the shoulder and lap belt portions together, route the tongue through the child seat according to the child seat manufacturer's instructions. Be sure the belt webbing is not twisted.

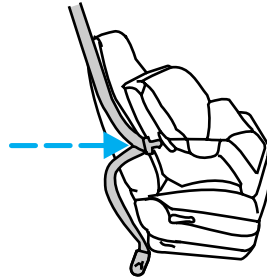

4. Insert the belt tongue into the proper buckle (the buckle closest to the direction the tongue is coming from) for that seating position until you hear and feel the latch engage. Make sure the tongue is latched securely by pulling on it.

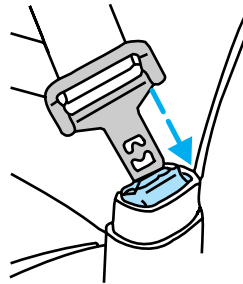

5. To put the retractor in the automatic locking mode, grasp the shoulder portion of the belt and pull downward until all of the belt is extracted and a click is heard.

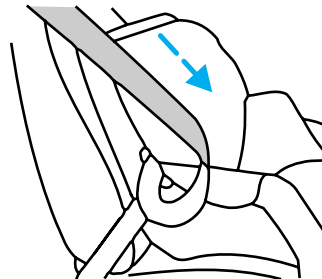

6. Allow the belt to retract. The belt will click as it retracts to indicate it is in the automatic locking mode.

Seating and safety restraints

7. Pull the lap belt portion across the child seat toward the buckle and pull up on the shoulder belt while pushing down with knee on the child seat.

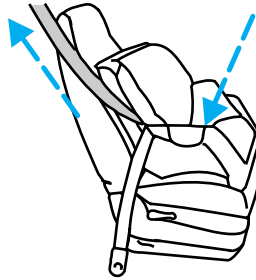

8. Allow the safety belt to retract to remove any slack in the belt.

9. Before placing the child in the seat, forcibly tilt the seat forward and back to make sure the seat is securely held in place.

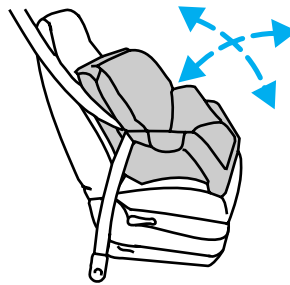

10. Try to pull the belt out of the retractor to make sure the retractor is in the automatic locking mode (you should not be able to pull more belt out). If the retractor is not locked, unbuckle the belt and repeat steps two through nine.

Check to make sure the child seat is properly secured before each use.

Seating and safety restraints

Attaching safety seats with tether straps

Some manufacturers make safety seats that include a tether strap that goes over the back of the vehicle seat and attaches to an anchoring point. Other manufacturers offer the tether strap as an accessory. Contact the manufacturer of your child safety seat for information about ordering a tether strap.

In Super Cabs equipped with Center Facing Jump Seats, the tether strap anchor bracket should be installed only at the center of the cab's back panel with the child seat in the front center seating position. Installing an anchor bracket at the right rear of the cab may increase risk of injury to an occupant of the right rear center facing jump seat in the event of a collision or a sudden stop. If a tether child seat is installed in the right front seating position, secure the tether strap to the webbing of the buckled right rear lap belt.

You can attach a tether strap anchor bracket to the cab inner back panel by using a tether anchor kit (613D20) available at no charge from any Ford dealer.



Do not install a child seat in a center facing jump seat.

Tether anchorage hardware

Tether anchorage hardware kits (part number 613D20) including instructions, may be obtained at no charge from any Ford or Lincoln-Mercury dealer.



Tighten the anchor according to specifications. Otherwise, the safety seat may not be properly secured and the child may be injured in a sudden stop or collision.

Starting

PREPARING TO START YOUR VEHICLE

Engine starting is controlled by the powertrain control system. This system meets all Canadian Interference-Causing Equipment standard requirements regulating the impulse electrical field strength of radio noise.

When starting a fuel-injected engine, avoid pressing the accelerator before or during starting. Only use the accelerator when you have difficulty starting the engine. For more information on starting the vehicle, refer to *Starting the engine* in this chapter.



Extended idling at high engine speeds can produce very high temperatures in the engine and exhaust system, creating the risk of fire or other damage.



Do not park, idle, or drive your vehicle in dry grass or other dry ground cover. The emission system heats up the engine compartment and exhaust system, which can start a fire.



Do not start your vehicle in a closed garage or in other enclosed areas. Exhaust fumes can be toxic. Always open the garage door before you start the engine. See *Guarding against exhaust fumes* in this chapter for more instructions.



If you smell exhaust fumes inside your vehicle, have your dealer inspect your vehicle immediately. Do not drive if you smell exhaust fumes.

Important safety precautions

A computer system controls the engine's idle revolutions per minute (RPM). When the engine starts, the idle RPM runs faster to warm the engine. If the engine idle speed does not slow down automatically, have the vehicle checked. Do not allow the vehicle to idle for more than 10 minutes at high engine RPM.

Before starting the vehicle:

1. Make sure all vehicle occupants have buckled their safety belts. For more information on safety belts and their proper usage, refer to the *Seating and safety restraints* chapter.

Starting

2. Make sure the headlamps and vehicle accessories are off.

If starting a vehicle with an automatic transmission:

- Make sure the parking brake is set.

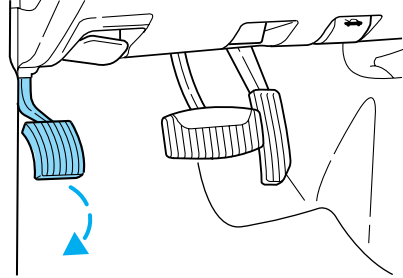

- Make sure the gearshift is in P (Park).

If starting a vehicle with a manual transmission:

- Make sure the parking brake is set.
- Push the clutch pedal to the floor.

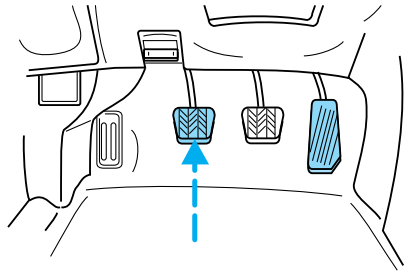

3. Turn the key to 4 (ON) without turning the key to 5 (START).

If there is difficulty in turning the key, firmly rotate the steering wheel left and right until the key turns freely. This condition may occur when:

- front wheels are turned
- front wheel is against the curb
- steering wheel is turned when getting in or out of the vehicle

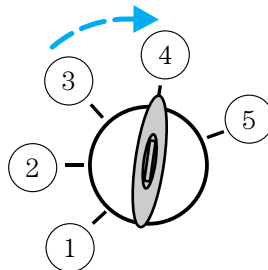

Starting

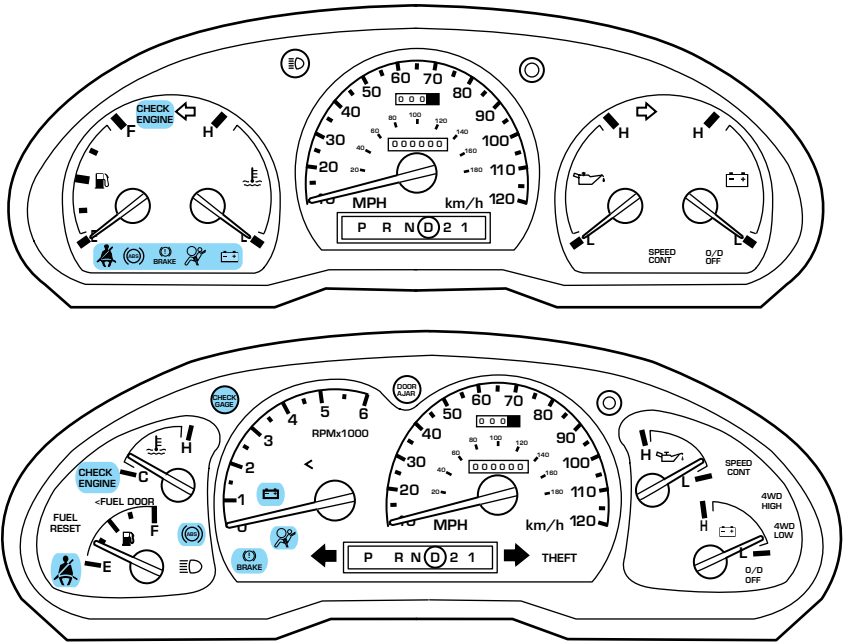

Make sure the corresponding lights illuminate briefly. If a light fails to illuminate, have the vehicle serviced.

- If the driver's safety belt is fastened, the  light may not illuminate.

STARTING THE ENGINE

1. Turn the key to 5 (START) without pressing the accelerator pedal and release as soon as the engine starts. The key will return to 4 (ON).
2. If the temperature is above -12°C (10°F) and the engine does not start within five seconds on the first try, turn the key to OFF, wait 10 seconds and try again.

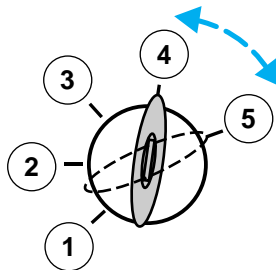

3. If the temperature is below -12°C (10°F) and the engine does not start in 15 seconds on the first try, turn the key OFF and wait 10 seconds and try again. If the engine does not start in two attempts, press the accelerator pedal all the way to floor and hold. Turn the key to START position.
4. When the engine starts, release the key, then release the accelerator pedal gradually as the engine speeds up.
5. After idling for a few seconds, apply the brake and release the parking brake.

Cold weather starting (flexible fuel vehicles only)

As the outside temperature approaches freezing, ethanol fuel distributors should supply winter grade (E_d 85) ethanol (same as with unleaded gasoline). If summer grade (E_d 85) ethanol is used in cold weather conditions, you may experience increased cranking times, rough idle or hesitation until the engine has warmed up. Consult your fuel distributor for the availability of winter grade (E_d 85) ethanol.

High-quality blends of winter grade (E_d 85) ethanol will produce satisfactory cold weather starting and driving results. However, fuel composition varies, and sub-optimal winter grade blends could produce increased cranking times, rough idle or hesitation at temperatures below -18°C (0°F). If you experience this condition you may find that a different brand of winter grade (E_d 85) (if available in your area) improves the performance of your vehicle.

Cold starting performance can also be improved with the use of an engine block heater. The engine block heater is available as a Ford option and can also be obtained from your Ford dealer. Consult the engine block heater section for proper use of the engine block heater.

If you should experience cold weather starting problems on (E_d 85) ethanol, and neither an alternative brand of (E_d 85) ethanol nor an engine block heater is available, the addition of unleaded gasoline to your tank will improve cold starting performance. Your vehicle is designed to operate on (E_d 85) ethanol alone, unleaded gasoline alone, or any mixture of the two.

Starting

If the engine fails to start using the preceding instructions

1. Press the accelerator pedal 1/3 to 1/2 of the way to floor and hold.
2. Turn the key to START position.
3. When the engine starts, release the key, then release the accelerator pedal gradually as the engine speeds up.
4. If the engine still fails to start, repeat steps one through three.
5. After the engine starts, hold your foot on the brake pedal, put the gearshift lever in gear and release the parking brake. Slowly release the brake pedal and drive away in a normal manner.

Using the engine block heater (if equipped)

An engine block heater warms the engine coolant, which improves starting, warms up the engine faster and allows the heater-defroster system to respond quickly. Use of an engine block heater is strongly recommended if you live in a region where temperatures reach -23°C (-10°F) or below. Your engine block heater also comes with a battery warmer. The battery warmer wraps around the battery and keeps the battery warm when the engine block heater is plugged in.

For best results, plug the heater in at least three hours before starting the vehicle. Using the heater for longer than three hours will not harm the engine, so the heater can be plugged in the night before starting the vehicle.



To prevent electrical shock, do not use your heater with ungrounded electrical systems or two-pronged (cheater) adapters.

Guarding against exhaust fumes

Although odorless and colorless, carbon monoxide is present in exhaust fumes. Take precautions to avoid its dangerous effects.



If you ever smell exhaust fumes of any kind inside your vehicle, have your dealer inspect and fix your vehicle immediately. Do not drive if you smell exhaust fumes. These fumes are harmful and could kill you.

Have the exhaust and body ventilation systems checked whenever:

- the vehicle is raised for service.
- the sound of the exhaust system changes.
- the vehicle has been damaged in a collision.



Engine exhaust, some of its constituents, and certain vehicle components contain or emit chemicals known to the State of California to cause cancer, and birth defects or other reproductive harm.

Important ventilating information

If the engine is idling while the vehicle is stopped in an open area for long periods of time, open the windows at least 2.5 cm (one inch).

Adjust the heating or air conditioning (if equipped) to bring in fresh air.

Improve vehicle ventilation by keeping all air inlet vents clear of snow, leaves and other debris.

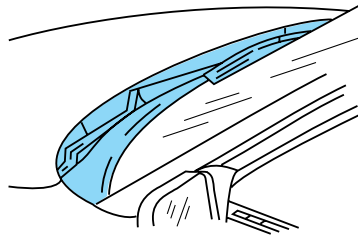

Driving

BRAKES

Your service brakes are self-adjusting. Refer to the scheduled maintenance guide for scheduled maintenance.

Occasional brake noise is normal and often does not indicate a performance concern with the vehicle's brake system. In normal operation, automotive brake systems may emit occasional or intermittent squeal or groan noises when the brakes are applied. Such noises are usually heard during the first few brake applications in the morning; however, they may be heard at any time while braking and can be aggravated by environmental conditions such as cold, heat, moisture, road dust, salt or mud. If a "metal-to-metal," "continuous grinding" or "continuous squeal" sound is present while braking, the brake linings may be worn-out and should be inspected by a qualified service technician.

Rear anti-lock brake system (RABS)

Rear Anti-lock Brake System (RABS) is standard equipment on this vehicle. RABS is designed to help you maintain directional stability in emergency stopping situations. With RABS, the rear brakes are kept from locking during panic stops; however, the front wheels can lock because they are not controlled by RABS.

A clicking noise and slight pedal pulsation during RABS braking events indicates the RABS is functioning. Pedal pulsation coupled with clicking noise while braking under panic conditions on loose gravel, wet or snowy roads is normal and indicates proper functioning of the vehicle's RABS. If the vehicle has continuous vibration or shudder in the steering wheel while braking, the vehicle should be inspected by a qualified service technician.

The RABS operates by detecting the onset of rear wheel lockup during brake applications and compensating for this tendency.

RABS warning lamp

The  warning lamp in the instrument cluster momentarily illuminates when the ignition is turned to the ON position. If the light does not illuminate momentarily at start up, remains on or continues to flash, the ABS needs to be serviced.

With the ABS light on, the anti-lock brake system is disabled and normal braking is still effective unless the brake warning light also remains illuminated with parking brake released. (If your brake warning lamp illuminates, have your vehicle serviced immediately.)



Using RABS

- In an emergency, applying full pressure may cause the front wheels to lock. **If the front brakes lock, the vehicle cannot be steered.** You should apply the brakes with steadily increasing force, as if “squeezing” the brakes. If you feel the front wheels begin to lock, momentarily release the pedal and repeat the “squeeze” technique.
- We recommend that you familiarize yourself with how the RABS performs. However, avoid unnecessary risks.

Four-wheel anti-lock brake system (ABS) (if equipped)

On vehicles equipped with an anti-lock braking system (ABS), a noise from the hydraulic pump motor and pulsation in the pedal may be observed during ABS braking events. Pedal pulsation coupled with noise while braking under panic conditions or on loose gravel, bumps, wet or snowy roads is normal and indicates proper functioning of the vehicle’s anti-lock brake system. If the vehicle has continuous vibration or shudder in the steering wheel while braking, the vehicle should be inspected by a qualified service technician.

The ABS operates by detecting the onset of wheel lockup during brake applications and compensates for this tendency. The wheels are prevented from locking even when the brakes are firmly applied. The accompanying illustration depicts the advantage of an ABS equipped vehicle (on bottom) to a non-ABS equipped vehicle (on top) during hard braking with loss of front braking traction.

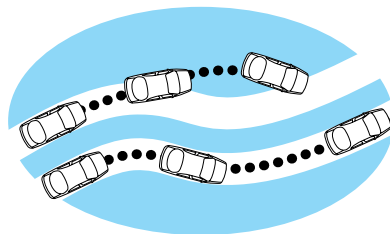

Driving

ABS warning lamp (ABS)

The (ABS) warning lamp in the instrument cluster momentarily illuminates when the ignition is turned to the ON position. If the light does not illuminate momentarily at start up, remains on or continues to flash, the ABS needs to be serviced.

With the ABS light on, the anti-lock brake system is disabled and normal braking is still effective unless the brake warning light also remains illuminated with parking brake released. (If your brake warning lamp illuminates, have your vehicle serviced immediately.)



Using ABS

- In an emergency or when maximum efficiency from the ABS is required, apply continuous force on the brake. The ABS will be activated immediately, thus allowing you to retain full steering control of your vehicle and, providing there is sufficient space, will enable you to avoid obstacles and bring the vehicle to a controlled stop.
- The Anti-Lock system does not decrease the time necessary to apply the brakes or always reduce stopping distance. Always leave enough room between your vehicle and the vehicle in front of you to stop.
- We recommend that you familiarize yourself with this braking technique. However, avoid taking any unnecessary risks.

Parking brake (P)

Apply the parking brake whenever the vehicle is parked. To set the parking brake, press the parking brake pedal down until the pedal stops.

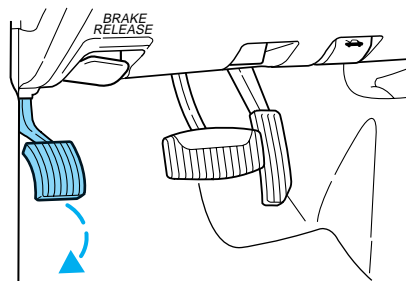

The BRAKE warning lamp in the instrument cluster illuminates and remains illuminated (when the ignition is turned ON) until the parking brake is released.



Always set the parking brake fully and make sure that the gearshift is securely latched in P (Park) (automatic transmission) or in 1 (First) (manual transmission).

The parking brake is not recommended to stop a moving vehicle. However, if the normal brakes fail, the parking brake can be used to stop your vehicle in an emergency. Since the parking brake applies only the rear brakes, the vehicle's stopping distance will increase greatly and the handling of your vehicle will be adversely affected.

Pull the release lever to release the brake. Driving with the parking brake on will cause the brakes to wear out quickly and reduce fuel economy.

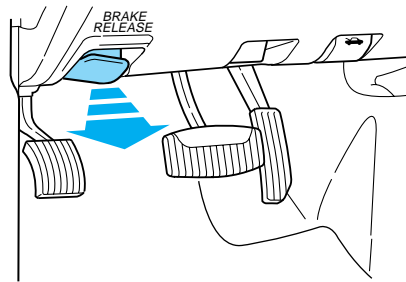

STEERING

Your vehicle is equipped with power steering. Power steering uses energy from the engine to help steer the vehicle.

To prevent damage to the power steering pump:

- Never hold the steering wheel to the extreme right or the extreme left for more than a few seconds when the engine is running.
- Do not operate the vehicle with a low power steering pump fluid level.

If the power steering system breaks down (or if the engine is turned off), you can steer the vehicle manually, but it takes more effort.

Driving

If the steering wanders or pulls, the condition could be caused by any of the following:

- underinflated tire(s) on any wheel(s)
- high crown in center of road
- high crosswinds
- wheels out of alignment
- loose or worn components in steering linkage

PREPARING TO DRIVE YOUR VEHICLE



Utility vehicles have a significantly higher rollover rate than other types of vehicles.



In a rollover crash, an unbelted person is significantly more likely to die than a person wearing a seat belt.

Your vehicle has special design and equipment features to make it capable of performing in a wide variety of circumstances. These special design features, such as larger tires and increased ground clearance, give the vehicle a higher center of gravity than a passenger car.



Vehicles with a higher center of gravity such as utility and four-wheel drive vehicles handle differently than vehicles with a lower center of gravity. Utility and four-wheel drive vehicles are **not** designed for cornering at speeds as high as passenger cars any more than low-slung sports cars are designed to perform satisfactorily under off-road conditions. Avoid sharp turns, excessive speed and abrupt maneuvers in these vehicles. Failure to drive cautiously could result in an increased risk of vehicle rollover, personal injury and death.



Loaded vehicles, with a higher center of gravity, may handle differently than unloaded vehicles. Extra precautions, such as slower speeds and increased stopping distance, should be taken when driving a heavily loaded vehicle.

Your vehicle has the capability to haul more cargo and people than most passenger cars. Depending upon the type and placement of the load, hauling people and cargo may raise the center of gravity of the vehicle.

Use extra caution while becoming familiar with your vehicle. Know the capabilities and limitations of both you as a driver and your vehicle.

AUTOMATIC TRANSMISSION OPERATION (IF EQUIPPED)

Brake-shift interlock

This vehicle is equipped with a brake-shift interlock feature that prevents the gearshift lever from being moved from P (Park) when the ignition is in the ON position unless brake pedal is depressed.

If you cannot move the gearshift lever out of P (Park) with ignition in the ON position and the brake pedal depressed:

1. Apply the parking brake, turn ignition key to LOCK, then remove the key.
2. Insert the key and turn it to OFF. Apply the brake pedal and shift to N (Neutral).
3. Start the vehicle.

If it is necessary to use the above procedure to move the gearshift lever, it is possible that a fuse has blown or the vehicle's brakelamps are not operating properly. Refer to *Fuses and relays* in the *Roadside emergencies* chapter.



Do not drive your vehicle until you verify that the brakelamps are working.

If your vehicle gets stuck in mud or snow it may be rocked out by shifting from forward and reverse gears, stopping between shifts, in a steady pattern. Press lightly on the accelerator in each gear.

Do not rock the vehicle if the engine is not at normal operating temperature or damage to the transmission may occur.

Do not rock the vehicle for more than a few minutes or damage to the transmission and tires may occur or the engine may overheat.



Always set the parking brake fully and make sure the gearshift is latched in P (Park). Turn off the ignition whenever you leave your vehicle.

Driving



If the parking brake is fully released, but the brake warning lamp remains illuminated, the brakes may not be working properly. See your dealer or a qualified service technician.

Driving with a 4–speed automatic transmission (if equipped)

To put your vehicle in gear, start the engine, depress the brake pedal, then move gearshift lever out of P (Park).



Hold the brake pedal down while you move the gearshift lever from P (Park) to another position. If you do not hold the brake pedal down, your vehicle may move unexpectedly and injure someone.

Understanding gearshift positions

P (Park)

Always come to a complete stop before shifting into P (Park). Make sure the gearshift lever is securely latched in P (Park). This position locks the transmission and prevents the rear wheels from turning.



Always set the parking brake fully and make sure the gearshift lever is latched in P (Park). Turn off the ignition whenever you leave your vehicle.

R (Reverse)

With the gearshift in R (Reverse), the vehicle will move backward. Always come to a complete stop before shifting into and out of R (Reverse).



N (Neutral)

With the gearshift in N (Neutral), the vehicle can be started and is free to roll. Hold the brake pedal down while in this gear.



D (Overdrive)

The normal driving position for the best fuel economy. Transmission operates in gears one through four.



D (Overdrive) can be deactivated by pressing the transmission control switch on the gearshift lever.

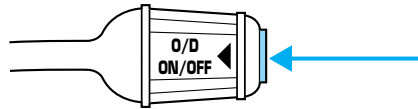

The transmission control indicator light (TCIL) will illuminate on the instrument cluster.

O/D
OFF

Drive – Not shown on the display. Activate by pressing the transmission control switch on the end of the gearshift lever with the gearshift in the **D** position. The O/D OFF indicator will illuminate on the instrument cluster. Transmission operates in gears one through three. **D** (Drive) provides more engine braking than **D** (Overdrive) and is useful when:

- driving with a heavy load.
- towing a trailer up or down steep hills.
- additional engine braking is desired. If towing a trailer, refer to *Driving while you tow* in the *Trailer Towing* chapter.

To return to **D** (Overdrive) mode, press the transmission control switch. The O/D OFF indicator will no longer be illuminated.

Each time the vehicle is started, the transmission will automatically return to normal overdrive mode.

Every time the vehicle is shut off and restarted, you must press the transmission control switch to cancel overdrive operation if driving in overdrive is not desired.

2 (Second)

Use 2 (Second) to start-up on slippery roads or to provide additional engine braking on downgrades. Transmission operates only in Second gear.



Driving

1 (First)

Use 1 (Low) to provide maximum engine braking on steep downgrades. Upshifts can be made by shifting to 2 (Second) or to **D** (Overdrive). Selecting 1 (Low) at higher speeds causes the transmission to shift to a lower gear, and will shift to 1 (Low) after vehicle decelerates to the proper speed.



Forced Downshifts

To gain acceleration in **D** (Overdrive) or Drive (O/D OFF) when passing another vehicle, push the accelerator to the floor. The transmission will downshift to the appropriate gear: third, second or first gear.

Driving with a 5–speed automatic transmission (if equipped)

Understanding gearshift positions



Hold the brake pedal down while you move the gearshift lever from P (Park) to another position. If you do not hold the brake pedal down, your vehicle may move unexpectedly and injure someone.

P (Park)

To put your vehicle in gear, start the engine, depress the brake pedal, then move gearshift lever out of P (Park).

Always come to a complete stop before shifting into P (Park). Make sure the gearshift lever is securely latched in P (Park). This position locks the transmission and prevents the rear wheels from turning.



Always set the parking brake fully and make sure the gearshift is latched in P (Park). Turn off the ignition whenever you leave your vehicle.

R (Reverse)

With the gearshift lever in R (Reverse), the vehicle will move backward. Always come to a complete stop before shifting into and out of R (Reverse).



N (Neutral)

With the gearshift lever in N (Neutral), the vehicle can be started and is free to roll. Hold the brake pedal down while in this position.



D (Overdrive)

The normal driving position for the best fuel economy. Transmission operates in gears one through five.



D (Overdrive) can be deactivated by pressing the transmission control switch on the end of the gearshift lever.

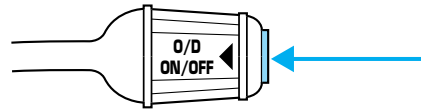

The transmission control indicator light (TCIL) will illuminate on the instrument cluster.

O/D
OFF

Drive – Not shown on the display. Activate by pressing the transmission control switch on the end of the gearshift lever with the gearshift in the **D** (Overdrive) position. The TCIL will illuminate on the instrument cluster. Transmission operates in gears one through four. Drive (O/D OFF) provides more engine braking than **D** (Overdrive) and is useful whenever driving conditions (i.e., city traffic, hilly terrain, etc.) cause the transmission to excessively shift between **D** (Overdrive) and other gears. Deactivate **D** (Overdrive) when:

- driving with a heavy load.
- towing a trailer up or down steep hills.
- additional engine braking is desired. If towing a trailer, refer to *Driving while you tow* in the *Trailer Towing* chapter.

Driving

To return to **D** (Overdrive) mode, press the transmission control switch. The TCIL will no longer be illuminated.

Each time the vehicle is started, the transmission will automatically return to normal **D** (Overdrive) mode.

2 (Second)

Use 2 (Second) to start-up on slippery roads or to provide additional engine braking on downgrades.



1 (First)

Use 1 (First) to provide maximum engine braking on steep downgrades. Upshifts can be made by shifting to 2 (Second) or to **D** (Overdrive). Selecting 1 (Low) at higher speeds causes the transmission to shift to a lower gear and will shift to 1 (First) after the vehicle decelerates to the proper vehicle speed.



Forced Downshifts

To gain acceleration in **D** (Overdrive) or Drive (O/D OFF) when passing another vehicle, push the accelerator to the floor. The transmission will downshift to the appropriate gear: fourth, third, second or first gear.

Manual transmission operation (if equipped)

Using the clutch

Vehicles equipped with a manual transmission have a starter interlock that prevents Starting the engine unless the clutch pedal is fully depressed.

When starting a vehicle with a manual transmission:

1. Hold down the brake pedal.
2. Depress the clutch pedal.

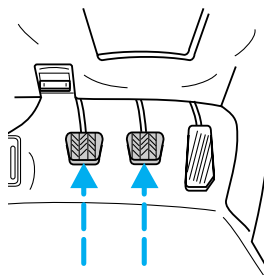

- Put the gearshift lever in N (Neutral).
- Start the engine and let it idle for a few seconds.
 - Put the gearshift lever in 1 (First) or R (Reverse).
- Release the clutch slowly while pressing gradually down on the accelerator pedal.
 - Do not drive with your foot resting on the clutch pedal. Do not use the clutch to hold your vehicle at a standstill while waiting on a hill. These actions may reduce clutch life.

Parking

- Apply the brake and shift into N (Neutral).

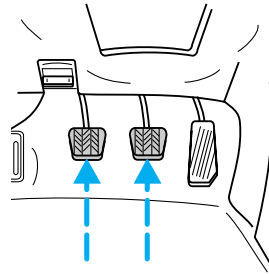

- Engage the parking brake.

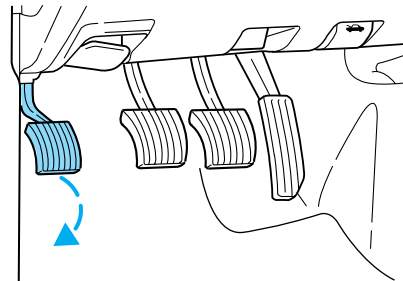

- Shift into 1 (First).
- Turn the ignition to Off.



Do not park your vehicle in Neutral, it may move unexpectedly and injure someone. Use 1 (First) gear and set the parking brake fully.

Driving

Recommended shift speeds

Upshifts when accelerating (for best fuel economy)		
Shift from:	Transfer case position (if equipped)	
	4H	4L
1 - 2	14 km/h (10 mph)	5 km/h (4 mph)
2 - 3	32 km/h (22 mph)	11 km/h (9 mph)
3 - 4	50 km/h (33 mph)	19 km/h (13 mph)
4 - 5 (Overdrive)	71 km/h (41 mph)	27 km/h (17 mph)
Upshifts when cruising (recommended for best fuel economy)		
Shift from:	Transfer case position (if equipped)	
	4H	4L
1 - 2	16 km/h (10 mph)	6 km/h (4 mph)
2 - 3	26 km/h (19 mph)	10 km/h (8 mph)
3 - 4	43 km/h (28 mph)	16 km/h (12 mph)
4 - 5 (Overdrive)	68 km/h (40 mph)	26 km/h (16 mph)
Maximum downshift speeds		
Shift from:	Transfer case position (if equipped)	
	4H	4L
5 (Overdrive) - 4	88 km/h (55 mph)	34 km/h (22 mph)
4 - 3	72 km/h (45 mph)	27 km/h (18 mph)
3 - 2	56 km/h (35 mph)	21 km/h (14 mph)
2 - 1	32 km/h (20 mph)	11 km/h (8 mph)

Reverse

Ensure that the vehicle is at a complete stop before shifting into R (Reverse). Failure to do so may damage the transmission.

Put the gearshift lever into N and wait at least several seconds before shifting into R.

You can shift into R (Reverse) only by moving the gearshift lever from left of 3 (Third) and 4 (Fourth) gears before you shift into R (Reverse). This is a special lockout feature that protects you from accidentally shifting into R (Reverse) when you downshift from 5 (Overdrive).

FOUR-WHEEL DRIVE (4WD) OPERATION (IF EQUIPPED)



For important information regarding safe operation of this type of vehicle, see **Preparing to drive your vehicle** in this chapter.

When Four-wheel drive (4WD) is engaged, power is supplied to all four wheels through a transfer case. 4WD power can be selected when additional driving power is desired.

If equipped with the Electronic Shift 4WD System, and the instrument panel control is moved to 4WD Low while the vehicle is moving, the system will not engage and no damage will occur to the 4WD system. Before 4WD Low can be engaged, the vehicle must be brought to a complete stop with the brake pedal depressed and the transmission placed in neutral (or the clutch pedal depressed on manual transmissions).

4WD operation is not recommended on dry pavement. Doing so could result in difficult disengagement of the transfer case, increased tire wear and decreased fuel economy.

4WD system indicator lights

The 4WD system indicator lights illuminate only under the following conditions. If these lights illuminate when driving in 2WD, contact your Ford dealer as soon as possible.

- **4WD HIGH** -momentarily illuminates when the vehicle is started. Illuminates when 4H (4WD High) is engaged. **4WD HIGH**
- **4WD LOW** –momentarily illuminates when the vehicle is started. Illuminates when 4L (4WD Low) is engaged. **4WD LOW**

Using the electronic shift 4WD system (if equipped)

Positions of the electronic shift system

2WD (2WD High) – Power to rear axle only.

4X4 HIGH (4WD High) – Power delivered to front and rear axles for increased traction.

4X4 LOW (4WD Low) – Power to front and rear axles at low speeds.

Driving

Shifting from 2WD (2WD high) to 4X4 HIGH (4WD high)

Move the 4WD control to the 4X4 HIGH position.

- At temperatures below 0°C (32°F), shifts from 2WD to 4X4 HIGH should not be performed above 72 km/h (45 mph).

Do not shift into 4X4 HIGH with the rear wheels slipping.

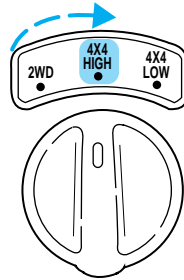

Shifting from 4X4 HIGH (4WD high) to 2WD (2WD high)

Move the 4WD control to 2WD position at any forward speed.

- You **do not** need to operate the vehicle in R (Reverse) to disengage your front hubs.

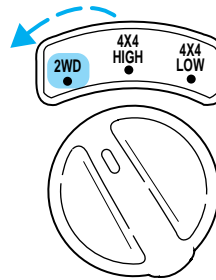

Shifting from 2WD (2WD high) to 4X4 LOW (4WD low)

1. Bring the vehicle to a stop.
2. Depress the brake.
3. Place the gearshift in N (Neutral) (automatic transmission) or depress the clutch (manual transmission).
4. Move the 4WD control to the 4X4 LOW position.

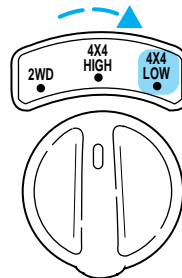

Shifting from 4X4 LOW (4WD low) to 2WD (2WD high)

1. Bring the vehicle to a stop.
2. Depress the brake.
3. Place the gearshift in N (Neutral) (automatic transmission) or depress the clutch (manual transmission).
4. Move the 4WD control to the 2WD position.

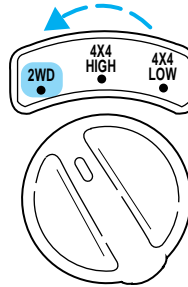

Shifting between 4X4 HIGH (4WD high) and 4X4 LOW (4WD low)

1. Bring the vehicle to a stop.
2. Depress the brake.
3. Place the gearshift in N (Neutral) (automatic transmission) or depress the clutch (manual transmission).
4. Move the 4WD control to the 4X4 HIGH or 4X4 LOW position.

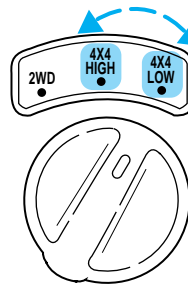

Driving off-road with 4WD

Your vehicle is specially equipped for driving on sand, snow, mud and rough terrain and has operating characteristics that are somewhat different from conventional vehicles, both on and off the road.

Driving

Maintain steering wheel control at all times, especially in rough terrain. Since sudden changes in terrain can result in abrupt steering wheel motion, make sure you grip the steering wheel from the outside. Do not grip the spokes.

Drive cautiously to avoid vehicle damage from concealed objects such as rocks and stumps.

You should either know the terrain or examine maps of the area before driving. Map out your route before driving in the area. For more information on driving off-road, read the “Four Wheeling” supplement in your owner’s portfolio.

If your vehicle gets stuck

If the vehicle is stuck it may be rocked out by shifting from forward and reverse gears, stopping between shifts, in a steady pattern. Press lightly on the accelerator in each gear.

Do not rock the vehicle if the engine is not at normal operating temperature or damage to the transmission may occur.

Do not rock the vehicle for more than a few minutes or damage to the transmission and tires may occur or the engine may overheat.



Do not spin the wheels at over 56 km/h (35 mph). The tires may fail and injure a passenger or bystander.

Sand

When driving over sand, try to keep all four wheels on the most solid area of the trail. Do not reduce the tire pressures but shift to a lower gear and drive steadily through the terrain. Apply the accelerator slowly and avoid spinning the wheels.

Mud and water

If you must drive through high water, drive slowly. Traction or brake capability may be limited.

When driving through water, determine the depth; avoid water higher than the bottom of the hubs (if possible) and proceed slowly. If the ignition system gets wet, the vehicle may stall.

Once through water, always try the brakes. Wet brakes do not stop the vehicle as effectively as dry brakes. Drying can be improved by moving your vehicle slowly while applying light pressure on the brake pedal.

After driving through mud, clean off residue stuck to the driveshafts and tires. Excess mud stuck on tires and rotating driveshafts causes an imbalance that could damage drive components.

If the transmission, transfer case or front axle are submerged in water, their fluids should be checked and changed, if necessary.

Water intrusion into the transmission may damage the transmission.

Replace rear axle lubricant any time the axle has been submerged in water. The rear axle does not normally require a lubricant change for the life of the vehicle. Rear axle lubricant quantities are not to be checked or changed unless a leak is suspected or repair is required.

Driving on hilly or sloping terrain

When driving on a hill, avoid driving crosswise or turning on steep slopes. You could lose traction and slip sideways. Drive straight up, straight down or avoid the hill completely. Know the conditions on the other side of a hill before driving over the crest.

When climbing a steep hill, start in a lower gear rather than downshifting to a lower gear from a higher gear once the ascent has started. This reduces strain on the engine and the possibility of stalling.

When descending a steep hill, avoid sudden braking. Shift to a lower gear when added engine braking is desired.

When speed control is on and you are driving uphill, your vehicle speed may drop considerably, especially if you are carrying a heavy load.

If vehicle speed drops more than 16 km/h (10 mph), the speed control will cancel automatically. Resume speed with accelerator pedal.

If speed control cancels after climbing the hill, reset speed by pressing and holding the SET ACCEL button (to resume speeds over 50 km/h [30 mph]).

Automatic transmissions may shift frequently while driving up steep grades. Eliminate frequent shifting by shifting out of **D** (Overdrive) into a lower gear.

Driving on snow and ice

A 4WD vehicle has advantages over 2WD vehicles in snow and ice but can skid like any other vehicle.

Driving

Avoid sudden applications of power and quick changes of direction on snow and ice. Apply the accelerator slowly and steadily when starting from a full stop.

When braking, apply the brakes as you normally would. In order to allow the anti-lock brake system (ABS) to operate properly, keep steady pressure on the brake pedal.

Allow more stopping distance and drive slower than usual. Consider using one of the lower gears.

TRACTION-LOK AXLE (IF EQUIPPED)

This axle provides added traction on slippery surfaces, particularly when one wheel is on a poor traction surface. Under normal conditions, the Traction-Lok axle functions like a standard rear axle.

Extended use of other than the manufacturer's specified size tires on a Traction-Lok rear axle could result in a permanent reduction in effectiveness. This loss of effectiveness does not affect normal driving and should not be noticeable to the driver.



To avoid injury, never run the engine with one wheel off the ground, such as when changing a tire.

DRIVING THROUGH WATER

Do not drive quickly through standing water, especially if the depth is unknown. Traction or brake capability may be limited and if the ignition system gets wet, your engine may stall. Water may also enter your engine's air intake and severely damage your engine.

If driving through deep or standing water is unavoidable, proceed very slowly. Never drive through water that is higher than the bottom of the hubs (for trucks) or the bottom of the wheel rims (for cars).

Once through the water, always try the brakes. Wet brakes do not stop the vehicle as effectively as dry brakes. Drying can be improved by moving your vehicle slowly while applying light pressure on the brake pedal.

Driving through deep water where the transmission vent tube is submerged may allow water into the transmission and cause internal transmission damage.

VEHICLE LOADING

Before loading a vehicle, familiarize yourself with the following terms:

- **Base Curb Weight:** Weight of the vehicle including any standard equipment, fluids, lubricants, etc. It does not include passengers or aftermarket equipment.
- **Payload:** Combined maximum allowable weight of cargo, passengers and optional equipment. The payload equals the gross vehicle weight rating minus base curb weight.
- **GVW (Gross Vehicle Weight):** Base curb weight plus payload weight. The GVW is not a limit or a specification.
- **GVWR (Gross Vehicle Weight Rating):** Maximum total weight of the base vehicle, passengers, optional equipment and cargo. The GVWR is specific to each vehicle and is listed on the Safety Compliance Label on the driver's door pillar.
- **GAWR (Gross Axle Weight Rating):** Carrying capacity for each axle system. The GAWR is specific to each vehicle and is listed on the Safety Compliance Label on the driver's door pillar.
- **GCW (Gross Combined Weight):** The combined weight of the towing vehicle (including passengers and cargo) and the trailer.
- **GCWR (Gross Combined Weight Rating):** Maximum combined weight of towing vehicle (including passengers and cargo) and the trailer. The GCWR indicates the maximum loaded weight that the vehicle is designed to tow.
- **Maximum Trailer Weight Rating:** Maximum weight of a trailer the vehicle is permitted to tow. The maximum trailer weight rating is determined by subtracting the vehicle curb weight for each engine/transmission combination, any required option weight for trailer towing and the weight of the driver from the GCWR for the towing vehicle.
- **Maximum Trailer Weight:** Maximum weight of a trailer the loaded vehicle (including passengers and cargo) is permitted to tow. It is determined by subtracting the weight of the loaded trailer towing vehicle from the GCWR for the towing vehicle.
- **Trailer Weight Range:** Specified weight range that the trailer must fall within that ranges from zero to the maximum trailer weight rating.

Remember to figure in the tongue load of your loaded trailer when figuring the total weight.

Driving



Do not exceed the GVWR or the GAWR specified on the certification label.

Do not use replacement tires with lower load carrying capacities than the originals because they may lower the vehicle's GVWR and GAWR limitations. Replacement tires with a higher limit than the originals do not increase the GVWR and GAWR limitations.

The Certification Label, found on the inside pillar of the driver's door, lists several important vehicle weight rating limitations. Before adding any additional equipment, refer to these limitations. If you are adding weight to the front of your vehicle, (potentially including weight added to the cab), the weight added should not exceed the front axle reserve capacity (FARC). Additional frontal weight may be added to the front axle reserve capacity provided you limit your payload in other ways (i.e. restrict the number of passengers or amount of cargo carried).

You may add equipment throughout your vehicle if the total weight added is equal to or less than the total axle reserve capacity (TARC) weight. You should NEVER exceed the total axle reserve capacity.

Always ensure that the weight of passengers, cargo and equipment being carried is within the weight limitations that have been established for your vehicle including both gross vehicle weight and Front and rear gross axle weight rating limits. Under no circumstance should these limitations be exceeded. Exceeding any vehicle weight rating limitation could result in serious damage to the vehicle and/or personal injury.

Special loading instructions for owners of pickup trucks and utility-type vehicles



For important information regarding safe operation of this type of vehicle, see the **Preparing to drive your vehicle** section in the **Driving** chapter of this owner guide.



Loaded vehicles, with a higher center of gravity, may handle differently than unloaded vehicles. Extra precautions, such as slower speeds and increased stopping distance, should be taken when driving a heavily loaded vehicle.

Your vehicle has the capability to haul more cargo and people than most passenger cars. Depending upon the type and placement of the load, hauling cargo and people may raise the center of gravity of the vehicle.

Calculating the load your vehicle can carry/tow

1. Use the appropriate maximum gross combined weight rating (GCWR) chart to find the maximum GCWR for your type engine and rear axle ratio.
2. Weigh your vehicle as you customarily operate the vehicle without cargo. To obtain correct weights, try taking your vehicle to a shipping company or an inspection station for trucks.
3. Subtract your loaded vehicle weight from the maximum GCWR on the following charts. This is the maximum trailer weight your vehicle can tow and must fall below the maximum shown under maximum trailer weight on the chart.

TRAILER TOWING

Your vehicle may tow a class I, II or III trailer provided the maximum trailer weight is less than or equal to the maximum trailer weight listed for your engine and rear axle ratio on the following charts.

Your vehicle's load capacity is designated by weight, not by volume, so you cannot necessarily use all available space when loading a vehicle.

Towing a trailer places an additional load on your vehicle's engine, transmission, axle, brakes, tires and suspension. Inspect these components carefully after any towing operation.

Driving

Trailer towing table (4x2 manual transmission)				
Engine	Rear axle ratio	Maximum GCWR-kg (lbs.)	Maximum trailer weight-kg (lbs.) (0-maximum)	Maximum frontal area of trailer-m² (ft²)
Regular Cab 4x2				
2.5L	3.73	2 177 (4 800)	0-717 (0-1 580)	Equal to frontal area of base vehicle
2.5L	4.10	2 177 (4 800)	0-717 (0-1 580)	Equal to frontal area of base vehicle
3.0L	3.73	2 721 (6 000)	0-1 207 (0-2 660)	4.64 (50)
3.0L Torsion Bar Suspension	4.10	2 721 (6 000)	0-1 179 (0-2 600)	4.64 (50)
4.0L	3.55	3 175 (7 000)	0-1 633 (0-3 600)	4.64 (50)
SuperCab 4x2				
2.5L	3.73	2 177 (4 800)	0-617 (0-1 360)	Equal to frontal area of base vehicle
2.5L	4.10	2 177 (4 800)	0-617 (0-1 360)	Equal to frontal area of base vehicle
3.0L	3.73	2 271 (6 000)	0-1 116 (0-2 460)	4.64 (50)
4.0L	3.55	3 175 (7 000)	0-1 542 (0-3 400)	4.64 (50)
For high altitude operation, reduce GCW by 2% per 300 meters (1 000 ft.) elevation.				
For definition of terms used in this table see <i>Vehicle Loading</i> earlier in this chapter.				
To determine maximum trailer weight designed for your particular vehicle, see <i>Calculating the load</i> earlier in this chapter.				

Trailer towing table (4x2 manual transmission)

Maximum trailer weight is shown. The combined weight of the completed towing vehicle (including hitch, passengers and cargo) and the loaded trailer must not exceed the Gross Combined Weight Rating (GCWR).

Trailer tow table (4x4 manual transmission)

Engine	Rear axle ratio	Maximum GCWR-kg (lbs.)	Maximum trailer weight-kg (lbs.)	Maximum frontal area of trailer-m ² (ft ²)
Regular Cab				
3.0L	3.73	2 721 (6 000)	0-1 089 (0-2 400)	4.64 (50)
3.0L	4.10	2 721 (6 000)	0-1 089 (0-2 400)	4.64 (50)
4.0L	3.73	3 175 (7 000)	0-1 515 (0-3 340)	4.64 (50)
4.0L	4.10	3 175 (7 000)	0-1 515 (0-3 340)	4.64 (50)
SuperCab				
3.0L	3.73	2 721 (6 000)	0-998 (0-2 200)	4.64 (50)
3.0L	4.10	2 721 (6 000)	0-998 (0-2 200)	4.64 (50)
4.0L	3.73	3 175 (7 000)	0-1 433 (0-3 160)	4.64 (50)
4.0L	4.10	3 175 (7 000)	0-1 433 (0-3 160)	4.64 (50)
For high altitude operation, reduce GCW by 2% per 300 meters (1 000 ft.) of elevation.				
For definition of terms used in this table, see <i>Vehicle loading</i> earlier in this chapter.				
To determine maximum trailer weight designed for your vehicle, see <i>Calculating the load</i> earlier in this chapter.				
Maximum trailer weight is shown. The combined weight of the completed towing vehicle (including hitch, passengers and cargo) and the loaded trailer must not exceed the Gross Combined Weight Rating (GCWR).				

Driving

Trailer towing table (4x2 automatic transmission)				
Engine	Rear axle ratio	Maximum GCWR-kg (lbs.)	Maximum trailer weight-kg (lbs.) (0-maximum)	Maximum frontal area of trailer-m² (ft²)
Regular Cab 4x2				
2.5L	4.10	2 494 (5 500)	0-989 (2 180)	Equal to frontal area of base vehicle
3.0L	3.73	3 401 (7 500)	0-1 869 (0-4 120)	4.64 (50)
3.0L Torsion Bar Suspension	4.10	3 401 (7 500)	0-1 842 (0-4 060)	4.64 (50)
4.0L	3.55	4 309 (9 500)	0-2 749 (0-6 060)	4.64 (50)
SuperCab 4x2				
3.0L	3.73	3 401 (7 500)	0-1 778 (0-3 920)	4.64 (50)
4.0L	3.55	4 309 (9 500)	0-2 658 (0-5 860)	4.64 (50)
For high altitude operation, reduce GCW by 2% per 300 meters (1 000 ft.) elevation.				
For definition of terms used in this table see <i>Vehicle Loading</i> earlier in this chapter.				
To determine maximum trailer weight designed for your particular vehicle, see <i>Calculating the load</i> earlier in this chapter.				
Maximum trailer weight is shown. The combined weight of the completed towing vehicle (including hitch, passengers and cargo) and the loaded trailer must not exceed the Gross Combined Weight Rating (GCWR).				

Trailer tow table (4x4 automatic transmission)				
Engine	Rear axle ratio	Maximum GCWR-kg (lbs.)	Maximum trailer weight-kg (lbs.)	Maximum frontal area of trailer-m² (ft²)
Regular Cab				
3.0L	3.73	3 401 (7 500)	0-1 751 (0-3 860)	4.64 (50)
3.0L	4.10	3 628 (8 000)	0-1 978 (0-4 360)	4.64 (50)
4.0L	3.73	4 309 (9 500)	0-2 631 (0-5 800)	4.64 (50)
4.0L	4.10	4 309 (9 500)	0-2 631 (0-5 800)	4.64 (50)
SuperCab				
3.0L	3.73	3 401 (7 500)	0-1 660 (0-3 660)	4.64 (50)
3.0L	4.10	3 628 (8 000)	0-1 887 (0-4 160)	4.64 (50)
4.0L	3.73	4 309 (9 500)	0-2 549 (5 620)	4.64 (50)
4.0L	4.10	4 309 (9 500)	0-2 549 (0-5 620)	4.64 (50)
For high altitude operation, reduce GCW by 2% per 300 meters (1 000 ft.) of elevation.				
For definition of terms used in this table, see <i>Vehicle loading</i> earlier in this chapter.				
To determine maximum trailer weight designed for your vehicle, see <i>Calculating the load</i> earlier in this chapter.				
Maximum trailer weight is shown. The combined weight of the completed towing vehicle (including hitch, passengers and cargo) and the loaded trailer must not exceed the Gross Combined Weight Rating (GCWR).				



Do not exceed the GVWR or the GAWR specified on the certification label.

Driving



Towing trailers beyond the maximum recommended gross trailer weight could result in engine damage, transmission/axle damage, structural damage, loss of control, and personal injury.

Preparing to tow

Use the proper equipment for towing a trailer, and make sure it is properly attached to your vehicle. See your dealer or a reliable trailer dealer if you require assistance.

Hitches

For towing trailers up to 907 kg (2 000 lb), use a weight carrying hitch and ball which uniformly distributes the trailer tongue loads through the underbody structure. Use a frame-mounted weight distributing hitch for trailers over 907 kg (2 000 lb).

Do not install a single or multi-clamp type bumper hitch, or a hitch which attaches to the axle. Underbody mounted hitches are acceptable if they are installed properly. Follow the towing instructions of a reputable rental agency.

Whenever a trailer hitch and hardware are removed, make sure all mounting holes in the underbody are properly sealed to prevent noxious gases or water from entering.

Safety chains

Always connect the trailer's safety chains to the frame or hook retainers of the vehicle. To connect the trailer's safety chains, cross the chains under the trailer tongue and allow slack for turning corners.

If you use a rental trailer, follow the instructions that the rental agency gives to you.

Do not attach safety chains to the bumper.

Trailer brakes

Electric brakes and manual, automatic or surge-type trailer brakes are safe if installed properly and adjusted to the manufacturer's specifications. The trailer brakes must meet local and Federal regulations.



Do not connect a trailer's hydraulic brake system directly to your vehicle's brake system. Your vehicle may not have enough braking power and your chances of having a collision greatly increase.

The braking system of the tow vehicle is rated for operation at the GVWR not GCWR.

Trailer lamps

Trailer lamps are required on most towed vehicles. Make sure your trailer lamps conform to local and Federal regulations. See your dealer or trailer rental agency for proper instructions and equipment for hooking up trailer lamps.

Using a step bumper

The optional step bumper is equipped with an integral hitch and requires only a ball with a 19 mm (3/4 inch) shank diameter. The bumper has a 907 kg (2 000 lb.) trailer weight and 91 kg (200 lb.) tongue weight capability.

The rated capacities (as shown in this guide) for trailer towing with the factory bumper are only valid when the trailer hitch ball is installed directly into the ball hole in the bumper. Addition of bracketry to either lower the ball hitch position or extend the ball hitch rearward will significantly increase the loads on the bumper and its attachments. This can result in the failure of the bumper or the bumper attachments. Use of any type of hitch extensions should be considered abuse.

Trailer tow connector

The trailer tow connector is located under the rear bumper, on the driver's side of the vehicle.

Refer to the following chart for information regarding the factory-equipped trailer tow connector:

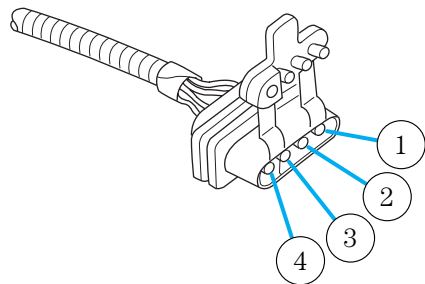

Driving

Trailer tow connector		
Color	Function	Comment
1. Dark Green	Trailer right hand turn signal	Circuit activated when brake pedal is depressed or when ignition is on and right hand turn signal is applied.
2. Yellow	Trailer left hand turn signal	Circuit activated when brake pedal is depressed or when ignition is on and left hand turn signal is applied.
3. Tan/White	Tail lamp	Relay controlled circuit activated when the park lamps/headlamps are on.
4. White	Ground	Matching vehicle circuit returns to battery's negative ground.

Driving while you tow

When towing a trailer:

- Ensure that you turn off your speed control. The speed control may shut off automatically when you are towing on long, steep grades.
- Consult your local motor vehicle speed regulations for towing a trailer.
- Use a lower gear when towing up or down steep hills. This will eliminate excessive downshifting and upshifting for optimum fuel economy and transmission cooling.
- Anticipate stops and brake gradually.

Exceeding the GCWR rating may cause internal transmission damage and void your warranty coverage.

Servicing after towing

If you tow a trailer for long distances, your vehicle will require more frequent service intervals. Refer to your Scheduled Maintenance guide for more information.

Trailer towing tips

- Practice turning, stopping and backing up in an area before starting on a trip to get the feel of the vehicle trailer combination. When turning, make wider turns so the trailer wheels will clear curbs and other obstacles.

- Allow more distance for stopping with a trailer attached.
- The trailer tongue weight should be no more than 10–15% of the loaded trailer weight.
- After you have traveled 80 km (50 miles), thoroughly check your hitch, electrical connections and trailer wheel lug nuts.
- When stopped in traffic for long periods of time in hot weather, place the gearshift in P (Park) (automatic transmissions) or N (Neutral) (manual transmissions). This aids engine cooling and air conditioner efficiency.
- Vehicles with trailers should not be parked on a grade. If you must park on a grade, place wheel chocks under the trailer's wheels.

Launching or retrieving a boat

When backing down a ramp during boat launching or retrieval,

- Do not allow the static water level to rise above the bottom edge of the rear bumper and
- Do not allow waves to break higher than 15 cm (6 inches) above the bottom edge of the rear bumper.

Exceeding these limits may allow water to enter critical vehicle components, adversely affecting driveability, emissions, reliability and causing internal transmission damage.

Replace the rear axle lubricant anytime the axle has been submerged in water. Rear axle lubricant quantities are not to be checked or changed unless a leak is suspected or repair required.

Disconnect the wiring to the trailer before backing the trailer into the water. Reconnect the wiring to the trailer after the trailer is removed from the water.

Driving

Recreational towing

Follow these guidelines if you have a need for recreational towing. An example of recreational towing would be towing your vehicle behind a motorhome. These guidelines are designed to ensure that your transmission is not damaged.

4x2 and 4x4 vehicles equipped with manual transmissions

Before you have your vehicle towed:

- Release the parking brake.
- Move the gearshift to N (Neutral).
- Turn the key in the ignition to the OFF/UNLOCKED position.
- The maximum recommended speed is 88 km/h (55 mph).
- The maximum recommended distance is unlimited.

In addition, it is recommended that you follow the instructions provided by the after market manufacturer of the towing apparatus if one has been installed.

4x2 and 4x4 vehicles equipped with automatic transmissions

For all cars, 4x2 truck/sports utility with automatic transmissions, or 4x4 truck/sport utility with manual transfer cases and automatic transmissions, follow these guidelines for recreational towing:

- Release the parking brake.
- Turn the key in the ignition to the OFF/UNLOCKED position.
- Place the transmission in N (Neutral).
- Do not exceed a distance of 80 km (50 miles).
- Do not exceed 56 km/h (35 mph) vehicle speed.

If a distance of 80 km (50 miles) or a speed of 56 km/h (35 mph) must be exceeded, you must disconnect the driveshaft. Ford recommends the driveshaft be removed/installed only by a qualified technician. See your local dealer for driveshaft removal/installation.

Improper removal/installation of the driveshaft can cause transmission fluid loss, damage to the driveshaft and internal transmission components.

CAMPER BODIES

Your Ranger Pickup is not recommended for slide-in camper bodies.

Roadside emergencies

GETTING ROADSIDE ASSISTANCE

To fully assist you should you have a vehicle concern, Ford offers a complimentary roadside assistance program. This program is separate from the New Vehicle Limited Warranty. The service is available:

- 24-hours, seven days a week
- for the Basic warranty period (Canada) or New Vehicle Limited Warranty period (U.S.) of three years or 60,000 km (36,000 miles), whichever comes first on Ford and Mercury vehicles, and four years or 80,000 km (50,000 miles) on Lincoln vehicles

Roadside assistance will cover:

- changing a flat tire
- jump-starts
- lock-out assistance
- fuel delivery
- towing of your disabled vehicle to the nearest Ford dealership, or your selling dealer if within 25 kms (15.5 miles) of the nearest Ford Dealership (one tow per disablement). Even non-warranty related tows, like accidents or getting stuck in the mud or snow, are covered (some exclusions apply, such as impound towing or repossession).

Using roadside assistance

Complete the roadside assistance identification card and place it in your wallet for quick reference. In the United States, this card is found in the Owner Guide portfolio in the glove compartment in Ford vehicles and is mailed to you if you own a Mercury or Lincoln. In Canada, it is found in the Roadside Assistance book in the glove compartment.

To receive roadside assistance in the United States for Ford or Mercury vehicles, call 1-800-241-3673 or if you own a Lincoln vehicle, call 1-800-521-4140. In Canada call 1-800-665-2006.

Should you need to arrange roadside assistance for yourself, Ford will reimburse a reasonable amount. To obtain information about reimbursement, call 1-800-241-3673 in the United States for Ford or Mercury vehicles; or if you own a Lincoln vehicle, call 1-800-521-4140. Call 1-800-665-2006 in Canada.

Roadside emergencies

Roadside coverage beyond basic warranty

In the United States, you may purchase additional roadside assistance coverage beyond this period through the Ford Auto Club by contacting your Ford or Lincoln Mercury dealer.

Similarly in Canada, you may purchase additional coverage beyond the basic coverage period by consulting the Ford Roadside Assistance Club brochure or by calling 1-877-294-CLUB (1-877-894-2582).

HAZARD FLASHER

Use only in an emergency to warn traffic of vehicle breakdown, approaching danger, etc. The hazard flashers can be operated when the ignition is off.

- The hazard lights control is located on top of the steering column.
- Depress hazard lights control to activate all hazard flashers simultaneously.
- Depress control again to turn the flashers off.

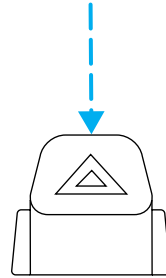

RESETTING THE FUEL PUMP SHUT-OFF SWITCH

The fuel pump shut-off switch is a device intended to stop the electric fuel pump when your vehicle has been involved in a substantial jolt.

After a collision, if the engine cranks but does not start, the fuel pump shut-off switch may have been activated. The “Fuel Reset” indicator light will illuminate in the instrument cluster.

Roadside emergencies

The fuel pump shut-off switch is located in the passenger's foot well, by the kick panel.

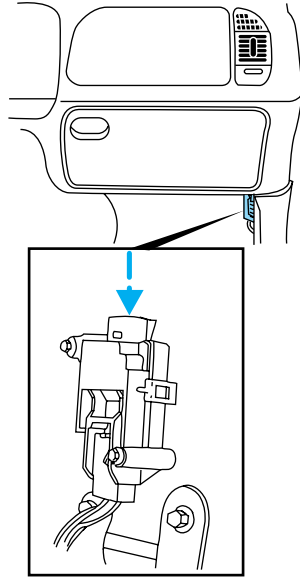

Use the following procedure to reset the fuel pump shut-off switch.

1. Turn the ignition to the OFF position.
2. Check the fuel system for leaks.
3. If no fuel leak is apparent, reset the fuel pump shut-off switch by pushing in on the reset button.
4. Turn the ignition to the ON position. Pause for a few seconds and return the key to the OFF position.
5. Make a further check for leaks in the fuel system.

Roadside emergencies

FUSES AND RELAYS

Fuses

If electrical components in the vehicle are not working, a fuse may have blown. Blown fuses are identified by a broken wire within the fuse. Check the appropriate fuses before replacing any electrical components.

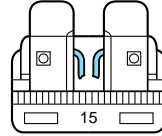

Always replace a fuse with one that has the specified amperage rating. Using a fuse with a higher amperage rating can cause severe wire damage and could start a fire.

Standard fuse amperage rating and color

COLOR					
Fuse Rating	Mini Fuses	Standard Fuses	Maxi Fuses	Cartridge Maxi Fuses	Fuse Link Cartridge
2A	Grey	Grey	—	—	—
3A	Violet	Violet	—	—	—
4A	Pink	Pink	—	—	—
5A	Tan	Tan	—	—	—
7.5A	Brown	Brown	—	—	—
10A	Red	Red	—	—	—
15A	Blue	Blue	—	—	—
20A	Yellow	Yellow	Yellow	Blue	Blue
25A	Natural	Natural	—	—	—
30A	Green	Green	Green	Pink	Pink
40A	—	—	Orange	Green	Green
50A	—	—	Red	Red	Red
60A	—	—	Blue	—	Yellow
70A	—	—	Tan	—	Brown
80A	—	—	Natural	—	Black

Roadside emergencies

Passenger compartment fuse panel

The fuse panel is located on the left hand side of the instrument panel facing the driver's side door. Pull the panel cover outward to access the fuses.

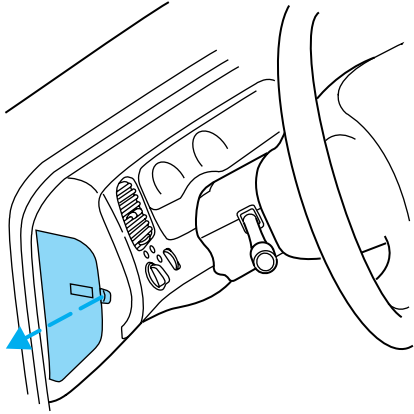

To remove a fuse use the fuse puller tool provided on the fuse panel cover.

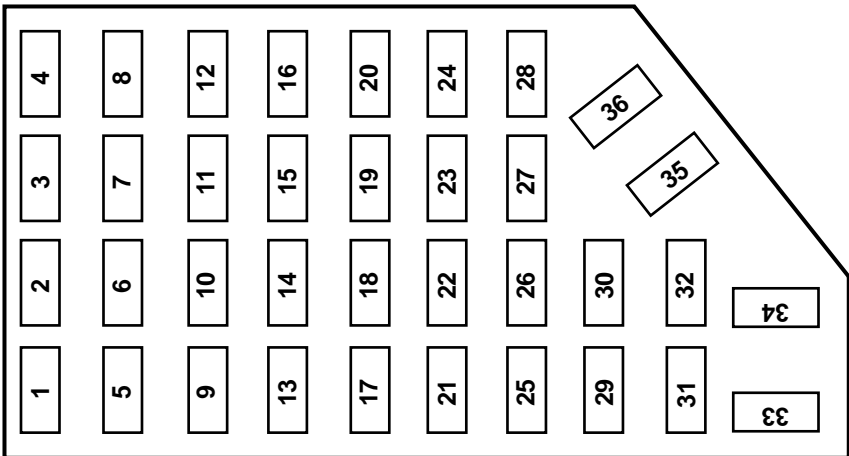

Roadside emergencies

The fuses are coded as follows:

Fuse/Relay Location	Fuse Amp Rating	Passenger Compartment Fuse Panel Description
1	7.5A	Power Mirror Switch
2	7.5A	Blower Motor Relay, PAD Module, Air Bag Diagnostic Monitor
3	7.5A	Left Stop/Turn Trailer Tow Connector
4	10A	Left Headlamp
5	—	Not Used
6	15A	Overdrive, Back-up Lamps, DRL, 4x4
7	7.5A	Right Stop/Turn Trailer Tow Connector
8	10A	Right Headlamp, Fog Lamp Relay
9	7.5A	Brake Pedal Position Switch
10	7.5A	Speed Control Servo/Amplifier Assembly, Generic Electronic Module (GEM), Shift Lock Actuator, Blend Door Actuator, A/C-Heater Assembly, Turn Signals
11	7.5A	Instrument Cluster, Daytime Running Lights (DRL), RABS Resistor
12	—	Not Used
13	20A	Brake Pedal Position Switch
14	20A or 10A	20A: If equipped with Rear Anti-Lock Brake System (RABS) Module. 10A: If equipped with 4 Wheel Anti-Lock Brake System (4WABS) Module, 4WABS Main Relay
15	7.5A	Air Bag Indicator Lamp, Alternator Indicator Lamp
16	30A	Windshield Wiper Motor, Wiper Hi-Lo Relay, Wiper Run/Park Relay
17	25A	Cigar Lighter, Data Link Connector (DLC)
18	15A	Driver's Unlock Relay, All-Unlock Relay, All-Lock Relay
19	25A	PCM Power Diode, Ignition, PATS
20	7.5A	RAP Module, Generic Electronic Module (GEM), Radio

Roadside emergencies

Fuse/Relay Location	Fuse Amp Rating	Passenger Compartment Fuse Panel Description
21	15A	Flasher (Hazard)
22	20A	Auxiliary Power Socket
23	—	Not Used
24	7.5A	Clutch Pedal Position (CPP) switch, Starter Interrupt Relay, Anti-Theft
25	—	Not Used
26	10A	Battery Saver Relay, Electronic Shift Relay, Interior Lamp Relay, Power Window Relay, Electronic Shift Control Module, Dome/Map Lamp, GEM, Instrument Cluster
27	—	Not Used
28	7.5A	Generic Electronic Module (GEM), Radio
29	15A	Radio
30	10A	RABS Test Connector
31	—	Not Used
32	—	Not Used
33	15A	Headlamps, Daytime Running Lamps (DRL) Module, Instrument Cluster
34	—	Not Used
35	—	Not Used
36	—	Not Used

Roadside emergencies

Power distribution box

The power distribution box is located in the engine compartment. The power distribution box contains high-current fuses that protect your vehicle's main electrical systems from overloads.

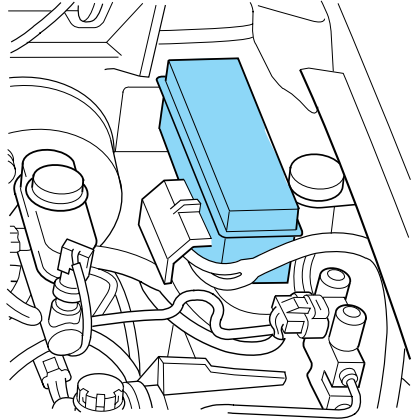

Always disconnect the battery before servicing high current fuses.



Always replace the cover to the Power Distribution Box before reconnecting the battery or refilling fluid reservoirs.

If the battery has been disconnected and reconnected, refer to the *Battery* section of the *Maintenance and care* chapter.

Roadside emergencies

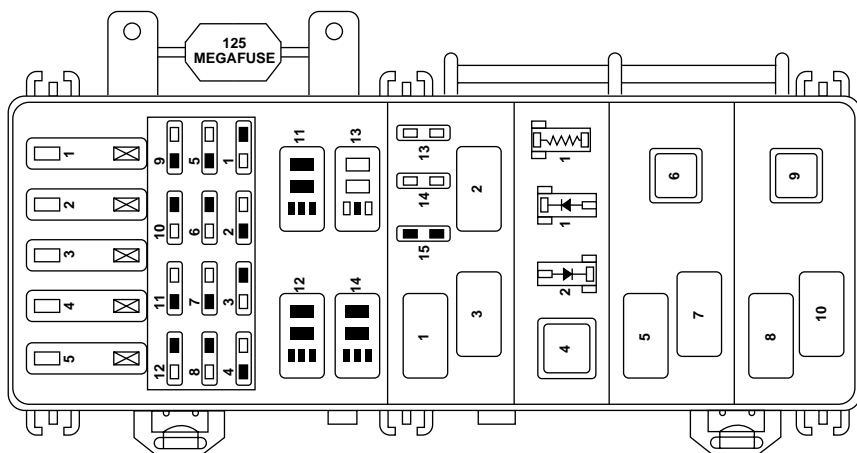

The high-current fuses are coded as follows:

Fuse/Relay Location	Fuse Amp Rating	Power Distribution Box Description
1	50A**	I/P Fuse Panel
2	40A**	Blower Motor Relay
3	50A**	4 Wheel Anti-Lock Brake System (4WABS) Module
4	20A**	Power Windows
5	50A**	Ignition Switch, Starter Relay
1	10A*	A/C Relay
2	—	Not Used
3	20A*	Electronic Shift Relay and Electronic Shift Control Module
4	20A*	Fog Lamp and Daytime Running Lamps
5	15A	Trailer Tow Park Lamps
6	10A*	Powertrain Control Module
7	30A*	4 Wheel Anti-lock Brake System (4WABS) Module
8	30A*	PCM Relay

Roadside emergencies

Fuse/Relay Location	Fuse Amp Rating	Power Distribution Box Description
9	20A*	Fuel Pump Relay and RAP Module
10	15A*	Horn Relay
11	15A*	Parklamps Relay and Main Light Switch
12	30A*	Main Light Switch and Multifunction Switch
13	15A*	Heated Oxygen Sensor, EGR Vacuum Regulator, EVR Solenoid, Camshaft Position Sensor (CMP), Canister Vent Solenoid
14	30A*	Alternator Voltage Regulator
15	—	Not Used
1	—	Wiper Park Relay
2	—	A/C Relay
3	—	Wiper Hi/Lo Relay
4	—	PCM Power Relay
5	—	Fuel Pump Relay
6	—	Starter Relay
7	—	Horn Relay
8	—	Fog Lamp Control Relay
9	—	Blower Motor Relay
10	—	Foglamp Isolation Relay
11	—	Not Used
12	—	Not Used
13	—	Park Lamp/Trailer Tow Relay
14	—	Washer Pump Relay
1	—	RABS Resistor
1	—	RABS Diode
2	—	Electronic Engine Controls Diode
* Mini Fuses ** Maxi Fuses		

Roadside emergencies

CHANGING THE TIRES

If you get a flat tire while driving, do not apply the brake heavily. Instead, gradually decrease your speed. Hold the steering wheel firmly and slowly move to a safe place on the side of the road.

Temporary spare tire information

Your vehicle may have a temporary or conventional spare tire. The temporary spare tire for your vehicle is labeled as such. It is smaller than a regular tire and is designed for emergency use only. Replace this tire with a full-size tire as soon as possible.

It is not recommended that the vehicle be operated in 4WD modes with a temporary spare. If 4WD operation is necessary, do not operate above speeds of 16 km/h (10 mph) or for distances above 80 km (50 miles).



If you use the temporary spare tire continuously or do not follow these precautions, the tire could fail, causing you to lose control of the vehicle, possibly injuring yourself or others.

When driving with the temporary spare tire **do not:**

- exceed 80 km/h (50 mph) under any circumstances
- load the vehicle beyond maximum vehicle load rating listed on the Safety Compliance Label
- tow a trailer
- use tire chains
- drive through an automatic car wash, because of the vehicle's reduced ground clearance
- try to repair the temporary spare tire or remove it from its wheel
- use the wheel for any other type of vehicle

Conventional spare tire information

If you have the conventional spare tire, you can use it as a spare or a regular tire. The spare is identical to the other tires on your vehicle, although the wheel may not match.

Roadside emergencies

Location of the spare tire and tools

The spare tire and tools for your vehicle are stowed in the following locations:

Tool	Location
Spare tire	Under the vehicle, just forward of the rear bumper
Jack, jack handle, wheel nut wrench	Regular Cab: behind seats and underneath the jack and tools cover
	SuperCab: stowed in the passenger side rear cab compartment or behind the jump seat in a separate tool bag
	Four-door models: stowed behind the front seats, between jump seats and underneath jack and tools cover.
Key, spare tire lock (if equipped)	In the glove box

Removing the spare tire

1. Assemble the jack handle to the lug wrench as shown in the illustrations.

When connecting the jack handle, assemble the following:

- one handle extension and one typical extension. To assemble, slide parts together. To disconnect, depress button and pull apart.
- one wheel nut wrench. Depress button and slide together.

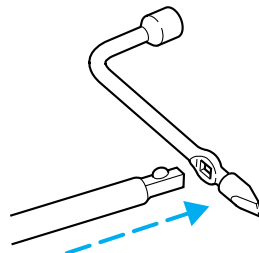
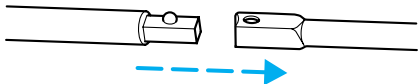

Roadside emergencies

2. If equipped, unlock and remove the spare tire carrier lock from the rear access hole located just above the rear bumper and below the tailgate.

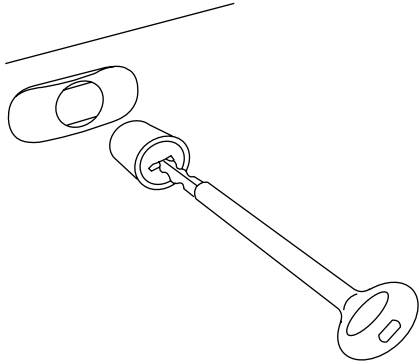

3. Insert the straight end of the jack handle into the rear access hole located just above the rear bumper and below the tailgate.

Forward motion will stop and resistance to turning will be felt when properly engaged.

4. Turn the handle counterclockwise until tire is lowered to the ground and the cable is slightly slack.

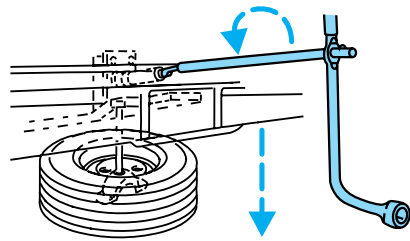

5. Remove the retainer from the spare tire.

Stowing the spare tire

1. Lay the tire on the ground with the valve stem facing up.

2. Install the retainer through the wheel center and slide the wheel under the vehicle.

3. Turn the spare handle clockwise until the tire is raised to its original position underneath the vehicle. The spare handle ratchets when the tire is raised to the stowed position. It will not allow you to overtighten.

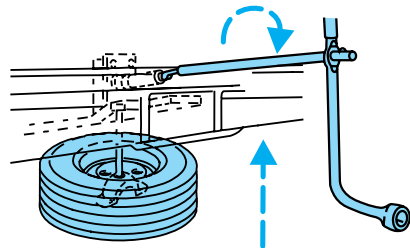

Roadside emergencies

4. If your vehicle is equipped with P265/75 R15 AT tires, do not stow a flat or inflated full size spare tire in the spare tire carrier. The flat full size tire should be stowed and tied down in the pickup box bed until it can be repaired.
5. If removed, install the spare tire carrier lock on the access hole above the bumper.

Tire change procedure



To prevent the vehicle from moving when you change a tire, be sure the parking brake is set, then block (in both directions) the wheel that is diagonally opposite (other side and end of the vehicle) to the tire being changed.



If the vehicle slips off the jack, you or someone else could be seriously injured.

1. Park on a level surface, activate hazard flashers and place gearshift lever in P (Park) (automatic transmission) or 1 (First) (manual transmission).
2. Set the parking brake and turn engine OFF.

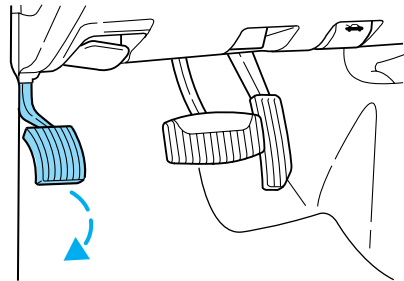

3. Block the diagonally opposite wheel.

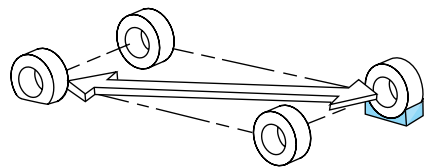

Roadside emergencies

4. Insert tapered end of the lug wrench behind hub caps and twist them off.

5. Loosen each wheel lug nut one-half turn counterclockwise but do not remove them until the wheel is raised off the ground.

6. Position the jack according to the following guides and turn the jack handle clockwise until the tire is a maximum of 25 mm (1 inch) off the ground.

- Front

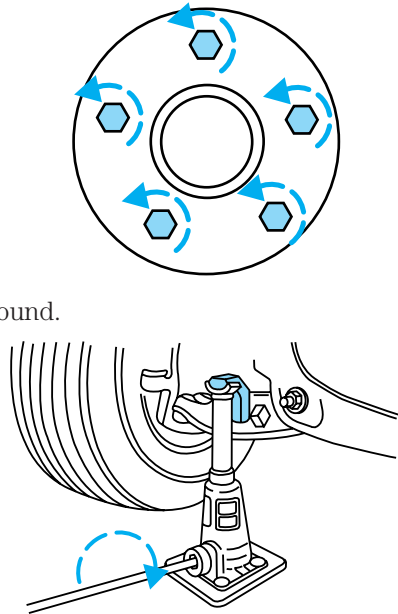

- Rear

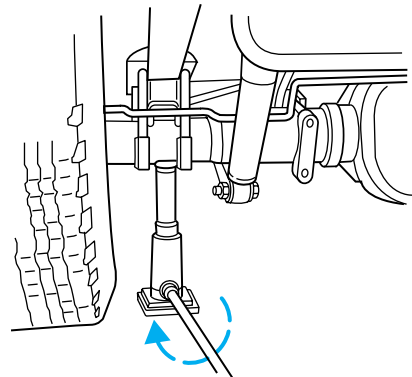

Roadside emergencies

 To lessen the risk of personal injury, do not put any part of your body under the vehicle while changing a tire. Do not start the engine when your vehicle is on the jack. The jack is only meant for changing the tire.

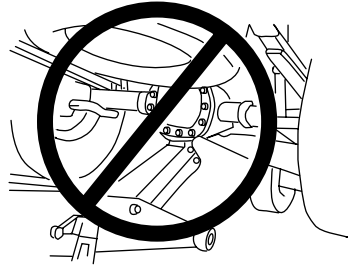

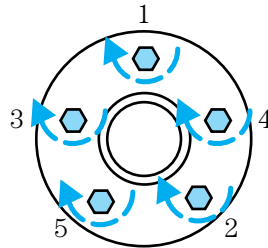

- **Never use the differential as a jacking point.**

7. Remove the wheel lug nuts with the lug wrench.
8. Replace the flat tire with the spare tire, making sure the valve stem is facing outward. Reinstall the lug nuts until the wheel is snug against the hub. Do not fully tighten the lug nuts until the wheel has been lowered.
9. Lower the wheel by turning the jack handle counterclockwise.
10. Remove the jack and fully tighten the lug nuts in the order shown.
11. Stow the flat tire. Refer to *Stowing the spare tire*.
12. Stow the jack and lug wrench. Make sure the jack is fastened so it does not rattle when you drive.
13. Unblock the wheels.



JUMP STARTING YOUR VEHICLE

 The gases around the battery can explode if exposed to flames, sparks, or lit cigarettes. An explosion could result in injury or vehicle damage.

 Do not push start your vehicle. You could damage the catalytic converter.

 Batteries contain sulfuric acid which can burn skin, eyes, and clothing, if contacted.

Roadside emergencies

Do not attempt to push start your vehicle. Automatic transmissions do not have push-start capability.

Preparing your vehicle

1. **Use only a 12-volt supply to start your vehicle.**
2. Do not disconnect the battery of the disabled vehicle as this could damage the vehicle's electrical system.
3. Park the booster vehicle close to the hood of the disabled vehicle making sure the two vehicles **do not** touch. Set the parking brake on both vehicles and stay clear of the engine cooling fan and other moving parts.
4. Check all battery terminals and remove any excessive corrosion before you attach the battery cables. Ensure that vent caps are tight and level.
5. Turn the heater fan on in both vehicles to protect any electrical surges. Turn all other accessories off.

Connecting the jumper cables

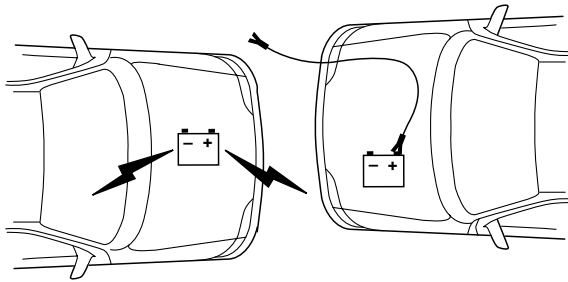

1. Connect the positive (+) booster cable to the positive (+) terminal of the discharged battery.

Note: In the illustrations, *lightning bolts* are used to designate the assisting (boosting) battery.

Roadside emergencies

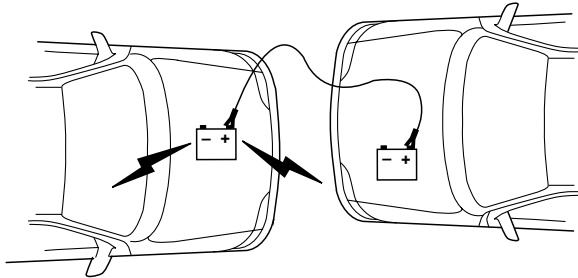

2. Connect the other end of the positive (+) cable to the positive (+) terminal of the assisting battery.

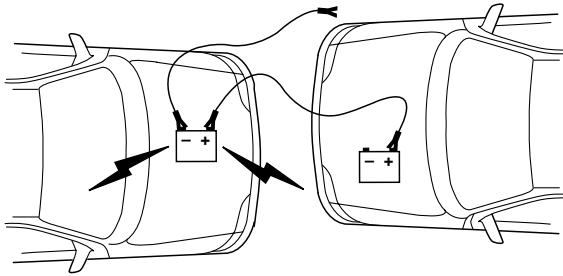

3. Connect the negative (-) cable to the negative (-) terminal of the assisting battery.

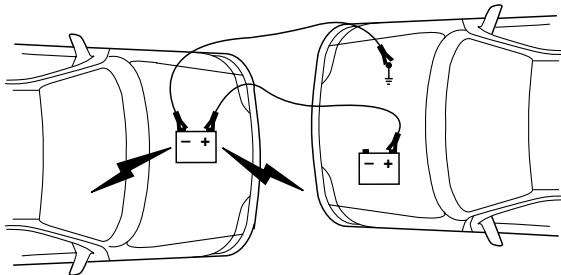

4. Make the final connection of the negative (-) cable to an exposed metal part of the stalled vehicle's engine, away from the battery and the carburetor/fuel injection system. **Do not** use fuel lines, engine rocker covers or the intake manifold as *grounding* points.

Roadside emergencies



Do not connect the end of the second cable to the negative (-) terminal of the battery to be jumped. A spark may cause an explosion of the gases that surround the battery.

5. Ensure that the cables are clear of fan blades, belts, moving parts of both engines, or any fuel delivery system parts.

Jump starting

1. Start the engine of the booster vehicle and run the engine at moderately increased speed.
2. Start the engine of the disabled vehicle.
3. Once the disabled vehicle has been started, run both engines for an additional three minutes before disconnecting the jumper cables.

Removing the jumper cables

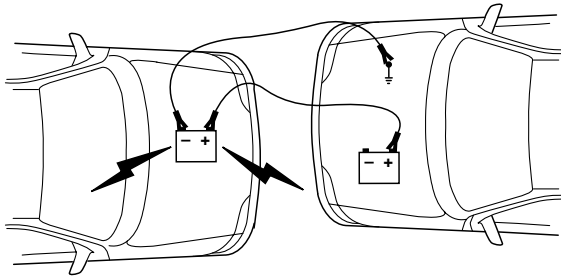

Remove the jumper cables in the reverse order that they were connected.

1. Remove the jumper cable from the *ground* metal surface.

Roadside emergencies

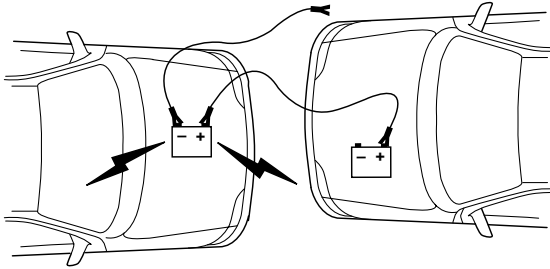

2. Remove the jumper cable on the negative (-) connection of the booster vehicle's battery.

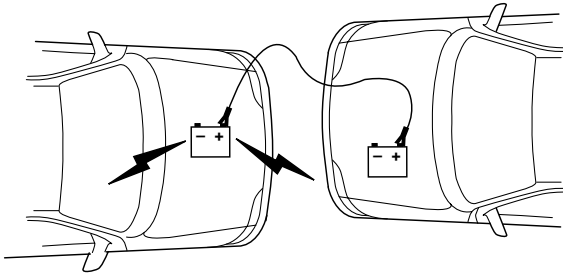

3. Remove the jumper cable from the positive (+) terminal of the booster vehicle's battery.

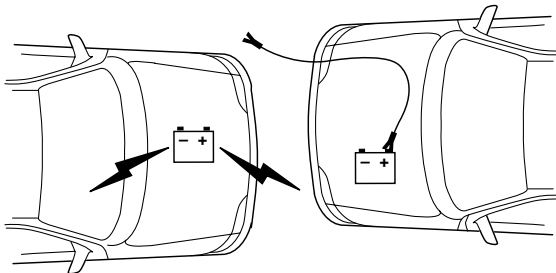

4. Remove the jumper cable from the positive (+) terminal of the disabled vehicle's battery.

After the disabled vehicle has been started and the jumper cables removed, allow it to idle for several minutes so the engine computer can *relearn* its idle conditions.

Roadside emergencies

WRECKER TOWING

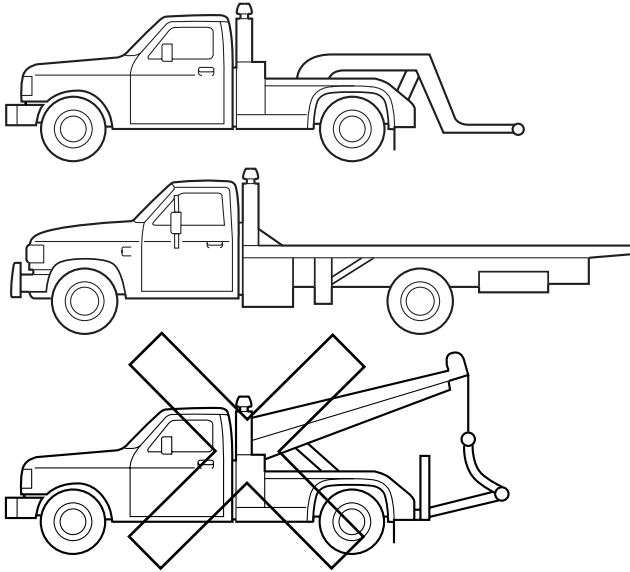

If you need to have your vehicle towed, contact a professional towing service or, if you are a member, your roadside assistance center.

It is recommended that your vehicle be towed with a wheel lift or flatbed equipment. Do not tow with a slingbelt. Ford Motor Company has not approved a slingbelt towing procedure.

On 4x2 vehicles, it is acceptable to tow the vehicle with the front wheels on the ground and the rear wheels off the ground.

On 4x4 vehicles, it is recommended that your vehicle be towed with a wheel lift and dollies or flatbed equipment with all the wheels off the ground.

If the vehicle is towed by other means or incorrectly, vehicle damage may occur.

Ford Motor Company provides a towing manual for all authorized tow truck operators. Have your tow truck operator refer to this manual for proper hook-up and towing procedures for your vehicle.

Maintenance and care

SERVICE RECOMMENDATIONS

To help you service your vehicle:

- We highlight do-it-yourself items in the engine compartment for easy location.
- We provide a Scheduled Maintenance Guide which makes tracking routine service easy.

If your vehicle requires professional service, your dealership can provide necessary parts and service. Check your “Warranty Guide” to find out which parts and services are covered.

Use only recommended fuels, lubricants, fluids and service parts conforming to specifications. Motorcraft parts are designed and built to provide the best performance in your vehicle.

PRECAUTIONS WHEN SERVICING YOUR VEHICLE

Be especially careful when inspecting or servicing your vehicle.

- Do not work on a hot engine.
- When the engine is running, make sure that loose clothing, jewelry or long hair does not get caught up in moving parts.
- Do not work on a vehicle with the engine running in an enclosed space, unless you are sure you have enough ventilation.
- Keep all lit cigarettes, open flames and other lit material away from the battery and all fuel related parts.

If you disconnect the battery, the engine must “relearn” its idle conditions before your vehicle will drive properly, as explained in *Battery* in this chapter.

Working with the engine off

- Automatic transmission:
 1. Set the parking brake and ensure the gearshift is securely latched in P (Park).
 2. Turn off the engine and remove the key.
 3. Block the wheels to prevent the vehicle from moving unexpectedly.
- Manual transmission:
 1. Set the parking brake.
 2. Depress the clutch and place the gearshift in 1 (First).

Maintenance and care

3. Turn off the engine and remove the key.
4. Block the wheels to prevent the vehicle from moving unexpectedly.

Working with the engine on

- Automatic transmission:

1. Set the parking brake and ensure the gearshift is securely latched in P (Park).
2. Block the wheels to prevent the vehicle from moving unexpectedly.



Do not start your engine with the air cleaner removed and do not remove it while the engine is running.

- Manual transmission:

1. Set the parking brake, depress the clutch and place the gearshift in N (Neutral).
2. Block the wheels to prevent the vehicle from moving unexpectedly.



Do not start your engine with the air cleaner removed and do not remove it while the engine is running.

OPENING THE HOOD

1. Inside the vehicle, pull the hood release handle located under the bottom of the instrument panel.
2. Go to the front of the vehicle and release the auxiliary latch that is located under the front center of the hood.
3. Lift the hood and support it with the prop rod.

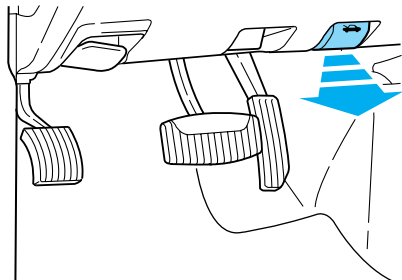

Maintenance and care

IDENTIFYING COMPONENTS IN THE ENGINE COMPARTMENT

2.5L I4 engine

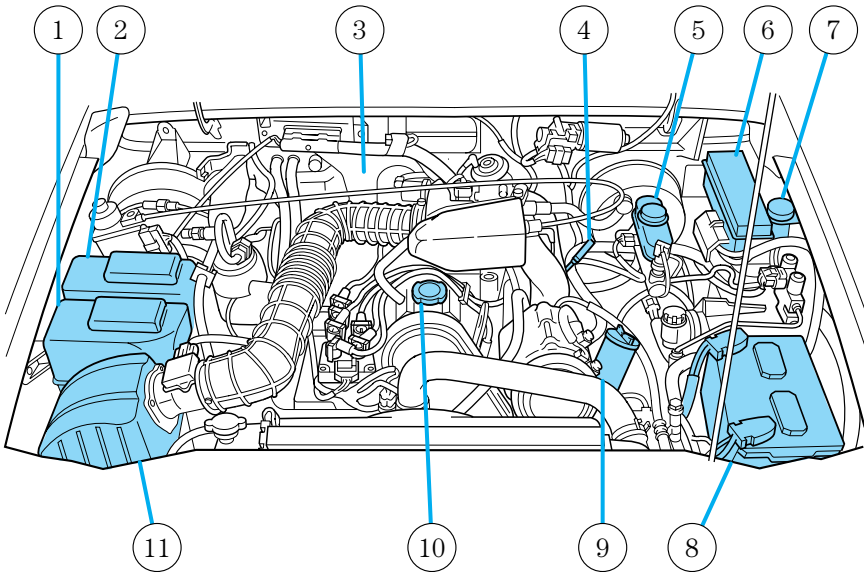

1. Engine coolant reservoir
2. Windshield washer fluid reservoir
3. Transmission fluid dipstick (automatic transmission)
4. Engine oil dipstick
5. Brake fluid reservoir
6. Power distribution box
7. Clutch fluid reservoir (manual transmission)
8. Battery
9. Power steering fluid reservoir
10. Engine oil filler cap
11. Air filter assembly

Maintenance and care

3.0L V6 engine

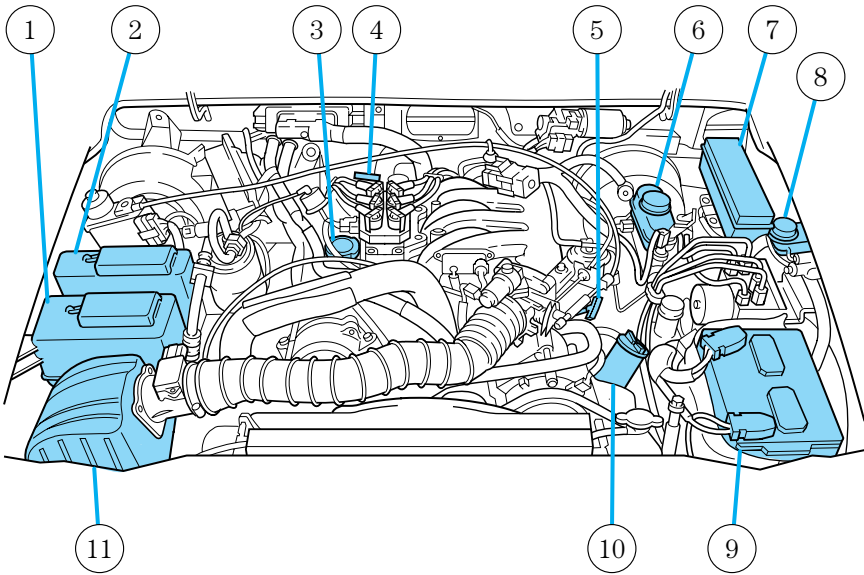

1. Engine coolant reservoir
2. Windshield washer fluid reservoir
3. Engine oil filler cap
4. Transmission fluid dipstick (automatic transmission)
5. Engine oil dipstick
6. Brake fluid reservoir
7. Power distribution box
8. Clutch fluid reservoir
9. Battery
10. Power steering fluid reservoir
11. Air filter assembly

Maintenance and care

4.0L OHV V6 engine

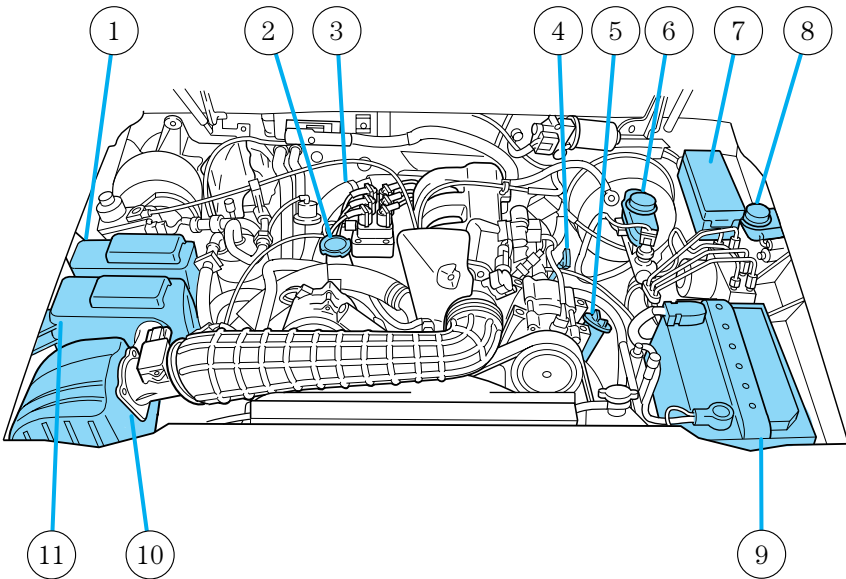

1. Windshield washer fluid reservoir
2. Engine oil filler cap
3. Transmission fluid dipstick (automatic transmission)
4. Engine oil dipstick
5. Power steering fluid reservoir
6. Brake fluid reservoir
7. Power distribution box
8. Clutch fluid reservoir (manual transmission)
9. Battery
10. Air filter assembly
11. Engine coolant reservoir

Maintenance and care

ENGINE OIL

Checking the engine oil

Refer to the Scheduled Maintenance Guide for the appropriate intervals for checking the engine oil.

1. Make sure the vehicle is on level ground.
2. Turn the engine off and wait a few minutes for the oil to drain into the oil pan.
3. Set the parking brake and ensure the gearshift is securely latched in P (Park) (automatic transmissions) or 1 (First) (manual transmissions).
4. Open the hood. Protect yourself from engine heat.
5. Locate and carefully remove the engine oil level indicator (dipstick).

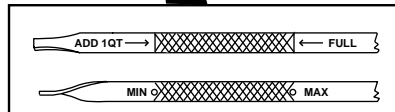
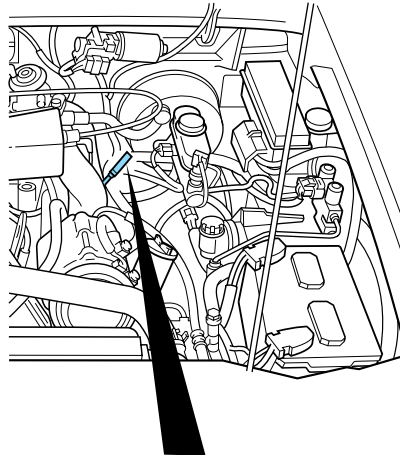

6. Wipe the indicator clean. Insert the indicator fully, then remove it again.
- If the oil level is **between the ADD and FULL marks** or **between the MIN and MAX marks (depending on application)**, the oil level is acceptable. **DO NOT ADD OIL.**

Maintenance and care

- If the oil level is below the ADD mark or MIN mark, add enough oil to raise the level within the ADD-FULL range or MIN-MAX range.

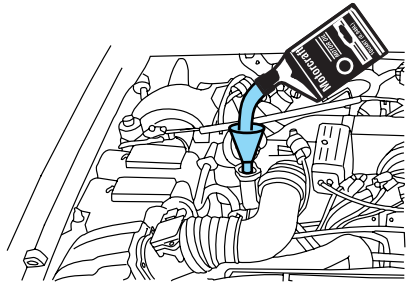

- Oil levels above the letter F in FULL or the MAX mark may cause engine damage. Some oil must be removed from the engine by a service technician.
7. Put the indicator back in and ensure it is fully seated.

Adding engine oil

1. Check the engine oil. For instructions, refer to *Checking the engine oil* in this chapter.
2. If the engine oil level is not within the normal range, add only certified engine oil of the recommended viscosity. Remove the engine oil filler cap and use a funnel to pour the engine oil into the opening.
3. Recheck the engine oil level. Make sure the oil level is not above the MAX mark or the letter F in FULL on the engine oil level indicator (dipstick).
4. Install the indicator and ensure it is fully seated.
5. Fully install the engine oil filler cap by turning the filler cap clockwise until three clicks can be heard.

To avoid possible oil loss, DO NOT operate the vehicle with the engine oil level indicator and/or the engine oil filler cap removed.

Maintenance and care

Engine oil and filter recommendations

Look for this certification trademark.

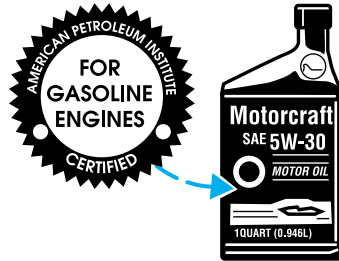

Use SAE 5W-30 motor oil certified for gasoline engines by the American Petroleum Institute (API).

Motor oil displaying the API certification trademark will meet all requirements for your vehicle's engine.

Ford oil specification is WSS-M2C153-G.

Do not use supplemental engine oil additives, oil treatments or engine treatments. They are unnecessary and could, under certain conditions, lead to engine damage which is not covered by your warranty.

Change your engine oil and filter according to the appropriate schedule listed in the Scheduled Maintenance Guide.

Ford production and aftermarket (Motorcraft) oil filters are designed for added engine protection and long life. If a replacement oil filter is used that does not meet Ford material and design specifications, start-up engine noises or knock may be experienced.

It is recommended you use the appropriate Motorcraft oil filter (or another brand meeting Ford specifications) for your engine application.

Maintenance and care

BRAKE FLUID (⚠)

Checking and adding brake fluid

Brake fluid should be checked and refilled as needed. Refer to the Scheduled Maintenance Guide for the service interval schedules.

1. Clean the reservoir cap before removal to prevent dirt or water from entering the reservoir.

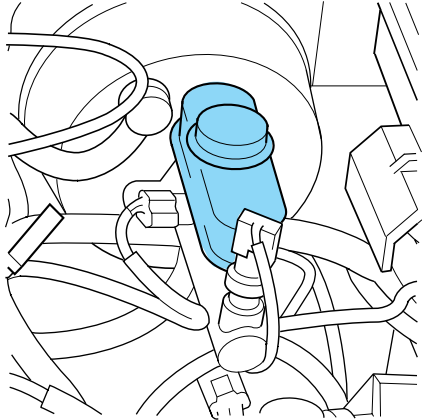

2. Visually inspect the fluid level.

3. If necessary, add brake fluid from a clean un-opened container until the level reaches MAX. Do not fill above this line.

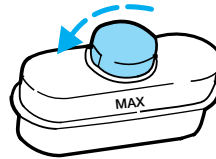

4. Use only a DOT 3 brake fluid certified to meet Ford specifications. Refer to *Lubricant specifications* in the *Capacities and specifications* chapter.



Brake fluid is toxic. If brake fluid contacts the eyes, flush eyes with running water for 15 minutes. Seek medical attention if irritation persists. If taken internally, drink water and induce vomiting. Seek medical attention immediately.



If you use a brake fluid that is not DOT 3, you will cause permanent damage to your brakes.



Do not let the reservoir for the master cylinder run dry. This may cause the brakes to fail.

Maintenance and care

CLUTCH FLUID (IF EQUIPPED)

Check the clutch fluid level. Refer to the Scheduled Maintenance Guide for the service interval schedules.

During normal operation, the fluid level in the clutch reservoir should remain constant. If the fluid level drops, refill the fluid level to the step in the reservoir.

Use only a DOT 3 brake fluid designed to meet Ford specifications. Refer to *Capacities and specifications*.



Brake fluid is toxic. If brake fluid contacts the eyes, flush eyes with running water for 15 minutes. Seek medical if irritation persists. If taken internally, drink water and induce vomiting. Seek medical attention immediately.

1. Clean the reservoir cap before removal to prevent dirt and water from entering the reservoir.
2. Remove cap and rubber diaphragm from reservoir.
3. Add fluid until the level reaches the step in the reservoir.
4. Reinstall rubber diaphragm and cap onto reservoir.

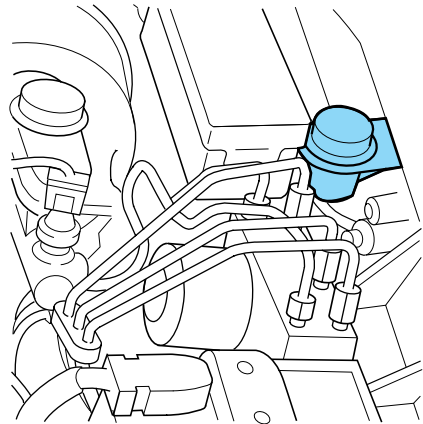

Maintenance and care

WINDSHIELD WASHER FLUID

Checking and adding washer fluid

Check the washer fluid whenever you stop for fuel. The reservoir is highlighted with a  symbol.

If the level is low, add enough fluid to fill the reservoir. In very cold weather, do not fill the reservoir all the way.

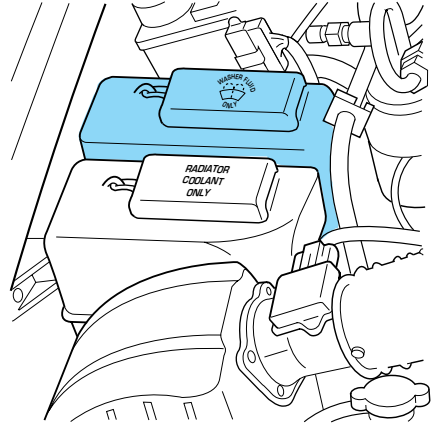

Only use a washer fluid that meets Ford specifications. Refer to *Lubricant specifications* in the *Capacities and specifications* chapter.

State or local regulations on volatile organic compounds may restrict the use of methanol, a common windshield washer antifreeze additive. Washer fluids containing non-methanol antifreeze agents should be used only if they provide cold weather protection without damaging the vehicle's paint finish, wiper blades or washer system.



Do not put washer fluid in the engine coolant reservoir. Washer fluid placed in the cooling system may harm engine and cooling system components.

ENGINE COOLANT

Checking engine coolant

Your engine's cooling system has been factory-filled with a 50/50 mixture of distilled water and Ford Premium Engine Coolant E2FZ-19549-AA (in Canada, Motorcraft CXC-10), or an equivalent premium engine coolant that meets Ford specification ESE-M97B44-A.

Maintenance and care

A **50/50 mixture** of distilled water and Ford Premium Engine Coolant provides:

- **maximum cooling system efficiency.**
- **freeze protection down to -36° C (-34° F).**
- **boiling protection up to 129° C (265° F).**
- **protection against rust and other forms of corrosion.**
- **an accurate temperature readout from the engine coolant gauge.**

The engine coolant must be maintained at the correct fluid level and concentration to work properly. If the engine coolant fluid level and concentration is not maintained correctly, damage to the engine and cooling system may result.

When the engine is cold, check the level of the engine coolant in the reservoir.

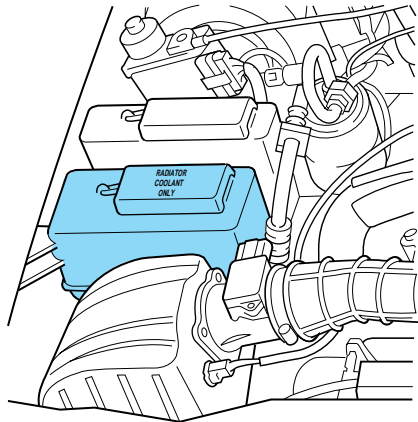

- The engine coolant should be at the “cold fill level” or within the “cold fill range” as listed on the engine coolant reservoir (depending upon application).
- Refer to the Scheduled Maintenance Guide for service interval schedules.
- Be sure to read and understand *Precautions when servicing your vehicle* in this chapter.

If the engine coolant has not been checked at the recommended interval, the engine coolant reservoir may become low or empty. If the reservoir is low or empty, add engine coolant to the reservoir. Refer to *Adding engine coolant* in this chapter.

Maintenance and care



Automotive fluids are not interchangeable; do not use engine coolant, antifreeze or windshield washer fluid outside of its specified function and vehicle location.

Adding engine coolant

Use only **Ford Premium Engine Coolant E2FZ-19549-AA** (in Canada, Motorcraft CXC-10) or a premium engine coolant that meets Ford specification ESE-M97B44-A.

- **DO NOT USE Ford Extended Life Engine Coolant F6AZ-19544-AA (orange in color).**
- **DO NOT USE a DEX-COOL® engine coolant or an equivalent engine coolant that meets Ford specification WSS-M97B44-D.**
- **DO NOT USE alcohol or methanol antifreeze or any engine coolants mixed with alcohol or methanol antifreeze.**
- **DO NOT USE supplemental coolant additives in your vehicle. These additives may harm your engine's cooling system.**
- **DO NOT MIX recycled coolant and conventional coolant together in your vehicle. Mixing of engine coolants may harm your engine's cooling system.**
- **The use of an improper coolant may harm engine and cooling system components and may void the warranty of your vehicle's engine cooling system. If you are unsure which type of coolant your vehicle requires, contact your local dealer.**



Do not put engine coolant in the windshield washer fluid reservoir. If engine coolant is sprayed onto the windshield, it could make it difficult to see through the windshield.

When the engine is cool, add a **50/50 mixture** of engine coolant and distilled water to the engine coolant reservoir, until the coolant is at the “cold fill level” or within the “ cold fill range” as listed in the engine coolant reservoir (depending upon application).

- **NEVER increase the coolant concentration above 60%.**
- **NEVER decrease the coolant concentration below 40%.**
- **Engine coolant concentrations above 60% or below 40% will decrease the freeze protection characteristics of the engine coolant and may cause engine damage.**

Maintenance and care

Plain water may be added in an emergency, but you **must** replace it with a 50/50 mixture of engine coolant and distilled water as soon as possible.

Check the coolant level in the reservoir before you drive your vehicle the next few times (with the engine cool). If necessary, add a **50/50 mixture** of engine coolant and distilled water to the engine coolant reservoir until the coolant level is at the “cold fill level” or within the “cold fill range” as listed on the reservoir (depending upon application).

Have your dealer check the engine cooling system for leaks if you have to add more than 1.0 liter (1.0 quart) of engine coolant per month.



To avoid scalding hot steam or coolant from being released from the engine cooling system, never remove the radiator cap while the engine is running or hot. Failure to follow this warning may result in damage to the engine's cooling system and possible severe personal injury.

If you must remove the radiator cap, follow these steps to avoid personal injury:

1. Before you remove the cap, turn the engine off and let it cool.
2. When the engine is cool, wrap a thick cloth around the cap. Slowly turn cap counterclockwise until pressure begins to release.
3. Step back while the pressure releases.
4. When you are sure that all the pressure has been released, use the cloth to turn it counterclockwise and remove the cap.

Recycled engine coolant

Ford Motor Company recommends the use of a recycled engine coolant produced by Ford-approved processes.

Not all coolant recycling processes produce coolant which meets Ford specification ESE-M97B44-A. Use of a recycled engine coolant which does not meet the Ford specification may harm engine and cooling system components.



Always dispose of used automotive fluids in a responsible manner. Follow your community's regulations and standards for recycling and disposing of automotive fluids.

Maintenance and care

Coolant refill capacity

To find out how much fluid your vehicle's cooling system can hold, refer to *Refill capacities* in the *Capacities and specifications* chapter.

Fill your engine coolant reservoir as outlined in *Adding engine coolant* in this chapter.

Severe climates

If you drive in extremely cold climates (less than -36°C [-34°F]):

- **it may be necessary to increase the coolant concentration above 50%.**
- **NEVER increase the coolant concentration above 60%.**
- **increased engine coolant concentrations above 60% will decrease the overheat protection characteristics of the engine coolant and may cause engine damage.**
- **refer to the chart on the coolant container to ensure the coolant concentration in your vehicle will provide adequate freeze protection at the temperatures in which you drive in the winter months.**

If you drive in extremely hot climates:

- **it is still necessary to maintain the coolant concentration above 40%.**
- **NEVER decrease the coolant concentration below 40%.**
- **decreased engine coolant concentrations below 40% will decrease the corrosion protection characteristics of the engine coolant and may cause engine damage.**
- **decreased engine coolant concentrations below 40% will decrease the freeze protection characteristics of the engine coolant and may cause engine damage.**
- **refer to the chart on the coolant container to ensure the coolant concentration in your vehicle will provide adequate protection at the temperatures in which you drive.**

Vehicles driven year-round in non-extreme climates should use a 50/50 mixture of engine coolant and distilled water for optimum cooling system and engine protection.

Maintenance and care

CHECKING AND ADDING POWER STEERING FLUID

Check the power steering fluid. Refer to the Scheduled Maintenance Guide for the service interval schedules. If adding fluid is necessary, use only MERCON® ATF.

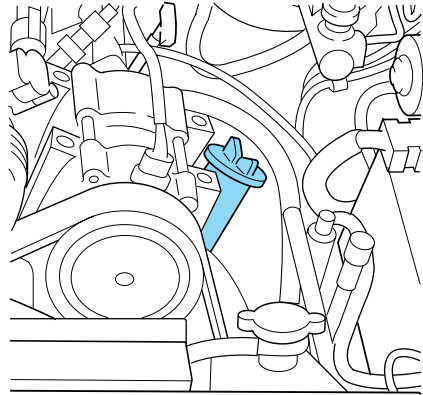

1. Start the engine and let it run until it reaches normal operating temperature (the engine coolant temperature gauge indicator will be near the center of the normal area between H and C).
2. While the engine idles, turn the steering wheel left and right several times.
3. Turn the engine off.
4. Check the fluid level on the dipstick. It should be between the arrows in the FULL HOT range. Do not add fluid if the level is within this range.
5. If the fluid is low, add fluid in small amounts, continuously checking the level until it reaches the FULL HOT range. Be sure to put the dipstick back in the reservoir.

TRANSMISSION FLUID

Checking automatic transmission fluid

Refer to your Scheduled Maintenance Guide for scheduled intervals for fluid checks and changes. Your transmission does not consume fluid. However, the fluid level should be checked if the transmission is not working properly, i.e., if the transmission slips or shifts slowly or if you notice some sign of fluid leakage.

Automatic transmission fluid expands when warmed. To obtain an accurate fluid check, drive the vehicle until it is at normal operating temperature (approximately 30 km [20 miles]). If your vehicle has been

Maintenance and care

operated for an extended period at high speeds, in city traffic during hot weather or pulling a trailer, the vehicle should be turned off for about 30 minutes to allow fluid to cool before checking.

1. Drive the vehicle 30 km (20 miles) or until it reaches normal operating temperature.
2. Park the vehicle on a level surface and engage the parking brake.
3. With the parking brake engaged and your foot on the brake pedal, start the engine and move the gearshift lever through all of the gear ranges. Allow sufficient time for each gear to engage.
4. Latch the gearshift lever in P (Park) and leave the engine running.
5. Remove the dipstick, wiping it clean with a clean, dry lint free rag. If necessary, refer to *Identifying components in the engine compartment* in this chapter for the location of the dipstick.
6. Install the dipstick making sure it is fully seated in the filler tube.
7. Remove the dipstick and inspect the fluid level. The fluid should be in the designated area for normal operating temperature or ambient temperature.

Low fluid level

Do not drive the vehicle if the fluid level is at the bottom of the dipstick and the ambient temperature is above 10°C (50°F).

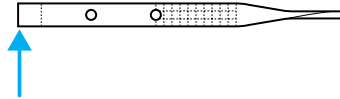

Correct fluid level

The transmission fluid should be checked at normal operating temperature 66°C-77°C (150°F-170°F) on a level surface. The normal operating temperature can be reached after approximately 30 km (20 miles) of driving.

You can check the fluid without driving if the ambient temperature is above 10°C (50°F). However, if fluid is added at this time, an overfill condition could result when the vehicle reaches normal operating temperature.

The transmission fluid should be in this range if at normal operating temperature (66°C-77°C [150°F-170°F]).

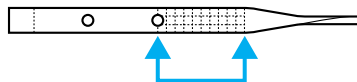

Maintenance and care

The transmission fluid should be in this range if at ambient temperature (10°C-35°C [50°F-95°F]).

High fluid level

Fluid levels above the safe range may result in transmission failure. An overfill condition of transmission fluid may cause shift and/or engagement concerns and/or possible damage.

High fluid levels can be caused by an overheating condition.

Adjusting automatic transmission fluid levels

Before adding any fluid, make sure the correct type is used. The type of fluid used is normally indicated on the dipstick and also in the *Lubricant specifications* section in the *Capacities and specifications* chapter.

Use of a non-approved automatic transmission fluid may cause internal transmission component damage.

If necessary, add fluid in 250 mL (1/2 pint) increments through the filler tube until the level is correct.

If an overfill occurs, excess fluid should be removed by a qualified technician.

An overfill condition of transmission fluid may cause shift and/or engagement concerns and/or possible damage.

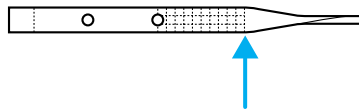
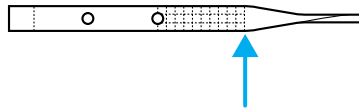
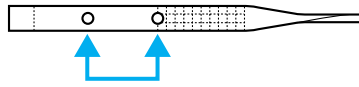

Maintenance and care

Checking and adding manual transmission fluid

1. Clean the filler plug.
2. Remove the filler plug and inspect the fluid level.

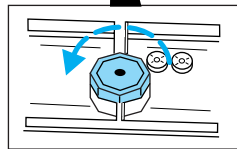
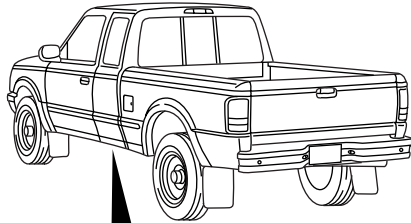

3. Fluid level should be at bottom of the opening.
4. Add enough fluid through the filler opening so that the fluid level is at the bottom of the opening.
5. Install and tighten the fill plug securely.

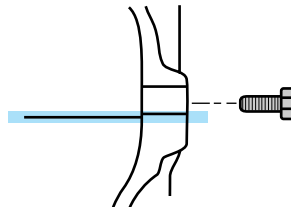

Use only fluid that meets Ford specifications. Refer to the *Capacities and specifications* chapter.

Maintenance and care

Checking and adding transfer case fluid (if equipped)

1. Clean the filler plug.
2. Remove the filler plug and inspect the fluid level.

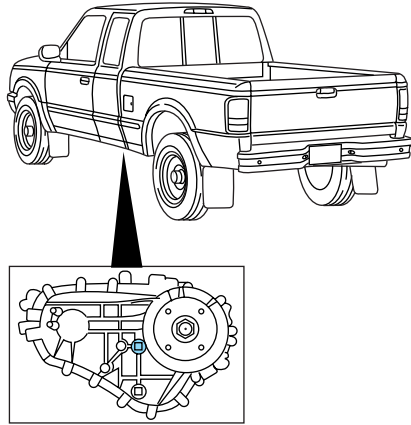

3. Add only enough fluid through the filler opening so that the fluid level is at the bottom of the opening.

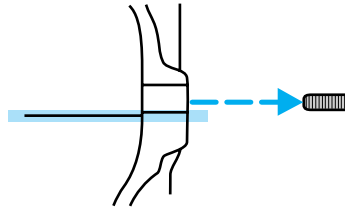

Use only fluid that meets Ford specifications. Refer to the *Capacities and specifications* chapter.

DRIVELINE UNIVERSAL JOINT AND SLIP YOKE

Your vehicle may be equipped with universal joints that require lubrication. Refer to the Scheduled Maintenance Guide for maintenance intervals. If the original universal joints are replaced with universal joints equipped with grease fittings, lubrication will also be necessary.

Maintenance and care

BATTERY

Your vehicle is equipped with a Motorcraft maintenance-free battery which normally does not require additional water during its life of service.

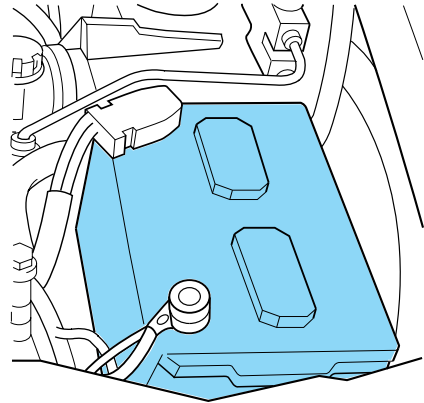

However, for severe usage or in high temperature climates, check the battery electrolyte level. Refer to the Scheduled Maintenance Guide for the service interval schedules.

Keep the electrolyte level in each cell up to the “level indicator”. Do not overfill the battery cells.

If the electrolyte level in the battery is low, you can add plain tap water to the battery, as long as you do not use hard water (water with a high mineral or alkali content). If possible, however, try to only fill the battery cells with distilled water. If the battery needs water often, have the charging system checked.

If your battery has a cover/shield, make sure it is reinstalled after the battery has been cleaned or replaced.

For longer, trouble-free operation, keep the top of the battery clean and dry. Also, make certain the battery cables are always tightly fastened to the battery terminals.

If you see any corrosion on the battery or terminals, remove the cables from the terminals and clean with a wire brush. You can neutralize the acid with a solution of baking soda and water.

Maintenance and care



Batteries normally produce explosive gases which can cause personal injury. Therefore, do not allow flames, sparks or lighted substances to come near the battery. When working near the battery, always shield your face and protect your eyes. Always provide proper ventilation.



When lifting a plastic-cased battery, excessive pressure on the end walls could cause acid to flow through the vent caps, resulting in personal injury and/or damage to the vehicle or battery. Lift the battery with a battery carrier or with your hands on opposite corners.



Keep batteries out of reach of children. Batteries contain sulfuric acid. Avoid contact with skin, eyes or clothing. Shield your eyes when working near the battery to protect against possible splashing of acid solution. In case of acid contact with skin or eyes, flush immediately with water for a minimum of 15 minutes and get prompt medical attention. If acid is swallowed, call a physician immediately.

Because your vehicle's engine is electronically controlled by a computer, some control conditions are maintained by power from the battery. When the battery is disconnected or a new battery is installed, the engine must relearn its idle and fuel trim strategy for optimum driveability and performance. To begin this process:

1. With the vehicle at a complete stop, set the parking brake.
 2. Put the gearshift in P (Park) (automatic transmission) or the neutral position (manual transmission), turn off all accessories and start the engine.
 3. Run the engine until it reaches normal operating temperature.
 4. Allow the engine to idle for at least one minute.
 5. Turn the A/C on and allow the engine to idle for at least one minute.
 6. Drive the vehicle to complete the relearning process.
- The vehicle may need to be driven 16 km (10 miles) or more to relearn the idle and fuel trim strategy.

Maintenance and care

- **If you do not allow the engine to relearn its idle trim, the idle quality of your vehicle may be adversely affected until the idle trim is eventually relearned.**

If the battery has been disconnected or a new battery has been installed, the clock and the preset radio stations must be reset once the battery is reconnected.

- Always dispose of automotive batteries in a responsible manner. Follow your local authorized standards for disposal. Call your local authorized recycling center to find out more about recycling automotive batteries.

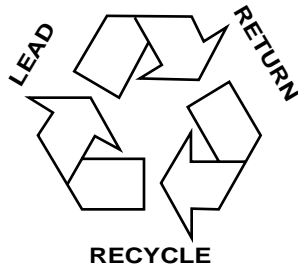

WINDSHIELD WIPER BLADES

Check the wiper blades at least twice a year or when they seem less effective. Substances such as tree sap and some hot wax treatments used by commercial car washes reduce the effectiveness of wiper blades.

Checking the wiper blades

If the wiper blades do not wipe properly, clean both the windshield and wiper blades using undiluted windshield wiper solution or a mild detergent. Rinse thoroughly with clean water. To avoid damaging the blades, do not use fuel, kerosene, paint thinner or other solvents.

Maintenance and care

Changing the wiper blades

To replace the wiper blades:

1. Pull the wiper arm away from the windshield and lock into the service position.
2. Turn the blade at an angle from the wiper arm. Push the lock pin manually to release the blade and pull the wiper blade down toward the windshield to remove it from the arm.
3. Attach the new wiper to the wiper arm and press it into place until a click is heard.

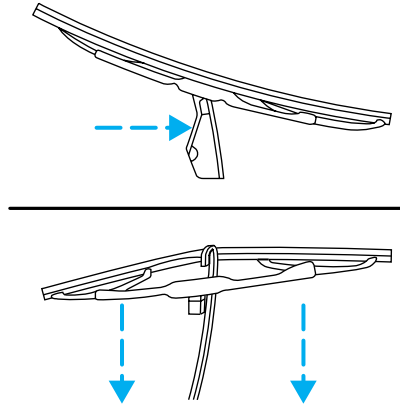

INFORMATION ABOUT UNIFORM TIRE QUALITY GRADING

New vehicles are fitted with tires that have a rating on them called Tire Quality Grades. The Quality grades can be found where applicable on the tire sidewall between tread shoulder and maximum section width. For example:

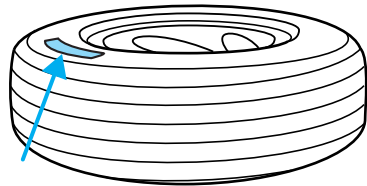

• Treadwear 200 Traction AA Temperature A

These Tire Quality Grades are determined by standards that the United States Department of Transportation has set.

Tire Quality Grades apply to new pneumatic tires for use on passenger cars. They do not apply to deep tread, winter-type snow tires, space-saver or temporary use spare tires, tires with nominal rim diameters of 10 to 12 inches or limited production tires as defined in Title 49 Code of Federal Regulations Part 575.104(c)(2).

U.S. Department of Transportation-Tire quality grades: The U.S. Department of Transportation requires Ford to give you the following information about tire grades exactly as the government has written it.

Maintenance and care

Treadwear

The treadwear grade is a comparative rating based on the wear rate of the tire when tested under controlled conditions on a specified government test course. For example, a tire graded 150 would wear one and one-half (1 1/2) times as well on the government course as a tire graded 100. The relative performance of tires depends upon the actual conditions of their use, however, and may depart significantly from the norm due to variations in driving habits, service practices, and differences in road characteristics and climate.

Traction AA A B C

The traction grades, from highest to lowest are AA, A, B, and C. Those grades represent the tire's ability to stop on wet pavement as measured under controlled conditions on specified government test surfaces of asphalt and concrete. A tire marked C may have poor traction performance.



The traction grade assigned to this tire is based on straight-ahead braking traction tests, and does not include acceleration, cornering, hydroplaning or peak traction characteristics.

Temperature A B C

The temperature grades are A (the highest), B, and C, representing the tire's resistance to the generation of heat and its ability to dissipate heat when tested under controlled conditions on a specified indoor laboratory test wheel. Sustained high temperature can cause the material of the tire to degenerate and reduce tire life, and excessive temperature can lead to sudden tire failure. The grade C corresponds to a level of performance which all passenger car tires must meet under the Federal Motor Vehicle Safety Standard No. 109. Grades B and A represent higher levels of performance on the laboratory test wheel than the minimum required by law.



The temperature grade for this tire is established for a tire that is properly inflated and not overloaded. Excessive speed, underinflation, or excessive loading, either separately or in combination, can cause heat buildup and possible tire failure.

Maintenance and care

SERVICING YOUR TIRES

Checking the tire pressure

- Use an accurate tire pressure gauge.
- Check the tire pressure when tires are cold, after the vehicle has been parked for at least one hour or has been driven less than 5 km (3 miles).
- Adjust tire pressure to recommended specifications found on the Certification Label.



Improperly inflated tires can affect vehicle handling and can fail suddenly, possibly resulting in loss of vehicle control.

Tire rotation

Because your vehicle's tires perform different jobs, they often wear differently. To make sure your tires wear evenly and last longer, rotate them as indicated in the Scheduled Maintenance Guide. If you notice that the tires wear unevenly, have them checked.

The following procedure applies to vehicles equipped with single rear wheels, if your vehicle is equipped with dual rear wheels it is recommended that only the front wheels be rotated (side to side).

- Four tire rotation

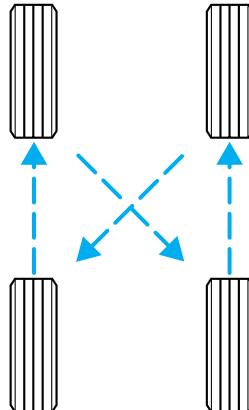

Maintenance and care

- Five tire rotation

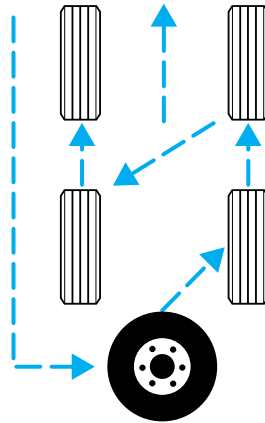

Replacing the tires

Replace the tires when the wear band is visible through the tire treads.

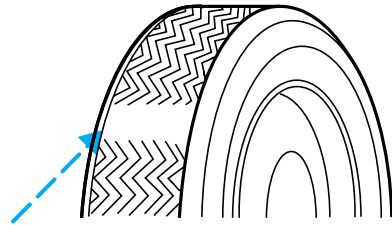

When replacing full size tires, never mix radial bias-belted, or bias-type tires. Use only the tire sizes that are listed on the Certification Label. Make sure that all tires are the same size, speed rating, and load-carrying capacity. Use only the tire combinations recommended on the label. If you do not follow these precautions, your vehicle may not drive properly and safely.



Make sure that all replacement tires are of the same size, type, load-carrying capacity and tread design (e.g., "All Terrain", etc.), as originally offered by Ford.

Maintenance and care



Do not replace your tires with “high performance” tires or larger size tires.



Failure to follow these precautions may adversely affect the handling of the vehicle and make it easier for the driver to lose control and roll over.

Tires that are larger or smaller than your vehicle’s original tires may also affect the accuracy of your speedometer.

SNOW TIRES AND CHAINS



Driving too fast for conditions creates the possibility of loss of vehicle control. Driving at very high speeds for extended periods of time may result in damage to vehicle components.



Snow tires must be the same size and grade as the tires you currently have on your vehicle.

The tires on your vehicle have all weather treads to provide traction in rain and snow. However, in some climates, you may need to use snow tires and chains. If you need to use snow tires and chains, it is recommended that steel wheels are used of the same size and specifications as those originally installed.

Follow these guidelines when using snow tires and chains:

- Do not use tire chains on aluminum wheels. Chains may chip the wheels.
- Use only SAE Class S chains.
- Install chains securely, verifying that the chains do not touch any wiring, brake lines or fuel lines.
- Drive cautiously. If you hear the chains rub or bang against your vehicle, stop and re-tighten the chains. If this does not work, remove the chains to prevent damage to your vehicle.
- If possible, avoid fully loading your vehicle.
- Remove the tire chains when they are no longer needed. Do not use tire chains on dry roads.

Maintenance and care

- The suspension insulation and bumpers will help prevent vehicle damage. Do not remove these components from your vehicle when using snow tires and chains.

WHAT YOU SHOULD KNOW ABOUT AUTOMOTIVE FUELS

Important safety precautions



Do not overfill the fuel tank. The pressure in an overfilled tank may cause leakage and lead to fuel spray and fire.



The fuel system may be under pressure. If the fuel filler cap is venting vapor or if you hear a hissing sound, wait until it stops before completely removing the fuel filler cap. Otherwise, fuel may spray out and injure you or others.



If you do not use the proper fuel filler cap, excessive pressure or vacuum in the fuel tank may damage the fuel system or cause the fuel system to work improperly in a collision, which may result in possible personal injury.



Automotive fuels can cause serious injury or death if misused or mishandled.



Fuel ethanol and gasoline may contain benzene, which is a cancer-causing agent.

Observe the following guidelines when handling automotive fuel:

- Extinguish all smoking materials and any open flames before fueling your vehicle.
- Always turn off the vehicle before fueling.
- Automotive fuels can be harmful or fatal if swallowed. Fuels such as gasoline and ethanol are highly toxic and if swallowed can cause



Maintenance and care

death or permanent injury. If fuel is swallowed, call a physician immediately, even if no symptoms are immediately apparent. The toxic effects of fuel may not be visible for hours.

- Avoid inhaling fuel vapors. Inhaling too much fuel vapor of any kind can lead to eye and respiratory tract irritation. In severe cases, excessive or prolonged breathing of fuel vapor can cause serious illness and permanent injury.
- Avoid getting fuel liquid in your eyes. If fuel is splashed in the eyes, remove contact lenses (if worn), flush with water for 15 minutes and seek medical attention. Failure to seek proper medical attention could lead to permanent injury.
- Fuels can also be harmful if absorbed through the skin. If fuel is splashed on the skin and/or clothing, promptly remove contaminated clothing and wash skin thoroughly with soap and water. Repeated or prolonged skin contact with fuel liquid or vapor causes skin irritation.
- Be particularly careful if you are taking “Antabuse” or other forms of disulfiram for the treatment of alcoholism. Breathing gasoline and/or ethanol vapors, or skin contact could cause an adverse reaction. In sensitive individuals, serious personal injury or sickness may result. If fuel is splashed on the skin, promptly wash skin thoroughly with soap and water. Consult a physician immediately if you experience an adverse reaction.
- FFV fuel tanks may contain zero to 85 percent or more of ethanol. Any fuel blends containing gasoline and ethanol should be treated the same as “Fuel Ethanol (E85)”.

Pure ethanol is the alcohol which is the intoxicating agent in liquor, beer and wine. It is distilled from the fermentation of plants such as field corn and sugar cane. When ethanol is used in the making of motor fuels, a small amount of a bad tasting chemical is added to discourage beverage use. The resulting fuel is called E_d 100 meaning 100% pure ethanol diluted by 2% to 5% gasoline as the “denaturant.”

Fuel ethanol (E_d 85) is then made by adding 15% more unleaded gasoline. The resulting fuel also has a higher octane rating than unleaded regular gasoline and other properties which allow engine designs with greater efficiency and power.

Winter blends may contain up to 30% unleaded gasoline (25% plus the denaturant) to enhance cold engine starts. Severely cold weather may require additional measures for reliable starting. Refer to *Cold Weather Starting* in the *Starting* chapter.

Maintenance and care

Ethanol is more chemically active than gasoline. It corrodes some metals and causes some plastic and rubber components to swell, break down or become brittle and crack, especially when mixed with gasoline. Special materials and procedures have been developed for flexible fuel vehicles and the dispensers used by ethanol fuel providers.



Flexible fuel components and standard unleaded gasoline fuel components are not interchangeable. If your vehicle is not serviced in accordance with flexible fuel vehicles procedures, damage may occur and your warranty may be invalidated.



When refueling always shut the engine off and never allow sparks or open flames near the filler neck. Never smoke while refueling. Fuel vapor is extremely hazardous under certain conditions. Care should be taken to avoid inhaling excess fumes.



The flow of fuel through a fuel pump nozzle can produce static electricity, which can cause a fire if fuel is pumped into an ungrounded fuel container.

Use the following guidelines to avoid static build-up when filling an ungrounded fuel container:

- Place approved fuel container on the ground.
- DO NOT fill a fuel container while it is in the vehicle.
- Keep the fuel pump nozzle in contact with the fuel container while filling.
- DO NOT use a device that would hold the fuel pump handle in the fill position.

Fuel Filler Cap

Your fuel tank filler cap has an indexed design with a 1/8 turn on/off feature.

When fueling your vehicle:

1. Turn the engine off.
2. Carefully turn the filler cap counterclockwise 1/8 of a turn until it stops.

Maintenance and care

3. Pull to remove the cap from the fuel filler pipe.
4. To install the cap, align the tabs on the cap with the notches on the filler pipe.
5. Turn the filler cap clockwise 1/8 of a turn until it stops.

If the “Service Engine Soon/Check Engine” indicator comes on and stays on when you start the engine, the fuel filler cap may not be properly installed. Turn off the engine, remove the fuel filler cap, align the cap properly and reinstall it.

If you must replace the fuel filler cap, replace it with a fuel filler cap that is designed for your vehicle. The customer warranty may be void for any damage to the fuel tank or fuel system if the correct genuine Ford or Motorcraft fuel filler cap is not used.



The fuel system may be under pressure. If the fuel filler cap is venting vapor or if you hear a hissing sound, wait until it stops before completely removing the fuel filler cap. Otherwise, fuel may spray out and injure you or others.



If you do not use the proper fuel filler cap, excessive pressure or vacuum in the fuel tank may damage the fuel system or cause the fuel system to work improperly in a collision, which may result in possible personal injury.

Choosing the right fuel

Use only UNLEADED FUEL. The use of leaded fuel is prohibited by law and could damage your vehicle.

If your vehicle is a flexible fuel vehicle (FFV), use only UNLEADED FUEL and ETHANOL (E85). The use of leaded fuel is prohibited by law and could damage your vehicle.

Do not use fuel containing methanol. It can damage critical fuel system components.

Your vehicle was not designed to use fuel or fuel additives with metallic compounds, including manganese-based compounds containing MMT.

Repairs to correct the effects of using a fuel for which your vehicle was not designed may not be covered by your warranty.

Maintenance and care

Octane recommendations

Do not be concerned if your engine sometimes knocks lightly. However, if it knocks heavily under most driving conditions while you are using fuel with the recommended octane rating, see your dealer or a qualified service technician to prevent any engine damage.

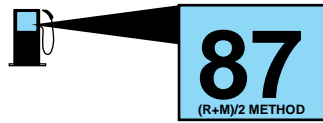

Unleaded Gasoline engines

Your vehicle is designed to use “Regular” unleaded gasoline with an (R+M)/2 octane rating of 87. We do not recommend the use of gasolines labeled as “Regular” that are sold with octane ratings of 86 or lower in high altitude areas.

FFV engine

Your vehicle is designed to use Fuel Ethanol (E85), “Regular” unleaded gasoline or any percentage of the two fuels combined.

U.S. government regulations require fuel ethanol dispensing pumps to have a small, square, orange and black label with the common abbreviation E85 or the appropriate percentage for that region. Use of other fuels such as Fuel Methanol may cause powertrain damage, a loss of vehicle performance, and your warranty may be invalidated.

Fuel quality

Many of the world’s automakers issued the World-wide Fuel Charter that recommends gasoline specifications to provide improved performance and emission control system protection for your vehicle. Gasolines that meet the World-wide Fuel Charter should be used when available. Ask your fuel supplier about gasolines that meet the World-wide Fuel Charter.

It should not be necessary to add any aftermarket products to your fuel tank if you continue to use high quality fuel of the recommended octane rating. Aftermarket products could cause damage to the fuel system. Repairs to correct the effects of using an aftermarket product in your fuel may not be covered by your warranty.

Unleaded Gasoline engines

If you are experiencing starting, rough idle or hesitation driveability problems during a cold start, try a different brand of “Regular” unleaded

Maintenance and care

gasoline. “Premium” unleaded gasoline is not recommended (particularly in the United States) because it may cause these problems to become more pronounced. If the problems persist, see your dealer or a qualified service technician.

FFV engine

Your FFV will operate well on ordinary “Regular” unleaded gasoline, but only the highest quality fuel ethanol will provide the same level of protection and performance.

Standards for fuel ethanol have been developed to provide FFVs the best possible performance, safety and durability. To assist alcohol fuel providers in meeting these standards, guidelines have also been developed which prescribe “Ethanol Fuel Compatible” dispensing station equipment. These standards and guidelines can be obtained from Ford Motor Company. Fuel stations may apply to be certified as meeting these standards. However, not all stations meet these standards at this time. To ensure proper operation of your FFV on fuel ethanol, refuel at certified stations.

If you are experiencing a rough or rolling idle after start-up with the outside temperature above 27° C (80° F), the idle should improve within 10 to 30 seconds. If the problems persist below this temperature, see your dealer or a qualified service technician.

Cleaner air

Ford approves the use of reformulated “cleaner-burning” gasolines to improve air quality. These gasolines may contain oxygenates up to 10% ethanol or 15% MTBE.

Running out of fuel

Avoid running out of fuel because this situation may have an adverse affect on powertrain components.

If you have run out of fuel:

- You may need to cycle the ignition from OFF to ON several times after refueling, to allow the fuel system to pump the fuel from the tank to the engine.
- Your “Check Engine” indicator may come on. For more information on the “Check Engine” indicator, refer to the *Instrumentation* chapter.

Maintenance and care

Fuel Filter

For fuel filter replacement, see your dealer or a qualified service technician. Refer to the Scheduled Maintenance Guide for the appropriate intervals for changing the fuel filter.

Replace the fuel filter with an authorized Motorcraft part. The customer warranty may be void for any damage to the fuel system if an authorized Motorcraft fuel filter is not used.

ESSENTIALS OF GOOD FUEL ECONOMY

Measuring techniques

Your best source of information about actual fuel economy is you, the driver. You must gather information as accurately and consistently as possible. Fuel expense, frequency of fillups or fuel gauge readings are NOT accurate as a measure of fuel economy. We do not recommend taking fuel economy measurements during the first 1 600 km (1 000 miles) of driving (engine break-in period). You will get a more accurate measurement after 3 000 km–5 000 km (2 000 miles–3 000 miles).

Filling the tank

The advertised fuel capacity of the fuel tank on your vehicle is equal to the rated refill capacity of the fuel tank as listed in the *Refill Capacities* section of the *Capacities and specifications* chapter.

The advertised capacity is the amount of the indicated capacity and the empty reserve combined. Indicated capacity is the difference in the amount of fuel in a full tank and a tank when the fuel gauge indicates empty. Empty reserve is the small amount of usable fuel remaining in the fuel tank after the fuel gauge indicates empty.

The amount of empty reserve varies and should not be relied upon to increase driving range. When refueling your vehicle after the fuel gauge indicates empty, you might not be able to refuel the full amount of the advertised capacity of the fuel tank due to the empty reserve still present in the tank.

For consistent results when filling the fuel tank:

- Use the same filling rate setting (low — medium — high) each time the tank is filled.
- Allow three automatic click-offs when filling.
- Always use fuel with the recommended octane rating.

Maintenance and care

- Use a known quality gasoline, preferably a national brand.
- Use the same side of the same pump and have the vehicle facing the same direction each time you fill up.
- Have the vehicle loading and distribution the same every time.

Your results will be most accurate if your filling method is consistent.

Calculating fuel economy

1. Fill the fuel tank completely and record the initial odometer reading (in kilometers or miles).
2. Each time you fill the tank, record the amount of fuel added (in liters or gallons).
3. After at least three to five tank fill-ups, fill the fuel tank and record the current odometer reading.
4. Subtract your initial odometer reading from the current odometer reading.
5. Follow one of the simple calculations in order to determine fuel economy:

Multiply liters used by 100, then divide by total kilometers traveled.

Divide total miles traveled by total gallons used.

Keep a record for at least one month and record the type of driving (city or highway). This will provide an accurate estimate of the vehicle's fuel economy under current driving conditions. Additionally, keeping records during summer and winter will show how temperature impacts fuel economy. In general, lower temperatures give lower fuel economy.

Ethanol has less energy per gallon than gasoline. Fuel economy will decrease as the percentage of ethanol used is increased.

Driving style — good driving and fuel economy habits

Give consideration to the lists that follow and you may be able to change a number of variables and improve your fuel economy.

Habits

- Smooth, moderate operation can yield up to 10% savings in fuel.
- Steady speeds without stopping will usually give the best fuel economy.

Maintenance and care

- Idling for long periods of time (greater than one minute) may waste fuel.
- Anticipate stopping; slowing down may eliminate the need to stop.
- Sudden or hard accelerations may reduce fuel economy.
- Slow down gradually.
- Driving at reasonable speeds (traveling at 88 km/h [55 mph] uses 15% less fuel than traveling at 105 km/h [65 mph]).
- Revving the engine before turning it off may reduce fuel economy.
- Using the air conditioner or defroster may reduce fuel economy.
- You may want to turn off the speed control in hilly terrain if unnecessary shifting between third and fourth gear occurs. Unnecessary shifting of this type could result in reduced fuel economy.
- Warming up a vehicle on cold mornings is not required and may reduce fuel economy.
- Resting your foot on the brake pedal while driving may reduce fuel economy.
- Combine errands and minimize stop-and-go driving.

Maintenance

- Keep tires properly inflated and use only recommended size.
- Operating a vehicle with the wheels out of alignment will reduce fuel economy.
- Use recommended engine oil. Refer to *Lubricant Specifications*.
- Perform all regularly scheduled maintenance items. Follow the recommended maintenance schedule and owner maintenance checks found in your vehicle Scheduled Maintenance Guide.

Conditions

- Heavily loading a vehicle or towing a trailer may reduce fuel economy at any speed.
- Carrying unnecessary weight may reduce fuel economy (approximately 0.4 km/L [1 mpg] is lost for every 180 kg [400 lb] of weight carried).
- Adding certain accessories to your vehicle (for example bug deflectors, rollbars/light bars, running boards, ski/luggage racks) may reduce fuel economy.

Maintenance and care

- Using fuel blended with alcohol may lower fuel economy.
- Fuel economy may decrease with lower temperatures during the first 12–16 km (8–10 miles) of driving.
- Driving on flat terrain offers improved fuel economy as compared to driving on hilly terrain.
- Transmissions give their best fuel economy when operated in the top cruise gear and with steady pressure on the gas pedal.
- Four-wheel-drive operation (if equipped) is less fuel efficient than two-wheel-drive operation.
- Close windows for high speed driving.

EPA window sticker

Every new vehicle should have the EPA window sticker. Contact your dealer if the window sticker is not supplied with your vehicle. The EPA window sticker should be your guide for the fuel economy comparisons with other vehicles.

It is important to note the box in the lower left corner of the window sticker. These numbers represent the Range of L/100 km (MPG) expected on the vehicle under optimum conditions. Your fuel economy may vary depending upon the method of operation and conditions.

EMISSION CONTROL SYSTEM

Your vehicle is equipped with various emission control components and a catalytic converter which will enable your vehicle to comply with applicable exhaust emission standards. To make sure that the catalytic converter and other emission control components continue to work properly:

- Use only unleaded fuel (or E85, if equipped with the 3.0L FFV V6 engine).
- Avoid running out of fuel.
- Do not turn off the ignition while your vehicle is moving, especially at high speeds.
- Have the items listed in your Scheduled Maintenance Guide performed according to the specified schedule.

The scheduled maintenance items listed in the Scheduled Maintenance Guide are essential to the life and performance of your vehicle and to its emissions system.

Maintenance and care

If other than Ford, Motorcraft or Ford-authorized parts are used for maintenance replacements or for service of components affecting emission control, such non-Ford parts should be equivalent to genuine Ford Motor Company parts in performance and durability.



Do not park, idle, or drive your vehicle in dry grass or other dry ground cover. The emission system heats up the engine compartment and exhaust system, which can start a fire.

Illumination of the “Check Engine” light, charging system warning light or the temperature warning light, fluid leaks, strange odors, smoke or loss of engine power, could indicate that the emission control system is not working properly.



Exhaust leaks may result in entry of harmful and potentially lethal fumes into the passenger compartment.

Do not make any unauthorized changes to your vehicle or engine. By law, vehicle owners and anyone who manufactures, repairs, services, sells, leases, trades vehicles, or supervises a fleet of vehicles are not permitted to intentionally remove an emission control device or prevent it from working. Information about your vehicle’s emission system is on the Vehicle Emission Control Information Decal located on or near the engine. This decal identifies engine displacement and gives some tune up specifications.

Please consult your “Warranty Guide” for complete emission warranty information.

Readiness for Inspection/Maintenance (I/M) testing

In some localities, it may be a legal requirement to pass an I/M test of the on-board diagnostics system. If your “Check Engine/Service Engine Soon” light is on, refer to the description in the *Warning Lights and Chimes* section of the *Instrumentation* chapter. Your vehicle may not pass the I/M test with the “Check Engine/Service Engine Soon” light on.

If the vehicle’s powertrain system or its battery has just been serviced, the on-board diagnostics system is reset to a “not ready for I/M test” condition. To ready the on-board diagnostics system for I/M testing, a minimum of 30 minutes of city and highway driving is necessary as described below:

- First, at least 10 minutes of driving on an expressway or highway.

Maintenance and care

- Next, at least 20 minutes driving in stop-and-go, city-type traffic with at least four idle periods.

Allow the vehicle to sit for at least eight hours without starting the engine. Then, start the engine and complete the above driving cycle. The engine must warm up to its normal operating temperature. Once started, do not turn off the engine until the above driving cycle is complete.

BULBS

Replacing exterior bulbs

Check the operation of the following lamps frequently:

- Headlamps
- Foglamps
- High-mount brakelamp
- Brakelamps
- Turn signals
- License plate lamp
- Tail lamps
- Back-up lamps

Do not remove lamp bulbs unless they can be replaced immediately with new ones. If a bulb is removed for an extended period of time, contaminants may enter the lamp housings and affect lamp performance.

Replacing headlamp bulbs

To remove the headlamp bulb:

1. Make sure headlamp switch is in OFF position.
2. Open the hood.
3. Locate the headlamp bulb through the hole in the upper radiator support assembly.
4. Disconnect the electrical connector from the bulb by pulling rearward.

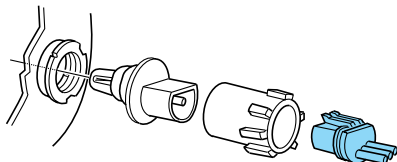

Maintenance and care

5. Remove the bulb retaining ring by rotating it counterclockwise (when viewed from the rear) to free it from the bulb socket, and slide the ring off the plastic base. Keep the ring to retain the new bulb.

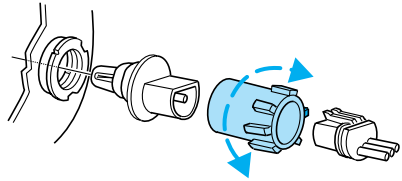

6. Without turning, remove the old bulb by gently pulling it straight back out of the lamp assembly.

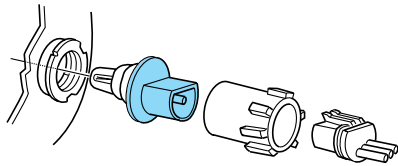

To install the new bulb:



Handle a halogen headlamp bulb carefully and keep out of children's reach. Grasp the bulb only by its plastic base and do not touch the glass. The oil from your hand could cause the bulb to break the next time the headlamps are operated.

1. With the flat side of the bulb's plastic base facing upward, insert the glass end of the bulb into the lamp assembly. You may need to turn the bulb left or right to align the grooves in the plastic base with the tabs in the lamp assembly. When the grooves are aligned, push the bulb into the lamp assembly until the plastic base contacts the rear of the lamp assembly.
2. Install the bulb retaining ring over the plastic base until it contacts the rear of the socket by rotating clockwise until you feel a "stop."
3. Install the electrical connector into the plastic base until it snaps, locking it into position.
4. Turn the headlamps on and make sure they work properly. If the headlamp was correctly aligned before you changed the bulb, you should not need to align it again.

Maintenance and care

Replacing front side marker bulbs

1. Open the hood.
2. Remove two screws from the lamp assembly.
3. Disengage lamp assembly (it has a snap fit).
4. Disconnect the electrical connector from the bulb by pulling rearward.

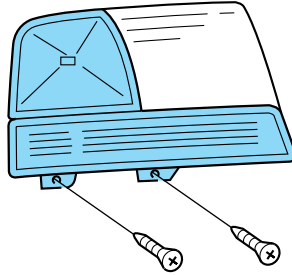

5. Rotate bulb socket counterclockwise about $\frac{1}{4}$ turn and remove from lamp assembly.
6. Carefully pull bulb straight out of socket and push in the new bulb.
7. Insert the bulb into the parking lamp assembly. When the grooves in the plastic base are aligned, push the bulb into the lamp assembly until the plastic base contacts the rear of the lamp assembly and turn to lock.
8. Connect the electrical connector into the rear of the plastic base until it “snaps.”
9. Align the lamp studs with the plastic grommets on the vehicle and push to snap in place.
10. Install two screws on lamp assembly.

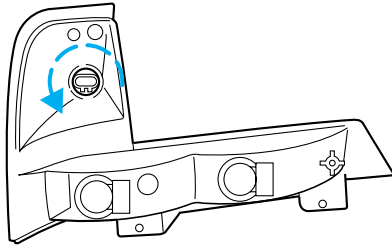

Maintenance and care

Replacing tail lamp/turn/backup lamp bulbs

The tail lamp/turn/backup lamp bulbs are located in the same portion of the tail lamp assembly, one just below the other. Follow the same steps to replace either bulb:

1. Open the liftgate to expose the lamp assemblies.
2. Remove the four screws and the lamp assembly from vehicle.

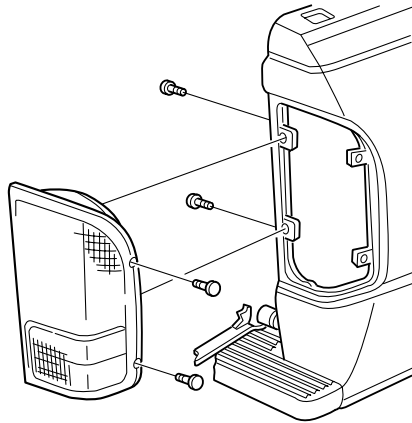

3. Rotate bulb socket counterclockwise turn and remove from lamp assembly.
4. Carefully pull the bulb straight out of the socket and push in the new bulb.
5. Install the bulb socket in lamp assembly by turning clockwise.
6. Install the lamp assembly and secure with four screws.

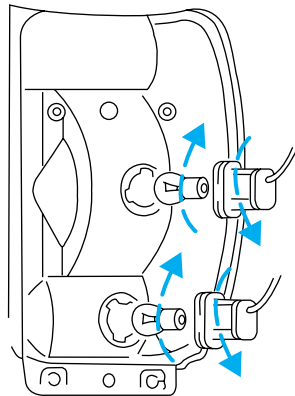

Replacing foglamp bulbs

1. Remove the bulb socket from the foglamp by turning counterclockwise.
2. Disconnect the electrical connector from the foglamp bulb.
3. Connect the electrical connector to the new foglamp bulb.
4. Install the bulb socket in the foglamp turning clockwise.

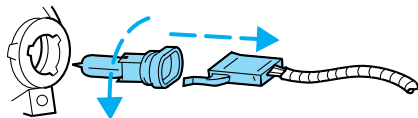

Maintenance and care

Replacing high-mount brakelamp and cargo lamp bulbs

The replacement of the high-mount brakelamp bulb and cargo lamp bulb is basically the same. This procedure covers the high-mount brakelamp bulb.

To remove the brakelamp assembly:

1. Remove the two screws and lamp assembly from vehicle.
2. Remove the bulb socket from lamp assembly by rotating it counterclockwise.
3. Carefully pull bulb straight out of socket and push in the new bulb.

To install the brakelamp assembly:

1. Install the bulb socket into the lamp assembly by rotating clockwise.
2. Install the lamp assembly on the vehicle and secure with two screws.

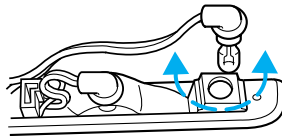
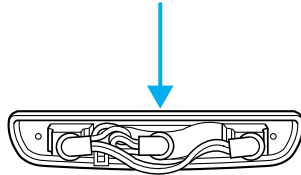

Replacing license plate lamp bulbs

The license plate bulbs are located behind the rear bumper. To change the license plate lamp bulbs:

1. Reach behind the rear bumper to locate the bulb socket.
2. Twist the socket counterclockwise and remove.
3. Pull out the old bulb from socket and push in the new bulb.
4. Install the bulb socket in lamp assembly by turning it clockwise.

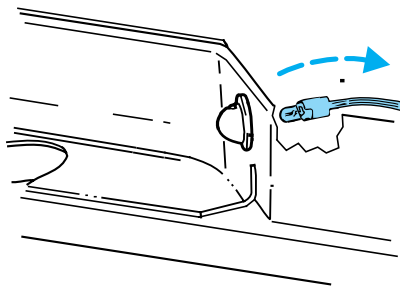

Using the right bulbs

Replacement bulbs are specified in the chart below. Headlamp bulbs must be marked with an authorized "D.O.T." for North America and an "E" for Europe to assure lamp performance, light brightness and pattern and safe visibility. The correct bulbs will not damage the lamp assembly or void the lamp assembly warranty and will provide quality bulb burn time.

Maintenance and care

Function	Number of bulbs	Trade number
Park/turn/side marker lamps (front)	4	3157
	2	194
Headlamps	2	9007
Foglamps (if equipped)	2	9006 HB4
Hi-mount brakelamp	1	922
Cargo lamps	2	906
Rear stop/turn/tail lamps	2	3157
Rear license plate lamps	2	194
Backup lamp	2	3156
Dome lamp	1	912
Map/dome-SuperCab (if equipped)	2	904
Map/dome-Regular Cab (if equipped)	1	904
	1	904
All replacement bulbs are clear in color except where noted.		
To replace all instrument panel lights - see your dealer.		

REPLACING THE INTERIOR BULBS

Check the operation of the following interior bulbs frequently:

- interior overhead lamp
- map lamp

For bulb replacement, see a dealer or qualified technician.

AIMING THE HEADLAMPS

The headlamps on your vehicle are properly aimed at the assembly plant.

If your vehicle has been in an accident the alignment of your headlamps should be checked by a qualified service technician.

CLEANING AND CARING FOR YOUR VEHICLE

Refer to the Customer Assistance chapter for a list of Ford-approved cleaners, polishes and waxes.

Washing your vehicle

Wash your vehicle regularly with cold or lukewarm water. Never use strong detergents or soap. If your vehicle is particularly dirty, use a quality car wash detergent. Always use a clean sponge, washing glove or similar device and plenty of water for best results. To avoid spots, avoid washing when the hood is still warm, immediately after or during exposure to strong sunlight.

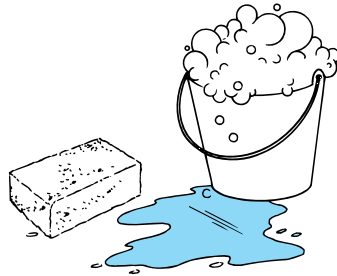

During winter months, it is especially important to wash the vehicle on a regular basis. Large quantities of dirt and road salt are difficult to remove and also cause damage to the vehicle.

Any gasoline spilled on the vehicle or deposits such as bird droppings should be washed and sponged off as soon as possible. Deposits not removed promptly can cause damage to the vehicle's paintwork.

Remove any exterior accessories, such as antennas, before entering a car wash. If you have wax applied to the vehicle at a commercial car wash, it is recommended that you clean the wiper blades and windshield as described in *Cleaning the wiper blades and windshield*.

After washing, apply the brakes several times to dry them.

Waxing your vehicle

Waxing your vehicle on a regular basis will reduce minor scratches and paint damage.

Wax when water stops beading on the surface. This could be every three or four months, depending on operating conditions.

Use only carnauba or synthetic-based waxes. Use a cleaning fluid with a clean cloth to remove any bugs before waxing your vehicle. Use tar remover to remove any tar spots.

Avoid getting wax on the windshield, or on any surfaces which appear coarse or bumpy. If you have wax applied at a commercial car wash, it is

Maintenance and care

recommended that you clean the wiper blades and windshield as described in *Cleaning the wiper blades and windshield*.

Repairing paint chips

Minor scratches or paint damage from road debris may be repaired with the Ultra Touch Prep and Finishing Kit (#F7AZ-19K507-BA), Lacquer Touch-up Paint (#ALBZ-19500-XXXXA), or Exterior Acrylic Spray Lacquer (#ALAZ-19500-XXXXA) from the Ford Car Care Chemicals line. Please note that the part numbers (shown as XXXX above) will vary with your vehicle's specific coloring. Observe the application instructions on the products.

Remove particles such as bird droppings, tree sap, insect remains, tar spots, road salt and industrial fallout immediately.

Cleaning the wheels

Wash with the same detergent as the body of your vehicle. Do not use acid-based or alcohol-based wheel cleaners, steel wool, fuel or strong detergents. Never use abrasives that will damage the finish of special wheel surfaces. Use a tar remover to remove grease and tar.

The brushes used in some automatic car washes may damage the finish on your wheels. Before going to a car wash, find out if the brushes are abrasive.

Cleaning the engine

Engines are more efficient when they are clean because grease and dirt buildup keep the engine warmer than normal. When washing:

- Take care when using a power washer to clean the engine. The high pressure fluid could penetrate the sealed parts and cause damage.
- Do not spray with cold water to avoid cracking the engine block or other engine components.
- Cover the highlighted areas to prevent water damage when cleaning the engine.

Maintenance and care

- 4.0L

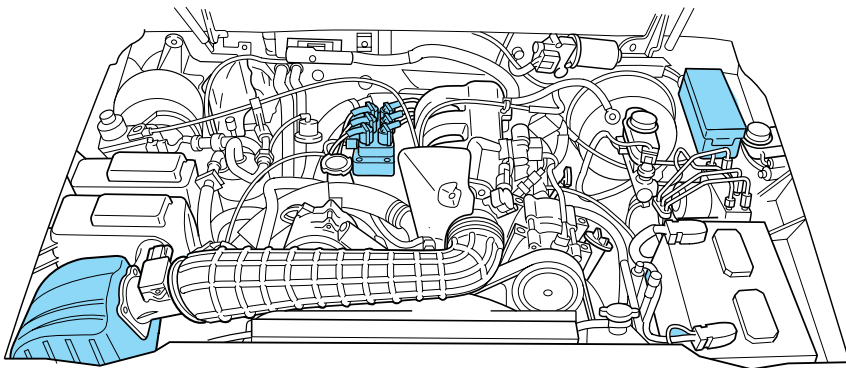

- 3.0L

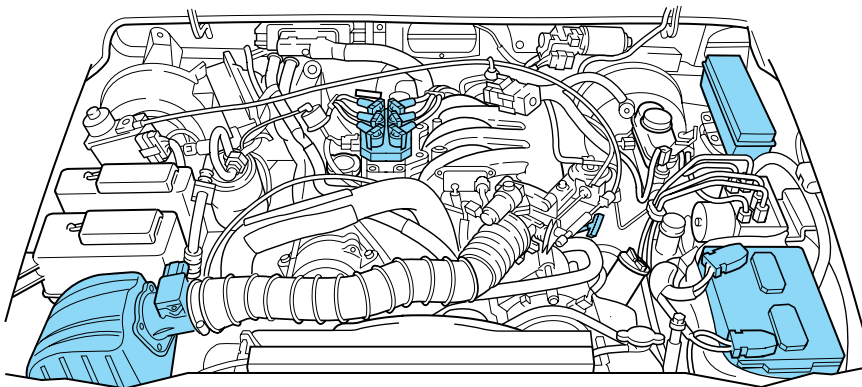

Maintenance and care

- 2.5L

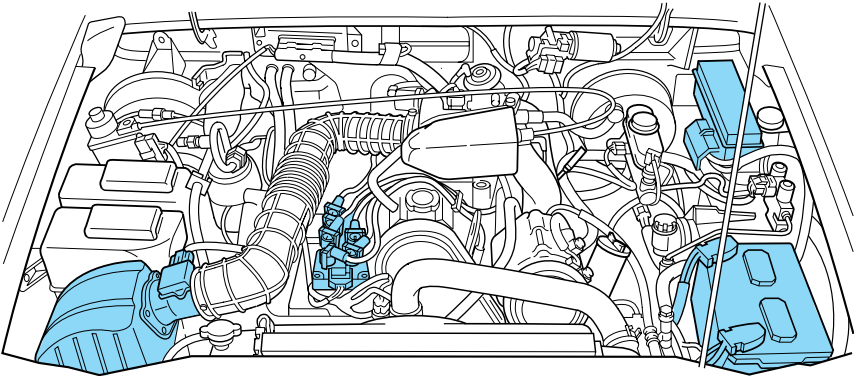

- Never wash or rinse the engine while it is running; water in the running engine may cause internal damage.

Cleaning non-painted plastic exterior parts

Use vinyl cleaner for routine cleaning. Clean with a tar remover if necessary. Do not clean plastic parts with thinners, solvents or petroleum-based cleaners.

Cleaning the exterior lamps

Wash with the same detergent as the exterior of your vehicle. If necessary, use a tar remover such as Ford Extra Strength Tar and Road Oil Remover (B7A-19520-AA).

To avoid scratching the lamps, do not use a dry paper towel, chemical solvents or abrasive cleaners.

Cleaning the wiper blades, windshield and rear window

If the wiper blades do not wipe properly, clean the wiper blade rubber element with undiluted windshield washer solution or a mild detergent. To avoid damaging the blades, do not use fuel, kerosene, paint thinner or other solvents.

If the wiper still does not wipe properly, this could be caused by substances on the windshield or rear window such as tree sap and some hot wax treatments used by commercial car washes. Clean the outside of the windshield or rear window with a non-abrasive cleaner such as Ford

Maintenance and care

Ultra-Clear Spray Glass Cleaner, (E4AZ-19C507-AA), available from your Ford Dealer. **Do not** use abrasive cleansers on glass as they may cause scratches. The windshield or rear window is clean if beads do not form when you rinse it with water. The windshield, rear window and wiper blades should be cleaned on a regular basis, and blades or rubber elements replaced when worn.

Cleaning the instrument panel

Clean with a damp cloth, then dry with a dry cloth.

Avoid cleaner or polish that increases the gloss of the upper portion of the instrument panel. The dull finish in this area helps protect the driver from undesirable windshield reflection.



Do not use chemical solvents or strong detergents when cleaning the steering wheel or instrument panel to avoid contamination of the air bag system.

Cleaning the instrument cluster lens

Clean with a damp cloth, then dry with a dry cloth.

Do not use household or glass cleaners as these may damage the lens.

Cleaning the interior fabric

Remove dust and loose dirt with a whisk broom or a vacuum cleaner. Remove fresh spots immediately. Do not use household or glass cleaners. These agents can stain and discolor the fabric. Use a mild soap and water solution if necessary.

Cleaning and maintaining the safety belts

Clean the safety belts with a mild soap solution recommended for cleaning upholstery or carpets. Do not bleach or dye the belts, because these actions may weaken the belt webbing.

Check the safety belt system periodically to make sure there are no nicks, wear or cuts. If your vehicle has been involved in an accident, refer to the *Safety belt maintenance* section in the *Seating and safety restraints* chapter.

Underbody

Flush the complete underside of vehicle frequently. Keep body drain holes unplugged. Inspect for road damage.

Maintenance and care

Inside windows

Use Ultra-Clear Spray Glass Cleaner (E4AZ-19C507-AA) for the inside windows if they become fogged.

Cleaning mirrors

Do not clean your mirrors with a dry cloth or abrasive materials. Use a soft cloth and mild detergent and water. Be careful when removing ice from outside mirrors because you may damage the reflective surface.

Capacities and specifications

MOTORCRAFT PART NUMBERS

Component	2.5L I4 engine	3.0L FFV V6 engine	4.0L V6 engine
Air filter element	FA-1658	FA-1658	FA-1658
Fuel filter	FG-1002	FG-1002	FG-1002
Battery	BXT-59	BXT-59	BXT-59
Oil filter	FL-400S	FL-400S	FL-1A
PCV valve	EV-227	EV-130	EV-225
Spark plugs*	AWSF-32F**	AGSF-22PP***	AGSF-22PP***

* Refer to Vehicle Emissions Control Information (VECI) decal for spark plug gap information.

** Two spark plugs per cylinder required (eight total).

*** If any spark plug needs to be removed for inspection, it must be re-installed in the same cylinder. Cylinders No.1, 2 and 3 have a "PG" suffix. Cylinders No. 4, 5 and 6 have a "P" suffix. If any spark plug needs to be replaced, use only spark plugs with the service part number suffix letters "PP" as shown on the engine decal.

REFILL CAPACITIES

Fluid	Ford Part Name	Application	Capacity
Engine oil (includes filter change)	Motorcraft SAE 5W-30 Super Premium Motor Oil	2.5L I4 and 3.0L V6 engine	4.3L (4.5 quarts)
		4.0L V6 engine	4.7L (5.0 quarts)
Brake fluid	High Performance DOT 3 Motor Vehicle Brake Fluid	All	Fill to line on reservoir
Power steering fluid	Motorcraft MERCON® ATF	All	Fill to range on dipstick

Capacities and specifications

Fluid	Ford Part Name	Application	Capacity
Transmission fluid ¹	Motorcraft MERCON® ATF	5-speed manual	2.65L (2.8 quarts) ²
	Motorcraft MERCON®V ATF	4x2 vehicles with automatic and 2.5L I4 engine	9.4L (9.9 quarts) ³
		4x2 vehicles with automatic and 3.0L or 4.0L V6 engine	9.5L (10.0 quarts) ³
		4x4 vehicles with automatic	9.8L (10.3 quarts) ³
Engine coolant ⁴	Premium Engine Coolant	2.5L I4 engine with manual transmission	10.0L (10.5 quarts)
		2.5L I4 engine with automatic transmission	9.7L (10.2 quarts)
		3.0L V6 engine with manual transmission	14.3L (15.1 quarts)
		3.0L V6 engine with automatic transmission	14.0L (14.8 quarts)
		4.0L V6 engine with manual transmission	13.0L (13.7 quarts)
		4.0L V6 engine with automatic transmission	12.5L (13.2 quarts)
Fuel tank	N/A	Regular cab (Short wheel base)	62.4L (16.5 gallons)
		Regular cab (Long wheel base)	75.7L (20.0 gallons)
		SuperCab	73.8L (19.5 gallons)
Transfer Case Fluid	Motorcraft MERCON® ATF	4x4 Vehicles	1.2L (1.25 quarts)

Capacities and specifications

Fluid	Ford Part Name	Application	Capacity
Front axle lubricant	Motorcraft SAE 80W-90 Premium Rear Axle Lubricant	4x4 Vehicles	1.7L (3.6 pints)
Rear axle lubricant ⁵	Motorcraft SAE 80W-90 Premium Rear Axle Lubricant	All	2.4-2.5L (5.0-5.3 pints)
Windshield washer fluid	Ultra-Clear Windshield Washer Concentrate	All	2.6L (2.75 quarts)

¹ Ensure the correct automatic transmission fluid is used. MERCON® and MERCON® V are not interchangeable. DO NOT MIX MERCON® and MERCON® V. Refer to the Scheduled Maintenance Guide to determine the correct service interval.

² Service refill capacity is determined by filling the transmission to the bottom of the filler hole with the vehicle on a level surface.

³ Indicates only approximate dry-fill capacity. Some applications may vary based on cooler size and if equipped with an in-tank cooler. The amount of transmission fluid and fluid level should be set by the indication on the dipstick's normal operating range.

⁴ Use Ford Premium Engine Coolant (green in color). DO NOT USE Ford Extended Life Engine Coolant (orange in color). Refer to *Adding engine coolant, in the Maintenance and Care chapter*.

⁵ Traction-Lok axles use 2.2–2.4L (4.75–5.0 pints) of rear axle lubricant. Add 118 ml (4 oz.) of Additive Friction Modifier C8AZ-19B546-A or equivalent meeting Ford specification EST-M2C118-A for complete refill of Traction-Lok axles.

Service refill capacities are determined by filling the rear axle 6 mm to 14 mm (1/4 inch to 9/16 inch) below the bottom of the filler hole.

Capacities and specifications

LUBRICANT SPECIFICATIONS

Item	Ford part name or equivalent	Ford part number	Ford specification
Front axle (4X4)	Motorcraft SAE 80W-90 Premium Rear Axle Lubricant	XY-80W90-QL	WSP-M2C197-A
Rear axle	Motorcraft SAE 80W-90 Premium Rear Axle Lubricant ¹	XY-80W90-QL	WSP-M2C197-A
Brake fluid and clutch fluid (if equipped)	High Performance DOT 3 Motor Vehicle Brake Fluid	C6AZ-19542-AB	ESA-M6C25-A and DOT 3
Door weather strips	Silicone Lubricant	F7AZ-19G208-BA	ESR-M13P4-A
Engine coolant	Ford Premium Engine Coolant	E2FZ-19549-AA (in Canada, Motorcraft CXC-8-B)	ESE-M97B44-A
Engine oil	Motorcraft SAE 5W-30 Super Premium Motor Oil	XO-5W30-QSP	WSS-M2C153-G and API Certification Mark
Hinges, door checks, latches, striker plates, fuel filler door hinge and seat tracks	Multi-Purpose Grease	DOAZ-19584-AA or F5AZ-19G209-AA	ESB-M1C93-B or ESB-M1C159-A

Capacities and specifications

Item	Ford part name or equivalent	Ford part number	Ford specification
Transmission /steering/parking brake linkages and pivots, brake and clutch pedal shaft, clutch pilot bearing and. input shaft spline (manual transmission).	Premium Long-Life Grease	XG-1-C or XG-1-K	ESA-M1C75-B
Power steering fluid, transfer case fluid (4X4) and transmission fluid (manual)	Motorcraft MERCON® ATF	XT-2-QDX	MERCON®
Automatic transmission (4R44E, 5R44E and 5R55E)	Motorcraft MERCON®V ATF ²	XT-5-QM	MERCON®V
Windshield washer fluid	Ultra-clear Windshield Washer Concentrate	C9AZ-19550-AC	ESR-M17P5-A

¹ Add 118 ml (4 oz.) of Additive Friction Modifier C8AZ-19B546-A or equivalent meeting Ford specification EST-M2C118-A for complete refill of Traction-Lok axles.

² Ensure the correct automatic transmission fluid is used. Transmission fluid requirements are indicated on the dipstick or on the dipstick handle. MERCON® and MERCON® V are not interchangeable. DO NOT mix MERCON® and MERCON® V. Refer to your Scheduled Maintenance Guide to determine the correct service interval.

Capacities and specifications

ENGINE DATA

Engine	2.5L I4 engine	3.0L FFV V6 engine	4.0L V6 engine
Cubic inches	153	182	245
Required fuel	87 octane	87 octane or Ethanol (E 85)	87 octane
Firing order	1-3-4-2	1-4-2-5-3-6	1-4-2-5-3-6
Spark plug gap	1.07-1.17 mm (0.042-.046 inch)	1.07-1.17 mm (0.042-.046 inch)	1.3-1.4 mm (0.052-0.056 inch)
Ignition system	EDIS	EDIS	EDIS
Compression ratio	9.4:1	9.14:1	9.0:1

Engine	2.3L I4 engine	2.5L I4 engine	3.0L V6 engine	4.0L V6 engine
Cubic inches	138	153	182	245
Required fuel	87 octane	87 octane	87 octane	87 octane
Firing order	1-3-4-2	1-3-4-2	1-4-2-5-3-6	1-4-2-5-3-6
Spark plug gap	1.04-1.19mm (0.041-0.047 inch)	1.07-1.17mm (0.042-0.046 inch)	1.07-1.17mm (0.042-0.046 inch)	1.3-1.4 mm (0.052-0.056 inch)
Ignition system	EDIS	EDIS	EDIS	EDIS
Compression ratio	9.7:1	9.4:1	9.14:1	9.0:1

Capacities and specifications

VEHICLE DIMENSIONS

Vehicle dimensions	Regular Cab Short Wheel Base (SWB) mm (in)	Regular Cab Long Wheel Base (LWB) mm (in)	Supercab mm (in)
(1) Overall length	4 763 (187.5)	5 093 (200.5)	5 153 (202.9)
(2) Overall width	1 785 (70.3)	1 785 (70.3)	1 785 (70.3)
(3) Overall height 4x2/4x4	1 575 (62.0) / 1 655 (65.2)	1 586 (62.4) / 1 655 (65.2)	1 585 (62.4) / 1 684 (66.3)
(4) Wheelbase	2 831 (111.4)	2 983 (117.4)	3 192 (125.7)
(5) Track - Front	1 486 (58.5)	1 486 (58.5)	1 485 (58.5)
(5) Track - Rear	1 455 (57.3)	1 455 (57.3)	1 455 (57.3)

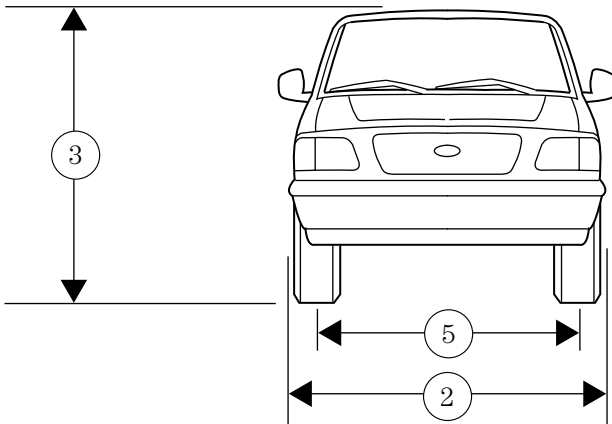

Capacities and specifications

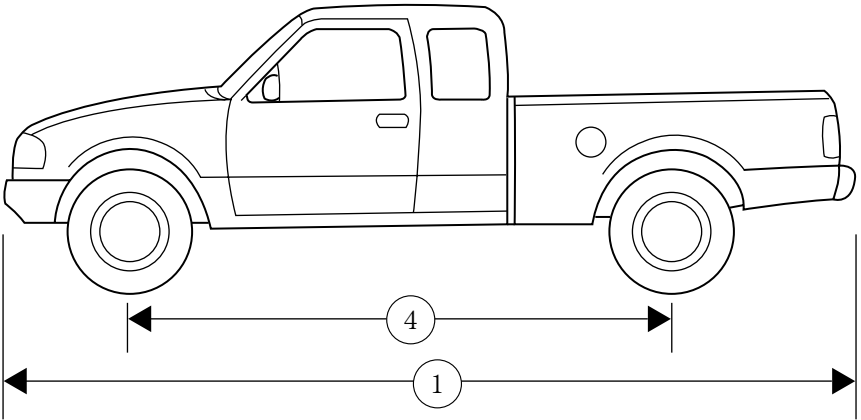
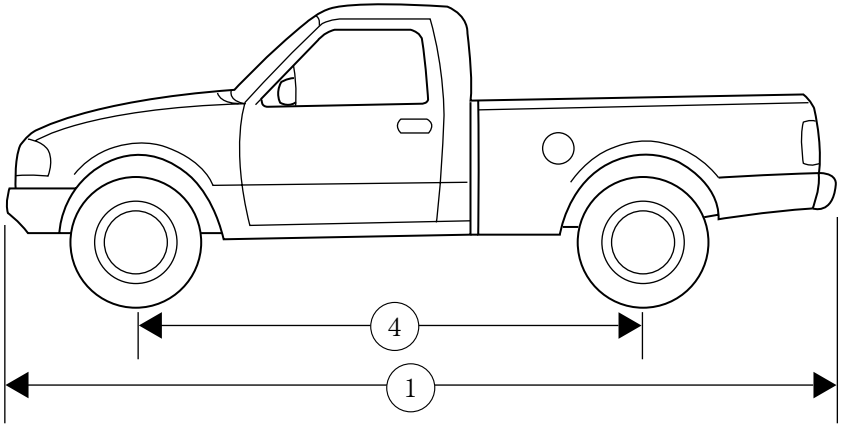

Capacities and specifications

IDENTIFYING YOUR VEHICLE

Certification label

The National Highway Traffic Safety Administration Regulations require that a Certification Label be affixed to a vehicle and prescribe where the Certification Label may be located. The Certification Label is located on the front door latch pillar on the driver's side.

MFD. BY FORD MOTOR CO. IN U.S.A.			
DATE: XXXXX	GVWR: XXXXX LB/ XXXXX KG		
FGAWR: XXXXX/XXXXXXXX	RGAWR: XXXXX/XXXXXXXX		
THIS VEHICLE CONFORMS TO ALL APPLICABLE FEDERAL MOTOR VEHICLE SAFETY STANDARDS IN EFFECT ON THE DATE OF MANUFACTURE SHOWN ABOVE.			
VIN: XXXXXXXXXXXXXXXXXXXX TYPE: XXXXXXXXXXXXXXXXXXXX			
			
MAXIMUM LOAD=OCCUPANTS + LUGGAGE=XXXXKG/XXXXLB			
OCCUPANTS: X TOTAL X FR X 2ND X RR OCCUPANTS LUGGAGE			
XX XXXKG/XXXLB			
X XXXKG/XXXLB			
TIRE: XXXXXXXXXXX XXX			
PRESSURE (FR) XXX kPa/33 PSI COLD			
PRESSURE (RR) XXX kPa/33 PSI COLD			
TRAILER TOWING: SEE OWNER GUIDE			
EXT PNT: XXXXXX XXXXX	RC: XX	DSO: XXXX	F0000
BAR INT TR TP/PS R	AXLE TR SPR	T0000	
X XX XXX X XX X XXXX	UTC VFOHT-15294A10-GA		

Vehicle identification number

The vehicle identification number is attached to a metal tag and is located on the driver side instrument panel. (Please note that in the graphic XXXX is representative of your vehicle identification number.)

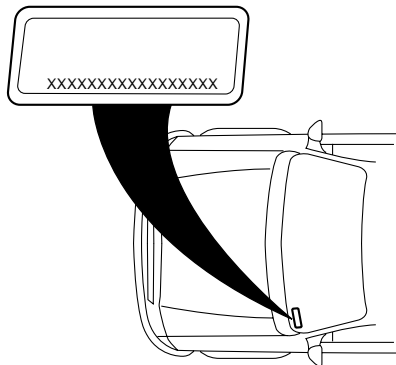

Engine number

The engine number (the last eight numbers of the vehicle identification number) is stamped on the engine block, transmission, frame and transfer case (if equipped).

Customer assistance

Ford Extended Service Plan

You can get more protection for your new car or light truck by purchasing Ford Extended Service Plan (Ford ESP) coverage. Ford ESP is an optional service contract which is backed by Ford Motor Company or Ford Motor Service Company (in the U.S.) and Ford of Canada (in Canada). It provides the following:

- benefits during the warranty period depending on the plan you purchase (such as: reimbursement for rentals; coverage for certain maintenance and wear items)
- protection against repair costs after your Bumper to Bumper Warranty expires

You may purchase Ford ESP from any participating Ford and Lincoln/Mercury and Ford of Canada dealer. There are several plans available in various time, distance and deductible combinations which can be tailored to fit your own driving needs. Ford ESP also offers reimbursement benefits for towing and rental coverage. (In Hawaii, rules vary. See your dealer for details.)

When you buy Ford ESP, you receive Peace-of-Mind protection throughout the United States and Canada, provided by a network of more than 5,000 participating Ford or Lincoln/Mercury and Ford of Canada dealers.

If you did not take advantage of the Ford Extended Service Plan at the time of purchasing your vehicle, you may still be eligible. Please contact your dealer for further information. Since this information is subject to change, please ask your dealer for complete details about Ford Extended Service Plan coverage options.

Getting the service you need

At home

Ford Motor Company and Ford of Canada have authorized dealerships to service your vehicle. When you need warranty repairs your selling dealer would like you to return to it for that service, but you may also take your vehicle to another Ford Motor Company or Ford of Canada dealership authorized for warranty repairs. Certain warranty repairs require special training though, so not all dealers are authorized to perform all warranty repairs. That means that depending on the warranty repair needed, the vehicle may need to be taken to another dealer. If a particular dealership can not assist you, then contact the Customer Assistance Center.

Customer assistance

If you have questions or concerns, or are unsatisfied with the service you are receiving, follow these steps:

1. Contact your Sales Representative or Service Advisor at your selling/servicing dealership.
2. If your inquiry or concern remains unresolved, contact the Sales Manager or Service Manager at the dealership.
3. If the inquiry or concern cannot be resolved at the dealership level, please contact the Ford Customer Assistance Center.

Ford Motor Company and Ford of Canada dealerships also carry quality parts and accessories, providing you with equipment reliability.

Away from home

If you own a Ford or Mercury vehicle and are away from home when your vehicle needs service, or if you need more help than the dealership could provide, after following the steps described above, contact the Ford Customer Assistance Center to find an authorized dealership to help you. In the United States:

Ford Motor Company
Customer Assistance Center
16800 Executive Plaza Drive
P.O. Box 6248
Dearborn, Michigan 48121
1-800-392-3673 (FORD)
(TDD for the hearing impaired: 1-800-232-5952)

In Canada:
Customer Assistance Centre
Ford Motor Company of Canada, Limited
P.O. Box 2000
Oakville, Ontario L6J 5E4
1-800-565-3673 (FORD)

Customer assistance

If you own a Lincoln vehicle and are away from home when your vehicle needs service, or if you need more help than the dealership could provide, after following the steps described above, contact the Ford Customer Assistance Center to find an authorized dealership to help you. In the United States:

Ford Motor Company
Customer Assistance Center
16800 Executive Plaza Drive
P.O. Box 6248
Dearborn, Michigan 48121
1-800-521-4140
(TDD for the hearing impaired: 1-800-232-5952)

In Canada:
Customer Assistance Centre
Ford Motor Company of Canada, Limited
P.O. Box 2000
Oakville, Ontario L6J 5E4
1-800-565-3673 (FORD)

In order to help you service your Ford or Lincoln Mercury vehicle, please have the following information available when contacting a Customer Assistance Center:

- Your telephone number (home and business)
- The name of the dealer and the city where the dealership is located
- The year and make of your vehicle
- The date of vehicle purchase
- The current odometer reading
- The vehicle identification number (VIN)

If you still have a complaint involving a warranty dispute, you may wish to contact the Dispute Settlement Board (U.S.) or the Mediation/Arbitration Program (Canada).

In some states (in the U.S.) you must directly notify Ford in writing before pursuing remedies under your state's warranty laws. Ford is also allowed a final repair attempt in some states.

In the United States, a warranty dispute must be submitted to the Dispute Settlement Board before taking action under the Magnuson-Moss Warranty Act, or to the extent allowed by state law, before pursuing replacement or repurchase remedies provided by certain state laws. This

Customer assistance

dispute handling procedure is not required prior to enforcing state created rights or other rights which are independent of the Magnuson-Moss Warranty Act or state replacement or repurchase laws.

THE DISPUTE SETTLEMENT BOARD (U.S. only)

The Dispute Settlement Board is:

- an independent, third-party arbitration program for warranty disputes
- available free to owners and lessees of qualifying Ford Motor Company vehicles

The Dispute Settlement Board may not be available in all states. Ford Motor Company reserves the right to change eligibility limitations, modify procedures and/or to discontinue this service without notice and without incurring obligations per applicable state law.

What kinds of cases does the Board review?

Unresolved warranty repair concerns or vehicle performance as designed concerns on Ford and Lincoln Mercury cars and Ford and Lincoln Mercury light trucks which are within the terms of any applicable written new vehicle warranty are eligible for review, except those involving:

- a non-Ford product
- a non-Ford dealership
- sales disputes between customer and dealer except those associated with warranty repairs or concerns with the vehicle's performance as designed
- a request for reimbursement of consequential expenses unless a service or product concern is being reviewed
- items not covered by the New Vehicle Limited Warranty (including maintenance and wear items)
- alleged personal injury/property damage claims
- cases currently in litigation
- vehicles not used primarily for family, personal or household purposes (except in states where the Dispute Settlement Board is required to review commercial vehicles)
- vehicles with non-U.S. warranties

Customer assistance

Concerns are ineligible for review if the New Vehicle Limited Warranty has expired at receipt of your application and, in certain states eligibility is dependent upon the customer's possession of the vehicle.

Eligibility may differ according to state law. For example, see the unique brochures for California, West Virginia, Georgia and Wisconsin purchasers/lessees.

Board membership

The Board consists of:

- three consumer representatives
- a Ford or Lincoln Mercury dealership representative

Consumer candidates for Board membership are recruited and trained by an independent consulting firm. The dealership Board member is chosen from Ford and Lincoln Mercury dealership management, recognized for their business leadership qualities.

What the Board needs

To have your case reviewed you must complete the application in the DSB brochure and mail it to the address provided on the application form. Some states will require you to use certified mail, with return receipt requested.

Your application is reviewed and, if it is determined to be eligible, you will receive an acknowledgment indicating:

- the file number assigned to your application
- the toll-free phone number of the DSB's independent administrator

Your dealership and a Ford Motor Company representative will then be asked to submit statements.

To properly review your case, the Board needs the following information:

- legible copies of all documents and maintenance or repair orders relevant to the case
- the year, make, model, and Vehicle Identification Number (VIN) listed on your vehicle ownership license
- the date of repair(s) and mileage at the time of occurrence(s)
- the current mileage
- the name of the dealer(s) who sold or serviced the vehicle
- a brief description of your unresolved concern

Customer assistance

- a brief summary of the action taken by the dealer(s) and Ford Motor Company
- the names (if known) of all the people you contacted at the dealership(s)
- a description of the action you expect to resolve your concern

You will receive a letter of explanation if your application does not qualify for Board review.

Oral presentations

If you would like to make an oral presentation, indicate YES to question #6 on the application. While it is your right to make an oral presentation before the Board, this is not a requirement and the Board will decide the case whether or not an oral presentation is made. Oral presentation may be requested by the Board as well.

Making a decision

Board members review all available information related to each complaint, including oral presentations, and arrive at a fair and impartial decision. Board review may be terminated at any time by either party.

Every effort is made to decide the case within 40 days of the date that all requested information is received by the Board. Since the Board generally meets once a month, it may take longer for the Board to consider some cases.

After a case is reviewed, the Board mails you a decision letter and a form on which to accept or reject the Board's decision. The decisions of the Board are binding on Ford (and, in some cases, on the dealer) but not on consumers who are free to pursue other remedies available to them under state or federal law.

To Request a DSB Brochure/Application

For a brochure/application, speak to your dealer or write/call to the Board at the following address/phone number:

Dispute Settlement Board
P.O. Box 5120
Southfield, MI 48086-5120
1-800-428-3718

Customer assistance

You may also contact the North American Customer Assistance Center at 1-800-392-3673 (Ford), TDD for the hearing impaired: 1-800-232-5952 or by writing to the Center at the following address:

Ford Motor Company
Customer Assistance Center
16800 Executive Plaza Drive
P.O. Box 6248
Dearborn, Michigan 48121

UTILIZING THE MEDIATION/ARBITRATION PROGRAM (CANADA ONLY)

In those cases where you continue to feel that the efforts by Ford and the dealer to resolve a factory-related vehicle service concern have been unsatisfactory, Ford of Canada participates in an impartial third party mediation/arbitration program administered by the Canadian Motor Vehicle Arbitration Plan (CAMVAP).

The CAMVAP program is a straight-forward and relatively speedy alternative to resolve a disagreement when all other efforts to produce a settlement have failed. This procedure is without cost to you and is designed to eliminate the need for lengthy and expensive legal proceedings.

In the CAMVAP program, impartial third-party arbitrators conduct hearings at mutually convenient times and places in an informal environment. These impartial arbitrators review the positions of the parties, make decisions and, when appropriate, render awards to resolve disputes. CAMVAP decisions are fast, fair, and final; the arbitrator's award is binding both to you and Ford of Canada.

CAMVAP services are available in all territories and provinces, except Quebec. For more information, without charge or obligation, call your CAMVAP Provincial Administrator directly at 1-800-207-0685.

GETTING ASSISTANCE OUTSIDE THE U.S. AND CANADA

Before exporting your vehicle to a foreign country, contact the appropriate foreign embassy or consulate. These officials can inform you of local vehicle registration regulations and where to find unleaded fuel.

If you cannot find unleaded fuel or can only get fuel with an anti-knock index lower than is recommended for your vehicle, contact a district or owner relations/customer assistance office.

Customer assistance

The use of leaded fuel in your vehicle without proper conversion may damage the effectiveness of your emission control system and may cause engine knocking or serious engine damage. Ford Motor Company/Ford of Canada is not responsible for any damage caused by use of improper fuel.

In the United States, using leaded fuel may also result in difficulty importing your vehicle back into the U.S.

If your vehicle must be serviced while you are traveling or living in Central or South America, the Caribbean, or the Middle East, contact the nearest Ford dealership. If the dealership cannot help you, write or call:

FORD MOTOR COMPANY
WORLDWIDE DIRECT MARKET OPERATIONS
1555 Fairlane Drive
Fairlane Business Park #3
Allen Park, Michigan 48101
U.S.A.
Telephone: (313) 594-4857
FAX: (313) 390-0804

If you are in another foreign country, contact the nearest Ford dealership. If the dealership employees cannot help you, they can direct you to the nearest Ford affiliate office.

If you buy your vehicle in North America and then relocate outside of the U.S. or Canada, register your vehicle identification number (VIN) and new address with Ford Motor Company Worldwide Direct Market Operations.

FORD CAR CARE PRODUCTS FOR YOUR VEHICLE

Ford has many quality products available from your dealer to clean your vehicle and protect its finishes. These quality products have been specifically engineered to fulfill your automotive needs; they are custom designed to complement the style and appearance of your vehicle. Each product is made from high quality materials and that meet or exceed Ford's rigid specifications. For best results, use the following or products of equivalent quality:

Ford Custom Clearcoat Polish*

Ford Custom Silicone Gloss Polish

Ford Custom Vinyl Protectant* (not available in Canada)

Motorcraft Vinyl Conditioner (Canada only)

Customer assistance

Ford Deluxe Leather and Vinyl Cleaner (not available in Canada)

Motorcraft Vinyl Cleaner (Canada only)

Ford Extra Strength Tar and Road Oil Remover* (not available in Canada)

Ford Extra Strength Upholstery Cleaner (Canada only)

Ford Extra Strength Upholstery Cleaner (not available in Canada)

Ford Metal Surface Cleaner

Ford Multi-Purpose Cleaner*

Motorcraft Car Wash Concentrate

Motorcraft Carlite Glass Cleaner

Ford Spot and Stain Remover*

Ford Super Premium Tire and Trim Dressing

Ford Triple Clean

Ford Ultra-Clear Spray Glass Cleaner (not available in Canada)

* May be sold with the Motorcraft name

FORD ACCESSORIES FOR YOUR VEHICLE

A wide selection of Ford accessories are available for your vehicle through your local authorized Ford, Lincoln Mercury or Ford of Canada dealer. These quality accessories have been specifically engineered to fulfill your automotive needs; they are custom designed to complement the style and aerodynamic appearance of your vehicle. In addition, each accessory is made from high quality materials and meets or exceeds Ford's rigid engineering and safety specifications. Ford accessories are warranted for up to 12 months or 20 000 km (12 000 miles) on all cars and light trucks and 12 months with unlimited distance on medium/heavy duty trucks unless the accessory is installed on a new vehicle, then the warranty becomes the balance of the new vehicle's warranty or the accessories warranty, whichever is greater. See your dealer for complete warranty information and availability.

Not all accessories are available for all models.

Vehicle Security

Styled wheel protector locks

Vehicle security systems

Comfort and convenience

Cargo nets

Cargo organizers

Cargo shades (Super Cab only)

Engine block heaters

Manual sliding rear window

Tire step

Travel equipment

Daytime running lights

Fog lights

Heavy-duty battery

Pickup box rails

Removable luggage rack

Running boards

Speed control

Trailer hitch

Trailer hitch bars and balls

Trailer hitch wiring adaptor

Protection and appearance equipment

Air bag anti-theft locks

Bed mat/bedliner tailgate covers

Bed mats

Bedliners

Carpet floor mats

Cleaners, waxes and polishes

Front end covers (full and sport)

Customer assistance

Hood deflectors

Locking gas cap

Lubricants and oils

Molded vinyl floor mats

Side window air deflectors

Spare tire lock

Step bumpers

Step/sill plates

Tailgate protector

Tonneau covers

Touch-up paint

Universal floor mats

For maximum vehicle performance, keep the following information in mind when adding accessories or equipment to your vehicle:

- When adding accessories, equipment, passengers and luggage to your vehicle, do not exceed the total weight capacity of the vehicle or of the front or rear axle (GVWR or GAWR as indicated on the Safety compliance certification label). Consult your dealer for specific weight information.
- The Federal Communications Commission (FCC) and Canadian Radio Telecommunications Commission (CRTC) regulate the use of mobile communications systems - such as two-way radios, telephones and theft alarms - that are equipped with radio transmitters. Any such equipment installed in your vehicle should comply with FCC or CRTC regulations and should be installed only by a qualified service technician.
- Mobile communications systems may harm the operation of your vehicle, particularly if they are not properly designed for automotive use or are not properly installed. When operated, such systems may cause the engine to stumble or stall. In addition, such systems may be damaged or their performance may be affected by operating your vehicle. (Citizens band [CB] transceivers, garage door openers and other transmitters with outputs of five watts or less will not ordinarily affect your vehicle's operation.)
- Ford cannot assume responsibility for any adverse effects or damage that may result from the use of such equipment.

Customer assistance

ORDERING ADDITIONAL OWNER'S LITERATURE

To order the publications in this portfolio:

Make checks payable to:

HELM, INCORPORATED

P.O. Box 07150

Detroit, Michigan 48207

For a free publication catalog, order toll free: 1-800-782-4356

Monday-Friday 8:00 a.m. - 6:00 p.m. EST,

for credit card holders only

Obtaining a French owner's guide

French Owner's Guides can be obtained from your dealer or by writing to Ford Motor Company of Canada, Limited, Service Publications, P.O. Box 1580, Station B, Mississauga, Ontario L4Y 4G3.

Reporting safety defects

REPORTING SAFETY DEFECTS (U.S. ONLY)

If you believe that your vehicle has a defect that could cause a crash, or could cause injury or death, you should immediately inform the National Highway Traffic Safety Administration (NHTSA) in addition to notifying Ford Motor Company.



If NHTSA receives similar complaints, it may open an investigation, and if it finds that a safety defect exists in a group of vehicles, it may order a recall and remedy campaign. However, NHTSA cannot become involved in individual problems between you, your dealer or Ford Motor Company.

To contact NHTSA, you may either call the Auto Safety Hotline toll-free at 1-800-424-9393 (202-366-0123 in the Washington D.C. area) or write to:

NHTSA
U.S. Department of Transportation
400 Seventh Street
Washington D.C. 20590

You can also obtain other information about motor vehicle safety from the Hotline.

Air bag supplemental restraint system	84
and child safety seats	85
description	84
disposal	88
driver air bag	86
indicator light	10,87
operation	86
passenger air bag	86
passenger deactivation switch	25,88
Air cleaner filter	209
Air conditioning	19
manual heating and air conditioning system	21
Ambulance packages	3
Antifreeze (see Engine coolant)	168
Anti-lock brake system (see Brakes)	107,108
Anti-theft system warning light	11
Audio system (see Radio)	26
Automatic transmission	111
driving an automatic overdrive	112,114
fluid, adding	173
fluid, checking	173
fluid, refill capacities	209
fluid, specification	214
Auxiliary power point	25
Axle lubricant specifications ..	212,214
refill capacities	209
traction lok	124
Battery	178
acid, treating emergencies	178
charging system warning light	11
jumping a disabled battery	152
maintenance-free	178
replacement, specifications ..	209
servicing	178
voltage gauge	17
Belt minder	80
Brakes	106
anti-lock	106,107,108
anti-lock brake system (ABS) warning light	10,108
brake warning light	10
fluid, checking and adding	166
fluid, refill capacities	209
fluid, specifications	212,214
lubricant specifications ..	212,214
parking	108
shift interlock	111
Break-in period	2
Capacities for refilling fluids ..	209
Cargo area shade	63
Cargo net	63
Certification Label	217
Child safety restraints	93
child safety belts	93
Child safety seats	94
attaching with tether straps ..	99
in front seat	96
in rear seat	96
tether anchorage hardware	99
Cleaning your vehicle	203
engine compartment	204
exterior	204,207
exterior lamps	206
instrument panel	207
instrument panel lens	207
interior	207
mirrors	208
plastic parts	206
safety belts	207
washing	203
waxing	203
wheels	204
windows	208
wiper blades	206

Index

- Climate control (see Air conditioning or Heating)19
- Clock29,36,42,51
- Clutch
 - fluid167
 - operation while driving116
 - recommended shift speeds118
- Console63
- Coolant
 - checking and adding168
 - refill capacities172,209
 - specifications212,214
- Cruise control
(see Speed control)55
- Customer Assistance137
 - Ford accessories for your vehicle225
 - Ford Extended Service Plan218
 - Getting assistance outside the U.S. and Canada224
 - Getting roadside assistance ...137
 - Getting the service you need218
 - Ordering additional owner's literature229
 - The Dispute Settlement Board221
 - Utilizing the Mediation/ Arbitration Program224
- Daytime running lamps (see Lamps)18
- Dipstick
 - automatic transmission fluid173
 - engine oil163
- Doors
 - door ajar warning12
 - lubricant specifications212
- Driveline universal joint and slip yoke177
- Driving under special conditions122,123
 - mud122
 - sand122
 - snow and ice123
 - through water122,124
- Emergencies, roadside
 - jump-starting152
- Emission control system195
- Engine214,215
 - check engine/ service engine soon light8
 - cleaning204
 - coolant168
 - idle speed control178
 - lubrication specifications212,214
 - refill capacities209
 - service points160,161,162
 - starting after a collision138
- Engine block heater104
- Engine oil163
 - checking and adding163
 - dipstick163
 - filter, specifications165,209
 - recommendations165
 - refill capacities209
 - specifications212,214
- Exhaust fumes105
- Fluid capacities209
- Foglamps18
- Four-Wheel Drive vehicles ..12,119
 - control trac24
 - description119
 - driving off road121
 - electronic shift24,119
 - indicator light119
 - preparing to drive your vehicle110
- Fuel186
 - calculating fuel economy192
 - cap188

- capacity209
- choosing the right fuel189
- comparisons with EPA fuel
- economy estimates195
- detergent in fuel191
- filling your vehicle
- with fuel186,188,192
- filter, specifications192,209
- fuel pump shut-off switch138
- gauge14
- improving fuel economy192
- octane rating190,214,215
- quality190
- running out of fuel191
- safety information relating to
automotive fuels186
- Fuses140,141
- Gas cap (see Fuel cap)188
- Gas mileage
(see Fuel economy)192
- Gauges14
- battery voltage gauge17
- engine coolant
temperature gauge15
- engine oil pressure gauge17
- fuel gauge14
- odometer16
- speedometer16
- tachometer15
- trip odometer16
- GAWR
(Gross Axle Weight Rating)125
- calculating127
- definition125
- driving with a heavy load125
- location125
- GVWR (Gross
Vehicle Weight Rating)125
- calculating125,127
- definition125
- driving with a heavy load125
- location125
- Hazard flashers138
- Headlamps18
- aiming202
- bulb specifications201
- daytime running lights18
- flash to pass19
- high beam11,18
- replacing bulbs197
- turning on and off18
- warning chime13
- Heating19
- heater only system19
- Hood159
- Ignition214,215
- positions of the ignition54
- Infant seats (see Safety seats) ..94
- Inspection/maintenance (I/M)
testing196
- Instrument panel
- cleaning207
- cluster8,207
- lighting up
- panel and interior19
- location of components8
- Jump-starting your vehicle152
- Keys
- key in ignition chime13
- positions of the ignition54
- Lamps
- bulb replacement
specifications chart201
- cargo lamps19
- daytime running light18
- fog lamps18
- headlamps18
- headlamps, flash to pass19
- instrument panel, dimming19
- interior lamps202
- replacing bulbs ..197,199,200,201
- Lane change indicator
(see Turn signal)54
- Lights, warning and indicator8

Index

- air bag10
- anti-lock brakes (ABS)10,108
- anti-theft11
- brake10
- charging system11
- check coolant12
- check engine8
- cruise indicator12
- door ajar12
- fuel reset10
- high beam11
- overdrive off11
- safety belt10
- speed control59
- turn signal indicator11
- Load limits125
 - GAWR125
 - GVWR125
 - trailer towing125
- Loading instructions126
- Lubricant specifications212,214
- Lumbar support, seats71
- Manual transmission116
 - fluid capacities209
 - lubricant specifications214
 - reverse118
- Mirrors
 - cleaning208
 - side view mirrors (power)62
- Motorcraft parts192,209
- Octane rating190
- Odometer16
- Oil (see Engine oil)163
- Overdrive59
- Panic alarm feature, remote entry system64
- Parking brake108
- Parts (see Motorcraft parts)209
- Power distribution box (see Fuses)144
- Power door locks62
- Power steering109
 - fluid, checking and adding173
 - fluid, refill capacity209
 - fluid, specifications212,214
- Preparing to drive your vehicle110
- Radio26
- Relays140
- Remote entry system63,64
 - illuminated entry67
 - locking/unlocking doors64
 - panic alarm64
 - replacement/additional transmitters66
 - replacing the batteries65
- Safety belts (see Safety restraints)13,72,73,74,75,76
- Safety defects, reporting230
- Safety restraints72,73,74,75,76
 - belt minder80
 - cleaning the safety belts ...83,207
 - extension assembly79
 - for adults73,74,75,76
 - for children93
 - lap belt78
 - warning light and chime10,13,79
- Safety seats for children94
- Seat belts (see Safety restraints)72
- Seats70
 - child safety seats94
- SecuriLock passive anti-theft system67,68,69
- Servicing your vehicle158
- Snowplowing3
- Spark plugs, specifications209,214,215
- Special notice3
 - ambulance conversions3
 - utility-type vehicles3
- Specification chart, lubricants212,214

- Speed control55
- Speedometer16
- Starting your vehicle100,102
 - jump starting152
- Steering wheel
 - tilting60
- Tachometer15
- Tires147,181,182,183
 - changing147,150
 - checking the pressure183
 - replacing184
 - rotating183
 - snow tires and chains185
 - tire grades182
 - treadwear182
- Towing183
 - recreational towing136
 - wrecker157
- Traction-lok rear axle124
- Transfer case
 - fluid checking177
- Transmission
 - automatic operation111
 - fluid, checking and adding (automatic)173
 - fluid, checking and adding (manual)176
 - fluid, refill capacities209
 - lubricant specifications ...212,214
 - manual operation116
- Trip odometer16
- Turn signal11,54
- Vehicle dimensions215
- Vehicle Identification Number (VIN)217
- Vehicle loading125
 - camper bodies136
- Ventilating your vehicle105
- Warning chimes13
- Warning lights (see Lights)8
- Washer fluid168
- Water, Driving through124
- Windows
 - power61
- Windshield washer fluid and wipers
 - checking and adding fluid168
 - checking and cleaning180
 - operation61
 - replacing wiper blades181
- Wrecker towing157

Filling station information

Item	Information
Required fuel	Refer to "Octane recommendations" in the <i>Maintenance and care</i> chapter.
Fuel tank capacity (Regular cab-Short wheel base)	62.4L (16.5 gallons)
Fuel tank capacity (Regular cab-Long wheel base)	75.7 (20.0 gallons)
Fuel tank capacity (SuperCab)	73.8L (19.5 gallons)
Engine oil capacity (includes filter change)-2.5L I4 and 3.0L V6 engines	4.3L (4.5 quarts). Use Motorcraft SAE 5W-30 Super Premium Motor Oil, Ford specification WSS-M2C153-G.
Engine oil capacity (includes filter change)-4.0L V6 engine	4.7L (5.0 quarts). Use Motorcraft SAE 5W-30 Super Premium Motor Oil, Ford specification WSS-M2C153-G.
Tire size and pressure	Refer to the Certification Label on inside of driver's door.
Hood release	Pull handle under the left side of the instrument panel.
Coolant capacity-2.5L I4 with manual transmission ¹	10.0L (10.5 quarts)
Coolant capacity-2.5L I4 with automatic transmission ¹	9.7L (10.2 quarts)
Coolant capacity-3.0L V6 with manual transmission ¹	14.3L (15.1 quarts)
Coolant capacity-3.0L V6 with automatic transmission ¹	14.0L (14.8 quarts)
Coolant capacity-4.0L V6 with manual transmission ¹	13.0L (13.7 quarts)
Coolant capacity-4.0L V6 with automatic transmission ¹	12.5L (13.2 quarts)
Power steering fluid capacity	Fill to range on dipstick. Use Motorcraft MERCON® ATF.

Filling station information

Item	Information
Manual transmission fluid capacity	2.65L (2.8 quarts). Use Motorcraft MERCON® ATF. ²
Automatic transmission fluid capacity-4x2 vehicles with I4 engine	9.4L (9.9 quarts). Use Motorcraft MERCON®V ATF. ^{2, 3}
Automatic transmission fluid capacity-4x2 vehicles with V6 engine	9.5L (10.0 quarts). Use Motorcraft MERCON®V ATF. ^{2, 3}
Automatic transmission fluid capacity-4x4 vehicles	9.8L (10.3 quarts). Use Motorcraft MERCON®V ATF. ^{2, 3}
Windshield washer fluid	2.6L (2.75 quarts). Use Ultra-Clear Windshield Washer Concentrate.

¹ Use Ford Premium Engine Coolant (green in color). DO NOT USE Ford Extended Life Engine Coolant (orange in color). Refer to *Adding engine coolant, in the Maintenance and Care chapter*.

² Ensure the correct automatic transmission fluid is used. Transmission fluid requirements are indicated on the dipstick or on the dipstick handle. MERCON® and MERCON® V are not interchangeable. DO NOT mix MERCON® and MERCON® V. Refer to your Scheduled Maintenance Guide to determine the correct service interval.

³ Approximate dry capacity, includes cooler and tubes. Fluid level should be checked by a qualified service technician.

Free Manuals Download Website

<http://myh66.com>

<http://usermanuals.us>

<http://www.somanuals.com>

<http://www.4manuals.cc>

<http://www.manual-lib.com>

<http://www.404manual.com>

<http://www.luxmanual.com>

<http://aubethermostatmanual.com>

Golf course search by state

<http://golfingnear.com>

Email search by domain

<http://emailbydomain.com>

Auto manuals search

<http://auto.somanuals.com>

TV manuals search

<http://tv.somanuals.com>