

Table of Contents

Introduction	4
Instrument Cluster	12
Warning lights and chimes	12
Gauges	17
Message center	19
Entertainment Systems	25
AM/FM stereo with CD/MP3	25
Auxiliary input jack (Line in)	33
USB port	35
Satellite radio information	38
SYNC®	41
Climate Controls	42
Manual heating and air conditioning	42
Rear window defroster	45
Lights	46
Headlamps	46
Turn signal control	49
Bulb replacement	50
Driver Controls	56
Windshield wiper/washer control	56
Steering wheel adjustment	57
Power windows	60
Mirrors	61
Speed control	62
Moon roof	65
Locks and Security	68
Keys	68
Locks	73
Anti-theft system	83

Table of Contents

Seating and Safety Restraints	88
Seating	88
Safety restraints	95
Airbags	110
Child restraints	125
Tires, Wheels and Loading	144
Tire information	144
Tire inflation	146
Tire Pressure Monitoring System (TPMS)	159
Vehicle loading	163
Trailer towing	169
Recreational towing	169
Driving	171
Starting	171
Brakes	176
AdvanceTrac®	178
Transmission operation	184
Roadside Emergencies	190
Getting roadside assistance	190
Hazard flasher control	191
Fuel pump shut-off switch	192
Fuses and relays	192
Changing tires	199
Wheel lug nut torque	205
Jump starting	206
Wrecker towing	209
Customer Assistance	211
Reporting safety defects (U.S. only)	218
Reporting safety defects (Canada only)	218
Cleaning	219

Table of Contents

Maintenance and Specifications	227
Engine compartment	229
Engine oil	231
Battery	233
Engine coolant	235
Fuel information	241
Air filter(s)	255
Part numbers	258
Maintenance product specifications and capacities	259
Engine data	262
Accessories	266
Ford Extended Service Plan	269
Scheduled Maintenance Guide	273
Normal scheduled maintenance and log	279
Index	296

All rights reserved. Reproduction by any means, electronic or mechanical including photocopying, recording or by any information storage and retrieval system or translation in whole or part is not permitted without written authorization from Ford Motor Company. Ford may change the contents without notice and without incurring obligation.

Copyright © 2010 Ford Motor Company

Introduction

CONGRATULATIONS

Congratulations on acquiring your new Ford. Please take the time to get well acquainted with your vehicle by reading this handbook. The more you know and understand about your vehicle, the greater the safety and pleasure you will derive from driving it.

For more information on Ford Motor Company and its products visit the following website:

- In the United States: www.ford.com
- In Canada: www.ford.ca
- In Australia: www.ford.com.au
- In Mexico: www.ford.com.mx

Additional owner information is given in separate publications.

This Owner's Guide describes every option and model variant available and therefore some of the items covered may not apply to your particular vehicle. Furthermore, due to printing cycles it may describe options before they are generally available.

Remember to pass on this Owner's Guide when reselling the vehicle. It is an integral part of the vehicle.



WARNING: Fuel pump shut-off switch: In the event of an accident the safety switch will automatically cut off the fuel supply to the engine. The switch can also be activated through sudden vibration (e.g. collision when parking). To reset the switch, refer to the *Fuel pump shut-off switch* in the *Roadside Emergencies* chapter.

SAFETY AND ENVIRONMENT PROTECTION



Warning symbols in this guide

How can you reduce the risk of personal injury to yourself or others? In this guide, answers to such questions are contained in comments highlighted by the warning triangle symbol. These comments should be read and observed.

Introduction

Warning symbols on your vehicle

When you see this symbol, it is imperative that you consult the relevant section of this guide before touching or attempting adjustment of any kind.



Protecting the environment

We must all play our part in protecting the environment. Correct vehicle usage and the authorized disposal of waste, cleaning and lubrication materials are significant steps towards this aim. Information in this respect is highlighted in this guide with the tree symbol.



CALIFORNIA Proposition 65 Warning



WARNING: Engine exhaust, some of its constituents, and certain vehicle components contain or emit chemicals known to the State of California to cause cancer and birth defects or other reproductive harm. In addition, certain fluids contained in vehicles and certain products of component wear contain or emit chemicals known to the State of California to cause cancer and birth defects or other reproductive harm.

PERCHLORATE MATERIAL

Certain components of this vehicle such as airbag modules, seat belt pretensioners, and button cell batteries may contain Perchlorate Material – Special handling may apply for service or vehicle end of life disposal. See www.dtsc.ca.gov/hazardouswaste/perchlorate.

BREAKING-IN YOUR VEHICLE

Your vehicle does not need an extensive break-in. Try not to drive continuously at the same speed for the first 1,000 miles (1,600 km) of new vehicle operation. Vary your speed frequently in order to give the moving parts a chance to break in.

Do not add friction modifier compounds or special break-in oils since these additives may prevent piston ring seating. See *Engine oil* in the *Maintenance and Specifications* chapter for more information on oil usage.

Introduction

SPECIAL NOTICES

New Vehicle Limited Warranty

For a detailed description of what is covered and what is not covered by your vehicle's New Vehicle Limited Warranty, refer to the *Warranty Guide* that is provided to you along with your Owner's Guide.

Special instructions

For your added safety, your vehicle is fitted with sophisticated electronic controls.



WARNING: Please read the section *Airbag Supplemental Restraint System (SRS)* in the *Seating and Safety Restraints* chapter. Failure to follow the specific warnings and instructions could result in personal injury.



WARNING: Front seat mounted rear-facing child or infant seats should **NEVER** be placed in front of an active passenger airbag.

IMPORTANT INFORMATION FOR P215/45R17 LOW-PROFILE TIRES AND WHEELS

If your vehicle is equipped with P215/45R17 tires, they are low-profile tires. These tires and wheels are designed to give your vehicle a sport appearance. With low-profile tires, you may notice an increase in road noise and faster tire wear, depending on road conditions and driving styles. Due to their design, low-profile tires and wheels are more prone to road damage from potholes, rough or unpaved roads, car wash rails and curb contact than standard tires and wheels. Your vehicle's warranty does not cover these types of damage. Tires should always be kept at the correct inflation pressures and extra caution should be taken when operating on rough roads to avoid impacts that could cause wheel and tire damage.

DATA RECORDING

Service Data Recording

Service data recorders in your vehicle are capable of collecting and storing diagnostic information about your vehicle. This potentially includes information about the performance or status of various systems and modules in the vehicle, such as engine, throttle, steering or brake

6

Introduction

systems. In order to properly diagnose and service your vehicle, Ford Motor Company, Ford of Canada, and service and repair facilities may access or share among them vehicle diagnostic information received through a direct connection to your vehicle when diagnosing or servicing your vehicle. For U.S. only (if equipped), if you choose to use the SYNC® Vehicle Health Report, you consent that certain diagnostic information may also be accessed electronically by Ford Motor Company and Ford authorized service facilities, and that the diagnostic information may be used for any purpose. See your *SYNC*® supplement for more information.

Event Data Recording

This vehicle is equipped with an event data recorder (EDR). The main purpose of an EDR is to record, in certain crash or near crash-like situations, such as an airbag deployment or hitting a road obstacle; this data will assist in understanding how a vehicle's systems performed. The EDR is designed to record data related to vehicle dynamics and safety systems for a short period of time, typically 30 seconds or less. The EDR in this vehicle is designed to record such data as:

- **How various systems in your vehicle were operating;**
- **Whether or not the driver and passenger seatbelts were buckled/fastened;**
- **How far (if at all) the driver was depressing the accelerator and/or the brake pedal; and**
- **How fast the vehicle was travelling; and**
- **Where the driver was positioning the steering wheel.**

This data can help provide a better understanding of the circumstances in which crashes and injuries occur.

Note: EDR data is recorded by your vehicle only if a non-trivial crash situation occurs; no data is recorded by the EDR under normal driving conditions and no personal data or information (e.g., name, gender, age, and crash location) is recorded (see limitations regarding 911 Assist and Traffic, directions and Information privacy below). However, parties, such as law enforcement, could combine the EDR data with the type of personally identifying data routinely acquired during a crash investigation.

Introduction

To read data recorded by an EDR, special equipment is required, and access to the vehicle or the EDR is needed. In addition to the vehicle manufacturer, other parties, such as law enforcement, that have such special equipment, can read the information if they have access to the vehicle or the EDR. Ford Motor Company and Ford of Canada do not access event data recorder information without obtaining consent, unless pursuant to court order or where required by law enforcement, other government authorities or other third parties acting with lawful authority. Other parties may seek to access the information independently of Ford Motor Company and Ford of Canada.

Note: Including to the extent that any law pertaining to Event Data Recorders applies to SYNC® or its features, please note the following: Once 911 Assist (if equipped) is enabled (set ON), 911 Assist may, through any paired and connected cell phone, disclose to emergency services that the vehicle has been in a crash involving the deployment of an airbag or, in certain vehicles, the activation of the fuel pump shut-off. Certain versions or updates to 911 Assist may also be capable of being used to electronically or verbally provide to 911 operators the vehicle location (such as latitude and longitude), and/or other details about the vehicle or crash or personal information about the occupants to assist 911 operators to provide the most appropriate emergency services. If you do not want to disclose this information, do not activate the 911 Assist feature. See your SYNC® supplement for more information.

Additionally, when you connect to Traffic, Directions and Information (if equipped, U.S. only) the service uses GPS technology and advanced vehicle sensors to collect the vehicle's current location, travel direction, and speed ("vehicle travel information") only to help provide you with the directions, traffic reports, or business searches your request. If you do not want Ford or its vendors to receive this information, do not activate the service. Ford Motor Company and the vendors it uses to provide you with this information do not store your vehicle travel information. For more information, see Traffic, Directions and Information, Terms and Conditions. See your SYNC® supplement for more information.

Introduction

CELL PHONE USE

The use of Mobile Communications Equipment has become increasingly important in the conduct of business and personal affairs. However, drivers must not compromise their own or others' safety when using such equipment. Mobile Communications can enhance personal safety and security when appropriately used, particularly in emergency situations. Safety must be paramount when using mobile communications equipment to avoid negating these benefits.

Mobile Communication Equipment includes, but is not limited to, cellular phones, pagers, portable email devices, text messaging devices and portable two-way radios.



WARNING: Driving while distracted can result in loss of vehicle control, accident and injury. Ford strongly recommends that you use extreme caution when using any device or feature that may take your focus off the road. Your primary responsibility is the safe operation of your vehicle.

We recommend against the use of any handheld device while driving and that you comply with all applicable laws.





















EXPORT UNIQUE (NON-UNITED STATES/CANADA) VEHICLE SPECIFIC INFORMATION

For your particular global region, your vehicle may be equipped with features and options that are different from the features and options that are described in this Owner's Guide. A market unique supplement may be supplied that complements this book. By referring to the market unique supplement, if provided, you can properly identify those features, recommendations and specifications that are unique to your vehicle. This Owner's Guide is written primarily for the U.S. and Canadian Markets. Features or equipment listed as standard may be different on units built for Export. **Refer to this Owner's Guide for all other required information and warnings.**

Introduction























These are some of the symbols you may see on your vehicle.

Vehicle Symbol Glossary

Safety Alert		See Owner's Guide	
Fasten Safety Belt		Airbag - Front	
Airbag - Side		Child Seat Lower Anchor	
Child Seat Tether Anchor		Brake System	
Anti-Lock Brake System		Parking Brake System	
Brake Fluid - Non-Petroleum Based		Parking Aid System	
Stability Control System		Speed Control	
Master Lighting Switch		Hazard Warning Flasher	
Fog Lamps-Front		Fuse Compartment	
Fuel Pump Reset		Windshield Wash/Wipe	
Windshield Defrost/Demist		Rear Window Defrost/Demist	

Introduction

Vehicle Symbol Glossary

Power Windows Front/Rear		Power Window Lockout	
Child Safety Door Lock/Unlock		Interior Luggage Compartment Release	
Panic Alarm		Engine Oil	
Engine Coolant		Engine Coolant Temperature	
Do Not Open When Hot		Battery	
Avoid Smoking, Flames, or Sparks		Battery Acid	
Explosive Gas		Fan Warning	
Power Steering Fluid		Maintain Correct Fluid Level	
Service Engine Soon		Engine Air Filter	
Passenger Compartment Air Filter		Jack	
Check Fuel Cap		Low Tire Pressure Warning	

Instrument Cluster

WARNING LIGHTS AND CHIMES

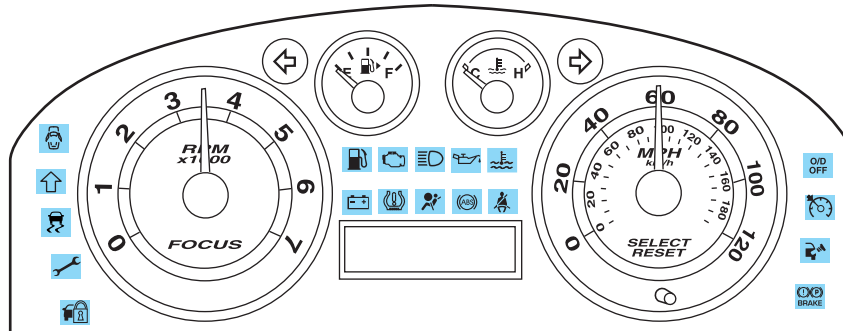

Warning lights and gauges can alert you to a vehicle condition that may become serious enough to cause expensive repairs. A warning light may illuminate when a problem exists with one of your vehicle's functions. Many lights will illuminate when you start your vehicle to make sure the bulb works. If any light remains on after starting the vehicle, refer to the respective system warning light for additional information.

Service engine soon: The *service engine soon* indicator light illuminates when the ignition is first turned to the on position to check

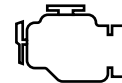

the bulb and to indicate whether the vehicle is ready for Inspection/Maintenance (I/M) testing. Normally, the "service engine soon" light will stay on until the engine is cranked, then turn itself off if no malfunctions are present. However, if after 15 seconds the "service engine soon" light blinks eight times, it means that the vehicle is not ready for I/M testing. See the *Readiness for Inspection/Maintenance (I/M) testing* in the *Maintenance and Specifications* chapter.

Solid illumination after the engine is started indicates the on-board diagnostics system (OBD-II) has detected a malfunction. Refer to *On-board diagnostics (OBD-II)* in the *Maintenance and Specifications* chapter. If the light is blinking, engine misfire is occurring which could damage your catalytic converter. Drive in a moderate fashion (avoid heavy acceleration and deceleration) and have your vehicle serviced immediately by your authorized dealer.

12

Instrument Cluster

 **WARNING:** Under engine misfire conditions, excessive exhaust temperatures could damage the catalytic converter, the fuel system, interior floor coverings or other vehicle components, possibly causing a fire.

Check fuel cap: Illuminates when the fuel cap may not be properly installed. Continued driving with this light on may cause the Service engine soon warning light to come on, refer to *Fuel filler cap* in the *Maintenance and Specifications* chapter.



Brake system warning light: To confirm the brake system warning light is functional, it will momentarily illuminate when the ignition is turned to the on position when the engine is not running, or in a position between on and start, or by applying the parking brake when the ignition is turned to the on position. If the brake system warning light does not illuminate at this time, seek service immediately from your authorized dealer. Illumination after releasing the parking brake indicates low brake fluid level and the brake system should be inspected immediately by your authorized dealer.



 **WARNING:** Driving a vehicle with the brake system warning light on is dangerous. A significant decrease in braking performance may occur. It will take you longer to stop the vehicle. Have the vehicle checked by your authorized dealer. Driving extended distances with the parking brake engaged can cause brake failure and the risk of personal injury.

Anti-lock brake system (if equipped): If the ABS light stays illuminated or continues to flash, a malfunction has been detected, have the system serviced immediately by your authorized dealer. Normal braking is still functional unless the brake warning light also is illuminated.



Instrument Cluster

Airbag readiness: If this light fails to illuminate when the ignition is turned to on, continues to flash or remains on, have the system serviced immediately by your authorized dealer. A chime will sound when there is a malfunction in the indicator light.



Safety belt: Reminds you to fasten your safety belt. A Belt-Minder® chime will also sound to remind you to fasten your safety belt. Refer to the *Seating and Safety Restraints* chapter to activate/deactivate the Belt-Minder® chime feature.



Charging system: Illuminates when the battery is not charging properly. If it stays on while the engine is running, there may be a malfunction with the charging system. Contact your authorized dealer as soon as possible. This indicates a problem with the electrical system or a related component.



Engine oil pressure: Illuminates when the oil pressure falls below the normal range, refer to *Engine oil* in the *Maintenance and Specifications* chapter.

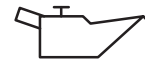

Engine coolant temperature: Illuminates when the engine coolant temperature is high. Stop the vehicle as soon as possible, switch off the engine and let cool. Refer to *Engine coolant* in the *Maintenance and Specifications* chapter.



WARNING: Never remove the coolant reservoir cap while the engine is running or hot.

Anti-theft system: Flashes when the SecuriLock® Passive Anti-theft system has been activated.



Instrument Cluster

Overdrive off (if equipped):

Illuminates when the overdrive function of the transmission has been turned off, refer to the

Driving chapter. If the light flashes steadily or does not illuminate, have the transmission serviced soon, or damage may occur.

O/D
OFF

Speed control (if equipped):

Illuminates when the speed control is activated. Turns off when the speed control system is deactivated.

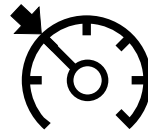

Upshift (if equipped): To maximize fuel economy, this light

illuminates when the manual transmission should be shifted to the next highest gear. Refer to the *Driving* chapter for more information.



Low tire pressure warning:

Illuminates when your tire pressure is low. If the light remains on at start up or while driving, the tire pressure should be checked. Refer

to *Inflating your tires* in the *Tires, Wheels and Loading* chapter. When the ignition is first turned to on, the light will illuminate for three seconds to ensure the bulb is working. If the light does not turn on or begins to flash, have the system inspected by your authorized dealer. For more information on this system, refer to *Tire pressure monitoring system (TPMS)* in the *Tires, Wheels and Loading* chapter.

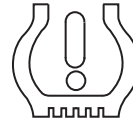

AdvanceTrac®/traction control:

Illuminates when the AdvanceTrac®/traction control is active. If the light remains on,

contact your authorized dealer as soon as possible. Refer to the *Driving* chapter for more information.



Throttle control/transmission:

Illuminates when a powertrain fault has been detected. Contact your authorized dealer as soon as possible.



Instrument Cluster

Low fuel: Illuminates when the fuel level in the fuel tank is at or near empty (refer to *Fuel gauge* in this chapter).



Door ajar: Illuminates when the ignition is on and any door, the trunk or hood is open.



Turn signal: Illuminates when the left or right turn signal or the hazard lights are turned on. If the indicators stay on or flash faster, check for a burned out bulb.



High beams: Illuminates when the high beam headlamps are turned on.



Key-in-ignition warning chime: Sounds when the key is left in the ignition in the off or accessory position and the driver's door is opened.

Headlamps on warning chime: Sounds when the headlamps or parking lamps are on, the ignition is off (the key is not in the ignition) and the driver's door is opened.

Perimeter alarm warning chime: Sounds when using a key to unlock the driver's doors and the perimeter alarm is armed.

Instrument Cluster

GAUGES

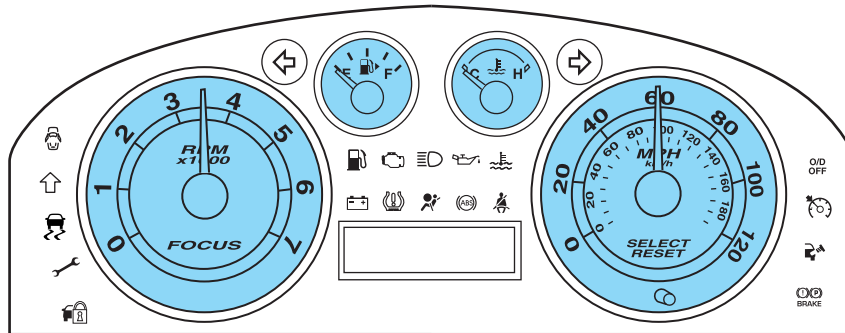

Speedometer: Indicates the current vehicle speed.

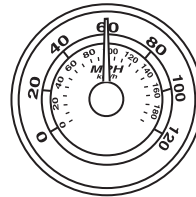

Engine coolant temperature gauge: Indicates engine coolant temperature. At normal operating temperature, the needle will be in the normal range. **If it enters the red section, the engine is overheating. Stop the vehicle as soon as safely possible, switch off the engine and let the engine cool.** If it enters the red section and the *service engine soon* indicator light illuminates, refer to *How fail safe cooling works* in the *Maintenance and Specifications* chapter.

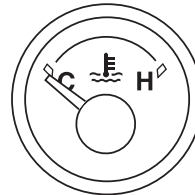

WARNING: Never remove the coolant reservoir cap while the engine is running or hot.

Instrument Cluster

Odometer: Registers the total miles (kilometers) of the vehicle.

If equipped with a message center, refer to *Message center* in this chapter on how to switch the display between Metric and English.



Trip odometer: Registers the distance of individual journeys.

• **Standard instrument cluster:**
Press the SELECT/RESET button once to switch from the odometer to the TRIP A or B feature. To reset the trip, press and hold the SELECT/RESET button.

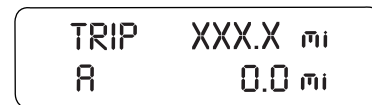

• **Optional instrument cluster:** See *TRIP A/B* under *Message center* in this chapter.

Tachometer: Indicates the engine speed in revolutions per minute. Driving with your tachometer pointer continuously at the top of the scale may damage the engine.

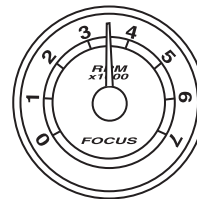

Fuel gauge: Indicates approximately how much fuel is left in the fuel tank (when the ignition is in the on position). The fuel gauge may vary slightly when the vehicle is in motion or on a grade.

Refer to *Filling the tank* in the *Maintenance and Specifications* chapter for more information.

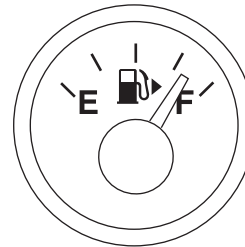

Instrument Cluster

MESSAGE CENTER

Your vehicle's message center is capable of monitoring many vehicle systems and will alert you to potential vehicle problems and various conditions with an informational message followed by a long indicator chime.

The message center display is located in the instrument cluster.

Info

Press the INFO button repeatedly to cycle through the following features:



TRIP A/B

Registers the distance of individual journeys. Press and release INFO button until the A or B trip appears in the display (this represents the trip mode). Press and hold RESET until it resets.

Refer to *UNITS* later in this section to switch the display between Metric and English.

MYKEY MILES (km) (if programmed)

For more information, refer to *MyKey™* in the *Locks and Security* chapter.

MILES (km) TO E

This displays an estimate of approximately how far you can drive with the fuel remaining in your tank under normal driving conditions. Remember to turn the ignition off when refueling to allow this feature to correctly detect the added fuel.

LOW FUEL LEVEL will display when you have approximately 50 miles (80 km), to empty. Press RESET to clear this warning message. It will return at approximately 25 miles (40 km), 10 miles (16 km) and 0 miles (0 km) miles to empty.

Distance to empty is calculated using a running average fuel economy, which is based on your recent driving history of 500 miles (800 km). This value is not the same as the average fuel economy display. The running average fuel economy is re-initialized to a factory default value if the battery is disconnected.

Instrument Cluster

AVG MPG (L/100km)

Average fuel economy displays your average fuel economy in miles/gallon or liters/100 km.

If you calculate your average fuel economy by dividing distance traveled by gallons of fuel used (liters of fuel used by 100 kilometers traveled), your figure may be different than displayed for the following reasons:

- Your vehicle was not perfectly level during fill-up
- Differences in the automatic shut-off points on the fuel pumps at service stations
- Variations in top-off procedure from one fill-up to another
- Rounding of the displayed values to the nearest 0.1 gallon (liter)

1. Drive the vehicle at least 5 miles (8 km) with the speed control system engaged to display a stabilized average.

2. Record the highway fuel economy for future reference.

It is important to press the RESET button (press and hold RESET for two seconds in order to reset the function) after setting the speed control to get accurate highway fuel economy readings.

For more information refer to *Essentials of good fuel economy* in the *Maintenance and Specifications* chapter.

MPG (L/km) ↑ ↓

This displays instantaneous fuel economy as a bar graph ranging from ↓ poor economy to ↑ excellent economy.

Your vehicle must be moving to calculate instantaneous fuel economy. When your vehicle is not moving, this function shows ↓, one or no bars illuminated. Instantaneous fuel economy cannot be reset.

System check and vehicle feature customization

Press the SETUP button repeatedly to cycle the message center through the following features:

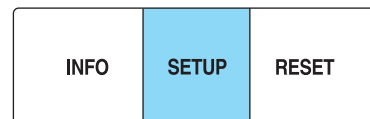

RESET FOR SYSTEM CHECK

When this message appears, press the RESET button and the message center will begin to cycle through the following systems and provide a status of the item if needed.

20

Instrument Cluster

1. CHARGING SYSTEM
2. DOORS
3. TRUNK
4. BRAKE SYSTEM
5. DTE/FUEL LEVEL
6. MYKEY DISTANCE (if programmed)
7. MYKEY(S) PROGRAMMED
8. ADMIN KEYS PROGRAMMED

Note: Some systems show a message only if a condition is present.

UNITS

Displays the current units in English or Metric.

Press RESET to change between English and Metric.

AUTOLOCK

This feature automatically locks all vehicle doors when the vehicle is shifted into any gear, putting the vehicle in motion.

Press the RESET control to turn autolock on or off.

AUTOUNLOCK

This feature automatically unlocks all vehicle doors when the driver's door is opened within 10 minutes of the ignition being turned off.

Press the RESET control to turn autounlock on or off.

CREATE MYKEY / MYKEY SETUP / CLEAR MYKEY

For more information refer to *MyKey*[™] in the *Locks and Security* chapter.

LANGUAGE = ENGLISH / SPANISH / FRENCH

Allows you to choose which language the message center will display in. Selectable languages are English, Spanish, or French.

Waiting four seconds or pressing the RESET button cycles the message center through each of the language choices.

Press and hold the RESET button for two seconds to set the language choice.

Instrument Cluster

System warnings

System warnings alert you to possible problems or malfunctions in your vehicle's operating systems.

In the event of a multiple warning situation, the message center will cycle the display to show all warnings by displaying each one for four seconds.

The message center will display the last selected feature if there are no more warning messages. This allows you to use the full functionality of the message center after you acknowledge the warning by pressing the RESET control and clearing the warning message.

Warning messages can be divided into three categories:

- Cannot be cleared until the condition is corrected.
- Reappears 10 minutes after resetting it.
- Reappears if the condition clears, then reoccurs within the same ignition on/off cycle.

Pressing RESET can clear some messages. If they do not clear when pressing RESET, the condition causing the message must be addressed to clear the message.

Pressing RESET can clear some messages. If they do not clear when pressing RESET, the condition causing the message must be addressed to clear the message.

DRIVER DOOR AJAR — Displayed when the driver door is not completely closed.

PASSENGER DOOR AJAR — Displayed when the passenger door is not completely closed.

REAR LEFT DOOR AJAR — Displayed when the rear left door is not completely closed.

REAR RIGHT DOOR AJAR — Displayed when the rear right door is not completely closed.

TRUNK AJAR — Displayed when the trunk is not completely closed.

PARK BRAKE ENGAGED — Displayed when the parking brake is set, the engine is running and the vehicle is driven more than 3 mph (5 km/h). If the warning stays on after the parking brake is released, contact your authorized dealer as soon as possible.

XXX MILES TO E FUEL LEVEL LOW — Displayed as an early reminder of a low fuel condition.

22

Instrument Cluster

CHECK BRAKE SYSTEM — Displayed when the braking system is not operating properly. If the warning stays on or continues to come on, contact your authorized dealer as soon as possible.

BRAKE FLUID LEVEL LOW — Indicates the brake fluid level is low and the brake system should be inspected immediately. Refer to *Brake/clutch fluid* in the *Maintenance and Specifications* chapter.

LOW TIRE PRESSURE — Displayed when one or more tires on your vehicle have low tire pressure. Refer to *Inflating your tires* in the *Tires, Wheels and Loading* chapter.

TIRE PRESSURE MONITOR FAULT — Displayed when the tire pressure monitoring system is malfunctioning. If the warning stays on or continues to come on, contact your authorized dealer as soon as possible.

TIRE PRESSURE SENSOR FAULT — Displayed when a tire pressure sensor is malfunctioning, or your spare tire is in use. For more information on how the system operates under these conditions, refer to *Tire Pressure Monitoring System (TPMS)* in the *Tires, Wheels and Loading* chapter. If the warning stays on or continues to come on, contact your authorized dealer as soon as possible.

MYKEY ACTIVE DRIVE SAFELY — Displayed at startup when MyKey™ is in use. Refer to *MyKey™* in the *Locks and Security* chapter for more information.

KEY COULD NOT PROGRAM — Displayed when an attempt is made to program a spare key using two existing MyKeys. Refer to *MyKey™* in the *Locks and Security* chapter for more information.

VEHICLE SPEED 80 MPH MAX — Displayed when a MyKey™ is in use and the Admin has enabled the MyKey speed limit and the vehicle speed is 80 mph (130 km/h). Refer to *MyKey™* in the *Locks and Security* chapter for more information.

SPEED LIMITED TO 80 MPH — Displayed when starting the vehicle and MyKey™ is in use and the MyKey speed limit is on. Refer to *MyKey™* in the *Locks and Security* chapter for more information.

CHECK SPEED DRIVE SAFELY — Displayed when a MyKey™ is in use and the optional setting is on and the vehicle exceeds a preselected speed. Refer to *MyKey™* in the *Locks and Security* chapter for more information.

Instrument Cluster

VEHICLE NEAR TOP SPEED — Displayed when a MyKey™ is in use and the MyKey speed limit is on and the vehicle speed is approaching 80 mph (130 km/h). Refer to *MyKey™* in the *Locks and Security* chapter for more information.

TOP SPEED MYKEY SETTING — Displayed when a MyKey™ is in use and the MyKey speed limit is on and the vehicle speed is 80 mph (130 km/h). Refer to *MyKey™* in the *Locks and Security* chapter for more information.

BUCKLE UP TO UNMUTE AUDIO — Displayed when a MyKey™ is in use and Belt-Minder® is activated. Refer to *MyKey™* in the *Locks and Security* chapter for more information.

ADVTRAC ON MYKEY SETTING — Displayed when a MyKey™ is in use when trying to disable the AdvanceTrac® system and the optional setting is on. Refer to *MyKey™* in the *Locks and Security* chapter for more information.

TO STOP ALARM START VEHICLE (if equipped)— Displayed when the perimeter alarm system is armed and the vehicle is entered using the key on the driver's side door. In order to prevent the perimeter alarm system from triggering, the ignition must be turned to start or on before the 12 second chime expires. See *Perimeter alarm system* in the *Locks and Security* chapter.

Entertainment Systems

AUDIO SYSTEMS

AM/FM/single CD satellite compatible sound system

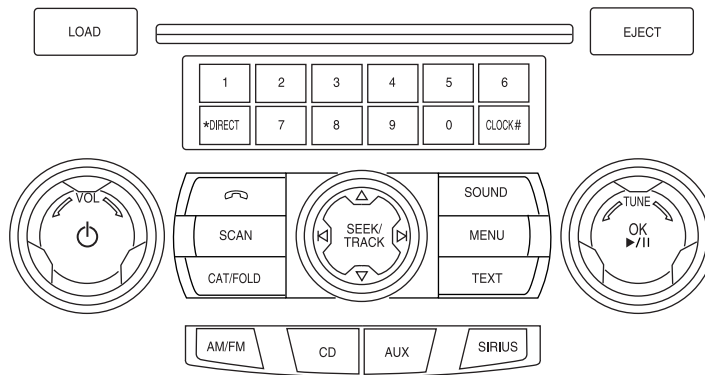

WARNING: Driving while distracted can result in loss of vehicle control, accident and injury. Ford strongly recommends that drivers use extreme caution when using any device or feature that may take their focus off the road. Your primary responsibility is the safe operation of the vehicle. We recommend against the use of any handheld device while driving and that you comply with all applicable laws.

Accessory delay: Your vehicle is equipped with accessory delay. With this feature, the radio and other electrical accessories may be used for up to ten minutes after the ignition is turned off or until either front door is opened.

Setting the clock

To set the time, press CLOCK#. The display will read SET TIME. Use the memory preset numbers (0–9) to enter in the desired time—hours and minutes and press OK. The clock will then begin from that time.

Entertainment Systems

AM/FM Radio

⏻ / VOL (Power/Volume): Press to turn the radio on/off. Turn the knob to increase/decrease volume.

If the volume is set above a certain level and the ignition is turned off, the volume will come back on at a nominal listening level when the ignition switch is turned back on.

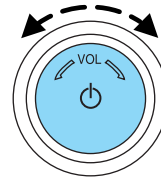

AM/FM: Press repeatedly to select AM/FM1/FM2 frequency band.

TUNE: Turn the knob to go up/down the frequency band in individual increments.



DIRECT: Press DIRECT and then select the desired radio frequency (i.e. 93.9) using the memory preset numbers (0–9).

SEEK/TRACK: Press ◀ SEEK/TRACK ▶ to access the previous/next strong radio station.



SCAN: Press for a brief sampling of all strong radio stations.

MEMORY PRESETS (0–9): When tuned to any station, press and hold a preset button until sound returns and PRESET # SAVED appears in the display. You can save up to 30 stations, 10 in AM, 10 in FM1 and FM2.



Saving presets automatically– Autoset allows you to set the strongest local radio stations without losing your original manually set preset stations for AM/FM1/FM2.

To activate the autoset feature: Press MENU repeatedly until AUTO PRESET ON/OFF appears in the display. Use ◀ SEEK/TRACK ▶ to switch AUTO PRESET to ON, and either wait five seconds for the search to initiate or press OK to immediately initiate the search. If you press

26

Entertainment Systems

another control within those five seconds, the search will not initiate. The 10 strongest stations will be filled and the station stored in preset 1 will begin playing.

If there are fewer than 10 strong stations, the system will store the last one in the remaining presets.

RBDS Radio

Available only in FM mode. This feature allows you to search RBDS-equipped stations for a certain category of music format: CLASSIC, COUNTRY, JAZZ/RB, ROCK, etc.

To activate: Press MENU repeatedly until RDS (ON/OFF) appears in the display. Use ◀ SEEK/TRACK ▶ to switch RDS ON/OFF. When RDS is OFF, you will not be able to search for RDS equipped stations or view the station name or type.

CAT/FOLD (Category/Folder): This feature allows you to select from various music categories.

To change RDS categories: Press MENU repeatedly until RDS ON/OFF appears in the display. Use ▲ / ▼ to switch RDS to ON. Press CAT. PRESS UP OR DOWN TO CHANGE RDS CATEGORY will appear in the display. Press ▲ / ▼ to scroll through all possible categories. When the desired category appears in the display, press ◀ SEEK/TRACK ▶ to find the next station playing that selection or press SCAN for a brief sampling of all stations playing that category of music.

CD/MP3 Player

CD: Press to enter CD/MP3 mode. If a disc is already loaded into the system, CD/MP3 play will begin where it ended last. If no CD is loaded, NO DISC will appear in the display.

LOAD: This control is not operational. To load a CD, simply insert the disc, label side up, into the CD slot.

EJECT: Press EJECT to eject the CD.

▶ / || **Play/Pause:** Press to play/pause a track when playing a CD.



Entertainment Systems

SEEK/TRACK: Press ◀
SEEK/TRACK ▶ to access the
previous/next track.



CAT (Category) / FOLD (Folder):

In MP3 mode only– Press CAT/FOLD and then press ◀
SEEK/TRACK ▶ to access the previous/next folder.

SCAN: Press for a brief sampling of all tracks on the current disc or
MP3 folder.

DIRECT:

In CD mode– Press DIRECT. The display will read DIRECT TRACK
MODE SELECT TRACK. Enter the desired track number using the
memory preset buttons (0–9). The system will then begin playing that
track.

In MP3 folder mode– Press DIRECT and the memory preset buttons
(0–9) of the desired folder. The system will advance to that specific
folder.

TEXT:

In MP3 mode only– Press TEXT repeatedly to view Album (AL), Folder
(FL), Song (SO) and Artist (AR) in the display, if available.

In TEXT MODE: Sometimes the display requires additional text to be
displayed. When the < / > indicator is active, press TEXT and then
press ◀ SEEK/TRACK ▶ to view the additional display text.

COMPRESSION: Press MENU repeatedly until COMPRESSION ON/OFF
appears in the display. Use ◀ SEEK/TRACK ▶ to switch between
ON/OFF. When COMPRESSION is ON, the system will bring the soft and
loud CD passages together for a more consistent listening level.

SHUFFLE: Press MENU repeatedly until SHUFFLE ON/OFF appears in
the display. Use ◀ SEEK/TRACK ▶ to switch between ON/OFF. If
you wish to engage shuffle mode right away, press ◀
SEEK/TRACK ▶ to begin random play. Otherwise, random play will
begin when the current track is finished playing. The system will only
shuffle the currently playing disc.

28

Entertainment Systems

Satellite Radio (if equipped)



Satellite radio is available only with a valid SIRIUS radio subscription. Check with your authorized dealer for availability.

SIRIUS: Press repeatedly to access satellite radio mode, if equipped. Press repeatedly to cycle through SAT1, SAT2 and SAT3 modes.



TUNE/OK: Turn the knob to go to the next / previous available SIRIUS satellite station.



DIRECT: Press DIRECT then enter the desired channel (i.e. 002) using the memory preset buttons (0–9). If you only enter one digit, press OK and the system will go to that satellite channel. If you enter three digits, the system will automatically go to that channel, if available. You may cancel your entry by pressing DIRECT. If an invalid station number is entered, INVALID CHANNEL will appear in the display and the system will continue playing the current station.

SEEK/TRACK: Press  SEEK/TRACK  to seek to the previous/next channel. If a specific category is selected, (Jazz, Rock, News, etc.), press 



SEEK/TRACK  to seek to the previous/next channel in the selected category. Press and hold  SEEK/TRACK  to fast seek through the previous/next channels.

SCAN: Press SCAN for a brief sampling of all available SIRIUS satellite channels. If a specific category is selected, (Jazz, Rock, News, etc.) press SCAN for a brief sampling of all available SIRIUS satellite channels within the selected category.

MEMORY PRESETS (0–9): There are 30 available presets, 10 each for SAT1, SAT2 and SAT3. To save satellite channels in your memory presets, tune to the desired channel then press and hold a memory preset number (0–9) until sound returns.



TEXT: Press and release to display the artist and song title. While in TEXT MODE, press again to scroll through the Artist (AR), Song (SO), Channel (CH) and Category (CA).

Entertainment Systems

In TEXT MODE: Sometimes the display requires additional text to be displayed. When the < / > indicator is active, press TEXT and then press ◀ SEEK/TRACK ▶ to view the additional display text.

CAT (Category) / FOLD (Folder): Press to switch between turning the most recently selected satellite radio category on or off. The category icon (CAT) will illuminate in the display when a specific category is selected (the icon will not illuminate during CATEGORY ALL). If no category has ever been selected, NO CATEGORY SELECTED will display.

Note: Separate categories can be set for SAT1, SAT2 or SAT3. Refer to *Satellite radio menu* for further information on selecting a satellite radio category.

SATELLITE RADIO MENU: Press MENU when satellite radio mode is active to access. Press OK to enter into the satellite radio menu.

Press ▲ / ▼ to cycle through the following options:

- **CATEGORY MENU-** Press OK to enter category mode.
Press ▲ / ▼ to scroll through the list of available SIRIUS channel Categories (Pop, Rock, News, etc.) Press OK when the desired category appears in the display. After a category is selected, press ▲ / ▼ to search for that specific category of channels only (i.e. ROCK). You may also select CATEGORY ALL to seek all available SIRIUS categories and channels. Press OK to close and return to the main menu.
- **SONG SEEK MENU-** Press OK to enter song seek menu.
Press ▲ / ▼ to scroll through the following options:
 - a. **SAVE THIS SONG:** Press OK to save the currently playing song's title in the system's memory. (If you try to save something other than a song, CANT SAVE will appear in the display.) When the chosen song is playing on any satellite radio channel, the system will alert you with an audible prompt. Press OK while SONG ALERT is in the display and the system will take you to the channel playing the desired song. You can save up to 20 song titles. If you attempt to save more than 20 titles, the display will read REPLACE SONG? Press OK to access the saved titles and press ▲ / ▼ to cycle through the saved titles. When the song title appears in the display that you would like to replace, press OK. SONG REPLACED will appear in the display.
 - b. **DELETE A SONG:** Press OK to delete a song from the system's memory. Press ▲ / ▼ to cycle through the saved songs. When the song appears in the display that you would like to delete, press OK.

30

Entertainment Systems

The song will appear in the display for confirmation. Press OK again and the display will read SONG DELETED. If you do not want to delete the currently listed song, press ▲ / ▼ to select either RETURN or CANCEL.

Note: If there are no songs presently saved, the display will read NO SONGS.

c. DELETE ALL SONGS: Press OK to delete all song's from the system's memory. The display will read ARE YOU SURE ? Press OK to confirm deletion of all saved songs and the display will read ALL DELETED.

Note: If there are no songs presently saved, the display will read NO SONGS.

d. DISABLE ALERTS/ENABLE ALERTS: Press OK to enable/disable the satellite alert status which alerts you when your selected songs are playing on a satellite radio channel. (The system default is disabled.) SONG ALERTS ENABLED/DISABLED will appear in the display. The menu listing will display the opposite state. For example, if you have chosen to enable the song alerts, the menu listing will read DISABLE as the alerts are currently on, so your other option is to turn them off.

- **CHANNEL LOCKOUT MENU-** Press OK to enter the Channel Lockout menu. Press the ▲ / ▼ to scroll through the following options:
 - a. LOCK/UNLOCK THIS CHANNEL:** Press OK when LOCK/UNLOCK THIS CHANNEL is displayed and the display will read ENTER PIN. Enter your four-digit PIN number (initial PIN is 1234) and the system will lock/unlock the channel and CHANNEL LOCKED or UNLOCKED will be displayed.
Note: you must be tuned to the specific channel you want to lock/unlock when using this feature.
 - b. CHANGE PIN:** Press OK when CHANGE PIN is displayed. The display will read ENTER OLD PIN. Enter your current (old) PIN number and when the system accepts your entry it will display ENTER NEW PIN. Enter your new four-digit PIN and the system will save the new PIN and PIN SAVED will display.
 - c. UNLOCK ALL CHANNELS:** Press OK when UNLOCK ALL CHANNELS is displayed and the display will read ENTER PIN. Enter your four-digit PIN and the system will unlock all channels and the display will read CHANNEL UNLOCKED.
 - d. RESET PIN:** Press OK when RESET PIN is displayed. The display will read ARE YOU SURE. Press OK again to automatically reset the

Entertainment Systems

PIN number to its initial password setting (1234). PIN RESET TO DEFAULT PIN will be displayed.

e. RETURN: Press OK when RETURN is displayed and the system will exit back to the satellite radio menu.

Sound Adjustments

Press SOUND repeatedly to cycle through the following features:

BASS: Press ◀ SEEK/TRACK ▶ to adjust the level of bass.

TREBLE: Press ◀ SEEK/TRACK ▶ to adjust the level of treble.

BALANCE: Press ◀ SEEK/TRACK ▶ to adjust the audio between the left (L) and right (R) speakers.

FADE: Press ◀ SEEK/TRACK ▶ to adjust the audio between the back (B) and front (F) speakers.

SPEED COMPENSATED VOLUME: With this feature on, radio volume automatically gets louder with increasing vehicle speed to compensate for road and wind noise.

The default setting is *off*.

Use ◀ SEEK/TRACK ▶ to adjust between SPEED OFF and levels 1–7: Increasing the level from 1 (lowest setting) to 7 (highest setting) allows the radio volume to automatically change slightly with vehicle speed to compensate for road and wind noise.

Recommended level is 1–3; SPEED OFF turns the feature off and level 7 is the maximum setting.

ALL SEATS (Occupancy mode, if equipped): Press SOUND repeatedly to reach the Occupancy mode setting. Press ◀ SEEK/TRACK ▶ to select and optimize sound for ALL SEATS, DRIVERS SEAT or REAR SEATS.

Extra Features

AUX: Press to access LINE IN (auxiliary audio mode), and SYNC® (if equipped) modes.

For location and further information on auxiliary audio mode, refer to *Auxiliary input jack* later in this chapter.

If your vehicle is equipped with SYNC®, refer to the SYNC® information included with your vehicle for further information.

32

Entertainment Systems

OK: Your vehicle may be equipped with special phone and media features which will require you to confirm commands by pressing OK. Refer to the *SYNC*[®] information included with your vehicle for further information.

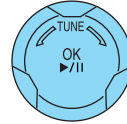

☎ (Phone): If your vehicle is equipped with *SYNC*[®], press to access *SYNC PHONE* features. Refer to the *SYNC*[®] information included with your vehicle for further information. If your vehicle is not equipped with *SYNC*[®], the display will read NO PHONE.

Auxiliary input jack (Line in)



WARNING: Driving while distracted can result in loss of vehicle control, accident and injury. Ford strongly recommends that drivers use extreme caution when using any device or feature that may take their focus off the road. Your primary responsibility is the safe operation of the vehicle. We recommend against the use of any handheld device while driving and that you comply with all applicable laws.

The auxiliary input jack provides a way to connect your portable music player to the in-vehicle audio system. This allows the audio from a portable music player to be played through the vehicle speakers with high fidelity. To achieve optimal performance, please observe the following instructions when attaching your portable music device to the audio system.

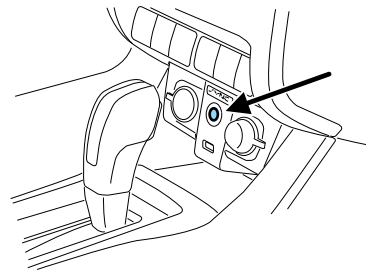

If your vehicle is equipped with a navigation system, refer to *Auxiliary input jack* section in the *Audio Features* chapter of your *Navigation System* supplement.

Required equipment:

1. Any portable music player designed to be used with headphones
2. An audio extension cable with stereo male 1/8 in. (3.5 mm) connectors at each end

Entertainment Systems

To play your portable music player using the auxiliary input jack:

1. Begin with the vehicle parked and the radio turned off.
2. Ensure that the battery in your portable music player is new or fully charged and that the device is turned off.
3. Attach one end of the audio extension cable to the headphone output of your player and the other end of the audio extension cable to the AIJ in your vehicle.
4. Turn the radio on, using either a tuned FM station or a CD loaded into the system. Adjust the volume to a comfortable listening level.
5. Turn the portable music player on and adjust the volume to 1/2 the volume.
6. Press AUX on the vehicle radio repeatedly until LINE, LINE IN or SYNC LINE IN appears in the display.
You should hear audio from your portable music player although it may be low.
7. Adjust the sound on your portable music player until it reaches the level of the FM station or CD by switching back and forth between the AUX and FM or CD controls.

Troubleshooting:

1. Do not connect the audio input jack to a line level output. Line level outputs are intended for connection to a home stereo and are not compatible with the AIJ. The AIJ will only work correctly with devices that have a headphone output with a volume control.
2. Do not set the portable music player's volume level higher than is necessary to match the volume of the CD or FM radio in your audio system as this will cause distortion and will reduce sound quality. Many portable music players have different output levels, so not all players should be set at the same levels. Some players will sound best at full volume and others will need to be set at a lower volume.
3. If the music sounds distorted at lower listening levels, turn the portable music player volume down. If the problems persists, replace or recharge the batteries in the portable music player.
4. The portable music player must be controlled in the same manner when it is used with headphones as the AIJ does not provide control (play, pause, etc.) over the attached portable music player.
5. For safety reasons, connecting or adjusting the settings on your portable music player should not be attempted while the vehicle is moving. Also, the portable music player should be stored in a secure

34

Entertainment Systems

location, such as the center console or the glove box, when the vehicle is in motion. The audio extension cable must be long enough to allow the portable music player to be safely stored while the vehicle is in motion.

USB port (if equipped)



WARNING: Driving while distracted can result in loss of vehicle control, accident and injury. Ford strongly recommends that drivers use extreme caution when using any device or feature that may take their focus off the road. Your primary responsibility is the safe operation of the vehicle. We recommend against the use of any handheld device while driving and that you comply with all applicable laws.

Your vehicle may be equipped with a USB port inside your center console. This feature allows you to plug in media playing devices, memory sticks, and also to charge devices if they support this feature. For further information on this feature, refer to *Accessing and using your USB port* in the SYNC® supplement or *Navigation System* supplement.

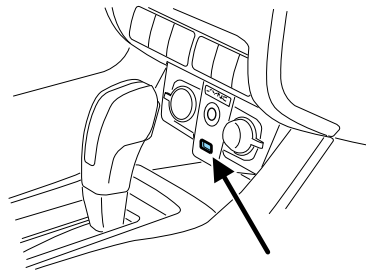

GENERAL AUDIO INFORMATION

Radio frequencies:

AM and FM frequencies are established by the Federal Communications Commission (FCC) and the Canadian Radio and Telecommunications Commission (CRTC). Those frequencies are:

AM: 530, 540–1700, 1710 kHz

FM: 87.7, 87.9–107.7, 107.9 MHz

Radio reception factors:

There are three factors that can affect radio reception:

- Distance/strength: The further you travel from an FM station, the weaker the signal and the weaker the reception.
- Terrain: Hills, mountains, tall buildings, power lines, electric fences, traffic lights and thunderstorms can interfere with your reception.
- Station overload: When you pass a broadcast tower, a stronger signal may overtake a weaker one and play while the weak station frequency is displayed.

Entertainment Systems

CD/CD player care

Do:

- Handle discs by their edges only. (Never touch the playing surface).
- Inspect discs before playing.
- Clean only with an approved CD cleaner.
- Wipe discs from the center out.

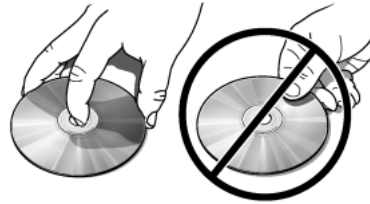

Don't:

- Expose discs to direct sunlight or heat sources for extended periods of time.
- Clean using a circular motion.

CD units are designed to play commercially pressed 4.75 in (12 cm) audio compact discs only. Due to technical incompatibility, certain recordable and re-recordable compact discs may not function correctly when used in Ford CD players.

Do not use any irregular shaped CDs or discs with a scratch protection film attached.

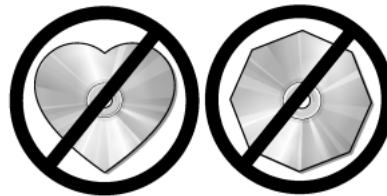

Entertainment Systems

CDs with homemade paper (adhesive) labels should not be inserted into the CD player as the label may peel and cause the CD to become jammed. It is recommended that homemade CDs be identified with permanent felt tip marker rather than adhesive labels. Ballpoint pens may damage CDs. Please contact your authorized dealer for further information.

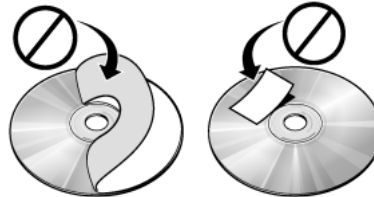

Audio system warranty and service

Refer to the *Warranty Guide* for audio system warranty information. If service is necessary, see your dealer or qualified technician.

MP3 track and folder structure

Your MP3 system recognizes MP3 individual tracks and folder structure as follows:

- There are two different modes for MP3 disc playback: MP3 track mode (system default) and MP3 folder mode. For more information on track and folder mode, refer to *Sample MP3 structure* in the following section.
- MP3 track mode ignores any folder structure on the MP3 disc. The player numbers each MP3 track on the disc (noted by the .mp3 file extension) from T001 to a maximum of T255.
Note: The maximum number of playable MP3 files may be less depending on the structure of the CD and exact model of radio present.
- MP3 folder mode represents a folder structure consisting of one level of folders. The CD player numbers all MP3 tracks on the disc (noted by the .mp3 file extension) and all folders containing MP3 files, from F001 (folder) T001 (track) to F253 T255.
- Creating discs with only one level of folders will help with navigation through the disc files.

Entertainment Systems

Sample MP3 structure

If you are burning your own MP3 discs, it is important to understand how the system will read the structures you create. While various files may be present, (files with extensions other than mp3), only files with the .mp3 extension will be played. Other files will be ignored by the system. This enables you to use the same MP3 disc for a variety of tasks on your work computer, home computer and your in-vehicle system.

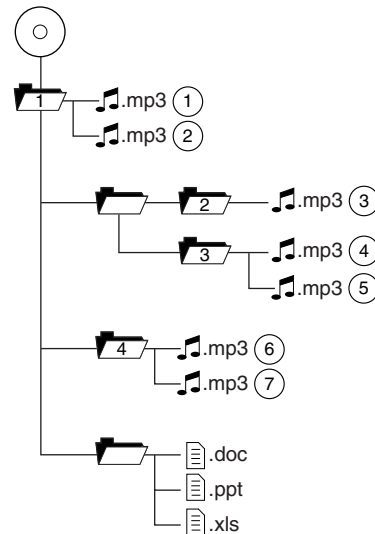

In track mode, the system will display and play the structure as if it were only one level deep (all .mp3 files will be played, regardless of being in a specific folder). In folder mode, the system will only play the .mp3 files in the current folder.

Satellite radio information (if equipped)

Satellite radio channels: SIRIUS® broadcasts a variety of music, news, sports, weather, traffic and entertainment satellite radio channels. For more information and a complete list of SIRIUS® satellite radio channels, visit www.sirius.com in the United States, www.sirius-canada.ca in Canada, or call SIRIUS® at 1-888-539-7474.

Entertainment Systems

Satellite radio reception factors: To receive the satellite signal, your vehicle has been equipped with a satellite radio antenna located on the roof of your vehicle. The vehicle roof provides the best location for an unobstructed, open view of the sky, a requirement of a satellite radio system. Like AM/FM, there are several factors that can affect satellite radio reception performance:

- **Antenna obstructions:** For optimal reception performance, keep the antenna clear of snow and ice build-up and keep luggage and other material as far away from the antenna as possible.
- **Terrain:** Hills, mountains, tall buildings, bridges, tunnels, freeway overpasses, parking garages, dense tree foliage and thunderstorms can interfere with your reception.
- **Station overload:** When you pass a ground based broadcast repeating tower, a stronger signal may overtake a weaker one and result in an audio mute.

Unlike AM/FM audible static, you will hear an audio mute when there is a satellite radio signal interference. Your radio display may display NO SIGNAL to indicate the interference.

SIRIUS® satellite radio service: SIRIUS® satellite radio is a subscription based satellite radio service that broadcasts music, sports, news and entertainment programming. A service fee is required in order to receive SIRIUS® service. Vehicles that are equipped with a factory installed SIRIUS® satellite radio system include hardware and a limited subscription term, which begins on the date of sale or lease of the vehicle.

For information on extended subscription terms, the online media player and other SIRIUS® features, please contact SIRIUS® at 1-888-539-7474.

Note: SIRIUS® reserves the unrestricted right to change, rearrange, add or delete programming including canceling, moving or adding particular channels, and its prices, at any time, with or without notice to you. Ford Motor Company shall not be responsible for any such programming changes.

Entertainment Systems

Satellite radio electronic serial number (ESN): This 12–digit Satellite Serial Number is needed to activate, modify or track your satellite radio account. You will need this number when communicating with SIRIUS®. While in satellite radio mode, you can view this number on the radio display by pressing the AUX and preset 1 controls simultaneously.

Radio Display	Condition	Action Required
ACQUIRING	Radio requires more than two seconds to produce audio for the selected channel.	No action required. This message should disappear shortly.
SAT FAULT	Internal module or system failure present.	If this message does not clear within a short period of time, or with an ignition key cycle, your receiver may have a fault. See your authorized dealer for service.
INVALID CHNL	Channel no longer available.	This previously available channel is no longer available. Tune to another channel. If the channel was one of your presets, you may choose another channel for that preset button.
UNSUBSCRIBED	Subscription not available for this channel.	Contact SIRIUS® at 1–888–539–7474 to subscribe to the channel or tune to another channel.
NO TEXT	Artist information not available.	Artist information not available at this time on this channel. The system is working properly.

Entertainment Systems

Radio Display	Condition	Action Required
NO TEXT	Song title information not available.	Song title information not available at this time on this channel. The system is working properly.
NO TEXT	Category information not available.	Category information not available at this time on this channel. The system is working properly.
NO SIGNAL	Loss of signal from the SIRIUS® satellite or SIRIUS® tower to the vehicle antenna.	You are in a location that is blocking the SIRIUS® signal (i.e., tunnel, under an overpass, dense foliage, etc). The system is working properly. When you move into an open area, the signal should return.
UPDATING	Update of channel programming in progress.	No action required. The process may take up to three minutes.
CALL SIRIUS® 1-888-539-7474	Satellite service has been deactivated by SIRIUS® satellite radio.	Call SIRIUS® at 1-888-539-7474 to re-activate or resolve subscription issues.





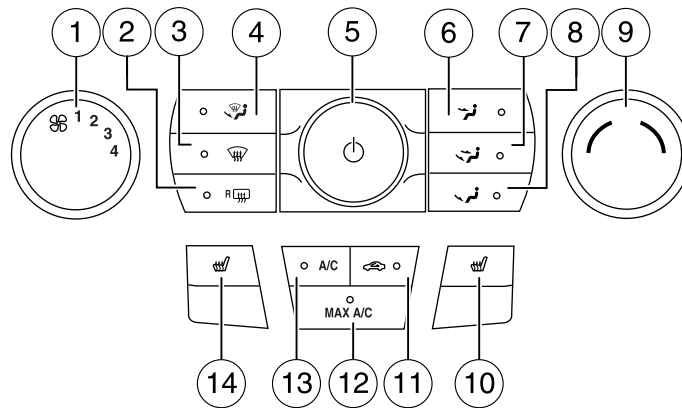

SYNC® (IF EQUIPPED)

Your vehicle may be equipped with SYNC®, a hands-free communications and entertainment system with special phone and media features. For more information, please refer to the *SYNC®* supplement.











Climate Controls

MANUAL HEATING AND AIR CONDITIONING SYSTEM





1.  **Fan speed adjustment:** Controls the volume of air circulated in the vehicle.
2.  **Rear defroster:** Press to activate/deactivate the rear window defroster. Refer to *Rear window defroster* later in this chapter for more information.
3.  **Defrost:** Distributes outside air through the windshield defroster vents and demister vents. Can be used to clear the windshield of fog and thin ice. The system will automatically provide outside air to reduce window fogging. Press this button again to return to the previous air flow selection.
4.  : Distributes air through the windshield defroster vents, demister vents, floor vents and rear seat floor vents. The system will automatically provide outside air to reduce window fogging.
5.  **Power:** Press to activate/deactivate the climate control system. When the system is off, outside air is prevented from entering the vehicle.
6.  : Distributes air through the instrument panel vents.

Climate Controls

7.  : Distributes air through the instrument panel vents, floor vents, rear seat floor vents and demister vents.
8.  : Distributes air through the floor vents, rear seat floor vents and demister vents.
9. **Temperature control:** Controls the temperature of the airflow in the vehicle.
10.  **Passenger heated seat control (if equipped):** Press to activate/deactivate the passenger heated seat. See *Heated seats* in the *Seating and Safety Restraints* chapter.
11.  **Recirculated air:** Press to activate/deactivate air recirculation in the vehicle. Recirculated air may reduce the amount of time needed to cool down the interior of the vehicle and may also help reduce undesired odors from reaching the interior of the vehicle. Recirculated air engages automatically when MAX A/C is selected or can be engaged manually in any airflow mode except  (defrost). When the ignition switch is turned off and back on, the climate system will return to the recirculated air mode only if the A/C button LED is illuminated and the air distribution selection is either  (panel) or  (panel/floor).
12. **MAX A/C:** Distributes recirculated air through the instrument panel vents to cool the vehicle. This re-cooling of the interior air is more economical and efficient. Recirculated air may also help reduce undesirable odors from entering the vehicle. Press the MAX A/C button again for normal A/C operation.
13. **A/C:** Press to activate/deactivate air conditioning. Use with recirculated air to improve cooling performance and efficiency. A/C engages automatically in MAX A/C,  (defrost) and  (floor/defrost).
14.  **Driver heated seat control (if equipped):** Press to activate/deactivate the driver heated seat. See *Heated seats* in the *Seating and Safety Restraints* chapter.

Climate Controls

Operating tips

- To reduce fog build-up on the windshield during humid weather, select  (defrost) or  (floor/defrost).
- To reduce humidity build-up inside the vehicle, do not drive with the system off or with  (recirculated air) engaged and A/C off.
- Do not put objects under the front seats that will interfere with the airflow to the back seats.
- Remove any snow, ice or leaves from the air intake area at the base of the windshield.
- To improve the time to reach comfort in hot weather, drive with the windows slightly open for 2-3 minutes after start up or until the vehicle has been “aired out.”
- A small amount of air may be felt from the floor vent regardless of the air distribution setting that is selected.

During extreme high ambient temperatures when idling stationary for extended periods of time in gear, it is recommended to run the A/C in the MAX A/C position, reduce blower fan speed from the highest setting and put the vehicle's transmission into the P (Park) gear position (automatic transmission only) to continue to receive cool air from your A/C system.

For maximum cooling performance in MAX A/C mode:

1. Select MAX A/C.
2. Select the coolest temperature setting.
3. Set the fan to the highest speed initially. As the interior starts to cool down, adjust the fan speed to maintain comfort.

To aid in side window defogging/demisting in cold weather:

1. Select .
2. Select A/C.
3. Adjust the temperature control to maintain comfort.
4. Set the fan speed to the highest setting.
5. Direct the outer instrument panel vents towards the side windows.

To increase airflow to the outer instrument panel vents, close the vents located in the middle of the instrument panel.

Climate Controls

REAR WINDOW DEFROSTER

The rear defroster control is located on the climate control panel and works to clear the rear window of fog and thin ice.

The engine must be running to operate the rear window defroster.

Press  to turn the rear window defroster on. An indicator light on the control will illuminate when active. The rear window defroster turns off automatically after a predetermined amount of time, if a low battery condition is detected or when the ignition is turned off or to the accessory position. To manually turn off the rear window defroster at any time, press the control again.

If your vehicle is equipped with both rear defroster and heated mirrors, the same control will activate both. Refer to *Heated outside mirrors* in the *Driver Controls* chapter.

Do not use razor blades or other sharp objects to clean the inside of the rear window or to remove decals from the inside or the rear window. This may cause damage to the heated grid lines and will not be covered by your warranty.

Lights

HEADLAMP CONTROL

- Turns the lamps off.
- P◁ Turns on the parking lamps, instrument panel lamps, license plate lamps and tail lamps.
- ≡◊ Turns the low beam headlamps on.

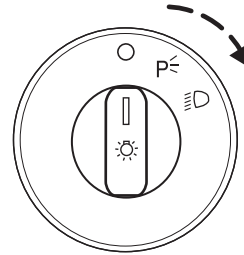

Fog lamp control (if equipped)

The fog lamps can be turned on when the headlamp control is in the ≡◊ or P◁ position and the high beams are not turned on.

With the key in the on position, pull the headlamp control towards you to turn fog lamps on. The fog lamp indicator light ≡◊ on the headlamp control will illuminate.

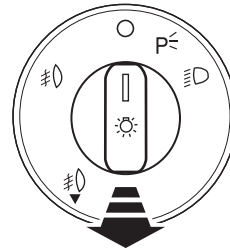

High beams

Push the lever toward the instrument panel to activate. Pull the lever towards you to deactivate.

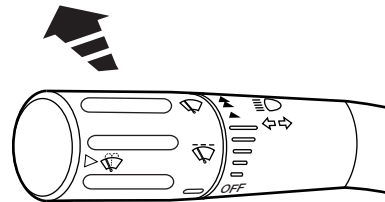

Lights

Flash-to-pass

Pull toward you slightly to activate and release to deactivate.

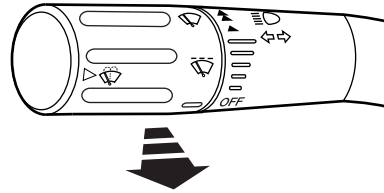

Daytime running lamps (DRL) (if equipped)

Turns the headlamps on with a reduced output.

To activate:

- the ignition must be in the on position and
- the headlamp control is in the off or parking lamp position.



WARNING: Always remember to turn on your headlamps at dusk or during inclement weather. The Daytime Running Lamp (DRL) system does not activate the tail lamps and generally may not provide adequate lighting during these conditions. Failure to activate your headlamps under these conditions may result in a collision.

PANEL DIMMER CONTROL

Use to adjust the brightness of the instrument panel and all applicable switches in the vehicle during headlamp and parking lamp operation.

Move the control to the full upright position, past detent, to turn on the interior lamps.

Note: If the battery is disconnected, discharged, or a new battery is installed, the dimmer switch requires re-calibration. Rotate the dimmer switch from the full dim position to the full dome/on position to reset. This will ensure that your displays are visible under all lighting conditions.

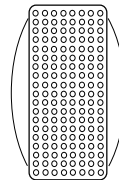

Lights

AIMING THE HEADLAMPS

The headlamps on your vehicle are properly aimed at the assembly plant. If your vehicle has been in an accident, the alignment of your headlamps should be checked by your authorized dealer.

Vertical aim adjustment

1. Park the vehicle directly in front of a wall or screen on a level surface, approximately 25 feet (7.6 meters) away.

- (1) 8 feet (2.4 meters)
- (2) Center height of lamp to ground
- (3) 25 feet (7.6 meters)
- (4) Horizontal reference line

2. Measure the height from the center of your headlamp to the ground and mark an 8 foot (2.4 meter) horizontal reference line on the vertical wall or screen at this height (a piece of masking tape works well).

3. Turn on the low beam headlamps to illuminate the wall or screen and open the hood.

4. On the wall or screen you will observe an area of high intensity light. The top of the high intensity area should touch the horizontal reference line. If not, the beam will need to be adjusted.

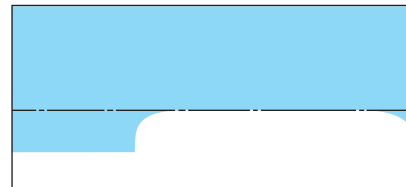
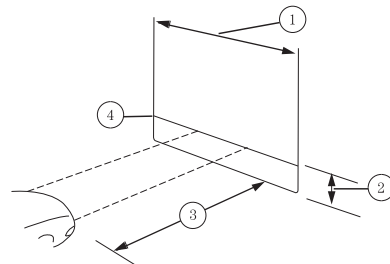

Lights

5. Locate the vertical adjuster on each headlamp, then use a Phillips #2 screwdriver or 10 mm wrench/socket to adjust the headlamp up or down.

6. Close the hood and turn off the lamps.

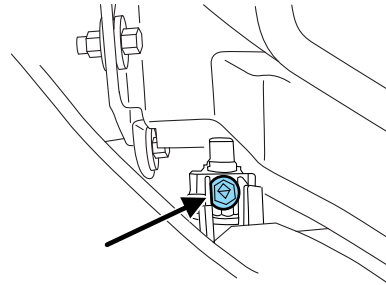

HORIZONTAL AIM IS NOT REQUIRED FOR THIS VEHICLE AND IS NON-ADJUSTABLE.

TURN SIGNAL CONTROL

- Push down to activate the left turn signal.
- Push up to activate the right turn signal.

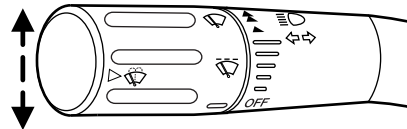

INTERIOR LAMPS

Map lamps

To turn on the map lamps, press the outer edge of the clear lens. The map lamp lights when:

- any door is opened.
- the remote entry controls are pressed and the ignition is off.

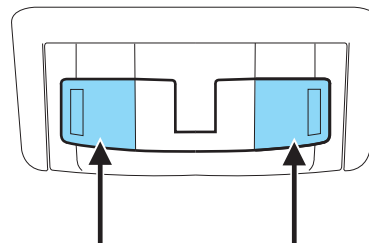

Lights

Rear dome lamp

When the lamp control is in the middle position, the rear dome lamp will come on when a door is opened or the unlock button is pressed on the remote keyless entry.

If the control is moved to the driver side position, the lamp will not come on at all.

If the control is moved to the passenger side position, the lamp will stay on.

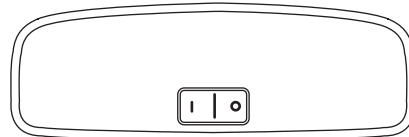

Ambient lighting (if equipped)

Illuminates four footwells and three cupholders with a choice of several colors. The ambient lighting control switch is located on the instrument panel. To activate, press and release the control to cycle through the color choices plus the off state.

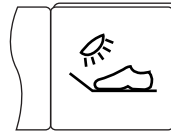

The lights come on whenever the ignition is in either the on or accessory position.

Note: The ambient lights will stay on until the ignition is placed in the off position and either of the front doors are opened or the accessory delay timer expires.

BULB REPLACEMENT

Lamp assembly condensation

Exterior lamps are vented to accommodate normal changes in pressure. Condensation can be a natural by-product of this design. When moist air enters the lamp assembly through the vents, there is a possibility that condensation can occur when the temperature is cold. When normal condensation occurs, a thin film of mist can form on the interior of the lens. The thin mist eventually clears and exits through the vents during normal operation. Clearing time may take as long as 48 hours under dry weather conditions.

Lights

Examples of acceptable condensation are:

- Presence of thin mist (no streaks, drip marks or droplets)
- Fine mist covers less than 50% of the lens

Examples of unacceptable moisture (usually caused by a lamp water leak) are:

- Water puddle inside the lamp
- Large water droplets, drip marks or streaks present on the interior of the lens

Take your vehicle to a dealer for service if any of the above conditions of unacceptable moisture are present.

Using the right bulbs

Replacement bulbs are specified in the chart below. Headlamp bulbs must be marked with an authorized "D.O.T." for North America to ensure lamp performance, light brightness and pattern and safe visibility. The correct bulbs will not damage the lamp assembly or void the lamp assembly warranty and will provide quality bulb burn time.

Function	Trade number
Headlamps	H13
Park and turn lamp (front)	3457 NAK or 3457AK
Side marker lamp (front)	168
Fog lamps (if equipped)	H11 LL
Stop/turn and tail lamps	3057K
Backup lamp	921
License plate lamp	C5W L
* High-mount brake lamp	LED
* To replace these lamps - see your authorized dealer.	
To replace all instrument panel lights - see your authorized dealer	

Replacing interior bulbs

Check the operation of all bulbs frequently.

Replacing exterior bulbs

Check the operation of all the bulbs frequently.

Lights

Replacing headlamp bulbs

1. Make sure the headlamp control is in the off position and open the hood.
2. Remove four push pins from the radiator grille and pull the grille forward to access the lower screw.
3. Remove three bolts and washers from the headlamp assembly.
4. Carefully pull the headlamp assembly up and away from the vehicle to disengage the hidden spring clip located on the bottom of the headlamp assembly. This may require substantial upward force.
5. Disconnect electrical connector from the bulb.
6. Remove bulb from the headlamp assembly by turning it counterclockwise, then pull it straight out.

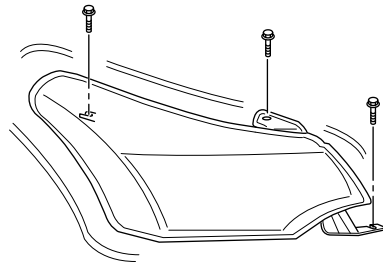

Install the new bulb in reverse order. Be sure that the spring clip is not damaged or detached from the housing during the replacement procedure.

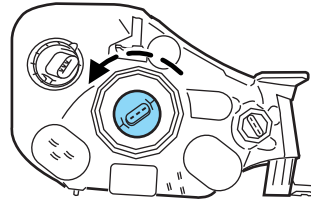

! **WARNING:** Handle a halogen headlamp bulb carefully and keep out of children's reach. Grasp the bulb by only its plastic base and do not touch the glass. The oil from your hand could cause the bulb to break the next time the headlamps are operated.

Note: If the bulb is accidentally touched, it should be cleaned with rubbing alcohol before being used.

Lights

Replacing front parking lamp/turn signal bulbs

1. Make sure the headlamp control is in the off position and open the hood.

2. Remove four push pins from the radiator grille and pull the grille forward to access the lower screw.

3. Remove three bolts and washers from the headlamp assembly.

4. Carefully pull the headlamp assembly up and away from the vehicle to disengage the hidden spring clip located on the bottom of the headlamp assembly. This may require substantial upward force.

5. Remove the bulb socket from the lamp assembly by turning counterclockwise.

6. Pull the bulb straight out of the socket.

Install the new bulb in reverse order. Be sure that the spring clip is not damaged or detached from the housing during the replacement procedure.

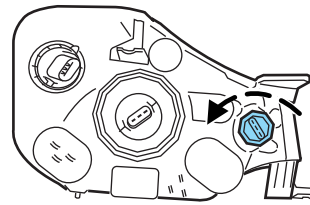
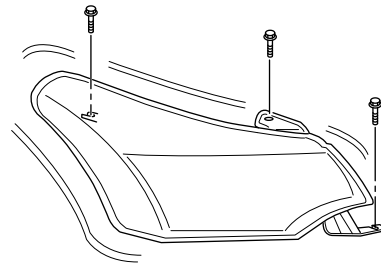

Replacing side marker bulbs

1. Make sure the headlamp control is in the off position and open the hood.

2. Remove four push pins from the radiator grille and pull the grille forward to access the lower screw.

3. Remove three bolts and washers from the headlamp assembly.

4. Carefully pull the headlamp assembly up and away from the vehicle to disengage the hidden spring clip located on the bottom of the headlamp assembly. This may require substantial upward force.

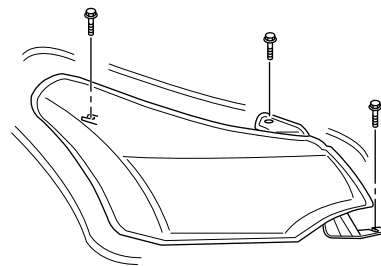

Lights

5. Remove the bulb socket from the lamp assembly by turning counterclockwise.

6. Pull the bulb straight out of the socket.

Install the new bulb in reverse order. Be sure that the spring clip is not damaged or detached from the housing during the replacement procedure.

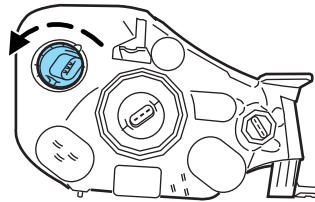

Replacing tail/brake/backup lights and turn signal bulbs

1. Make sure the headlamp control is in the off position and then open the trunk.

2. Remove two plastic screws and cover from inside the luggage compartment.

3. Remove two nuts from the lamp assembly.

4. Gently pull the lamp assembly away from the vehicle.

5. Turn the bulb socket counterclockwise and pull it out.

6. Pull the bulb straight out of the socket.

Install the new bulb in reverse order.

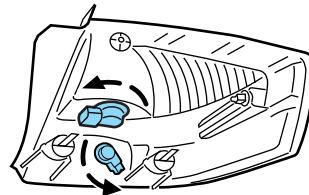

Replacing fog lamp bulbs (if equipped)

1. Make sure the headlamp switch is in the off position.

2. Reach under the front fender and remove the aeroshield. Then remove the harness/bulb assembly from the fog lamp by turning it counterclockwise.

3. Disconnect the harness from the bulb by pulling it straight out.

Install the new bulb in reverse order.

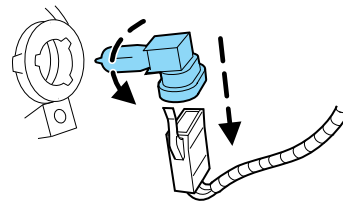

Lights

Replacing license plate lamp bulbs

1. Make sure the headlamp switch is in the off position.
2. Remove the two screws and the lens from the license plate lamp assembly.
3. Carefully pull the bulb straight out from the lamp assembly.

Install new bulb(s) in reverse order.

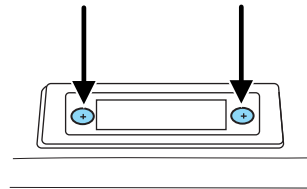

Replacing high-mount brake lamp assembly

Your vehicle is equipped with an LED center high-mount stop lamp. It is designed to last the life of the vehicle. If replacement is required, it is recommended that you see your authorized dealer.

Driver Controls

MULTI-FUNCTION LEVER

Windshield wiper: Rotate the end of the control away from you to increase the speed of the wipers; rotate towards you to decrease the speed of the wipers.

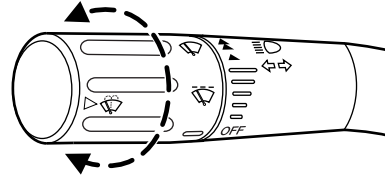

Windshield washer: Press the end of the stalk:

- briefly: causes a single swipe of the wipers without washer fluid.
- a quick press and hold: the wipers will swipe three times with washer fluid.
- a long press and hold: the wipers and washer fluid will be activated for up to ten seconds.

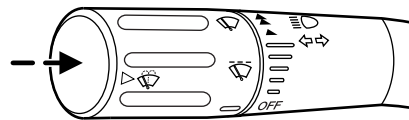

Courtesy wipe feature: One extra wipe will happen a few seconds after washing the front window to clear any water that is dripping down from the top of the windshield caused by the washing.

Note: Do not operate the washer when the washer reservoir is empty. This may cause the washer pump to overheat. Check the washer fluid level frequently. Do not operate the wipers when the windshield is dry. This may scratch the glass, damage the wiper blades and cause the wiper motor to burn out. Before operating the wiper on a dry windshield, always use the windshield washer. In freezing weather, be sure the wiper blades are not frozen to the windshield before operating the wipers.

Driver Controls

TILT STEERING WHEEL

To adjust the steering wheel:

1. Pull the lever down to unlock the steering column.
2. While the lever is in the down position, move the steering wheel up or down until you find the desired position.
3. While holding the steering wheel in place, pull the lever up to its original position to lock the steering column.

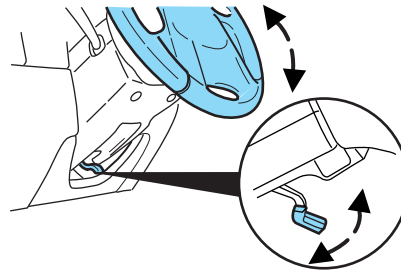

WARNING: Never adjust the steering wheel when the vehicle is moving.

ELECTRONIC COMPASS (IF EQUIPPED)

The compass heading is displayed in the center integrated display (CID).

The compass reading may be affected when you drive near large buildings, bridges, power lines and powerful broadcast antenna. Magnetic or metallic objects placed in, on or near the vehicle may also affect compass accuracy.

Usually, when something affects the compass readings, the compass will correct itself after a few days of operating your vehicle in normal conditions. If the compass still appears to be inaccurate, a manual calibration may be necessary. Refer to *Compass calibration adjustment*.

Most geographic areas (zones) have a magnetic north compass point that varies slightly from the northerly direction on maps. This variation is four degrees between adjacent zones and will become noticeable as the vehicle crosses multiple zones. A correct zone setting will eliminate this error. Refer to *Compass zone adjustment*.

Driver Controls

Compass zone adjustment

1. Determine which magnetic zone you are in for your geographic location by referring to the zone map.
2. Turn ignition to the on position.

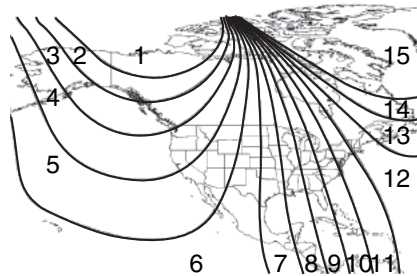

3. Press and hold the 7 and 9 radio preset buttons together for approximately five seconds until ZONE XX appears in the CID.

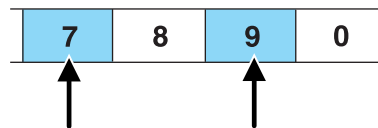

4. Press and release the 7 and 9 radio preset buttons together, repeatedly until ZONE XX changes to the correct zone (1–15) in the CID.

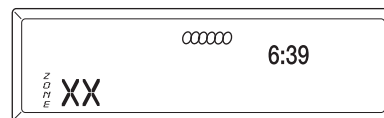

5. The direction will display after the buttons are released. The zone is now updated.

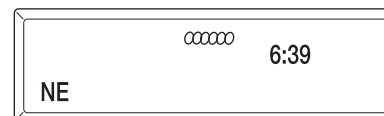

Compass calibration adjustment

Perform compass calibration in an open area free from steel structures and high voltage lines. For optimum calibration, turn off all electrical accessories (heater/air conditioning, wipers, etc.) and make sure all vehicle doors are shut.

1. Start the vehicle.

Driver Controls

2. To calibrate, press and hold the 7 and 9 radio preset buttons together for approximately 10 seconds until CAL appears. Release the buttons.

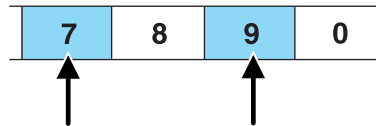

3. Slowly drive the vehicle in a circle (less than 3 mph [5 km/h]) until the CAL display changes to the direction value (N, S, E, W, etc.). It may take up to five circles to complete calibration.

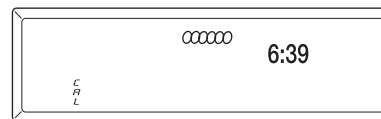

4. The compass is now calibrated.

CENTER CONSOLE

Your vehicle has a variety of console features. These include:

- Cupholders
- Utility compartment



WARNING: Use only soft cups in the cupholder. Hard objects can injure you in a collision.

AUXILIARY POWER POINT (12V DC)

Power outlet is designed for accessory plugs only. Do not insert any other object in the power outlet as this will damage the outlet and blow the fuse. Do not hang any type of accessory or accessory bracket from the plug. Improper use of the power outlet can cause damage not covered by your warranty.

The auxiliary power points are located near the bottom of the center stack.

Do not use the power point for operating the cigarette lighter element (if equipped).

To prevent the fuse from being blown, do not use the power point(s) over the vehicle capacity of 12V DC/180W. If the power point or cigar lighter socket is not working, a fuse may have blown. Refer to *Fuses and relays* in the *Roadside Emergencies* chapter for information on checking and replacing fuses.

Driver Controls

To have full capacity usage of your power point, the engine is required to be running to avoid unintentional discharge of the battery. To prevent the battery from being discharged:

- do not use the power point longer than necessary when the engine is not running,
- do not leave battery chargers, video game adapters, computers and other devices plugged in overnight or when the vehicle is parked for extended periods.

Always keep the power point caps closed when not being used.

POWER WINDOWS



WARNING: Do not leave children unattended in the vehicle and do not let children play with the power windows. They may seriously injure themselves.



WARNING: When closing the power windows, you should verify they are free of obstructions and ensure that children and/or pets are not in the proximity of the window openings.

Press and pull the window switches to open and close windows.

- Press down (to the first detent) and hold the switch to open.
- Pull up (to the first detent) and hold the switch to close.

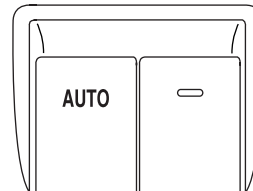

One-touch down

Allows the driver's window to open fully without holding the control down. Press the switch completely down to the second detent and release quickly. The window will open fully. Momentarily press the switch to any position to stop the window operation.

Driver Controls

Window lock (if equipped)

The window lock feature allows only the driver to operate the power windows.

To lock out all the window controls (except for the driver's) press the right side of the control. Press the left side to restore the window controls.

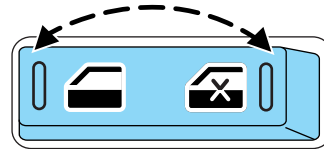

INTERIOR MIRROR

The interior rear view mirror has two pivot points on the support arm which lets you adjust the mirror up or down and from side to side.



WARNING: Do not adjust the mirror while the vehicle is in motion.

Automatic dimming interior rear view mirror (if equipped)

The interior rear view mirror has an auto-dimming function. The electronic day/night mirror will change from the normal (high reflective) state to the non-glare (darkened) state when bright lights (glare) reach the mirror. When the mirror detects bright light from behind the vehicle, it will automatically adjust (darken) to minimize glare.

The mirror will automatically return to the normal state whenever the vehicle is placed in R (Reverse) to ensure a bright clear view when backing up.

Do not block the sensors on the front and back of the interior rear view mirror since this may impair proper mirror performance.

Note: A rear center passenger and/or raised rear center headrest (if equipped) may also block the light from reaching the sensor.

Do not clean the housing or glass of any mirror with harsh abrasives, fuel or other petroleum-based cleaning products.

Driver Controls

EXTERIOR MIRRORS

Power side view mirrors (if equipped)



WARNING: Do not adjust the mirror while the vehicle is in motion.

To adjust your mirrors:

1. Rotate the control clockwise to adjust the right mirror and rotate the control counterclockwise to adjust the left mirror.
2. Move the control in the direction you wish to tilt the mirror.
3. Return to the center position to lock mirrors in place.

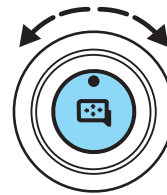

Heated outside mirrors (if equipped)

Both mirrors are heated automatically to remove ice, mist and fog when the rear window defrost is activated.

Do not remove ice from the mirrors with a scraper or attempt to readjust the mirror glass if it is frozen in place.

These actions could cause damage to the glass and mirrors.

Do not clean the housing or glass of any mirror with harsh abrasives, fuel or other petroleum-based cleaning products.

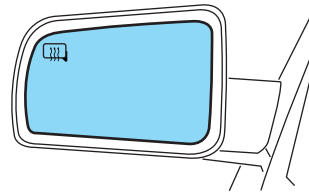

SPEED CONTROL (IF EQUIPPED)

With speed control set, you can maintain a set speed without keeping your foot on the accelerator pedal.



WARNING: Do not use the speed control in heavy traffic or on roads that are winding, slippery or unpaved.

Driver Controls

Using speed control

The speed controls are located on the steering wheel. The following buttons work with speed control:

RESUME: Press to resume a set speed.

SET +: Press to set a speed or increase a set speed.

SET -: Press to decrease a set speed.

OFF: Press to turn speed control off.

ON: Press to turn speed control on.

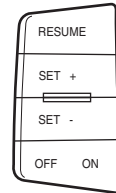

Setting speed control

To set speed control:

1. Press and release ON.
2. Accelerate to the desired speed.
3. Press and release SET +.
4. Take your foot off the accelerator pedal.
5. The indicator  light on the instrument cluster will turn on.

Note:

- Vehicle speed may vary momentarily when driving up and down a steep hill.
- If the vehicle speed increases above the set speed on a downhill, you may want to apply the brakes to reduce the speed.
- If the vehicle speed decreases more than 10 mph (16 km/h) below your set speed on an uphill, your speed control will disengage.

Disengaging speed control

To disengage the speed control, press the brake pedal or press the clutch pedal (if equipped). Disengaging the speed control will not erase previous set speed.

Note: When you use the clutch pedal to disengage the speed control, the engine speed may briefly increase; this is normal.

Resuming a set speed

Press and release RESUME. This will automatically return the vehicle to the previously set speed.

Driver Controls

Increasing speed while using speed control

To set a higher speed:

- Press and hold SET + until you get to the desired speed, then release. You can also use SET + to operate the tap-up function. Press and release SET + to increase the vehicle set speed in 1 mph (1.6 km/h) increments.
- Use the accelerator pedal to get to the desired speed, then press and release SET +.

Reducing speed while using speed control

To reduce a set speed:

- Press and hold SET – until you get to the desired speed, then release. You can also use SET – to operate the tap-down function. Press and release SET – to decrease the vehicle set speed in 1 mph (1.6 km/h) increments.
- Press the brake pedal until the desired vehicle speed is reached, then press and release SET +.

Turning off speed control

To turn off the speed control, press and release OFF or turn off the ignition.

Note: When you turn off the speed control or the ignition, your speed control set speed memory is erased.

STEERING WHEEL CONTROLS (IF EQUIPPED)

Radio control features

VOL + (Volume): Press to increase the volume.

VOL – (Volume): Press to decrease the volume.



◀◀ ▶▶ (Seek): Press to select the previous/next radio station preset, CD track or satellite radio channel preset (if equipped) depending on which media mode you are in.

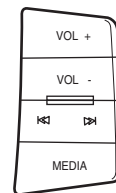

MEDIA: Press repeatedly to scroll through available audio modes.





Driver Controls

SYNC® hands free control feature (if equipped)

Press  briefly to use the voice command feature. You will hear a tone and LISTENING will appear in the radio display. Press and hold  to exit voice command.

Press  to activate phone mode or answer a phone call. Press and hold  to end call or exit phone mode.

Press   to scroll through various menus and selections. Press OK to confirm your selection.

For further information on the SYNC® system, refer to the SYNC® supplement.

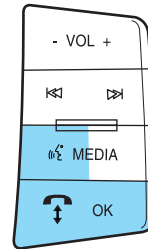

MOON ROOF (IF EQUIPPED)

You can move the glass panel of the moon roof back to open or tilt up to ventilate the vehicle.



WARNING: Do not let children play with the moon roof or leave children unattended in the vehicle. They may seriously hurt themselves.

The moon roof is equipped with an automatic, one-touch, express opening and closing feature. To stop motion at any time during the one-touch operation, press the control a second time.

Note: The moon roof will open to the “**comfort**” position first before opening all the way. The “comfort” position helps to alleviate rumbling wind noise which may happen in the vehicle with the roof fully opened.

Driver Controls

To open the moon roof: Press and release the SLIDE control. The moon roof will open to the “comfort” position. Press and release the control again to fully open. Press the switch again to stop the moon roof.

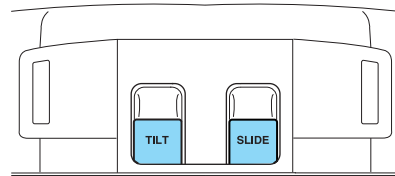

WARNING: When closing the moon roof, you should verify that it is free of obstructions and ensure that children and/or pets are not in the proximity of the moon roof opening.

To close the moon roof: Pull and release the SLIDE control, the moon roof will close automatically. Press the switch again to stop the moon roof.

Bounce-back: When an obstacle has been detected in the moon roof opening as the moon roof is closing, the moon roof will automatically open and stop at a prescribed position.

Bounce-back override: To override bounce-back function, pull and hold the SLIDE switch within two seconds of a bounce-back event. The closing force will begin to increase each time the moon roof is closed for the first three closing cycles, with bounce-back active. For example: Bounce-back can be used to overcome the resistance of ice on the moon roof or seals

To vent the moon roof: Press and release the TILT control, the moon roof will move to the vent position automatically. Press the switch again to stop the moon roof. Pull and hold the TILT control to close the moon roof.

The moon roof has a built-in sliding shade that can be manually opened or closed when the glass panel is shut. To close the shade, pull it toward the front of the vehicle.

Relearning function: In case the moon roof does not close properly anymore, follow this relearning procedure.

- Tilt the moon roof into the vent position as far as possible. Release the switch.
- Press and hold the same switch again for 30 seconds until you see the moon roof move.

66

Driver Controls

- Release the switch and immediately press and hold it again. The moon roof will close, open fully and then close again. Do not release the switch before the moon roof has reached the closed position for the second time.

Safety mode: If the system detects a malfunction, it enters a safety mode. The moon roof will move about 0.5 seconds at a time and then stop again. Press the switch repeatedly until the moon roof is closed. Have the system checked by your authorized dealer immediately.

POSITIVE RETENTION FLOOR MAT

 **WARNING:** Do not install additional floor mats on top of the factory installed floor mats as they may interfere with the accelerator or the brake pedals.

Position the floor mat so that the eyelet is over the retention post and press down to lock in. Make sure that the mat does not interfere with the operation of the accelerator or the brake pedal. To remove the floor mat, reverse the installation procedure.

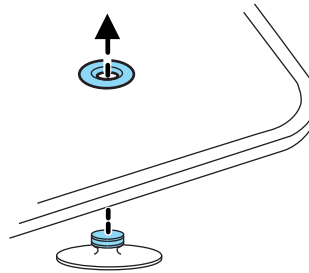

INTERIOR TRUNK CONTROL

To open the trunk, press the control on the driver's side kick panel, located below the instrument panel.

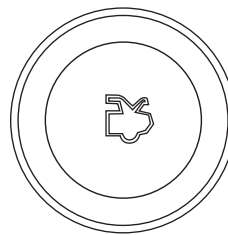

Locks and Security

KEYS

One key operates all the locks and starts the vehicle. Always carry a spare key with you in case of an emergency.

Your keys are programmed to your vehicle; using a non-programmed key will not permit your vehicle to start. If you lose your authorized dealer supplied keys, replacement keys are available through your authorized dealer. Refer to the *SecuriLock® passive anti-theft system* section later in this chapter for more information.

MYKEY™

The MyKey™ feature allows you to program a restricted driving mode to promote good driving habits. All but one of the keys programmed to the vehicle can be activated as a MyKey™. The key will remain restricted until MyKey™ is cleared. Any remaining keys are referred to as an “administrator key” or admin key. The admin key can be used to create a MyKey™, program optional MyKey™ settings, and clear the MyKey™ feature. When the MyKey™ feature is enabled the user can use system check in the message center to see how many MyKeys™ and admin keys are programmed to the vehicle, and see the total distance the vehicle has been driven with the MyKey™ active.

MyKey™ restricted features

Standard settings – these settings cannot be changed

- Belt-Minder cannot be disabled. The audio system will be muted whenever Belt-Minder® is activated until the safety belts are buckled. Refer to the *Seating and Safety Restraints* chapter for a detailed description of Belt-Minder® operation.
- Low fuel warnings are displayed in the message center followed by a chime when the distance to empty value reaches 75 miles (120 km).
- The following systems, if equipped, cannot be turned off: reverse sensing system, Blind Spot Information System (BLIS®) with cross traffic alert and collision warning system.

Optional settings – these settings can be changed

- Vehicle speed is limited to 80 mph (130 km/h). Visual warnings are displayed followed by a chime when the vehicle speed has reached 80 mph (130 km/h).
- Visual warnings are displayed followed by a chime when a preselected vehicle speed of 45, 55 or 65 mph (75, 90, or 105 km/h) is exceeded.
- The maximum volume of the audio system is limited to 45%. MYKEY VOLUME LIMITED will be displayed in the audio system display when attempting to exceed the limited volume.

68

Locks and Security

- The AdvanceTrac® system cannot be turned off. When this optional setting is on, the MyKey™ user will not be able to deactivate the system. **Note:** It may be beneficial to deactivate the AdvanceTrac® system if the vehicle is stuck in snow, mud or sand.

Create a MyKey™

To program MyKey™ on one of the keys programmed to the vehicle, insert the key that you want to make a MyKey™ into the ignition. For vehicles equipped with push button start, put the intelligent access key in the backup slot; see the *Driving* chapter for the location of the backup slot. Turn the ignition on. Use the message center buttons to do the following:

1. Press SETUP until PRESS RESET TO CREATE MYKEY is displayed.
2. Press and release the RESET button. HOLD RESET TO CONFIRM MYKEY will be displayed.
3. Press and hold the RESET button for two seconds until MARK THIS AS RESTRICTED is displayed.
4. Wait until KEY RESTRICTED AT NEXT START is displayed.

MyKey™ is successfully programmed. Make sure you label it so you can distinguish it from the admin keys. **Note:** To program the optional settings go to Step 2 in the *Programming MyKey™ Optional Settings* section. If your vehicle is equipped with remote start, see the *Using MyKey™ with Remote Start Systems* section.

Note: The MyKey™ can be cleared within the same key cycle that it was created, otherwise a standard key (administrator key) is required to clear the MyKey™ programming. To clear all MyKeys™ go to Step 2 in the *Clear MyKey™* section.

Programming MyKey™ Optional Settings

Turn the ignition on using an admin key. To program the optional settings, use the message center buttons to do the following:

1. Press SETUP until RESET FOR MYKEY SETTINGS is displayed.
2. Press and release the RESET button to display MyKey setup menus.

The first menu shown is:

MYKEY MAX MPH <80 MPH> OFF

3. If you don't want to change the maximum speed setting, press the SETUP button to display the next menu. The remaining menus appear as follows with the default settings shown:

MYKEY MPH TONES 45 55 65 <OFF>
MYKEY VOLUME LIMIT <ON> OFF
MYKEY ADVTRAC CTRL ON <OFF>.

Locks and Security

4. On any of the menus press RESET to highlight your choice with the <...>.
5. Press SETUP to enter your choice. The next optional setting will be displayed.
6. Repeat Steps 4 and 5 until you are done changing the optional settings.

Clear MyKey™

To reset all MyKeys™ as admin keys, do the following:

1. Turn the vehicle on using the admin key.
2. Press SETUP until PRESS RESET TO CLEAR MYKEY is displayed.
3. Press and release the RESET button. HOLD RESET TO CONFIRM CLEAR is displayed.
4. Press and hold the RESET button for two seconds until ALL MYKEYS CLEARED is displayed.

Check MyKey™ system status

The vehicle system check will provide the status of the following MyKey™ parameters:

- MYKEY MILES — This odometer only tracks mileage when a MyKey™ is used. If mileage does not accumulate as expected, then the MyKey™ is not being used by the intended user. The only way to reset this odometer to zero is by clearing MyKey™. If this odometer is lower than the last time you checked, then the MyKey™ system has been recently cleared.
- # MYKEY(S) PROGRAMMED — Indicates how many MyKeys™ are programmed to the vehicle. Can be used to detect deletion of a MyKey™.
- # ADMIN KEYS PROGRAMMED — Indicates how many admin keys are programmed to the vehicle. Can be used to detect if an additional spare key has been programmed to the vehicle.

Refer to *Message center* in the *Instrument Cluster* chapter for MyKey™ system warnings displays.

Using MyKey™ with remote start systems

MyKey™ is not compatible with non-Ford approved aftermarket remote start systems. If you choose to install a remote start system please see your authorized dealer for a Ford approved remote start system.

Locks and Security

Vehicles equipped with traditional keys:

When using a Ford-approved remote start system, the default settings will recognize the remote start system as an additional admin key with its associated privileges. Owners of vehicles equipped with traditional keys should program the remote start system as a MyKey™ in addition to the key that they have already programmed as a MyKey™. To program the remote start system as MyKey™, do the following:

1. Enter the vehicle and close all doors.
2. Remote start the vehicle using a remote start fob.
3. Follow Steps 1-4 in the *Create a MyKey™* section.

Vehicles equipped with an intelligent access key (push button start)

- It is not possible to program the remote start system as a MyKey™ on vehicles equipped with intelligent access key (push button start). Therefore, you should treat the remote start fob as you would any other admin key. When the vehicle is started using remote start, the system will stall the engine when you either enter the vehicle or shift the vehicle into gear. Prior to the engine stall, the vehicle will have administrative privileges. When you restart the engine, the vehicle will identify the user as an admin or MyKey™ driver depending on the settings of the actual key used to start the vehicle.

Note: For all vehicles, the number of MYKEY(S) PROGRAMMED or ADMIN KEYS PROGRAMMED that is displayed in the MyKey™ system status menus will include the remote start system as an additional key in the total count. See the *Check MyKey™ system status* section.

Note: For all vehicles with remote start installed, it is possible to program all 'real' keys as MyKeys™, in which case, you will need to use your remote start system to reset all MyKeys™ as admin keys by doing the following:

1. Enter the vehicle, close all doors.
2. Remote start the vehicle using your remote start fob.
3. Follow Steps 1-4 in the *Clear MyKey™* section.

Locks and Security



Troubleshooting

Condition	Potential Causes
Can't create a MyKey™	<ul style="list-style-type: none"> • Key in the ignition is already a MyKey™. • Key in the ignition is the last remaining admin key (there always has to be at least one admin key). • Intelligent access key (if equipped) not in the backup slot — for vehicles with push button start. • SecuriLock® Passive Anti-Theft System is disabled or in unlimited mode • Vehicle has been started using a remote start system that is programmed as MyKey™. Refer to <i>Using MyKey™ with remote start systems</i> section.
Cannot program the MyKey™ optional settings	<ul style="list-style-type: none"> • Key in the ignition is a MyKey™ • No MyKeys™ are programmed to the vehicle. Refer to <i>Create a MyKey™</i> section • Vehicle has been started using a remote start system that is programmed as a MyKey™. Refer to <i>Using MyKey™ with remote start systems</i> section.
Cannot clear MyKey™	<ul style="list-style-type: none"> • Key in the ignition is a MyKey™ • No MyKeys™ are programmed to the vehicle. Refer to <i>Create a MyKey™</i> section • Vehicle has been started using a remote start system that is programmed as a MyKey™. Refer to <i>MyKey™ with remote start systems</i> section.
Lost the only admin key	<ul style="list-style-type: none"> • Purchase a new key from your authorized dealer
Lost any key	<ul style="list-style-type: none"> • For programming spare keys, refer to the <i>Programming spare keys</i> section in this chapter.
I accidentally programmed all keys as MyKeys™	<ul style="list-style-type: none"> • Vehicle has a remote start system that is recognized as an admin key. Refer to the <i>Using MyKey™ with remote start systems</i> section to reset all MyKeys™ as admin keys.

Locks and Security

Condition	Potential Causes
No MyKey™ function with intelligent access key (push button start) (if equipped)	<ul style="list-style-type: none"> • An admin key is present at vehicle start • No MyKeys™ are programmed to the vehicle. Refer to <i>Create a MyKey™</i> section
MyKey™ programmed total includes one additional key	<ul style="list-style-type: none"> • Unknown key has been programmed to the vehicle as a MyKey™. • Vehicle is equipped with a remote start system. Refer to <i>Using MyKey™ with remote start systems</i> section.
Admin keys programmed total includes one additional key	<ul style="list-style-type: none"> • Unknown key has been programmed to the vehicle as admin key. • Vehicle is equipped with a remote start system. Refer to <i>Using MyKey™ with remote start systems</i> section.
MyKey™ miles do not accumulate	<ul style="list-style-type: none"> • MyKey™ is not being used by the intended user. • MyKey™ system has been recently cleared.

POWER DOOR LOCKS

- Press the  control to unlock all doors.
- Press the  control to lock all doors.

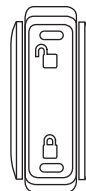

Smart locks

This feature helps to prevent you from locking yourself out of the vehicle if your key is still in the ignition.

When you open one of the front doors and you lock the vehicle with the power door lock control (on the driver or passenger door trim panel), all the doors will lock, then all doors will automatically unlock reminding you that your key is still in the ignition.

Locks and Security

The vehicle can still be locked, with the key in the ignition, by locking the driver's door with a key or using the lock control on the remote entry key fob.

If both front doors are closed, the vehicle can be locked from any method, regardless of whether the key is in the ignition or not.

Autolock (if equipped)

The autolock feature will lock all the doors when:

- all doors are closed,
- the ignition is on,
- you shift into any gear putting the vehicle in motion, and
- the vehicle attains a speed greater than 12 mph (20 km/h).

The autolock feature repeats when:

- any door is opened then closed while the ignition is on and the vehicle speed is 9 mph (15 km/h) or lower, and
- the vehicle attains a speed greater than 12 mph (20 km/h).

Deactivating/activating autolock

Your vehicle comes with the autolock feature enabled. There are three methods to enable/disable this feature:

- Through your authorized dealer, or
- Performing the power door lock control procedure, or
- Performing the message center (if equipped) procedure. Refer to *Message center* in the *Instrument Cluster* chapter.



Note: The autolock feature can be activated/deactivated independently of the autounlock feature.

Before following the activation or deactivation procedures, make sure that the anti-theft system is not armed, ignition is in the off position, and all vehicle doors are closed.

Locks and Security

Power door unlock/lock procedure

Before starting, ensure the ignition is in the off position and all vehicle doors are closed. You must complete Steps 1–5 within 30 seconds or the procedure will have to be repeated. If the procedure needs to be repeated, wait a minimum of 30 seconds before beginning again.

1. Place the key in the ignition and turn the ignition to the on position.
2. Press the power door  control on the door panel three times.
3. Turn the ignition from the on position to the off position.
4. Press the power door  control on the door panel three times.
5. Turn the ignition back to the on position. The horn will chirp one time to confirm programming mode has been entered and is active.
6. To enable/disable the autolock feature, press the unlock control, then press the lock control. The horn will chirp once if autolock was deactivated or twice (one short and one long chirp) if autolock was activated.
7. Turn the ignition to the off position. The horn will chirp once to confirm the procedure is complete.

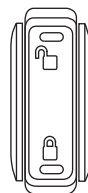

Autounlock feature (if equipped)

The autounlock feature will unlock all the doors when:

- the ignition is in the on position, all the doors are closed, and the vehicle has been in motion at a speed greater than 12 mph (20 km/h);
- the vehicle has then come to a stop and the ignition is turned to the off or accessory position; and
- the driver door is opened within 10 minutes of the ignition being transitioned to the off or accessory position.

Note: The doors will not autounlock if the vehicle has been electronically locked before the driver door is opened.

Locks and Security

Deactivating/activating autounlock feature



Your vehicle comes with the autounlock features activated; there are three methods to enable/disable this feature:

- Through your authorized dealer,
- by using a power door unlock/lock sequence
- or by using the instrument cluster message center. Refer to *Message center* in the *Instrument Cluster* chapter.

Note: The autounlock feature can be activated/deactivated independently of the autolock feature.

Power door lock switch autounlock enable/disable procedure

Before starting, ensure the ignition is in the off position and all vehicle doors are closed. You must complete Steps 1–5 within 30 seconds or the procedure will have to be repeated. If the procedure needs to be repeated, wait a minimum of 30 seconds before beginning again.

1. Place the key in the ignition and turn the ignition to the on position.
2. Press the power door  control on the door panel three times.
3. Turn the ignition from the on position to the off position.
4. Press the power door  control on the door panel three times.
5. Turn the ignition back to the on position. The horn will chirp one time to confirm programming mode has been entered and is active.
6. To enable/disable the autounlock feature, press the lock control, then press the unlock control. The horn will chirp once if autounlock was deactivated or twice (one short and one long chirp) if autounlock was activated.
7. Turn the ignition to the off position. The horn will chirp once to confirm the procedure is complete.

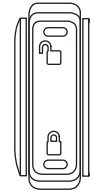

Locks and Security

CHILDPROOF DOOR LOCKS

- When these locks are set, the rear doors cannot be opened from the inside.
- The rear doors can be opened from the outside when the childproof door locks are set, but the doors are unlocked.

The childproof locks are located on the rear edge of each rear door and must be set separately for each door. Setting the lock for one door will not automatically set the lock for both doors.

- Insert the key and turn to the lock position (key horizontal) to engage the childproof locks.
- Insert the key and turn to the unlock position (key vertical) to disengage the childproof locks.

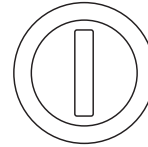
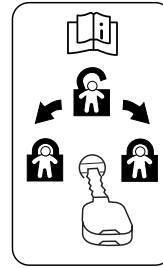

INTERIOR LUGGAGE COMPARTMENT RELEASE

Your vehicle is equipped with a mechanical interior luggage compartment release handle that provides a means of escape for children and adults in the event they become locked inside the luggage compartment.

Adults are advised to familiarize themselves with the operation and location of the release handle.

Locks and Security

To open the luggage compartment door (lid) from within the luggage compartment, pull the illuminated “T” shaped handle and push up on the trunk lid. The handle is composed of a material that will glow for hours in darkness following brief exposure to ambient light.

The “T” shaped handle will be located either on the luggage compartment door (lid) or inside the luggage compartment near the tail lamps.

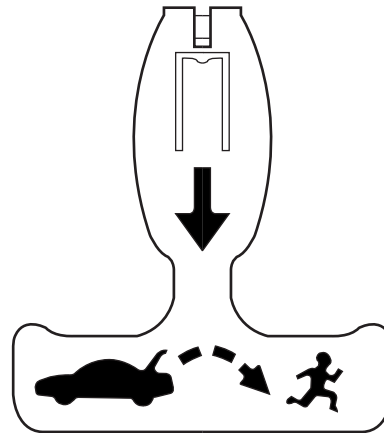

WARNING: Keep vehicle doors and luggage compartment locked and keep keys and remote transmitters out of a child's reach. Unsupervised children could lock themselves in the trunk and risk injury. Children should be taught not to play in vehicles.

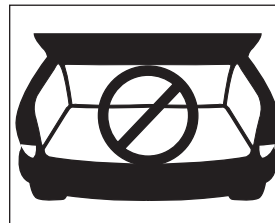

WARNING: Do not leave children, unreliable adults, or animals unattended in the vehicle. On hot days, the temperature in the trunk or vehicle interior can rise very quickly. Exposure of people or animals to these high temperatures for even a short time can cause death or serious heat-related injuries, including brain damage. Small children are particularly at risk.

Locks and Security

REMOTE ENTRY SYSTEM

This device complies with part 15 of the FCC rules and with RSS-210 of Industry Canada. Operation is subject to the following two conditions: (1) This device may not cause harmful interference, and (2) This device must accept any interference received, including interference that may cause undesired operation.

Changes or modifications not expressly approved by the party responsible for compliance could void the user's authority to operate the equipment.

The typical operating range for your remote entry transmitter is approximately 33 feet (10 meters). A decrease in operating range could be caused by:

- weather conditions,
- nearby radio towers,
- structures around the vehicle, or
- other vehicles parked next to your vehicle.

Your vehicle may have an all-door remote entry system.

The all-door remote entry system allows you to:

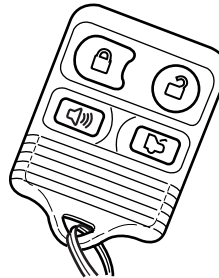

- lock or unlock all vehicle doors without a key.
- open the luggage compartment without a key.
- activate the panic alarm.



The remote entry lock/unlock feature operates in any ignition position except start. The panic feature operates with the key in the off position.

If there are problems with the remote entry system, make sure to take **ALL remote entry transmitters** with you to the authorized dealer in order to aid in troubleshooting the problem.

Unlocking the doors





1. Press  and release to unlock the driver's door. **Note:** The interior lamps and parking lamps will illuminate.
2. With the all-door remote entry, press  and release again within three seconds to unlock all the doors.

Locks and Security



The remote entry system activates the illuminated entry feature. This feature turns on the lamps for 25 seconds or until the ignition is turned to the on position. The dome lamp control must be set to the **ON** position in order for the illuminated entry feature to operate.

Programming unlocking mode (if equipped)

The unlocking mode on the remote entry transmitter can be programmed. To change the unlocking mode from the single-door unlocking mode to the central all-door unlocking mode:

- With the vehicle in the off position, press  and  on the remote entry transmitter simultaneously and hold for four seconds. The turn lamps will illuminate twice to indicate the mode change.
- Press the  and  on the remote entry transmitter simultaneously and hold for four seconds to switch between unlocking modes.

Locking the doors

- Press  and release to lock all doors. **Note:** The parking lamps will illuminate. If any door or trunk is ajar, the lamps will not illuminate. Once the door that was ajar is closed, the lamps will illuminate to indicate that the vehicle is locked and all doors are closed.
- Press  and release again within three seconds to confirm all doors have locked. **Note:** The horn will honk once and the turn lamps will illuminate if all doors are closed. The horn will honk twice if any door is ajar.

Car finder

Press  twice within three seconds. The horn will chirp and the turn lamps will flash. It is recommended that this method be used to locate your vehicle, rather than using the panic alarm.

Sounding a panic alarm

Press  to activate the alarm. Press again or turn the ignition to the on or accessory position to deactivate, or wait for the alarm to time out in three minutes.

Note: The panic alarm will only operate when the ignition is in the off position.

Opening the luggage compartment

Press  once to open the luggage compartment. **Note:** This feature will only operate with the ignition in the off or the accessory position.

80

Locks and Security

- Ensure that the trunk is closed and latched before driving your vehicle. Failure to properly latch the trunk may cause objects to fall out or block the driver's rear view.

Replacing the battery

The remote entry transmitter uses one coin type three-volt lithium battery CR2032 or equivalent.

To replace the battery:

1. Twist a thin coin between the two halves of the remote entry transmitter near the key ring. **DO NOT TAKE THE RUBBER COVER AND CIRCUIT BOARD OFF THE FRONT HOUSING OF THE REMOTE ENTRY TRANSMITTER.**

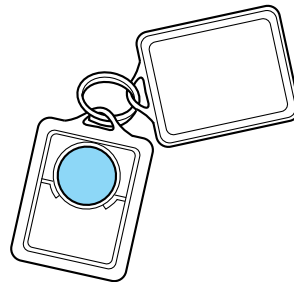

2. Do not wipe off any grease on the battery terminals on the back surface of the circuit board.
3. Remove the old battery.

Note: Please refer to local regulations when disposing of transmitter batteries.

4. Insert the new battery. Refer to the diagram inside the remote entry transmitter for the correct orientation of the battery. Press the battery down to ensure that the battery is fully seated in the battery housing cavity.
5. Snap the two halves back together.

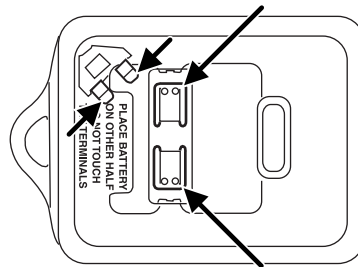

Note: Replacement of the battery will **not** cause the remote transmitter to become deprogrammed from your vehicle. The remote transmitter should operate normally after battery replacement.

Replacing lost remote entry transmitters

If you would like to have your remote entry transmitter reprogrammed because you lost one, or would like to buy additional remote entry transmitters, you can either reprogram them yourself, or take **all remote entry transmitters** to your authorized dealer for reprogramming.

Locks and Security

How to reprogram your remote entry transmitters

You must have **all remote entry transmitters** (maximum of four) available before beginning this procedure. If all remote entry transmitters are not present during the programming procedure, the transmitters that are not present during programming will no longer operate the vehicle.

Note: Ensure the brake pedal is not pressed during this sequence.

To reprogram the remote entry transmitters:

1. Ensure the vehicle is electronically unlocked.
2. Put the key in the ignition.
3. Turn the key from the 1 (off) position to 3 (on).
4. Cycle eight times rapidly (within 10 seconds) between the 1 (off) position and 3 (on).

Note: The eighth turn must end in the 3 (on) position.

5. The doors will lock, then unlock, to confirm that the programming mode has been activated.
6. Within 20 seconds press any button on the remote entry transmitter.
Note: If more than 20 seconds have passed you will need to start the procedure over again.
7. The doors will lock, then unlock, to confirm that this remote entry transmitter has been programmed.
8. Repeat Step 6 to program each additional remote entry transmitter.
9. Turn the ignition to the 1 (off) position after you have finished programming all of the remote entry transmitters.
10. The doors will lock, then unlock, to confirm that the programming mode has been exited.

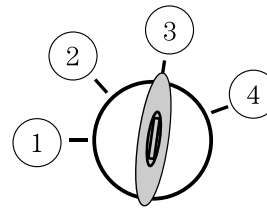

Illuminated entry

The interior lamps and parking lamps illuminate when the remote entry system is used to unlock the door(s).

The illuminated entry system will turn off the lights if:

- the ignition is turned to the on position,
- the remote transmitter lock control is pressed, or
- after 25 seconds of illumination.

82

Locks and Security

The lights will not turn off if:

- they have been turned on with the dimmer control, or
- any door is open.

Illuminated exit

- When all vehicle doors and the trunk are closed, and the key is removed from the ignition, the interior lamps and parking lamps will illuminate.

The lamps will turn off if all the doors and the trunk remain closed and

- 25 seconds elapse, or
- the key is inserted in the ignition.

Battery saver

The battery saver will shut off the lamps 30 minutes after the ignition has been turned to the 1 (off) position.

- If the dome lamps were turned on using the panel dimmer control, the battery saver will shut them off 30 minutes after the ignition has been turned to the 1 (off) position.
- If the courtesy lamps were turned on because one of the vehicle doors was opened, the battery saver will shut them off 10 minutes after the ignition has been turned to the 1 (off) position.
- The battery saver will shut off the headlamps and fog lamps 10 minutes after the ignition has been turned to the 1 (off) position.

SECURILOCK® PASSIVE ANTI-THEFT SYSTEM

SecuriLock® passive anti-theft system is an engine immobilization system. This system is designed to help prevent the engine from being started unless a **coded key programmed to your vehicle** is used. The use of the wrong type of coded key may lead to a “no-start” condition.

Your vehicle comes with two coded keys; additional coded keys may be purchased from your authorized dealer. The authorized dealer can program your spare keys to your vehicle or you can program the keys yourself. Refer to *Programming spare keys* for instructions on how to program the coded key.

Note: The SecuriLock® passive anti-theft system is not compatible with non-Ford aftermarket remote start systems. Use of these systems may result in vehicle starting problems and a loss of security protection.

Locks and Security

Note: Large metallic objects, electronic devices that are used to purchase gasoline or similar items, or a second coded key on the same key chain may cause vehicle starting issues. You need to prevent these objects from touching the coded key while starting the engine. These objects will not cause damage to the coded key, but may cause a momentary issue if they are too close to the key when starting the engine. If a problem occurs, turn the ignition off, remove all objects on the key chain away from the coded key and restart the engine.

Note: Do not leave a duplicate coded key in the vehicle. Always take your keys and lock all doors when leaving the vehicle.

Anti-theft indicator

The anti-theft indicator is located in the instrument cluster.

- When the ignition is in the off position, the indicator will flash once every two seconds to indicate the SecuriLock® system is functioning as a theft deterrent.
- When the ignition is in the on position, the indicator will glow for three seconds, then turn off, to indicate normal system functionality.



If a problem occurs with the SecuriLock® system, the indicator will flash rapidly or glow steadily when the ignition is in the on position. If this occurs, turn the ignition off then back to on to make sure there was no electronic interference with the programmed key. If the vehicle doesn't start, try to start it with the 2nd programmed key and if successful contact your authorized dealership for key replacement. If the indicator still flashes rapidly or glows steadily, and the vehicle will not start, contact your authorized dealer as soon as possible for service.

Replacement keys

If your keys are lost or stolen and you don't have an extra coded key, you will need to have your vehicle towed to an authorized dealer. The key codes need to be erased from your vehicle and new coded keys will need to be programmed.

Replacing coded keys can be very costly. Store an extra programmed key away from the vehicle in a safe place to help prevent any inconveniences. Please visit an authorized dealer to purchase additional spare or replacement keys.

84

Locks and Security

Programming spare keys

You can program your own coded keys to your vehicle. Please read and understand the entire procedure before you begin.

Tips:

- A maximum of eight keys can be coded to your vehicle.
- Only use SecuriLock® keys.
- You must have two previously programmed coded keys (keys that already operate your vehicle's engine) and the new unprogrammed key(s) readily accessible.
- If two previously programmed coded keys are not available, you must take your vehicle to your authorized dealer to have the spare key(s) programmed.

1. Insert a previously programmed coded key into the ignition.
2. Turn the ignition from the 1 (off) position to the 3 (on) position. Keep the ignition in the 3 (on) position for at least one second, but no more than 10 seconds.

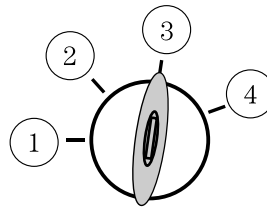

3. Turn the ignition to the 1 (off) position.
4. Remove the previously programmed coded key from the ignition.
5. After three seconds but within 10 seconds of removing the previously programmed coded key, insert the other previously programmed coded key into the ignition.
6. Turn the ignition from the 1 (off) position to the 3 (on) position. Keep the ignition in the 3 (on) position for at least one second but not more than 10 seconds.
7. Turn the ignition to the 1 (off) position.
8. Remove the previously programmed coded key from the ignition.
9. After three seconds but within twenty seconds of removing the previously programmed coded key, insert the unprogrammed key (new/valet key) into the ignition.

Locks and Security

10. Turn the ignition from the 1 (off) position to the 3 (on) position. Keep the ignition in the 3 (on) position for at least one second, but no more than 10 seconds.

11. Your new, unprogrammed key is now programmed.

If the key has been successfully programmed it will start the vehicle's engine and the theft indicator light will illuminate for three seconds and then go out.

If the key was not successfully programmed, it will not start your vehicle's engine and the theft indicator light will flash on and off, or stay on for more than three seconds. If failure repeats, bring your vehicle to your authorized dealer to have the new key(s) programmed.

To program additional new unprogrammed key(s), repeat this procedure from Step 1 for each additional key.

Note: To program MyKey features, refer to *MyKey* in this chapter.

PERIMETER ALARM SYSTEM (IF EQUIPPED)

The perimeter anti-theft system will warn you in the event of an unauthorized entry to your vehicle.

If there is any potential perimeter anti-theft problem with your vehicle, ensure **ALL remote entry transmitters** are taken to the authorized dealer to aid in troubleshooting.

Arming the system

When armed, this system will respond if unauthorized entry is attempted. When unauthorized entry occurs, the system will flash the park/turn lamps and will sound the horn.

The system is ready to arm whenever the key is removed from the ignition. Either of the following actions will prearm the alarm system:

- Press the lock control on the remote entry transmitter.
- Open a door and press the power door lock control to lock all the doors, and then close the door.

Locks and Security

Disarming the system

You can disarm the system by any of the following actions:

- Unlock the doors by pressing the  control on your remote entry transmitter.
- Turn the ignition to the on or start position with a programmed coded ignition key.
- Press the panic control on the remote entry transmitter. This will only shut off the horn and turn lamps when the alarm is sounding. The alarm system will still be armed.
- If using a key in the driver's door to unlock the vehicle, a chime will sound when you open the door and you will have 12 seconds to disarm the alarm system using any of the actions above, otherwise the alarm will trigger.

Pressing the power door unlock control within the 20 second prearmed mode will return the vehicle to a disarmed state.

Triggering the anti-theft system

The armed system will be triggered if any door, trunk or the hood is opened without using the key or the remote entry transmitter.

Seating and Safety Restraints

FRONT SEATING

! **WARNING:** Reclining the seatback can cause an occupant to slide under the seat's safety belt, resulting in severe personal injuries in the event of a collision.

! **WARNING:** Do not pile cargo higher than the seatbacks to reduce the risk of injury in a collision or sudden stop.

! **WARNING:** Before returning the seatback to its original position, make sure that cargo or any objects are not trapped behind the seatback. After returning the seatback to its original position, pull on the seatback to ensure that it has fully latched. An unlatched seat may become dangerous in the event of a sudden stop or collision.

First-row adjustable head restraints

Your vehicle is equipped with front row outboard head restraints that are vertically adjustable.

! **WARNING:** To minimize the risk of neck injury in the event of a crash, the driver and passenger occupants should not sit in and/or operate the vehicle, until the head restraint is placed in its proper position. The driver should never adjust the head restraint while the vehicle is in motion.

The adjustable head restraints consist of :

- a trimmed energy absorbing foam and structure (1),
- two steel stems (2),
- a guide sleeve adjust release button (3),
- and a guide sleeve unlock/remove button (4).

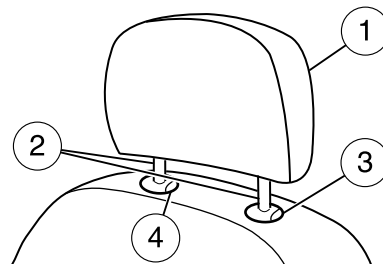

Seating and Safety Restraints

To adjust the head restraint, do the following:

1. Adjust the seatback to an upright driving/riding position.
2. Raise the head restraint by pulling up on the head restraint.

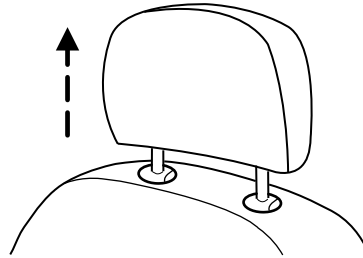

3. Lower the head restraint by pressing and holding the guide sleeve adjust release button and pushing down on the head restraint.

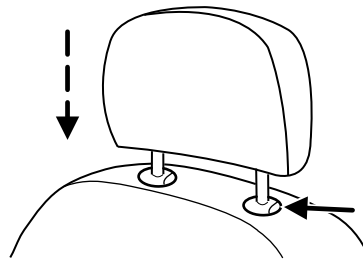

Properly adjust the head restraint so that the top of the head restraint is even with the top of your head and positioned as close as possible to the back of your head. For occupants of extremely tall stature, adjust the head restraint to its full up position.



WARNING: The adjustable head restraint is a safety device. Whenever possible it should be installed and properly adjusted when the seat is occupied.

Seating and Safety Restraints

To remove the adjustable head restraint, do the following:

1. Pull up the head restraint until it reaches the highest adjustment position.

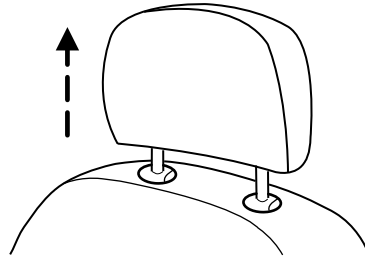

2. Simultaneously press and hold both the adjust/release button and the unlock/remove button, then pull up on the head restraint.

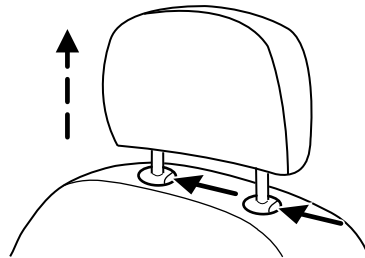

To reinstall the adjustable head restraint, do the following:

1. Insert the two stems into the guide sleeve collars.
2. Push the head restraint down until it locks.

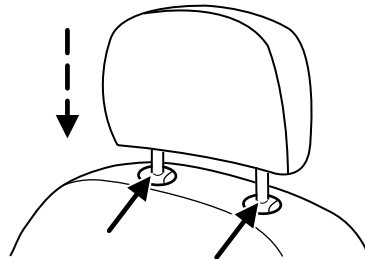

Properly adjust the head restraint so that the top of the head restraint is even with the top of your head and positioned as close as possible to the back of your head. For occupants of extremely tall stature, adjust the head restraint to its full up position.

Seating and Safety Restraints



WARNING: To minimize the risk of neck injury in the event of a crash, head restraints must be installed properly.

Adjusting the front manual seat



WARNING: Sitting improperly out of position or with the seat back reclined too far can take off weight from the seat cushion and affect the decision of the passenger sensing system, resulting in serious injury or death in a crash. Always sit upright against your seatback, with your feet on the floor.



WARNING: To reduce the risk of possible serious injury: Do not hang objects off seat back or stow objects in map pocket (if equipped) when a child is in the front passenger seat. Do not place objects underneath the front passenger seat or between the seat and the center console (if equipped). Check the “passenger airbag off” or “pass airbag off” indicator lamp for proper airbag status. Refer to *Front passenger sensing system* chapter for additional details. Failure to follow these instructions may interfere with the front passenger seat sensing system.

Pull the lever located under the front edge of the seat to move the seat forward or backward.

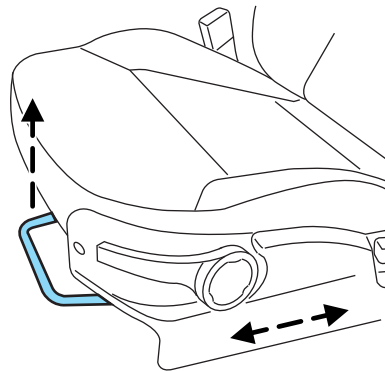

Seating and Safety Restraints

Pull up on the control to raise the seat and push down on the control to lower the seat.

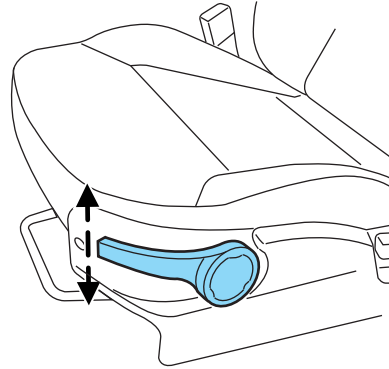

Lift the control to adjust the angle of the seatback.

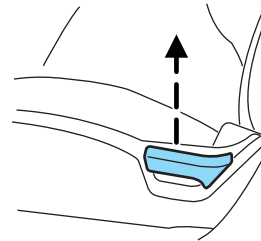

WARNING: Reclining the seatback can cause an occupant to slide under the seat's safety belt, resulting in severe personal injuries in the event of a collision.

Seating and Safety Restraints

Heated seats (if equipped)

 **WARNING:** Persons who are unable to feel pain to the skin because of advanced age, chronic illness, diabetes, spinal cord injury, medication, alcohol use, exhaustion, or other physical conditions, must exercise care when using the seat heater. The seat heater may cause burns even at low temperatures, especially if used for long periods of time. Do not place anything on the seat that insulates against heat, such as a blanket or cushion, because this may cause the seat heater to overheat. Do not puncture the seat with pins, needles, or other pointed objects because this may damage the heating element which may cause the seat heater to overheat. An overheated seat may cause serious personal injury.

Note: Do not do the following:

- Place heavy objects on the seat
- Operate the seat heater if water or any other liquid is spilled on the seat. Allow the seat to dry thoroughly.

To operate the heated seats:

- Press the button located on the instrument panel to activate.
- Press again to deactivate.

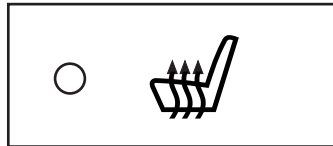

The heated seats will activate when the ignition is in the on position and the engine is running.

The system automatically shuts off after 10 minutes.

Seating and Safety Restraints

Tip/slide front passenger seat (if equipped)

Lift the control and fold the seatback forward.

The seat can be slid forward to allow easier entry to the rear seats. Slide the seat back and fold back the seatback until it locks with a distinct click. Rock the seat to ensure that the catch is securely engaged.

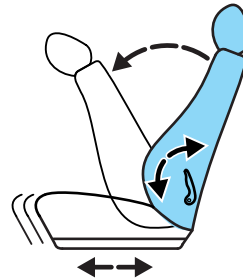

WARNING: Do not place objects behind the seat which could prevent the engagement of the seat lock.

REAR SEATS

Second row head restraints

Your vehicle is equipped with second row outboard head restraints that are vertically adjustable.



WARNING: To minimize the risk of neck injury in the event of a crash, the driver and passenger occupants should not sit in and/or operate the vehicle, until the head restraint is placed in its proper position. The driver should never adjust the head restraint while the vehicle is in motion.

The adjustable head restraints consist of :

- a trimmed energy absorbing foam and structure (1),
- two steel stems (2),
- a guide sleeve adjust release button (3),
- and a guide sleeve unlock/remove button (4).

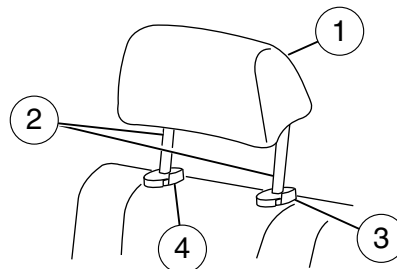

The second row head restraints function the same as the first row head restraints. For details about how to raise, lower and remove the second row head restraints, refer to *First row adjustable head restraints* at the beginning of this chapter.

94

Seating and Safety Restraints

Folding down the rear seat

One or both rear seatbacks can be folded down to provide additional cargo space.

To lower the seatback(s) from inside the vehicle, do the following:

1. Lower the head restraint (if equipped) to the lowest position.
2. Pull the strap located on the inboard side of the seatback (passenger side) or on the outboard side of the seatback (driver side) to release it.
3. Fold the seatback down.

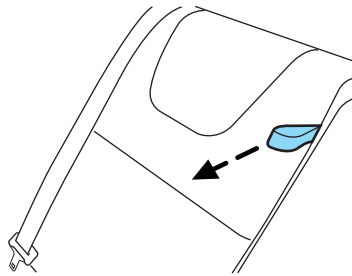

When raising the seatback(s), make sure you hear the seat latch into place.



WARNING: Before returning the seatback to its original position, make sure that cargo or any objects are not trapped behind the seatback. After returning the seatback to its original position, pull on the seatback to ensure that it has fully latched. An unlatched seat may become dangerous in the event of a sudden stop or collision.

SAFETY RESTRAINTS

Personal Safety System™

The Personal Safety System provides an improved overall level of frontal crash protection to front seat occupants and is designed to help further reduce the risk of airbag-related injuries. The system is able to analyze different occupant conditions and crash severity before activating the appropriate safety devices to help better protect a range of occupants in a variety of frontal crash situations.

Your vehicle's Personal Safety System consists of:

- Driver and passenger dual-stage airbag supplemental restraints.
- Front safety belts with pretensioners, energy management retractors, and safety belt usage sensors.

Seating and Safety Restraints

- Driver's seat position sensor.
- Front crash severity sensor.
- Front passenger sensing system
- "Passenger airbag off" or "pass airbag off" indicator lamp
- Restraints Control Module (RCM) with impact and safing sensors.
- Restraint system warning light and backup tone.
- The electrical wiring for the airbags, crash sensor(s), safety belt pretensioners, front safety belt usage sensors, driver seat position sensor, and indicator lights.

How does the Personal Safety System™ work?

The Personal Safety System can adapt the deployment strategy of your vehicle's safety devices according to crash severity and conditions. A collection of crash sensors provides information to the Restraints Control Module (RCM). During a crash, the RCM may activate the safety belt pretensioners and/or either none, one, or both stages of the dual-stage airbag supplemental restraints based on crash severity and conditions.

The fact that the pretensioners or airbags did not activate for both front seat occupants in a collision does not mean that something is wrong with the system. Rather, it means the Personal Safety System determined the accident conditions (crash severity, belt usage, etc.) were not appropriate to activate these safety devices. Front airbags are designed to activate only in frontal and near-frontal collisions, not rollovers, side-impacts, or rear-impacts unless the collision causes sufficient longitudinal deceleration.

Driver and passenger dual-stage airbag supplemental restraints

The dual-stage airbags offer the capability to tailor the level of airbag inflation energy. A lower, less forceful energy level is provided for more common, moderate-severity impacts. A higher energy level is used for the most severe impacts. Refer to *Airbag supplemental restraints (SRS)* section in this chapter.

Front crash severity sensor

The front crash severity sensor enhances the ability to detect the severity of an impact. Positioned up front, it provides valuable information early in the crash event on the severity of the impact. This allows your Personal Safety System to distinguish between different levels of crash severity and modify the deployment strategy of the dual-stage airbags and safety belt pretensioners.

96

Seating and Safety Restraints

Driver's seat position sensor

The driver's seat position sensor allows your Personal Safety System to tailor the deployment level of the driver dual-stage airbag based on seat position. The system is designed to help protect smaller drivers sitting close to the driver airbag by providing a lower airbag output level.

Front passenger sensing system

For airbags to do their job they must inflate with great force, and this force can pose a potentially deadly risk to occupants that are very close to the airbag when it begins to inflate. For some occupants, like infants in rear-facing child seats, this occurs because they are initially sitting very close to the airbag. For other occupants, this occurs when the occupant is not properly restrained by safety belts or child safety seats and they move forward during pre-crash braking. The most effective way to reduce the risk of unnecessary injuries is to make sure all occupants are properly restrained. Accident statistics suggest that children are much safer when properly restrained in the rear seating positions than in the front.



WARNING: Air bags can kill or injure a child in a child seat.

NEVER place a rear-facing child seat in front of an active air bag. If you must use a forward-facing child seat in the front seat, move the seat all the way back.



WARNING: Always transport children 12 years old and under in a rear seating position and always properly use appropriate child restraints.

The front passenger sensing system can automatically turn off the passenger front airbag. The system is designed to help protect small (child size) occupants from airbag deployments when they are improperly seated or restrained in the front passenger seat contrary to proper child-seating or restraint usage recommendations. Even with this technology, parents are **STRONGLY** encouraged to always properly restrain children in the rear seat. The sensor also turns off the airbag when the passenger seat is empty to prevent unnecessary replacement of the airbag(s) after a collision.

When the front passenger seat is occupied and the sensing system has turned off the passenger's frontal airbag, the "pass airbag off" indicator will light and stay lit to remind you that the front passenger frontal airbag is off. See *Front passenger sensing system* in the *Airbag supplemental restraints (SRS)* section of this chapter.

Seating and Safety Restraints

Front safety belt usage sensors

The front safety belt usage sensors detect whether or not the driver and front outboard passenger safety belts are fastened. This information allows your Personal Safety System to tailor the airbag deployment and safety belt pretensioner activation depending upon safety belt usage.

Front outboard safety belt pretensioners

The safety belt pretensioners at the front outboard seating positions are designed to tighten the safety belts firmly against the occupant's body during frontal collisions, and in side collisions when the side air curtain system activates. This helps increase the effectiveness of the safety belts. In frontal collisions, the safety belt pretensioners can be activated alone or, if the collision is of sufficient severity, together with the front airbags.

Front outboard safety belt energy management retractors

The front safety belt energy management retractors allow webbing to be pulled out of the retractor in a gradual and controlled manner in response to the occupant's forward momentum. This helps reduce the risk of force-related injuries to the occupant's chest by limiting the load on the occupant. Refer to the *Energy management feature* section in this chapter.

Determining if the Personal Safety System™ is operational

The Personal Safety System uses a warning light in the instrument cluster or a back-up tone to indicate the condition of the system. Refer to the *Warning lights and chimes* section in the *Instrument Cluster* chapter. Routine maintenance of the Personal Safety System is not required.

The Restraints Control Module (RCM) monitors its own internal circuits and the circuits for the airbag supplemental restraints, crash sensor(s), safety belt pretensioners, front safety belt buckle sensors, front passenger sensing system, and the driver seat position sensor. In addition, the RCM also monitors the restraints warning light in the instrument cluster. A difficulty with the system is indicated by one or more of the following.

- The warning light will either flash or stay lit.
- The warning light will not illuminate immediately after ignition is turned on.
- A series of five beeps will be heard. The tone pattern will repeat periodically until the problem and warning light are repaired.

98

Seating and Safety Restraints

If any of these things happen, even intermittently, have the Personal Safety System™ serviced at an authorized dealer immediately. Unless serviced, the system may not function properly in the event of a collision.

Safety belt precautions



WARNING: Always drive and ride with your seatback upright and the lap belt snug and low across the hips.



WARNING: To reduce the risk of injury, make sure children sit where they can be properly restrained.



WARNING: Never let a passenger hold a child on his or her lap while the vehicle is moving. The passenger cannot protect the child from injury in a collision.



WARNING: All occupants of the vehicle, including the driver, should always properly wear their safety belts, even when an air bag supplemental restraint system (SRS) is provided.



WARNING: It is extremely dangerous to ride in a cargo area, inside or outside of a vehicle. In a collision, people riding in these areas are more likely to be seriously injured or killed. Do not allow people to ride in any area of your vehicle that is not equipped with seats and safety belts. Be sure everyone in your vehicle is in a seat and using a safety belt properly.



WARNING: In a rollover crash, an unbelted person is significantly more likely to die than a person wearing a seat belt.



WARNING: Each seating position in your vehicle has a specific safety belt assembly which is made up of one buckle and one tongue that are designed to be used as a pair. 1) Use the shoulder belt on the outside shoulder only. Never wear the shoulder belt under the arm. 2) Never swing the safety belt around your neck over the inside shoulder. 3) Never use a single belt for more than one person.

Seating and Safety Restraints



WARNING: When possible, all children 12 years old and under should be properly restrained in a rear seating position.



WARNING: Front and rear seat occupants, including pregnant women, should wear safety belts for optimum protection in an accident.

Combination lap and shoulder belts

1. Insert the belt tongue into the proper buckle (the buckle closest to the direction the tongue is coming from) until you hear a snap and feel it latch. Make sure the tongue is securely fastened in the buckle.

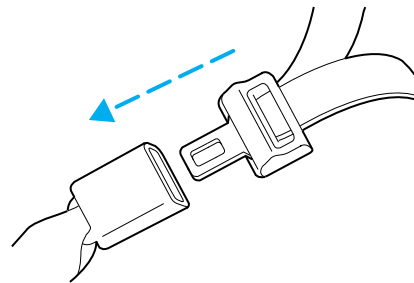

2. To unfasten, press the release button and remove the tongue from the buckle.

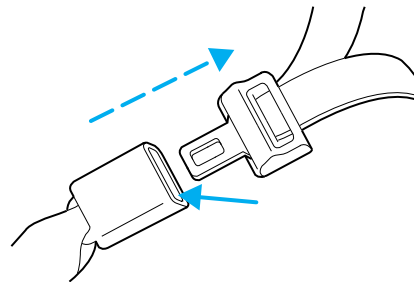

Restraint of pregnant women



WARNING: Always ride and drive with your seatback upright and the safety belt properly fastened. The lap portion of the safety belt should fit snug and be positioned low across the hips. The shoulder portion of the safety belt should be positioned across the chest. Pregnant women should also follow this practice. See figure below.

Seating and Safety Restraints

Pregnant women should always wear their safety belt. The lap belt portion of a combination lap and shoulder belt should be positioned low across the hips below the belly and worn as tight as comfort will allow. The shoulder belt should be positioned to cross the middle of the shoulder and the center of the chest.



Energy management feature

- This vehicle has a safety belt system with an energy management feature at the front outboard seating positions to help further reduce the risk of injury in the event of a head-on collision.
- This safety belt system has a retractor assembly that is designed to pay out webbing in a controlled manner. This feature is designed to help reduce the belt force acting on the occupant's chest.

Safety Belt Locking Modes

All safety restraints in the vehicle are combination lap and shoulder belts. The driver safety belt has the first locking mode and the front outboard passenger and rear seat outboard safety belts have both types of locking modes described as follows:

Vehicle sensitive mode

This is the normal retractor mode, which allows free shoulder belt length adjustment to your movements and locking in response to vehicle movement. For example, if the driver brakes suddenly or turns a corner sharply, or the vehicle receives an impact of approximately 5 mph (8 km/h) or more, the combination safety belts will lock to help reduce forward movement of the driver and passengers.

In addition, the retractor is designed to lock if the webbing is pulled out too quickly. If this occurs, let the belt retract slightly and pull webbing out again in a slow and controlled manner.

Automatic locking mode

In this mode, the shoulder belt is automatically pre-locked. The belt will still retract to remove any slack in the shoulder belt. The automatic locking mode is not available on the driver safety belt.

Seating and Safety Restraints

When to use the automatic locking mode

This mode should be used **any time** a child safety seat, except a booster, is installed in passenger front or rear seating positions. Children 12 years old and under should be properly restrained in a rear seating position whenever possible. Refer to *Safety restraints for children* or *Safety seats for children* later in this chapter.

How to use the automatic locking mode

- Buckle the combination lap and shoulder belt.

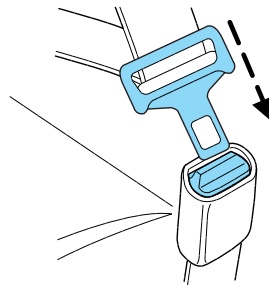

- Grasp the shoulder portion and pull downward until the entire belt is pulled out.





- Allow the belt to retract. As the belt retracts, you will hear a clicking sound. This indicates the safety belt is now in the automatic locking mode.

How to disengage the automatic locking mode

Disconnect the combination lap/shoulder belt and allow it to retract completely to disengage the automatic locking mode and activate the vehicle sensitive (emergency) locking mode.

Seating and Safety Restraints

 **WARNING:** After any vehicle collision, the safety belt system at all passenger seating positions must be checked by an authorized dealer to verify that the “automatic locking retractor” feature for child seats is still functioning properly. In addition, all safety belts should be checked for proper function.

 **WARNING:** BELT AND RETRACTOR ASSEMBLY MUST BE REPLACED if the safety belt assembly “automatic locking retractor” feature or any other safety belt function is not operating properly when checked by an authorized dealer. Failure to replace the belt and retractor assembly could increase the risk of injury in collisions.

Safety belts with locking cinch tongue (rear center position only)

The locking cinch tongue will slide up and down the belt webbing when the belt is in the stowed position or while putting safety belts on. When the locking cinch tongue of the lap/shoulder combination safety belt is latched into the buckle, the cinch tongue will allow the lap portion to become shorter, but locks the webbing in place to restrict it from becoming longer.

Before you can reach and latch a combination lap and shoulder belt having a cinch tongue into the buckle, you may have to lengthen the lap belt portion of it.

1. To lengthen the lap belt, pull some webbing out of the shoulder belt retractor.
2. While holding the webbing below the tongue, grasp the tip (metal portion) of the tongue so that it is parallel to the webbing and slide the tongue upward.

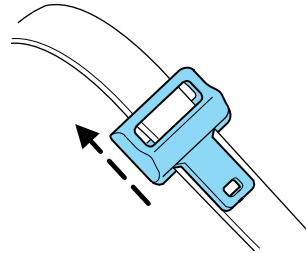

3. Provide enough lap belt length so that the tongue can reach the buckle.

How to fasten the cinch tongue

1. Pull the combination lap and shoulder belt from the retractor so that the shoulder belt portion of the safety belt crosses your shoulder and chest.

Seating and Safety Restraints

2. Be sure the belt is not twisted. If the belt is twisted, remove the twist.
3. Insert the belt tongue into the proper buckle for your seating position until you hear a snap and feel it latch.
4. Make sure the tongue is securely fastened to the buckle by pulling on the tongue.



WARNING: The lap belt should fit snugly and as low as possible around the hips, not across the waist.



WARNING: Front and rear seat occupants, including pregnant women, should wear safety belts for optimum protection in an accident.



WARNING: Each seating position in your vehicle has a specific safety belt assembly which is made up of one buckle and one tongue that are designed to be used as a pair. 1) Use the shoulder belt on the outside shoulder only. Never wear the shoulder belt under the arm. 2) Never swing the safety belt around your neck over the inside shoulder. 3) Never use a single belt for more than one person.

While you are fastened in the safety belt, the combination lap/shoulder belt with a cinch tongue adjusts to your movement. However, if you brake hard, turn hard, or if your vehicle receives an impact of 8 km/h (5 mph) or more, the safety belt will become locked and help reduce your forward movement.

Front safety belt height adjustment

Adjust the height of the shoulder belt so the belt rests across the middle of your shoulder.

To adjust the shoulder belt height, squeeze the buttons and slide the height adjuster up or down. Release the button and pull down on the height adjuster to make sure it is locked in place.

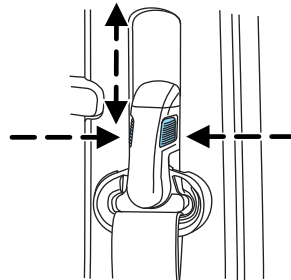

Seating and Safety Restraints



WARNING: Position the safety belt height adjusters so that the belt rests across the middle of your shoulder. Failure to adjust the safety belt properly could reduce the effectiveness of the seat belt and increase the risk of injury in a collision.

Safety belt pretensioner

Your vehicle is equipped with safety belt pretensioners at the driver and front outboard passenger seating positions.

The safety belt pretensioner tightens the safety belts firmly against the occupant's body at the start of the crash.



WARNING: The driver and front passenger safety belt system (including retractors, buckles and height adjusters) must be replaced if the vehicle is involved in a collision that results in deployment of front airbags, seat-mounted side airbags and side air curtains, and safety belt pretensioners.

Safety belt extension assembly

If the safety belt is too short when fully extended, there is an 8 inch (20 cm) safety belt extension assembly that can be added (part number 611C22). This assembly can be obtained from an authorized dealer.

Use only extensions manufactured by the same supplier as the safety belt. Manufacturer identification is located at the end of the webbing on the label. Also, use the safety belt extension only if the safety belt is too short for you when fully extended.



WARNING: Do not use extensions to change the fit of the shoulder belt across the torso.

Safety belt warning light and indicator chime

The safety belt warning light illuminates in the instrument cluster and a chime sounds to remind the occupants to fasten their safety belts.

Seating and Safety Restraints

Conditions of operation

If...	Then...
The driver's safety belt is not buckled before the ignition switch is turned to the on position...	The safety belt warning light illuminates 1-2 minutes and the warning chime sounds 4-8 seconds.
The driver's safety belt is buckled while the indicator light is illuminated and the warning chime is sounding...	The safety belt warning light and warning chime turn off.
The driver's safety belt is buckled before the ignition switch is turned to the on position...	The safety belt warning light and indicator chime remain off.

Belt-Minder®

The Belt-Minder® feature is a supplemental warning to the safety belt warning function. This feature provides additional reminders by intermittently sounding a chime and illuminating the safety belt warning light in the instrument cluster when the driver's and front passenger's safety belt is unbuckled.

The Belt-Minder® feature uses information from the front passenger sensing system to determine if a front seat passenger is present and therefore potentially in need of a warning. To avoid activating the Belt-Minder® feature for objects placed in the front passenger seat, warnings will only be given to large front seat occupants as determined by the front passenger sensing system.

Both the driver's and passenger's safety belt usages are monitored and either may activate the Belt-Minder® feature. The warnings are the same for the driver and the front passenger. If the Belt-Minder® warnings have expired (warnings for approximately five minutes) for one occupant (driver or front passenger), the other occupant can still activate the Belt-Minder® feature.

Note: If you are using MyKey™, the Belt-Minder® warning will not expire. Refer to *MyKey™* in the *Locks and Security* chapter.

Seating and Safety Restraints

If...	Then...
The driver's and front passenger's safety belts are buckled before the ignition switch is turned to the on position or less than 1-2 minutes have elapsed since the ignition switch has been turned to on...	The Belt-Minder® feature will not activate.
The driver's or front passenger's safety belt is not buckled when the vehicle has reached at least 3 mph (5 km/h) and 1-2 minutes have elapsed since the ignition switch has been turned to on...	The Belt-Minder® feature is activated - the safety belt warning light illuminates and the warning chime sounds for six seconds every 30 seconds, repeating for approximately five minutes or until the safety belts are buckled.
The driver's or front passenger's safety belt becomes unbuckled for approximately one minute while the vehicle is traveling at least 3 mph (5 km/h) and more than 1-2 minutes have elapsed since the ignition switch has been turned to on...	The Belt-Minder® feature is activated - the safety belt warning light illuminates and the warning chime sounds for six seconds every 30 seconds, repeating for approximately five minutes or until the safety belts are buckled.

Seating and Safety Restraints

The following are reasons most often given for not wearing safety belts
(All statistics based on U.S. data):

Reasons given...	Consider..
“Crashes are rare events”	36700 crashes occur every day. The more we drive, the more we are exposed to “rare” events, even for good drivers. <i>1 in 4 of us will be seriously injured in a crash during our lifetime.</i>
“I’m not going far”	3 of 4 fatal crashes occur within 25 miles (40 km) of home.
“Belts are uncomfortable”	We design our safety belts to enhance comfort. If you are uncomfortable - try different positions for the safety belt upper anchorage and seatback which should be as upright as possible; this can improve comfort.
“I was in a hurry”	Prime time for an accident. Belt-Minder® reminds us to take a few seconds to buckle up.
“Safety belts don’t work”	Safety belts , when used properly, reduce risk of death to front seat occupants by 45% in cars , and by 60% in light trucks .
“Traffic is light”	Nearly 1 of 2 deaths occur in single-vehicle crashes , many when no other vehicles are around.
“Belts wrinkle my clothes”	Possibly, but a serious crash can do much more than wrinkle your clothes, particularly if you are unbelted.
“The people I’m with don’t wear belts”	Set the example, teen deaths occur 4 times more often in vehicles with TWO or MORE people. Children and younger brothers/sisters imitate behavior they see.
“I have an airbag”	Airbags offer greater protection when used with safety belts. Frontal airbags are not designed to inflate in rear and side crashes or rollovers.
“I’d rather be thrown clear”	Not a good idea. People who are ejected are 40 times more likely to DIE . Safety belts help prevent ejection, WE CAN’T “PICK OUR CRASH”.

Seating and Safety Restraints



WARNING: Do not sit on top of a buckled safety belt or insert a latchplate into the buckle to avoid the Belt-Minder® chime. To do so may adversely affect the performance of the vehicle's airbag system.

Deactivating/activating the Belt-Minder® feature

The driver and front passenger Belt-Minder® are deactivated/activated independently. When deactivating/activating one seating position, do not buckle the other position as this will terminate the process.

Read Steps 1 - 4 thoroughly before proceeding with the deactivation/activation programming procedure.

Note: The driver and front passenger Belt-Minder® features must be disabled/enabled separately. Both cannot be disabled/enabled during the same key cycle.

Note: If you are using MyKey™, the Belt-Minder® cannot be disabled. Also, if the Belt-Minder® has been previously disabled, it will be re-enabled after the use of MyKey™. Refer to *MyKey™* in the *Locks and security* chapter.

The driver and front passenger Belt-Minder® features can be deactivated/activated by performing the following procedure:

Before following the procedure, make sure that:

- The parking brake is set
- The gearshift is in P (Park) (automatic transmission) and in neutral (manual transmission)
- The ignition switch is in the off position
- The driver and front passenger safety belts are unbuckled



WARNING: While the design allows you to deactivate your Belt-Minder®, this system is designed to improve your chances of being safely belted and surviving an accident. We recommend you leave the Belt-Minder® system activated for yourself and others who may use the vehicle. To reduce the risk of injury, do not deactivate/activate the Belt-Minder® feature while driving the vehicle.

1. Turn the ignition switch to the on position. **DO NOT START THE ENGINE.**
2. Wait until the safety belt warning light turns off (Approximately one minute).

Seating and Safety Restraints

- Step 3 must be completed within 50 seconds after the safety belt warning light turns off.
3. For the seating position being disabled, buckle then unbuckle the safety belt nine times at a moderate speed, ending in the unbuckled state.
 - After Step 3, the safety belt warning light will be turned on for three seconds.
 4. Within approximately seven seconds of the light turning off, buckle then unbuckle the safety belt.
 - This will disable the Belt-Minder® feature for that seating position if it is currently enabled. As confirmation, the safety belt warning light will flash one time per second for three seconds.
 - This will enable the Belt-Minder® feature for that seating position if it is currently disabled. As confirmation, the safety belt warning light will flash four times per second for three seconds, followed by three seconds with the light off, then followed by the safety belt warning light flashing one time per second for three seconds again.

AIRBAG SUPPLEMENTAL RESTRAINT SYSTEM (SRS)

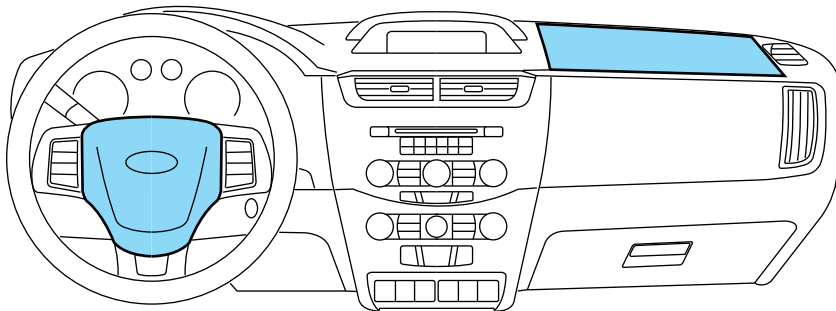

The supplemental restraint system is designed to work with the safety belt to help protect the driver and right front passenger from certain upper body injuries.



WARNING: Airbags **DO NOT** inflate slowly or gently, and the risk of injury from a deploying airbag is the greatest close to the trim covering the airbag module.

Seating and Safety Restraints

Important SRS precautions

The SRS is designed to work with the safety belt to help protect the driver and right front passenger from certain upper body injuries. Airbags DO NOT inflate slowly; there is a risk of injury from a deploying airbag.

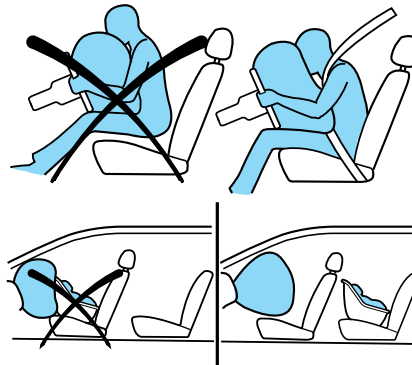

! **WARNING:** All occupants of the vehicle, including the driver, should always properly wear their safety belts, even when an air bag supplemental restraint system (SRS) is provided.

! **WARNING:** When possible, all children 12 years old and under should be properly restrained in a rear seating position.

! **WARNING:** The National Highway Traffic Safety Administration (NHTSA) recommends a minimum distance of at least 10 inches (25 cm) between an occupant's chest and the driver airbag module.

! **WARNING:** Never place your arm over the airbag module as a deploying airbag can result in serious arm fractures or other injuries.

To properly position yourself away from the airbag:

- Move your seat to the rear as far as you can while still reaching the pedals comfortably.
- Recline the seat slightly one or two degrees from the upright position.

! **WARNING:** Do not put anything on or over the airbag module. Placing objects on or over the airbag inflation area may cause those objects to be propelled by the airbag into your face and torso causing serious injury.

Seating and Safety Restraints

 **WARNING:** Do not attempt to service, repair, or modify the airbag supplemental restraint systems or its fuses. Contact your authorized dealer as soon as possible.

Children and airbags

Children must always be properly restrained. Accident statistics suggest that children are safer when properly restrained in the rear seating positions than in the front seating position. Failure to follow these instructions may increase the risk of injury in a collision.

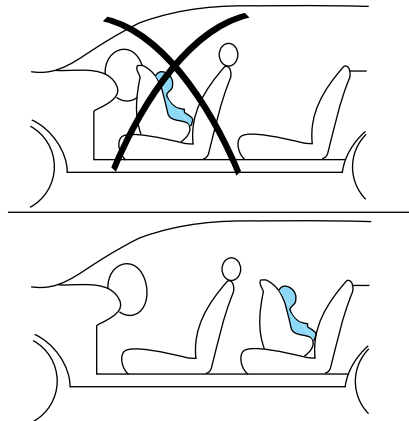

 **WARNING:** Airbags can kill or injure a child in a child seat. **NEVER** place a rear-facing child seat in front of an active airbag. If you must use a forward-facing child seat in the front seat, move the seat all the way back.

How does the airbag supplemental restraint system work?

The airbag SRS is designed to activate when the vehicle sustains longitudinal deceleration sufficient to cause the sensors to close an electrical circuit that initiates airbag inflation. The fact that the airbags did not inflate in a collision does not mean that something is wrong with the system. Rather, it means the forces were not of the type sufficient to cause activation. Front airbags are designed to inflate in frontal and near-frontal collisions, not rollover, side-impact, or rear-impacts unless the collision causes sufficient longitudinal deceleration.

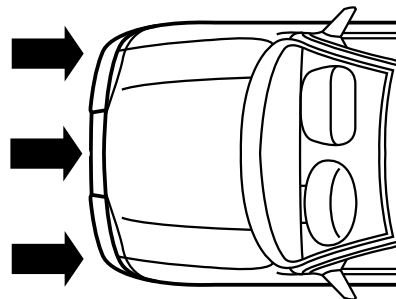

112

Seating and Safety Restraints

The airbags inflate and deflate rapidly upon activation. After airbag deployment, it is normal to notice a smoke-like, powdery residue or smell the burnt propellant. This may consist of cornstarch, talcum powder (to lubricate the bag) or sodium compounds (e.g., baking soda) that result from the combustion process that inflates the airbag. Small amounts of sodium hydroxide may be present which may irritate the skin and eyes, but none of the residue is toxic.



While the system is designed to help reduce serious injuries, contact with a deploying airbag may also cause abrasions, swelling or temporary hearing loss. Because airbags must inflate rapidly and with considerable force, there is the risk of death or serious injuries such as fractures, facial and eye injuries or internal injuries, particularly to occupants who are not properly restrained or are otherwise out of position at the time of airbag deployment. Thus, it is extremely important that occupants be properly restrained as far away from the airbag module as possible while maintaining vehicle control.



WARNING: Several air bag system components get hot after inflation. Do not touch them after inflation.



WARNING: If the air bag has deployed, **the air bag will not function again and must be replaced immediately.** If the air bag is not replaced, the unrepaired area will increase the risk of injury in a collision.

The SRS consists of:

- driver and passenger airbag modules (which include the inflators and airbags).
- side airbags. Refer to *Seat-mounted side airbag system* later in this chapter.
- side air curtain system. Refer to *Side-curtain airbag system* later in this chapter.

Seating and Safety Restraints

- safety belt pretensioners
- one or more impact and safing sensors.
- Front passenger sensing system. Refer to *Front passenger sensing system* later in this chapter.
- “Passenger airbag off” or “pass airbag off” indicator lamp. Refer to *Front passenger sensing system* later in this chapter.
- a readiness light and tone.
- diagnostic module.
- and the electrical wiring which connects the components.

The diagnostic module monitors its own internal circuits and the supplemental airbag electrical system wiring (including the impact sensors), the system wiring, the airbag system readiness light, the airbag backup power and the airbag ignitors.

Front passenger sensing system

The front passenger sensing system is designed to meet the regulatory requirements of Federal Motor Vehicle Safety Standard (FMVSS) 208 and is designed to disable (will not inflate) the front passenger’s frontal airbag under certain conditions.

The front passenger sensing system works with sensors that are part of the front passenger’s seat and safety belt. The sensors are designed to detect the presence of a properly seated occupant and determine if the front passenger’s frontal airbag should be enabled (may inflate) or disabled (will not inflate).

The front passenger sensing system will disable (will not inflate) the front passenger’s frontal airbag if:

- the front passenger seat is unoccupied, or has small/medium objects in the front seat,
- the system determines that an infant is present in a rear-facing infant seat that is installed according to the manufacturer’s instructions,
- the system determines that a small child is present in a forward-facing child restraint that is installed according to the manufacturer’s instructions,
- the system determines that a small child is present in a booster seat,
- a front passenger takes his/her weight off of the seat for a period of time,
- a child or a small person occupies the front passenger seat.

114

Seating and Safety Restraints

Note: When the passenger airbag off light is illuminated, the passenger (seat mounted) side airbag may be disabled to avoid the risk of airbag deployment injuries.

The front passenger sensing system uses a "passenger airbag off" or "pass airbag off" indicator which will illuminate and stay lit to remind you that the front passenger frontal airbag is disabled. The indicator lamp is located on the center stack area of the instrument panel.



Note: The indicator lamp will illuminate for a short period of time when the ignition is turned to the on position to confirm it is functional.

When the front passenger seat is not occupied (empty seat) or in the event that the front passenger frontal airbag is enabled (may inflate), the indicator lamp will be unlit.

The front passenger sensing system is designed to disable (will not inflate) the front passenger's frontal airbag when a rear facing infant seat, a forward-facing child restraint, or a booster seat is detected.

- When the front passenger sensing system disables (will not inflate) the front passenger frontal airbag, the indicator lamp will illuminate and stay lit to remind you that the front passenger frontal airbag is disabled.
- If the child restraint has been installed and the indicator lamp is not lit, then turn the vehicle off, remove the child restraint from the vehicle and reinstall the restraint following the child restraint manufacturer's instructions.

The front passenger sensing system is designed to enable (may inflate) the front passenger's frontal airbag anytime the system senses that a person of adult size is sitting properly in the front passenger seat.

- When the front passenger sensing system enables the front passenger frontal airbag (may inflate), the indicator will be unlit and stay unlit.

If a person of adult size is sitting in the front passenger's seat, but the "passenger airbag off" or "pass airbag off" indicator lamp is lit, it is possible that the person isn't sitting properly in the seat. If this happens:

- Turn the vehicle off and ask the person to place the seatback in the full upright position.
- Have the person sit upright in the seat, centered on the seat cushion, with the person's legs comfortably extended.

Seating and Safety Restraints

- Restart the vehicle and have the person remain in this position for about two minutes. This will allow the system to detect that person and enable the passenger's frontal airbag.
- If the indicator lamp remains lit even after this, the person should be advised to ride in the rear seat.

Occupant	Pass Airbag Off Indicator Lamp	Passenger Airbag
Empty seat	Unlit	Disabled
Small child in child safety seat or booster	Lit	Disabled
Small child with safety belt buckled or unbuckled	Lit	Disabled
Adult	Unlit	Enabled



WARNING: Even with Advanced Restraints Systems, children 12 and under should be properly restrained in a rear seating position.

After all occupants have adjusted their seats and put on safety belts, it's very important that they continue to sit properly. A properly seated occupant sits upright, leaning against the seat back, and centered on the seat cushion, with their feet comfortably extended on the floor. Sitting improperly can increase the chance of injury in a crash event. For example, if an occupant slouches, lies down, turns sideways, sits forward, leans forward or sideways, or puts one or both feet up, the chance of injury during a crash is greatly increased.



WARNING: Sitting improperly out of position or with the seat back reclined too far can take off weight from the seat cushion and affect the decision of the front passenger sensing system, resulting in serious injury or death in a crash. Always sit upright against your seatback, with your feet on the floor.

The front passenger sensing system may detect small or medium objects placed on the seat cushion. For most objects that are in the front passenger seat, the passenger airbag will be disabled. Even though the passenger airbag is disabled, the "pass airbag off" lamp may or may not be illuminated according to the table below.

116

Seating and Safety Restraints

Objects	Pass Airbag Off Indicator Lamp	Passenger Airbag
Small (i.e. three-ring binder, small purse, bottled water)	Unlit	Disabled
Medium (i.e. heavy briefcase, fully packed luggage)	Lit	Disabled
Empty seat, or small to medium object with safety belt buckled	Lit	Disabled

If you think that the status of the passenger airbag off indicator lamp is incorrect, check for the following:

- Objects lodged underneath the seat
- Objects between the seat cushion and the center console (if equipped)
- Objects hanging off the seat back
- Objects stowed in the seatback map pocket (if equipped)
- Objects placed on the occupant's lap
- Cargo interference with the seat
- Other passengers pushing or pulling on the seat
- Rear passenger feet and knees resting or pushing on the seat

The conditions listed above may cause the weight of a properly seated occupant to be incorrectly interpreted by the passenger sensing system. The person in the front passenger seat may appear heavier or lighter due to the conditions described in the list above.



WARNING: To reduce the risk of possible serious injury:

Do not stow objects in seat back map pocket (if equipped) or hang objects off seat back if a child is in the front passenger seat. Do not place objects underneath the front passenger seat or between the seat and the center console (if equipped). Check the “passenger airbag off” or “pass airbag off” indicator lamp for proper airbag Status. Failure to follow these instructions may interfere with the passenger seat sensing system.

Seating and Safety Restraints

In case there is a problem with the front passenger sensing system, the airbag readiness lamp in the instrument cluster will stay lit.



If the airbag readiness lamp is lit, do the following:

The driver and/or adult passengers should check for any objects that may be lodged underneath the front passenger seat or cargo interfering with the seat.

If objects are lodged and/or cargo is interfering with the seat; please take the following steps to remove the obstruction:

- Pull the vehicle over.
- Turn the vehicle off.
- Driver and/or adult passengers should check for any objects lodged underneath the front passenger seat or cargo interfering with the seat.
- Remove the obstruction(s) (if found).
- Restart the vehicle.
- Wait at least two minutes and verify that the airbag readiness lamp is no longer illuminated
- If the airbag readiness lamp remains illuminated, this may or may/not be a problem due to the front passenger sensing system.

DO NOT attempt to repair or service the system; take your vehicle immediately to an authorized dealer.

If it is necessary to modify an advanced front airbag system to accommodate a person with disabilities, contact the Ford Customer Relationship Center at the phone number shown in the *Customer Assistance* section of this owner's guide.



WARNING: Any alteration/modification to the front passenger seat may affect the performance of the front passenger sensing system.

Determining if the system is operational

The supplemental restraint system uses a warning indicator light in the instrument cluster or a backup tone to indicate the condition of the system. Refer to the *Warning lights and chimes* section in the *Instrument Cluster* chapter. Routine maintenance of the airbag is not required.

118

Seating and Safety Restraints

A difficulty with the system is indicated by one or more of the following:

- The readiness light (same light for front and side airbag system) will either flash or stay lit.
- The readiness light will not illuminate immediately after ignition is turned on.
- A series of five beeps will be heard. The tone pattern will repeat periodically until the problem and/or light are repaired.





If any of these things happen, even intermittently, have the supplemental restraint system serviced at an authorized dealer immediately. Unless serviced, the system may not function properly in the event of a collision.

Seat-mounted side airbag system

 **WARNING:** Do not place objects or mount equipment on or near the airbag cover on the side of the seatbacks of the front seats or in front seat areas that may come into contact with a deploying airbag. Failure to follow these instructions may increase the risk of personal injury in the event of a collision.

 **WARNING:** Do not use accessory seat covers. The use of accessory seat covers may prevent the deployment of the side airbags and increase the risk of injury in an accident.

 **WARNING:** Do not lean your head on the door. The side airbag could injure you as it deploys from the side of the seatback.

 **WARNING:** Do not attempt to service, repair, or modify the airbag SRS, its fuses or the seat cover on a seat containing an airbag. Contact your authorized dealer as soon as possible.

 **WARNING:** All occupants of the vehicle should always wear their safety belts even when an airbag SRS is provided.

Seating and Safety Restraints

How does the side airbag system work?

The design and development of the side airbag system included recommended testing procedures that were developed by a group of automotive safety experts known as the Side Airbag Technical Working Group. These recommended testing procedures help reduce the risk of injuries related to the deployment of side airbags.

The side airbag system consists of the following:

- An inflatable bag (airbag) with a gas generator concealed behind the outboard bolster of the driver and front passenger seatbacks.
- A special seat cover designed to allow airbag deployment.
- The same warning light, electronic control and diagnostic unit as used for the front airbags.
- Two pressure sensors located in the front doors.
- Two crash sensors located between the “B” and “C” pillars.

Side airbags, in combination with safety belts, can help reduce the risk of severe injuries in the event of a significant side impact collision.

The side airbags are fitted on the outboard side of the seatbacks of the front seats. In certain lateral collisions, the airbag on the side affected by the collision will be inflated. The airbag was designed to inflate between the door panel and occupant to further enhance the protection provided occupants in side impact collisions.

The airbag SRS is designed to activate when the vehicle sustains lateral deceleration sufficient to cause the sensors to close an electrical circuit that initiates airbag inflation.

The fact that the airbags did not inflate in a collision does not mean that something is wrong with the system. Rather, it means the forces were not of the type sufficient to cause activation. Side airbags are designed to inflate in side-impact collisions, not roll-over, rear-impact, frontal or near-frontal collisions, unless the collision causes sufficient lateral deceleration.

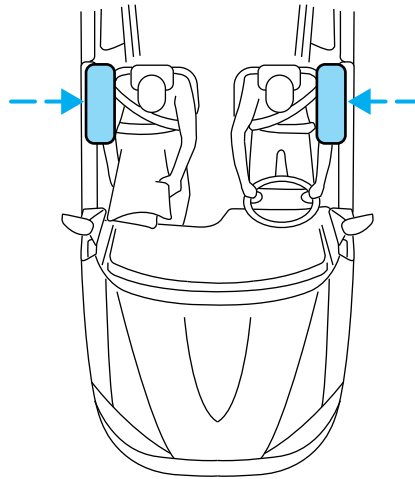

120

Seating and Safety Restraints

 **WARNING:** Several air bag system components get hot after inflation. Do not touch them after inflation.

 **WARNING:** If the side airbag has deployed, **the airbag will not function again. The side airbag system (including the seat) must be inspected and serviced by an authorized dealer.** If the airbag is not replaced, the unrepaired area will increase the risk of injury in a collision.

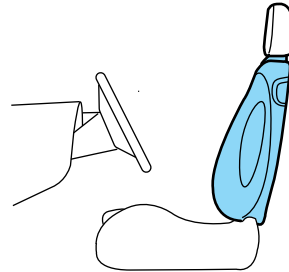

Side-curtain airbag system

 **WARNING:** Do not place objects or mount equipment on or near the headliner at the siderail that may come into contact with a deploying side air curtain. Failure to follow these instructions may increase the risk of personal injury in the event of a collision.

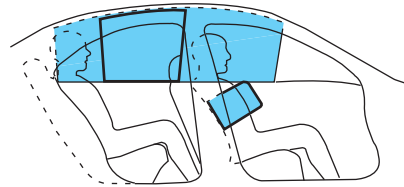



 **WARNING:** Do not place objects or mount equipment on or near the side air curtain cover.

 **WARNING:** Do not lean your head on the door. The side airbag could injure you as it deploys from the seat.

Seating and Safety Restraints

 **WARNING:** Do not attempt to service, repair, or modify the side air curtain system, its fuses, the A, B, or C pillar trim, or the headliner on a vehicle containing a side air curtain. See your authorized dealer.

 **WARNING:** All occupants of the vehicle, including the driver, should always wear their safety belts even when an inflatable curtain is provided.

 **WARNING:** To reduce the risk of injury, do not obstruct or place objects in the deployment zone of the inflatable curtain.

How does the side air curtain system work?

The design and development of the side air curtain system included recommended testing procedures that were developed by a group of automotive safety experts known as the Side Airbag Technical Working Group. These recommended testing procedures help reduce the risk of injuries related to the deployment of side airbags (including side air curtain systems).

The side air curtain system consists of the following:

- An inflatable curtain with a gas generator concealed behind the headliner and above the doors.
- The headliner will flex to open above the side doors to allow air curtain deployment.
- The same warning light, electronic control and diagnostic unit as used for the front airbags.

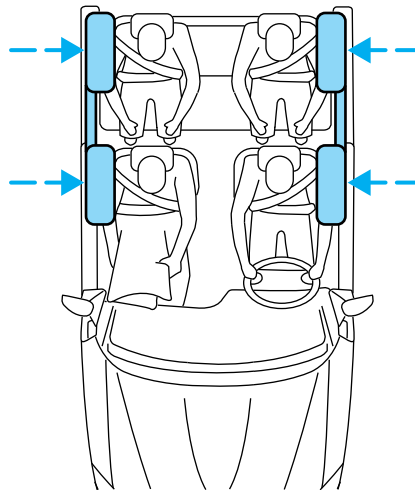

122

Seating and Safety Restraints

- Two pressure sensors located in the front doors.
- Two crash sensors located on the rocker panel between the “B” and “C” pillars near the floor.

Side air curtains and side airbags, in combination with safety belts, can help reduce the risk of severe injuries in the event of a significant side impact collision.

Children 12 years old and under should always be properly restrained in the rear seats. The side air curtain will not interfere with children restrained using a properly installed child or booster seat because it is designed to inflate downward from the headliner above the doors along the side window openings.

The side air curtains are mounted to the sheet metal above the first and second row seats. In certain lateral collisions, the air curtain and seat-mounted side airbag on the side affected by the collision will be inflated, except that the passenger sensing system will deactivate the passenger seat-mounted side airbag if it detects an empty unbuckled passenger seat. The air curtain was designed to inflate between the side window area and occupant to further enhance the head protection provided to occupants in side impact collisions. The seat-mounted side airbag was designed to inflate between the door panel and occupant to further enhance the protection provided occupants in side impact collisions.

The side air curtain system SRS is designed to activate when the vehicle sustains lateral deceleration sufficient to cause the sensors to close an electrical circuit that initiates air curtain and seat-mounted side airbag inflation.

The fact that the side air curtain and seat-mounted side airbag did not inflate in a collision does not mean that something is wrong with the system. Rather, it means the forces were not of the type sufficient to cause activation. The side air curtain system is designed to inflate in side impact collisions, not roll-over, rear impact, frontal or near-frontal collisions, unless the collision causes sufficient lateral deceleration.



WARNING: Several air bag system components get hot after inflation. Do not touch them after inflation.

Seating and Safety Restraints

! **WARNING:** If the side air curtain has deployed, **the air curtain will not function again. The side air curtain system (including the A, B and C pillar trim and headliner) must be inspected and serviced by an authorized dealer.** If the air curtain is not replaced, the unrepaired area will increase the risk of injury in a collision.

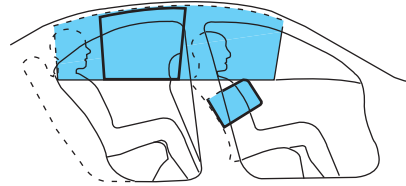

Determining if the system is operational

The SRS uses a readiness light in the instrument cluster or a tone to indicate the condition of the system. Refer to *Warning lights and chimes* in the *Instrument Cluster* chapter. Routine maintenance of the side airbag is not required.

A difficulty with the system is indicated by one or more of the following:

- The readiness light (same light as for front airbag system) will either flash or stay lit.
- The readiness light will not illuminate immediately after ignition is turned on.
- A series of five beeps will be heard. The tone pattern will repeat periodically until the problem and/or light are repaired.

If any of these things happen, even intermittently, have the SRS serviced at your authorized dealer immediately. Unless serviced, the system may not function properly in the event of a collision.

SOS Post-Crash Alert System™

The system automatically flashes the turn signal lamps and sounds the horn three times at four second intervals in the event of a serious impact that deploys an airbag (front, side, side curtain or Safety Canopy®) or the safety belt pretensioners.

The system can be turned off when any one of the following actions are taken by the driver or any other person:

- pressing the hazard control button,
- or pressing the panic button on the remote entry transmitter.

124

Seating and Safety Restraints

The feature will continue to operate until the vehicle runs out of power.

Disposal of airbags and airbag equipped vehicles (including pretensioners)

Contact your authorized dealer as soon as possible. Airbags MUST BE disposed of by qualified personnel.

SAFETY RESTRAINTS FOR CHILDREN

See the following sections for directions on how to properly use safety restraints for children. Also see *Airbag supplemental restraint system (SRS)* in this chapter for special instructions about using airbags.

Important child restraint precautions



WARNING: Always make sure your child is secured properly in a device that is appropriate for their height, age and weight. Child safety restraints must be purchased separately from the vehicle. Failure to follow these instructions and guidelines may result in an increased risk of serious injury or death to your child.



WARNING: All children are shaped differently. The Recommendations for Safety Restraints are based on probable child height, age and weight thresholds from NHTSA and other safety organizations or are the minimum requirements of law. Ford recommends checking with a NHTSA Certified Child Passenger Safety Technician (CPST) and consult your pediatrician to make sure your child seat is appropriate for your child, and is compatible with and properly installed in the vehicle. To locate a child seat fitting station and CPST contact the NHTSA toll free at 1-888-327-4236 or on the internet at <http://www.nhtsa.dot.gov>. In Canada, check with your local St. John Ambulance office for referral to a CPST or for further information, contact your provincial ministry of transportation, your local St. John Ambulance office at <http://www.sfa.ca>, or Transport Canada at 1-800-333-0371 (<http://www.tc.gc.ca>). Failure to properly restrain children in safety seats made especially for their height, age, and weight may result in an increased risk of serious injury or death to your child.

Seating and Safety Restraints

Recommendations for Safety Restraints for Children		
	Child size, height, weight, or age	Recommended restraint type
Infants or toddlers	Children weighing 40 lb (18 kg) or less (generally age four or younger)	Use a child safety seat (sometimes called an infant carrier, convertible seat, or toddler seat).
Small children	Children who have outgrown or no longer properly fit in a child safety seat (generally children who are less than 4 feet 9 inches (1.45 meters) tall, are greater than age four (4) and less than age twelve (12), and between 40 lb (18 kg) and 80 lb (36 kg) and upward to 100 lb (45 kg) if recommended by your child restraint manufacturer)	Use a belt-positioning booster seat.
Larger children	Children who have outgrown or no longer properly fit in a belt-positioning booster seat (generally children who are at least 4 feet 9 inches (1.45 meters) tall or greater than 80 lb (36 kg) or 100 lb (45 kg) if recommended by child restraint manufacturer)	Use a vehicle safety belt having the lap belt snug and low across the hips, shoulder belt centered across the shoulder and chest, and seatback upright.

- You are required by law to properly use safety seats for infants and toddlers in the U.S. and Canada.
- Many states and provinces require that small children use approved booster seats until they reach age eight, a height of 4 ft 9 in. (1.45 meters) tall, or 80 lb (36 kg). Check your local and state or provincial laws for specific requirements regarding the safety of children in your vehicle.
- When possible, always properly restrain children twelve (12) years of age and under in a rear seating position of your vehicle. Accident statistics suggest that children are safer when properly restrained in the rear seating positions than in a front seating position.

126

Seating and Safety Restraints

Recommendations for attaching child safety restraints for children

Restraint Type	Child Weight	Use any attachment method as indicated below by "X"				
		LATCH (lower anchors and top tether anchor)	LATCH (lower anchors only)	Safety belt and top tether anchor	Safety belt and LATCH (lower anchors and top tether anchor)	Safety belt only
Rear facing child seat	Up to 48 lb (21 kg)		X			X
Forward facing child seat	Up to 48 lb (21 kg)	X		X	X	
Forward facing child seat	Over 48 lb (21 kg)			X	X	

 **WARNING:** Airbags can kill or injure a child in a child seat. NEVER place a rear-facing child seat in front of an active airbag. If you must use a forward-facing child seat in the front seat, move the vehicle seat all the way back. When possible, all children age 12 and under should be properly restrained in a rear seating position. If all children cannot be seated and restrained properly in a rear seating position, properly restrain the largest child in the front seat.

 **WARNING:** Always carefully follow the instructions and warnings provided by the manufacturer of any child restraint to determine if the restraint device is appropriate for your child's size, height, weight, or age. Follow the child restraint manufacturer's instructions and warnings provided for installation and use in conjunction with the instructions and warnings provided by the vehicle manufacturer. A safety seat that is improperly installed or utilized, is inappropriate for your child's height, age, or weight or does not properly fit the child may increase the risk of serious injury or death.

Seating and Safety Restraints

 **WARNING:** Never let a passenger hold a child on his or her lap while the vehicle is moving. The passenger cannot protect the child from injury in a collision, which may result in serious injury or death.

 **WARNING:** Never use pillows, books, or towels to boost a child. They can slide around and increase the likelihood of injury or death in a collision.

 **WARNING:** Always restrain an unoccupied child seat or booster seat. These objects may become projectiles in a collision or sudden stop, which may increase the risk of serious injury.

 **WARNING:** Never place, or allow a child to place, the shoulder belt under a child's arm or behind the back because it reduces the protection for the upper part of the body and may increase the risk of injury or death in a collision.

 **WARNING:** Do not leave children, unreliable adults, or pets unattended in your vehicle.

Transporting children

Always make sure your child is secured properly in a device that is appropriate for their age, height and weight. All children are shaped differently. The child height, age and weight thresholds provided are recommendations or the minimum requirements of law. The National Highway Traffic Safety Administration (NHTSA) provides education and training to ensure that all children ages 0 to 16 are properly restrained in the correct restraint system. Ford recommends checking with a NHTSA Certified Child Passenger Safety Technician (CPST) and your pediatrician to make sure your seat is appropriate for your child and properly installed in the vehicle. To locate a child seat fitting station and CPST contact the NHTSA toll free at **1-888-327-4236** or on the internet at <http://www.nhtsa.dot.gov>. In Canada, check with your local St. John Ambulance office for referral to a CPST or for further information, contact your provincial ministry of transportation, your local St. John Ambulance office at <http://www.sfa.ca>, or Transport Canada at 1-800-333-0371 (<http://www.tc.gc.ca>).

128

Seating and Safety Restraints

Follow all the safety restraint and airbag precautions that apply to adult passengers in your vehicle.

If the child is the proper height, age, and weight (as specified by your child safety seat or booster manufacturer), fits the restraint and can be restrained properly, then restrain the child in the child safety seat or with the belt-positioning booster. Remember that child seats and belt-positioning boosters vary and may be designed to fit children of different heights, ages and weights. Children who are too large for child safety seats or belt-positioning boosters (as specified by your child safety seat manufacturer) should always properly wear safety belts.

SAFETY SEATS FOR CHILDREN

Infant and/or toddler seats

Use a safety seat that is recommended for the size and weight of the child.

When installing a child safety seat:

- Review and follow the information presented in the *Airbag supplemental restraint system (SRS)* section in this chapter.
- Carefully follow all of the manufacturer's instructions included with the safety seat you put in your vehicle. If you do not install and use the safety seat properly, the child may be injured in a sudden stop or collision.

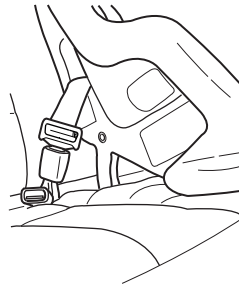

Airbags can kill or injure a child in a child seat. NEVER place a rear-facing child seat in front of an active airbag. If you must use a forward-facing child seat in the front seat, move the vehicle seat all the way back.

Children 12 and under should be properly restrained in a rear seating position whenever possible. If all children cannot be seated and restrained properly in a rear seating position, properly restrain the largest child in the front seat.

Installing child safety seats with combination lap and shoulder belts

Check to make sure the child seat is properly secured before each use. Children 12 and under should be properly restrained in a rear seating

129

Seating and Safety Restraints

position whenever possible. If all children cannot be seated and restrained properly in a rear seating position, properly restrain the largest child in the front seat.

When installing a child safety seat with combination lap/shoulder belts:

- Use the correct safety belt buckle for that seating position.
- Insert the belt tongue into the proper buckle until you hear a snap and feel it latch. Make sure the tongue is securely fastened in the buckle.
- Keep the buckle release button pointing up and away from the safety seat, with the tongue between the child seat and the release button, to prevent accidental unbuckling.
- Place vehicle seat back in upright position.
- Put the safety belt in the automatic locking mode. Refer to step 5 below. This vehicle does not require the use of a locking clip.



WARNING: Depending on where you secure a child restraint, and depending on the child restraint design, you may block access to certain safety belt buckle assemblies and/or LATCH lower anchors, rendering those features potentially unusable. To avoid risk of injury, occupants should only use seating positions where they are able to be properly restrained.

Perform the following steps when installing the child seat with combination lap/shoulder belts:

Note: Although the child seat illustrated is a forward facing child seat, the steps are the same for installing a rear facing child seat.

1. Position the child safety seat in a seat with a combination lap and shoulder belt.

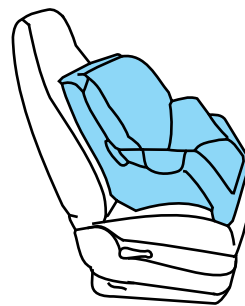

Seating and Safety Restraints

2. Pull down on the shoulder belt and then grasp the shoulder belt and lap belt together.

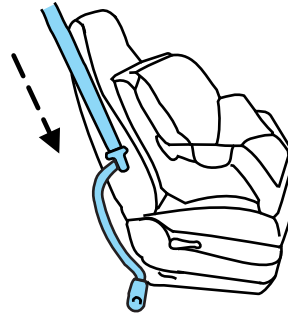

3. While holding the shoulder and lap belt portions together, route the tongue through the child seat according to the child seat manufacturer's instructions. Be sure the belt webbing is not twisted.

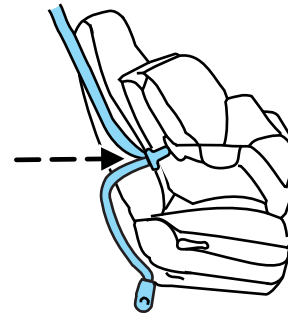

4. Insert the belt tongue into the proper buckle (the buckle closest to the direction the tongue is coming from) for that seating position until you hear a snap and feel the latch engage. Make sure the tongue is latched securely by pulling on it.

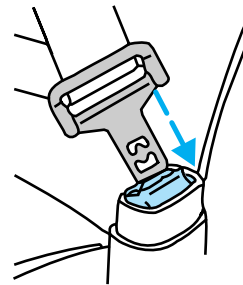

Seating and Safety Restraints

5. To put the retractor in the automatic locking mode, grasp the shoulder portion of the belt and pull downward until all of the belt is pulled out.

Note: The automatic locking mode is available on the front passenger and rear outboard seats only. The rear center seating position has a cinch tongue. Refer to *Installing child safety seats in cinch tongue combination lap and shoulder belt seating positions (rear center position only)* in this chapter.

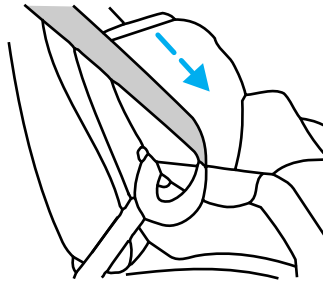

6. Allow the belt to retract to remove slack. The belt will click as it retracts to indicate it is in the automatic locking mode.

7. Try to pull the belt out of the retractor to make sure the retractor is in the automatic locking mode (you should not be able to pull more belt out). If the retractor is not locked, unbuckle the belt and repeat Steps 5 and 6.

8. Remove remaining slack from the belt. Force the seat down with extra weight, e.g., by pressing down or kneeling on the child restraint while pulling up on the shoulder belt in order to force slack from the belt. This is necessary to remove the remaining slack that will exist once the additional weight of the child is added to the child restraint. It also helps to achieve the proper snugness of the child seat to the vehicle. Sometimes, a slight lean towards the buckle will additionally help to remove remaining slack from the belt.

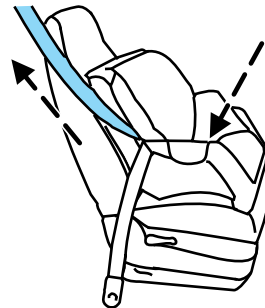

9. Attach the tether strap (if the child seat is equipped). Refer to *Attaching child safety seats with tether straps* later in this chapter.

Seating and Safety Restraints

10. Before placing the child in the seat, forcibly move the seat forward and back to make sure the seat is securely held in place. To check this, grab the seat at the belt path and attempt to move it side to side and forward and back. There should be no more than 1 inch (2.5 cm) of movement for proper installation.

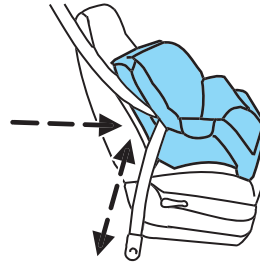

11. Ford recommends checking with a NHTSA Certified Child Passenger Safety Technician (CPST) to make certain the child restraint is properly installed. In Canada, check with your local St. John Ambulance office for referral to a CPST.

Installing child safety seats in cinch tongue combination lap and shoulder belt seating positions (rear center position only)

The belt webbing below the tongue is the lap portion of the combination lap/shoulder belt, and the belt webbing above the tongue is the shoulder belt portion of the combination lap/shoulder belt.

Note: Although the child seat illustrated is a forward facing child seat, the steps are the same for installing a rear facing child seat.

1. Position the child safety seat in a seat with a combination lap and shoulder belt.

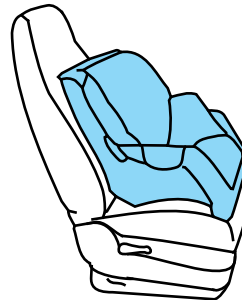

WARNING: Airbags can kill or injure a child in a child seat. If you must use a forward-facing child seat in the front seat, move seat all the way back.



WARNING: Rear facing child seats should NEVER be placed in front of an active airbag.

Seating and Safety Restraints

2. Slide the tongue up the webbing.

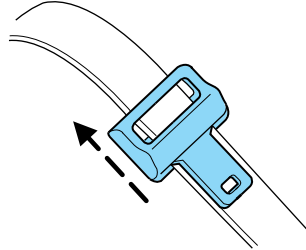

3. While holding both shoulder and lap portions next to the tongue, route the tongue and webbing through the child seat according to the child seat manufacturer's instructions. Be sure that the belt webbing is not twisted.

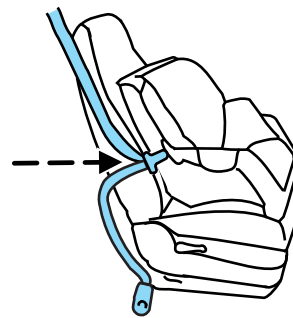

4. Insert the belt tongue into the proper buckle for that seating positions until you hear a snap and feel it latch. Make sure the tongue is securely latched to the buckle by pulling on the tongue.

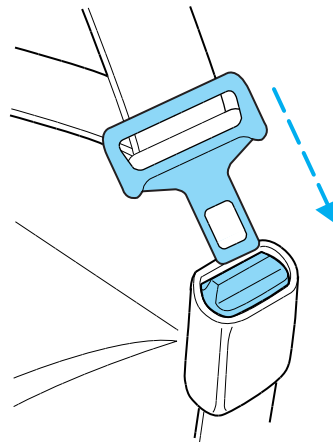

Seating and Safety Restraints

5. Remove remaining slack from the belt. Force the seat down with extra weight, e.g., by pressing down or kneeling on the child restraint while pulling up on the shoulder belt in order to force slack from the belt. This is necessary to remove the remaining slack that will exist once the additional weight of the child is added to the child restraint. It also helps to achieve the proper snugness of the child seat to the vehicle. Sometimes, a slight lean towards the buckle will additionally help to remove remaining slack from the belt.

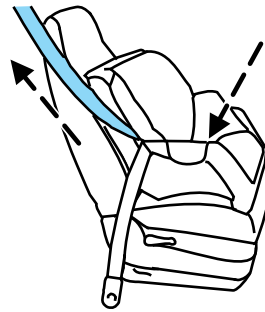

6. Attach the tether strap (if the child seat is equipped). Refer to *Attaching child safety seats with tether straps* later in this chapter.

7. Before placing the child in the seat, forcibly move the seat forward and back to make sure the seat is securely held in place. To check this, grab the seat at the belt path and attempt to move it side to side and forward and back. There should be no more than one inch (2.5 cm) of movement for proper installation.

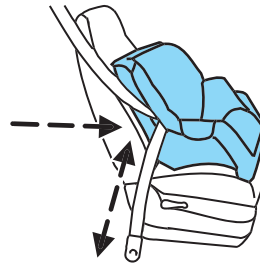

8. Ford recommends checking with a NHTSA Certified Child Passenger Safety Technician (CPST) to make certain the child restraint is properly installed. In Canada, check with your local St. John Ambulance office for referral to a CPST.

Attaching child safety seats with Lower Anchor and Tethers for Children (LATCH) attachments

The LATCH system is composed of three vehicle anchor points: two (2) lower anchors located where the vehicle seat back and seat cushion meet (called the “seat bight”) and one (1) top tether anchor located behind that seating position.

LATCH compatible child safety seats have two rigid or webbing mounted attachments that connect to the two lower anchors at the LATCH

135

Seating and Safety Restraints

equipped seating positions in your vehicle. This type of attachment method eliminates the need to use safety belts to attach the child seat, however the safety belt can still be used to attach the child seat. For forward-facing child seats, the top tether strap must also be attached to the proper top tether anchor, if a top tether strap has been provided with your child seat. Ford Motor Company recommends the use of a child safety seat having a top tether strap. See *Attaching child safety seats with tether straps* and *Recommendations for attaching safety restraints for children* in this chapter for more information.

Your vehicle has LATCH lower anchors for child seat installation at the seating positions marked with the child seat symbol.

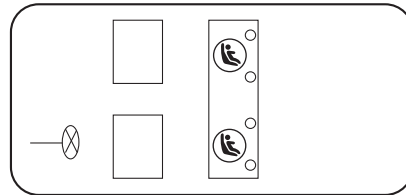

The LATCH anchors are located at the rear section of the rear seat between the cushion and seatback. Follow the child seat manufacturer's instructions to properly install a child seat with LATCH attachments.

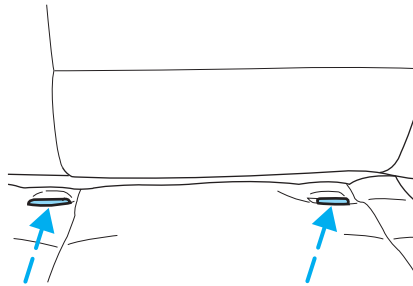

Follow the instructions on attaching child safety seats with tether straps. Refer to *Attaching child safety seats with tether straps* later in this chapter.

Attach LATCH lower attachments of the child seat only to the anchors shown.



WARNING: Never attach two child safety seats to the same anchor. In a crash, one anchor may not be strong enough to hold two child safety seat attachments and may break, causing serious injury or death.

Seating and Safety Restraints



WARNING: Depending on where you secure a child restraint, and depending on the child restraint design, you may block access to certain safety belt buckle assemblies and/or LATCH lower anchors, rendering those features potentially unusable. To avoid risk of injury, occupants should only use seating positions where they are able to be properly restrained.

Use of inboard lower anchors from the outboard seating positions (center seating use)

The lower anchors at the center of the second row rear seat are spaced 450 mm (18 inches) apart. The standardized spacing for LATCH lower anchors is 280 mm (11 inches) center to center. A child seat with rigid LATCH attachments cannot be installed at the center seating position. LATCH compatible child seats (with attachments on belt webbing) can only be used at this seating position provided that the child seat manufacturer's instructions permit use with the anchor spacing stated. Do not attach a child seat to any lower anchor if an adjacent child seat is attached to that anchor.



WARNING: The standardized spacing for LATCH lower anchors is 280 mm (11 inches) center to center. Do not use LATCH lower anchors for the center seating position unless the child seat manufacturer's instructions permit and specify using anchors spaced at least as far apart as those in this vehicle.

Each time you use the safety seat, check that the seat is properly attached to the lower anchors and tether anchor, if applicable. Tug the child seat from side to side and forward and back where it is secured to the vehicle. The seat should move less than one inch when you do this for a proper installation.

If the safety seat is not anchored properly, the risk of a child being injured in a crash greatly increases.

Combining safety belt and LATCH lower anchors for attaching child safety seats

When used in combination, either the safety belt or the LATCH lower anchors may be attached first, provided a proper installation is achieved. Attach the tether strap afterward, if included with the child seat. Refer to *Recommendations for attaching child safety restraints for children* in this chapter.

Seating and Safety Restraints

Attaching child safety seats with tether straps

Many forward-facing child safety seats include a tether strap which extends from the back of the child safety seat and hooks to an anchoring point called the top tether anchor. Tether straps are available as an accessory for many older safety seats. Contact the manufacturer of your child seat for information about ordering a tether strap, or to obtain a longer tether strap if the tether strap on your safety seat does not reach the appropriate top tether anchor in the vehicle.

The rear seats of your vehicle are equipped with built-in tether strap anchors located behind the seats as described below.

The tether anchors in your vehicle are located under a cover marked with the tether anchor symbol (shown with title).

The tether strap anchors in your vehicle are in the following positions (shown from top view):

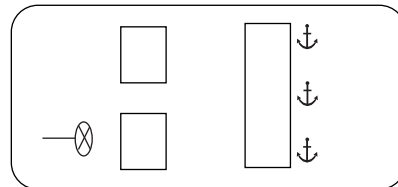

Attach the tether strap only to the appropriate tether anchor as shown. The tether strap may not work properly if attached somewhere other than the correct tether anchor.

Once the child safety seat has been installed using either the safety belt, the lower anchors of the LATCH system, or both, you can attach the top tether strap.

If you install a child seat with rigid LATCH attachments, do not tighten the tether strap enough to lift the child seat off the vehicle seat cushion when the child is seated in it. Keep the tether strap just snug without lifting the front of the child seat. Keeping the child seat just touching the vehicle seat gives the best protection in a severe crash.

Perform the following steps to install a child safety seat with tether anchors:

1. Route the child safety seat tether strap over the back of the seat.

For vehicles with adjustable head restraints, route the tether strap under the head restraint and between the head restraint posts, otherwise route the tether strap over the top of the seatback.

138

Seating and Safety Restraints

2. Locate the correct anchor for the selected seating position.



3. Open the tether anchor cover.



4. Clip the tether strap to the anchor as shown.

If the tether strap is clipped incorrectly, the child safety seat may not be retained properly in the event of a collision.

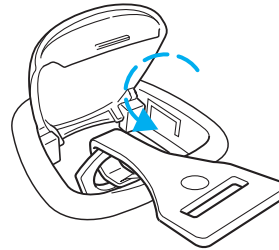

5. Tighten the child safety seat tether strap according to the manufacturer's instructions.

If the safety seat is not anchored properly, the risk of a child being injured in a collision greatly increases.

If your child restraint system is equipped with a tether strap, and the child restraint manufacturer recommends its use, Ford also recommends its use.

Child booster seats

The belt-positioning booster (booster seat) is used to improve the fit of the vehicle safety belt. Children outgrow a typical child seat (e.g., convertible or toddler seat) when they weigh about 40 lb (18 kg) and are around four (4) years of age. Consult your child safety seat owner guide for the weight, height, and age limits specific to your child safety seat. Keep your child in the child safety seat if it properly fits the child, remains appropriate for their weight, height and age AND if properly secured to the vehicle.

Seating and Safety Restraints

Although the lap/shoulder belt will provide some protection, children who have outgrown a typical child seat are still too small for lap/shoulder belts to fit properly, and wearing an improperly fitted vehicle safety belt could increase the risk of serious injury in a crash. To improve the fit of both the lap and shoulder belt on children who have outgrown child safety seats, Ford Motor Company recommends use of a belt-positioning booster.

Booster seats position a child so that vehicle lap/shoulder safety belts fit better. They lift the child up so that the lap belt rests low across the hips and the knees bend comfortably at the edge of the cushion, while minimizing slouching. Booster seats may also make the shoulder belt fit better and more comfortably. Try to keep the belt near the middle of the shoulder and across the center of the chest. Moving the child closer (a few centimeters or inches) to the center of the vehicle, but remaining in the same seating position, may help provide a good shoulder belt fit.

When children should use booster seats

Children need to use booster seats from the time they outgrow the toddler seat until they are big enough for the vehicle seat and lap/shoulder belt to fit properly. Generally this is when they reach a height of at least 4 feet 9 inches (1.45 meters) tall (around age eight to age twelve and between 40 lb (18 kg) and 80 lb (36 kg) or upward to 100 lb (45 kg) if recommended by your child restraint manufacturer). Many state and provincial laws require that children use approved booster seats until they reach age eight, a height of 4 feet 9 inches (1.45 meters) tall, or 80 lb (36 kg).

Booster seats should be used until you can answer YES to ALL of these questions when seated without a booster seat:

- Can the child sit all the way back against the vehicle seat back with knees bent comfortably at the edge of the seat cushion?
- Can the child sit without slouching?

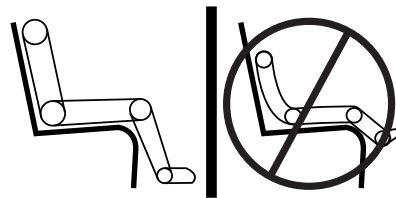

- Does the lap belt rest low across the hips?
- Is the shoulder belt centered on the shoulder and chest?
- Can the child stay seated like this for the whole trip?

140

Seating and Safety Restraints

Types of booster seats

There are generally two types of belt-positioning booster seats: backless and high back. Always use booster seats in conjunction with the vehicle lap/shoulder belt.

- **Backless booster seats**

If your backless booster seat has a removable shield, remove the shield. If a vehicle seating position has a low seat back or no head restraint, a backless booster seat may place your child's head (as measured at the tops of the ears) above the top of the seat. In this case, move the backless booster to another seating position with a higher seat back or head restraint and lap/shoulder belts, or consider using a high back booster seat.



- **High back booster seats**

If, with a backless booster seat, you cannot find a seating position that adequately supports your child's head, a high back booster seat would be a better choice.



Seating and Safety Restraints

Children and booster seats vary in size and shape. Choose a booster that keeps the lap belt low and snug across the hips, never up across the stomach, and lets you adjust the shoulder belt to cross the chest and rest snugly near the center of the shoulder. The drawings below compare the ideal fit (center) to a shoulder belt uncomfortably close to the neck and a shoulder belt that could slip off the shoulder. The drawings below also show how the lap belt should be low and snug across the child's hips.

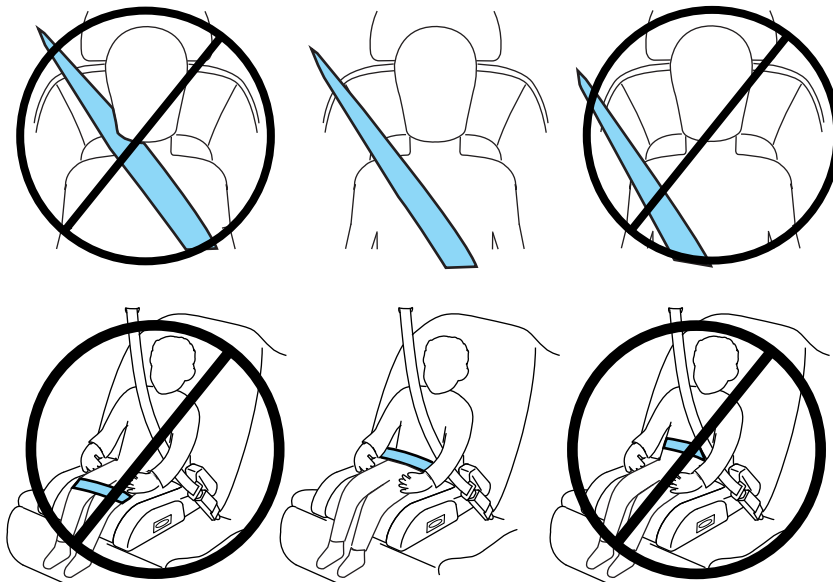

If the booster seat slides on the vehicle seat, placing a rubberized mesh sold as shelf or carpet liner under the booster seat may improve this condition. Do not introduce any item thicker than this under the booster seat. Check with the booster seat manufacturer's instructions.

The importance of shoulder belts

Using a booster without a shoulder belt increases the risk of a child's head hitting a hard surface in a collision. For this reason, you should never use a booster seat with a lap belt only. It is generally best to use a booster seat with lap/shoulder belts in the back seat.

Move a child to a different seating location if the shoulder belt does not stay positioned on the shoulder during use.

142

Seating and Safety Restraints

Follow all instructions provided by the manufacturer of the booster seat.



WARNING: Never place, or allow a child to place, the shoulder belt under a child's arm or behind the back because it reduces the protection for the upper part of the body and may increase the risk of injury or death in a collision.

Child restraint and safety belt maintenance

Inspect the vehicle safety belts and child safety seat systems periodically to make sure they work properly and are not damaged. Inspect the vehicle and child seat safety belts to make sure there are no nicks, tears or cuts. Replace if necessary. All vehicle safety belt assemblies, including retractors, buckles, front safety belt buckle assemblies, buckle support assemblies (slide bar-if equipped), shoulder belt height adjusters (if equipped), shoulder belt guide on seatback (if equipped), child safety seat LATCH and tether anchors, and attaching hardware, should be inspected after a collision. Refer to the child restraint manufacturer's instructions for additional inspection and maintenance information specific to the child restraint. Ford Motor Company recommends that all safety belt assemblies in use in vehicles involved in a collision be replaced. However, if the collision was minor and an authorized dealer finds that the belts do not show damage and continue to operate properly, they do not need to be replaced. Safety belt assemblies not in use during a collision should also be inspected and replaced if either damage or improper operation is noted.

For proper care of soiled safety belts, refer to *Interior* in the *Cleaning* chapter.



WARNING: Failure to inspect and if necessary replace the safety belt assembly or child restraint system under the above conditions could result in severe personal injuries in the event of a collision.

Tires, Wheels and Loading

INFORMATION ABOUT UNIFORM TIRE QUALITY GRADING

Tire Quality Grades apply to new pneumatic passenger car tires. The Quality grades can be found where applicable on the tire sidewall between tread shoulder and maximum section width. For example:

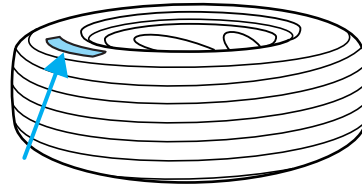

- **Treadwear 200 Traction AA Temperature A**

These Tire Quality Grades are determined by standards that the United States Department of Transportation has set.

Tire Quality Grades apply to new pneumatic passenger car tires. They do not apply to deep tread, winter-type snow tires, space-saver or temporary use spare tires, light truck or "LT" type tires, tires with nominal rim diameters of 10 to 12 inches or limited production tires as defined in Title 49 Code of Federal Regulations Part 575.104(c)(2).

U.S. Department of Transportation-Tire quality grades: The U.S. Department of Transportation requires Ford Motor Company to give you the following information about tire grades exactly as the government has written it.

Treadwear

The treadwear grade is a comparative rating based on the wear rate of the tire when tested under controlled conditions on a specified government test course. For example, a tire graded 150 would wear one and one-half (1½) times as well on the government course as a tire graded 100. The relative performance of tires depends upon the actual conditions of their use, however, and may depart significantly from the norm due to variations in driving habits, service practices, and differences in road characteristics and climate.

Traction AA A B C

The traction grades, from highest to lowest are AA, A, B, and C. The grades represent the tire's ability to stop on wet pavement as measured under controlled conditions on specified government test surfaces of asphalt and concrete. A tire marked C may have poor traction performance.

144

Tires, Wheels and Loading



WARNING: The traction grade assigned to this tire is based on straight-ahead braking traction tests, and does not include acceleration, cornering, hydroplaning or peak traction characteristics.

Temperature A B C

The temperature grades are A (the highest), B and C, representing the tire's resistance to the generation of heat and its ability to dissipate heat when tested under controlled conditions on a specified indoor laboratory test wheel. Sustained high temperature can cause the material of the tire to degenerate and reduce tire life, and excessive temperature can lead to sudden tire failure. The grade C corresponds to a level of performance which all passenger car tires must meet under the Federal Motor Vehicle Safety Standard No. 139. Grades B and A represent higher levels of performance on the laboratory test wheel than the minimum required by law.



WARNING: The temperature grade for this tire is established for a tire that is properly inflated and not overloaded. Excessive speed, underinflation, or excessive loading, either separately or in combination, can cause heat buildup and possible tire failure.

TIRES

Tires are designed to give many thousands of miles of service, but they must be maintained in order to get the maximum benefit from them.

Glossary of tire terminology

- **Tire label:** A label showing the OE (Original Equipment) tire sizes, recommended inflation pressure and the maximum weight the vehicle can carry.
- **Tire Identification Number (TIN):** A number on the sidewall of each tire providing information about the tire brand and manufacturing plant, tire size and date of manufacture. Also referred to as DOT code.
- **Inflation pressure:** A measure of the amount of air in a tire.
- **Standard load:** A class of P-metric or Metric tires designed to carry a maximum load at 35 psi [37 psi (2.5 bar) for Metric tires]. Increasing the inflation pressure beyond this pressure will not increase the tire's load carrying capability.
- **Extra load:** A class of P-metric or Metric tires designed to carry a heavier maximum load at 41 psi [43 psi (2.9 bar) for Metric tires].

145

Tires, Wheels and Loading

Increasing the inflation pressure beyond this pressure will not increase the tire's load carrying capability.

- **kPa:** Kilopascal, a metric unit of air pressure.
- **PSI:** Pounds per square inch, a standard unit of air pressure.
- **Cold inflation pressure:** The tire pressure when the vehicle has been stationary and out of direct sunlight for an hour or more and prior to the vehicle being driven for 1 mile (1.6 km).
- **Recommended inflation pressure:** The cold inflation pressure found on the Safety Compliance Certification Label or Tire Label located on the B-Pillar or the edge of the driver's door.
- **B-pillar:** The structural member at the side of the vehicle behind the front door.
- **Bead area of the tire:** Area of the tire next to the rim.
- **Sidewall of the tire:** Area between the bead area and the tread.
- **Tread area of the tire:** Area of the perimeter of the tire that contacts the road when mounted on the vehicle.
- **Rim:** The metal support (wheel) for a tire or a tire and tube assembly upon which the tire beads are seated.

INFLATING YOUR TIRES

Safe operation of your vehicle requires that your tires are properly inflated. Remember that a tire can lose up to half of its air pressure without appearing flat.

Every day before you drive, check your tires. If one looks lower than the others, use a tire gauge to check pressure of all tires and adjust if required.

At least once a month and before long trips, inspect each tire and check the tire pressure with a tire gauge (including spare, if equipped). Inflate all tires to the inflation pressure recommended by Ford Motor Company.

You are strongly urged to buy a reliable tire pressure gauge, as automatic service station gauges may be inaccurate. Ford recommends the use of a digital or dial-type tire pressure gauge rather than a stick-type tire pressure gauge.

Use the recommended cold inflation pressure for optimum tire performance and wear. Under-inflation or over-inflation may cause uneven treadwear patterns.

146

Tires, Wheels and Loading



WARNING: Under-inflation is the most common cause of tire failures and may result in severe tire cracking, tread separation or “blowout”, with unexpected loss of vehicle control and increased risk of injury. Under-inflation increases sidewall flexing and rolling resistance, resulting in heat buildup and internal damage to the tire. It also may result in unnecessary tire stress, irregular wear, loss of vehicle control and accidents. A tire can lose up to half of its air pressure and not appear to be flat!

Always inflate your tires to the Ford recommended inflation pressure even if it is less than the maximum inflation pressure information found on the tire. The Ford recommended tire inflation pressure is found on the Safety Compliance Certification Label or Tire Label which is located on the B-Pillar or the edge of the driver's door. Failure to follow the tire pressure recommendations can cause uneven treadwear patterns and adversely affect the way your vehicle handles.

Maximum Permissible Inflation Pressure is the tire manufacturer's maximum permissible pressure and/or the pressure at which the maximum load can be carried by the tire. This pressure is normally higher than the manufacturer's recommended cold inflation pressure which can be found on the Safety Compliance Certification Label or Tire Label which is located on the B-Pillar or the edge of the driver's door. The cold inflation pressure should never be set lower than the recommended pressure on the Safety Compliance Certification Label or Tire Label.

When weather temperature changes occur, tire inflation pressures also change. A 10°F (6°C) temperature drop can cause a corresponding drop of 1 psi (7 kPa) in inflation pressure. Check your tire pressures frequently and adjust them to the proper pressure which can be found on the Safety Compliance Certification Label or Tire Label.

To check the pressure in your tire(s):

1. Make sure the tires are cool, meaning they are not hot from driving even a mile.

If you are checking tire pressure when the tire is hot, (i.e. driven more than 1 mile [1.6 km]), never “bleed” or reduce air pressure. The tires are hot from driving and it is normal for pressures to increase above recommended cold pressures. A hot tire at or below recommended cold inflation pressure could be significantly under-inflated.

Note: If you have to drive a distance to get air for your tire(s), check and record the tire pressure first and add the appropriate air pressure

Tires, Wheels and Loading

when you get to the pump. It is normal for tires to heat up and the air pressure inside to go up as you drive.

2. Remove the cap from the valve on one tire, then firmly press the tire gauge onto the valve and measure the pressure.

3. Add enough air to reach the recommended air pressure.

Note: If you overfill the tire, release air by pressing on the metal stem in the center of the valve. Then recheck the pressure with your tire gauge.

4. Replace the valve cap.

5. Repeat this procedure for each tire, including the spare.

Note: Some spare tires operate at a higher inflation pressure than the other tires. For T-type/mini-spare tires (see the *Dissimilar spare tire/wheel information* section for description): Store and maintain at 60 psi (4.15 bar). For full-size and dissimilar spare tires (see the *Dissimilar spare tire/wheel information* section for description): Store and maintain at the higher of the front and rear inflation pressure as shown on the Tire Label.

6. Visually inspect the tires to make sure there are no nails or other objects embedded that could poke a hole in the tire and cause an air leak.

7. Check the sidewalls to make sure there are no gouges, cuts or bulges.

TIRE CARE

Inspecting your tires and wheel valve stems

Periodically inspect the tire treads for uneven or excessive wear and remove objects such as stones, nails or glass that may be wedged in the tread grooves. Check the tire and valve stems for holes, cracks, or cuts that may permit air leakage and repair or replace the tire and replace the valve stem. Inspect the tire sidewalls for cracking, cuts, bruises and other signs of damage or excessive wear. If internal damage to the tire is suspected, have the tire demounted and inspected in case it needs to be repaired or replaced. For your safety, tires that are damaged or show signs of excessive wear should not be used because they are more likely to blow out or fail.

Tires, Wheels and Loading

Improper or inadequate vehicle maintenance can cause tires to wear abnormally. Inspect all your tires, including the spare, frequently, and replace them if one or more of the following conditions exist:

Tire wear

When the tread is worn down to 1/16th of an inch (2 mm), tires must be replaced to help prevent your vehicle from skidding and hydroplaning. Built-in treadwear indicators, or “wear bars”, which look like narrow strips of smooth rubber across the tread will appear on the tire when the tread is worn down to 1/16th of an inch (2 mm).

When the tire tread wears down to the same height as these “wear bars”, the tire is worn out and must be replaced.

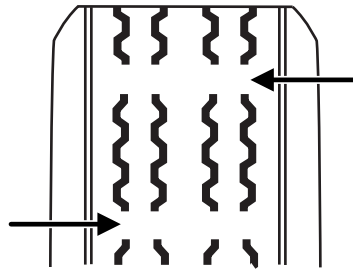

Damage

Periodically inspect the tire treads and sidewalls for damage (such as bulges in the tread or sidewalls, cracks in the tread groove and separation in the tread or sidewall). If damage is observed or suspected have the tire inspected by a tire professional. Tires can be damaged during off-road use, so inspection after off-road use is also recommended.



WARNING: Age

Tires degrade over time depending on many factors such as weather, storage conditions, and conditions of use (load, speed, inflation pressure, etc.) the tires experience throughout their lives. In general, tires should be replaced after six years regardless of tread wear. However, heat caused by hot climates or frequent high loading conditions can accelerate the aging process and may require tires to be replaced more frequently.

You should replace your spare tire when you replace the road tires or after six years due to aging even if it has not been used.

Tires, Wheels and Loading

U.S. DOT Tire Identification Number (TIN)

Both U.S. and Canada Federal regulations require tire manufacturers to place standardized information on the sidewall of all tires. This information identifies and describes the fundamental characteristics of the tire and also provides a U.S. DOT Tire Identification Number for safety standard certification and in case of a recall.

This begins with the letters "DOT" and indicates that the tire meets all federal standards. The next two numbers or letters are the plant code designating where it was manufactured, the next two are the tire size code and the last four numbers represent the week and year the tire was built. For example, the numbers 317 mean the 31st week of 1997. After 2000 the numbers go to four digits. For example, 2501 means the 25th week of 2001. The numbers in between are identification codes used for traceability. This information is used to contact customers if a tire defect requires a recall.

Tire replacement requirements

Your vehicle is equipped with tires designed to provide a safe ride and handling capability.



WARNING: Only use replacement tires and wheels that are the same size, load index, speed rating and type (such as P-metric versus LT-metric or all-season versus all-terrain) as those originally provided by Ford. The recommended tire and wheel size may be found on either the Safety Compliance Certification Label or the Tire Label which is located on the B-Pillar or edge of the driver's door. If this information is not found on these labels then you should contact your authorized dealer as soon as possible. Use of any tire or wheel not recommended by Ford can affect the safety and performance of your vehicle, which could result in an increased risk of loss of vehicle control, vehicle rollover, personal injury and death. Additionally the use of non-recommended tires and wheels could cause steering, suspension, axle or transfer case/power transfer unit failure. If you have questions regarding tire replacement, contact your authorized dealer as soon as possible.

Tires, Wheels and Loading



WARNING: When mounting replacement tires and wheels, you should not exceed the maximum pressure indicated on the sidewall of the tire to set the beads without additional precautions listed below. If the beads do not seat at the maximum pressure indicated, re-lubricate and try again.

When inflating the tire for mounting pressures up to 20 psi (138 kPa) greater than the maximum pressure on the tire sidewall, the following precautions must be taken to protect the person mounting the tire:

1. Make sure that you have the correct tire and wheel size.
2. Lubricate the tire bead and wheel bead seat area again.
3. Stand at a minimum of 12 ft (3.66 m) away from the tire wheel assembly.
4. Use both eye and ear protection.

For a mounting pressure more than 20 psi (138 kPa) greater than the maximum pressure, an authorized dealer or other tire service professional should do the mounting.

Always inflate steel carcass tires with a remote air fill with the person inflating standing at a minimum of 12 ft (3.66 m) away from the tire wheel assembly.

Important: Remember to replace the wheel valve stems when the road tires are replaced on your vehicle.

It is recommended that the two front tires or two rear tires generally be replaced as a pair.

The tire pressure sensors mounted in the wheels are not designed to be used in aftermarket wheels.

The use of wheels or tires not recommended by Ford Motor Company may affect the operation of your tire pressure monitoring system (if equipped).

If the TPMS indicator is flashing, your TPMS is malfunctioning. Your replacement tire might be incompatible with your TPMS, or some component of the TPMS may be damaged (if equipped).

Safety practices

Driving habits have a great deal to do with your tire mileage and safety.

- Observe posted speed limits
- Avoid fast starts, stops and turns
- Avoid potholes and objects on the road

Tires, Wheels and Loading

- Do not run over curbs or hit the tire against a curb when parking



WARNING: If your vehicle is stuck in snow, mud, sand, etc., **do not** rapidly spin the tires; spinning the tires can tear the tire and cause an explosion. A tire can explode in as little as three to five seconds.



WARNING: Do not spin the wheels at over 35 mph (56 km/h). The tires may fail and injure a passenger or bystander.

Highway hazards

No matter how carefully you drive there's always the possibility that you may eventually have a flat tire on the highway. Drive slowly to the closest safe area out of traffic. This may further damage the flat tire, but your safety is more important.

If you feel a sudden vibration or ride disturbance while driving, or you suspect your tire or vehicle has been damaged, immediately reduce your speed. Drive with caution until you can safely pull off the road. Stop and inspect the tires for damage. If a tire is under-inflated or damaged, deflate it, remove wheel and replace it with your spare tire and wheel. If you cannot detect a cause, have the vehicle towed to the nearest repair facility or tire dealer to have the vehicle inspected.

Tire and wheel alignment

A bad jolt from hitting a curb or pothole can cause the front end of your vehicle to become misaligned or cause damage to your tires. If your vehicle seems to pull to one side when you're driving, the wheels may be out of alignment. Have an authorized dealer check the wheel alignment periodically.

Wheel misalignment in the front or the rear can cause uneven and rapid treadwear of your tires and should be corrected by an authorized dealer. Front-wheel drive (FWD) vehicles and those with an independent rear suspension (if equipped) may require alignment of all four wheels.

The tires should also be balanced periodically. An unbalanced tire and wheel assembly may result in irregular tire wear.

Tire rotation

Rotating your tires at the recommended interval (as indicated in the *Scheduled Maintenance Guide* chapter) will help your tires wear more evenly, providing better tire performance and longer tire life.

152

Tires, Wheels and Loading

- Front-wheel drive (FWD) vehicles
(front tires at top of diagram)

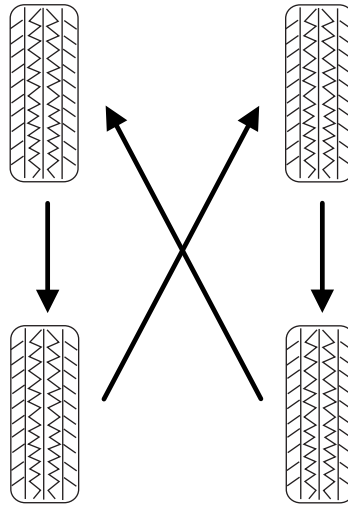

Sometimes irregular tire wear can be corrected by rotating the tires.

Note: If your tires show uneven wear ask an authorized dealer to check for and correct any wheel misalignment, tire imbalance or mechanical problem involved before tire rotation.

Note: Your vehicle may be equipped with a dissimilar spare tire/wheel. A dissimilar spare tire/wheel is defined as a spare tire and/or wheel that is different in brand, size or appearance from the road tires and wheels. If you have a dissimilar spare tire/wheel it is intended for temporary use only and should not be used in a tire rotation.

Note: After having your tires rotated, inflation pressure must be checked and adjusted to the vehicle requirements.

INFORMATION CONTAINED ON THE TIRE SIDEWALL

Both U.S. and Canada Federal regulations require tire manufacturers to place standardized information on the sidewall of all tires. This information identifies and describes the fundamental characteristics of the tire and also provides a U.S. DOT Tire Identification Number for safety standard certification and in case of a recall.

153

Tires, Wheels and Loading

Information on “P” type tires

P215/65R15 95H is an example of a tire size, load index and speed rating. The definitions of these items are listed below. (Note that the tire size, load index and speed rating for your vehicle may be different from this example.)

1. **P:** Indicates a tire, designated by the Tire and Rim Association (T&RA), that may be used for service on cars, SUVs, minivans and light trucks.

Note: If your tire size does not begin with a letter this may mean it is designated by either ETRTO (European Tire and Rim Technical Organization) or JATMA (Japan Tire Manufacturing Association).

2. **215:** Indicates the nominal width of the tire in millimeters from sidewall edge to sidewall edge. In general, the larger the number, the wider the tire.

3. **65:** Indicates the aspect ratio which gives the tire’s ratio of height to width.

4. **R:** Indicates a “radial” type tire.

5. **15:** Indicates the wheel or rim diameter in inches. If you change your wheel size, you will have to purchase new tires to match the new wheel diameter.

6. **95:** Indicates the tire’s load index. It is an index that relates to how much weight a tire can carry. You may find this information in your Owner’s Guide. If not, contact a local tire dealer.

Note: You may not find this information on all tires because it is not required by federal law.

7. **H:** Indicates the tire’s speed rating. The speed rating denotes the speed at which a tire is designed to be driven for extended periods of time under a standard condition of load and inflation pressure. The tires on your vehicle may operate at different conditions for load and inflation pressure. These speed ratings may need to be adjusted for the difference in conditions. The ratings range from 81 mph (130 km/h) to 186 mph (299 km/h). These ratings are listed in the following chart.



154

Tires, Wheels and Loading

Note: You may not find this information on all tires because it is not required by federal law.

Letter rating	Speed rating - mph (km/h)
M	81 mph (130 km/h)
N	87 mph (140 km/h)
Q	99 mph (159 km/h)
R	106 mph (171 km/h)
S	112 mph (180 km/h)
T	118 mph (190 km/h)
U	124 mph (200 km/h)
H	130 mph (210 km/h)
V	149 mph (240 km/h)
W	168 mph (270 km/h)
Y	186 mph (299 km/h)

Note: For tires with a maximum speed capability over 149 mph (240 km/h), tire manufacturers sometimes use the letters ZR. For those with a maximum speed capability over 186 mph (299 km/h), tire manufacturers always use the letters ZR.

8. U.S. DOT Tire Identification Number (TIN): This begins with the letters "DOT" and indicates that the tire meets all federal standards. The next two numbers or letters are the plant code designating where it was manufactured, the next two are the tire size code and the last four numbers represent the week and year the tire was built. For example, the numbers 317 mean the 31st week of 1997. After 2000 the numbers go to four digits. For example, 2501 means the 25th week of 2001. The numbers in between are identification codes used for traceability. This information is used to contact customers if a tire defect requires a recall.

9. M+S or M/S: Mud and Snow, or

AT: All Terrain, or

AS: All Season.

10. Tire Ply Composition and Material Used: Indicates the number of plies or the number of layers of rubber-coated fabric in the tire tread and sidewall. Tire manufacturers also must indicate the ply materials in the tire and the sidewall, which include steel, nylon, polyester, and others.

Tires, Wheels and Loading

11. **Maximum Load:** Indicates the maximum load in kilograms and pounds that can be carried by the tire. Refer to the Safety Compliance Certification Label, which is located on the B-Pillar or the edge of the driver's door, for the correct tire pressure for your vehicle.

12. Treadwear, Traction and Temperature Grades

- **Treadwear:** The treadwear grade is a comparative rating based on the wear rate of the tire when tested under controlled conditions on a specified government test course. For example, a tire graded 150 would wear one and one-half (1½) times as well on the government course as a tire graded 100.
- **Traction:** The traction grades, from highest to lowest are AA, A, B, and C. The grades represent the tire's ability to stop on wet pavement as measured under controlled conditions on specified government test surfaces of asphalt and concrete. A tire marked C may have poor traction performance.
- **Temperature:** The temperature grades are A (the highest), B and C, representing the tire's resistance to the generation of heat and its ability to dissipate heat when tested under controlled conditions on a specified indoor laboratory test wheel.

13. **Maximum Permissible Inflation Pressure:** Indicates the tire manufacturers' maximum permissible pressure and/or the pressure at which the maximum load can be carried by the tire. This pressure is normally higher than the manufacturer's recommended cold inflation pressure which can be found on the Safety Compliance Certification Label or Tire Label which is located on the B-Pillar or the edge of the driver's door. The cold inflation pressure should never be set lower than the recommended pressure on the vehicle label.

The tire suppliers may have additional markings, notes or warnings such as standard load, radial tubeless, etc.

Tires, Wheels and Loading

Additional information contained on the tire sidewall for “LT” type tires

“LT” type tires have some additional information beyond those of “P” type tires; these differences are described below.

Note: Tire Quality Grades do not apply to this type of tire.

1. **LT:** Indicates a tire, designated by the Tire and Rim Association (T&RA), that is intended for service on light trucks.

2. Load Range/Load Inflation

Limits: Indicates the tire’s load-carrying capabilities and its inflation limits.

3. **Maximum Load Dual lb (kg) at psi (kPa) cold:** Indicates the maximum load and tire pressure when the tire is used as a dual; defined as four tires on the rear axle (a total of six or more tires on the vehicle).

4. **Maximum Load Single lb (kg) at psi (kPa) cold:** Indicates the maximum load and tire pressure when the tire is used as a single; defined as two tires (total) on the rear axle.



Tires, Wheels and Loading

Information on “T” type tires

“T” type tires have some additional information beyond those of “P” type tires; these differences are described below:

T145/80D16 is an example of a tire size.

Note: The temporary tire size for your vehicle may be different from this example. Tire Quality Grades do not apply to this type of tire.

1. **T:** Indicates a type of tire, designated by the Tire and Rim Association (T&RA), that is intended for temporary service on cars, SUVs, minivans and light trucks.

2. **145:** Indicates the nominal width of the tire in millimeters from sidewall edge to sidewall edge. In general, the larger the number, the wider the tire.

3. **80:** Indicates the aspect ratio which gives the tire’s ratio of height to width. Numbers of 70 or lower indicate a short sidewall.

4. **D:** Indicates a “diagonal” type tire.

R: Indicates a “radial” type tire.

5. **16:** Indicates the wheel or rim diameter in inches. If you change your wheel size, you will have to purchase new tires to match the new wheel diameter.

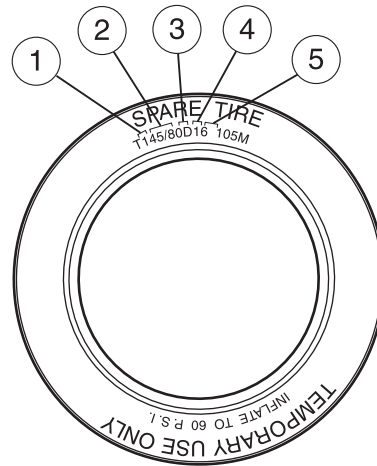

Location of the tire label

You will find a Tire Label containing tire inflation pressure by tire size and other important information located on the B-Pillar or the edge of the driver’s door. Refer to the payload description and graphic in the *Vehicle loading* section.

Tires, Wheels and Loading

TIRE PRESSURE MONITORING SYSTEM (TPMS)

Each tire, including the spare (if provided), should be checked monthly when cold and inflated to the inflation pressure recommended by the vehicle manufacturer on the vehicle placard or tire inflation pressure label. (If your vehicle has tires of a different size than the size indicated on the vehicle placard or tire inflation pressure label, you should determine the proper tire inflation pressure for those tires.)

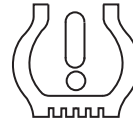

As an added safety feature, your vehicle has been equipped with a tire pressure monitoring system (TPMS) that illuminates a low tire pressure telltale when one or more of your tires is significantly under-inflated. Accordingly, when the low tire pressure telltale illuminates, you should stop and check your tires as soon as possible, and inflate them to the proper pressure. Driving on a significantly under-inflated tire causes the tire to overheat and can lead to tire failure. Under-inflation also reduces fuel efficiency and tire tread life, and may affect the vehicle's handling and stopping ability.

Please note that the TPMS is not a substitute for proper tire maintenance, and it is the driver's responsibility to maintain correct tire pressure, even if under-inflation has not reached the level to trigger illumination of the TPMS low tire pressure telltale.

Your vehicle has also been equipped with a TPMS malfunction indicator to indicate when the system is not operating properly. The TPMS malfunction indicator is combined with the low tire pressure telltale. When the system detects a malfunction, the telltale will flash for approximately one minute and then remain continuously illuminated. This sequence will continue upon subsequent vehicle start-ups as long as the malfunction exists.

When the malfunction indicator is illuminated, the system may not be able to detect or signal low tire pressure as intended. TPMS malfunctions may occur for a variety of reasons, including the installation of replacement or alternate tires or wheels on the vehicle that prevent the TPMS from functioning properly. Always check the TPMS malfunction telltale after replacing one or more tires or wheels on your vehicle to ensure that the replacement or alternate tires and wheels allow the TPMS to continue to function properly.

The tire pressure monitoring system complies with part 15 of the FCC rules and with RSS-210 of Industry Canada. Operation is subject to the

159

Tires, Wheels and Loading

following two conditions: (1) This device may not cause harmful interference, and (2) This device must accept any interference received, including interference that may cause undesired operation.



WARNING: The tire pressure monitoring system is NOT a substitute for manually checking tire pressure. The tire pressure should be checked periodically (at least monthly) using a tire gauge, see *Inflating your tires* in this chapter. Failure to properly maintain your tire pressure could increase the risk of tire failure, loss of control, vehicle rollover and personal injury.

Changing tires with TPMS

Each road tire is equipped with a tire pressure sensor located inside the tire/wheel cavity. The pressure sensor is attached to the valve stem. The pressure sensor is covered by the tire and is not visible unless the tire is removed. Care must be taken when changing the tire to avoid damaging the sensor. It is

recommended that you always have your tires serviced by an authorized dealer.

The tire pressure should be checked periodically (at least monthly) using an accurate tire gauge, refer to *Inflating your tires* in this chapter.

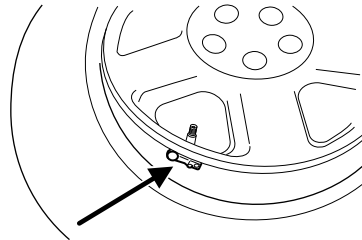

Understanding your tire pressure monitoring system (TPMS)

The tire pressure monitoring system measures pressure in your four road tires and sends the tire pressure readings to your vehicle. The low tire pressure warning lamp will turn on if the tire pressure is significantly low. Once the light is illuminated, your tires are under inflated and need to be inflated to the manufacturer's recommended tire pressure. Even if the light turns on and a short time later turns off, your tire pressure still needs to be checked. Visit www.checkmytires.org for additional information.

When your temporary spare tire is installed

When one of your road tires needs to be replaced with the temporary spare, the TPMS system will continue to identify an issue to remind you that the damaged road wheel/tire needs to be repaired and put back on your vehicle.

160

Tires, Wheels and Loading

To restore the full functionality of the tire pressure monitoring system, have the damaged road wheel/tire repaired and remounted on your vehicle. For additional information, refer to *Changing tires with TPMS* in this section.

When you believe your system is not operating properly

The main function of the tire pressure monitoring system is to warn you when your tires need air. It can also warn you in the event the system is no longer capable of functioning as intended. Please refer to the following chart for information concerning your tire pressure monitoring system:

Low tire pressure warning light	Possible cause	Customer action required
Solid warning light	Tire(s) under-inflated	1. Check your tire pressure to ensure tires are properly inflated; refer to <i>Inflating your tires</i> in this chapter. 2. After inflating your tires to the manufacturer's recommended inflation pressure as shown on the Tire Label (located on the edge of driver's door or the B-Pillar), the vehicle must be driven for at least two minutes over 20 mph (32 km/h) before the light will turn off.
	Spare tire in use	Your temporary spare tire is in use. Repair the damaged road wheel/tire and reinstall it on the vehicle to restore system functionality. For a description on how the system functions, refer to <i>When your temporary spare tire is installed</i> in this section.
	TPMS malfunction	If your tires are properly inflated and your spare tire is not in use and the light remains on, contact your authorized dealer as soon as possible.

Tires, Wheels and Loading

Low tire pressure warning light	Possible cause	Customer action required
Flashing warning light	Spare tire in use	Your temporary spare tire is in use. Repair the damaged road wheel and re-mount it on the vehicle to restore system functionality. For a description of how the system functions under these conditions, refer to <i>When your temporary spare tire is installed</i> in this section.
	TPMS malfunction	If your tires are properly inflated and your spare tire is not in use and the TPMS warning light still flashes, contact your authorized dealer as soon as possible.

When inflating your tires

When putting air into your tires (such as at a gas station or in your garage), the tire pressure monitoring system may not respond immediately to the air added to your tires.

It may take up to two minutes of driving over 20 mph (32 km/h) for the light to turn off after you have filled your tires to the recommended inflation pressure.

How temperature affects your tire pressure

The tire pressure monitoring system (TPMS) monitors tire pressure in each pneumatic tire. While driving in a normal manner, a typical passenger tire inflation pressure may increase approximately 2 to 4 psi (14 to 28 kPa) from a cold start situation. If the vehicle is stationary over night with the outside temperature significantly lower than the daytime temperature, the tire pressure may decrease approximately 3 psi (21 kPa) for a drop of 30°F (17°C) in ambient temperature. This lower pressure value may be detected by the TPMS as being significantly lower than the recommended inflation pressure and activate the TPMS warning for low tire pressure. If the low tire pressure warning light is on, visually check each tire to verify that no tire is flat. (If one or more tires are flat, repair as necessary.) Check air pressure in the road tires. If any tire is under-inflated, carefully drive the vehicle to the nearest location where air can be added to the tires. Inflate all the tires to the recommended inflation pressure.

162

Tires, Wheels and Loading

SNOW TIRES AND CHAINS



WARNING: Snow tires must be the same size, load index, speed rating as those originally provided by Ford. Use of any tire or wheel not recommended by Ford can affect the safety and performance of your vehicle, which could result in an increased risk of loss of vehicle control, vehicle rollover, personal injury and death. Additionally, the use of non-recommended tires and wheels could cause steering, suspension, axle or transfer case/power transfer unit failure.

The original equipment tires on your vehicle have an all-weather tread design to provide traction, handling and braking performance in year-round driving. You may install snow tires for improved traction when driving in areas with sustained periods of snow or icy driving conditions.

If you choose to install snow tires on your vehicle, they must be the same size, construction, and load range as the original tires listed on the tire placard, and they must be installed on all four wheels. Mixing tires of different size or construction on your vehicle can adversely affect your vehicle's handling and braking, and may lead to loss of vehicle control.



WARNING: Do not use snow chains or cables on this vehicle as they may cause damage to your vehicle which may lead to loss of vehicle control.

VEHICLE LOADING

This section will guide you in the proper loading of your vehicle to keep your loaded vehicle weight within its design rating capability. Properly loading your vehicle will provide maximum return of vehicle design performance. Before loading your vehicle, familiarize yourself with the following terms for determining your vehicle's weight ratings from the vehicle's Tire Label or Safety Compliance Certification Label:

Base Curb Weight – is the weight of the vehicle including a full tank of fuel and all standard equipment. It does not include passengers, cargo, or optional equipment.

Vehicle Curb Weight – is the weight of your new vehicle when you picked it up from your authorized dealer plus any aftermarket equipment.

163

Tires, Wheels and Loading



Payload – is the combined weight of cargo and passengers that the vehicle is carrying. The maximum payload for your vehicle can be found on the Tire Label on the B-Pillar or the edge of the driver's door (vehicles exported outside the US and Canada may not have a Tire Label). Look for **“THE COMBINED WEIGHT OF OCCUPANTS AND CARGO SHOULD NEVER EXCEED XXX kg OR XXX lb.”** for maximum payload. The payload listed on the Tire Label is the maximum payload for the vehicle as built by the assembly plant. If any aftermarket or authorized-dealer installed equipment has been installed on the vehicle, the weight of the equipment must be subtracted from the payload listed on the Tire Label in order to determine the new payload.



WARNING: The appropriate loading capacity of your vehicle can be limited either by volume capacity (how much space is available) or by payload capacity (how much weight the vehicle should carry). Once you have reached the maximum payload of your vehicle, do not add more cargo, even if there is space available. Overloading or improperly loading your vehicle can contribute to loss of vehicle control and vehicle rollover.

Tires, Wheels and Loading

Example only:

TIRE AND LOADING INFORMATION				
SEATING CAPACITY		TOTAL 5	FRONT 2	REAR 3
The combined weight of occupants and cargo should never exceed : XXX kg or XXX lbs.				
TIRE	SIZE	COLD TIRE PRESSURE		SEE OWNERS MANUAL FOR ADDITIONAL INFORMATION
FRONT	LT225/75R 16.5E	200 KPA, 29 PSI		
REAR	LT225/75R 16.5E	200 KPA, 29 PSI		
SPARE	T145/80D16 P225/60R17	420 KPA, 60 PSI 200 KPA, 29 PSI		

TIRE AND LOADING INFORMATION				
RENSEIGNEMENTS SUR LES PNEUS ET LE CHARGEMENT				
SEATING CAPACITY		TOTAL 5	FRONT 2	REAR 3
NOMBRE DE PLACES		TOTAL 5	AVANT 2	ARRIERE 3
The combined weight of occupants and cargo should never exceed 492 kg or 1085 lbs. Le poids total des occupants et du chargement ne doit jamais dépasser 492 kg ou 1085 lb.				
TIRE PNEU	SIZE DIMENSIONS	COLD TIRE PRESSURE PRESSION DES PNEUS A FROID		SEE OWNER'S MANUAL FOR ADDITIONAL INFORMATION VOIR LE MANUEL DE L'USAGER POUR PLUS DE RENSEIGNEMENTS
FRONT AVANT	P235/70R16	240 KPA, 35 PSI		
REAR ARRIERE	P235/70R16	240 KPA, 35 PSI		
SPARE DE SECOURS	T145/90R17	415 KPA, 60 PSI		

CARGO =



Cargo Weight – includes all weight added to the Base Curb Weight, including cargo and optional equipment.

GAW (Gross Axle Weight) – is the total weight placed on each axle (front and rear) – including vehicle curb weight and all payload.

Tires, Wheels and Loading

GAWR (Gross Axle Weight Rating) – is the maximum allowable weight that can be carried by a single axle (front or rear). **These numbers are shown on the Safety Compliance Certification Label located on the B-Pillar or the edge of the driver's door. The total load on each axle must never exceed its GAWR.**

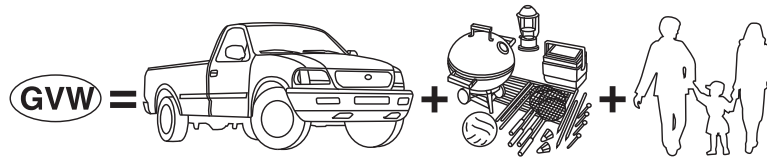

GVW (Gross Vehicle Weight) – is the Vehicle Curb Weight + cargo + passengers.

GVWR (Gross Vehicle Weight Rating) – is the maximum allowable weight of the fully loaded vehicle (including all options, equipment, passengers and cargo). **The GVWR is shown on the Safety Compliance Certification Label located on the B-Pillar or the edge of the driver's door. The GVW must never exceed the GVWR.**

Tires, Wheels and Loading

- Example only:

MFD. BY FORD MOTOR CO.

DATE: XX/XX GVWR: XXXXXLB/ XXXXXKG
 FRONT GAWR: XXXXL REAR GAWR: XXXXLB
 XXXXKG WITH XXXXKG WITH
 XXXX/XXXXXXXXX TIRES: XXXX/XXXXXXXXX TIRES
 XXXX.XX RIMS: XXXX.XX RIMS
 AT XXX kPa/XX PSI COLD AT XXX kPa/XX PSI COLD

THIS VEHICLE CONFORMS TO ALL APPLICABLE FEDERAL MOTOR
 VEHICLE SAFETY AND THEFT PREVENTION STANDARDS IN
 EFFECT ON THE DATE OF MANUFACTURE SHOWN ABOVE.

VIN: XXXXXXXXXXXXXXXXXX XXXXX
 TYPE: XXX XXXXX

EXT PNT: XX RC: XX DSO:
 WB BRK INT TR TP/PS R AXLE TR SPR XXXXX
 XXX X XX X XX X XX XXX
 XXXXXXXXXXXXX XXX XXXX-XXXXXXXX-XX

MFD. BY FORD MOTOR CO.

DATE: xx/xx GVWR/PNBV: xxxxxLB/xxxxxKG
 FRONT GAWR/PNBE AY REAR GAWR/PNBE AR
 xxxxx/xxxxxB xxxxxKG/xxxxLB
 WITH/AVEC TIRES/PNEUS
 xxxxx/xxxxx
 xxxxx/xxxxx
 xxx:xxx RIMS/JANTES xxx:xxx

AT/A kPa/PSI/LPC xxx/xx COLD/A FROID xxx/xx
 /JUMEELES

VIN: xxxxxxxxxxxxxxxxxxxx xxxxxx
 TYPE: xxx/xxxxx COMPLIES: xxxxx/xxx - xxx xxxxxx
 xxxxxx

EXT PNT: U RC: xx DSO:
 WB INT TR TP/PS R AXLE TR SPR xxxxx
 xxx xx x xx x xxxxx xxx
 XXXXXXXXXXXXXXX XXX XXXX-XXXXXXXX-XX

 **WARNING:** Exceeding the Safety Compliance Certification Label vehicle weight rating limits could result in substandard vehicle handling or performance, engine, transmission and/or structural damage, serious damage to the vehicle, loss of control and personal injury.

 **WARNING:** Do not exceed the GVWR or the GAWR specified on the Safety Compliance Certification Label.

Tires, Wheels and Loading



WARNING: Do not use replacement tires with lower load carrying capacities than the original tires because they may lower the vehicle's GVWR and GAWR limitations. Replacement tires with a higher limit than the original tires do not increase the GVWR and GAWR limitations.



WARNING: Exceeding any vehicle weight rating limitation could result in serious damage to the vehicle and/or personal injury.

Steps for determining the correct load limit:

1. Locate the statement "The combined weight of occupants and cargo should never exceed XXX kg or XXX lbs." on your vehicle's placard.
2. Determine the combined weight of the driver and passengers that will be riding in your vehicle.
3. Subtract the combined weight of the driver and passengers from XXX kg or XXX lbs.
4. The resulting figure equals the available amount of cargo and luggage load capacity. For example, if the "XXX" amount equals 1,400 lbs. and there will be five 150 lb. passengers in your vehicle, the amount of available cargo and luggage load capacity is 650 lbs. ($1400 - 750 (5 \times 150) = 650$ lb.). In metric units ($635 - 340 (5 \times 68) = 295$ kg.)
5. Determine the combined weight of luggage and cargo being loaded on the vehicle. That weight may not safely exceed the available cargo and luggage load capacity calculated in Step 4.

The following gives you a few examples on how to calculate the available amount of cargo and luggage load capacity:

- Another example for your vehicle with 1400 lb. (635 kg) of cargo and luggage capacity. You decide to go golfing. Is there enough load capacity to carry you, 4 of your friends and all the golf bags? You and four friends average 220 lb. (99 kg) each and the golf bags weigh approximately 30 lb. (13.5 kg) each. The calculation would be: $1400 - (5 \times 220) - (5 \times 30) = 1400 - 1100 - 150 = 150$ lb. Yes, you have enough load capacity in your vehicle to transport four friends and your golf bags. In metric units, the calculation would be: $635 \text{ kg} - (5 \times 99 \text{ kg}) - (5 \times 13.5 \text{ kg}) = 635 - 495 - 67.5 = 72.5$ kg.
- A final example for your vehicle with 1400 lb. (635 kg) of cargo and luggage capacity. You and one of your friends decide to pick up cement from the local home improvement store to finish that patio

168

Tires, Wheels and Loading

you have been planning for the past 2 years. Measuring the inside of the vehicle with the rear seat folded down, you have room for 12-100 lb. (45 kg) bags of cement. Do you have enough load capacity to transport the cement to your home? If you and your friend each weigh 220 lb. (99 kg), the calculation would be: $1400 - (2 \times 220) - (12 \times 100) = 1400 - 440 - 1200 = -240$ lb. No, you do not have enough cargo capacity to carry that much weight. In metric units, the calculation would be: $635 \text{ kg} - (2 \times 99 \text{ kg}) - (12 \times 45 \text{ kg}) = 635 - 198 - 540 = -103$ kg. You will need to reduce the load weight by at least 240 lb. (104 kg). If you remove 3-100 lb. (45 kg) cement bags, then the load calculation would be:

$1400 - (2 \times 220) - (9 \times 100) = 1400 - 440 - 900 = 60$ lb. Now you have the load capacity to transport the cement and your friend home. In metric units, the calculation would be: $635 \text{ kg} - (2 \times 99 \text{ kg}) - (9 \times 45 \text{ kg}) = 635 - 198 - 405 = 32$ kg.

The above calculations also assume that the loads are positioned in your vehicle in a manner that does not overload the Front or the Rear Gross Axle Weight Rating specified for your vehicle on the Safety Compliance Certification Label found on the edge of the driver's door.

TRAILER TOWING



WARNING: Never tow a trailer with this vehicle. Your vehicle is not equipped to tow. No towing packages are available through an authorized dealer.

RECREATIONAL TOWING

Follow these guidelines if you have a need for recreational (RV) towing. An example of recreational towing would be towing your vehicle behind a motorhome. These guidelines are designed to ensure that your transmission is not damaged.

Note: Put your climate control system in recirculated air mode to prevent exhaust fumes from entering the vehicle. Refer to the *Climate Controls* chapter for more information.

Tires, Wheels and Loading

Front-wheel drive (FWD) vehicles equipped with a manual transmission: If your vehicle is equipped with a manual transmission, shifting the transmission into neutral permits “flat-towing” (all wheels on the ground) for pulling behind a motorhome.

Before you tow your vehicle:

- Release the parking brake.
- Move the gearshift to the neutral position.
- Turn the key in the ignition to the off position.
- The maximum recommended speed is 70 mph (113 km/h).
- The maximum recommended distance is unlimited.
- The vehicle must be towed in the forward position to ensure no damage is done to the internal transmission components.

In addition, it is recommended that you follow the instructions provided by the aftermarket manufacturer of the towing equipment, if provided.

In case of a roadside emergency with a disabled vehicle, see *Wrecker towing* in the *Roadside Emergencies* chapter.

Front-wheel drive (FWD) vehicles equipped with an automatic transmission: Do not tow the vehicle with the front drive wheels on the ground. It is recommended to tow your vehicle with the front drive wheels on a dolly or with all four (4) wheels off the ground on a car-hauling trailer.

In case of a roadside emergency with a disabled vehicle, see *Wrecker towing* in the *Roadside Emergencies* chapter.

STARTING

Positions of the ignition

1. Off — locks the steering wheel, automatic transmission gearshift lever and allows key removal. This position also shuts the engine and all electrical accessories off.

2. Accessory—allows the electrical accessories such as the radio to operate while the engine is not running.

3. On— all electrical circuits operational. Warning lights illuminated. Key position when driving.

4. Start— cranks the engine. Release the key as soon as the engine starts.

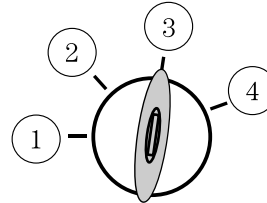

Preparing to start your vehicle

Engine starting is controlled by the powertrain control system.

This system meets all Canadian interference-causing equipment standard requirements regulating the impulse electrical field strength of radio noise.

When starting a fuel-injected engine, don't press the accelerator before or during starting. Only use the accelerator when you have difficulty starting the engine. For more information on starting the vehicle, refer to *Starting the engine* in this chapter.



WARNING: Extended idling at high engine speeds can produce very high temperatures in the engine and exhaust system, creating the risk of fire or other damage.



WARNING: Do not park, idle, or drive your vehicle in dry grass or other dry ground cover. The emission system heats up the engine compartment and exhaust system, which can start a fire.



WARNING: Do not start your vehicle in a closed garage or in other enclosed areas. Exhaust fumes can be toxic. Always open the garage door before you start the engine. See *Guarding against exhaust fumes* in this chapter for more instructions.

Driving



WARNING: If you smell exhaust fumes inside your vehicle, have your dealer inspect your vehicle immediately. Do not drive if you smell exhaust fumes.

Important safety precautions

When the engine starts, the idle RPM runs faster to warm the engine. If the engine idle speed does not slow down automatically, have the vehicle checked.

Before starting the vehicle:

1. Make sure all occupants buckle their safety belts. For more information on safety belts and their proper usage, refer to the *Seating and Safety Restraints* chapter.
2. Make sure the headlamps and electrical accessories are off.

If starting a vehicle with an automatic transmission:

- Make sure the parking brake is set.

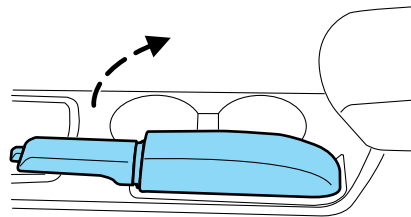

Driving

- Make sure the gearshift is in P (Park).

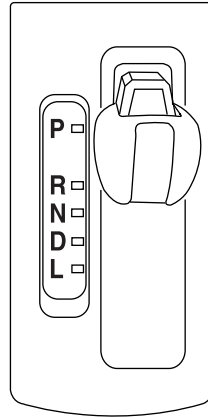

If starting a vehicle with a manual transmission:

- Make sure the parking brake is set.
- Press the clutch pedal to the floor.

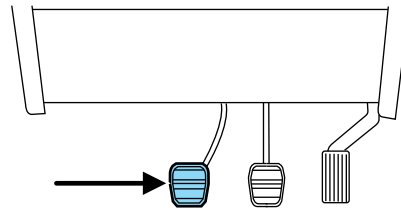

3. Turn the key to 3 (on) without turning the key to 4 (start).

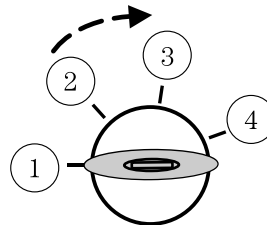

Some warning lights will briefly illuminate. See *Warning lights and chimes* in the *Instrument Cluster* chapter for more information regarding the warning lights.

Driving

Starting the engine

1. Turn the key to 3 (on) without turning the key to 4 (start).
2. Turn the key to 4 (start), then release the key as soon as the engine begins cranking. Your vehicle has a computer assisted cranking system that assists in starting the engine. After releasing the key from the 4 (start) position, the engine may continue cranking for up to 10 seconds or until the vehicle starts.

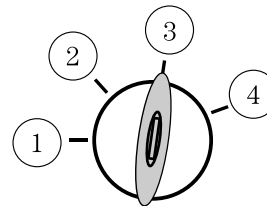

Note: Cranking may be stopped at any time by turning the key to the off position.

3. After idling for a few seconds, release the parking brake, apply the brake, shift into gear and drive.

Note: If the engine does not start on the first try, turn the key to the off position, wait 10 seconds and try Step 2 again. If the engine still fails to start, press the accelerator to the floor and try Step 2 again, keeping the accelerator on the floor until the engine begins to accelerate above cranking speeds; this will allow the engine to crank with the fuel shut off in case the engine is flooded with fuel.

Guarding against exhaust fumes

Carbon monoxide is present in exhaust fumes. Take precautions to avoid its dangerous effects.



WARNING: If you smell exhaust fumes inside your vehicle, have your dealer inspect your vehicle immediately. Do not drive if you smell exhaust fumes.

Important ventilating information

If the engine is idling while the vehicle is stopped for a long period of time, open the windows at least 1 inch (2.5 cm) or adjust the heating or air conditioning to bring in fresh air.

ENGINE BLOCK HEATER (IF EQUIPPED)

An engine block heater warms the engine coolant which aids in starting and allows the heater/defroster system to respond quickly. If your vehicle is equipped with this system, your equipment includes a heater element

174

Driving

which is installed in your engine block and a wire harness which allows the user to connect the system to a grounded 120 volt A/C electrical source. The block heater system is most effective when outdoor temperatures reach below 0°F (-18°C).



WARNING: Failure to follow engine block heater instructions could result in property damage or physical injury.



WARNING: To reduce the risk of electrical shock, do not use your heater with ungrounded electrical systems or two-pronged (cheater) adapters.

Prior to using the engine block heater, follow these recommendations for proper and safe operation:

- For your safety, use an outdoor extension cord that is product certified by Underwriter's Laboratory (UL) or Canadian Standards Association (CSA). Use only an extension cord that can be used outdoors, in cold temperatures, and is clearly marked "Suitable for Use with Outdoor Appliances." Never use an indoor extension cord outdoors; it could result in an electric shock or fire hazard.
- Use a 16-gauge outdoor extension cord, minimum.
- Use as short an extension cord as possible.
- Do not use multiple extension cords. Instead, use one extension cord which is long enough to reach from the engine block heater cord to the outlet without stretching.
- Make certain that the extension cord is in excellent condition (not patched or spliced). Store your extension cord indoors at temperatures above 32°F (0°C). Outdoor conditions can deteriorate extension cords over a period of time.
- To reduce the risk of electrical shock, do not use your heater with ungrounded electrical systems or two pronged (cheater) adapters. Also ensure that the block heater, especially the cord, is in good condition before use.
- Make sure that when in operation, the extension cord plug/engine block heater cord plug connection is free and clear of water in order to prevent possible shock or fire.
- Be sure that areas where the vehicle is parked are clean and clear of all combustibles such as petroleum products, dust, rags, paper and similar items.

175

Driving

- Be sure that the engine block heater, heater cord and extension cord are solidly connected. A poor connection can cause the cord to become very hot and may result in an electrical shock or fire. Be sure to check for heat anywhere in the electrical hookup once the system has been operating for approximately a half hour.
- Finally, have the engine block heater system checked during your fall tune-up to be sure it's in good working order.

How to use the engine block heater

Ensure the receptacle terminals are clean and dry prior to use. To clean them, use a dry cloth.

Depending on the type of factory installed equipment, your engine block heater will use .4 to 1.0 kilowatt-hours of energy per hour of use. Your factory installed block heater system does not have a thermostat; however, maximum temperature is attained after approximately three hours of operation. Block heater operation longer than three hours will not improve system performance and will unnecessarily use additional electricity.

Make sure system is unplugged and properly stowed before driving the vehicle. While not in use, make sure the protective cover seals the prongs of the engine block heater cord plug.

BRAKES

Occasional brake noise is normal. If a metal-to-metal, continuous grinding or continuous squeal sound is present, the brake linings may be worn-out and should be inspected by an authorized dealer. If the vehicle has continuous vibration or shudder in the steering wheel while braking, the vehicle should be inspected by an authorized dealer.

Refer to *Warning lights and chimes* in the *Instrument Cluster* chapter for information on the brake system warning light.

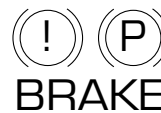

Under normal operating conditions, brake dust may accumulate on the wheels. Some brake dust is inevitable as brakes wear and does not contribute to brake noise. The use of modern friction materials with emphasis on improved performance and environmental considerations can lead to more dust than in the past. Brake dust can be cleaned by weekly washing with soapy water and a soft sponge. Heavier deposits can be removed with Motorcraft® Wheel and Tire Cleaner (ZC-37-A).

176

Four-wheel anti-lock brake system (ABS)

Your vehicle is equipped with an anti-lock braking system (ABS). This system helps you maintain steering control during emergency stops by keeping the brakes from locking. Noise from the ABS pump motor and brake pedal pulsation may be observed during ABS braking and the brake pedal may suddenly travel a little farther as soon as ABS braking is done and normal brake operation resumes. These are normal characteristics of the ABS and should be no reason for concern.

Using ABS

When hard braking is required, apply continuous force on the brake pedal. Do not pump the brake pedal since this will reduce the effectiveness of the ABS and will increase your vehicle's stopping distance. The ABS will be activated immediately, allowing you to retain steering control during hard braking and on slippery surfaces. However, the ABS does not decrease stopping distance.

ABS warning lamp

The ABS lamp in the instrument cluster momentarily illuminates when the ignition is turned on. If the light does not illuminate during start up, remains on or flashes, the ABS may be disabled and may need to be serviced.

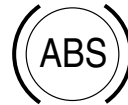

Even when the ABS is disabled, normal braking is still effective. (If your BRAKE warning lamp illuminates with the parking brake released, have your brake system serviced immediately.)



Driving

Parking brake

To set the parking brake (1), pull the parking brake handle up as far as possible.

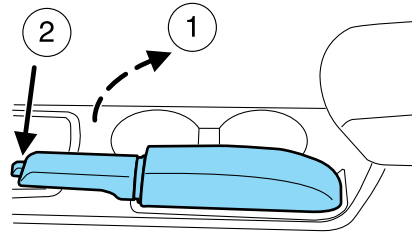

The BRAKE warning lamp will illuminate and will remain illuminated until the parking brake is released.

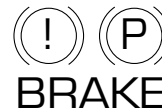

To release, press and hold the button (2), pull the handle up slightly, then push the handle down.

WARNING: Always set the parking brake fully and make sure that the gearshift is securely latched in P (Park) (automatic transmission) or in 1 (First) (manual transmission).

WARNING: If the parking brake is fully released, but the brake warning lamp remains illuminated, the brakes may not be working properly. See your authorized dealer as soon as possible.

ADVANCETRAC® STABILITY ENHANCEMENT SYSTEM

Your vehicle may be equipped with the AdvanceTrac® system. The AdvanceTrac® system provides the following stability enhancement features for certain driving situations:

- Traction control system (TCS), which functions to help avoid drive-wheel spin and loss of traction.
- Electronic Stability Control (ESC), which functions to help avoid skids or lateral slides

Driving

 **WARNING:** Vehicle modifications involving braking system, aftermarket roof racks, suspension, steering system, tire construction and/or wheel/tire size may change the handling characteristics of the vehicle and may adversely affect the performance of the AdvanceTrac® system. In addition, installing any stereo loudspeakers may interfere with and adversely affect the AdvanceTrac® system. Install any aftermarket stereo loudspeaker as far as possible from the front center console, the tunnel, and the front seats in order to minimize the risk of interfering with the AdvanceTrac® sensors. Reducing the effectiveness of the AdvanceTrac® system could lead to an increased risk of loss of vehicle control, vehicle rollover, personal injury and death.

 **WARNING:** Remember that even advanced technology cannot defy the laws of physics. It's always possible to lose control of a vehicle due to inappropriate driver input for the conditions. Aggressive driving on any road condition can cause you to lose control of your vehicle increasing the risk of personal injury or property damage. Activation of the AdvanceTrac® system is an indication that at least some of the tires have exceeded their ability to grip the road; this could reduce the operator's ability to control the vehicle potentially resulting in a loss of vehicle control, vehicle rollover, personal injury and death. If your AdvanceTrac® system activates, SLOW DOWN.

 **WARNING:** If a failure has been detected within the AdvanceTrac® system, the stability control light will illuminate steadily. Verify that the AdvanceTrac® system is not manually disabled (press the stability control button located on the center of the instrument panel). If the stability control light still illuminates steadily, have the system serviced by an authorized dealer immediately.

The AdvanceTrac® system automatically enables each time the engine is started. All features of the AdvanceTrac® system (TCS and ESC) are active and monitor the vehicle from start-up. However, the system will only intervene if the driving situation requires it.

Driving

The AdvanceTrac® system includes a stability control button on the center of the instrument panel, and a stability control light in the instrument cluster. The stability control light in the instrument cluster will illuminate temporarily during start-up as part of a normal system self-check, or during driving if a driving situation causes the AdvanceTrac® system to operate. If the stability control light illuminates steadily, verify that the AdvanceTrac® system is not manually disabled by pressing the stability control button located on the center stack of the instrument panel. If the stability control light remains steadily illuminated, have the system serviced by an authorized dealer immediately. If equipped with a message center, the vehicle will also indicate a failure with the AdvanceTrac® system.

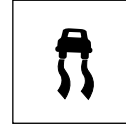

Note: If the system cannot be turned off, refer to *MyKey™* in the *Locks and Security* chapter for more information.

When AdvanceTrac® performs a normal system self-check, some drivers may notice a slight movement of the brake, and/or a rumble, grunting, or grinding noise after startup and when driving off.

When an event occurs that activates AdvanceTrac® you may experience the following:

- A slight deceleration of the vehicle
- The stability control light will flash.
- A vibration in the pedal when your foot is on the brake pedal
- If the driving condition is severe and your foot is not on the brake, the brake pedal may move as the systems applies higher brake forces. You may also hear a whoosh of air from under the instrument panel during this severe condition.
- The brake pedal may feel stiffer than usual.

Traction control system (TCS)

Traction control is a driver aid feature that helps your vehicle maintain traction of the wheels, typically when driving on slippery and/or hilly road surfaces, by detecting and controlling wheel spin.

Excessive wheel spin is controlled in two ways, which may work separately or in tandem, engine traction control and brake traction control. Engine traction control works to limit drive-wheel spin by momentarily reducing engine power. Brake traction control works to limit

180

wheel spin by momentarily applying the brakes to the wheel that is slipping. Traction control is most active at low speeds.

During TCS events, the stability control light in the instrument cluster will flash.

If the TCS is activated excessively in a short period of time, the braking portion of the system may become temporarily disabled to allow the brakes to cool down. In this situation, TCS will use only engine power reduction or transfer to help control the wheels from over-spinning. When the brakes have cooled down, the system will regain all features. Anti-lock braking, and ESC are not affected by this condition and will continue to function during the cool-down period.

The engine traction control and brake traction control system may be deactivated in certain situations. See the *Switching off traction control* section below.

Electronic stability control (ESC)

Electronic stability control (ESC) may enhance your vehicle's directional stability during adverse maneuvers, for example when cornering severely or avoiding objects in the roadway. ESC operates by applying brakes to one or more of the wheels individually and, if necessary, reducing engine power if the system detects that the vehicle is about to skid or slide laterally.

During ESC events, the stability control light in the instrument cluster will flash.

Certain adverse driving maneuvers may activate the ESC system, which include but are not limited to:

- Taking a turn too fast
- Maneuvering quickly to avoid an accident, pedestrian or obstacle
- Driving over a patch of ice or other slippery surfaces
- Changing lanes on a snow-rutted road
- Entering a snow-free road from a snow-covered side street, or vice versa
- Entering a paved road from a gravel road, or vice versa
- Cornering while towing a heavily loaded trailer (refer to *Trailer towing* in the *Tires, Wheels and Loading* chapter).

Switching off traction control

If the vehicle is stuck in snow, mud or sand, and seems to lose engine power, switching off the TCS feature of the AdvanceTrac® system may

Driving

be beneficial because the wheels are allowed to spin. This will restore full engine power and will enhance momentum through the obstacle. To switch off the TCS press the stability control button. Full features of the AdvanceTrac® system can be restored by pressing the stability control button again or by turning off and restarting the engine.

If you switch off the TCS, the stability control light will illuminate steadily. Pressing the AdvanceTrac® button again will turn off the stability control light.

In R (Reverse), ABS and the engine traction control and brake traction control features will continue to function; however, ESC is disabled.

AdvanceTrac® Features			
Button functions	Stability control light 	ESC	TCS
Default at start-up	Illuminated during bulb check	Enabled	Enabled
Button pressed momentarily	Illuminated solid	Enabled	Disabled
Button pressed again after deactivation	Not illuminated	Enabled	Enabled

STEERING

To help prevent damage to the power steering system:

- Never hold the steering wheel at its furthest turning points (until it stops) for more than a few seconds when the engine is running.
- Do not operate the vehicle with a low power steering fluid level (below the MIN mark on the reservoir).
- Some noise is normal during operation. If the noise is excessive, check for a low power steering fluid level before seeking service by your authorized dealer.
- Heavy or uneven steering efforts may be caused by a low power steering fluid level. Check for a low power steering fluid level before seeking service by your authorized dealer.
- Do not fill the power steering fluid reservoir above the MAX mark on the reservoir.

If the power steering system breaks down (or if the engine is turned off), you can steer the vehicle manually, but it takes more effort.

182

If the steering wanders or pulls, check for:

- An improperly inflated tire
- Uneven tire wear
- Loose or worn suspension components
- Loose or worn steering components
- Improper steering alignment

A high crown in the road or high crosswinds may also make the steering seem to wander/pull.

BRAKE-SHIFT INTERLOCK

This vehicle is equipped with a brake-shift interlock feature that prevents the gearshift lever from being moved from P (Park) when the ignition is in the on position unless the brake pedal is pressed.

If you cannot move the gearshift lever out of P (Park) with ignition in the on position and the brake pedal pressed, it is possible that a fuse has blown or the vehicle's brake lamps are not operating properly. Refer to *Fuses and relays* in the *Roadside Emergencies* chapter.

If the fuse is not blown and the brake lamps are working properly, the following procedure will allow you to move the gearshift lever from P (Park):

1. Apply the parking brake, turn ignition key to off, then remove the key.
2. Using a screwdriver (or similar tool), remove the protective cover to the interlock release access hole on the console.
3. Insert the screwdriver (or similar tool) into the access hole and press downward while pulling the gearshift lever out of the P (Park) position and into the N (Neutral) position.
4. Remove the tool and reinstall the protective cover.
5. Start the vehicle and release the parking brake.

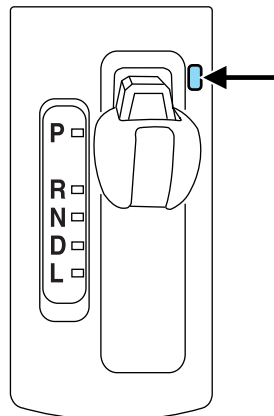

Driving

See your authorized dealer as soon as possible if this procedure is used.



WARNING: Do not drive your vehicle until you verify that the brake lamps are working.



WARNING: Always set the parking brake fully and make sure the gearshift is latched in P (Park). Turn the ignition to the off position and remove the key whenever you leave your vehicle.



WARNING: If the parking brake is fully released, but the brake warning lamp remains illuminated, the brakes may not be working properly. See your authorized dealer.

AUTOMATIC TRANSMISSION OPERATION (IF EQUIPPED)

Understanding the gearshift positions of the 4-speed automatic transmission

This vehicle is equipped with an adaptive transmission shift strategy. Adaptive transmission shift strategy offers the optimal transmission operation and shift quality. When the vehicle's battery has been disconnected for any type of service or repair, the transmission will need to relearn the normal shift strategy parameters, much like having to reset your radio stations when your vehicle battery has been disconnected. The adaptive transmission shift strategy allows the transmission to relearn these operating parameters. This learning process could take several transmission upshifts and downshifts; during this learning process, slightly firmer shifts may occur. After this learning process, normal shift feel and shift scheduling will resume.

P (Park)

This position locks the transmission and prevents the front wheels from turning.

To put your vehicle in gear:

1. Start the engine
2. Press the brake pedal
3. Move the gearshift lever into the desired gear

To put your vehicle in P (Park):

1. Come to a complete stop
2. Move the gearshift lever and securely latch it in P (Park)

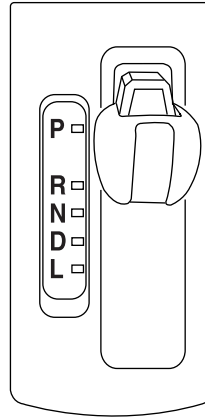

WARNING: Always set the parking brake fully and make sure the gearshift is latched in P (Park). Turn the ignition to the off position and remove the key whenever you leave your vehicle.

R (Reverse)

With the gearshift lever in R (Reverse), the vehicle will move backward. Always come to a complete stop before shifting into and out of R (Reverse).

N (Neutral)

With the gearshift lever in N (Neutral), the vehicle can be started and is free to roll. Hold the brake pedal down while in this position.

D (Drive) with Overdrive

The normal driving position for the best fuel economy. Transmission operates in gears one through four.

Driving

D (Drive) without Overdrive

Overdrive can be deactivated by pressing the transmission control switch on the side of the gearshift lever.

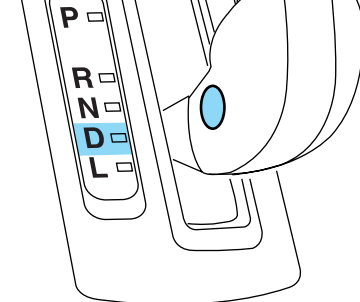
- This position allows for all forward gears (1–3) except overdrive.
 - Provides engine braking.
 - Use when driving conditions cause excessive shifting from O/D to other gears. Examples: hilly terrain, heavy loads, trailer towing and when engine braking is required.
- 
- The diagram shows a gearshift lever with a selector knob. To the left of the knob is a vertical panel with four positions labeled P, R, N, and L. The 'D' position is highlighted in blue. To the right of the knob is a circular button with a blue dot in the center, which is the O/D OFF switch. Below the diagram, the text 'O/D OFF' is printed.
- O/D
OFF
- O/D OFF lamp in the instrument cluster is illuminated.
 - To return to O/D (overdrive mode), press the transmission control switch. The O/D OFF lamp in the instrument cluster will not be illuminated.
 - O/D (overdrive) is automatically returned each time the key is turned off.

L (Low)

This position:

- Provides increased engine braking during downhill/mountain driving.
- Provides extended shift scheduling, allowing both upshifts and downshifts, at a higher overall RPM to provide optimum engine braking.
- Is not intended for use under extended or normal driving conditions and results in lower fuel economy.

If your vehicle gets stuck in mud or snow

If your vehicle gets stuck in mud or snow, it may be rocked out by shifting between forward and reverse gears, stopping between shifts in a steady pattern. Press lightly on the accelerator in each gear.

Do not rock the vehicle if the engine is not at normal operating temperature or damage to the transmission may occur.

Do not rock the vehicle for more than a minute or damage to the transmission and tires may occur, or the engine may overheat.

MANUAL TRANSMISSION OPERATION (IF EQUIPPED)

Using the clutch

Manual transmission vehicles have a starter interlock that prevents cranking the engine unless the clutch pedal is fully pressed.

To start the vehicle:

1. Make sure the parking brake is fully set.
2. Press the clutch pedal to the floor, then put the gearshift lever in the neutral position.
3. Start the engine.
4. Press the brake pedal and move the gearshift lever to the desired gear; 1 (First) or R (Reverse).

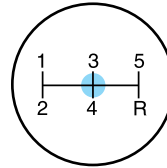

5. Release the parking brake, then slowly release the clutch pedal while slowly pressing on the accelerator.

During each shift, the clutch pedal must be fully pressed to the floor. Make sure the floor mat is properly positioned so it doesn't interfere with the full extension of the clutch pedal.

Failure to fully press the clutch pedal to the floor may cause increased shift efforts, prematurely wear transmission components or damage the transmission.

Do not drive with your foot resting on the clutch pedal or use the clutch pedal to hold your vehicle at a standstill while waiting on a hill. These actions will severely reduce the life of the clutch and could nullify a clutch warranty claim.

Driving

Recommended shift speeds

Do not downshift into 1 (First) when your vehicle is moving faster than 15 mph (24 km/h). This will damage the clutch.

Upshift according to the following chart:

Recommended upshifts (for best fuel economy) when accelerating	
5-speed manual transmission	
Shift from:	
1 - 2	14 mph (23 km/h)
2 - 3	24 mph (39 km/h)
3 - 4	32 mph (51 km/h)
4 - 5	44 mph (71 km/h)

Reverse

Make sure that your vehicle is at a complete stop before you shift into R (Reverse). Failure to do so may damage the transmission.

Hold the clutch pedal down and move the gearshift lever into the neutral position. Wait at least three seconds before shifting into R (Reverse).

Note: The gearshift lever can only be moved into R (Reverse) by moving it from left of 3 (Third) and 4 (Fourth) before shifting into R (Reverse). This is a lockout feature that protects the transmission from accidentally being shifted into R (Reverse) from 5 (Fifth).

If R (Reverse) is not fully engaged, press the clutch pedal down and return the gearshift to the neutral position. Release the clutch pedal for a moment, then press it down and shift to R (Reverse) again.

Parking your vehicle

1. Apply the brake and shift into the neutral position.
2. Fully apply the parking brake, hold the clutch pedal down, then shift into 1 (First).
3. Turn the ignition off.



WARNING: Do not park your vehicle in Neutral, it may move unexpectedly and injure someone. Use 1 (First) gear and set the parking brake fully.

Removing the key

Turn the ignition to position 1 (off) and remove the key.

188

DRIVING THROUGH WATER

If driving through deep or standing water is unavoidable, proceed very slowly especially when the depth is not known. Never drive through water that is higher than the bottom of the wheel rims (for cars) or the bottom of the hubs (for trucks).

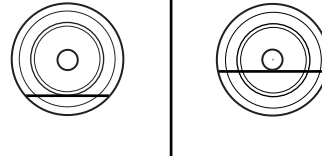

When driving through water, traction or brake capability may be limited. Also, water may enter your engine's air intake and severely damage your engine or your vehicle may stall. **Driving through deep water where the transmission vent tube is submerged may allow water into the transmission and cause internal transmission damage.**

Once through the water, always dry the brakes by moving your vehicle slowly while applying light pressure on the brake pedal. Wet brakes do not stop the vehicle as quickly as dry brakes.

Roadside Emergencies

ROADSIDE ASSISTANCE

Getting roadside assistance

To fully assist you should you have a vehicle concern, Ford Motor Company offers a complimentary roadside assistance program. This program is separate from the New Vehicle Limited Warranty. The service is available:

- 24-hours, seven days a week
- for the coverage period listed on the Roadside Assistance Card included in your Owner Guide portfolio.

Roadside assistance will cover:

- a flat tire change with a good spare (except vehicles that have been supplied with a tire inflation kit)
- battery jump start
- lock-out assistance (key replacement cost is the customer's responsibility)
- fuel delivery – Independent Service Contractors, if not prohibited by state, local or municipal law shall deliver up to 2.0 gallons (7.5L) of gasoline or 5.0 gallons (18.9L) of diesel fuel to a disabled vehicle. Fuel delivery service is limited to two no-charge occurrences within a 12-month period.
- winch out – available within 100 feet (30.5 meters) of a paved or county maintained road, no recoveries.
- towing – Ford/Mercury/Lincoln eligible vehicle towed to an authorized dealer within 35 miles (56 km) of the disablement location or to the nearest authorized dealer. If a member requests to be towed to an authorized dealer more than 35 miles (56 km) from the disablement location, the member shall be responsible for any mileage costs in excess of 35 miles (56 km).

Trailers shall be covered up to \$200 if the disabled eligible vehicle requires service at the nearest authorized dealer. If the trailer is disabled, but the towing vehicle is operational, the trailer does not qualify for any roadside services.

Roadside Emergencies

Canadian customers refer to your Warranty Guide or visit our website at www.ford.ca for information on:

Using roadside assistance

Complete the roadside assistance identification card and place it in your wallet for quick reference. In the United States, this card is found in the Owner Guide portfolio in the glove compartment. In Canada, the card is found in the *Warranty Guide* in the glove compartment.

U.S. Ford, Mercury and Lincoln vehicle customers who require Roadside Assistance, call 1-800-241-3673.

Canadian customers who require roadside assistance, call 1-800-665-2006.

If you need to arrange roadside assistance for yourself, Ford Motor Company will reimburse a reasonable amount for towing to the nearest dealership within 35 miles (56 km). To obtain reimbursement information, U.S. Ford, Mercury and Lincoln vehicle customers call 1-800-241-3673. Customers will be asked to submit their original receipts.

Canadian customers who need to obtain reimbursement information, call 1-800-665-2006 or visit our website at www.ford.ca.

HAZARD FLASHER CONTROL

The hazard flasher is located on the steering column, just behind the steering wheel. The hazard flashers will operate when the ignition is in any position or if the key is not in the ignition.

Press the flasher control and all front and rear direction signals will flash. Press the flasher control again to turn them off. Use it when your vehicle is disabled and is creating a safety hazard for other motorists.

Note: With extended use, the flasher may run down your battery.

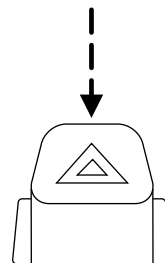

Roadside Emergencies

FUEL PUMP SHUT-OFF SWITCH

This device stops the electric fuel pump from sending fuel to the engine when your vehicle has had a substantial jolt.

After an accident, if the engine cranks but does not start, this switch may have been activated.

This switch is located in the front passenger's footwell, behind the kick panel access cover.

To reset the switch:

1. Turn the ignition off.
2. Check the fuel system for leaks.
3. If no leaks are apparent, reset the switch by pressing in on the reset button.
4. Turn the ignition to the on position.
5. Wait a few seconds and return the key to off.
6. Make another check for leaks.

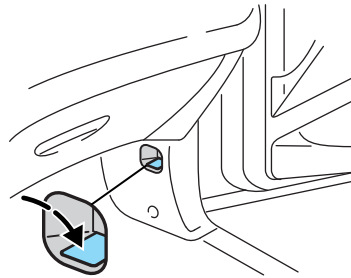

FUSES AND RELAYS

Fuses

If electrical components in the vehicle are not working, a fuse may have blown. Blown fuses are identified by a broken wire within the fuse. Check the appropriate fuses before replacing any electrical components.

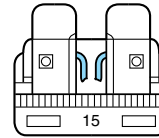

Note: Always replace a fuse with one that has the specified amperage rating. Using a fuse with a higher amperage rating can cause severe wire damage and could start a fire.

Roadside Emergencies

Standard fuse amperage rating and color

COLOR					
Fuse rating	Mini fuses	Standard fuses	Maxi fuses	Cartridge maxi fuses	Fuse link cartridge
2A	Grey	Grey	—	—	—
3A	Violet	Violet	—	—	—
4A	Pink	Pink	—	—	—
5A	Tan	Tan	—	—	—
7.5A	Brown	Brown	—	—	—
10A	Red	Red	—	—	—
15A	Blue	Blue	—	—	—
20A	Yellow	Yellow	Yellow	Blue	Blue
25A	Natural	Natural	—	—	—
30A	Green	Green	Green	Pink	Pink
40A	—	—	Orange	Green	Green
50A	—	—	Red	Red	Red
60A	—	—	Blue	Yellow	Yellow
70A	—	—	Tan	—	Brown
80A	—	—	Natural	Black	Black

Passenger compartment fuse panel

The fuse panel is located below and to the left of the steering wheel by the brake pedal. Remove the fuse panel cover to gain access to the fuses.

To remove a fuse use the fuse puller tool provided on the fuse panel cover.

Roadside Emergencies

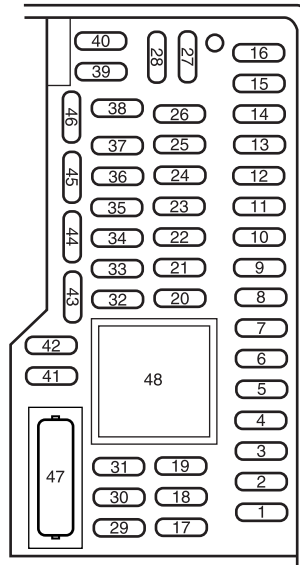

The fuses are coded as follows.

Fuse/Relay Location	Fuse Amp Rating	Protected circuits
1	30A	Not used (spare)
2	15A	Brake switch (high-mount brake lamp)
3	15A	Not used (spare)
4	30A	Not used (spare)
5	10A	Shift interlock
6	20A	Right front turn lamp/Left front turn lamp, Rear stop/turn lamps
7	10A	Left low beam headlamp
8	10A	Right low beam headlamp
9	15A	Interior lamps
10	15A	Instrument panel backlighting

Roadside Emergencies

Fuse/Relay Location	Fuse Amp Rating	Protected circuits
11	10A	Not used (spare)
12	7.5A	Power mirrors
13	5A	SYNC®
14	10A	Not used (spare)
15	10A	Recirculated air, Air conditioning
16	15A	Global positioning system (GPS) module
17	20A	Power locks, Trunk release
18	20A	Heated seats
19	25A	Not used (spare)
20	15A	Data link connector
21	15A	Fog lamps, Fog lamp indicator
22	15A	Parking lamps
23	15A	High beam lamps
24	20A	Horn
25	10A	Demand lamps, Trunk lamps
26	10A	Instrument cluster
27	20A	Ignition switch
28	5A	Radio (Start)
29	5A	Instrument cluster (run/start)
30	5A	Not used (spare)
31	10A	Not used (spare)
32	10A	Restraints control module
33	10A	Not used (spare)
34	5A	Not used (spare)
35	10A	Anti-lock brake system (ABS)
36	5A	Passive anti-theft system (PATS) module
37	10A	Climate control (run/start)
38	20A	Subwoofer

Roadside Emergencies

Fuse/Relay Location	Fuse Amp Rating	Protected circuits
39	20A	Radio, Center information display, Electronic finish panel
40	20A	Not used (spare)
41	15A	Door lock/sunroof switch illumination, Auto dimming rear view mirror, Ambient lighting
42	10A	Not used (spare)
43	10A	Heated seats relay
44	10A	Not used (spare)
45	5A	Front wipers (logic)
46	7.5A	Front passenger sensing system
47	30A (circuit breaker)	Sunroof, Power windows
48	—	Delayed accessory relay

Power distribution box

The power distribution box is located in the engine compartment. The power distribution box contains high-current fuses that protect your vehicle's main electrical systems from overloads.



WARNING: Always disconnect the battery before servicing high current fuses.



WARNING: To reduce risk of electrical shock, always replace the cover to the power distribution box before reconnecting the battery or refilling fluid reservoirs.

If the battery has been disconnected and reconnected, refer to the *Battery* section of the *Maintenance and Specifications* chapter.

Roadside Emergencies

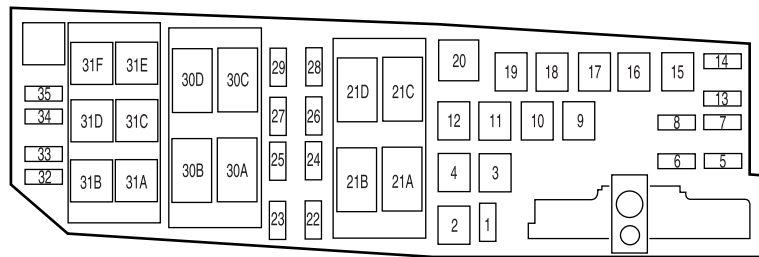

To remove a fuse, use the fuse puller tool provided on the inside of the passenger compartment fuse panel cover.

The high-current fuses are coded as follows:

Fuse/Relay Location	Fuse Amp Rating	Protected circuits
1	15A	Heated mirror
2	30A	Rear defrost
3	20A	Power point
4	20A	Fuel pump
5	10A	Powertrain control module (PCM) keep alive power, Canister Vent
6	15A	Alt sense
7	10A	Reverse lamps
8	—	Not used
9	40A	Anti-lock brake system (ABS) motor
10	30A	Wipers
11	30A	Starter
12	40A	Blower
13	10A	A/C clutch
14	10A	PCM relay coil
15	20A	Power point
16	20A	Cooling fan – low
17	30A	Cooling fan – high

Roadside Emergencies

Fuse/Relay Location	Fuse Amp Rating	Protected circuits
18	20A	ABS solenoid
19	—	Not used
20	—	A/C clutch relay
21A		Rear defrost relay
21B	—	Not used
21C	—	Blower relay
21D	—	PCM relay
22	10A	Fuel injector
23	—	Not used
24	—	Not used
25	—	Not used
26	15A	PCM – emission related powertrain components
27	—	Not used
28	15A	PCM
29	15A	Ignition
30A	—	Cooling fan low speed relay
30B	—	Starter relay
30C	—	Not used
30D	—	Cooling fan high speed relay
31A	—	Reverse lamp relay
31B	—	Fuel pump relay
31C	—	Wiper power relay
31D	—	Not used
31E	—	Not used
31F	—	Not used
32	—	Not used
33	—	EEC diode
34	—	One-touch integrated start (OTIS) diode
35	10A	Run/Start

Roadside Emergencies

CHANGING THE TIRES

If you get a flat tire while driving, do not apply the brake heavily. Instead, gradually decrease your speed. Hold the steering wheel firmly and slowly move to a safe place on the side of the road.

Note: The tire pressure monitoring system (TPMS) indicator light will illuminate when the spare tire is in use. To restore the full functionality of the monitoring system, all road wheels equipped with tire pressure monitoring sensors must be mounted on the vehicle.

Have a flat serviced by an authorized dealer in order to prevent damage to the TPMS sensors, refer to *Tire pressure monitoring system (TPMS)* in the *Tires, Wheels and Loading* chapter. Replace the spare tire with a road tire as soon as possible. During repairing or replacing of the flat tire, have the authorized dealer inspect the TPMS sensor for damage.



WARNING: The use of tire sealants may damage your tire pressure monitoring system (TPMS) and should not be used. However, if you must use a sealant, the TPMS sensor and valve stem on the wheel must be replaced by an authorized Ford dealer.



WARNING: Refer to *Tire pressure monitoring system (TPMS)* in the *Tires, Wheels and Loading* chapter for important information. If the tire pressure monitor sensor becomes damaged, it will no longer function.

Dissimilar spare tire/wheel information



WARNING: Failure to follow these guidelines could result in an increased risk of loss of vehicle control, injury or death.

If you have a dissimilar spare tire/wheel, then it is intended for temporary use only. This means that if you need to use it, you should replace it as soon as possible with a road tire/wheel that is the same size and type as the road tires and wheels that were originally provided by Ford. If the dissimilar spare tire or wheel is damaged, it should be replaced rather than repaired.

Roadside Emergencies

A dissimilar spare tire/wheel is defined as a spare tire and/or wheel that is different in brand, size or appearance from the road tires and wheels and can be one of three types:

1. **T-type mini-spare:** This spare tire begins with the letter “T” for tire size and may have “Temporary Use Only” molded in the sidewall
2. **Full-size dissimilar spare with label on wheel:** This spare tire has a label on the wheel that states: “THIS TIRE AND WHEEL FOR TEMPORARY USE ONLY”

When driving with one of the dissimilar spare tires listed above, **do not:**

- Exceed 50 mph (80 km/h)
- Load the vehicle beyond maximum vehicle load rating listed on the Safety Compliance Label
- Tow a trailer
- Use snow chains on the end of the vehicle with the dissimilar spare tire
- Use more than one dissimilar spare tire at a time
- Use commercial car washing equipment
- Try to repair the dissimilar spare tire

Use of one of the dissimilar spare tires listed above at any one wheel location can lead to impairment of the following:

- Handling, stability and braking performance
- Comfort and noise
- Ground clearance and parking at curbs
- Winter weather driving capability
- Wet weather driving capability

3. **Full-size dissimilar spare without label on wheel**

When driving with the full-size dissimilar spare tire/wheel, **do not:**

- Exceed 70 mph (113 km/h)
- Use more than one dissimilar spare tire/wheel at a time
- Use commercial car washing equipment
- Use snow chains on the end of the vehicle with the dissimilar spare tire/wheel

Roadside Emergencies

The usage of a full-size dissimilar spare tire/wheel can lead to impairment of the following:

- Handling, stability and braking performance
- Comfort and noise
- Ground clearance and parking at curbs
- Winter weather driving capability
- Wet weather driving capability
- All-wheel driving capability (if applicable)
- Load leveling adjustment (if applicable)

When driving with the full-size dissimilar spare tire/wheel additional caution should be given to:

- Towing a trailer
- Driving vehicles equipped with a camper body
- Driving vehicles with a load on the cargo rack

Drive cautiously when using a full-size dissimilar spare tire/wheel and seek service as soon as possible.

Stopping and securing the vehicle

1. Park on a level surface, set the parking brake and activate the hazard flashers.
2. Place the gearshift lever in P (Park) (automatic transmission) or R (Reverse) (manual transmission) and turn the engine off.

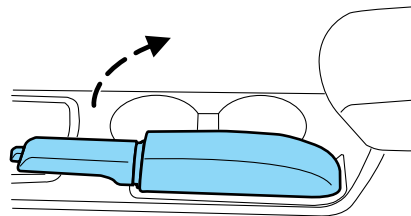

Roadside Emergencies

Removing the spare tire and jack

Remove the spare tire and jack by turning their tie-down bolts counterclockwise. The lug wrench is located in a bag next to, or on top of, the spare tire.

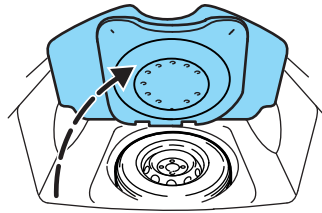

Tire change procedure

! **WARNING:** When one of the front wheels is off the ground, the transmission alone will not prevent the vehicle from moving or slipping off the jack, even if the vehicle is in P (Park) (automatic transmission) or R (Reverse) (manual transmission).

! **WARNING:** To help prevent the vehicle from moving when you change a tire, be sure the parking brake is set, then block (in both directions) the wheel that is diagonally opposite (other side and end of the vehicle) to the tire being changed.

! **WARNING:** If the vehicle slips off the jack, you or someone else could be seriously injured.

! **WARNING:** Do not attempt to change a tire on the side of the vehicle close to moving traffic. Pull far enough off the road to avoid the danger of being hit when operating the jack or changing the wheel.

Note: Passengers should not remain in the vehicle when the vehicle is being jacked.

Roadside Emergencies

1. Block the diagonally opposite wheel.

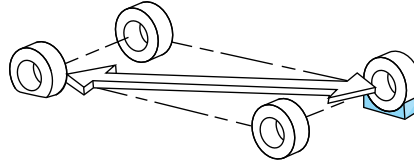

2. If equipped with a 6-spoke wheel cover that's bolted on, remove the four plastic nuts by turning counterclockwise 1/4 turn for access to the lug nuts.

Note: To avoid damage to the wheel cover, the 6-spoke wheel cover cannot be removed until the tire is off the vehicle.

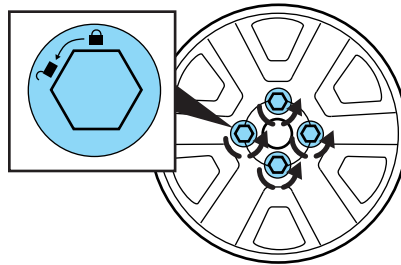

3. Loosen each wheel lug nut one-half turn counterclockwise but do not remove them until the wheel is raised off the ground.

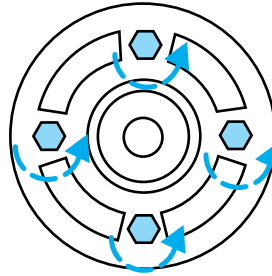

Roadside Emergencies

4. The vehicle jacking points are depicted on the yellow warning label on the jack shown here. Depending on which tire is to be changed, put the jack approximately 7 inches (18 cm) from the front wheel opening (1) or approximately 17 inches (43 cm) from the rear wheel opening (2).

Jack at the specified locations to avoid damage to the vehicle.



WARNING: To lessen the risk of personal injury, do not put any part of your body under the vehicle while changing a tire. Do not start the engine when your vehicle is on the jack. The jack is only meant for changing the tire.

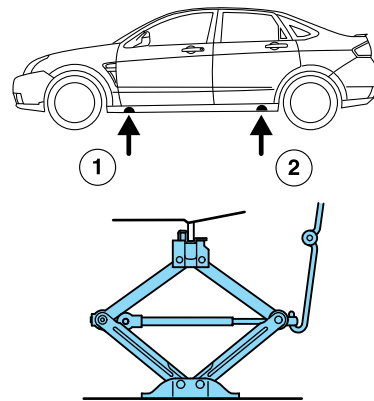

5. Remove the lug nuts with the lug wrench.

6. Replace the flat tire with the spare tire, making sure the valve stem is facing outward. Reinstall the lug nuts until the wheel is snug against the hub. Do not fully tighten the lug nuts until the wheel has been lowered.

7. Lower the wheel by turning the jack handle counterclockwise.

8. Remove the jack and fully tighten the lug nuts in the order shown. Refer to *Wheel lug nut torque specifications* later in this chapter for the proper lug nut torque specification.

9. Put the flat tire, jack and lug wrench away. Make sure the jack is fastened so it does not rattle when you drive. Unblock the wheels.

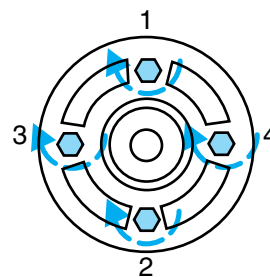

Roadside Emergencies

WHEEL LUG NUT TORQUE SPECIFICATIONS

Retighten the lug nuts to the specified torque at 500 miles (800 km) after any wheel disturbance (tire rotation, changing a flat tire, wheel removal, etc.).

Bolt size	Wheel lug nut torque*	
	ft-lb	N•m
M12 x 1.5	100	135

* Torque specifications are for nut and bolt threads free of dirt and rust. Use only Ford recommended replacement fasteners.

 **WARNING:** When a wheel is installed, always remove any corrosion, dirt or foreign materials present on the mounting surfaces of the wheel or the surface of the wheel hub, brake drum or brake disc that contacts the wheel. Ensure that any fasteners that attach the rotor to the hub are secured so they do not interfere with the mounting surfaces of the wheel. Installing wheels without correct metal-to-metal contact at the wheel mounting surfaces can cause the wheel nuts to loosen and the wheel to come off while the vehicle is in motion, resulting in loss of control.

Note: Inspect the wheel pilot hole prior to installation. If there is visible corrosion in wheel pilot hole, remove loose particles by wiping with clean rag and apply grease. Apply grease only to the wheel pilot hole surface by smearing a “dime” (1 square cm) sized glob of grease around the wheel pilot surface (1) with end of finger. DO NOT apply grease to lugnut/stud holes or wheel-to-brake surfaces.

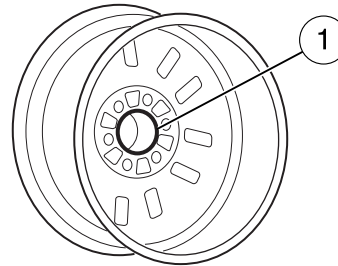

Roadside Emergencies

JUMP STARTING



WARNING: The gases around the battery can explode if exposed to flames, sparks, or lit cigarettes. An explosion could result in injury or vehicle damage.



WARNING: Batteries contain sulfuric acid which can burn skin, eyes and clothing, if contacted.

Do not attempt to push-start your automatic transmission vehicle. Automatic transmissions do not have push-start capability. Attempting to push-start a vehicle with an automatic transmission may cause transmission damage.

Preparing your vehicle

When the battery is disconnected or a new battery is installed, the automatic transmission must relearn its shift strategy. As a result, the transmission may have firm and/or soft shifts. This operation is considered normal and will not affect function or durability of the transmission. Over time, the adaptive learning process will fully update transmission operation.

1. **Use only a 12-volt supply to start your vehicle.**
2. Do not disconnect the battery of the disabled vehicle as this could damage the vehicle's electrical system.
3. Park the booster vehicle close to the hood of the disabled vehicle making sure the two vehicles **do not** touch. Set the parking brake on both vehicles and stay clear of the engine cooling fan and other moving parts.
4. Check all battery terminals and remove any excessive corrosion before you attach the battery cables. Ensure that vent caps are tight and level.
5. Turn the heater fan on in both vehicles to protect from any electrical surges. Turn all other accessories off.

Roadside Emergencies

Connecting the jumper cables

Note: In the illustration, the vehicle on the bottom is used to designate the assisting (boosting) battery.

1. Connect the positive (+) jumper cable to the positive (+) terminal of the discharged battery.
2. Connect the other end of the positive (+) cable to the positive (+) terminal of the assisting battery.
3. Connect the negative (-) cable to the negative (-) terminal of the assisting battery.
4. Make the final connection of the negative (-) cable to an exposed metal part of the stalled vehicle's engine, away from the battery and the carburetor/fuel injection system.

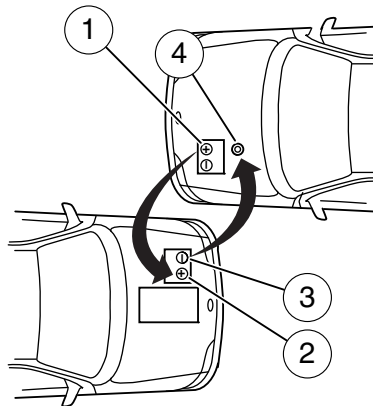

Note: Do not attach the negative (-) cable to fuel lines, engine rocker covers, the intake manifold or electrical components as grounding points.



WARNING: Do not connect the end of the second cable to the negative (-) terminal of the battery to be jumped. A spark may cause an explosion of the gases that surround the battery.

Ensure that the cables are clear of fan blades, belts, moving parts of both engines, or any fuel delivery system parts.

Jump starting

1. Start the engine of the booster vehicle and run the engine at moderately increased speed.
2. Start the engine of the disabled vehicle.
3. Once the disabled vehicle has been started, run both engines for an additional three minutes before disconnecting the jumper cables.

207

Roadside Emergencies

Removing the jumper cables

Remove the jumper cables in the reverse order that they were connected.

Note: In the illustration, the vehicle on the bottom is used to designate the assisting (boosting) battery.

1. Remove the jumper cable from the ground metal surface.
2. Remove the jumper cable on the negative (-) terminal of the booster vehicle's battery.
3. Remove the jumper cable from the positive (+) terminal of the booster vehicle's battery.
4. Remove the jumper cable from the positive (+) terminal of the disabled vehicle's battery.

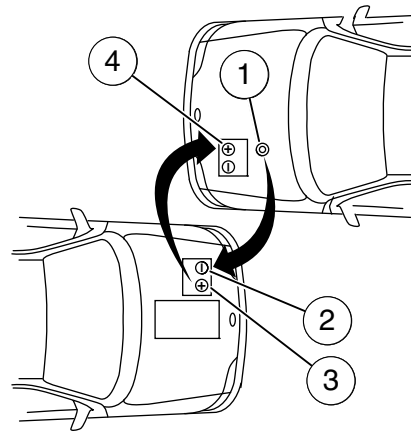

After the disabled vehicle has been started and the jumper cables removed, allow it to idle for several minutes so the engine computer can relearn its idle conditions.

Roadside Emergencies

WRECKER TOWING

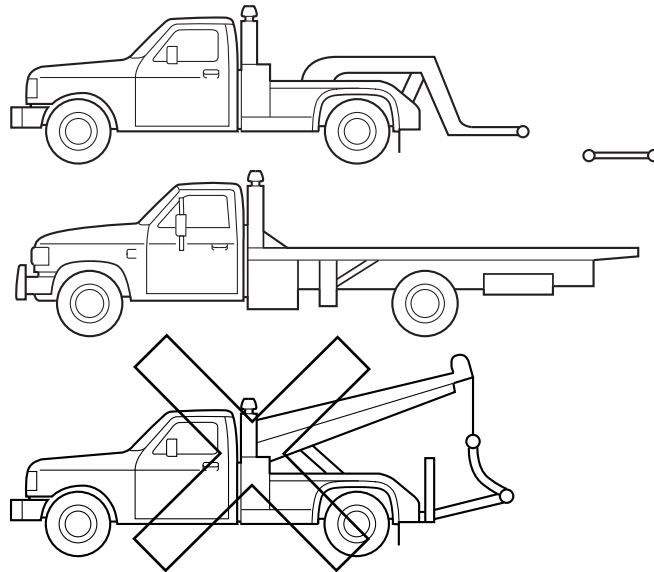

If you need to have your vehicle towed, contact a professional towing service or, if you are a member of a roadside assistance program, your roadside assistance service provider.

It is recommended that your vehicle be towed with a wheel lift or flatbed equipment. Do not tow with a slingbelt. Ford Motor Company has not approved a slingbelt towing procedure.

If your vehicle is to be towed from the rear using wheel lift equipment, the front wheels (drive wheels) must be placed on a dolly to prevent damage to the transmission.

If the vehicle is towed by other means or incorrectly, vehicle damage may occur.

Ford Motor Company produces a towing manual for all authorized tow truck operators. Have your tow truck operator refer to this manual for proper hook-up and towing procedures for your vehicle.

Roadside Emergencies

Emergency towing

In case of a roadside emergency with a disabled vehicle (without access to wheel dollies, car hauling trailer, or flatbed transport vehicle) your vehicle (regardless of transmission powertrain configuration) can be flat towed (all wheels on the ground) under the following conditions:

- Vehicle is facing forward so that it is being towed in a forward direction.
- Place the transmission in N (Neutral). Refer to *Brake-shift interlock* in the *Driving* chapter for specific instructions if you cannot move the gear shift lever into N (Neutral).
- Maximum speed is not to exceed 35 mph (56 km/h).
- Maximum distance is 50 miles (80 km).

Customer Assistance

GETTING THE SERVICES YOU NEED

Warranty repairs to your vehicle must be performed by an authorized Ford, Lincoln, or Mercury dealer. While any authorized dealer handling your vehicle line will provide warranty service, we recommend you return to your selling authorized dealer who wants to ensure your continued satisfaction.

Please note that certain warranty repairs require special training and/or equipment, so not all authorized dealers are authorized to perform all warranty repairs. This means that, depending on the warranty repair needed, you may have to take your vehicle to another authorized dealer.

A reasonable time must be allowed to perform a repair after taking your vehicle to the authorized dealer. Repairs will be made using Ford or Motorcraft® parts, or remanufactured or other parts that are authorized by Ford.

Away from home

If you are away from home when your vehicle needs service, contact the Ford Customer Relationship Center or use the online resources listed below to find the nearest authorized dealer.

In the United States:

Mailing address

Ford Motor Company
Customer Relationship Center
P.O. Box 6248
Dearborn, MI 48121

Telephone

1-800-392-3673 (FORD)
(TDD for the hearing impaired: 1-800-232-5952)

Online

Additional information and resources are available online at www.genuineservice.com.

- U.S. dealer locator by Dealer Name, City/State, or Zip Code
- Owner Guides
- Maintenance Schedules
- Recalls
- Ford Extended Service Plans
- Ford Genuine Accessories
- Service specials and promotions.

Customer Assistance

In Canada:

Mailing address (Ford vehicles)

Customer Relationship Centre
Ford Motor Company of Canada, Limited
P.O. Box 2000
Oakville, Ontario L6J 5E4

Telephone

1-800-565-3673 (FORD)

Online

www.ford.ca

Mailing address (Lincoln vehicles)

Lincoln Centre
Ford Motor Company of Canada, Limited
P.O. Box 2000
Oakville, Ontario L6J 5E4

Telephone

1-800-387-9333

Online

www.lincolncanada.com

Additional assistance

If you have questions or concerns, or are unsatisfied with the service you are receiving, follow these steps:

1. Contact your Sales Representative or Service Advisor at your selling/servicing authorized dealer.
2. If your inquiry or concern remains unresolved, contact the Sales Manager, Service Manager or Customer Relations Manager.
3. If you require assistance or clarification on Ford Motor Company policies, please contact the Ford Customer Relationship Center

In order to help you serve you better, please have the following information available when contacting a Customer Relationship Center:

- Vehicle Identification Number (VIN)
- Your telephone number (home and business)
- The name of the authorized dealer and city where located
- The vehicle's current odometer reading

In some states, you must directly notify Ford in writing before pursuing remedies under your state's warranty laws. Ford is also allowed a final repair attempt in some states.

212

Customer Assistance

In the United States, a warranty dispute must be submitted to the BBB AUTO LINE before taking action under the Magnuson-Moss Warranty Act, or to the extent allowed by state law, before pursuing replacement or repurchase remedies provided by certain state laws. This dispute handling procedure is not required prior to enforcing state created rights or other rights which are independent of the Magnuson-Moss Warranty Act or state replacement or repurchase laws.

IN CALIFORNIA (U.S. ONLY)

California Civil Code Section 1793.2(d) requires that, if a manufacturer or its representative is unable to repair a motor vehicle to conform to the vehicle's applicable express warranty after a reasonable number of attempts, the manufacturer shall be required to either replace the vehicle with one substantially identical or repurchase the vehicle and reimburse the buyer in an amount equal to the actual price paid or payable by the consumer (less a reasonable allowance for consumer use). The consumer has the right to choose whether to receive a refund or replacement vehicle.

California Civil Code Section 1793.22(b) presumes that the manufacturer has had a reasonable number of attempts to conform the vehicle to its applicable express warranties if, within the first 18 months of ownership of a new vehicle or the first 18,000 miles (29,000 km), whichever occurs first:

1. Two or more repair attempts are made on the same non-conformity likely to cause death or serious bodily injury OR
2. Four or more repair attempts are made on the same nonconformity (a defect or condition that substantially impairs the use, value or safety of the vehicle) OR
3. The vehicle is out of service for repair of nonconformities for a total of more than 30 calendar days (not necessarily all at one time)

In the case of 1 or 2 above, the consumer must also notify the manufacturer of the need for the repair of the nonconformity at the following address:

Ford Motor Company
16800 Executive Plaza Drive
Mail Drop 3NE-B
Dearborn, MI 48126

Customer Assistance

You are required to submit your warranty dispute to BBB AUTO LINE before asserting in court any rights or remedies conferred by California Civil Code Section 1793.22(b). You are also required to use BBB AUTO LINE before exercising rights or seeking remedies created by the Federal Magnuson-Moss Warranty Act, 15 U.S.C. sec. 2301 et seq. If you choose to seek redress by pursuing rights and remedies not created by California Civil Code Section 1793.22(b) or the Magnuson-Moss Warranty Act, resort to BBB AUTO LINE is not required by those statutes.

THE BETTER BUSINESS BUREAU (BBB) AUTO LINE PROGRAM (U.S. ONLY)

Your satisfaction is important to Ford Motor Company and to your dealer. If a warranty concern has not been resolved using the three-step procedure outlined on the first page of the *Customer Assistance* section, you may be eligible to participate in the BBB AUTO LINE program.

The BBB AUTO LINE program consists of two parts – mediation and arbitration. During mediation, a representative of the BBB will contact both you and Ford Motor Company to explore options for settlement of the claim. If an agreement is not reached during mediation or you do not want to participate in mediation, and if your claim is eligible, you may participate in the arbitration process. An arbitration hearing will be scheduled so that you can present your case in an informal setting before an impartial person. The arbitrator will consider the testimony provided and make a decision after the hearing.

Disputes submitted to the BBB AUTO LINE program are usually decided within forty days after you file your claim with the BBB. You are not bound by the decision, and may reject the decision and proceed to court where all findings of the BBB Auto Line dispute, and decision, are admissible in the court action. Should you choose to accept the BBB AUTO LINE decision, Ford is then bound by the decision, and must comply with the decision within 30 days of receipt of your acceptance letter.

BBB AUTO LINE Application: Using the information provided below, please call or write to request a program application. You will be asked for your name and address, general information about your new vehicle, information about your warranty concerns, and any steps you have already taken to try to resolve them. A Customer Claim Form will be mailed that will need to be completed, signed and returned to the BBB along with proof of ownership. Upon receipt, the BBB will review the claim for eligibility under the Program Summary Guidelines.

214

Customer Assistance

You can get more information by calling BBB AUTO LINE at 1-800-955-5100, or writing to:

**BBB AUTO LINE
4200 Wilson Boulevard, Suite 800
Arlington, Virginia 22203-1833**

BBB AUTO LINE applications can also be requested by calling the Ford Motor Company Customer Relationship Center at 1-800-392-3673.

Note: Ford Motor Company reserves the right to change eligibility limitations, modify procedures, or to discontinue this process at any time without notice and without obligation.

UTILIZING THE MEDIATION/ARBITRATION PROGRAM (CANADA ONLY)

For vehicles delivered to authorized Canadian dealers. In those cases where you continue to feel that the efforts by Ford of Canada and the authorized dealer to resolve a factory-related vehicle service concern have been unsatisfactory, Ford of Canada participates in an impartial third party mediation/arbitration program administered by the Canadian Motor Vehicle Arbitration Plan (CAMVAP).

The CAMVAP program is a straight forward and relatively speedy alternative to resolve a disagreement when all other efforts to produce a settlement have failed. This procedure is without cost to you and is designed to eliminate the need for lengthy and expensive legal proceedings.

In the CAMVAP program, impartial third-party arbitrators conduct hearings at mutually convenient times and places in an informal environment. These impartial arbitrators review the positions of the parties, make decisions and, when appropriate, render awards to resolve disputes. CAMVAP decisions are fast, fair, and final as the arbitrator's award is binding on both you and Ford of Canada.

CAMVAP services are available in all Canadian territories and provinces. For more information, without charge or obligation, call your CAMVAP Provincial Administrator directly at 1-800-207-0685 or visit www.camvap.ca.

Customer Assistance

GETTING ASSISTANCE OUTSIDE THE U.S. AND CANADA

Before exporting your vehicle to a foreign country, contact the appropriate foreign embassy or consulate. These officials can inform you of local vehicle registration regulations and where to find unleaded fuel.

If you cannot find unleaded fuel or can only get fuel with an anti-knock index lower than is recommended for your vehicle, contact a regional office or owner relations/customer relationship office.

The use of leaded fuel in your vehicle without proper conversion may damage the effectiveness of your emission control system and may cause engine knocking or serious engine damage. Ford Motor Company/Ford of Canada is not responsible for any damage caused by use of improper fuel. Using leaded fuel may also result in difficulty importing your vehicle back into the U.S.

If your vehicle must be serviced while you are traveling or living in Asia-Pacific Region, Sub-Saharan Africa, U.S. Virgin Islands, Central America, the Caribbean, and Israel, contact the nearest authorized dealer. If the authorized dealer cannot help you, contact:

FORD MOTOR COMPANY
FORD EXPORT OPERATIONS
1555 Fairlane Drive
Fairlane Business Park #3
Allen Park, Michigan 48101
U.S.A.
Telephone: (313) 594-4857
FAX: (313) 390-0804
Email: expcac@ford.com

If your vehicle must be serviced while you are traveling or living in Puerto Rico, contact the nearest authorized dealer. If the authorized dealer cannot help you, contact:

Ford International Business Development Inc.
Customer Assistance Center
P.O. Box 11957
Caparra Heights Station
San Juan, Puerto Rico 00922-1957
Telephone: (800) 841-FORD (3673)
FAX: (313) 390-0804
Email: prcac@ford.com

Customer Assistance

If your vehicle must be serviced while you are traveling or living in the Middle East, contact the nearest authorized dealer. If the authorized dealer cannot help you, contact:

Ford Middle East
Customer Relationship Center
P.O. Box 21470
Dubai, United Arab Emirates
Telephone: +971 4 3326084
FAX: +971 4 3327299
Email: menacac@ford.com
www.me.ford.com

If you buy your vehicle in North America and then relocate to any of the above locations, register your vehicle identification number (VIN) and new address with Ford Motor Company Export Operations.

If you are in another foreign country, contact the nearest authorized dealer. If the authorized dealer employees cannot help you, they can direct you to the nearest Ford affiliate office.

Customers in the U.S. should call 1-800-392-3673.

ORDERING ADDITIONAL OWNER'S LITERATURE

To order the publications in this portfolio, contact Helm, Incorporated at:

HELM, INCORPORATED
P.O. Box 07150
Detroit, Michigan 48207

Or to order a free publication catalog, call toll free: 1-800-782-4356

Monday-Friday 8:00 a.m. - 6:00 p.m. EST

Helm, Incorporated can also be reached by their website:
www.helminc.com.

(Items in this catalog may be purchased by credit card, check or money order.)

Obtaining a French Owner's Guide

French Owner's Guides can be obtained from your authorized dealer or by contacting Helm, Incorporated using the contact information listed previously in this section.

217

**2011 Focus (foc)
Owners Guide, 1st Printing
USA (fus)**

Customer Assistance

REPORTING SAFETY DEFECTS (U.S. ONLY)

If you believe that your vehicle has a defect which could cause a crash or could cause injury or death, you should immediately inform the National Highway Traffic Safety Administration (NHTSA) in addition to notifying Ford Motor Company.



If NHTSA receives similar complaints, it may open an investigation, and if it finds that a safety defect exists in a group of vehicles, it may order a recall and remedy campaign. However, NHTSA cannot become involved in individual problems between you, your dealer, or Ford Motor Company.

To contact NHTSA, you may call the Vehicle Safety Hotline toll-free at 1-888-327-4236 (TTY: 1-800-424-9153); go to <http://www.safercar.gov>; or write to:

Administrator
1200 New Jersey Avenue, Southeast
Washington, D.C. 20590

You can also obtain other information about motor vehicle safety from <http://www.safercar.gov>.

REPORTING SAFETY DEFECTS (CANADA ONLY)

If you believe that your vehicle has a defect which could cause a crash or could cause injury or death, you should immediately inform Transport Canada, using their toll-free number: 1-800-333-0510, or online at: <https://wwwapps.tc.gc.ca/Saf-Sec-Sur/7/PCDB-BDPP/Index.aspx>.

WASHING THE EXTERIOR

Wash your vehicle regularly with cool or lukewarm water and a neutral pH shampoo, such as Motorcraft® Detail Wash (ZC-3-A), which is available from your authorized dealer.

- Never use strong household detergents or soap, such as dish washing or laundry liquid. These products can discolor and spot painted surfaces.
- Never wash a vehicle that is “hot to the touch” or during exposure to strong, direct sunlight.
- Always use a clean sponge or car wash mitt with plenty of water for best results.
- Dry the vehicle with a chamois or soft terry cloth towel in order to eliminate water spotting.
- It is especially important to wash the vehicle regularly during the winter months, as dirt and road salt are difficult to remove and cause damage to the vehicle.
- Immediately remove items such as gasoline, diesel fuel, bird droppings and insect deposits because they can cause damage to the vehicle’s paintwork and trim over time. Use Motorcraft® Bug and Tar Remover (ZC-42) which is available from your authorized dealer.
- Remove any exterior accessories, such as antennas, before entering a car wash.
- **Suntan lotions and insect repellents can damage any painted surface; if these substances come in contact with your vehicle, wash off as soon as possible.**

Exterior chrome

- Wash the vehicle first, using cool or lukewarm water and a neutral pH shampoo, such as Motorcraft® Detail Wash (ZC-3-A).
- Use Motorcraft® Custom Bright Metal Cleaner (ZC-15), available from your authorized dealer. Apply the product as you would a wax to clean bumpers and other chrome parts; allow the cleaner to dry for a few minutes, then wipe off the haze with a clean, dry rag.
- **Never use abrasive materials such as steel wool or plastic pads as they can scratch the chrome surface.**

WAXING

- Wash the vehicle first.
- Use a quality wax that does not contain abrasives.

Cleaning

- Do not allow paint sealant to come in contact with any non-body (low-gloss black) colored trim, such as grained door handles, roof racks, bumpers, side moldings, mirror housings or the windshield cowl area. The paint sealant will “gray” or stain the parts over time.

PAINT CHIPS

Your authorized dealer has touch-up paint to match your vehicle’s color. Take your color code (printed on a sticker in the driver’s door jamb) to your authorized dealer to ensure you get the correct color.

- Remove particles such as bird droppings, tree sap, insect deposits, tar spots, road salt and industrial fallout before repairing paint chips.
- Always read the instructions before using the products.

ALUMINUM WHEELS AND WHEEL COVERS

Aluminum wheels and wheel covers are coated with a clearcoat paint finish. In order to maintain their shine:

- Clean weekly with Motorcraft® Wheel and Tire Cleaner (ZC-37-A), which is available from your authorized dealer. Heavy dirt and brake dust accumulation may require agitation with a sponge. Rinse thoroughly with a strong stream of water.
- Never apply any cleaning chemical to hot or warm wheel rims or covers.
- Some automatic car washes may cause damage to the finish on your wheel rims or covers. Industrial-strength (heavy-duty) cleaners, or cleaning chemicals, in combination with brush agitation to remove brake dust and dirt, could wear away the clearcoat finish over time.
- Do not use hydrofluoric acid-based or high caustic-based wheel cleaners, steel wool, fuels or strong household detergent.
- To remove tar and grease, use Motorcraft® Bug and Tar Remover (ZC-42), available from your authorized dealer.

ENGINE

Engines are more efficient when they are clean because grease and dirt buildup keep the engine warmer than normal.

When washing:

- Take care when using a power washer to clean the engine. The high-pressure fluid could penetrate the sealed parts and cause damage.

220

Cleaning

- Do not spray a hot engine with cold water to avoid cracking the engine block or other engine components.
- Spray Motorcraft® Engine Shampoo and Degreaser (ZC-20) on all parts that require cleaning and pressure rinse clean. In Canada, use Motorcraft® Engine Shampoo (CXC-66-A).
- Never wash or rinse the engine while it is hot or running; water in the running engine may cause internal damage.
- Never wash or rinse any ignition coil, spark plug wire or spark plug well, or the area in and around these locations.
- Cover the highlighted areas to prevent water damage when cleaning the engine.

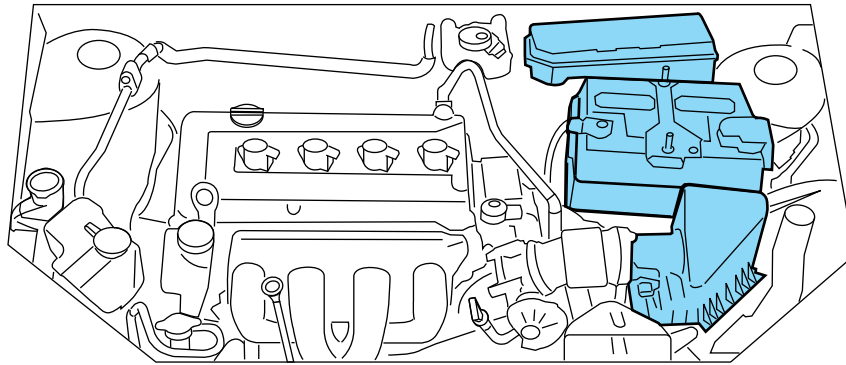

PLASTIC (NON-PAINTED) EXTERIOR PARTS

Use only approved products to clean plastic parts. These products are available from your authorized dealer.

- For routine cleaning, use Motorcraft® Detail Wash (ZC-3-A).
- If tar or grease spots are present, use Motorcraft® Bug and Tar Remover (ZC-42).

WINDOWS AND WIPER BLADES

The windshield, rear and side windows and the wiper blades should be cleaned regularly. If the wipers do not wipe properly, substances on the vehicle's glass or the wiper blades may be the cause. These may include hot wax treatments used by commercial car washes, water repellent coatings, tree sap, or other organic contamination; these contaminants

Cleaning

may cause squeaking or chatter noise from the blades, and streaking and smearing of the windshield. To clean these items, follow these tips:

- The windshield, rear windows and side windows may be cleaned with a non-abrasive cleaner such as Motorcraft® Ultra-Clear Spray Glass Cleaner (ZC-23), available from your authorized dealer.
- The wiper blades can be cleaned with isopropyl (rubbing) alcohol or Motorcraft® Premium Windshield Washer Concentrate (ZC-32-A) in the U.S., or Premium Quality Windshield Washer Fluid [CXC-37-(A, B, D, or F)] in Canada, available from your authorized dealer. This washer fluid contains special solution in addition to alcohol which helps to remove the hot wax deposited on the wiper blade and windshield from automated car wash facilities. Be sure to replace wiper blades when they appear worn or do not function properly.
- Do not use abrasives, as they may cause scratches.
- Do not use fuel, kerosene, or paint thinner to clean any parts.

If you cannot remove those streaks after cleaning with the glass cleaner or if the wipers chatter and move in a jerky motion, clean the outer surface of the windshield and the wiper blades using a sponge or soft cloth with a neutral detergent or mild-abrasive cleaning solution. After cleaning, rinse the windshield and wiper blades with clean water. The windshield is clean if beads do not form when you rinse the windshield with water.

Do not use sharp objects, such as a razor blade, to clean the inside of the rear window or to remove decals, as it may cause damage to the rear window defroster's heated grid lines.

INSTRUMENT PANEL/INTERIOR TRIM AND CLUSTER LENS

Clean the instrument panel, interior trim areas and cluster lens with a clean, damp, white cotton cloth, then use a clean and dry white cotton cloth to dry these areas.

- Avoid cleaners or polishes that increase the gloss of the upper portion of the instrument panel. The dull finish in this area helps protect the driver from undesirable windshield reflection.
- Be certain to wash or wipe your hands clean if you have been in contact with certain products such as insect repellent and suntan lotion in order to avoid possible damage to the interior painted surfaces.
- Do not use household or glass cleaners as these may damage the finish of the instrument panel, interior trim and cluster lens.

222

Cleaning

- Do not allow air fresheners and hand sanitizers to spill on interior surfaces. If a spill occurs, **wipe off immediately**. Damage may not be covered by your warranty.



WARNING: Do not use chemical solvents or strong detergents when cleaning the steering wheel or instrument panel to avoid contamination of the airbag system.

If a staining liquid like coffee/juice has been spilled on the instrument panel or on interior trim surfaces, clean as follows:

1. Wipe up spilled liquid using a clean, white, cotton cloth.
2. Wipe the surface with a damp, clean, white cotton cloth. For more thorough cleaning, use a mild soap and water solution. If the spot cannot be completely cleaned by this method, the area may be cleaned using a commercially available cleaning product designed for automotive interiors.
3. If necessary, apply more soap and water solution or cleaning product to a clean, white, cotton cloth and press the cloth onto the soiled area—allow this to set at room temperature for 30 minutes.
4. Remove the soaked cloth, and if it is not soiled badly, use this cloth to clean the area by using a rubbing motion for 60 seconds.
5. Following this, wipe area dry with a clean, white, cotton cloth.

INTERIOR

For fabric, carpets, cloth seats, safety belts and seats equipped with side airbags:

- Remove dust and loose dirt with a vacuum cleaner.
- Remove light stains and soil with Motorcraft® Professional Strength Carpet & Upholstery Cleaner (ZC-54).
- If grease or tar is present on the material, spot-clean the area first with Motorcraft® Spot and Stain Remover (ZC-14). In Canada, use Motorcraft® Multi-Purpose Cleaner (CXC-101).
- If a ring forms on the fabric after spot cleaning, clean the entire area immediately (but do not oversaturate) or the ring will set.
- Do not use household cleaning products or glass cleaners, which can stain and discolor the fabric and affect the flame retardant abilities of the seat materials.

223

Cleaning



WARNING: Do not use cleaning solvents, bleach or dye on the vehicle's safety belts, as these actions may weaken the belt webbing.



WARNING: On vehicles equipped with seat-mounted airbags, do not use chemical solvents or strong detergents. Such products could contaminate the side-airbag system and affect performance of the side airbag in a collision.

LEATHER SEATS (IF EQUIPPED, EXCEPT FOR THE KING RANCH® EDITION)

For King Ranch® leather seats, refer to a separate section in this chapter.

- Clean spills and stains as quickly as possible.
- For routine cleaning, wipe the surface with a soft, damp cloth. For more thorough cleaning, wipe the surface with a mild soap and water solution. In Canada, use Motorcraft® Vinyl Cleaner (CXC-93). Dry the area with a soft cloth.
- If the leather cannot be completely cleaned using a mild soap and water solution, the leather may be cleaned using a commercially available leather cleaning product designed for automotive interiors.
- To check for compatibility, first test any cleaner or stain remover on an inconspicuous part of the leather.
- Do not use household cleaning products, alcohol solutions, solvents or cleaners intended for rubber, vinyl and plastics, or oil/petroleum-based leather conditioners. These products may cause premature wearing or damage to the leather.

LEATHER SEATS FOR THE KING RANCH® EDITION ONLY (IF EQUIPPED)

Your vehicle is equipped with seating covered in premium, top-grain leather which is extremely durable, but still requires special care and maintenance in order to ensure longevity and comfort.

Regular cleaning and conditioning will maintain the appearance of the leather.

Cleaning

Cleaning

For dirt, use a vacuum cleaner then use a clean, damp cloth or soft brush.

For routine cleaning, wipe the surface with a soft, damp cloth. For more thorough cleaning, wipe the surface with a mild soap and water solution.

- Clean spills as quickly as possible.
- Test any cleaner or stain remover on an inconspicuous part of the leather as cleaners may darken the leather.
- Do not spill coffee, ketchup, mustard, orange juice or oil-based products on the leather as they may permanently stain the leather.
- Do not use household cleaning products, alcohol solutions, solvents or cleaners intended for rubber, vinyl or plastics.

Scratches

Natural Markings - Because the leather in the seat comes from genuine steer hides, there will be evidence of naturally occurring markings, such as small scars. These markings give character to the seating covers and should be considered as proof of a genuine leather product.

In order to lessen the appearance of certain scratches and other wear marks, apply conditioner on the affected area following the same instructions as in the *Conditioning* section.

Conditioning

Bottles of King Ranch® Leather Conditioner are available at the King Ranch® Saddle Shop. Visit the website at www.krsaddleshop.com, or telephone (in the United States) 1-800-282-KING (5464). If you are unable to obtain King Ranch® Leather Conditioner, use another premium leather conditioner.

- Clean the surfaces using the steps outlined in the *Cleaning* section.
- Ensure the leather is dry then apply a nickel-sized amount of conditioner to a clean, dry cloth.
- Rub the conditioner into leather until it disappears. Allow the conditioner to dry and repeat the process for the entire interior. If a film appears, wipe off film with a dry, clean cloth.

UNDERBODY

Flush the complete underside of your vehicle frequently. Keep body and door drain holes free from packed dirt.

Cleaning

FORD AND LINCOLN MERCURY CAR CARE PRODUCTS

Your Ford or Lincoln Mercury authorized dealer has many quality products available to clean your vehicle and protect its finishes. These quality products have been specifically engineered to fulfill your automotive needs; they are custom designed to complement the style and appearance of your vehicle. Each product is made from high quality materials that meet or exceed rigid specifications. For best results, use the following products or products of equivalent quality:

- Motorcraft® Bug and Tar Remover (ZC-42)
- Motorcraft® Custom Bright Metal Cleaner (ZC-15)
- Motorcraft® Detail Wash (ZC-3-A)
- Motorcraft® Dusting Cloth (ZC-24)
- Motorcraft® Engine Shampoo and Degreaser (U.S. only) (ZC-20)
- Motorcraft® Engine Shampoo (Canada only) (CXC-66-A)
- Motorcraft® Multi-Purpose Cleaner (Canada only) (CXC-101)
- Motorcraft® Premium Glass Cleaner (Canada only) (CXC-100)
- Motorcraft® Premium Quality Windshield Washer Fluid (Canada only) [CXC-37-(A, B, D or F)]
- Motorcraft® Premium Windshield Washer Concentrate (U.S. only) (ZC-32-A)
- Motorcraft® Professional Strength Carpet & Upholstery Cleaner (ZC-54)
- Motorcraft® Spot and Stain Remover (U.S. only) (ZC-14)
- Motorcraft® Ultra-Clear Spray Glass Cleaner (ZC-23)
- Motorcraft® Vinyl Cleaner (Canada only) (CXC-93)
- Motorcraft® Wheel and Tire Cleaner (ZC-37-A)

Maintenance and Specifications

SERVICE RECOMMENDATIONS

To help you service your vehicle, we provide *scheduled maintenance information* which makes tracking routine service easy.

If your vehicle requires professional service, your authorized dealer can provide the necessary parts and service. Check your *Warranty Guide* to find out which parts and services are covered.

Use only recommended fuels, lubricants, fluids and service parts conforming to specifications. Motorcraft® parts are designed and built to provide the best performance in your vehicle.

PRECAUTIONS WHEN SERVICING YOUR VEHICLE

Be especially careful when inspecting or servicing your vehicle.

- Do not work on a hot engine.
- When the engine is running, make sure that loose clothing, jewelry or long hair does not get caught in moving parts.
- Do not work on a vehicle with the engine running in an enclosed space, unless you are sure you have enough ventilation.
- Keep all open flames and other burning (cigarettes) material away from the battery and all fuel related parts.

If you disconnect the battery, the engine must “relearn” its idle condition before your vehicle will drive properly, as explained in *Battery* in this section.

Working with the engine off

1. For vehicles equipped with an automatic transmission, set the parking brake and shift to P (Park). For vehicles equipped with a manual transmission, set the parking brake, press and hold the clutch pedal, place the gearshift in 1 (First), and release the clutch pedal.
2. Turn off the engine and remove the key.
3. Block the wheels.

Working with the engine on

1. For vehicles equipped with an automatic transmission, set the parking brake and shift to P (Park). For vehicles equipped with a manual transmission, set the parking brake, press and hold the clutch pedal, place the gearshift in N (Neutral), and release the clutch pedal.
2. Block the wheels.

227

Maintenance and Specifications



WARNING: To reduce the risk of vehicle damage and/or personal burn injuries, do not start your engine with the air cleaner removed and do not remove it while the engine is running.

OPENING THE HOOD

1. Inside the vehicle, pull the hood release handle located under the instrument panel.

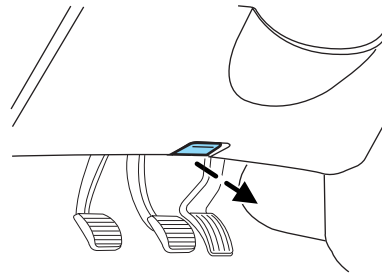

2. Go to the front of the vehicle and locate the auxiliary latch centered under the front of the hood and then release it by pushing the auxiliary latch to the left.

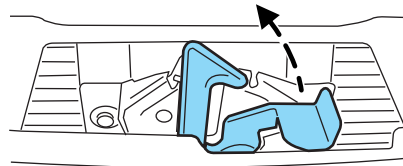

3. Lift the hood and locate the prop rod on the passenger side of the vehicle near the fender. Support the hood with the prop rod.

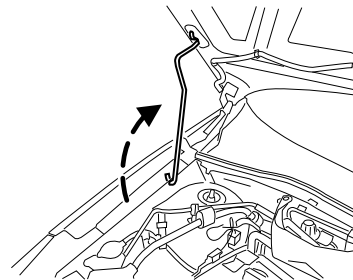

Maintenance and Specifications

IDENTIFYING COMPONENTS IN THE ENGINE COMPARTMENT

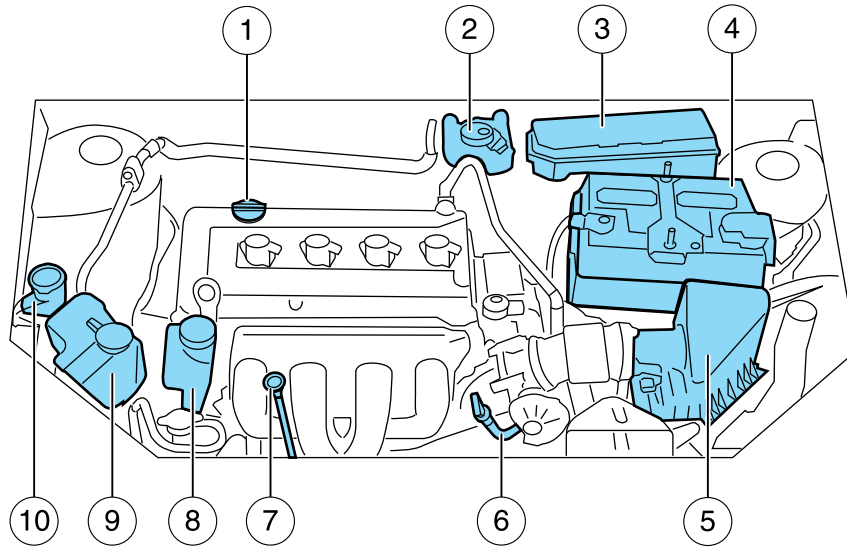

1. Engine oil filler cap
2. Brake/Clutch fluid reservoir
3. Power distribution box
4. Battery
5. Air filter
6. Automatic transmission fluid dipstick (if equipped)
7. Engine oil dipstick
8. Power steering fluid reservoir
9. Engine coolant reservoir
10. Windshield washer fluid reservoir

Maintenance and Specifications

WINDSHIELD WASHER FLUID

Add fluid to fill the reservoir if the level is low. In very cold weather, do not fill the reservoir completely.

Only use a washer fluid that meets Ford specifications. Do not use any special washer fluid such as windshield water repellent type fluid or bug wash. They may cause squeaking, chatter noise, streaking and smearing. Refer to *Maintenance product specifications and capacities* in this chapter.

State or local regulations on volatile organic compounds may restrict the use of methanol, a common windshield washer antifreeze additive. Washer fluids containing non-methanol antifreeze agents should be used only if they provide cold weather protection without damaging the vehicle's paint finish, wiper blades or washer system.



WARNING: If you operate your vehicle in temperatures below 40°F (5°C), use washer fluid with antifreeze protection. Failure to use washer fluid with antifreeze protection in cold weather could result in impaired windshield vision and increase the risk of injury or accident.

CHANGING THE WIPER BLADES

1. Pull the wiper blade and arm away from the glass. Turn the blade at a right angle to the arm. Press the lock tab (A) to release the blade from the arm loop and pull the blade down toward the windshield to remove it from the arm.

2. Attach the new blade to the arm loop and pull it into place until a click is heard.

Replace wiper blades at least once per year for optimum performance.

Poor wiper quality can be improved by cleaning the wiper blades and the windshield. Refer to *Windows and wiper blades* in the *Cleaning* chapter.

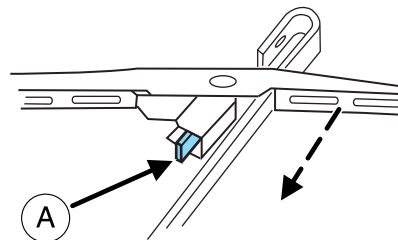

230

Maintenance and Specifications

To prolong the life of the wiper blades, it is highly recommended to scrape off the ice on the windshield before turning on the wipers. The layer of ice has many sharp edges and can damage the micro edge of the wiper rubber element.

ENGINE OIL

Checking the engine oil

Refer to the *scheduled maintenance information* for the appropriate intervals for checking the engine oil.

1. Make sure the vehicle is on level ground.
2. Turn the engine off and wait 15 minutes for the oil to drain into the oil pan.
3. Set the parking brake and ensure the gearshift is securely latched in P (automatic transmission) or 1st (manual transmission).
4. Open the hood. Protect yourself from engine heat.
5. Locate and carefully remove the engine oil level dipstick.
6. Wipe the dipstick clean. Insert the dipstick fully, then remove it again.

- If the oil level is **between the MIN and MAX marks**, the oil level is acceptable. **DO NOT ADD OIL.**

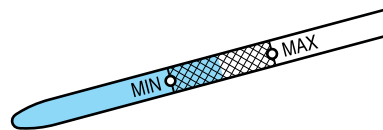

- If the oil level is below the MIN mark, add enough engine oil to raise the level within the MIN and MAX range. Refer to *Adding engine oil* in this chapter.
- **Oil levels above MAX mark may cause engine damage.** If the engine is overfilled, some oil must be removed from the engine by an authorized dealer.

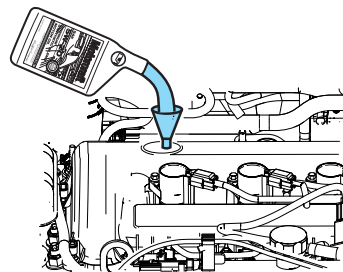

7. Put the dipstick back in and ensure it is fully seated.

Adding engine oil

1. Check the engine oil. For instructions, refer to *Checking the engine oil* in this chapter.

Maintenance and Specifications

2. If the engine oil level is not within the normal range, add only certified engine oil of the recommended viscosity. Remove the engine oil filler cap and use a funnel to pour the engine oil into the opening.
3. Recheck the engine oil level. Make sure the oil level is not above the MAX mark on the engine oil level dipstick.
4. Install the dipstick and ensure it is fully seated.
5. Fully install the engine oil filler cap by turning the filler cap clockwise tightly until clicks are heard, or until it is snug.

To avoid possible oil loss, DO NOT operate the vehicle with the engine oil level dipstick and/or the engine oil filler cap removed.

Engine oil and filter recommendations

Look for this certification trademark.

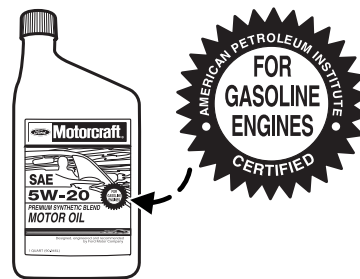

Use SAE 5W-20 engine oil

Only use oils certified for gasoline engines by the American Petroleum Institute (API). An oil with this trademark symbol conforms to the current engine and emission system protection standards and fuel economy requirements of the International Lubricant Standardization and Approval Committee (ILSAC), comprised of U.S. and Japanese automobile manufacturers.

To protect your engine and engine's warranty, use Motorcraft® SAE 5W-20 or an equivalent SAE 5W-20 oil meeting Ford specification WSS-M2C930-A. **SAE 5W-20 oil provides optimum fuel economy and durability performance meeting all requirements for your vehicle's engine.** Refer to *Maintenance product specifications and capacities* later in this chapter for more information.

Do not use supplemental engine oil additives, cleaners or other engine treatments. They are unnecessary and could lead to engine damage that is not covered by Ford warranty.

232

Maintenance and Specifications

Change your engine oil and filter according to the appropriate schedule listed in the *scheduled maintenance information*.

Ford production and Motorcraft® replacement oil filters are designed for added engine protection and long life. If a replacement oil filter is used that does not meet Ford material and design specifications, start-up engine noises or knock may be experienced.

It is recommended you use the appropriate Motorcraft® oil filter or another with equivalent performance for your engine application.

BATTERY

Your vehicle is equipped with a Motorcraft® maintenance-free battery which normally does not require additional water during its life of service.

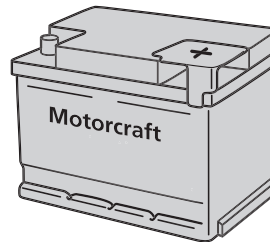

If your battery has a cover/shield, make sure it is reinstalled after the battery has been cleaned or replaced.

For longer, trouble-free operation, keep the top of the battery clean and dry. Also, make certain the battery cables are always tightly fastened to the battery terminals.

If you see any corrosion on the battery or terminals, remove the cables from the terminals and clean with a wire brush. You can neutralize the acid with a solution of baking soda and water.

It is recommended that the negative battery cable terminal be disconnected from the battery if you plan to store your vehicle for an extended period of time. This will minimize the discharge of your battery during storage.

Note: Electrical or electronic accessories or components added to the vehicle by the dealer or the owner may adversely affect battery performance and durability.



WARNING: Batteries normally produce explosive gases which can cause personal injury. Therefore, do not allow flames, sparks or lighted substances to come near the battery. When working near the battery, always shield your face and protect your eyes. Always provide proper ventilation.

Maintenance and Specifications

 **WARNING:** When lifting a plastic-cased battery, excessive pressure on the end walls could cause acid to flow through the vent caps, resulting in personal injury and/or damage to the vehicle or battery. Lift the battery with a battery carrier or with your hands on opposite corners.

 **WARNING:** Keep batteries out of reach of children. Batteries contain sulfuric acid. Avoid contact with skin, eyes or clothing. Shield your eyes when working near the battery to protect against possible splashing of acid solution. In case of acid contact with skin or eyes, flush immediately with water for a minimum of 15 minutes and get prompt medical attention. If acid is swallowed, call a physician immediately.

 **WARNING:** Battery posts, terminals and related accessories contain lead and lead compounds. **Wash hands after handling.**

Because your vehicle's engine is electronically controlled by a computer, some control conditions are maintained by power from the battery. When the battery is disconnected or a new battery is installed, the engine must relearn its idle and fuel trim strategy for optimum driveability and performance. To begin this process:

1. With the vehicle at a complete stop, set the parking brake.
 2. Put the gearshift in P (Park) (automatic transmission) or the neutral position (manual transmission), turn off all accessories and start the engine.
 3. Run the engine until it reaches normal operating temperature.
 4. Allow the engine to idle for at least one minute.
 5. Turn the A/C on and allow the engine to idle for at least one minute.
 6. Drive the vehicle to complete the relearning process.
- The vehicle may need to be driven 10 miles (16 km) or more to relearn the idle and fuel trim strategy.
 - **If you do not allow the engine to relearn its idle trim, the idle quality of your vehicle may be adversely affected until the idle trim is eventually relearned.**

When the battery is disconnected or a new battery installed, the automatic transmission must relearn its adaptive strategy. As a result of

234

Maintenance and Specifications

this, the transmission may shift firmly when first driven. This operation is considered normal and will fully update transmission operation to its optimum shift feel.

If the battery has been disconnected or a new battery has been installed, the clock and the preset radio stations must be reset once the battery is reconnected.

- Always dispose of automotive batteries in a responsible manner. Follow your local authorized standards for disposal. Call your local authorized recycling center to find out more about recycling automotive batteries.

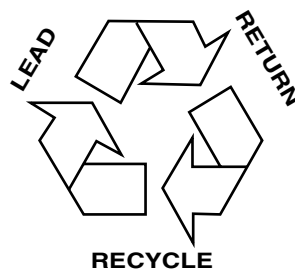

ENGINE COOLANT

Checking engine coolant

The concentration and level of engine coolant should be checked at the intervals listed in *scheduled maintenance information*. The coolant concentration should be maintained at 50/50 coolant and distilled water, which equates to a freeze point of -34°F (-36°C). Coolant concentration testing is possible with a hydrometer or antifreeze tester. The level of coolant should be maintained at the FULL COLD level or within the COLD FILL RANGE in the coolant reservoir. If the level falls below, add coolant per the instructions in the *Adding engine coolant* section.

Your vehicle was factory-filled with a 50/50 engine coolant and water concentration. If the concentration of coolant falls below 40% or above 60%, the engine parts could become damaged or not work properly. **A 50/50 mixture of coolant and water provides the following:**

- **Freeze protection down to -34°F (-36°C).**
- **Boiling protection up to 265°F (129°C).**
- **Protection against rust and other forms of corrosion.**
- **Proper function of calibrated gauges.**

Maintenance and Specifications

When the engine is cold, check the level of the engine coolant in the reservoir.

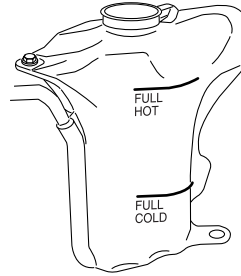

- The engine coolant should be at the FULL COLD level, or within the COLD FILL or MIN / MAX range as listed on the engine coolant reservoir (depending upon application).
- Refer to *scheduled maintenance information* for service interval schedules.

If the engine coolant has not been checked at the recommended interval, the engine coolant reservoir may become low or empty. If the reservoir is low or empty, add engine coolant to the reservoir. Refer to *Adding engine coolant* in this chapter.

Note: Automotive fluids are not interchangeable; do not use engine coolant/antifreeze or windshield washer fluid outside of its specified function and vehicle location.

Adding engine coolant

When adding coolant, make sure it is a 50/50 mixture of engine coolant and distilled water. Add the mixture to the coolant reservoir, **when the engine is cool**, until the appropriate fill level is obtained. If coolant is filled to the COLD FILL RANGE or FULL COLD level when the engine is not cool, the system will remain underfilled.

 **WARNING:** Do not add engine coolant when the engine is hot. Steam and scalding liquids released from a hot cooling system can burn you badly. Also, you can be burned if you spill coolant on hot engine parts.

 **WARNING:** Do not put engine coolant in the windshield washer fluid container. If sprayed on the windshield, engine coolant could make it difficult to see through the windshield.

- **DO NOT MIX** different colors or types of coolant in your vehicle. Make sure the correct coolant is used. **DO NOT MIX** recycled coolant

236

Maintenance and Specifications

and new (unused) coolant together in the vehicle. Mixing of engine coolants may harm your engine's cooling system. The use of an improper coolant may harm engine and cooling system components and may void the warranty. Refer to *Maintenance product specifications and capacities* in this chapter.

- A large amount of water without engine coolant may be added, in case of emergency, to reach a vehicle service location. In this instance, the cooling system must be drained and refilled with a 50/50 mixture of engine coolant and distilled water as soon as possible. Water alone (without engine coolant) can cause engine damage from corrosion, overheating or freezing.
- **Do not use alcohol, methanol, brine or any engine coolants mixed with alcohol or methanol antifreeze (coolant).** Alcohol and other liquids can cause engine damage from overheating or freezing.
- **Do not add extra inhibitors or additives to the coolant.** These can be harmful and compromise the corrosion protection of the engine coolant.

For vehicles with overflow coolant systems with a non-pressurized cap on the coolant recovery system, add coolant to the coolant recovery reservoir when the engine is cool. Add the proper mixture of coolant and distilled water to the FULL COLD level. For all other vehicles which have a coolant degas system with a pressurized cap, or if it is necessary to remove the coolant pressure relief cap on the radiator of a vehicle with an overflow system, follow these steps to add engine coolant.



WARNING: To reduce the risk of personal injury, make sure the engine is cool before unscrewing the coolant pressure relief cap. The cooling system is under pressure; steam and hot liquid can come out forcefully when the cap is loosened slightly.

Add the proper mixture of coolant and water to the cooling system by following these steps:

1. Before you begin, turn the engine off and let it cool.
2. When the engine is cool, wrap a thick cloth around the coolant pressure relief cap on the coolant reservoir (a translucent plastic bottle). Slowly turn cap counterclockwise (left) until pressure begins to release.
3. Step back while the pressure releases.
4. When you are sure that all the pressure has been released, use the cloth to turn it counterclockwise and remove the cap.

237

Maintenance and Specifications

5. Fill the coolant reservoir slowly with the proper coolant mixture, to within the COLD FILL RANGE or the FULL COLD level on the reservoir. If you removed the radiator cap in an overflow system, fill the radiator until the coolant is visible and radiator is almost full.

6. Replace the cap. Turn until tightly installed. Cap must be tightly installed to prevent coolant loss.

After any coolant has been added, check the coolant concentration (refer to *Checking engine coolant*). If the concentration is not 50/50 (protection to $-34^{\circ}\text{F}/-36^{\circ}\text{C}$), drain some coolant and adjust the concentration. It may take several drains and additions to obtain a 50/50 coolant concentration.

Whenever coolant has been added, the coolant level in the coolant reservoir should be checked the next few times you drive the vehicle. If necessary, add enough 50/50 concentration of engine coolant and distilled water to bring the liquid level to the proper level.

If you have to add more than 1.0 quart (1.0 liter) of engine coolant per month, have your authorized dealer check the engine cooling system. Your cooling system may have a leak. Operating an engine with a low level of coolant can result in engine overheating and possible engine damage.

Recycled engine coolant

Ford Motor Company does NOT recommend the use of recycled engine coolant since a Ford-approved recycling process is not yet available.



Used engine coolant should be disposed of in an appropriate manner. Follow your community's regulations and standards for recycling and disposing of automotive fluids.

Coolant refill capacity

To find out how much fluid your vehicle's cooling system can hold, refer to *Maintenance product specifications and capacities* in this chapter.

Fill your engine coolant reservoir as outlined in *Adding engine coolant* in this section.

Severe climates

If you drive in extremely cold climates (less than -34°F [-36°C]):

- **It may be necessary to increase the coolant concentration above 50%.**
- **NEVER increase the coolant concentration above 60%.**

238

Maintenance and Specifications

- **A coolant concentration of 60% will provide freeze point protection down to -62°F [-52°C]. Increased engine coolant concentrations above 60% will decrease the overheat protection characteristics of the engine coolant and may cause engine damage.**
- **If available, refer to the chart on the coolant container to ensure the coolant concentration in your vehicle will provide adequate freeze protection at the temperatures in which you drive in the winter months.**

If you drive in extremely hot climates:

- **It is still necessary to maintain the coolant concentration above 40%.**
- **NEVER decrease the coolant concentration below 40%.**
- **A coolant concentration of 40% will provide freeze point protection down to -12°F [-24°C]. Decreased engine coolant concentrations below 40% will decrease the corrosion/freeze protection characteristics of the engine coolant and may cause engine damage.**
- **If available, refer to the chart on the coolant container to ensure the coolant concentration in your vehicle will provide adequate protection at the temperatures in which you drive.**

Vehicles driven year-round in non-extreme climates should use a 50/50 mixture of engine coolant and distilled water for optimum cooling system and engine protection.

What you should know about fail-safe cooling

If the engine coolant supply is depleted, this feature allows the vehicle to be driven temporarily before incremental component damage is incurred. The “fail-safe” distance depends on ambient temperatures, vehicle load and terrain.

How fail-safe cooling works

If the engine begins to overheat:

- The engine coolant temperature gauge will move to the red (hot) area.
- The  (engine coolant temperature) indicator light will illuminate.

If the engine reaches a preset over-temperature condition, the engine will automatically switch to alternating cylinder operation. Each disabled cylinder acts as an air pump and cools the engine.

239

Maintenance and Specifications

When this occurs the vehicle will still operate. However:

- The engine power will be limited.
- The air conditioning system will be disabled.

Continued operation will increase the engine temperature:

- The engine will completely shut down.
- Steering and braking effort will increase.

Once the engine temperature cools, the engine can be re-started. Take your vehicle to an authorized dealer as soon as possible to minimize engine damage.

When fail-safe mode is activated

You have limited engine power when in the fail-safe mode, so drive the vehicle with caution. The vehicle will not be able to maintain high speed operation and the engine will run rough. Remember that the engine is capable of completely shutting down automatically to prevent engine damage, therefore:

1. Pull off the road as soon as safely possible and turn off the engine.
2. Arrange for the vehicle to be taken to an authorized dealer.
3. If this is not possible, wait a short period for the engine to cool.
4. Check the coolant level and replenish if low.



WARNING: Fail-safe mode is for use during emergencies only.

Operate the vehicle in fail-safe mode only as long as necessary to bring the vehicle to rest in a safe location and seek immediate repairs. When in fail-safe mode, the vehicle will have limited power, will not be able to maintain high-speed operation, and may completely shut down without warning, potentially losing engine power, power steering assist, and power brake assist, which may increase the possibility of a crash resulting in serious injury.



WARNING: Never remove the coolant reservoir cap while the engine is running or hot.

5. Restart the engine and take your vehicle to an authorized dealer.

Driving the vehicle without repairing the engine problem increases the chance of engine damage. Take your vehicle to an authorized dealer as soon as possible.

FUEL FILTER

Your vehicle is equipped with a lifetime fuel filter that is integrated with the fuel tank. Regular maintenance or replacement is not needed.

240

Maintenance and Specifications

WHAT YOU SHOULD KNOW ABOUT AUTOMOTIVE FUELS

Important safety precautions



WARNING: Do not overfill the fuel tank. The pressure in an overfilled tank may cause leakage and lead to fuel spray and fire.



WARNING: The fuel system may be under pressure. If the fuel filler cap is venting vapor or if you hear a hissing sound, wait until it stops before completely removing the fuel filler cap. Otherwise, fuel may spray out and injure you or others.



WARNING: If you do not use the proper fuel filler cap, excessive vacuum in the fuel tank may damage the fuel system or cause the fuel cap to disengage in a collision, which may result in serious personal injury.



WARNING: Automotive fuels can cause serious injury or death if misused or mishandled.



WARNING: Gasoline may contain benzene, which is a cancer-causing agent.

Observe the following guidelines when handling automotive fuel:

- Extinguish all smoking materials and any open flames before refueling your vehicle.
- Always turn off the vehicle before refueling.
- Automotive fuels can be harmful or fatal if swallowed. Fuel such as gasoline is highly toxic and if swallowed can cause death or permanent injury. If fuel is swallowed, call a physician immediately, even if no symptoms are immediately apparent. The toxic effects of fuel may not be visible for hours.
- Avoid inhaling fuel vapors. Inhaling too much fuel vapor of any kind can lead to eye and respiratory tract irritation. In severe cases, excessive or prolonged breathing of fuel vapor can cause serious illness and permanent injury.



Maintenance and Specifications

- Avoid getting fuel liquid in your eyes. If fuel is splashed in the eyes, remove contact lenses (if worn), flush with water for 15 minutes and seek medical attention. Failure to seek proper medical attention could lead to permanent injury.
- Fuels can also be harmful if absorbed through the skin. If fuel is splashed on the skin and/or clothing, promptly remove contaminated clothing and wash skin thoroughly with soap and water. Repeated or prolonged skin contact with fuel liquid or vapor causes skin irritation.
- Be particularly careful if you are taking “Antabuse” or other forms of disulfiram for the treatment of alcoholism. Breathing gasoline vapors, or skin contact could cause an adverse reaction. In sensitive individuals, serious personal injury or sickness may result. If fuel is splashed on the skin, promptly wash skin thoroughly with soap and water. Consult a physician immediately if you experience an adverse reaction.



WARNING: When refueling always shut the engine off and never allow sparks or open flames near the filler neck. Never smoke while refueling. Fuel vapor is extremely hazardous under certain conditions. Care should be taken to avoid inhaling excess fumes.



WARNING: The flow of fuel through a fuel pump nozzle can produce static electricity, which can cause a fire if fuel is pumped into an ungrounded fuel container.

Refueling



WARNING: Fuel vapor burns violently and a fuel fire can cause severe injuries. To help avoid injuries to you and others:

- Read and follow all the instructions on the pump island;
- Turn off your engine when you are refueling;
- Do not smoke if you are near fuel or refueling your vehicle;
- Keep sparks, flames and smoking materials away from fuel;
- Stay outside your vehicle and do not leave the fuel pump unattended when refueling your vehicle — this is against the law in some places;
- Keep children away from the fuel pump; never let children pump fuel.
- Do not use personal electronic devices while refueling.

Maintenance and Specifications

Use the following guidelines to avoid electrostatic charge build-up when filling an ungrounded fuel container:



- Place approved fuel container on the ground.
- DO NOT fill a fuel container while it is in the vehicle (including the cargo area).
- Keep the fuel pump nozzle in contact with the fuel container while filling.
- DO NOT use a device that would hold the fuel pump handle in the fill position.



Fuel filler cap

When fueling your vehicle:

1. Turn the engine off.
2. Carefully turn the filler cap counterclockwise until it spins off.
3. Pull to remove the cap from the fuel filler pipe.
4. To install the cap, align the tabs on the cap with the notches on the filler pipe.
5. Turn the filler cap clockwise 1/4 of a turn until at least one click is heard.

If the check fuel cap light  or a “check fuel cap” message comes on, the fuel filler cap may not be properly installed. The light or message can come on after several driving events after you’ve refueled your vehicle.

At the next opportunity, safely pull off of the road, remove the fuel filler cap, align the cap properly and reinstall it. The check fuel cap light  or “check fuel cap” message may not reset immediately; it may take several driving cycles for the check fuel cap light  or “check fuel cap” message to turn off. A driving cycle consists of an engine start-up (after four or more hours with the engine off) followed by city and highway driving.

Continuing to drive with the check fuel cap light  or “check fuel cap” message on may cause the  light to turn on as well.

If you must replace the fuel filler cap, replace it with a fuel filler cap that is designed for your vehicle. The customer warranty may be void for any damage to the fuel tank or fuel system if the correct genuine Ford, Motorcraft or other certified fuel filler cap is not used.

243

Maintenance and Specifications

 **WARNING:** The fuel system may be under pressure. If the fuel filler cap is venting vapor or if you hear a hissing sound, wait until it stops before completely removing the fuel filler cap. Otherwise, fuel may spray out and injure you or others.

 **WARNING:** If you do not use the proper fuel filler cap, excessive vacuum in the fuel tank may damage the fuel system or cause the fuel cap to disengage in a collision, which may result in personal injury.

FORD RECOMMENDS BP



Choosing the right fuel

Use only UNLEADED fuel or UNLEADED fuel blended with a maximum of 10% ethanol. Do not use fuel ethanol (E85), diesel, methanol, leaded fuel or any other fuel. The use of leaded fuel is prohibited by law and could damage your vehicle.

Your vehicle was not designed to use fuel or fuel additives with metallic compounds, including manganese-based additives.

Note: Use of any fuel other than those recommended may cause powertrain damage, a loss of vehicle performance, and repairs may not be covered under warranty.

Octane recommendations

Your vehicle is designed to use "Regular" unleaded gasoline with a pump (R+M)/2 octane rating of 87. Some stations offer fuels posted as "Regular" with an octane rating

below 87, particularly in high altitude areas. Fuels with octane levels below 87 are not recommended.



244

Maintenance and Specifications

Do not be concerned if your engine sometimes knocks lightly. However, if it knocks heavily under most driving conditions while you are using fuel with the recommended octane rating, see your authorized dealer to prevent any engine damage.

Fuel quality

If you are experiencing starting, rough idle or hesitation driveability problems during a cold start, try a different brand of "Regular" unleaded gasoline. Premium unleaded gasoline is not recommended for vehicles designed to use "Regular" unleaded gasoline because it may cause these problems to become more pronounced. If the problems persist, see your authorized dealer.

Do not add aftermarket fuel additive products to your fuel tank. It should not be necessary to add any aftermarket products to your fuel tank if you continue to use high quality fuel of the recommended octane rating. These products have not been approved for your engine and could cause damage to the fuel system. Repairs to correct the effects of using an aftermarket product in your fuel may not be covered by your warranty.

Many of the world's automakers approved the World-Wide Fuel Charter that recommends gasoline specifications to provide improved performance and emission control system protection for your vehicle. Gasolines that meet the World-Wide Fuel Charter should be used when available. Ask your fuel supplier about gasolines that meet the World-Wide Fuel Charter.

Cleaner air

Ford endorses the use of reformulated "cleaner-burning" gasolines to improve air quality, per the recommendations in the *Choosing the right fuel* section.

Running out of fuel



Avoid running out of fuel because this situation may have an adverse effect on powertrain components.

If you have run out of fuel:

- You may need to cycle the ignition from off to on several times after refueling to allow the fuel system to pump the fuel from the tank to the engine. On restarting, cranking time will take a few seconds longer than normal.
- Normally, adding 1 gallon (3.8L) of fuel is enough to restart the engine. If the vehicle is out of fuel and on a steep grade, more than 1 gallon (3.8L) may be required.

245

Maintenance and Specifications

- The service engine soon  indicator may come on. For more information on the service engine soon  indicator, refer to *Warning lights and chimes* in the *Instrument Cluster* chapter.

ESSENTIALS OF GOOD FUEL ECONOMY

Measuring techniques

Your best source of information about actual fuel economy is you, the driver. You must gather information as accurately and consistently as possible. Fuel expense, frequency of fill-ups or fuel gauge readings are NOT accurate as a measure of fuel economy. We do not recommend taking fuel economy measurements during the first 1,000 miles (1,600 km) of driving (engine break-in period). You will get a more accurate measurement after 2,000 miles–3,000 miles (3,000 km–5,000 km).

Filling the tank

The advertised fuel capacity of the fuel tank on your vehicle is equal to the rated refill capacity of the fuel tank as listed in the *Maintenance product specifications and capacities* section of this chapter.

The advertised capacity is the amount of the indicated capacity and the empty reserve combined. Indicated capacity is the difference in the amount of fuel in a full tank and a tank when the fuel gauge indicates empty. Empty reserve is the small amount of fuel remaining in the fuel tank after the fuel gauge indicates empty.

The amount of usable fuel in the empty reserve varies and should not be relied upon to increase driving range. When refueling your vehicle after the fuel gauge indicates empty, you might not be able to refuel the full amount of the advertised capacity of the fuel tank due to the empty reserve still present in the tank.

For consistent results when filling the fuel tank:

- Turn the engine/ignition switch to the off position prior to refueling, an error in the reading will result if the engine is left running.
- Use the same filling rate setting (low — medium — high) each time the tank is filled.
- Allow no more than two automatic click-offs when filling.
- Always use fuel with the recommended octane rating.
- Use a known quality gasoline, preferably a national brand.
- Have the vehicle loading and distribution the same every time.

246

Maintenance and Specifications

Your results will be most accurate if your filling method is consistent.

Calculating fuel economy

1. Fill the fuel tank completely and record the initial odometer reading (in miles or kilometers).
2. Each time you fill the tank, record the amount of fuel added (in gallons or liters).
3. After at least three to five tank fill-ups, fill the fuel tank and record the current odometer reading.
4. Subtract your initial odometer reading from the current odometer reading.
5. Follow one of the simple calculations in order to determine fuel economy:

Calculation 1: **Divide total miles traveled by total gallons used.**

Calculation 2: **Multiply liters used by 100, then divide by total kilometers traveled.**

Keep a record for at least one month and record the type of driving (city or highway). This will provide an accurate estimate of the vehicle's fuel economy under current driving conditions. Additionally, keeping records during summer and winter will show how temperature impacts fuel economy. In general, lower temperatures give lower fuel economy.

Driving style — good driving and fuel economy habits

Give consideration to the lists that follow and you may be able to change a number of variables and improve your fuel economy.

Habits

- Smooth, moderate operation can yield up to 10% savings in fuel.
- Steady speeds without stopping will usually give the best fuel economy.
- Idling for long periods of time (greater than one minute) may waste fuel.
- Anticipate stopping; slowing down may eliminate the need to stop.
- Sudden or hard accelerations may reduce fuel economy.
- Slow down gradually.
- Driving at reasonable speeds (traveling at 55 mph [88 km/h] uses 15% less fuel than traveling at 65 mph [105 km/h]).

247

Maintenance and Specifications

- Revving the engine before turning it off may reduce fuel economy.
- Using the air conditioner or defroster may reduce fuel economy.
- You may want to turn off the speed control in hilly terrain if unnecessary shifting between the top gears occurs. Unnecessary shifting of this type could result in reduced fuel economy.
- Warming up a vehicle on cold mornings is not required and may reduce fuel economy.
- Resting your foot on the brake pedal while driving may reduce fuel economy.
- Combine errands and minimize stop-and-go driving.

Maintenance

- Keep tires properly inflated and use only recommended size.
- Operating a vehicle with the wheels out of alignment will reduce fuel economy.
- Use recommended engine oil. Refer to *Maintenance product specifications and capacities* in this chapter.
- Perform all regularly scheduled maintenance items. Follow the recommended maintenance schedule and owner maintenance checks found in *scheduled maintenance information*.

Conditions

- Heavily loading a vehicle or towing a trailer may reduce fuel economy at any speed.
- Carrying unnecessary weight may reduce fuel economy (approximately 1 mpg [0.4 km/L] is lost for every 400 lb [180 kg] of weight carried).
- Adding certain accessories to your vehicle (for example bug deflectors, rollbars/light bars, running boards, ski/luggage racks) may reduce fuel economy.
- Using fuel blended with alcohol may lower fuel economy.
- Fuel economy may decrease with lower temperatures during the first 8–10 miles (12–16 km) of driving.
- Driving on flat terrain offers improved fuel economy as compared to driving on hilly terrain.
- Transmissions give their best fuel economy when operated in the top cruise gear and with steady pressure on the gas pedal.
- Close windows for high speed driving.

248

Maintenance and Specifications

EMISSION CONTROL SYSTEM

Your vehicle is equipped with various emission control components and a catalytic converter which will enable your vehicle to comply with applicable exhaust emission standards. To make sure that the catalytic converter and other emission control components continue to work properly:

- Use only the specified fuel listed.
- Avoid running out of fuel.
- Do not turn off the ignition while your vehicle is moving, especially at high speeds.
- Have the items listed in *scheduled maintenance information* performed according to the specified schedule.

The scheduled maintenance items listed in *scheduled maintenance information* are essential to the life and performance of your vehicle and to its emissions system.

If other than Ford, Motorcraft® or Ford-authorized parts are used for maintenance replacements or for service of components affecting emission control, such non-Ford parts should be equivalent to genuine Ford Motor Company parts in performance and durability.



WARNING: Do not park, idle, or drive your vehicle in dry grass or other dry ground cover. The emission system heats up the engine compartment and exhaust system, which can start a fire.

Illumination of the service engine soon  indicator, charging system warning light or the temperature warning light, fluid leaks, strange odors, smoke or loss of engine power could indicate that the emission control system is not working properly.

An improperly operating or damaged exhaust system may allow exhaust to enter the vehicle. Have a damaged or improperly operating exhaust system inspected and repaired immediately.





WARNING: Exhaust leaks may result in entry of harmful and potentially lethal fumes into the passenger compartment.

Maintenance and Specifications

Do not make any unauthorized changes to your vehicle or engine. By law, vehicle owners and anyone who manufactures, repairs, services, sells, leases, trades vehicles, or supervises a fleet of vehicles are not permitted to intentionally remove an emission control device or prevent it from working. Information about your vehicle's emission system is on the Vehicle Emission Control Information Decal located on or near the engine. This decal also lists engine displacement.



Please consult your *Warranty Guide* for complete emission warranty information.

On-board diagnostics (OBD-II)

Your vehicle is equipped with a computer that monitors the engine's emission control system. This system is commonly known as the on-board diagnostics system (OBD-II). The OBD-II system protects the environment by ensuring that your vehicle continues to meet government emission standards. The OBD-II system also assists your authorized dealer in properly servicing your vehicle. When the service engine soon  indicator illuminates, the OBD-II system has detected a malfunction. Temporary malfunctions may cause the service engine soon  indicator to illuminate. Examples are:

1. The vehicle has run out of fuel—the engine may misfire or run poorly.
2. Poor fuel quality or water in the fuel—the engine may misfire or run poorly.
3. The fuel cap may not have been securely tightened. See *Fuel filler cap* in this chapter.
4. Driving through deep water—the electrical system may be wet.

These temporary malfunctions can be corrected by filling the fuel tank with good quality fuel, properly tightening the fuel cap or letting the electrical system dry out. After three driving cycles without these or any other temporary malfunctions present, the service engine soon  indicator should stay off the next time the engine is started. A driving cycle consists of a cold engine startup followed by mixed city/highway driving. No additional vehicle service is required.

If the service engine soon  indicator remains on, have your vehicle serviced at the first available opportunity. Although some malfunctions detected by the OBD-II may not have symptoms that are apparent, continued driving with the service engine soon  indicator on can result in increased emissions, lower fuel economy, reduced engine and transmission smoothness, and lead to more costly repairs.



250

Maintenance and Specifications

Readiness for Inspection/Maintenance (I/M) testing

Some state/provincial and local governments may have Inspection/Maintenance (I/M) programs to inspect the emission control equipment on your vehicle. Failure to pass this inspection could prevent you from getting a vehicle registration. Your vehicle may not pass the I/M test if the service engine soon  indicator is on or not working properly (bulb is burned out), or if the OBD-II system has determined that some of the emission control systems have not been properly checked. In this case, the vehicle is considered not ready for I/M testing.

If the service engine soon  indicator is on or the bulb does not work, the vehicle may need to be serviced. Refer to *On-board diagnostics (OBD-II)* in this chapter.

If the vehicle's engine or transmission has just been serviced, or the battery has recently run down or been replaced, the OBD-II system may indicate that the vehicle is not ready for I/M testing. To determine if the vehicle is ready for I/M testing, turn the ignition key to the on position for 15 seconds without cranking the engine. If the service engine soon  indicator blinks eight times, it means that the vehicle is not ready for I/M testing; if the service engine soon  indicator stays on solid, it means that the vehicle is ready for I/M testing.

The OBD-II system is designed to check the emission control system during normal driving. A complete check may take several days. If the vehicle is not ready for I/M testing, the following driving cycle consisting of mixed city and highway driving may be performed:

15 minutes of steady driving on an expressway/highway followed by 20 minutes of stop-and-go driving with at least four 30-second idle periods.

Allow the vehicle to sit for at least eight hours without starting the engine. Then, start the engine and complete the above driving cycle. The engine must warm up to its normal operating temperature. Once started, do not turn off the engine until the above driving cycle is complete. If the vehicle is still not ready for I/M testing, the above driving cycle will have to be repeated.

Maintenance and Specifications

POWER STEERING FLUID

Check the fluid. Refer to *scheduled maintenance information*.

1. Start the engine and let it run until it reaches normal operating temperature.
2. Turn the steering wheel left and right several times.
3. Turn the engine off.
4. Check the fluid level.
5. If the fluid is below the MIN line, add fluid in small amounts until it reaches the correct level (between the MIN and MAX lines). Refer to *Maintenance product specifications and capacities* in this chapter for the proper fluid type.

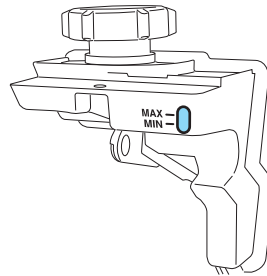

BRAKE/CLUTCH FLUID

Brake and clutch (if equipped) systems are supplied from the same reservoir.

The fluid level will drop slowly as the brakes wear, and will rise when the brake components are replaced. Fluid levels between the MIN and MAX lines are within the normal operating range; there is no need to add fluid. If the fluid levels are outside of the normal operating range, the performance of the system could be compromised; seek service from your authorized dealer immediately.

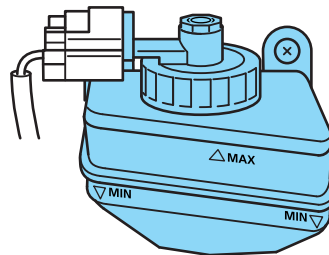

TRANSMISSION FLUID

Checking automatic transmission fluid

Refer to your *scheduled maintenance information* for scheduled intervals for fluid checks and changes. Your transmission does not consume fluid. However, the fluid level should be checked if the transmission is not working properly, i.e., if the transmission slips or shifts slowly or if you notice some sign of fluid leakage.

Automatic transmission fluid expands when warmed. To obtain an accurate fluid check, drive the vehicle until it is warmed up

252

Maintenance and Specifications

(approximately 20 miles [30 km]). If your vehicle has been operated for an extended period at high speeds, in city traffic during hot weather or pulling a trailer, the vehicle should be turned off for about 30 minutes to allow fluid to cool before checking.

1. Drive the vehicle 20 miles (30 km) or until it reaches normal operating temperature.
2. Park the vehicle on a level surface and engage the parking brake.
3. With the parking brake engaged and your foot on the brake pedal, start the engine and move the gearshift lever through all of the gear ranges. Allow sufficient time for each gear to engage.
4. Latch the gearshift lever in P (Park) and leave the engine running.
5. Remove the dipstick, wiping it clean with a clean, dry lint free rag. If necessary, refer to *Identifying components in the engine compartment* in this chapter for the location of the dipstick.
6. Install the dipstick making sure it is fully seated in the filler tube.
7. Remove the dipstick and inspect the fluid level. The fluid should be in the designated areas for normal operating temperature.

Low fluid level

Do not drive the vehicle if the fluid level is at the bottom of the dipstick and the outside temperatures are above 50°F (10°C).

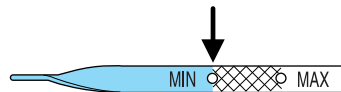

Correct fluid level

The transmission fluid should be checked at normal operating temperatures 120°F-140°F (50°C-60°C) on a level surface. The normal operating temperature can be reached after approximately 20 miles (30 km) of driving.

The transmission fluid should be in this range if at normal operating temperature (120°F-140°F [50°C-60°C]).

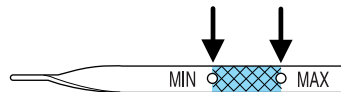

Maintenance and Specifications

High fluid level

Fluid levels above the safe range may result in transmission failure. An overfill condition of transmission fluid may cause shift and/or engagement concerns and/or possible damage.

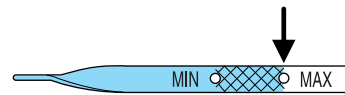

High fluid levels can be caused by an overheating condition.

Adjusting automatic transmission fluid levels

Before adding any fluid, make sure the correct type is used. The type of fluid used is normally indicated on the dipstick and also in the **Maintenance product specifications and capacities** section in this chapter.

Use of a non-approved automatic transmission fluid may cause internal transmission component damage.

If necessary, add fluid in 1/2 pint (250 mL) increments through the filler tube until the level is correct.

If an overfill occurs, excess fluid should be removed by an authorized dealer.

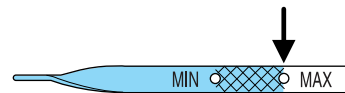

An overfill condition of transmission fluid may cause shift and/or engagement concerns and/or possible damage.

Do not use supplemental transmission fluid additives, treatments or cleaning agents. The use of these materials may affect transmission operation and result in damage to internal transmission components.

Maintenance and Specifications

Checking and adding manual transmission fluid (if equipped)

1. Clean the filler plug.
2. Remove the filler plug and inspect the fluid level.
3. Fluid level should be at the bottom of the opening.
4. Add enough fluid through the filler opening so that the fluid level is at the bottom of the opening.
5. Install and tighten the fill plug securely.

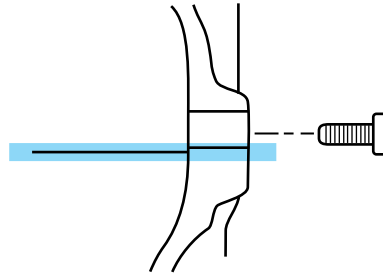

Use only fluid that meets Ford specifications. Refer to the *Maintenance product specifications and capacities* section in this chapter.

AIR FILTER

Refer to *scheduled maintenance information* for the appropriate intervals for changing the air filter element.

When changing the air filter element, use only the air filter element listed. Refer to *Motorcraft® part numbers* in this chapter.



WARNING: To reduce the risk of vehicle damage and/or personal burn injuries do not start your engine with the air cleaner removed and do not remove it while the engine is running.

Changing the air filter element

1. Release the clamps that secure the air filter housing cover.
2. Carefully separate the two halves of the air filter housing.
3. Remove the air filter element from the air filter housing.
4. Wipe the air filter housing and cover clean to remove any dirt or debris and to ensure good sealing.
5. Install a new air filter element. Be careful not to crimp the filter element edges between the air filter housing and cover. This could cause filter damage and allow unfiltered air to enter the engine if not properly seated.

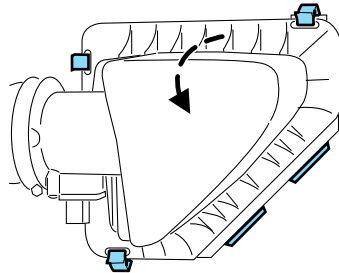

Maintenance and Specifications

6. Replace the air filter housing cover and secure the clamps. Be sure that the air cleaner cover tabs are engaged into the slots of the air cleaner housing.

Note: Failure to use the correct air filter element may result in severe engine damage. The customer warranty may be void for any damage to the engine if the correct air filter element is not used.

VEHICLE STORAGE

If you plan on storing your vehicle for an extended period of time (30 days or more), refer to the following maintenance recommendations to ensure your vehicle stays in good operating condition.

All motor vehicles and their components were engineered and tested for reliable, regular driving. Long term storage under various conditions may lead to component degradation or failure unless specific precautions are taken to preserve the components.

General

- Store all vehicles in a dry, ventilated place.
- Protect from sunlight, if possible.
- If vehicles are stored outside, they require regular maintenance to protect against rust and damage.

Body

- Wash vehicle thoroughly to remove dirt, grease, oil, tar or mud from exterior surfaces, rear-wheel housing and underside of front fenders. See the *Cleaning* chapter for more information.
- Periodically wash vehicles stored in exposed locations.
- Touch-up raw or primed metal to prevent rust.
- Cover chrome and stainless steel parts with a thick coat of auto wax to prevent discoloration. Re-wax as necessary when the vehicle is washed. See the *Cleaning* chapter for more information.
- Lubricate all hood, door and trunk lid hinges, and latches with a light grade oil. See the *Cleaning* chapter for more information.
- Cover interior trim to prevent fading.
- Keep all rubber parts free from oil and solvents.

Engine

- The engine oil and filter should be changed prior to storage, as used engine oil contain contaminants that may cause engine damage.

256

Maintenance and Specifications

- Start the engine every 15 days. Run at fast idle until it reaches normal operating temperature.
- With your foot on the brake, shift through all the gears while the engine is running.

Fuel system

- Fill the fuel tank with high-quality fuel until the first automatic shutoff of the fuel pump nozzle.

Note: During extended periods of vehicle storage (30 days or more), fuel may deteriorate due to oxidation. Add Motorcraft® Gas Stabilizer or equivalent meeting Ford material specification ESE-M99C112-A to the vehicle fuel system whenever actual or expected storage periods exceed 30 days. Follow the instructions on the additive label. The vehicle should then be operated at idle speed to circulate the additive throughout the fuel system.

Cooling system

- Protect against freezing temperatures.
- When removing vehicle from storage, check coolant fluid level. Confirm there are no cooling system leaks, and fluid is at the recommended level.

Battery

- Check and recharge as necessary. Keep connections clean.
- If storing your vehicle for more than 30 days without recharging the battery, it may be advisable to disconnect the battery cables to ensure battery charge is maintained for quick starting.

Note: If battery cables are disconnected, it will be necessary to reset memory features.

Brakes

- Make sure brakes and parking brake are fully released.

Tires

- Maintain recommended air pressure.

Miscellaneous

- Make sure all linkages, cables, levers and pins under vehicle are covered with grease to prevent rust.
- Move vehicles at least 25 feet (8 m) every 15 days to lubricate working parts and prevent corrosion.

Maintenance and Specifications

Removing vehicle from storage

When your vehicle is ready to come out of storage, do the following:

- Wash your vehicle to remove any dirt or grease film build-up on window surfaces.
- Check windshield wipers for any deterioration.
- Check under the hood for any foreign material that may have collected during storage (mice/squirrel nests).
- Check the exhaust for any foreign material that may have collected during storage.
- Check tire pressures and set tire inflation per the Tire Label.
- Check brake pedal operation. Drive the vehicle 15 ft (4.5 meters) back and forth to remove rust build up.
- Check fluid levels (including coolant, oil and gas) to make sure there are no leaks, and fluids are at recommended levels.
- If the battery was removed, clean the battery cable ends and inspect.

If you have any concerns or issues, contact your authorized dealer.

MOTORCRAFT PART NUMBERS

Component	2.0L I4 engine
Air filter element	FA-1890 ¹
Oil filter	FL-910 ²
Battery	BXL-96-R
Spark plugs	³

¹ Failure to use the correct air filter element may result in severe engine damage. The customer warranty may be void for any damage to the engine if the correct air filter element is not used.

² Only use the specified replacement oil filter. The use of a non-specified oil filter can result in engine damage.

³ For spark plug replacement, see your authorized dealer. Refer to *scheduled maintenance information* for the appropriate intervals for changing the spark plugs.

Replace the spark plugs with ones that meet Ford material and design specifications for your vehicle, such as Motorcraft® or equivalent replacement parts. The customer warranty may be void for any damage to the engine if such spark plugs are not used.

258

Maintenance and Specifications

MAINTENANCE PRODUCT SPECIFICATIONS AND CAPACITIES

Item	Capacity	Ford Part Name or Equivalent	Ford Part Number / Ford Specification
Brake fluid (and clutch fluid—if equipped)	Between MIN and MAX on reservoir	Motorcraft® High Performance DOT 3 Motor Vehicle Brake Fluid	PM-1-C / WSS-M6C62-A or WSS-M6C65-A1
Door latch, hood latch, auxiliary hood latch, trunk latch, seat tracks.	—	Multi-Purpose Grease (Lithium grease)	XG-4 or XL-5 or equivalent / ESB-M1C93-B
Lock cylinder	—	Motorcraft® Penetrating and Lock Lubricant	XL-1 / None
Automatic transmission fluid	6.9 quarts (6.6L) ¹	Motorcraft® MERCON® LV ATF ²	XT-10-QLV / MERCEN® LV
Manual transmission fluid (5-speed)	2.0 quarts (1.9L) ¹	Motorcraft® Full Synthetic Manual Transmission Fluid	XT-M5-QS / WSD-M2C200-C

Maintenance and Specifications

Item	Capacity	Ford Part Name or Equivalent	Ford Part Number / Ford Specification
Engine oil	4.5 quarts (4.3L)	<ul style="list-style-type: none"> • Motorcraft® SAE 5W-20 Premium Synthetic Blend Motor Oil (US) • Motorcraft® SAE 5W-20 Full Synthetic Motor Oil (US) • Motorcraft® SAE 5W-20 Super Premium Motor Oil (Canada) • Motorcraft® SAE 5W-20 Synthetic Motor Oil (Canada)³ 	<ul style="list-style-type: none"> • XO-5W20-QSP (US) • XO-5W20-QFS (US) • CXO-5W20-LSP12 (Canada) • CXO-5W20-LFS12 (Canada) / WSS-M2C930-A and API Certification Mark
Engine coolant	5.3 quarts (5.0 L)	Motorcraft® Premium Gold Engine Coolant with Bittering Agent (yellow-colored) ⁴	VC-7-B / WSS-M97B51-A1
Power steering fluid	Fill to between MIN and MAX lines on reservoir	Motorcraft® MERCON® V ATF	XT-5-QM / MERCON® V

Maintenance and Specifications

Item	Capacity	Ford Part Name or Equivalent	Ford Part Number / Ford Specification
Windshield washer fluid	Fill as required	Motorcraft® Premium Windshield Washer Concentrate (US) Premium Quality Windshield Washer Fluid (Canada)	ZC-32-A (US) CXC-37-(A, B, D, and F) (Canada) / WSB-M8B16-A2/- -
Fuel tank	13.0 gallons (49.2L)	—	—

¹Approximate dry fill capacity including transmission fluid cooling system, actual refill capacities will vary based on vehicle application and transmission fluid cooling system (i.e. coolers size, cooling lines, auxiliary cooler capacities). The amount of transmission fluid and fluid level should be set by the indication on the dipstick's normal operating range.

The manual transmission service refill capacity is determined by filling the transmission to the bottom of the filler hole with the vehicle on a level surface.

²Automatic transmissions that require MERCON® LV should only use MERCON® LV fluid. Refer to *scheduled maintenance* to determine the correct service interval. Use of any fluid other than the recommended fluid may cause transmission damage.

³Use of synthetic or synthetic blend motor oil is not mandatory. Engine oil need only meet the requirements of Ford specification WSS-M2C930-A and the API Certification mark.

⁴Add the coolant type originally equipped in your vehicle.

Maintenance and Specifications

ENGINE DATA

Engine	2.0L I4 engine
Cubic inches	121
Required fuel	87 octane
Firing order	1-3-4-2
Ignition system	C.O.P
Compression ratio	10.0:1
Spark plug gap	.051 inch +/- .002 (1.3 mm +/- .05)

Maintenance and Specifications

Engine drivebelt routing

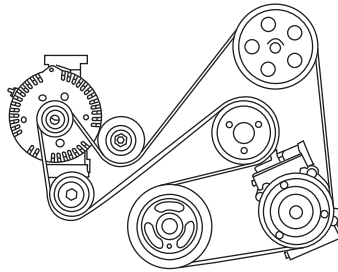

IDENTIFYING YOUR VEHICLE

Safety Compliance Certification Label

The National Highway Traffic Safety Administration Regulations require that a Safety Compliance Certification Label be affixed to a vehicle and prescribe where the Safety Compliance Certification Label may be located. The Safety Compliance Certification Label is located on the structure (B-Pillar) by the trailing edge of the driver's door or the edge of the driver's door.

MFD. BY FORD MOTOR CO.			
DATE: XX/XX	GVWR: XXXXXLB/ XXXXXKG		
FRONT GAWR: XXXXL	REAR GAWR: XXXXLB		
XXXXKG	WITH XXXXKG	WITH	
XXXX/XXXXXXX	TIRES: XXXX/XXXXXXX	TIRES	
XXXX.XX	RIMS: XXXX.XX	RIMS	
AT XXX kPa/XX	PSI COLD	AT XXX kPa/XX	PSI COLD
THIS VEHICLE CONFORMS TO ALL APPLICABLE FEDERAL MOTOR VEHICLE SAFETY AND THEFT PREVENTION STANDARDS IN EFFECT ON THE DATE OF MANUFACTURE SHOWN ABOVE.			
VIN: XXXXXXXXXXXXXXXXX		XXXXX	
TYPE: XXX		XXXXX	
EXT PNT: XX	RC: XX	DSO:	
WB ¹ BRK ¹ INT TR ¹ TP/PS ¹ R ¹	AXLE ¹ TR SPR ¹	XXXXX	
XXX X XX X XX X XX	XXX		
XXXXXXXXXXXXX XXX XXXX-XXXXXXXX-XX			

Maintenance and Specifications

Vehicle identification number (VIN)

The vehicle identification number is located on the driver side instrument panel.

Please note that in the graphic, XXXX is representative of your vehicle identification number.

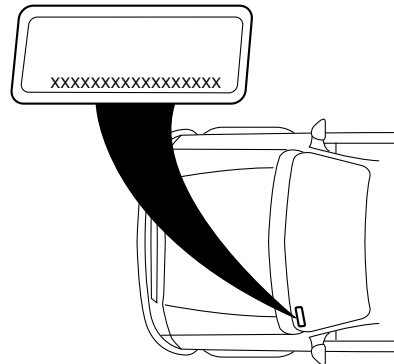

The Vehicle Identification Number (VIN) contains the following information:

1. World manufacturer identifier
2. Brake system / Gross Vehicle Weight Rating (GVWR) / Restraint Devices and their location
3. Make, vehicle line, series, body type
4. Engine type
5. Check digit
6. Model year
7. Assembly plant
8. Production sequence number

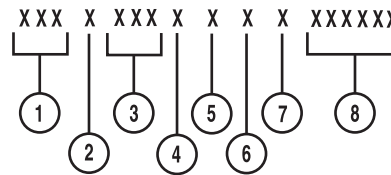

Maintenance and Specifications

TRANSMISSION CODE DESIGNATIONS

You can find a transmission code on the Safety Compliance Certification Label. The following table tells you which transmission each code represents.

MFD. BY FORD MOTOR CO.									
DATE: XXXX	GVWR: XXXXXLB/ XXXXXKG								
FRONT GAWR: XXXXL	REAR GAWR: XXXXLB								
XXXXKG	WITH	XXXXKG	WITH						
XXXXXX/XXXXXX	TIRES	XXXXXX/XXXXXX	TIRES						
XXXX.XX	RIMS	XXXX.XX	RIMS						
AT XXX kPa/XX	PSI COLD	AT XXX kPa/XX	PSI COLD						
THIS VEHICLE CONFORMS TO ALL APPLICABLE FEDERAL MOTOR VEHICLE SAFETY AND THEFT PREVENTION STANDARDS IN EFFECT ON THE DATE OF MANUFACTURE SHOWN ABOVE.									
VIN: XXXXXXXXXXXXXXXXX									XXXXX
TYPE: XXX									XXXXX
									
EXT PNT: XX	RC: XX		DSD: _____						
WB ¹ BRK ¹	INT TR ¹	TP/PS ¹	R ¹	AXLE ¹	TR ¹	SPR ¹	XXXXX		
XXX X	XX	X	XX	X	XX	XX	XXX		
XXXXXXXXXXXXXX XX XXXX-XXXXXX-XX									

Description	Code
Four-speed automatic (4F27E)	2
Five-speed manual (MTX75)	Z

Accessories

FORD CUSTOM ACCESSORIES FOR YOUR VEHICLE

A wide selection of Ford Custom Accessories are available for your vehicle through your local Ford or Ford of Canada dealer. These quality accessories have been specifically engineered to fulfill your automotive needs; they are custom designed to complement the style and aerodynamic appearance of your vehicle. In addition, each accessory is made from high quality materials and meets or exceeds Ford's rigorous engineering and safety specifications. Ford Motor Company will repair or replace any properly dealer-installed Ford Custom Accessories found to be defective in factory-supplied materials or workmanship during the warranty period, as well as any component damaged by the defective accessories. The accessories will be warranted for whichever provides you the greatest benefit:

- 12 months or 12,000 miles (20,000 km) (whichever occurs first), or
- the remainder of your new vehicle limited warranty.

Contact your dealer for details and a copy of the warranty.

The following is a list of several Ford Custom Accessories. Not all accessories are available for all models. For a complete listing of the accessories that are available for your vehicle, please contact your dealer or visit our online store at: www.fordaccessories.com.

Exterior style

- Bug shields
- Chrome exhaust tips
- Deflectors
- Graphics kit
- Fog lights
- Splash guards
- Spoilers
- Sport stripes
- Wheels
- Body kit*
- Custom graphics*

Interior style

- Ambient lighting kit
- Floor mats
- Lighted sill plates
- Electrochromic compass/temperature interior mirrors
- Illuminated shift knob*
- Subwoofer*
- Custom seat covers*

Accessories

Lifestyle

- Ash cup / smoker's package
- Rear bumper protector*
- Cargo net*
- Garmin navigation*
- Roof racks and carriers*
- Cargo organization and management

Peace of mind

- Keyless entry keypad
- Remote start
- Vehicle security systems
- Wheel locks
- Bumper mounted parking sensors*
- Vehicle tracking and recovery*
- Seat covers*
- Windshield wiper shaker*
- Back up camera*

*Ford Licensed Accessories (FLA) are warranted by the accessory manufacturer's warranty. Ford Licensed Accessories are fully designed and developed by the accessory manufacturer and have not been designed or tested to Ford Motor Company engineering requirements. Contact your Ford dealer for details regarding the manufacturer's limited warranty and/or a copy of the FLA product limited warranty offered by the accessory manufacturer.

For maximum vehicle performance, keep the following information in mind when adding accessories or equipment to your vehicle:

- When adding accessories, equipment, passengers and luggage to your vehicle, do not exceed the total weight capacity of the vehicle or of the front or rear axle (GVWR or GAWR as indicated on the Safety Compliance Certification label). Consult your authorized dealer for specific weight information.
- The Federal Communications Commission (FCC) and Canadian Radio Telecommunications Commission (CRTC) regulate the use of mobile communications systems — such as two-way radios, telephones and theft alarms - that are equipped with radio transmitters. Any such equipment installed in your vehicle should comply with FCC or CRTC regulations and should be installed only by a qualified service technician.

Accessories

- Mobile communications systems may harm the operation of your vehicle, particularly if they are not properly designed for automotive use.
- To avoid interference with other vehicle functions, such as anti-lock braking systems, amateur radio users who install radios and antennas onto their vehicle should not locate the Amateur Radio Antennas in the area of the driver's side hood.
- Electrical or electronic accessories or components that are added to the vehicle by the authorized dealer or the owner may adversely affect battery performance and durability.

Ford Extended Service Plan

FORD ESP EXTENDED SERVICE PLANS (U.S. ONLY)

More than 30 million Ford, Lincoln, and Mercury owners have discovered the powerful protection of Ford ESP. It is the only extended service plan backed by Ford Motor Company, and provides “peace of mind” protection beyond the New Vehicle Limited Warranty coverage.

Up to 500+ Covered Vehicle Components

There are four, new-vehicle Extended Service Plans with different levels of coverage. Ask your dealer for details.

PremiumCare – Our most comprehensive coverage. With over 500 covered components, this plan is so complete that we generally only discuss what’s not covered!

ExtraCare – Covers 113 components, and includes many high-tech items.

BaseCare – Covers 84 components.

PowertrainCare – Covers 29 critical components.

Ford ESP is honored by all Ford, Lincoln and Mercury Dealers in the U.S. and Canada It’s the only extended service plan authorized and backed by Ford Motor Company. That means you get:

- Reliable, quality service anywhere you go.
- **Factory-trained technicians.**
- **Genuine Ford and Motorcraft® Parts.**

Rental car reimbursement

If your vehicle is kept overnight for covered repairs, you are eligible for rental car coverage, including Bumper-to-Bumper warranty repairs, or manufacturer’s recalls.

Transferable coverage

If you sell your vehicle before your Ford ESP coverage expires, you can transfer any remaining coverage to the new owner. Whenever you’re ready to sell your car, prospective buyers may feel better about taking a risk on your used vehicle. Ford ESP may add resale value!

Plus, **exclusive 24/7 roadside assistance**, including:

- Towing, flat-tire change and battery jump starts.
- Out-of-fuel and lock-out assistance.
- Travel expense reimbursement for lodging, meals and rental car.
- Destination assistance for taxi, shuttle, rental car coverage and emergency transportation.

Ford Extended Service Plan

Ford ESP Can Quickly Pay for Itself

One service bill – the cost of parts and labor – can easily exceed the price of your Ford ESP Service Contract. With Ford ESP, you minimize your risk for unexpected repair bills and rising repair costs.

Avoid the rising cost of properly maintaining your vehicle!

Ford ESP also offers a Premium Maintenance Plan that covers items that **routinely wear out**.

The coverage is prepaid, so you never have to worry about affording your vehicle maintenance. It covers regular checkups, routine inspections, preventive care and replacement of items that require periodic attention for **normal “wear”**:

- **Wiper blades**
- **Spark plugs**
(except California)
- **Clutch disc**
- **Brake pads and linings**
- **Shock absorbers**
- **Belts and hoses**

Contact your selling Ford, Lincoln, or Mercury dealership today so they can customize a Ford Extended Service Plan that fits your driving lifestyle and budget.

Interest free finance options available

Take advantage of our installment payment plan, just a 10% down payment will provide you with an affordable no interest, no-fee payment opportunity.

Ford Extended Service Plan

Get Genuine Peace of Mind with Ford ESP!

To learn more, complete the information below and mail this to:

**Ford ESP
P.O. Box 8072
Royal Oak, MI 48068-9933**

NAME (PLEASE PRINT) _____

ADDRESS _____ APT.NO. _____

CITY _____ STATE _____ ZIP _____

E-MAIL: _____

Ford Extended Service Plan

FORD ESP EXTENDED SERVICE PLANS (CANADA ONLY)

You can get more protection for your vehicle by purchasing a Ford Extended Service Plan (ESP). Ford ESP is the only service contract backed by Ford Motor Company. Depending on the plan you purchase, Ford ESP provides benefits such as:

- Rental reimbursement
- Coverage for certain maintenance and wear items
- Protection against repair costs after your New Vehicle Limited Warranty Coverage expires
- Roadside Assistance benefits

You may purchase Ford ESP from any participating Ford Motor Company dealership. There are several Ford ESP plans available in various time, distance and deductible combinations. Each plan is tailored to fit your own driving needs, including reimbursement for towing and rental.

When you purchase Ford ESP, you receive peace-of-mind protection throughout Canada and the United States, provided by a network of Ford Motor Company dealers.

For more information, visit your local Ford of Canada dealer or www.ford.ca to find the Ford Extended Service Plan that is right for you.

NOTE: Repairs performed outside of Canada and the United States are not eligible for Ford ESP coverage. This information is subject to change.

Scheduled Maintenance Guide

GENERAL MAINTENANCE INFORMATION

Why maintain your vehicle?

This guide describes the scheduled maintenance required for your vehicle. Carefully following this schedule helps protect against major repair expenses resulting from neglect or inadequate maintenance and may also help to increase the value of your vehicle when you sell or trade it.

It is your responsibility to see that all scheduled maintenance is performed and that the materials used meet Ford engineering specifications. Failure to perform scheduled maintenance specific in this guide will invalidate warranty coverage on parts affected by the lack of maintenance. Be sure receipts for completed maintenance are kept with the vehicle and confirmation of the work performed is always recorded in this guide.

Your Ford or Lincoln Mercury dealer has factory-trained technicians who can perform the required maintenance using genuine Ford parts. They are committed to meeting your service needs and to assuring your continuing satisfaction.

Protecting your investment

Maintenance is an investment that will pay dividends in the form of improved reliability, durability and resale value. To ensure the proper performance of your vehicle and its emission control systems, it is imperative that scheduled maintenance be completed at the designated intervals.

Your vehicle is very sophisticated and built with multiple complex performance systems. Every manufacturer develops these systems using different specifications and performance features. That's why it's important to rely upon your Ford or Lincoln Mercury dealership to properly diagnose and repair your vehicle.

Ford Motor Company has recommended maintenance intervals for various parts and component systems based upon engineering testing. Ford Motor Company relies upon this testing to determine the most appropriate mileage for replacement of oils and fluids to protect your vehicle at the lowest overall cost to you and recommends against maintenance schedules that deviate from the scheduled maintenance information.

Scheduled Maintenance Guide

Ford strongly recommends the use of genuine Ford replacement parts. Parts other than Ford, Motorcraft® or Ford-authorized remanufactured parts that are used for maintenance replacement or for the service of components affecting emission control must be equivalent to genuine Ford Motor Company parts in performance and durability. It is the owner's responsibility to determine the equivalency of such parts. Please consult your *Warranty Guide* for complete warranty information.

Non-Ford approved chemicals or additives are not required for factory recommended maintenance. In fact, Ford Motor Company recommends against the use of such additive products unless specifically recommended by Ford for a particular application.

Oil, fluids and flushing

In many cases, fluid discoloration is a normal operating characteristic and, by itself, does not necessarily indicate a concern or that the fluid needs to be changed. However, discolored fluids that also show signs of overheating and/or foreign material contamination should be inspected immediately by a qualified expert such as the factory-trained technicians at your Ford or Lincoln Mercury Dealership. Your vehicle's oils and fluids should be changed at the specified intervals or in conjunction with a repair. Flushing is a viable way to change fluid for many vehicle sub-systems during scheduled maintenance. It is critical that systems are flushed only with new fluid that is the same as that required to fill and operate the system, or using a Ford-approved flushing chemical.

Genuine Ford parts and service

When planning your maintenance services, consider your Ford and Lincoln Mercury dealership for all your vehicle's needs.

Get the most from your service and maintenance visits

There are a lot of reasons why visiting your Ford or Lincoln Mercury dealership for all your service needs is a great way to help keep your vehicle running great.

Convenience

Many dealerships have extended evening and Saturday hours to make your service visit more convenient. How's that for quality service?

Scheduled Maintenance Guide

Factory-trained technicians

Ford and Lincoln Mercury service technicians participate in extensive factory-sponsored certification training to help them become experts on the operation of your vehicle. Ask your dealership about the training and certification their technicians have received.

Genuine Ford and Motorcraft® replacement parts

Ford and Lincoln Mercury dealerships stock Ford and Motorcraft® branded replacement parts. These parts meet or exceed Ford Motor Company's specifications, and we stand behind them. Parts installed at your Ford or Lincoln Mercury dealership carry a nationwide, 12 months, 12,000 mile (20,000 km) parts and labor limited warranty. Your dealer can give you details.

Value shopping for your vehicle's maintenance needs

Your dealership recognizes the competitive landscape of maintenance and light repair automotive services. With factory-trained technicians, and one-stop service from routine maintenance like oil changes and tire rotations to repairs like brake service, check out the value your Ford and Lincoln Mercury dealers can offer.

WHICH MAINTENANCE SCHEDULE SHOULD YOU FOLLOW?

Owner checks and services

Certain basic maintenance checks and inspections should be performed by the owner or a service technician at the intervals indicated. Service information and supporting specifications are provided in this owner's guide.

Any adverse condition should be brought to the attention of your dealer or qualified service technician as soon as possible for the proper service advice. The owner maintenance service checks are generally not covered by warranties so you may be charged for labor, parts or lubricants used.

Maximum oil change interval

- 7,500 miles (12,000 km) or 6 months, whichever comes first

Engine coolant change interval

- 6 years or 105,000 miles (168,000 km) - change engine coolant (whichever comes first)
- After initial change - change engine coolant every 3 years or 45,000 miles (72,000 km).

Scheduled Maintenance Guide

Check every month

- Check function of all interior and exterior lights
- Check tires for wear and correct air pressure, including spare tire
- Check windshield washer fluid level
- Check engine oil level

Check every six months

- Check lap/shoulder belts and seat latches for wear and function
- Check parking brake for proper operation
- Check safety warning lamps (brake, ABS, airbag, safety belt) for operation
- Check cooling system fluid level and coolant strength
- Check battery connections and clean if necessary
- Check washer spray, wiper operation and clean all wiper blades (replace as necessary)
- Check and lubricate all hinges, latches and outside locks. Inspect for correct operation
- Check and lubricate door rubber weatherstrips. Inspect for excessive wear
- Check and clean body and door drain holes. Inspect for clogs and obstructions

Multi-point inspection

In order to keep your vehicle running right, it is important to have the systems on your vehicle checked regularly. This can help identify potential issues and prevent major problems. Ford Motor Company recommends the following multi-point inspection be performed at every scheduled maintenance interval to help ensure your vehicle keeps running great.

Scheduled Maintenance Guide

Multi-point inspection - Recommended at every visit

- Check and top-up fluid levels: brake, coolant recovery reservoir, manual and automatic transmission (if equipped with an underhood dipstick), power steering (if equipped) and window washer
- Inspect tires for wear and check air pressure, including spare.
- Check exhaust system for leaks, damage, loose parts and foreign material.
- Check battery performance.
- Check operation of horn, exterior lamps, turn signals and hazard warning lights.
- Check radiator, coolers, heater and air conditioning hoses.
- Inspect windshield washer spray and wiper operation.
- Check windshield for cracks, chips and pitting.
- Inspect for oil and fluid leaks.
- Inspect engine air filter.
- Inspect half shaft dust boots, if equipped.
- Check shocks and struts and other suspension components for leaks and damage.
- Inspect steering and linkage.
- Inspect accessory drive belt(s).
- Inspect clutch operation, if equipped.

Be sure to ask your Ford or Lincoln Mercury dealership service advisor or technician about the multi-point vehicle inspection. It's a comprehensive way to perform a thorough inspection of your vehicle. It's your checklist that gives you immediate feedback on the overall condition of your vehicle. You'll know what's been checked, what's okay, as well as those things that may require future or immediate attention. The multi-point vehicle inspection is one more way to keep your vehicle running great!

Scheduled Maintenance Guide

Panel's Member #: _____
 Panel's Service Balance: _____

Multi-Point Inspection Report Card as Recommended by Ford Motor Company

Make: _____ Model/Year: _____ Mileage: _____

Days: _____ Mile: _____ Static Inspection Month: _____

Vehicle Address: _____

SCHEDULED MAINTENANCE ITEMS DUE FOR SERVICES ON THIS VEHICLE			
DATE	PERFORMED	DATE	PERFORMED
Oil Change	<input type="checkbox"/>	Oil Filter	<input type="checkbox"/>
Engine Air Filter	<input type="checkbox"/>	Spark Plugs	<input type="checkbox"/>
Engine Coolant	<input type="checkbox"/>	Tire Rotation	<input type="checkbox"/>
Blind Spot Filter	<input type="checkbox"/>	Transmission Fluid	<input type="checkbox"/>
Oil Change	<input type="checkbox"/>	Transmission Fluid	<input type="checkbox"/>

*This is only a partial list of vehicle maintenance items and is NOT all-inclusive. Please consult your Owner's Manual or visit www.ford.com/owners for vehicle specific maintenance requirements.

CHECK FLUID LEVELS AND FILL			
Oil	Wash	Wash	Wash
Oil and/or fluid leaks	<input type="checkbox"/>	Wash	<input type="checkbox"/>
Wash	<input type="checkbox"/>	Wash	<input type="checkbox"/>
Wash	<input type="checkbox"/>	Wash	<input type="checkbox"/>

BATTERY	
State of Health	Condition of
<div style="width: 50%; height: 10px; background: linear-gradient(to right, green 50%, red 50%);"></div>	<input type="checkbox"/>

EXTERIOR BODY	
Factory spec cold cranking amps	<input type="checkbox"/>
Arctic Lock	<input type="checkbox"/>

TIRE BRAKE WEAR	
Left Front	Right Front
Left Rear	Right Rear

Comments: _____

Service Advisor: _____ Customer Signature: _____

Technician: _____ Customer Copy: _____ 12-XXXXXXX

Scheduled Maintenance Guide

NORMAL SCHEDULED MAINTENANCE AND LOG

The following section contains the “Normal Schedule”. This schedule is presented at specific mileage (kilometer) intervals with exceptions noted.

Scheduled Maintenance Guide

Miles (x 1,000)*	7.5	15	22.5	30	37.5	45	52.5	60	67.5	75
Kilometers (x 1,000)*	12	24	36	48	60	72	84	96	108	120
Months*	6	12	18	24	30	36	42	48	54	60
Change engine oil and filter	•	•	•	•	•	•	•	•	•	•
Rotate tires, inspect tire wear and measure tread depth.	•	•	•	•	•	•	•	•	•	•
Inspect wheels and related components for abnormal noise, wear, looseness or drag	•	•	•	•	•	•	•	•	•	•
Perform multi-point inspection (recommended)	•	•	•	•	•	•	•	•	•	•
Inspect automatic transmission fluid level (if equipped with dipstick). Consult dealer for requirements.		•		•		•		•		•
Inspect brake pads, shoes, rotors, drums, brake linings, hoses and parking brake		•		•		•		•		•
Inspect engine cooling system for strength, and hoses		•		•		•		•		•
Inspect exhaust system and heat shields		•		•		•		•		•
Inspect half-shaft boots (if equipped)		•		•		•		•		•
Inspect steering linkage, ball joints, suspension, tie-rod ends, driveshaft and U-joints; lubricate if equipped with grease fittings		•		•		•		•		•
Inspect cabin air filter (if equipped)	•			•		•		•		•

* Whichever comes first

Scheduled Maintenance Guide

Miles (x 1,000)*	82.5	90	97.5	105	112.5	120	127.5	135	142.5	150
Kilometers (x 1,000)*	132	144	156	168	180	192	204	216	228	240
Months*	66	72	78	84	90	96	102	108	114	120
Change engine oil and filter	•	•	•	•	•	•	•	•	•	•
Rotate tires, inspect tire wear and measure tread depth.	•	•	•	•	•	•	•	•	•	•
Inspect wheels and related components for abnormal noise, wear, looseness or drag	•	•	•	•	•	•	•	•	•	•
Perform multi-point inspection (recommended)	•	•	•	•	•	•	•	•	•	•
Inspect automatic transmission fluid level (if equipped with dipstick). Consult dealer for requirements.		•		•		•		•		•
Inspect brake pads, shoes, rotors, drums, brake linings, hoses and parking brake		•		•		•		•		•
Inspect engine cooling system for strength, and hoses		•		•		•		•		•
Inspect exhaust system and heat shields		•		•		•		•		•
Inspect half-shaft boots (if equipped)		•		•		•		•		•
Inspect steering linkage, ball joints, suspension, tie-rod ends, driveshaft and U-joints; lubricate if equipped with grease fittings		•		•		•		•		•
Inspect cabin air filter (if equipped)	•		•		•		•		•	

* Whichever comes first

Scheduled Maintenance Guide

Every 15,000 miles (24,000 km)	Replace cabin air filter (if equipped)
Every 30,000 miles (48,000 km)	Replace climate-controlled seat filter (if equipped)
	Replace engine air filter
	Replace fuel filter (Crown Victoria, Grand Marquis and Town Car)
Every 105,000 miles (168,000 km)	Change engine coolant ¹
	Replace spark plugs
	Inspect accessory drive belt(s) ²
Every 150,000 miles (240,000 km)	Change automatic transmission fluid and filter (filter not required on 6F35, 6F50, DPS6 and AWF-21 transmissions); consult dealer for requirements.
	Change manual transmission fluid
	Change rear axle fluid (RWD vehicles)
	Replace accessory drive belt(s) if not replaced within the last 100,000 miles (160,000 km)
	Replace timing belt (Fiesta). Failure to replace timing belt can cause internal engine damage.
¹ Initial replacement at 105,000 miles (160,000 km) or 72 months; every 45,000 miles (72,000 km) or 36 months thereafter	
² Perform a follow-up inspection at 120,000 miles (192,000 km)	

Scheduled Maintenance Guide

Maintenance schedule log

<p style="text-align: center;">DEALER VALIDATION:</p> <p>RO#: P&A CODE: DATE: HOURS: MILEAGE:</p>	<p style="text-align: center;">DEALER VALIDATION:</p> <p>RO#: P&A CODE: DATE: HOURS: MILEAGE:</p>
<p style="text-align: center;">DEALER VALIDATION:</p> <p>RO#: P&A CODE: DATE: HOURS: MILEAGE:</p>	<p style="text-align: center;">DEALER VALIDATION:</p> <p>RO#: P&A CODE: DATE: HOURS: MILEAGE:</p>
<p style="text-align: center;">DEALER VALIDATION:</p> <p>RO#: P&A CODE: DATE: HOURS: MILEAGE:</p>	<p style="text-align: center;">DEALER VALIDATION:</p> <p>RO#: P&A CODE: DATE: HOURS: MILEAGE:</p>
<p style="text-align: center;">DEALER VALIDATION:</p> <p>RO#: P&A CODE: DATE: HOURS: MILEAGE:</p>	<p style="text-align: center;">DEALER VALIDATION:</p> <p>RO#: P&A CODE: DATE: HOURS: MILEAGE:</p>
<p style="text-align: center;">DEALER VALIDATION:</p> <p>RO#: P&A CODE: DATE: HOURS: MILEAGE:</p>	<p style="text-align: center;">DEALER VALIDATION:</p> <p>RO#: P&A CODE: DATE: HOURS: MILEAGE:</p>

Scheduled Maintenance Guide

<p style="text-align: center;">DEALER VALIDATION:</p> <p style="text-align: center;">P&A CODE:</p> <p>RO#: HOURS:</p> <p>DATE: MILEAGE:</p>	<p style="text-align: center;">DEALER VALIDATION:</p> <p style="text-align: center;">P&A CODE:</p> <p>RO#: HOURS:</p> <p>DATE: MILEAGE:</p>
<p style="text-align: center;">DEALER VALIDATION:</p> <p style="text-align: center;">P&A CODE:</p> <p>RO#: HOURS:</p> <p>DATE: MILEAGE:</p>	<p style="text-align: center;">DEALER VALIDATION:</p> <p style="text-align: center;">P&A CODE:</p> <p>RO#: HOURS:</p> <p>DATE: MILEAGE:</p>
<p style="text-align: center;">DEALER VALIDATION:</p> <p style="text-align: center;">P&A CODE:</p> <p>RO#: HOURS:</p> <p>DATE: MILEAGE:</p>	<p style="text-align: center;">DEALER VALIDATION:</p> <p style="text-align: center;">P&A CODE:</p> <p>RO#: HOURS:</p> <p>DATE: MILEAGE:</p>
<p style="text-align: center;">DEALER VALIDATION:</p> <p style="text-align: center;">P&A CODE:</p> <p>RO#: HOURS:</p> <p>DATE: MILEAGE:</p>	<p style="text-align: center;">DEALER VALIDATION:</p> <p style="text-align: center;">P&A CODE:</p> <p>RO#: HOURS:</p> <p>DATE: MILEAGE:</p>
<p style="text-align: center;">DEALER VALIDATION:</p> <p style="text-align: center;">P&A CODE:</p> <p>RO#: HOURS:</p> <p>DATE: MILEAGE:</p>	<p style="text-align: center;">DEALER VALIDATION:</p> <p style="text-align: center;">P&A CODE:</p> <p>RO#: HOURS:</p> <p>DATE: MILEAGE:</p>

Scheduled Maintenance Guide

<p style="text-align: center;">DEALER VALIDATION:</p> <p style="text-align: center;">P&A CODE:</p> <p>RO#: HOURS:</p> <p>DATE: MILEAGE:</p>	<p style="text-align: center;">DEALER VALIDATION:</p> <p style="text-align: center;">P&A CODE:</p> <p>RO#: HOURS:</p> <p>DATE: MILEAGE:</p>
<p style="text-align: center;">DEALER VALIDATION:</p> <p style="text-align: center;">P&A CODE:</p> <p>RO#: HOURS:</p> <p>DATE: MILEAGE:</p>	<p style="text-align: center;">DEALER VALIDATION:</p> <p style="text-align: center;">P&A CODE:</p> <p>RO#: HOURS:</p> <p>DATE: MILEAGE:</p>
<p style="text-align: center;">DEALER VALIDATION:</p> <p style="text-align: center;">P&A CODE:</p> <p>RO#: HOURS:</p> <p>DATE: MILEAGE:</p>	<p style="text-align: center;">DEALER VALIDATION:</p> <p style="text-align: center;">P&A CODE:</p> <p>RO#: HOURS:</p> <p>DATE: MILEAGE:</p>
<p style="text-align: center;">DEALER VALIDATION:</p> <p style="text-align: center;">P&A CODE:</p> <p>RO#: HOURS:</p> <p>DATE: MILEAGE:</p>	<p style="text-align: center;">DEALER VALIDATION:</p> <p style="text-align: center;">P&A CODE:</p> <p>RO#: HOURS:</p> <p>DATE: MILEAGE:</p>
<p style="text-align: center;">DEALER VALIDATION:</p> <p style="text-align: center;">P&A CODE:</p> <p>RO#: HOURS:</p> <p>DATE: MILEAGE:</p>	<p style="text-align: center;">DEALER VALIDATION:</p> <p style="text-align: center;">P&A CODE:</p> <p>RO#: HOURS:</p> <p>DATE: MILEAGE:</p>

Scheduled Maintenance Guide

SPECIAL OPERATING CONDITIONS

If you operate your Ford/Lincoln/Mercury vehicle **primarily** in one of the more demanding **Special Operating Conditions** listed below, you will need to have some items maintained more frequently. If you only **occasionally** operate your vehicle under these conditions, it is not necessary to perform the additional maintenance. For specific recommendations, see your Ford or Lincoln Mercury dealership service advisor or technician.

Towing a trailer or using a camper or car-top carrier

Inspect frequently, service as required. – Inspect and lubricate U-joints.
– See axle maintenance items under *Exceptions*.

Every 5,000 miles (8,000 km) – Inspect wheels and related components for abnormal noise, wear, looseness or drag.
– Rotate tires, inspect tires for wear and measure tread depth.

Every 5,000 miles (8,000 km) or 6 months – Change engine oil and replace oil filter.
– Inspect and lubricate U-joints.

Every 30,000 miles (48,000 km) – Change automatic transmission fluid (except 6R80 transmission).

Every 60,000 miles (96,000 km) – Change manual transmission fluid.

Scheduled Maintenance Guide

Extensive idling and/or low-speed driving for long distances as in heavy commercial use such as delivery, taxi, patrol car or livery

- | | |
|--|--|
| Inspect frequently, service as required | – Replace cabin air filter (if equipped).
– Replace engine air filter. |
| Every 5,000 miles (8,000 km) | – Inspect brake system.
– Inspect wheels and related components for abnormal noise, wear, looseness or drag.
– Lubricate control arm and steering ball joints (if equipped with grease fittings).
– Rotate tires, inspect tires for wear and measure tread depth. |
| Every 5,000 miles (8,000 km) or 6 months | – Inspect and lubricate U-joints. |
| Every 5,000 miles (8,000 km), 6 months or 200 hours of engine operation | – Change engine oil and replace oil filter. |
| Every 15,000 miles (24,000 km) | – Replace fuel filter (Crown Victoria, Grand Marquis and Town Car). |
| Every 30,000 miles (48,000 km) | – Change automatic transmission fluid (except 6R80 transmission). |
| Every 60,000 miles (96,000 km) | – Replace spark plugs. |

Scheduled Maintenance Guide

Crown Victoria police interceptor & taxi, and Executive Series Town Car equipped with engine idle hour meter

Inspect frequently, service as required – Replace cabin air filter (if equipped).

Every 5,000 miles (8,000 km) – Inspect brake system.
– Inspect wheels and related components for abnormal noise, wear, looseness or drag.
– Lubricate control arm and steering ball joints (if equipped with grease fittings).
– Rotate tires, inspect tires for wear and measure tread depth.

Every 5,000 miles (8,000 km) or 6 months – Inspect and lubricate U-joints.

Every 5,000 miles (8,000 km), 6 months or as indicated by time/mileage calculation – Change engine oil and replace oil filter (see description below).

Every 15,000 miles (24,000 km) – Replace fuel filter.

Every 30,000 miles (48,000 km) – Change automatic transmission fluid (except 6R80 transmission).

Every 60,000 miles (96,000 km) – Replace spark plugs.

Scheduled Maintenance Guide

ENGINE IDLE HOUR METER (IF EQUIPPED):

Your vehicle may be equipped with an idle meter to indicate how much time the vehicle is idling in P (Park) or N (Neutral). The meter is incorporated with the vehicle odometer. Depressing the odometer-reset button once will display the trip odometer (miles [km] followed by a "T" for trip odometer). Depressing the odometer-reset button a second time will display the idle meter (hours followed by an "H" for hours). The idle meter only accumulates time when the vehicle is in P (Park) or N (Neutral). Displayed time is cumulative for the vehicle. **It cannot be reset to zero.** Police/Fleet vehicles often experience long periods of idling, during which engine oil will continue to break down but distance is not accumulated on the odometer.

To assist fleet managers in maintaining proper oil change intervals, the idle meter will help determine when an oil change is required. For every hour that the vehicle idles, it has accumulated the equivalent of approximately 33 miles (53 km) of driving. Using the combination of the vehicle odometer and idle meter allows the fleet manager to better determine when the oil needs to be changed

Engine idle hour meter calculation:

Idle hours x 33 = miles (km) equivalency

Miles (km) driven + miles (km) equivalency = oil change interval

Example: When the odometer has accumulated 3,000 miles (4,800 km) and the idle meter shows 61 hours, a 5,000 mile (8,000 km) oil change interval will have been reached: 3,000 road miles (4,800 road km) + (61 idle hours x 33 miles [53 km]/idle hour) = 5,013 miles (8,067 km).

Scheduled Maintenance Guide

Operating in dusty conditions such as unpaved or dusty roads

- | | |
|---|---|
| Inspect frequently, service as required | – Replace cabin air filter (if equipped).
– Replace engine air filter. |
| Every 5,000 miles (8,000 km) | – Inspect wheels and related components for abnormal noise, wear, looseness or drag.
– Rotate tires, inspect tires for wear and measure tread depth. |
| Every 5,000 miles (8,000 km) or 6 months | – Change engine oil and replace oil filter.
– Inspect and lubricate U-joints. |
| Every 15,000 miles (24,000 km) | – Replace fuel filter (Crown Victoria, Grand Marquis and Town Car). |
| Every 30,000 miles (48,000 km) | – Change automatic transmission fluid (except 6R80 transmission). |
| Every 50,000 miles (80,000 km) | – Change manual transmission fluid. |

Exclusive use of E85 (Flex Fuel Vehicles only)

- | | |
|----------------------------------|--|
| Every oil change interval | – If ran exclusively on E85, fill the fuel tank full with regular unleaded fuel. |
|----------------------------------|--|

Scheduled Maintenance Guide

Special operating condition log

<p style="text-align: center;">DEALER VALIDATION:</p> <p>RO#: P&A CODE: DATE: HOURS: MILEAGE:</p>	<p style="text-align: center;">DEALER VALIDATION:</p> <p>RO#: P&A CODE: DATE: HOURS: MILEAGE:</p>
<p style="text-align: center;">DEALER VALIDATION:</p> <p>RO#: P&A CODE: DATE: HOURS: MILEAGE:</p>	<p style="text-align: center;">DEALER VALIDATION:</p> <p>RO#: P&A CODE: DATE: HOURS: MILEAGE:</p>
<p style="text-align: center;">DEALER VALIDATION:</p> <p>RO#: P&A CODE: DATE: HOURS: MILEAGE:</p>	<p style="text-align: center;">DEALER VALIDATION:</p> <p>RO#: P&A CODE: DATE: HOURS: MILEAGE:</p>
<p style="text-align: center;">DEALER VALIDATION:</p> <p>RO#: P&A CODE: DATE: HOURS: MILEAGE:</p>	<p style="text-align: center;">DEALER VALIDATION:</p> <p>RO#: P&A CODE: DATE: HOURS: MILEAGE:</p>
<p style="text-align: center;">DEALER VALIDATION:</p> <p>RO#: P&A CODE: DATE: HOURS: MILEAGE:</p>	<p style="text-align: center;">DEALER VALIDATION:</p> <p>RO#: P&A CODE: DATE: HOURS: MILEAGE:</p>

Scheduled Maintenance Guide

<p style="text-align: center;">DEALER VALIDATION:</p> <p style="text-align: center;">P&A CODE:</p> <p>RO#: HOURS:</p> <p>DATE: MILEAGE:</p>	<p style="text-align: center;">DEALER VALIDATION:</p> <p style="text-align: center;">P&A CODE:</p> <p>RO#: HOURS:</p> <p>DATE: MILEAGE:</p>
<p style="text-align: center;">DEALER VALIDATION:</p> <p style="text-align: center;">P&A CODE:</p> <p>RO#: HOURS:</p> <p>DATE: MILEAGE:</p>	<p style="text-align: center;">DEALER VALIDATION:</p> <p style="text-align: center;">P&A CODE:</p> <p>RO#: HOURS:</p> <p>DATE: MILEAGE:</p>
<p style="text-align: center;">DEALER VALIDATION:</p> <p style="text-align: center;">P&A CODE:</p> <p>RO#: HOURS:</p> <p>DATE: MILEAGE:</p>	<p style="text-align: center;">DEALER VALIDATION:</p> <p style="text-align: center;">P&A CODE:</p> <p>RO#: HOURS:</p> <p>DATE: MILEAGE:</p>
<p style="text-align: center;">DEALER VALIDATION:</p> <p style="text-align: center;">P&A CODE:</p> <p>RO#: HOURS:</p> <p>DATE: MILEAGE:</p>	<p style="text-align: center;">DEALER VALIDATION:</p> <p style="text-align: center;">P&A CODE:</p> <p>RO#: HOURS:</p> <p>DATE: MILEAGE:</p>
<p style="text-align: center;">DEALER VALIDATION:</p> <p style="text-align: center;">P&A CODE:</p> <p>RO#: HOURS:</p> <p>DATE: MILEAGE:</p>	<p style="text-align: center;">DEALER VALIDATION:</p> <p style="text-align: center;">P&A CODE:</p> <p>RO#: HOURS:</p> <p>DATE: MILEAGE:</p>

Scheduled Maintenance Guide

EXCEPTIONS

In addition, there are several exceptions to the Normal Schedule. They are listed below:

Normal vehicle axle maintenance

- Rear axles and power take-off (PTO) units containing synthetic lubricant and light duty trucks equipped with Ford-design axles are lubricated for life. These lubricants are not to be checked or changed unless a leak is suspected, service is required or the axle assembly has been submerged in water. The axle and PTO lubricant should be changed anytime the axle and PTO have been submerged in water. During extended trailer tow operation above 70°F (21°C) ambient and wide open throttle for extended periods above 45 mph (72 km/h), non-synthetic rear axle lubricants should be replaced every 3,000 miles (4,800 km) or three months, whichever occurs first. The 3,000 mile (4,800 km) lubricant change interval may be waived if the axle was filled with 75W140 synthetic gear lubricant meeting Ford specification WSL-M2C192-A, part number FITZ-19580-B or equivalent. Add friction modifier XL-3 (EST-M2C118-A) or equivalent for complete refill of Traction-Lok rear axles (refer to *Maintenance product and specifications* in the *Maintenance and Specifications* chapter for details). The axle lubricant should be changed anytime an axle has been submerged in water.

Police/Taxi/Livery vehicle axle maintenance

- Replace rear axle lubricant every 100,000 miles (160,000 km). Rear axle lubricant change may be waived if the axle was filled with 75W140 synthetic gear lubricant meeting Ford specification WSL-M2C192-A, part number FITZ-19580-B or equivalent. Add four ounces (118 mL) of friction modifier XL-3 (EST-M2C118-A) or equivalent for complete refill of Traction-Lok rear axles. The axle lubricant should be changed anytime the axle has been submerged in water.

California fuel filter replacement

- If vehicle is registered in California, the California Air Resources Board has determined that the failure to perform this maintenance item will not nullify the emission warranty or limit recall liability prior to the completion of the vehicle's useful life. Ford Motor Company, however, urges you to have all recommended maintenance services performed at the specified intervals and to record all vehicle service.

Hot climate oil change intervals

- If operating conditions are normal and you drive your Ford, Lincoln or Mercury vehicle under typical, everyday conditions **and** you are using an API performance category oil of SL or later (for example SM, etc.) then you can follow the 7,500 mile (12,000 km) normal service oil change intervals schedule. Vehicles operating in the Middle East, North Africa, Sub-Saharan Africa or locations with similar climates must follow the oil change interval of 3,000 mile (5,000 km) if the owner is using oils defined by the American Petroleum Institute (API) performance category of API SK or earlier (for example SJ, etc.).

Engine air filter & cabin air filter replacement

- Engine air filter and cabin air filter life is dependent on exposure to dusty and dirty conditions. Vehicles operated in these conditions will require frequent inspection and replacement of the engine air filter and cabin air filter.

Scheduled Maintenance Guide

COOLANT CHANGE RECORD

Engine coolant

- 6 years or 105,000 miles (168,000 km) - change coolant (whichever comes first).
- After initial change - change coolant every 3 years or 45,000 miles (72,000 km).

Scheduled Maintenance Guide

Engine coolant change log

<p style="text-align: center;">DEALER VALIDATION:</p> <p>RO#: P&A CODE: DATE: HOURS: MILEAGE:</p>	<p style="text-align: center;">DEALER VALIDATION:</p> <p>RO#: P&A CODE: DATE: HOURS: MILEAGE:</p>
<p style="text-align: center;">DEALER VALIDATION:</p> <p>RO#: P&A CODE: DATE: HOURS: MILEAGE:</p>	<p style="text-align: center;">DEALER VALIDATION:</p> <p>RO#: P&A CODE: DATE: HOURS: MILEAGE:</p>
<p style="text-align: center;">DEALER VALIDATION:</p> <p>RO#: P&A CODE: DATE: HOURS: MILEAGE:</p>	<p style="text-align: center;">DEALER VALIDATION:</p> <p>RO#: P&A CODE: DATE: HOURS: MILEAGE:</p>
<p style="text-align: center;">DEALER VALIDATION:</p> <p>RO#: P&A CODE: DATE: HOURS: MILEAGE:</p>	<p style="text-align: center;">DEALER VALIDATION:</p> <p>RO#: P&A CODE: DATE: HOURS: MILEAGE:</p>
<p style="text-align: center;">DEALER VALIDATION:</p> <p>RO#: P&A CODE: DATE: HOURS: MILEAGE:</p>	<p style="text-align: center;">DEALER VALIDATION:</p> <p>RO#: P&A CODE: DATE: HOURS: MILEAGE:</p>

Index

A

AdvanceTrac178
Air cleaner filter255, 258
Air conditioning
 manual heating and air
 conditioning system42
Airbag supplemental restraint
system110–111, 119, 121
 and child safety seats112
 description111, 119, 121
 disposal125
 driver airbag112, 120, 122
 indicator light118, 124
 operation112, 120, 122
 passenger airbag112, 120, 122
 side airbag119
Ambient mood/lighting50
AM/FM25
Antifreeze
 (see Engine coolant)235
Anti-lock brake system
 (see Brakes)177
Anti-theft system83, 86
 arming the system86
 disarming a triggered
 system87
 triggering87
Audio system (see Radio)25
Automatic transmission184
 driving an automatic
 overdrive184
 fluid, adding252
 fluid, checking252
 fluid, refill capacities259
 fluid, specification259
Auxiliary input jack (Line in)33
Auxiliary power point59

Axle
 refill capacities259

B

Battery233
 acid, treating emergencies233
 jumping a disabled battery206
 maintenance-free233
 replacement, specifications ...258
 servicing233
Belt-Minder®106
Booster seats140
Brakes176–177
 anti-lock177
 anti-lock brake system (ABS)
 warning light177
 fluid, checking and adding252
 fluid, refill capacities259
 fluid, specifications259
 lubricant specifications259
 parking178
 shift interlock183
Break-in period5
Bulbs50

C

Capacities for refilling fluids259
CD25
Cell phone use9
Changing a tire199
Child safety seats129
 attaching with tether
 straps138
 in front seat129, 133
 in rear seat129, 133
 LATCH135
 recommendations127

Index

- Child safety seats - booster seats 140
 - Cleaning your vehicle
 - engine compartment 220
 - instrument panel 222
 - interior 223
 - plastic parts 221
 - washing 219
 - waxing 219
 - wheels 220
 - wiper blades 221
 - Climate control (see Air conditioning or Heating) 42
 - Clock adjust
 - AM/FM/CD 25
 - Clutch
 - fluid 252
 - operation while driving 187
 - recommended shift speeds 188
 - Compass, electronic 57
 - calibration 58
 - set zone adjustment 58
 - Console 59
 - Controls
 - steering column 64
 - Coolant
 - checking and adding 235
 - refill capacities 238, 259
 - specifications 259
 - Cruise control (see Speed control) 62
 - Customer Assistance 190
 - Ford Extended Service Plan 269, 272
 - Getting assistance outside the U.S. and Canada 216
 - Getting roadside assistance ... 190
 - Getting the service you need 211
 - Ordering additional owner's literature 217
 - Utilizing the Mediation/Arbitration Program 215
- ### D
- Daytime running lamps (see Lamps) 47
 - Dipstick
 - automatic transmission fluid 252
 - engine oil 231
 - Driving under special conditions 187
 - through water 189
- ### E
- Electronic message center 19
 - Emergencies, roadside
 - jump-starting 206
 - Emergency Flashers 191
 - Emission control system 249
 - Engine 262–263
 - cleaning 220
 - coolant 235
 - fail-safe cooling 239
 - idle speed control 233
 - lubrication specifications 259
 - refill capacities 259
 - service points 229–230
 - starting after a collision 192
 - Engine block heater 174
 - Engine fan 229
 - Engine oil 231
 - checking and adding 231
 - dipstick 231

Index

- filter, specifications232, 258
- recommendations232
- refill capacities259
- specifications259
- Event data recording7
- Exhaust fumes174
- F**
- Fail safe cooling239
- Fan, Engine Cooling227, 229
- Fleet MyKey programming68
- Floor mats67
- Fluid capacities259
- Fog lamps46
- Fuel241
 - calculating fuel
 - economy20, 246
 - cap243
 - capacity259
 - choosing the right fuel244
 - detergent in fuel245
 - filling your vehicle
 - with fuel241, 243, 246
 - filter, specifications240, 258
 - fuel pump shut-off switch192
 - improving fuel economy246
 - octane rating244, 262–263
 - quality245
 - running out of fuel245
 - safety information relating to automotive fuels241
- Fuel pump shut-off switch192
- Fuses192–193
- G**
- Gas cap (see Fuel cap)243
298
- Gas mileage
(see Fuel economy)246
- Gauges17
- H**
- Hazard flashers191
- Head restraints88
- Headlamps46
 - aiming48
 - bulb specifications51
 - daytime running lights47
 - flash to pass47
 - high beam46
 - replacing bulbs52
 - turning on and off46
- Heating
 - heating and air conditioning system42
- Hood228
- I**
- Ignition171, 262–263
- Infant seats
(see Safety seats)129
- Inspection/maintenance (I/M)
testing251
- Instrument panel
 - cleaning222
 - cluster12
 - lighting up panel
and interior47
- J**
- Jack199
 - positioning199
 - storage199
- Jump-starting your vehicle206

Index

K

- Keyless entry system
 - autolock74
- Keys84
 - positions of the ignition171

L

- Lamps
 - bulb replacement
 - specifications chart51
 - daytime running light47
 - fog lamps46
 - headlamps46
 - headlamps, flash to pass47
 - instrument panel, dimming47
 - interior lamps49–51
 - replacing bulbs52
- LATCH anchors135
- Lights, warning and indicator12
 - anti-lock brakes (ABS)177
- Load limits163
- Locks
 - autolock74
 - childproof77
 - doors73
- Lubricant specifications259
- Lug nuts205

M

- Manual transmission187
 - fluid capacities259
 - lubricant specifications259
 - reverse188
- Message center19

- english/metric button22
- system check button22
- warning messages22
- Mirrors61–62
 - automatic dimming rearview mirror61
 - heated62
 - side view mirrors (power)62
- Moon roof65
- Motorcraft® parts226, 258
- MyKey68

O

- Octane rating244
- Oil (see Engine oil)231

P

- Parental MyKey programming ...68
- Parking brake178
- Parts
 - (see Motorcraft® parts)258
- Passenger Occupant Classification Sensor97
- Power distribution box
 - (see Fuses)196
- Power door locks73
- Power mirrors62
- Power point59
- Power steering182
 - fluid, checking and adding252
 - fluid, refill capacity259
 - fluid, specifications259
- Power Windows60

Index

R

- Radio25
- Recommendations for
 - attaching safety restraints for children127
- Relays192
- Remote entry system79
 - illuminated entry82–83
 - locking/unlocking doors79–80
 - opening the trunk80
 - panic alarm80
 - replacement/additional transmitters81
 - replacing the batteries81
- Roadside assistance190

S

- Safety belts (see Safety restraints)95, 99–101, 103–104
- Safety Canopy119
- Safety defects, reporting218
- Safety restraints95, 99–101, 103–105
 - Belt-Minder®106
 - extension assembly105
 - for adults100–101, 103
 - for children125
 - Occupant Classification Sensor97
 - warning light and chime105–106
- Safety restraints - LATCH anchors135
- Safety seats for children129
- Safety Compliance Certification Label263
- Satellite Radio25
- Satellite Radio Information38
- Scheduled Maintenance Guide
 - Normal Scheduled Maintenance and Log279
 - What Maintenance Schedule Should You Follow?275
- Seats88
 - child safety seats129
 - cleaning224
 - heated93
- SecuriLock passive anti-theft system83
- Servicing your vehicle227
- Setting the clock25
- Side air curtain121
- SOS Post Crash Alert124
- Spark plugs, specifications258, 262–263
- Specification chart, lubricants259
- Speed control62
- Starting your vehicle171–172, 174
 - jump starting206
- Steering wheel
 - controls64
 - tilting57
- Stereo
 - CD-MP325
- SYNC®41

T

- Tilt steering wheel57
- Tire Pressure Monitoring System (TPMS)
 - Tires, Wheels and Loading159

Index

- Tires144–145, 199
 alignment152
 care148
 changing199, 202
 checking the pressure148
 inflating146
 label158
 replacing150
 rotating152
 safety practices151
 sidewall information153
 snow tires and chains163
 spare tire199
 terminology145
 tire grades145
 treadwear144, 149
- Towing169
 recreational towing169
 trailer towing169
 wrecker209
- Transmission
 automatic operation184
 brake-shift interlock (BSI)183
 fluid, checking and adding
 (automatic)252
 fluid, checking and adding
 (manual)255
 fluid, refill capacities259
 lubricant specifications259
 manual operation187
- Trunk77
 remote release67, 80
- Turn signal49
- U**
- USB port35
- V**
- Vehicle Identification Number
(VIN)264
- Vehicle loading163
- Ventilating your vehicle174
- W**
- Warning lights (see Lights)12
- Washer fluid230
- Water, Driving through189
- Windows
 power60
- Windshield washer fluid and
wipers56
 checking and adding fluid230
 replacing wiper blades230
- Wrecker towing209

Free Manuals Download Website

<http://myh66.com>

<http://usermanuals.us>

<http://www.somanuals.com>

<http://www.4manuals.cc>

<http://www.manual-lib.com>

<http://www.404manual.com>

<http://www.luxmanual.com>

<http://aubethermostatmanual.com>

Golf course search by state

<http://golfingnear.com>

Email search by domain

<http://emailbydomain.com>

Auto manuals search

<http://auto.somanuals.com>

TV manuals search

<http://tv.somanuals.com>