

FS-4300

Digital Satellite Receiver

Receives Free Satellite Channels



More information
available at
www.fortecstar.com

User's Guide

FS-4300



Digital Satellite Receiver

Receives Free Satellite Channels

 **FORTEC STAR**[®]
Since 1994

Download from Www.Somanuals.com. All Manuals Search And Download.

Contents

GENERAL INFORMATION

3

Main Features	3
For your Safety	4
Unpacking	5
General Operation	5
RCU	6

INSTALLATION

7

Rear Panel	7
Connecting to TV& VCR using SCART support	7
Connecting to TV using RCA support	8
Connecting to Digital Amplifier	8

MENU INFORMATION

9

Main Menu	9
1. Channel List	10
1.1 TV Channel List	10
1.2 Radio Channel List	13
1.3 Delete All	13
1.4 Deltec channels by satellite	13
2. Installation	14
2.1 Antenna Connection	14
2.2 Satellite List	14
2.3 Antenna Setup	15
2.4 Single Satellite Search	18
2.5 Multi Satellite Search	18
2.6 TP List	19
3. System Setup	20
3.1 Language	20
3.2 TV	20
3.3 Local Time setting	21
3.4 Timer Setting	21
3.5 Parental Control	22
3.6 OSD Setting	22
3.7 Favorite	23
3.8 Other	23

Contents

4. Tools	23
4.1 Information	24
4.2 Factory Setting	24
5. Game	24
6. Hot key	25
6.1 Info	25
6.2 EPG	25
6.3 Find	26
6.4 Number	26
6.5 TV/Radio	26
6.6 Up/Down	26
6.7 Left/Right	26
6.8 Mute	26
6.9 Pause	26
6.10 OK	26
6.11 Audio	27
6.12 Recall	27
6.13 Fav	27
6.14 Teletext	27
6.15 Zoom	27

TROUBLE SHOOTING

28

WARNING

If the battery is fixed or packed, it should not be exposed to excessive heat like, Sunlight or Fire etc....

The connection to the device must have ON / OFF Switch for easy operation.

تحذير

البطاريات سواء كانت مركبه او محزمه يجب الا تتعرض للحراره الزائده مثل اشعه الشمس او النار وماشابه ذلك

قابض مصدر الكهرباء الرئيسي اوقارن الجهاز كاداه الفصل يجب ان يبقي جاهز لامكانيه التشغيل

GENERAL INFORMATION

A Digital Satellite Receiver is a convenient product that allows you to view a variety of programs provided through satellite. This user's guide covers the installation of the DSR and the necessary steps to implement various features. This also explains special features available only in this DSR in detail, which will allow you to make full use of these features.

Information confirmed in this document is subject to change. We reserve the right, without notice, to make changes in product design or performance as progress in engineering or technology.

Main Features

- High quality Video & Audio & Digital Audio
- Fully MPEG-2, DVB compliant
- Provide friendly and easy-to-use menu system
- Various channel editing function (Favorite, moving, locking, renaming, deleting and sorting)
- User programmable various Satellite & Transponder information
- Automatically search for newly added transponder
- Stores up to 4000 channels
- Easy and speedy software upgrade through RS-232 port
- Plug-and-play data transfer system (DSR to DSR)
- Timer function, automatically turns On/Off by setting function (daily, monthly, yearly)
- Automatic reserved channel moving system
- Provide Electronic Program Guide (EPG)
- Teletext function support
- 256 colors On-Screen-Display
- Last channel automatically saving

GENERAL INFORMATION

For Your Safety

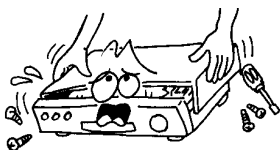

- To avoid electric-shock hazards, do not open the cabinet, refer servicing to qualified personnel only.



- Keep the receiver away from flower vases, tubs, sinks, etc., in order to avoid damaging the equipment.



- Do not expose the receiver under the sunlight. And keep it away from the heat source.

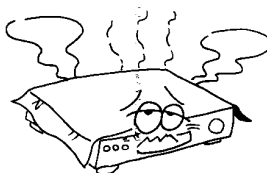

- Do not block ventilation holes of the Receiver so that air can circulate freely.

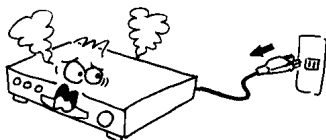

- When the abnormal phenomenon occur, you should cut off the power immediately.

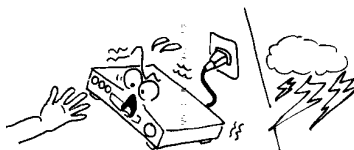

- Do not touch the receiver during thunder, since that might create electric-shock hazards.



- Switch the receiver off whenever it remains out of service for an extended period.

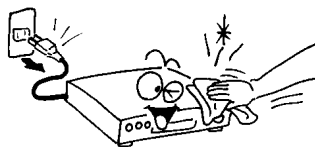

- Be sure to turn the Receiver off and disconnect the AC power cord before cleaning the Receiver surface. If the surface is dirty, wipe clean with a cloth which has been dipped in a weak soap-and-water solution and wrung out thoroughly, and then wipe again with a dry cloth.

GENERAL INFORMATION

Unpacking

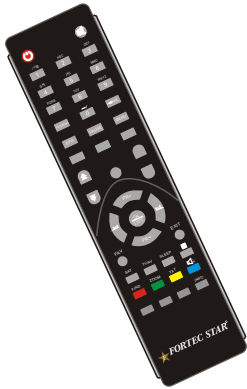

● Remote Control



● Batteries



● User's Guide

General Operation

- Throughout this manual you will notice that the everyday operation of the receiver is based on a series of user friendly on screen display and menus. These menus will help you get the most from your receiver, guiding you through installation, channel organizing, viewing and many other functions.
- All function can be carried out using the buttons on the RCU, and some of the function can also be carried out using the buttons on the front panel.
- The receiver is easy to use, always at your command and adaptable for future advances.
- Please be aware that new software may change the functionality of the receiver.
- Should you experience any difficulties with the operation of your receiver, please consult the relevant section of this manual, including the Problem Shooting, or alternatively call your dealer or a customer service adviser.

GENERAL INFORMATION

RCU



Key	Function
	Turns power ON/OFF of the DSR
	When watching a channel, mute the sound
0~9	Enter number of the required menu item or select a channel number to watch
TV/RADIO	Switches between TV and Radio mode
← PR	Switches back to previous channel
FAV	Display the favorite group list
SAT	Display the satellite list
FIND	Display the Find window
INFO	Show information of the current channel
MENU	Press this key one time to run menu onscreen
▲ ▼	Moves up / down a page in the list
OK, LIST	Executes the selected item in the menu screen or enters the desired value in any input mode
PR+, PR-	When watching a channel, change channels or move to the next higher or lower item in the menu
◀ ▶	When watching a channel, adjust the volume or move to the left or right item in the menu
EXIT	Return to the previous menu on the menu screen or escape from the menu
EPG	Call up the EPG (Electronic Program Guide)
	Display the Audio window.
TV/AV	Switch between TV and AV modes
TXT	Switch to teletext or subtitle mode
ZOOM	Enter into the zoom in mode
PAUSE	Press once to pause the screen picture, press once again to go to the normal mode
SLEEP	Enter into the sleep in mode
	Enter into the nine-pictures mode displayed on the screen.

INSTALLATION

Rear Panel

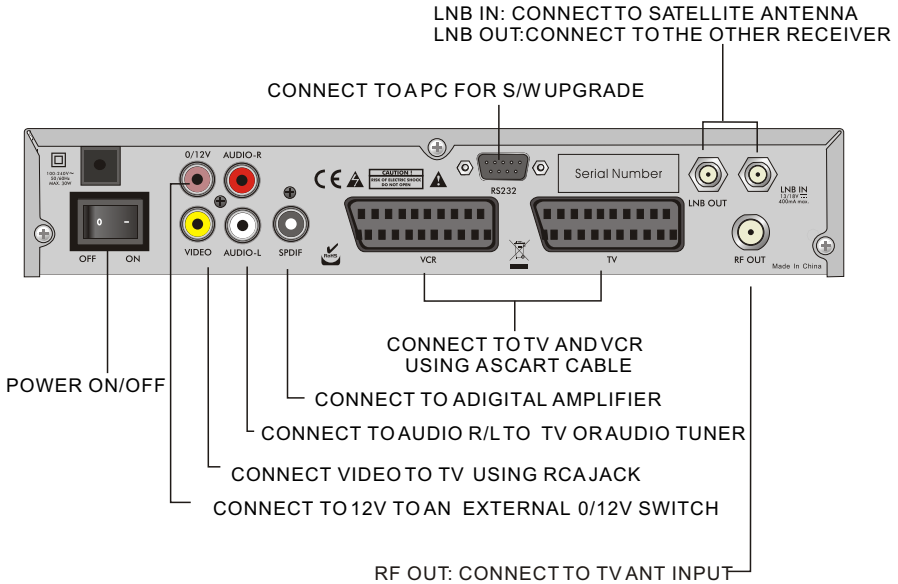

Connecting to TV using SCART support

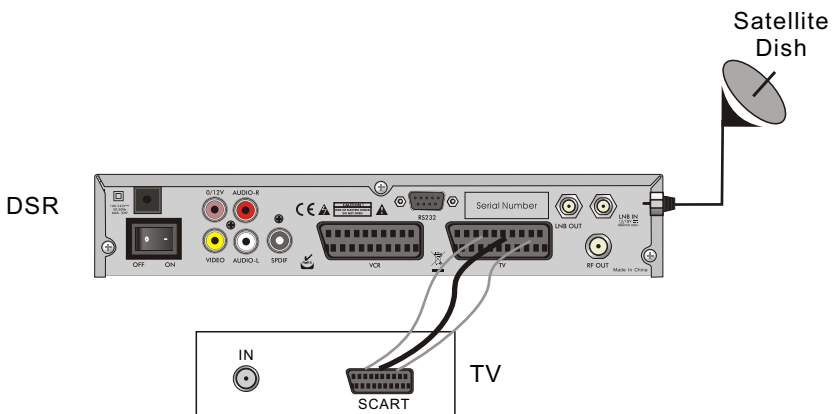

INSTALLATION

Connecting to TV using RCA support

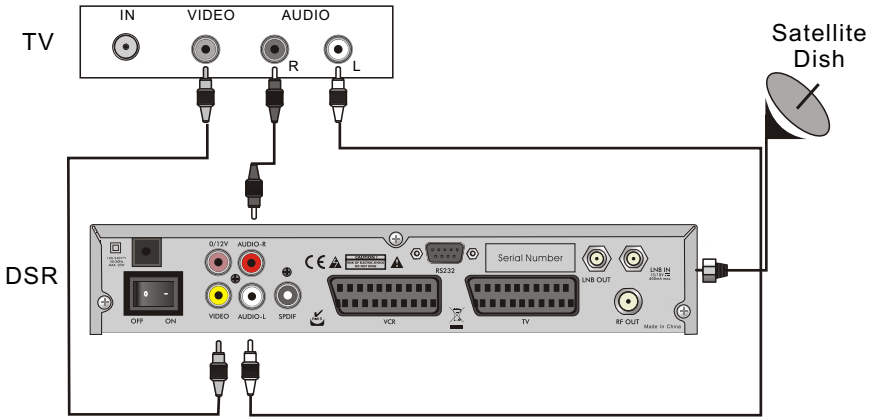

Connecting to Digital Amplifier

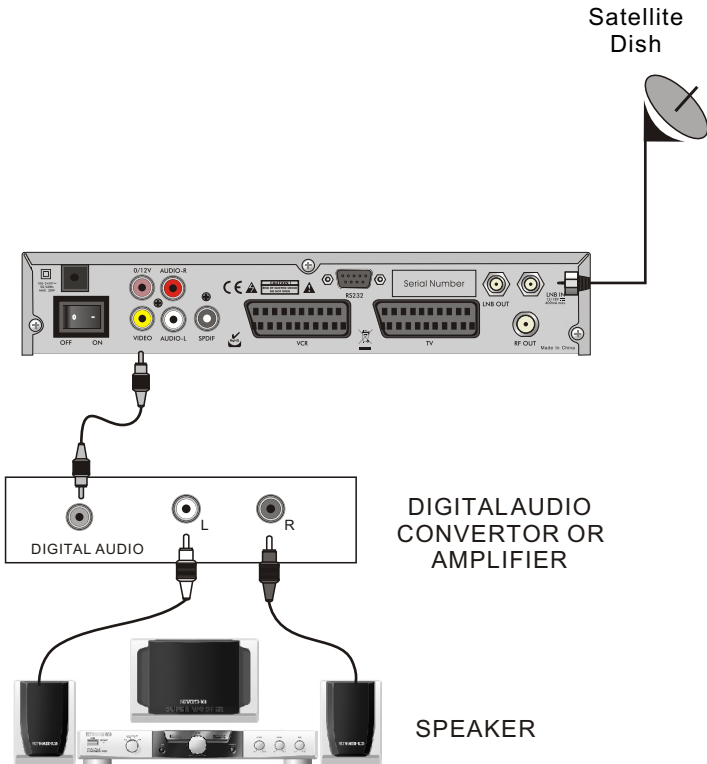

MENU INFORMATION

Main Menu

- Make sure that you have properly installed and connected the cables of the receiver well. If the receiver is the factory status or there is no program list, when power on, the Main Menu window will be displayed on the screen.

During the normal TV/Radio mode, press **MENU** key on the RCU to enter into the **Main Menu** window.

- This menu consists of 5 major main menus as follow.

- **Edit Channel**
- **Installation**
- **System Setup**
- **Tools**
- **Game**



- During the installation the **OK** key confirms a selection and **LIST** key shows Down List Box if the column has ◀ ▶ mark. You can also use the numeric keys on the RCU to enter numeric value.

Use the **PR+**, **PR-** key to move upwards and downwards from one line to another line and use **↵**, **⏪** key to move from main menu to sub menu and move from left side to rightside or versa.

Meantime, you want to escape the menu system, please press **MENU** or **EXIT** key on the RCU.

MENU INFORMATION

- If there is no program, you can not exit from the **Main Menu** window by pressing **MENU** or **EXIT** key. System will inform "No channel" and the following items turn grey.

Sub-menu	Turn grey when there is no program
Edit Channel	TV Channel List Radio Channel List Delete all Delete channels by satellite
Installation	Antenna Connection Satellite List Antenna Setup Single Satellite Search Multi Satellite Search TP List
System Setup	Language TV System Local Time Setting Timer Setting Parental Lock OSD Setting Favorite Other
Tools	Information Factory Setting SatcoDX Auto Programing
Game	Tetris Othello

1. Edit Channel

1. Press **OK** key or ∇ key to pop up the "Input Password" dialogue, you can not enter into the menu unless the correct password is inputted. The default password is "0000".
2. Press **PR+**, **PR-** keys to move the cursor up or down.
3. Press **EXIT** key or \triangleleft key to move the focus to the left menu.

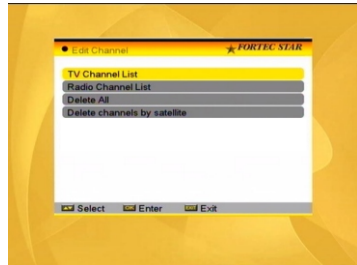

1.1 TV Channel List

1. Press \triangleleft ∇ keys to select satellite.
2. Press **PR+**, **PR-** keys to select the program that you want to play, and then press **OK** key to view it in the small window. If move the **yellow** cursor to select up or down, you will see a gray line which indicates the playing program in the small window.



MENU INFORMATION

3. Press **FAV** key to move the FAV button upward. Select the program and press **OK** key to pop up the favourite group list. In the list, select the group that you want to add into and press **OK** key, and then you will find the favourite mark is displayed at the right side of the selected program.

Press **FAV** key again to exit from the fav mode, and you will find the FAV button return to the origin position.

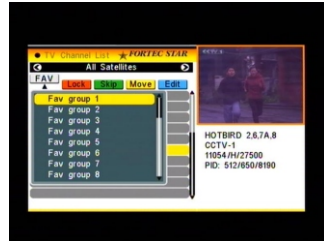

4. Press **red** colour key to move the Lock button upward. Select the program and press **OK** key to mark this program with the Lock mark. You can cancel this mark by pressing **OK** key once more.

Press **red** colour key again to exit from the lock mode, and you will find the Lock button return to the origin position.

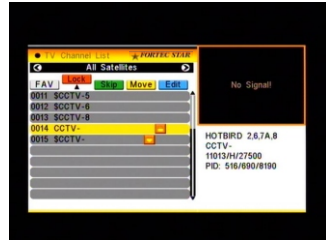

5. Press **green** colour key to move the Skip button upward. Select the program and press **OK** key to mark this program with the skip mark. You can cancel this mark by pressing **OK** key once more.

Press **green** colour key again to exit from the skip mode, and you will find the Skip button return to the origin position.

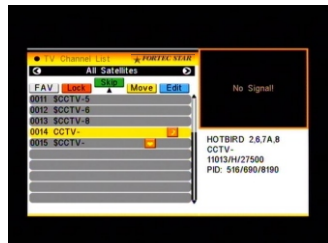

6. Press **yellow** colour key to move the Move button upward. Select the program and press **OK** key to mark this program with the move mark. Press **PR+**, **PR-** keys to move the cursor to the position where you want to locate and press **OK** key to confirm.

Press **yellow** colour key again to exit from the yellow mode, and you will find the yellow button return to the origin position.

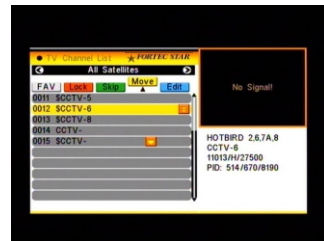

7. Press **blue** colour key to enter into the **Edit channel** window.

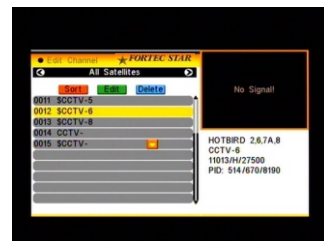

MENU INFORMATION

i. Sort (red colour key)

Press **red** colour key to pop up the Sort drop-down list.

Name(A-Z): The ascending order, omitting the \$ character, the number is ahead, then the capital letter, at last the lowercase.

Name (Z-A): The opposite order of the above Name (A-Z).

Free/Scramble:: All FTA programs are listed ahead, while all scrambled programs are listed last.

Lock: all locked programs are listed at the last.

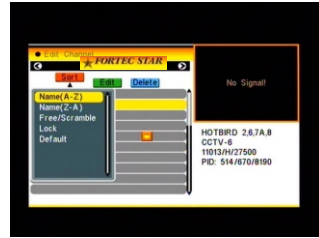

ii. Edit (green colour key)

Press green colour key to move the Edit button upward. Select the program and press **OK** key to pop up the **Rename** window.

In **Rename** window, press **red** colour key to switch between capital letter and lower letter; press **green** colour key to delete the character on the cursor; press **←** **→** keys to move the cursor left or right; press **numeric keys (0-9)** to input the character, please refer to the down table. Press **yellow** colour key to save and exit, or press **blue** key to cancel and exit.

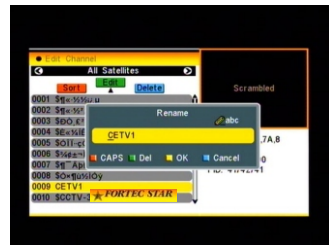

Numeric keys	Press numeric key repeatedly, display in circle
1	.,*?!@1
2	ABC2
3	DEF3
4	GHI4
5	JKL5
6	MNO6
7	PQRS7
8	TUV8
9	WXYZ9
0	[space]_-0

If the name is empty, system will pop up a dialogue informing "Name" once **yellow** colour key is pressed. Press **OK** key to close this dialogue.

MENU INFORMATION

iii. Delete (blue colour key)

In **Delete** window, press **blue** colour key to move the Delete button upward. Select the program and press **OK** key to mark this program with the deletion mark. You can cancel this mark by pressing **OK** key again. Press **EXIT** key to pop up the dialogue "Are you sure to save?". Select Yes button and press **OK** key to save, or select NO button and press **OK** key to exit without saving.

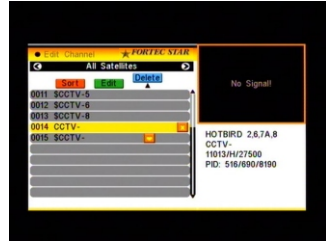

1.2 Radio Channel List

Sine the same operation as 1.1 TV Channel List, here we don't explain any more.

1.3 Delete All

Move cursor to the **Delete All** item, and press **OK** Key to pop up the dialogue "Warning! Do you really want to delete all channel?".

Press **EXIT** key to pop up the dialogue "Are you sure to save?". Select Yes button and press **OK** key to save, or select NO button and press **OK** key to exit without saving.



1.4 Delete Channels by satellite

Move cursor to the Delete channels by satellite item, and press OK key to pop up the dialogue "Warning! Do you really want to delete all channel?". Select Yes button and press OK key to delete the channels, or select NO button and press OK key to exit without deleting.

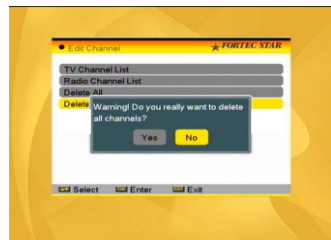

MENU INFORMATION

2. Installation

1. Press **OK** key or ∇ key to pop up the "Input Password" dialogue, you can not enter into the menu unless the correct password is inputted. The default password is "0000".
2. Press **PR+**, **PR-** keys to move the cursor up or down.
3. Press **EXIT** key or \triangleleft key to move the focus to the left menu.



2.1 Antenna Connection

Press \triangleleft ∇ keys to select between Motor Antenna and Fixed Antenna.



2.2 Satellite List

1. Press **PR+**, **PR-** keys to select the satellite up or down. Press **OK** key to select and mark, and you can press **OK** key again to cancel the selection and the mark.
2. If there is no satellite, the red colour and blue colour keys will be invalid.



3. Press **red** colour key to pop up the **Edit Satellite** window. Press **PR+**, **PR-** keys to move cursor up or down.

Name: User numeric keys to change the name of the satellite, please refer to the **Edit Channel Name**.

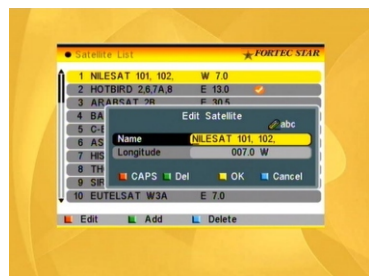

MENU INFORMATION

Longitude: You can press \leftarrow \rightarrow keys to switch between east longitude and west longitude. After pressing **OK** key, you can use numeric keys to edit the longitude, press **EXIT** key or the **PR+**, **PR-** keys to exit editing mode. The range of the longitude is from 1 to 180 degree. If beyond this range, system will inform you "out of range" when you press **yellow** colour key on the RCU.

After setting, press **yellow** colour key to save and exit, while press blue colour key to exit without saving.

4. Press **green** colour key to pop up the **Add Satellite** window. Since the same operation as the above **Edit Satellite** window, here we don't explain anymore.

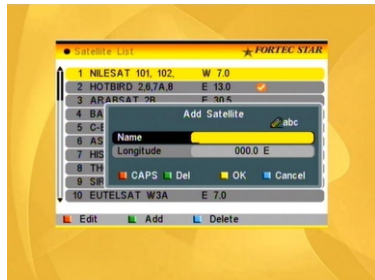

5. Press **blue** colour key to pop up the dialogue "Are you sure to delete?". Select Yes button and press **OK** key to delete the selected satellite. You can cancel this operation by pressing **OK** key at the NO button.

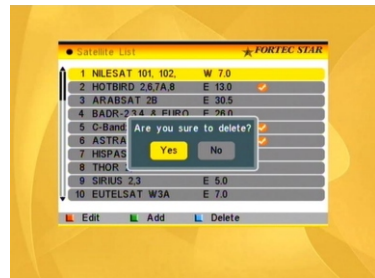

2.3 Antenna Setup

Part A: Fixed

Suppose that you have selected Fixed Antenna in the **Antenna Connection** window.

1. **Satellite:** All selected satellites in the satellite list are displayed in this item.

Press \leftarrow \rightarrow keys to select the satellite in circle. Or press **OK** key to pop up the drop-down list, then select the desired satellite in the list and press **OK** key to confirm.

2. **LNB Freq, Transponder, DiSEqC1.0, DiSEqC1.1:** The same operation as the above.

3. **22K, 0/12V, Toneburst, Polarity:** You can press \leftarrow \rightarrow keys to select in circle.

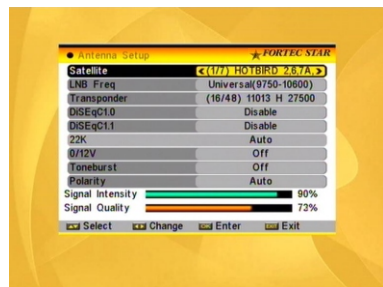

MENU INFORMATION

Part B: Motor

Suppose that you have selected Motor Antenna in the **Antenna Connection** window.

- 1. LNB Type:** Select the proper LNB type.
- 2. Motor Type:** Select between DiSEqC1.2 and USALS. If you select DiSEqC1.2, the following Local Longitude and Local Latitude items will turn grey.
- 3. Delete All:** Press **OK** key to pop up the dialogue "Are you sure to clear set satellite position of this tuner?". Press **OK** key at the Yes button to clear all the memories about the position of the satellites that has connected to the current tuner.

4. Motor Setting: Press **OK** key to the **Motor Setting** window.

Satellite: Press \leftarrow \rightarrow keys to select the satellite in circle. Or press **OK** key to pop up the drop-down list, then select the desired satellite in the list and press **OK** key to confirm.

Transponder: The same operation as the above.

Position No., & Save: The range is from 0 to 63. "0" delegates the original position. You can select the proper value when you has rotated the antenna.

Go to X: Press **OK** key to pop up the drop-down list, select the proper position (reference or from 1 to 63) to realize the selected position.

West <Save> East: Press \leftarrow key to turn west, while press \rightarrow key to turn east. Press **OK** key to pop up the dialogue "Are you sure to change this satellite's position?". Press **OK** key at the Yes button to save the current position, or press **OK** key at the No button to cancel the operation.

Recalculation: Press **OK** key to pop up the dialogue "Are you sure to change this satellite's position?". Press **OK** key at the Yes button to recalculation.

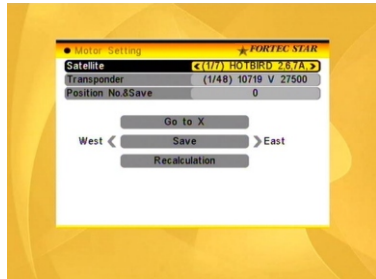
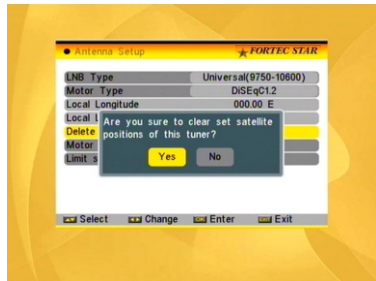
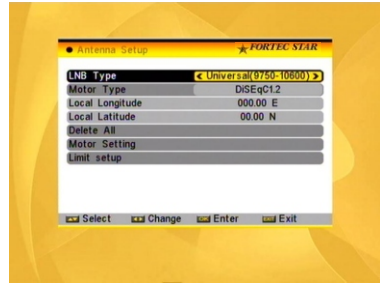

MENU INFORMATION

5. Limit Setup: Press **OK** key to pop up the **Limit Setup** window.

Limit Setup: Press \leftarrow \rightarrow keys to switch among Disable Limit, East Limit and West Limit.

Limit Setup: Move cursor to the Limit Setup button. You can press \leftarrow key to turn west , or press \rightarrow key to turn east.

Go to Reference: Press **OK** key to go to reference. If you select Disable Limit in the above Limit Setup item, this button will turn grey.



6. If select USALS, Delete All item will turn grey.

Local Longitude, Local Latitude: Press \leftarrow \rightarrow keys to switch between West and East, or press \leftarrow \rightarrow keys to switch between North and South. Press **OK** key to enter into the editing mode. Use **numeric keys (0-9)** to input the longitude or latitude, press **MENU** key or **EXIT** key to exit. The range of the longitude is from 0 to 180, while the range of the latitude is from 0 to 90. If the inputted value is not in this range, system will pop up a dialogue "Out of Range" when exit from this window. You can press **OK** key to close this dialogue.

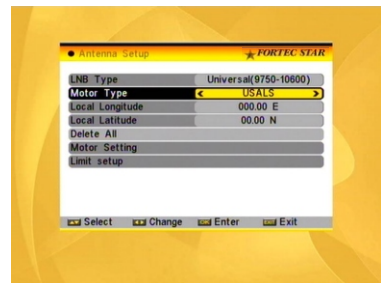

7. Motor Setting: Press **OK** key to enter into the **Motor setting** window.

Satellite, Transponder: Press \leftarrow \rightarrow keys to select satellite or transponder, or press **OK** key to pop up the drop-down list and select in the list.

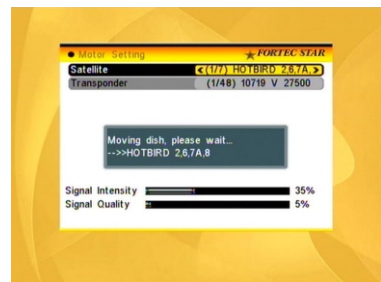

MENU INFORMATION

2.4 Single Satellite Search

1. Satellite : Press $\leftarrow \rightarrow$ keys to select the satellite in circle. Or press **OK** key to pop up the drop-down list, then select the desired satellite in the list and press **OK** key to confirm.

2. FTA Only: Press $\leftarrow \rightarrow$ keys to select between Yes and No.

3. Scan Channel: Press $\leftarrow \rightarrow$ keys to select among TV+Radio, TVChannel, Radio.

4. Network Search: Select between No and Yes. This item turns grey when Auto Scan is selected in the following Scan mode item.

5. Scan Mode: Press $\leftarrow \rightarrow$ keys to select between Auto Scan and Preset Scan. Auto Scan is Blind scan, while Preset Scan is to search the preset frequencies.

6. Search: Press **OK** key to start searching.

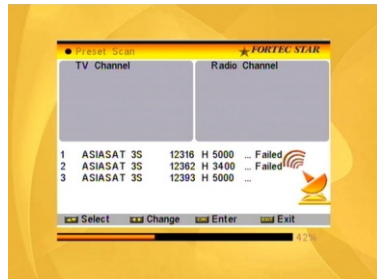

2.5 Multi Satellite Search

From the **Multi Satellite Search** window, you can search several satellites at the one time.

1. Satellite: All selected satellites in the satellite list window are displayed on the down part. You can press $\leftarrow \rightarrow$ keys to switch among them.

2. FTA Only: Press $\leftarrow \rightarrow$ keys to select between Yes and No.

3. Scan Channel: Press $\leftarrow \rightarrow$ keys to select among TV+Radio, TVChannel, Radio.

4. Network Search: Select between No and Yes. This item turns grey when Auto Scan is selected in the following Scan mode item.

5. Scan Mode: Press $\leftarrow \rightarrow$ keys to select between Auto Scan and Preset Scan. Auto Scan is Blind scan, while Preset Scan is to search the preset frequencies.

6. Search: Press **OK** key to start searching.

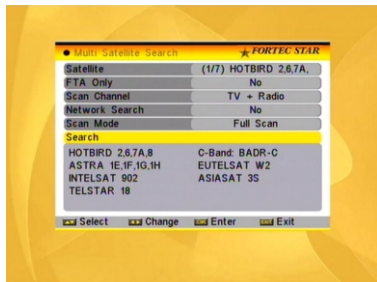

MENU INFORMATION

2.6 TP List

1. Press **PR+,PR-** keys to select the proper satellite.

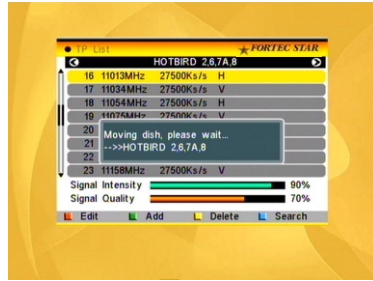

2. Press **red** colour key to pop up the **Edit TP** window.

Frequency, Symbol rate: Press \leftarrow \rightarrow keys to add or reduce by step one. Or press **numeric keys (0-9)** to input the desired value. The range of the frequency is 3000-13450, while the range of the symbol rate is 1000~45000. The inputted value is beyond this range, the value will return to the origin value.

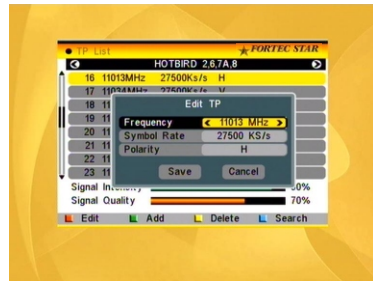

Polarity: Press \leftarrow \rightarrow keys to switch between Vertical and Horizontal.

3. Press **green** colour key to pop up the **Add TP** window. Since the same operation as the above **Edit TP** window, here we don't explain any more.

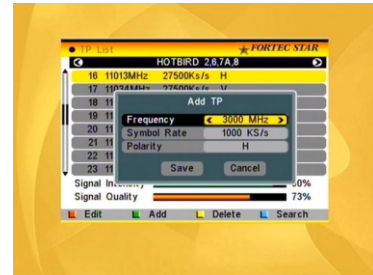

4. Press **yellow** colour key to pop up dialogue "Are you sure to delete?". Press **OK** key at the Yes button to delete the selected TP, or press **EXIT** key to cancel the operation.

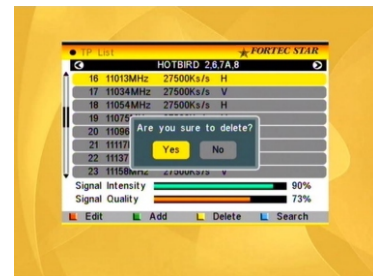

MENU INFORMATION

5. Press **blue** colour key to pop up the **TP Search** window.

FTA only, Scan Channel, Network Search:

Press \leftarrow \rightarrow keys to select the proper option.

Press **OK** key at the OK button to start searching.

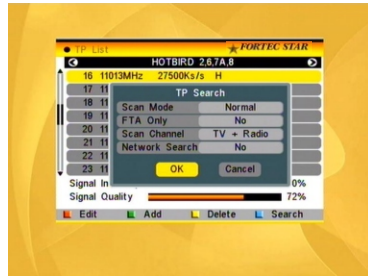

1. Press **OK** key or \rightarrow key to move the cursor to the right menu.

2. Press **PR+, PR-** keys to move the cursor up or down.

3. Press **EXIT** key or \leftarrow key to move the focus to the left menu.

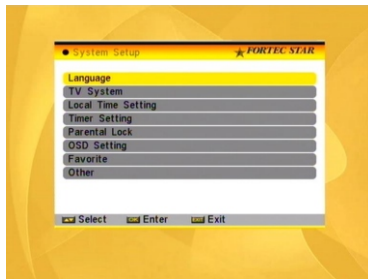

3. System Setup

3.1 Language

1. Press **OK** key to enter into the **Language** window. Press \leftarrow \rightarrow keys to select the language in circle, while press **PR+, PR-** keys to move the cursor up or down in circle.

2. Press **MENU** key or **EXIT** key to save and exit.

3. The types of the language, please refer to the configuration of the customer.

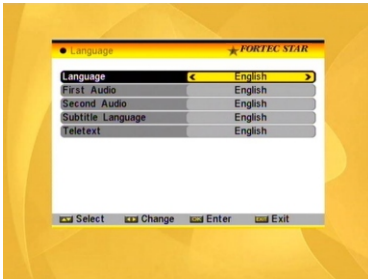

3.2 TV System

Press **PR+, PR-** key to move the cursor up or down, while press \leftarrow \rightarrow keys to change the setting and the setting will take effect immediately.

1. **Display Mode:** Select among Auto, PAL, PAL-M, PAL-N, NTSC.

2. **Aspect Mode:** Select among 4:3LetterBox, 4:3PanScan, 16:9.

3. **Video Output:** Select between RGB and CVBS.

4. **RF System:** Select among PAL-BG, PAL-I, PAL-DK and NTSC.

5. **RF Channel:** PAL:21-69, ntsc:14-83.



MENU INFORMATION

3.3 Local Time Setting

1. Summer Time: Select between ON and OFF. "OFF" delegates the normal time. If select ON, time will add one hour.

2. GMT Offset: When select "ON" in GMT Usage item, system will get the date and time information from the screen automatically. Date and Time two items will turn grey. Select the proper option in the GMT Offset item. The default setting is GMT ON.

3. Date, Time: When select "OFF" in GMT Usage, Date and Time two items take effect, while GMT Usage turns grey. Use numeric keys to input the desired value. After setting, press **MENU** key or **EXIT** key to exit and save. If the value is invalid, system will inform "Invalid input! Continue to edit?". Press **OK** key at the Yes button to continue the modification, or press **OK** key at the No button to exit without saving.



3.4 Timer Setting

If there is no program, you can not enter into this window. There are 8 timers that can be set. Select Timer up or down, and press **OK** key to enter into the setting window.

1. Timer mode: The default mode is off. You can set the timer once, daily, weekly, monthly and yearly.



2. Timer Service: You can select Channel the Wakeup Channel is displayed in the following item.

3. Wakeup Date, On Time: Use numeric keys to input the valid date.



MENU INFORMATION

Duration: Set the gap time. After waking up, system will power off automatically after the duration time.

Press **MENU** or **EXIT** key to save and exit.

3.5 Parental Lock

Before entering into the **Parental Lock** window, you need input the correct password. The default password is **0000**.

1. Menu Lock: Press \leftarrow \rightarrow keys to select between Off and On. If select "On", you can not enter into the most window before entering the password.

2. Channel Lock: Press \leftarrow \rightarrow keys to select between Off and On. The default value is Off.

If select "On", you can not view the locked channel set in **Chanel List Edit** window until you have inputted the correct password.

3. New Password: User **numeric key (0-9)** to input the new password.

4. Confirm Password: Input the new password once again. Confirm password must be the same as the New password. System will inform you "Change password successfully!" while they are the same, or inform you to input the password of Confirm password once again when they are not the same.



3.6 OSD Setting

1. Subtitle Display: Press \leftarrow \rightarrow keys to select between On and Off.

2. OSD Timeout: Press \leftarrow \rightarrow keys to select from 1 to 10 by step 1. The default values is 5.

3. OSD Transparency: Press \leftarrow \rightarrow keys to select among Off, 10%, 20%, 30%, 40%. The default option is Off.

Press **MENU** or **EXIT** key to save and exit.

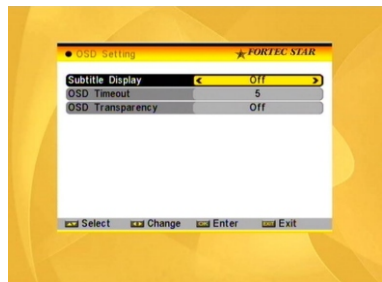

MENU INFORMATION

3.7 Favorite

There are 32 favorites group listed in this window. Press **PR+**, **PR-** keys to select one and press **OK** key to the **Rename** window. Since the same operation as the above the **Add Satellite** window, here we don't explain any more.

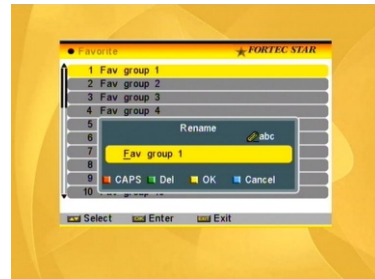
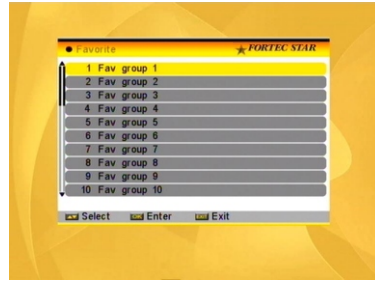

3.8 Other

1. **LNB Power:** Select between Off and On.
2. **Channel Play Type:** Select among All, Free, Scramble.
3. **Channel Change:** Select between Freeze and Black screen.
4. **Beeper:** Select between Off and On.

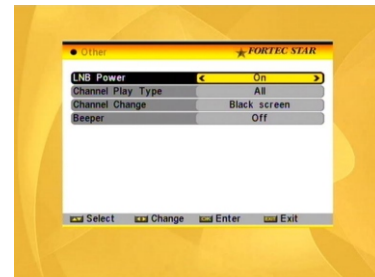

4. Tools

1. Press **OK** key or \triangleleft key to pop up the "Input Password" dialogue, you can not enter into the menu unless the correct password is inputted. The default password is **0000**.
2. Press **PR+**, **PR-** keys to move the cursor up or down.
3. Press **EXIT** key or \triangleleft key to move the focus to the left menu.

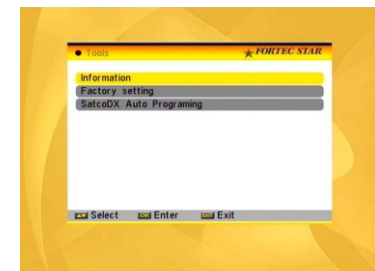

MENU INFORMATION

4.1 Information

Press **OK** key to the Information window.



4.2 Factory Setting

Press **OK** key to enter into the **Factory Setting** window.

Select Yes button and press **OK** key to return to the factory setting. All searched channels and set information will be erased.

Select No button and press **OK** key to cancel this operation, or press **MENU** or **EXIT** key to cancel and exit.

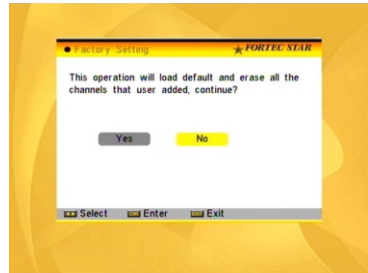

4.3 SatcoDX Auto Programing

Press **OK** key at the Start button to start receiving date from RS232 for 10seconds.



5. Game

1. Press **OK** key or \triangle key to enter into the game.

2. Press **PR+**, **PR-** keys to move the cursor up or down.

3. Press **EXIT** key or \square key to move the focus to the left menu.

4. Select the game that you want to play and press **OK** key to enter into the window.

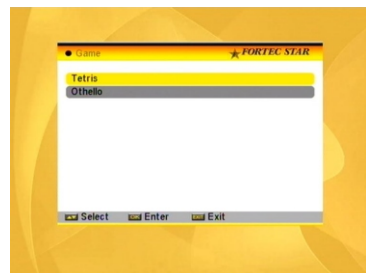

MENU INFORMATION

6. Hot Key

6.1 Info

Press **INFO** key to pop up the Infobar.

Press **INFO** key again to pop up the program guide of the current program. You can press \leftarrow \rightarrow keys to know the program guide of the future 16 days.



6.2 EPG

Press **EPG** key to enter into the EPG window.

1. Press **PR+**, **PR-**, \leftarrow \rightarrow keys to select up or down, left or right.

2. Press **red** colour key to pop up the Time Bar window. Press **PR+**, **PR-** keys to select up or down, while press \leftarrow \rightarrow keys to select left or right in the time bar.

\leftarrow : Press **OK** key at this button to return to the EPG window.

\rightarrow : Press **OK** key at this button to move the cursor to the current time line.

\leftarrow \rightarrow : Press **OK** key to push the time forward or backward by half an hour.

\leftarrow \rightarrow : Press **OK** key to push the time forward or backward by half an hour.

\leftarrow \rightarrow : Press **OK** key to push the time forward or backward by a day. From the current day, you can switch among the future 14 days in circle.

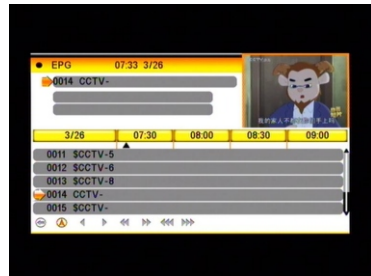

3. Detail Information: In the **EPG** window, press **PR+**, **PR-**, \leftarrow \rightarrow keys to select the channel and program, and press **OK** key to know the detail information of the current program.

4. Press **green** colour key to enter into the **Timer** window. You can add the current program to the Timer. If 8 timers is already, system will inform "Timer is full!".

MENU INFORMATION

6.3 Find

Press **A-Z** key on to pop up the **Find** window. User numeric keys to enter into the character and use the colour keys to realized the corresponding operation.

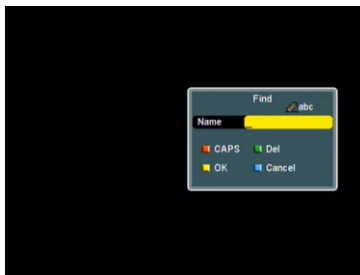

6.4 Number

Use the **numeric keys (0-9)** to input the number of the desired channel. If the inputted number is beyond the valid channel number, system will "No such a channel" and press **OK** key to close this message.

6.5 TV/RADIO

In normal mode, press **TV/RADIO** key to switch between TV mode and Radiomode.

6.6 Up/Down (Channel Change)

Press **PR+**, **PR-** keys to change the channel up or down. If in the all satellites group, you can select channel in all searched channels. If in the specific satellite, only can select channel in the satellite group.

6.7 Left/Right (Volume+/-)

Press \leftarrow \rightarrow keys to change the volume. Press \leftarrow keys to decrease the volume by step 1, while press \rightarrow keys to add the volume by step 1.

6.8 Mute

Press \boxtimes key to close the volume. You can press \boxtimes key once again to restore the volume, or press \leftarrow \rightarrow keys to open the volume.

6.9 Pause

During the viewing, you can press **PAUSE** key to stop the picture while the volume continues. You can play the picture by pressing **PAUSE** key once again.

6.10 OK

1. During the viewing or listening, press **OK** key to pop up the TV program list or the Radio program list.
2. Press **PR+**, **PR-** keys to select the channel up or down, and then press **OK** key to play this channel in full-screen.
3. Press \leftarrow \rightarrow keys to select the satellite.
4. Press **MENU** or **EXIT** key to close this window.



MENU INFORMATION

6.11 Audio

1. Press **⇐** **⇨** keys to enter into the Audio window.
2. Press **⇐** **⇨** keys to select among Left, Right, Stereo, and Mono.
3. Changing the audio mode is only connected with the current channel, not all the channels.
4. Press **MENU** or **EXIT** key to close this window.



6.12 Recall

Press **←PR** key to switch the current channel to the previous channel.

6.13 FAV

1. Press **FAV** key to pop up the favourite group window.
2. Press **⇐** **⇨** keys to select the favorite group. Press **PR+**, **PR-** keys to select the channel up or down.. Press **OK** key at the selected channel to view it in full-screen. Press **MENU** or **EXIT** key to exit.
3. If there is no favorite channel, system will inform " No FAV Channel!" when you press **FAV** key.



6.14 Teletext

Press **TXT** key to open the teletext on the screen. If there is no teletext, system will inform "No TeletextData". Press **EXIT** key to exit.

6.15 Zoom

1. Press **ZOOM** key to switch among Zoom*1, Zoom*2, Zoom*3, Zoom*4, Zoom*5, Zoom*6, Zoom*8, Zoom*12, Zoom*16.
2. In zoom mode, press **PR+**, **PR-** **⇐** **⇨** keys to move the cursor up, left, right, down.
3. Press **MENU** or **EXIT** key to exit

TROUBLE SHOOTING

Problem	Possible causes	What to do
The display on the front panel does not light up.	Main cable is not connected.	Check that the main cable is plugged into the power socket.
No sound or picture, but the front panel shows red light.	The receiver is in standby mode.	Press the standby button.
No sound or picture.	The satellite dish is not pointing at the satellite.	Adjust the dish. Check the signal level in the Antenna Setup menu.
	No signal or weak signal.	Check the cable connections, LNB and other equipment connected between the LNB and the receiver, or adjust the dish.
	The satellite dish is not pointing at the satellite.	Adjust the dish.
	Signal is too strong.	Connect a signal attenuator to the LNB input.
Bad picture / blocking error.	Satellite dish is too small.	Change to a larger dish.
	LNB noise factor too high.	Change to an LNB with lower noise factor.
	The LNB is faulty.	Change the LNB.
The picture is not showed on the screen, when switching on.	The system is connected by RF leads.	Check the UHF channel fixed in your system and tune the UHF channel properly.
There is interference on your digital satellite channels, an existing terrestrial channel or video signal.	The system is connected by RF leads and the output channel of the receiver interferes with an existing terrestrial channels or Video signal.	Change the receiver output channel to a more suitable channel, or connect the system by SCART leads.
The RCU is not working.	Battery exhausted.	Change the batteries.
	RCU is incorrectly aimed.	Aim RCU at the receiver, or check that nothing blocks the front panel.

● **Note** : If you have tried all of the actions suggested above, without solving the problem, please contact your dealer or service provider.

Free Manuals Download Website

<http://myh66.com>

<http://usermanuals.us>

<http://www.somanuals.com>

<http://www.4manuals.cc>

<http://www.manual-lib.com>

<http://www.404manual.com>

<http://www.luxmanual.com>

<http://aubethermostatmanual.com>

Golf course search by state

<http://golfingnear.com>

Email search by domain

<http://emailbydomain.com>

Auto manuals search

<http://auto.somanuals.com>

TV manuals search

<http://tv.somanuals.com>