

# USER MANUAL

(English)



**Lifetime Ultra**<sup>TM</sup>  
Digital Satellite Receiver

**PREFACE****1 OVERVIEW**

1. How to use the REMOTE CONTROL KEY
2. FRONT PANEL
3. REAR PANEL
4. CONNECTION DIAGRAM
5. CONNECTION DIAGRAM (DISH)

**2 OPERATION**

1. Start Up
2. Main Menu
3. User Setup
4. Installation
5. Channel Edit
6. System Setup
7. Channel List
8. Program Guide
9. Audio Change
10. Recall the Favorite Channel
11. How to download Software via RS-232 Serial Cable

**3 SPECIFICATIONS****4 TROUBLE SHOOTING****1. General Information**

Congratulations on purchasing a new Fortec Star digital satellite receiver. Before using your new receiver, we suggest that you read this manual carefully for your own safety, and to learn how to correctly operation the system.

**2. Main Features**

- EPG (Electronic Program Guide) - 7 days of program information
- Fully compliant with MPEG-2 Digital & DVB broadcasting
- 950~2150 MHz input Frequency (IF loop throughput)
- Variable input Symbol Rate (1.5~45 Msps)
- Multi-language OSD (On-screen Display)
- Automatic PAL/NTSC Conversion
- Fast Channel Change
- 3,000 Channel Memory (TV & Radio)
- Flexible reception of SCPC & MCPC from C/Ku band Satellites
- Timer Function (Automatic On/Off Setting Function)
- 256-Colors (Graphic Use Interface)
- P-I-G (Picture-in-Graphic) On-screen Display
- 5 Favorite Lists
- Powerful Channel Editing Function
  - Sorting: Alphabetic, Satellite, FTA/Scramble, Parental Lock, TP Order
  - Move, Delete, Edit Favorites
  - Parental Lock, Channel Rename, Channel Skip
- Manual PID / Satellite & TP / Network Scan & Power Scan
- Simultaneous Scan of 4 Satellites
- USALS Compatible
- Capable Of Setting the Frequency for SMATV Systems
- Upgrade through RS-232C (STB to STB, PC to STB)

Fortec Communications Inc.  
2780 Skymark Ave. Unit 8  
Mississauga, ON  
Canada L4W 5A7  
www.fortecstar.com

©2003 Fortec Communications Inc.

**3. FOR YOUR SAFETY**

- Do not open the cover. It may cause malfunction or electric shock.
- When not in use for a long period of time, please unplug the receiver from the power outlet.  
Also do not use a damaged power cord that may cause fire or electric shock.
- Do not use the receiver in a humid area.
- Do not cover the receiver or place anything heavy on the receiver. Ensure that the receiver has sufficient ventilation.  
Avoid using spray or liquid materials around the receiver.
- Do not connect or disconnect any cables while the receiver is plugged into the power outlet.

**4. THE FOLLOWING ACCESSORIES ARE ENCLOSED:**

- 1 User Manual
- 1 Remote Control Unit
- 2 Batteries (AAA Type)

**Note:**

If any of the accessories listed above are missing, please contact the sales outlet where this product was initially purchased.

**1. How to use the REMOTE CONTROL**

Key	Function
<b>POWER</b> ⏻	Turns the receiver on/off. In the standby mode, it will automatically changed to the TV Mode which enables watching terrestrial TV broadcasting.
🔇	Sound Off/On.
<b>INFO</b>	Shows channel information, such as channel number, channel name, Frequency, Polarity, Symbol Rate, Video PID, Audio PID and PCR PID.
<b>GUIDE</b>	Shows program information.
<b>TV/RADIO</b>	Toggles between the TV channels and radio channels.
<b>PAUSE</b>	Pauses the picture. Push again to release.
<b>SIGNAL</b>	Shows signal quality.
<b>AUDIO</b>	Selects audio mode (Stereo, left only and right only). Selects language in case of Multilingual program.
<b>MENU</b>	Enters main menu screen. Or exits menu screen.
<b>EXIT</b>	Moves to upper menu.
<b>CH ▲ ▼</b>	Channel up/down. Moves the cursor upward/downward in the menu screen.
<b>OK</b>	Shows channel list. Confirms selection in Menu mode.
<b>VOL ◀ ▶</b>	Volume down/up. Changes the value of a selected item in the Menu mode.
<b>LAST</b>	Returns to previous program.
<b>FAV</b>	Enters favorite program or Exits from Favorite program.
<b>0~9</b>	Changes channel directly. Controls the numerical operation in the Menu mode.
<b>PgDn</b>	Execute page down function in the menu.
<b>PgUp</b>	Execute page up function in the menu.
<b>SAT</b>	Shows the list of satellites.



## Operating Principle

- Select an item by using the up and down keys and change the value of the highlighted (selected) item by using keys shown on the screen. Press the OK key to enter the sub-menu if there is no instruction marked on the screen.
- The item is automatically stored and moved to the upper menu by pressing the "EXIT" key.
- You can return to the normal mode at the time by pressing the menu key from the menu mode.

## 2. FRONT PANEL

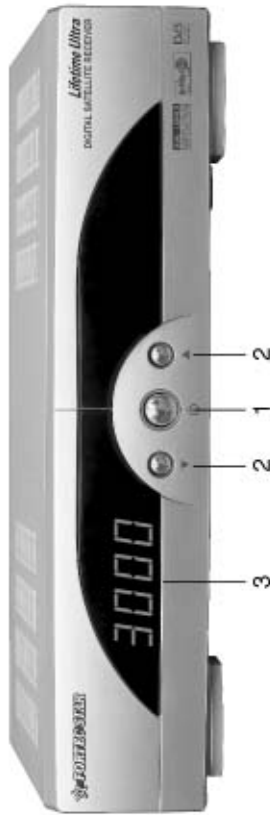

Figure 2-2 Front Panel

### 1. POWER

Switches between Stand-by mode and normal mode (On/Off).

### 2. CH ▲, CH ▼

Changes Channel Up/Down

### 3. CHANNEL DISPLAY (4 digit / 7 Segment)

After pressing the power button, "ON" is showed on screen .

After the receiver searches the program, the program number is displayed as "0001~3000".

### 3. REAR PANEL

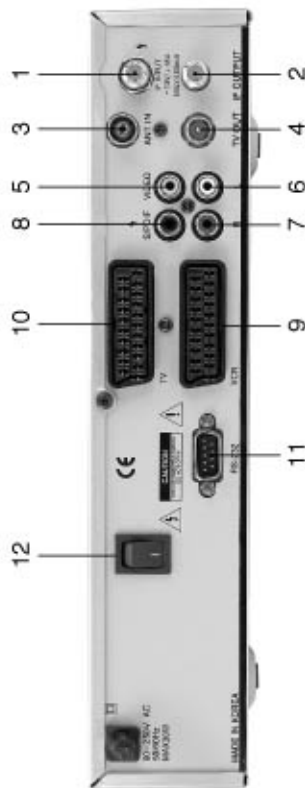

NO	NAME	FUNCTION
1	IF INPUT	IF INPUT from LNB to receiver
2	IF OUTPUT	IF Loop-through output to 2nd receiver
3	ANT IN	Input from terrestrial TV antenna or cable
4	TV OUT	Output to TV
5	VIDEO	Composite video output (RCA jack)
6	L	Left audio output (RCA jack)
7	R	Right audio output (RCA jack)
8	S/PDIF	Dolby Digital output (RCA jack) (Available on North American receivers.)
9	VCR SCART	VCR SCART output (not available on North American receivers; S-Video substituted)
10	TV SCART	TV SCART output (not available on North American receivers; S-Video substituted)
11	RS232	Serial port used for software upgrade
12	AC SWITCH	AC Power ON/OFF

### 4. CONNECTION DIAGRAM

- Receiver to TV with RF output and terrestrial antenna:  
Connect the TV antenna to the ANT IN socket of the receiver.  
Connect the TV out of the receiver to the RF INPUT of the TV set.  
Search on the TV set for UHF Channel 38 (for Europe), or channel VHF channel 3 or 4 for North America.  
Channel 38 is set at factory for UHF.  
If needed, you can change it in the User Set-up Menu mode.

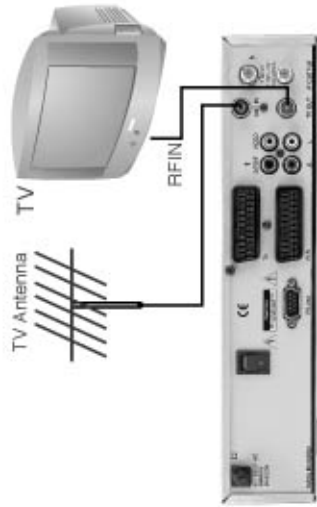

- Receiver to VCR and then to TV with RF output:  
Connect the TV antenna to the ANT IN socket of the receiver if a Terrestrial antenna is also needs to be connected.  
Connect the TV output Socket of the receiver to the RF IN of the VCR.  
Connect the RF output of the VCR to the RF IN of the TV set.  
Search on the VCR for UHF channel 38 (for Europe), or channel VHF channel 3 or 4 for North America.

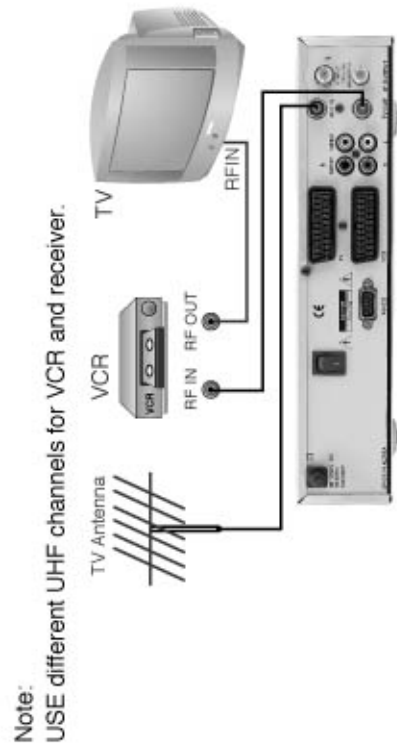

**Note:**  
USE different UHF channels for VCR and receiver.

3) Receiver to TV with Audio and Video cables:

Connect the TV antenna to the ANT IN socket of the receiver if a Terrestrial antenna also needs to be connected.

Connect the TV out socket of the receiver to the RF IN of the TV set. This connection is not necessary if the Video RCA connection is used in the next step.

Connect the Video and Audio outputs of the receiver to the Video and Audio inputs of the TV set.

(The Video RCA connection is recommended since it yields a better picture quality than using the RF IN of the TV set.)

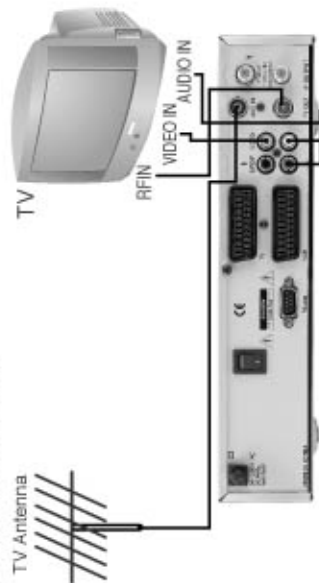

4) Receiver to TV and VCR with SCART cable: (Not available with North American models.)

Connect the TV antenna to the ANT In socket of the receiver.

Connect the TV out socket of the receiver to the RF IN of the VRC.

Connect the RF out of the VCR to the RF IN of the TV set.

Search on the VCR for UHF channel 38.

Connect the SCART cable from the TV SCART of the receiver to the SCART of the TV set.

Connect the SCART cable from the VCR SCART of the receiver to the SCART of the VCR.

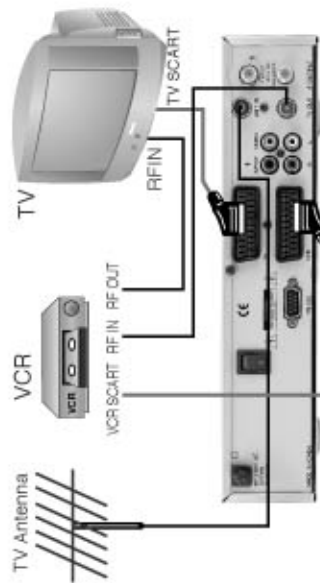

## 5. CONNECTION DIAGRAM (DISH)

1) One dish:



2) 2 dishes with 0/12V switch (0/12V jack not available on North American model):

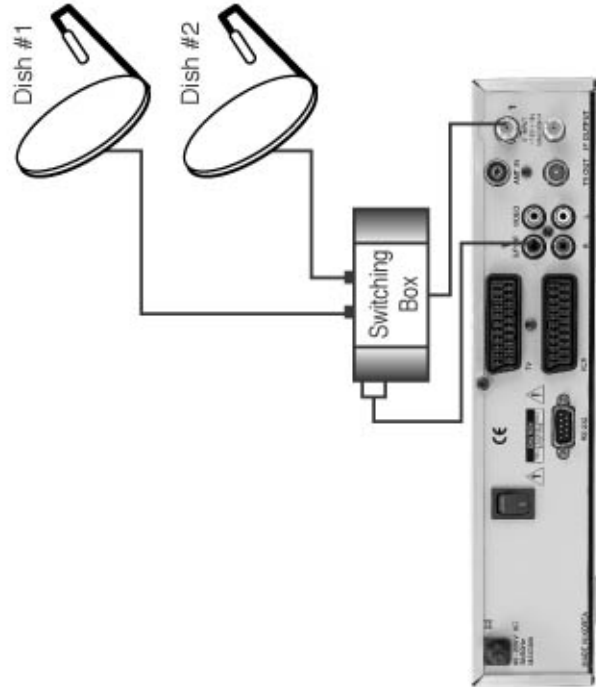

3) Two dishes using DiSeqC mode:

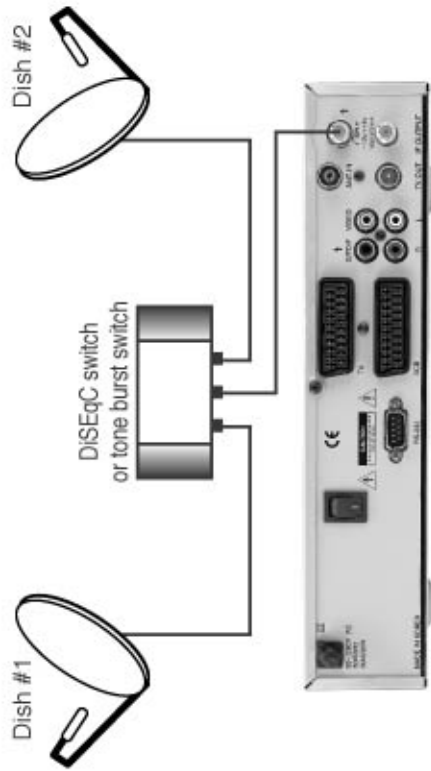

## 1. Start Up

If you are watching TV through the RF-cable, you need to adjust the Channel number. The type of TV and Channel number are set to PAL-G and Channel 38 (for Europe), or to NTSC and Channel 3 (for North America) at the factory.

### 1.1 Language

Select the desired language and press OK to confirm it.



This receiver supports 8 languages.

English,  
German,  
French,  
Portugal,  
Spanish,  
Turkish,  
Arabic  
Russian

## 2. MAIN MENU

Many of the functions of the receiver are available from the Main Menu. There are 4 sections in this Main menu, which are "User Setup", "Installation", "Channel EDIT" and "System Setup". The sub-menu will appear as you scroll between the 4 sections of the Main Menu.

### 3. User Setup

In the USER SETUP mode, you can select the sub-mode as shown in the right figure by pressing the CH ▲▼ key and then selecting the OK key. Any changes are stored by pressing the EXIT key.



#### 3.1 Language

Press EXIT or the OK key after you select your preferred language by using the VOL ◀▶ key.

Select from English, German, French, Portugal, Spanish, Turkish, Arabic & Russian.

#### 3.2 Aspect ratio

You can set TV aspect ratio (4:3 for normal TV & 16:9 for wide-screen TV) by pressing the VOL ◀▶ keys.

#### 3.3 TV Type

You can set the TV type (PAL, NTSC and AUTO) by pressing the VOL ◀▶ keys.

If the setting value is Auto, then the source program sets the TV type automatically.

#### 3.4 Time Setting

After selecting the Time Setting, you can adjust the time. Also you can set the Wakeup time and Sleep time to turn the receiver on and off automatically.



### 3.5 Modulator

You may need to change the modulator setting to support your program source:

- 1) PAL-G, PAL-I, PAL-K, NTSC is supported.
- 2) Modulator channel can be changed from channel 21 to channel 69 for PAL, and from 3 to 4 for NTSC.



### 3.6 OSD setting

You can adjust the transparency level by using the Vol ◀▶ keys.

#### 3.6.1 OSD Timeout

When you change the channel, the channel information will be displayed on the On-screen Display (OSD) for a certain period of time. You can change the amount of time the information will be displayed on the OSD by selecting a different value in this menu.

After changing the OSD time, press the Exit key.

### 3.7 Screen option

Select ON or Off with ◀▶ Key

- ON : After being Black screen, channel is changed. When changing channel, desired channel will display after showing black screen.
- OFF : When changing channel, previous channel is seen and desired channel will display .



#### 4. Installation

In this section, you will learn how to use the Antenna Set-up, Scan, and Edit Channel and TP data.



#### 4.1 Antenna Setup

##### 4.1.1 Satellite

- Scroll to the satellite you want to program by using the ▲▼keys.
- Select the satellite you want by pressing ◀▶key. A check mark will appear next to the satellite to show that it is selected. You can de-select it again by pressing ◀▶key once more. If you press OK, the satellite will be selected and that satellite's sub-menu will appear.
- From the satellite's sub-menu, you can adjust the LNB type, LNB Lo-Freq., 22KHz, DiSEqC, LNB power, 0/12V, TP, and Positioner Setting.

##### 4.1.2 LNB type

- Select proper LNB type using ◀▶keys according to the LNB type you are using. The default settings are the Fortec Star Universal LNB (Universal 1). All settings for the LNB type are shown below:
  - Universal 1 (9750MHz & 10600 MHz)
  - Universal 2 (9750MHz & 10750 MHz)
  - Single-SL (5150MHz & 5750 MHz)
  - Single SH ( 5150MHz & 5750 MHz)
  - Standard (9750MHz; the value can be manually changed)
- 22KHz control is automatically set for each LNB alternative. If Universal 1 or 2 is selected, 22KHz control should be in the "off state".

##### 4.1.3 LNB Lo-Freq

When the required LNB frequency is not available, select "Standard" and then input the frequency value with the numeric keys.

##### 4.1.4 22KHz

When you are using a Dual LNB or two antennas connected to a 22KHz tone switch box, set 22KHz tone switch "ON" for one dish and set 22KHz tone switch to the "OFF" mode for the other dish.

##### 4.1.5 DiSEqC

- Full DiSEqC

If a DiSEqC switch is used, select the port number that corresponds to the output of the DiSEqC switch.

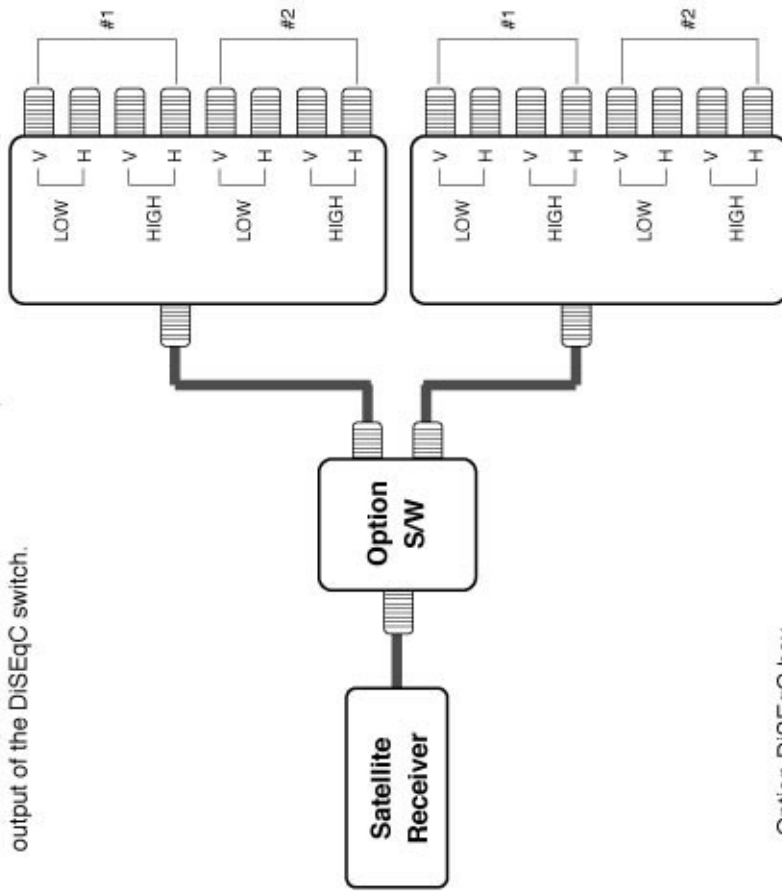

- Option DiSEqC box

If the option switch is used according to figure below, there are two different ways to scan the satellites depending on LNB type.

- (1) For universal LNB:

Select a DiSEqC number to which the RF signal is fed the LNB.

- (2) For standard LNB:

For low band scanning, "set 22kHz" to off and select a DiSEqC number.

For high band scanning, "set 22kHz" to off and select a different DiSEqC number.

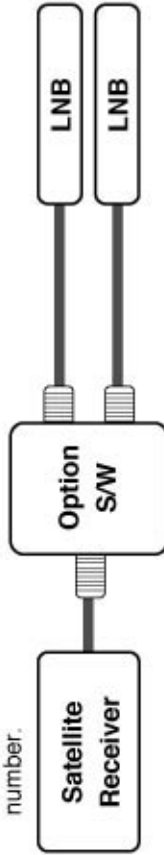

#### 4.1.6 LNB POWER

Set the LNB power On/Off by using ◀▶ keys.

#### 4.1.7 0/12V (Not available on the North American model)

By turning this function On or Off, the receiver will either supply or not supply 12V from this terminal using ◀▶ keys.

#### 4.1.8 TP

Select a specific transponder by using the VOL ◀▶ keys. When the dish is positioned properly to receive the satellite signal, the Quality bar meter will indicate a signal in a green color.

#### 4.1.9 Positioner Setting

It is used to set the DiSEqC 1.2 motor & USALS. If you have no positioner equipment, leave this setting in the Disable state. Otherwise, you can select either DiSEqC 1.2 or USALS.

##### 1) DiSEqC 1.2

(1) Current position:

Select the position number by using ◀▶ keys (#0~#26 are defined default values, #27~#49 are user defined values).

(2) Movement:

Select East /West by using ◀▶ keys and press OK to stop.

(3) Nudge East/ West:

Select Nudge East/West by using ◀▶ keys and press OK to save current position.

(4) Recalculation:

If it is used to shift the position for all the satellites, select Recalculation by using the OK key and then use the movement function above.

(5) East Limit Set:

Move the position to the most eastern position and press OK to store it.

(6) West Limit Set:

Move the position to the most western position and press OK to store it.

(7) Limits Disable:

Select Disable limits by using the OK key.

(8) Go-to reference:

Select Go-to reference by using OK key.

##### 2) USALS (DiSEqC 1.3)

(1) Satellite Position:

It indicates the position for the saved satellite. You can change the position of the satellite by using the numeric keys.

(2) My Longitude:

Input Local Longitude by using the numeric keys.

(3) My latitude:

Input Local Latitude by using the numeric keys.

(4) Reference position:

Moves the dish to the zero position.

(5) Move:

The satellite position shown in (1)

above and the position calculated by the values of (2) & (3) will be shown.

Press OK key and it will move to the satellite position.

(6) Store:

Select "Store" and the values will be saved, and the dish will move to the satellite position.



**Note:** When scrolling through the satellite list in the Antenna Setup menu, the dish will start to move when you highlight a satellite that has the Positioner Setting set to DiSEqC 1.2 or USALS (assuming that a DiSEqC 1.2 or USALS motor is connected to your dish). You can avoid this by returning the Positioner Setting to the Disable state.

#### 4.1.10 Satellite Scan Mode

Select the satellite scan mode Free or ALL. The Free mode is used to download only Free channels to the receiver. The ALL mode is used to download Free and Scrambled channels. If you select OK while the Satellite Scan mode is highlighted, you will be asked to press OK to save or Exit to escape this menu. If you press OK to save, the channel search will begin. Remember to move the dish to the desired satellite if using a motor before you begin a channel search.

#### 4.2 Satellite Scan (From Installation Menu)

Scan all transponders for selected satellites.

1) Press OK key and scroll through the satellite list by using the ▲&▼ keys. Select the satellite to search by using the ◀▶ keys. Only four satellites can be selected at once.

2) Then press the OK key to begin the scanning.

3) The transponders (TP) will be consecutively scanned for each of the selected satellites.



### 4.3 TP Scan

The selected transponders are scanned in this menu.

- 1) Select TP scan in the installation menu.
- 2) Select a satellite by using the ◀▶ keys.
- 3) Select the scan mode FTA or ALL.
- 4) Scroll through the TP list by using the ▲▼ key, and select the desired TPs by using the ◀▶ keys, then press OK to start the search.

### 4.4 Network Scan

Follow the same procedure for as used in the TP Scan section above.

It is advantageous to use the Network Scan since it will scan for updated information provided by the satellite's Network Index Table.



### 4.5 Advanced Scan

To perform an Advanced Scan, press Ok. Then select the Scan mode FTA or ALL. Select the satellite. You can perform the Advanced Scan by entering the parameters you wish to search. Select the parameters by using the ◀▶ keys, or by using the value using the numeric keys. Press OK to begin the search.

#### 4.5.1 Down Frequency

Input the frequency that you want to search.

#### 4.5.2 Symbol Rate

Input proper key value.

#### 4.5.3 Polarity

Select Horizontal or Vertical by using ◀▶ keys.

#### 4.5.4 Channel Name

Press OK key and key Board will be shown. You can edit channel name.

#### 4.5.5 Video/Audio/PCR PID

Setting Video PID/Audio PID/PCR PID

- You can set the PID values to search.
- After setting the PID values, press OK key.

### 4.6 Power Scan



#### 4.6.1 Satellite

- 1) Select satellite name with ◀▶ key
- 2) If you want to add a new satellite, press the OK Key.

#### 4.6.2 LNB Configuration



#### 4.6.3 Symbol range

- Select Full, High, or Low
- Full : High and Low
- High : >7.5M
- Low : <7.5M

#### 4.6.4 Polarity

- Select Horizontal / Vertical with ◀▶ Key.
- All : Scan Horizontal and Vertical.
- Horizontal / Scan Horizontal TP only.
- Vertical : Scan Vertical TP only.

#### 4.6.5 Scan

- Select Scan type with ◀▶ Key
- When you select the OK Key, the scanning will start.

#### 4.7 Edit TP/Satellite

In this mode, you can add new, edit or delete satellite and transponder information.

##### 4.7.1 How to add a new satellite

- Select "New". It is located at the bottom of satellite name list. Enter the new satellite name by using the numeric keys, ▲▼ keys, or ◀▶ keys.
- Maximum number of characters is 12 digits.
- Press the OK key to select each character.
- Store the new name by selecting the OK character located on the last row.
- Enter the Down frequency, symbol Rate and LNB Polarity.
- Press EXIT or OK key and the new transponder information is stored.

##### 4.7.2 How to rename the satellite

- Press OK after selecting a satellite.
- Select "Rename" from the menu.
- Enter new name by using numeric keys, ▲▼ keys & ◀▶ keys and then select OK.

##### 4.7.3 How to Delete/Restore a satellite

- Press OK key after selecting the satellite you want to delete.
- Press OK to confirm or press EXIT to cancel. The color of the deleted satellite name in the list will change.
- Satellites that are marked with a check mark cannot be deleted.
- To restore the deleted satellite, move the cursor to the deleted satellite and press OK key. Then select "Restore" in the menu and press the OK key.

##### 4.7.4 How to add a new transponder

- Press OK after selecting a satellite.
- Select Edit TP and then the Transponder list will appear.
- Press the OK key after selecting "NEW" from the transponder list.
- Enter the Down frequency, Symbol Rate and LNB Polarity.
- Press EXIT or OK and the new transponder information will be stored.

##### 4.7.5 How to delete or edit a transponder

- Press OK key after selecting a satellite.
- Select Edit TP, then the transponder list will appear.
- Scroll through the list of transponders.
- Press OK to select the TP you want to Edit or Delete.
- The Edit or Delete menu will appear.
- When you want to Edit the TP, select the EDIT menu and press OK key.
- Enter Down frequency, LNB polarity & Symbol Rate and press EXIT or OK.
- When you want to Delete a TP, select Delete from the menu and press OK key. The TP selected will be deleted.

## 5. Channel Edit

In this mode, you can edit both TV and Radio channels.

### 5.1 How to sort the channels

- 1) Press OK after selecting "Sort".
- 2) The Sub-mode will appear as follows:
  - Alphabetic
  - Satellite
  - FTA/Scramble
  - P-Lock
  - TP Order
- 3) Select one of 5 kinds of sort modes and press OK.
- 4) Press EXIT to exit from this mode.



#### Note:

- P-Lock: The channels with a P-Lock will appear first.
- TP Order: TP value will be shown from low to high.

### 5.2 How to move the channel

- 1) Press OK after selecting the "Move" key.
- 2) Press OK to select a channel to move, and then move the selected channel to the new position by using the ▲▼ keys.
- 3) Press the OK key again.

### 5.3 How to delete the channel

- 1) Select "Delete" and press OK.
- 2) Select a channel you want to delete by using the ◀▶ key. More than one channel can be selected.
- 3) Press the OK key after selecting all the channels to be deleted.

### 5.4 How to store channels in a Favorite List

- 1) Select "Favorite" and press OK.
- 2) Select the desired Favorite List (1-5), and press OK.
- 3) Select the channel to be added to the Favorite List and press OK.
- 4) Once all the desired channels are selected, press EXIT.

5) This process can be repeated for the other Favorite Lists.

6) To delete a channel from the Favorite List, go to the marked channel and press "OK".

### 5.5 How to lock/unlock the channel

- 1) Select P-LOCK from the menu and press OK.
- 2) Select the channel that you want to lock and press OK.
- 3) This channel is now locked and the lock symbol appears beside it.
- 4) You can unlock the locked channel if you press OK after selecting the locked channel.
- 5) When a locked channel is selected while watching television, a password is requested to view the channel.

### 5.7 How to rename the channel

- 1) Press OK after selecting the RENAME menu.
- 2) Select the channel you wish to rename.
- 3) Press OK to enter the characters for the name.
- 4) The maximum number of characters is 20.
- 5) Press the OK character on the last row to store the new name.



6. Systems Setup

6.1 Parental Control

The factory set default Password is "0-0-0-0".

6.1.1 Change PIN Code

You can change the PIN Code (Password), if you want to.

- 1) Enter the Old password. If you enter this mode for the first time after purchasing the receiver, the OLD PIN Code is the default password.
- 2) Enter the new password.
- 3) Re-enter the new password to confirm.



**Warning!** You must remember the exchange password because it is used for several functions. The Password is required:

- To view parental locked channels.
- To reset the receiver to the factory settings.

6.1.2 Menu Lock

Select ON or Off with ◀▶ Key

- ON : When entering menu, input Password.
- OFF : When entering menu, no need to input Password.

6.2 SW Transfer From Receiver to Receiver

- 1) Connect the Master receiver to the Slave receiver using a RS-232 Female-to female Nul modem Cable. Pin configuration is shown below.

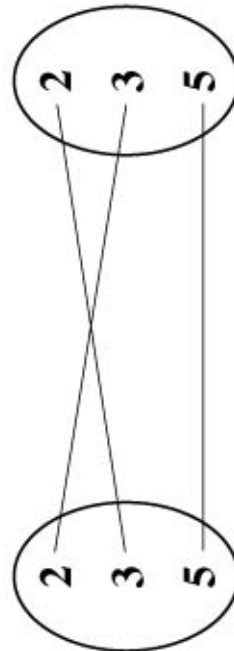

- 2) Select the s/w transfer mode using ◀▶ keys.

- 3) In the Code Mode, you are transferring the "main" s/w" from the STB (Master) receiver to the STB (Slave) receiver. To start the transfer, you must press the "Channel Up" key on the Front panel of STB (Master), not STB (Slave).

- 4) In the Data Mode, you are transferring the "main" s/w" from the STB (Master) receiver to the STB (Slave) receiver. To start the transfer, you must press the "Channel Up" key on the Front panel of STB (Master).
- 5) Press the EXIT key to cancel the transfer. After transferring the Code file, you should turn Off, then On the STB (Slave) receiver.



**Caution!** Never turn off the receiver during software transferring. Failure to follow this procedure correctly will void your warranty.

6.3 Factory Setting

Once the Factory setting is selected, you will be prompted to enter the correct password. After you enter the correct password, press OK, the receiver will restore all the factory settings.

If you do not want to continue this operation, press the EXIT key before you enter the password.



6.4 System Information

This mode shows the following information: model name, date and version of S/W.

## 7. View the Channel List While Watching TV

- You can see the channel list as shown in the figure to the right by pressing the OK key.
- You can view the channels alphabetically by pressing the PAUSE key.
- Use the ▲▼ keys to scroll to the next channel, or use ◀▶ keys to jump to the channels that begin with the next letter in the alphabet.
- Press OK key to view the channel.
- With the Channel List showing, you can press the FAV key. Then you can select the list to be viewed (All channels, or Fav list 1 through Fav List 5).
- With the Channel List showing, you can press the TV/RADIO key. This changes the list from TV channel list to the Radio channel list. You can exit from the channel list menu by pressing the EXIT key.



## 8. Program Guide

- Press the GUIDE key.
- The title and start time of the program is shown as displayed in the figure to the right.
- You can select the particular channel you want using the ▲▼ keys.
- Press EXIT to view that channel.



## 9. Audio change

- For multilingual programs, a different language can be selected by pressing the AUDIO key and then select the language using the ▲▼ keys.
- The audio mode (L-left, R-right, L/R-stereo) is also changed by pressing the AUDIO key. Scroll to the different modes by using the ◀▶ keys.



## 10. Display the Favorite Channel List

- Press the FAV key to display the Channel lists.
- A Favorite Channel List is programmed and stored using the channel edit menu.

## 11. How to Download Software via RS-232 Serial Cable

- 1) Connect between Receiver and PC by RS-232 Female-to Female Straight-through Modem Cable. The PIN configuration is shown below.

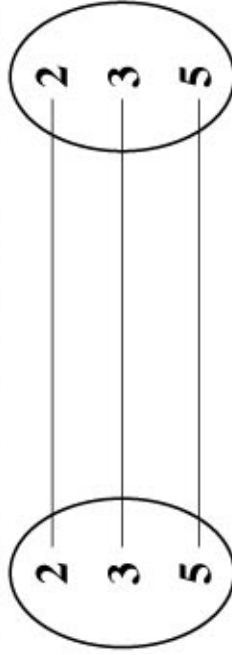

- 2) Please go to the Fortec Star Web site to get the Uploader software and the software available for this receiver. The Uploader program is illustrated below.

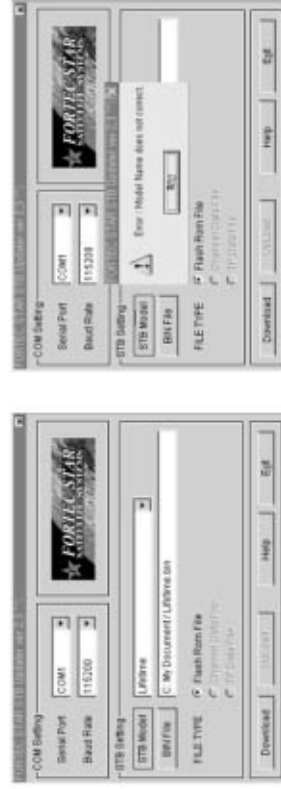

- 3) The software for the receiver (BIN file) must match the STB Model. For this receiver, enter the STB model as Lifetime. Then select the bin file for the Lifetime receiver that is appropriate for your region of the world, i.e., the PAL file for Europe and the Middle East and the NTSC file for North America.

The following message will appear when the STB Model and Bin file don't match.

**Tuner/LNB**

Input Connector F-type, IEC 169-24  
 IF Input Frequency 950MHz to 2150MHz  
 IF Loop Throughout 950MHz to 2150MHz  
 IF Frequency Zero-IF  
 Input Level -65dBm~-25Bm  
 LNB Power 13/18V DC  
 500mA Max  
 DiSEqC Control Version 1.3 Compatible  
 Band Switching 22Hz Tone  
 Demodulation QPSK  
 System Rate 2~45 Mbps (SCPC, MCPC)  
 Viterbi Decoding Rate 1/2, 2/3, 3/4, 5/6, 7/8  
 Reed Solomon Decoding FEC: 204, 188, 1=8  
 DiSEqC 1.3 Compatible (USALS)

**Mpeg transport Stream & AV Decoding**

Demultiplex According to ISO/IEC  
 13818-1  
 Input Stream Max. 90Mbits/s  
 Aspect Ratio 4:3, 16:9  
 Video Resolution 720 x 576  
 Audio Decoding MPEG layer I and II  
 Audio Mode Single/Dual Channel, Stereo, Joint Stereo  
 Sampling Frequency 16/22,05/24/32/44,1 48Khz

**Microprocessor & Memories**

Main Processor Slti 5518ST20 32bit  
 CPU Clock 81 MHz  
 Flash Memory 1 Mbyte  
 SDRAM 8 Mbyte  
 EEPROM 32 kbits

**Data Port**

Connector 9 Pin D-Sub Type  
 Protocol RS232 Asynchronous  
 Data Rate Max. 19,2kpbs

**RF Modulator**

Connector IEC 169-2 Male/Female  
 Frequency 470 MHz to 860 MHz  
 Output Channel CH 21-69 or Ch 3-4  
 TV Standard PAL DK/JG/IM, NTSC  
 Preset Channel Ch 3, or CH38, Changeable by Menu Screen

**Front Panel**

4 Digits LED Display  
 Channel Number Display  
 3 Keys Power, Channel Down and Channel Up

**Rear Panel**

IF Input F-type Connector  
 IF Loop-through output F-type Connector  
 TV SCART (if avail.) CVBS, Audio L/R  
 VCR SCART (if avail.) CVBS, Audio L/R  
 4 Phone (RCA) Video, Audio L, Audio R, 0/12V or S/PDIF

**Remote Control**

Type Infra-red  
 Battery (Carrier Freq: 38 KHz) 2 x 1.5V AAA Type

**Others**

Inputs Voltage AC90-250, 50/60Hz  
 Power Consumption Max. 25 Watts  
 Standby Power Less than 5 Watts  
 Dimension 290 x 200 x 65 mm  
 2,3 kg

Problem	Possible causes	Remedy
<b>LED on front panel does not light up</b>	AC power cord disconnected	Connect power cord properly into the power socket
<b>No picture or sound</b>	Wrong connection of the video/audio output to TV input terminal	Connect two terminals correctly with SCART cable or RCA or RF cable.
	Wrong connection of satellite antenna cable	Connect the antenna cable correctly
	Wrong direction of satellite antenna	Adjust the direction of antenna
	No signal or weak signal	Check the cable connections, LNB and other equipment connected between the LNB and the receiver or adjust the antenna
<b>Black and white screen or V-hold</b>	Wrong setting of channel information in MENU screen	Type the setting value correctly
	Your TV mode is different from the satellite broadcasting mode	Change the TV setting mode Use the NTSC/PAL converter connected to the receiver and TV
<b>The remote controller is not working</b>	Battery exhausted	Change the batteries
	Florescent light interfering with the remote controller	Switch off the light
	Remote controller is incorrectly aimed	Aim the remote control at the receiver
<b>Distorted menu screen</b>	Too high brightness and contrast level of TV set	Adjust brightness and contrast to low level
<b>Not working</b>	Process Down	Remove the power code or AC switch OFF/ON

**Caution!** Never turn off the receiver during software downloading. Any interruption while downloading will damage the flash ROM, and will void the warranty.



## Free Manuals Download Website

<http://myh66.com>

<http://usermanuals.us>

<http://www.somanuals.com>

<http://www.4manuals.cc>

<http://www.manual-lib.com>

<http://www.404manual.com>

<http://www.luxmanual.com>

<http://aubethermostatmanual.com>

Golf course search by state

<http://golfingnear.com>

Email search by domain

<http://emailbydomain.com>

Auto manuals search

<http://auto.somanuals.com>

TV manuals search

<http://tv.somanuals.com>