

Mini Mixer

Model MN04 Owner's Manual

FOSTEX®

Thank you for purchasing the Fostex Model MN04.

The model MN04 is a four input two output mini mixer small in size and light in weight.

Channel 1 is an input for line/mic level (switchable type) and channels 2~4 are inputs for line level signals.

Channel 1, in particular, has, in addition to the regular mic level position, an ALC (Automatic Level Control) circuit position which minimizes distortion against input overload when using a microphone.

The MN04 can be conveniently used in any location as it employs a two power supply system (AC adaptor [Included]/S-006P battery [Option]). Please read through this manual before operation.



CAUTION

RISK OF ELECTRIC SHOCK
DO NOT OPEN



CAUTION: TO REDUCE THE RISK OF ELECTRIC SHOCK,
DO NOT REMOVE COVER (OR BACK).

NO USER - SERVICEABLE PARTS INSIDE.

REFER SERVICING TO QUALIFIED SERVICE PERSONNEL.

CAUTION:

TO PREVENT ELECTRIC SHOCK, MATCH WIDE BLADE OF PLUG TO WIDE SLOT, FULLY INSERT.

ATTENTION:

POUR ÉVITER LES CHOCS ÉLECTRIQUES, INTRODUIRE LA LAME LA PLUS LARGE DE LA FICHE DANS LA BORNE CORRESPONDANTE DE LA PRISE ET POUSSER JUSQU' AU FOND.



The lightning flash with arrowhead symbol, within an equilateral triangle, is intended to alert the user to the presence of uninsulated "dangerous voltage" within the product's enclosure that may be of sufficient magnitude to constitute a risk of electric shock to persons.



The exclamation point within an equilateral triangle is intended to alert the user to the presence of important operating and maintenance (servicing) instructions in the literature accompanying the appliance.

"WARNING"

"TO REDUCE THE RISK OF FIRE OR ELECTRIC SHOCK,
DO NOT EXPOSE THIS APPLIANCE TO RAIN OR MOISTURE."

SAFETY INSTRUCTIONS

1. Read Instructions - All the safety and operating instructions should be read before the appliance is operated.
2. Retain Instructions - The safety and operating instructions should be retained for future reference.
3. Heed Warnings - All warnings on the appliance and in the operating instructions should be adhered to.
4. Follow Instructions - All operating and use instructions should be followed.
5. Water and Moisture - The appliance should not be used near water - for example, near a bathtub, washbowl, kitchen sink, laundry tub, in a wet basement, or near a swimming pool, and the like.
6. Carts and Stands - The appliance should be used only with a cart or stand that is recommended by the manufacturer.
7. Wall or Ceiling Mounting - The appliance should be mounted to a wall or ceiling only as recommended by the manufacturer.
8. Ventilation - The appliance should be situated so that its location or position does not interfere with its proper ventilation. For example, the appliance should not be situated on a bed, sofa, rug, or similar surface that may block the ventilation openings; or, placed in a built-in installation, such as a bookcase or cabinet that may impede the flow of air through the ventilation openings.
9. Heat - The appliance should be situated away from heat sources such as radiators, heat registers, stoves, or other appliances (including amplifiers) that produce heat.
10. Power Sources - The appliance should be connected to a power supply only of the type described in the operating instructions or as marked on the appliance.
11. Grounding or Polarization - The precautions that should be taken so that the grounding or polarization means of an appliance is not defeated.
12. Power Cord Protection - Power supply cords should be routed so that they are not likely to be walked on or pinched by items placed upon or against them, paying particular attention to cords at plugs, convenience receptacles, and the point where they exit from the appliance.
13. Cleaning - The appliance should be cleaned only as recommended by the manufacturer.
14. Nonuse Periods - The power cord of the appliance should be unplugged from the outlet when left unused for a long period of time.
15. Object and Liquid Entry - Care should be taken so that objects do not fall and liquids are not spilled into the enclosure through openings.
16. Damage Requiring Service - The appliance should be serviced by qualified service personnel when:
 - A. The power supply cord or the plug has been damaged; or
 - B. Objects have fallen, or liquid has been spilled into the appliance; or
 - C. The appliance has been exposed to rain; or
 - D. The appliance does not appear to operate normally or exhibits a marked change in performance; or
 - E. The appliance has been dropped, or the enclosure damaged.
17. Servicing - The user should not attempt to service the appliance beyond that described in the operating instructions. All other servicing should be referred to qualified service personnel.



An appliance and cart combination should be moved with care. Quick stops, excessive force, and uneven surfaces may cause the appliance and cart combination to overturn.

IMPORTANT NOTES IN OPERATION

1. Avoid using headphones for long hours at high volume levels.

Doing so can result in hearing failure. Any sudden increase in headphone sound levels must also be avoided. This could result in damage to your hearing.

2. Turn down all sound volume controls when switching on power to this mixer.

Also, turn all volume controls when switching on/off power to the MN04. Otherwise, a sudden loud noise could have a bad affect on you ears and your hearing.

3. Turn down the sound volume control when plugging or unplugging the headphone into the PHONES jack.

Always turn down the sound volume control when connecting or removing the headphone plug from the PHONES jack. Doing so with the volume control turned up, could result in hurting your ears.

4. Switch off power to the mixer when interconnecting it to external equipment.

Always be sure to switch off the MN04 power when interconnecting external equipment to the MN04.

5. Properly dispose of exhausted battery removed from the mixer.

Do not throw old battery removed from MN04 into a fire. This is very dangerous as they could explode.

6. Use an AC adaptor specified by Fostex.

Be sure to use the AC adaptor specified by Fostex. The power cord connector polarity could be wrong depending on the manufacturer.

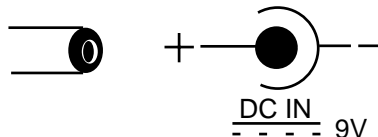

The schematic indicates that the outer sheath is minus polarity and the inner pole plus polarity, and the power supply is DC 9V.

NAMES AND FUNCTIONS OF THE CONTROLS

Battery compartment

The commonly sold battery is installed here (Refer to next page). A standard battery is not to be used for long periods of time.

DC IN jack

The AC adaptor included with the MN04 is connected here (Refer to next page).

Power switch

Switches ON-OFF (STANDBY) power to this mixer.

<NOTE>

As a small current will be flowing even though the mixer power is switched off, it is recommended to unplug the AC adaptor from the wall outlet if the MN04 is not to be used for long hours or extensive periods of time.

STEREO OUT jacks

These jacks are connected to the input jacks of amplifier contained speakers, multitrack recorders, mixers, etc. (Refer to next page).

Level selector switch

Input level is selected in accordance to the sound source connected to Input Jack 1.

LINE (-10dBV):

This position is selected when a line level sound source is connected.

MIC (-60dBV):

This position is selected when a microphone is used.

MIC (ALC ON; -50~-20dBV)

This is also the position when using a microphone. When this position is selected, the ALC circuit becomes active and the input level is automatically adjusted within a -50dBV~-20dBV range (The LED will light in green when switched to this position and change to red when the ALC circuit is in operation).

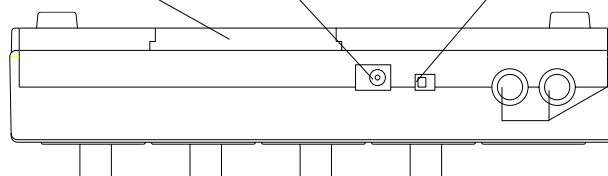

Power LED

This is lit when the power supply is switched on.

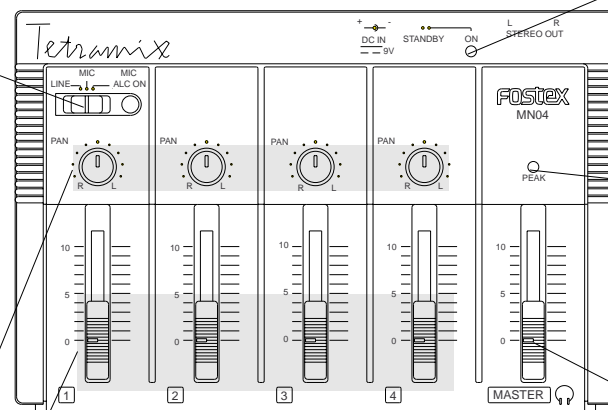

Peak LED

This LED will be lit when the output signal adjusted by the master fader overloads. Set the master fader so that the LED dose not light too frequently.

Pan pot knob

Adjusts the sound position when signals input to each input jack is output to the STEREO OUT jacks.

Input fader

Adjusts input level of the sound source signal applied to input jacks 1~4.

Input jacks 1 ~ 4

External sound sources such as mic, keyboard, guitar, etc. are plugged here. As a level selector for mic/line is provided in channel 1, this should be used when connecting a microphone. Line level output signals only should be connected to channels 2~4 as these jacks are designed for line output sound sources.

Master fader

Final level of the mixed signal output to the STEREO OUT jacks are adjusted with this fader. The headphone sound level is also adjusted by this fader.

PHONES jack

Monitor headphone is plugged in here.

CONNECTING THE AC ADAPTOR/INSTALLING THE BATTERY

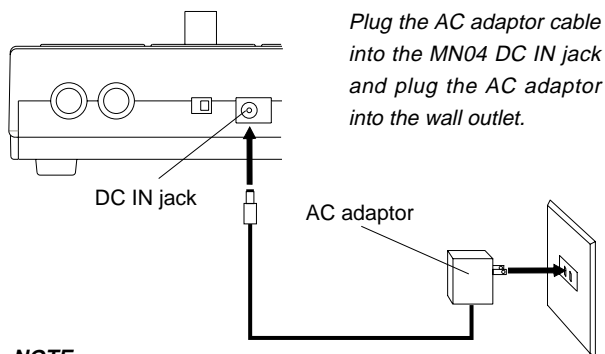

Plug the AC adaptor cable into the MN04 DC IN jack and plug the AC adaptor into the wall outlet.

<NOTE>

Unplug the AC adaptor from the wall outlet if the MN04 is not to be used for long hours or extensive periods of time.

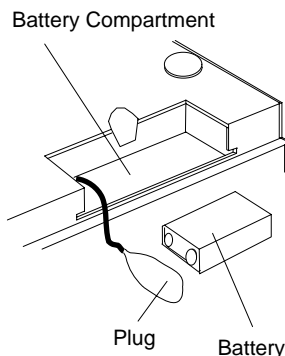

Open the mixer bottom battery compartment lid by hand, correctly connect the plug to the battery, and place battery in compartment and replace lid as before.

<NOTE>

Be sure to remove the battery if it is not to be used for long hours or extensive periods of time. If not, it could result in leaking electrolyte from the battery which can ruin your new mixer.

INTERCONNECTING EXAMPLE WITH EXTERNAL EQUIPMENT

As shown in example below, by interconnecting MN04 as a sub mixer with a multitracker having few input ports, a multitude of sound sources can then be mixed and recorded by the multitracker.

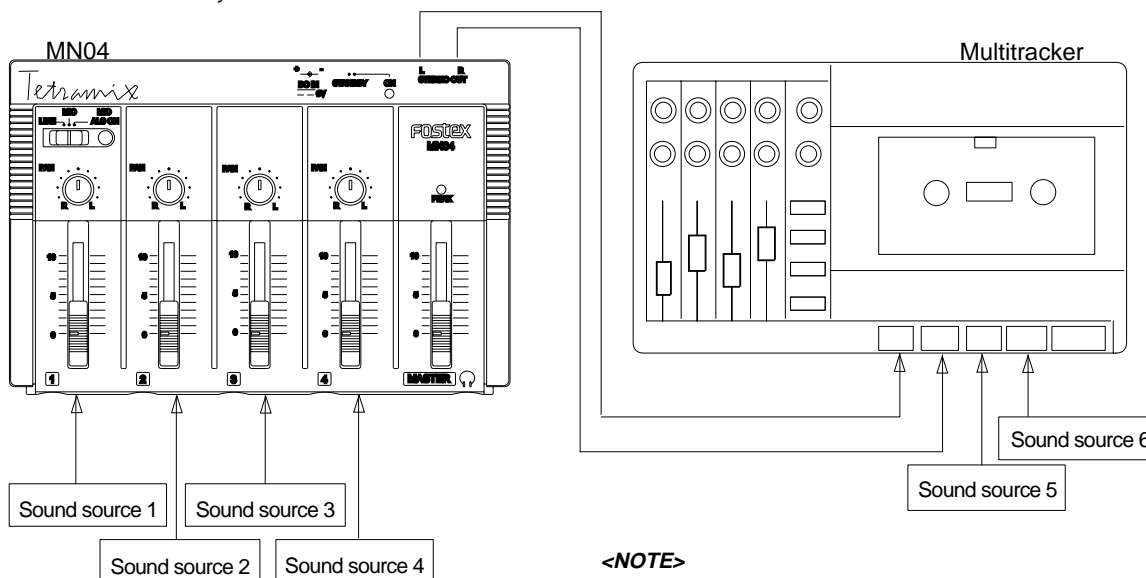

<NOTE>

Plug a microphone into channel 1.
Channels 2~4 are exclusively line level inputs.

BLOCK DIAGRAM

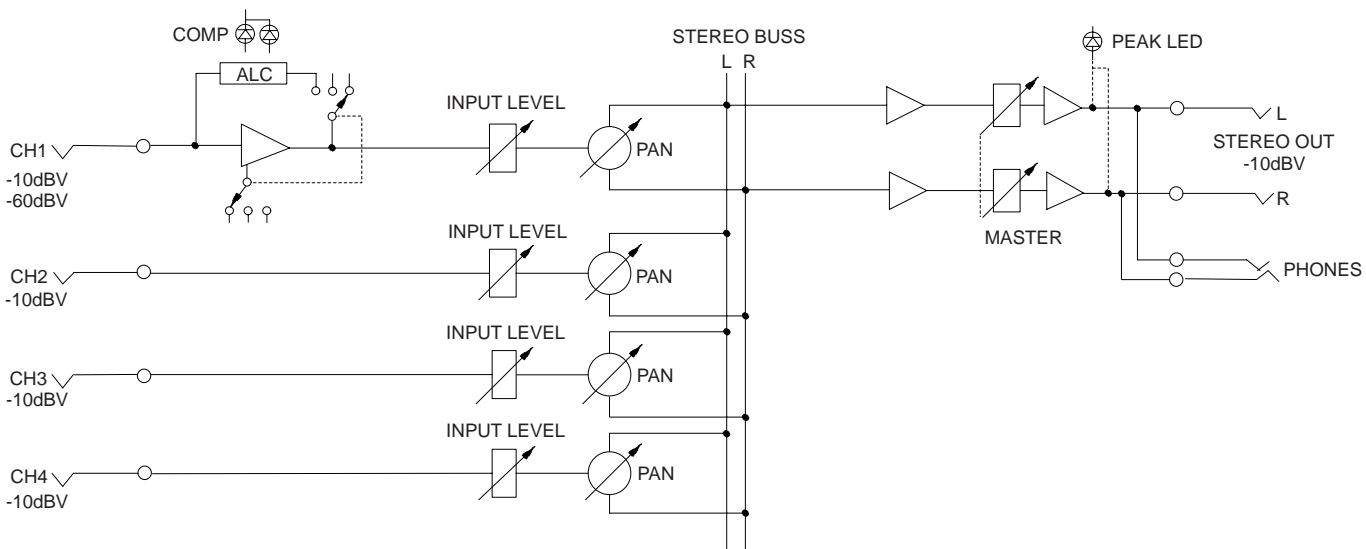

Specifications

INPUT (Ā-4)

<Input 1>

| | |
|-------------------|-------------------|
| Mic Impedance | : Less than 10kΩ |
| Input Impedance | : 20kΩ |
| Rated Input Level | |
| MIC INPUT | : -60dBV |
| ALC ON | : -50dBV ~ -20dBV |
| LINE INPUT | : -10dBV |

<Input 2-4>

| | |
|-------------------|----------|
| Rated Input Level | : -10dBV |
| Input Impedance | : 8kΩ |

STEREO OUT (L, R)

| | |
|--------------------|--------------------|
| Load Impedance | : Higher than 10kΩ |
| Rated Output Level | : -10dBV |

PHONES OUT

| | |
|----------------|-----------------|
| Maximum Output | : 20mW (at 32Ω) |
|----------------|-----------------|

| | |
|---|--|
| Load Impedance | : Higher than 16Ω |
| Frequency Response | : 20Hz ~ 20kHz |
| Distortion Rate (T.H.D.) | : 0.05% |
| Power Supply | : DC9V (Exclusive AC adaptor) : Battery x 1 (Option/Equivalent to S-006P, 6F22) |
| Current Consumption | : 40mA |
| Battery Life (Depends on application condition) | : Manganese type (S-006P, 6F22) = Approx. 4 hours, Alkali type (6LR61) = Approx. 10 hours |
| Physical Dimensions (mm) | : 193 (W) x 130 (D) x 52 (H) |
| Weight | : Main unit - Approx. 500g : AC adaptor - Approx. 230g |
| Accessory | : AC adaptor x 1, Owner's Manual |

* Specifications subject to change without notice.

Declaration of EC Directive

This equipment is compatible with the EMC Directive (89/336/EEC) - Directive on approximation of member nation's ordinance concerning the electromagnetic compatibility and with the Low Voltage Directive (73/23/EEC) - Directive on approximation of member nation's ordinance concerning electric equipment designed to be used within the specified voltage range.

The Affect of Immunity on This Equipment

The affect of the European specification EN50082-1 (coexistence of electromagnetic waves - common immunity specification) on this equipment are as shown below.

* In the electrical fast transient / burst requirements, radiated electromagnetic field requirements and static electricity discharging environment, this could be affected by generation of noise and distortion in some cases.

FOSTEX DISTRIBUTORS LIST IN EUROPE * Including non - EU countries. * underlined: contracted distributors (as of November, 1997)

<AUSTRIA>

NAME: ATEC Audio-u. Videogeraete VertriebsgesmbH.
ADD: Im Winkel 5, A-2325 Velm, Austria
TEL: (+43) 2234-74004, FAX: (+43) 2234-74074

<BELGIUM>

NAME: EML N. V.
ADD: Bijvennestraat 1A, B3500 Hasselt, Belgium
TEL: (+32) 11-232355, FAX: (+32) 11-232172

<DENMARK>

NAME: SC Sound ApS
ADD: Malervej 2, DK-2630 Taastrup, Denmark
TEL: (+45) 4399-8877, FAX: (+45) 4399-8077

<FINLAND>

NAME: Noretron Audio
ADD: Tonntuorinkuja 4, FIN-02200 Espoo, Finland
TEL: (+358) 0-5259330, FAX: (+358) 0-52593352

<FRANCE>

NAME: Musikengro
ADD: ZAC de Follieuses, B. P. 609, 01706 Les Echets, France
TEL: (+33) 72 26 27 00, FAX: (+33) 72 26 27 01

<GERMANY>

NAME: Studiosound & Music GmbH
ADD: Scheppe Gewissegasse 8, D-35039 Marburg, Germany
TEL: (+49) 6421-12071, FAX: (+49) 6421-15522

<GREECE>

NAME: Bon Studio S. A.
ADD: 6 Zaimi Street, Exarchia, 106.83 Athens, Greece
TEL: (+30) 1-3809605-8, 3302059, FAX: (+30) 1-3845755

<ICELAND>

NAME: I. D. elrf. electronic Ltd.
ADD: Armula 38 108 Reykjavik, Iceland
TEL: (+354) 588 5010, FAX: (+354) 588 5011

<ITALY>

NAME: Recoton Italia Srl.
ADD: V. 1 Maggio, N 18, 40050 Quarto Inferiore, (BO) Italy
TEL: (+39) 51-768576, FAX: (+39) 51-768336

<THE NETHERLANDS>

NAME: IEMKE ROOS AUDIO B. V.
ADD: Kuiperbergweg 20, 1101 AG Amsterdam, The Netherlands
TEL: (+31) 20-697-2121, FAX: (+31) 20-697-4201

<NORWAY>

NAME: Siv. Ing. Benum A/S
ADD: P. O. Box 145 Vinderen, 0319 Oslo 3, Norway
TEL: (+47) 22-139900, FAX: (+47) 22-148259

<PORTUGAL>

NAME: Caius - Tecnologias Audio e Musica, Lda.
ADD: Rua de Santa Catarina, 131 4000 Porto, Portugal
TEL: (+351) 2-2084456/325400, FAX: (+351) 2-314760

<SPAIN>

NAME: Multitracker, S. A.
ADD: C/Garcilaso No.9, Madrid 28010, Spain
TEL: (+34) 1-4470700, 1-4470898, FAX: (+34) 1-5930716

<SWEDEN>

NAME: TTS Tal & Ton Studioteknik AB
ADD: Gelbgjutarevagen 4, S-171 48 Solna, Sweden
TEL: (+46) 8-7340750, FAX: (+46) 8-824476

<SWITZERLAND>

NAME: Audio Bauer Pro AG
ADD: Bernerstrasse-Nord 182, CH-8064 Zurich, Switzerland
TEL: (+41) 1-4323230, FAX: (+41) 1-4326558

<UK>

NAME: SCV London
ADD: 3A 6-24 Southgate Road, London N1 3JJ, England, UK
TEL: (+44) 171-923-1892, FAX: (+44) 171-241-3644

Fostex

FOSTEX CORPORATION

3-2-35 Musashino, Akishima-shi, Tokyo, Japan 196-0021

FOSTEX CORPORATION OF AMERICA

15431, Blackburn Ave., Norwalk, CA 90650, U. S. A.

Free Manuals Download Website

<http://myh66.com>

<http://usermanuals.us>

<http://www.somanuals.com>

<http://www.4manuals.cc>

<http://www.manual-lib.com>

<http://www.404manual.com>

<http://www.luxmanual.com>

<http://aubethermostatmanual.com>

Golf course search by state

<http://golfingnear.com>

Email search by domain

<http://emailbydomain.com>

Auto manuals search

<http://auto.somanuals.com>

TV manuals search

<http://tv.somanuals.com>