

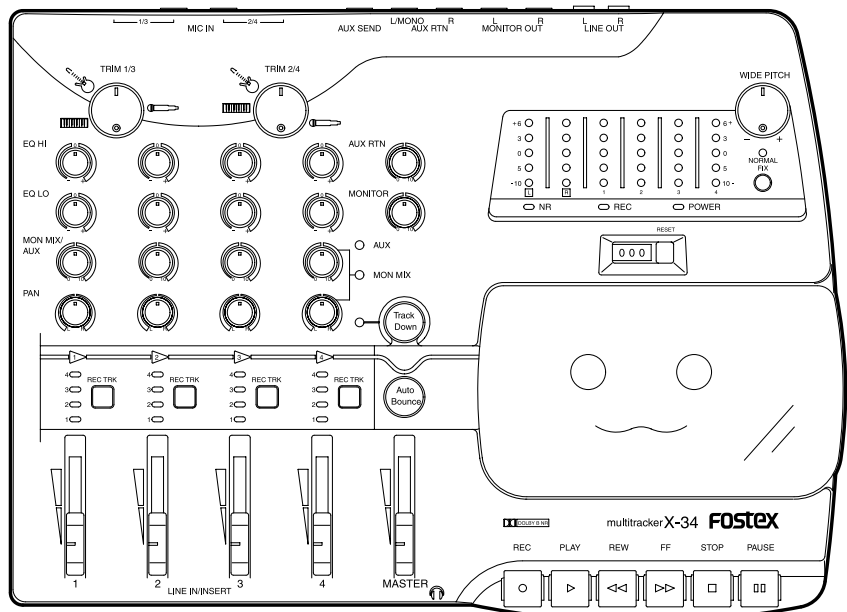

# Model X-34

Multitracker



**Fostex**

	<b>CAUTION</b> RISK OF ELECTRIC SHOCK DO NOT OPEN	
<p>CAUTION: TO REDUCE THE RISK OF ELECTRIC SHOCK, DO NOT REMOVE COVER (OR BACK). NO USER - SERVICEABLE PARTS INSIDE. REFER SERVICING TO QUALIFIED SERVICE PERSONNEL.</p>		

**CAUTION:**  
TO PREVENT ELECTRIC SHOCK, MATCH WIDE BLADE OF PLUG TO WIDE SLOT, FULLY INSERT.

**ATTENTION:**  
POUR ÉVITER LES CHOCS ÉLECTRIQUES, INTRODUIRE LA LAME LA PLUS LARGE DE LA FICHE DANS LA BORNE CORRESPONDANTE DE LA PRISE ET POUSSER JUSQU' AU FOND.



The lightning flash with arrowhead symbol, within an equilateral triangle, is intended to alert the user to the presence of uninsulated "dangerous voltage" within the product's enclosure that may be of sufficient magnitude to constitute a risk of electric shock to persons.



The exclamation point within an equilateral triangle is intended to alert the user to the presence of important operating and maintenance (servicing) instructions in the literature accompanying the appliance.

## "WARNING"

"TO REDUCE THE RISK OF FIRE OR ELECTRIC SHOCK, DO NOT EXPOSE THIS APPLIANCE TO RAIN OR MOISTURE."

## SAFETY INSTRUCTIONS

1. Read Instructions - All the safety and operating instructions should be read before the appliance is operated.
2. Retain Instructions - The safety and operating instructions should be retained for future reference.
3. Heed Warnings - All warnings on the appliance and in the operating instructions should be adhered to.
4. Follow Instructions - All operating and use instructions should be followed.
5. Water and Moisture - The appliance should not be used near water - for example, near a bathtub, washbowl, kitchen sink, laundry tub, in a wet basement, or near a swimming pool, and the like.
6. Carts and Stands - The appliance should be used only with a cart or stand that is recommended by the manufacturer.



An appliance and cart combination should be moved with care. Quick stops, excessive force, and uneven surfaces may cause the appliance and cart combination to overturn.

7. Wall or Ceiling Mounting - The appliance should be mounted to a wall or ceiling only as recommended by the manufacturer.
8. Ventilation - The appliance should be situated so that its location or position does not interfere with its proper ventilation. For example, the appliance should not be situated on a bed, sofa, rug, or similar surface that may block the ventilation openings; or, placed in a built-in installation, such as a bookcase or cabinet that may impede the flow of air through the ventilation openings.

9. Heat - The appliance should be situated away from heat sources such as radiators, heat registers, stoves, or other appliances (including amplifiers) that produce heat.
10. Power Sources - The appliance should be connected to a power supply only of the type described in the operating instructions or as marked on the appliance.
11. Grounding or Polarization - The precautions that should be taken so that the grounding or polarization means of an appliance is not defeated.
12. Power Cord Protection - Power supply cords should be routed so that they are not likely to be walked on or pinched by items placed upon or against them, paying particular attention to cords at plugs, convenience receptacles, and the point where they exit from the appliance.
13. Cleaning - The appliance should be cleaned only as recommended by the manufacturer.
14. Nonuse Periods - The power cord of the appliance should be unplugged from the outlet when left unused for a long period of time.
15. Object and Liquid Entry - Care should be taken so that objects do not fall and liquids are not spilled into the enclosure through openings.
16. Damage Requiring Service - The appliance should be serviced by qualified service personnel when:
  - A. The power supply cord or the plug has been damaged; or
  - B. Objects have fallen, or liquid has been spilled into the appliance; or
  - C. The appliance has been exposed to rain; or
  - D. The appliance does not appear to operate normally or exhibits a marked change in performance; or
  - E. The appliance has been dropped, or the enclosure damaged.
17. Servicing - The user should not attempt to service the appliance beyond that described in the operating instructions. All other servicing should be referred to qualified service personnel.

Thank you for purchasing the Fostex Model X-34 multitracker.

The X-34 is a four-track, four-channel cassette tape recorder that features four line inputs, plus two inputs that accept a range of inputs from line level to mic level. Each channel module is equipped with a two-band EQ for superior sound quality. The X-34 also provides flexible elements, such as the AUX send/return connectors for applying desired external effects and the recording track-select switches that enable you to specify any track as the recording destination. A speed of 9.5cm/s and Dolby B type noise reduction ensure high quality recording. In particular, the exclusive Fostex "Auto Bounce function" makes ping-pong recording a breeze.

The X-34 contains a "Rehearsal" mode, which is convenient for punching in and out. You can practice until you are ready to record.

Please read this owner's manual thoroughly before using the X-34 to make the best use of its features and extend the useful life of the unit.

## Table of Contents

<b>Precautions (please read before use)</b> .....	<b>3</b>
<b>Cautions for Using the X-34</b> .....	<b>4</b>
<b>Before Using the X-34</b> .....	<b>4</b>
<Top Panel> .....	5
<Front panel> .....	7
<Rear Panel> .....	8
<b>Basic Operation: "Let's Record!"</b> .....	<b>9</b>
Initial mode after the X-34 is powered on: .....	9
Initial setup of the X-34 .....	9
Remember the following before you start to record! ....	10
<b>Basic Recording - 1 (Recording from the front panel LINE IN/INSERT jack)</b> .....	<b>12</b>
<b>Basic Recording - 2 (Recording with the rear panel MIC IN jack)</b> .....	<b>14</b>
Basic Playback Procedure .....	15
<b>Multitrack Recording</b> .....	<b>16</b>
Overdubbing .....	16
<Overdubbing Electric Bass in Track 2 While Listening to the Drum Track> .....	16
Mixdown (Track Down mode) .....	18
<b>Advanced Operation</b> .....	<b>19</b>
Punch In/Out Recording .....	19
Ping-pong Recording (Using the Auto Bounce Function) .....	21
Tape Sync .....	23
Recording a sync signal .....	24
Applying Effects .....	25
Troubleshooting .....	27
Maintenance .....	28
Block Diagram .....	28
Specifications .....	29
Declaration of EC Directive .....	30
The Affect of Immunity on This Equipment .....	30
FOSTEX DISTRIBUTORS LIST IN EUROPE .....	30

## Precautions (please read before use)

### Power supply

- \* When unplugging the AC adapter from an outlet, be sure to grasp the adapter. Attempting to unplug it by pulling on the AC cable may damage the wiring.
- \* It is dangerous to use any power cable that is cut or frayed. If the power cable is damaged, immediately stop using it and have the unit repaired.

- \* Do not plug in or unplug the AC adapter with wet hands. Doing so may result in dangerous electrical shock.
- \* Do not open the unit or touch any parts inside. Doing so may result in a dangerous electrical shock, and may damage the unit.
- \* Do not let water or other liquids, flammable materials, or metal objects such as pins get inside the unit. These items may cause electrical shock or short circuit the X-34 and damage it. If the X-34 should become wet, unplug the AC adapter from the AC outlet, and contact your authorized service station.
- \* When turning the power on, turn the X-34 on first before turning on any connected equipment. Doing so will avoid damaging to the other equipment. Also, when connecting or disconnecting cables to or from the X-34's input or output jacks, set all faders to "0."
- \* When the AC adapter is connected to an AC outlet, it will continue to draw a small amount of power even if the switch is set to off (STANDBY). If you will not be using the X-34 for an extended period of time, be sure to unplug the AC adapter from the outlet.

### Location

**Avoid using the X-34 in the following locations:**

- \* Locations of extreme low or high temperatures, or subject to extreme changes in temperature.
- \* Locations with excessive moisture or dust.
- \* Locations subject to direct sunlight for an extended period of time, or near a stove or other source of heat.
- \* Locations subject to fluctuations in electrical voltage.
- \* Unstable locations or locations subject to heavy vibration.
- \* Near strong magnetic fields (e.g., on top of a television or speaker).

## Cautions for Using the X-34

- \* If a monitor speaker with an internal amplifier is connected to the MONITOR OUT jacks, do not advance the monitor speaker volume control or the X-34 MON MIX/AUX knobs. Doing so could generate a loud noise from the speaker or headphone and damage your hearing.
- \* When plugging external equipment into the X-34 input jack or headphone jack, always switch off the power to the X-34.
- \* When using an external mic, do not bring it close to the monitor speaker while the INPUT faders, MON MIX/AUX knobs, and MONITOR knob are raised and the track is selected for recording. Doing so will generate feedback.
- \* Do not apply the LINE OUT jack signals to the mic input or line input jacks (e.g., directly connecting the LINE OUT jack to the input jack). The resulting oscillation could hurt your ears if you are monitoring with headphones.
- \* Be sure to use the AC adapter included with the X-34. Should an adapter with a different voltage or wrong plug polarity be used, it could cause a fire or severely damage the X-34.

## Before Using the X-34

### <The difference between multitracker recording and cassette deck recording>

A stereo cassette deck allows for stereo recording on sides A and B of a cassette tape.

As shown in the figure below, a cassette tape is divided into four tracks: two for side A, two for side B.

On the other hand, a multitracker, such as the X-34, records to all four tracks on the same side of the tape. If you record something on the multitracker and play the tape on a cassette deck, Tracks 1 and 2 will play normally, but when you try to play the other side of tape, Tracks 3 and 4 will play in reverse.

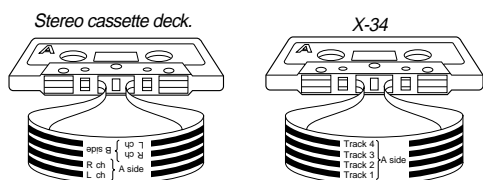

### <Handling cassette tapes>

#### Cassette tape suitable for recording:

The X-34 performs best with a high-position cassette tape (TYPE II, HIGH).

We recommend that you use these types or equivalent tapes for multitrack recording.

C-120 tapes (60 minutes each side) are thin and not suitable for repeated recording or playback.

Use C-90 or shorter tapes for good performance.

#### Using write-protection tabs:

On the edge of a cassette tape are write-protection tabs that are used to prevent recorded data from being accidentally erased. You may want to break off the tab for side A and side B of a cassette tape that you have already recorded, since the X-34 uses all four tracks at the same time. If you later wish to record data on a tape with broken tabs, apply a piece of scotch tape to cover the tab hole.

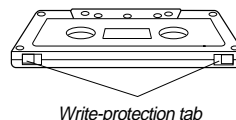

### <Rehearsal Mode>

The Fostex X-34 contains a "rehearsal mode" which is convenient for Punch-in recording.

The rehearsal mode lets you practice the timing for punching in and out, and adjust the recording level by going through the punch in/out take operation without entering recording mode. Connecting an optional foot switch (Model 8051) to the PUNCH IN/OUT jack, selecting a punch-in track, and pressing the PLAY button puts the X-34 in Rehearsal mode.

Using this function, you can practice any number of times before the actual take. For details, refer to "Punch in/out" on page 19.

## Names and Functions

### <Top Panel>

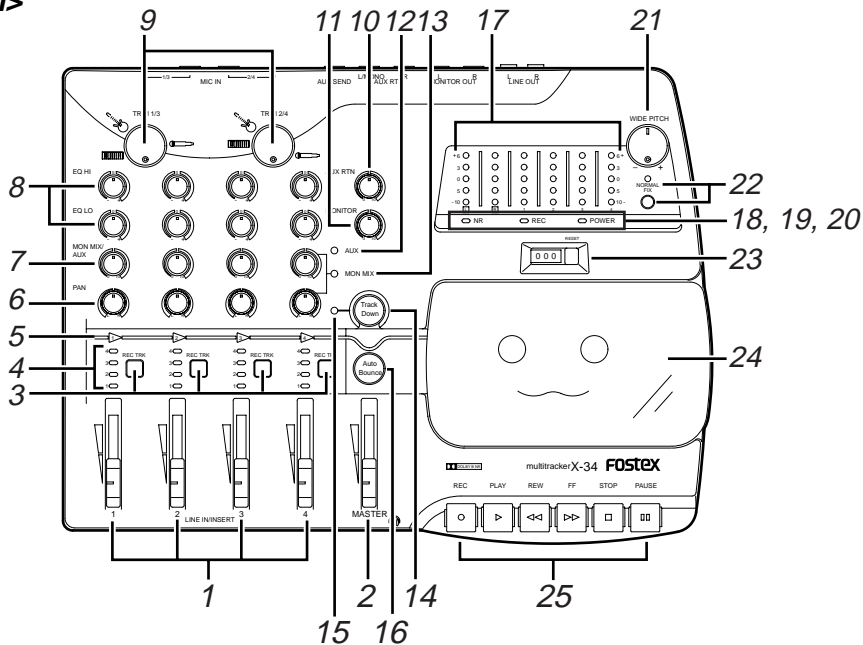

#### 1. Input/playback level control faders

These faders have two functions:  
One function controls the recording level. Input levels applied to the INPUT jacks (front or rear) are controlled by this knob.

The other function controls the tape playback level of each track. For more information on using these faders, refer to the "Basic Recording" and "Basic Playback Procedure" sections.

#### 2. Master fader [MASTER]

This fader controls the output level from LINE OUT L and R.

#### 3. Record track select switch [REC TRK]

This switch is used to select recording tracks.  
Press the switch repeatedly to select the desired track. The track indicator (red) of the selected track lights up to indicate that this track is REC READY. To cancel the track selection, press the switch repeatedly until none of the track indicators are lit.

#### <Note>

When the Track Down button is "ON," the REC TRK switches are disabled. Also, if the Auto Bounce button or Track Down button is switched on and off while any one REC TRK switch is set to REC READY state, the selected REC TRK switch will be canceled. In this case, reselect the recording track using the REC TRK switch.

#### 4. Record track indicator

This indicator lights up in red to indicate that the track is in the REC READY mode when you press the REC TRK switch.

#### 5. Auto bounce indicator

This lights up in green when you press the Auto Bounce button, indicating that the corresponding track is selected as the auto bounce destination.

#### 6. Pan pot knob [PAN]

When the AUX indicator is lit, use these knobs to adjust the stereo imaging of channel signals routed to the INPUT faders. When the MON MIX indicator is lit, use these knobs to control the stereo imaging of each track sound.

#### 7. Monitor/AUX send level control knob [MON MIX/AUX]

This knob enables you to adjust the level of the channel signal for monitoring or to control the level of the signal sent to the AUX bus.

#### 8. Equalizer control knobs [EQ HI, EQ LO]

The X-34 is equipped with a two-band, shelving-type EQ. These knobs are used to adjust tonal quality of the signals routed to the channel faders. The following settings are available:

HI: Signals with a frequency of 10kHz will be boosted and cut up to +/-12 dB.

LO: Signals with a frequency of 100Hz will be boosted and cut up to +/-12 dB.

#### 9. Trim knob

Use this knob to adjust the input level depending on the sound source input to the rear panel MIC IN jack (1/4" or XLR).

This knob enables you to adjust from a signal that ranges from line level to mic level.

**10. AUX return knob [AUX RTN]**

This knob allows you to adjust the input level of processed signals from a connected external effect unit. The level of both signals input to AUX RTN L/MONO and R are adjusted equally.

**11. Monitor master knob [MONITOR]**

This knob allows you to adjust the final level of monitoring signals, i.e., the headphone volume and the level of signals output from the MONITOR OUT L/R jacks.

**12. [AUX] indicator**

This red indicator lights up when the channel MON MIX/AUX knob functions as an AUX control.

**13. [MON MIX] indicator**

This red indicator lights up when the channel MON MIX/AUX knob functions as a MON MIX control.

**14. Track down on/off button [Track Down]**

Pressing this button switches Track Down mode on and off. When Track Down mode is switched on, the Track Down indicator lights up. When Track Down mode is switched off, the Track Down indicator turns off. To select a recording track or perform Auto Bounce (ping-pong), you need to cancel Track Down mode.

**15. Track Down indicator**

The green Track Down indicator lights up when Track Down mode is on. When you turn on the power to the X-34, Track Down mode is automatically engaged.

**16. Auto bounce select button [Auto Bounce]**

When Track Down mode is off, press this button to engage Auto Bounce mode and select a ping-pong destination track. This button is disabled when Track Down mode is on. Pressing this button repeatedly selects a track in the following order: [1]->[2]->[3]->[4]->[OFF]->[1]

**<Note>**

You cannot cancel ping-pong recording by pressing the Auto Bounce button once the process has started.

**17. Level meters**

These five-dot indicator meters indicate the recording/playback level.

During recording, the optimum level is 0 ~ 3 on this meter.

**18. Dolby B noise reduction indicator [NR]**

This indicator lights up in green when you turn on the DOLBY NR switch on the rear panel.

**19. Record indicator [REC]**

This indicator lights up in red when the X-34 is placed in record mode. It also flashes in Punch in/out rehearsal mode.

**20. Power indicator [POWER]**

This indicator lights up when you turn on the power.

**21. Pitch control knob [WIDE PITCH]**

Tape speed can be adjusted within the range of -50% ~ +12%. This is normally set to the center position.

Use this knob during the playback of recorded music to practice your performance at a slower speed.

This is also useful when you wish to overdub a musical instrument that has slightly offset pitch, or a vocalist who can't quite hit the highest note. Pitch control is disabled when the NORMAL FIX indicator is lit.

**22. Tape speed control/indicator [NORMAL FIX]**

Press this switch to change the tape speed from 9.5cm/s to 4.75cm/s. The NORMAL FIX indicator lights up in green, and the pitch control and Dolby B noise reduction are disabled. Pressing this switch again will restore the Dolby and pitch control settings, and the tape speed (9.6cm/s) will be restored. This switch is disabled during recording.

**23. Tape counter/reset button [RESET]**

Tape transport is metered and indicated here.

Press the reset button to return the counter to [000].

**24. Cassette lid/Cassette tray**

Insert a cassette tape here.

Load or unload cassettes only when the transport is stopped.

**25. Transport control buttons****Play button [PLAY]**

Press this button to start playback.

**Stop button [STOP]**

Press the [STOP] button to stop tape transport. The tape transport buttons PLAY, REC, REW and FF will cancel and the tape will stop.

**Fast forward button [FF]**

Press this button to fast forward the tape at high speed.

**Rewind button [REW]**

Press this button to rewind the tape at high speed.

**Recording button [REC]**

While a record track indicator or indicators are lit (red), press this button and the PLAY button simultaneously to start recording. If you press the PAUSE button prior to these buttons, the X-34 will enter record standby mode and the tape will remain stopped.

**<Note>**

The REC button will be ineffective if the "cassette erase prevention tab" is broken.

**Pause button [PAUSE]**

You press this button during playback or recording, the tape will stop (the PLAY and RECORD buttons will remain depressed). If you press this button again, stop mode will be canceled and playback or recording will resume.

This button will not function during rewind or fast forward operations.

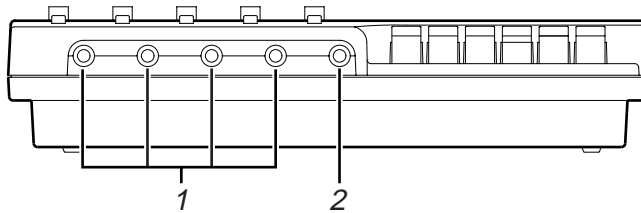
**<Front panel>****1. Line in/insert jack [LINE IN/INSERT 1, 2, 3, 4]**

Line level sound sources are input here.

Input signals are sent only to the tracks selected by the REC TRK switches on the corresponding channels.

If a sound source input from the rear panel MIC IN jack is to be processed, use these jacks to insert a

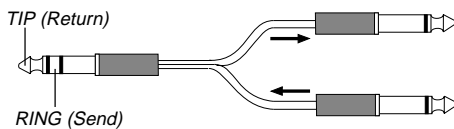

compressor/limiter or other effect.

**<Note>**

Priority is always given to the LINE IN/INSERT jacks. You cannot record one sound source from the MIC IN 1/3 jack and one from the LINE/INSERT 1 and 3 jacks (or one from the MIC IN 2/4 jack and one from the LINE/INSERT 2 and 4 jacks) onto the same track at the same time. Refer to page 10 and 11 for more information.

**2. Headphone jack [PHONES]**

Plug in monitor headphones here.

<Rear Panel>

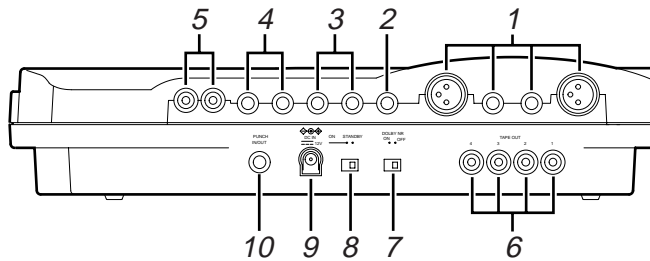

**1. Mic input jack [MIC IN 1/3, 2/4]**

Plug in a microphone here.

You can input any signal, ranging from mic level to line level devices, because the X-34 features a trim knob for each input. Both XLR connectors (balanced) and 1/4" jacks (unbalanced) are provided. Use the one appropriate for your application.

The sound source input to MIC IN jack 1/3 is routed to channels 1 and 3, and the inputs to MIC IN jack 2/4 are sent to channels 2 and 4.

**<Note>**

The XLR connector and 1/4" jack cannot be used simultaneously to record onto the same track.

**2. AUX Send jack [AUX SEND]**

Connect this 1/4" jack to the input of an effects processor. This jack outputs the signals selected and adjusted by the MON MIX/AUX knobs.

**3. AUX Return jacks [AUX RTN (L/MONO, R)]**

Connect these 1/4" jacks to the output of an effects processor. You can also use them as auxiliary inputs. If a connected effects processor has a mono output, connect the output to the L/MONO jack of the X-34. (The right channel will receive the same signal.) Adjust the level of processed signals using the AUX RTN knobs on the top panel.

**4. Monitor Out jacks [MONITOR OUT (L, R)]**

Connect monitoring speakers and an amplifier (or powered speakers) here to monitor the sound. These 1/4" jacks output the same signals as the PHONES jack. Use the MONITOR knob on the top panel to adjust the monitoring level.

**5. Line out jacks [LINE OUT L, R]**

These RCA pin jacks are connected to the master recorder input connectors (L, R) for mixdown. Adjust the output level using the MASTER fader.

**6. Tape out jack [TAPE OUT 1, 2, 3, 4]**

Signals from tracks 1-4 are output from these RCA pin jacks.

These outputs can be sent to external mixers.

In addition, TAPE OUT 4 can also be used as the SYNC OUT jack to send the sync signal from the tape to an external MIDI sequencer.

**7. Dolby B noise reduction on/off switch [DOLBY NR ON/OFF]**

This switch turns on Dolby B noise reduction.

For high quality recording and playback, we recommend Dolby B.

If a tape recorded with Dolby B noise reduction is played back, set this switch to ON. This switch is disabled when the NORMAL FIX indicator is lit. Dolby setting turns off automatically when the NORMAL FIX indicator lights up.

**8. Power switch [ON-STANDBY]**

This switch turns on the power to the X-34. Even when this is switched off (STANDBY), a small amount of current continues to flow through the X-34.

Therefore, if the X-34 is not going to be used for a long period of time, disconnect the AC adapter from the wall socket.

**9. DC IN connector [DC IN 12V]**

Plug in the exclusive AC adapter packaged with X-34 here.

**10. Punch in/out jack [PUNCH IN/OUT]**

Plug in the optional Foot Switch (Model 8051) for punching in and out or rehearsal here.



## Basic Operation: "Let's Record!"

### Initial mode after the X-34 is powered on:

When you connect the AC adapter and turn on the power to the X-34, it automatically engages "Track Down mode," and the Track Down indicator lights up as shown below.

Please refer to the following "Initial setup of the X-34" section to reset the X-34 before you proceed to the next session.

\* For information on Track Down mode, refer to page 18.

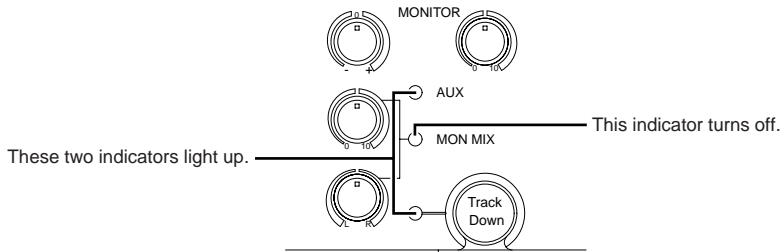

### Initial setup of the X-34

After you complete a recording session, reset all knobs and switches on the X-34 to their initial settings before proceeding. This will help you avoid unexpected problems related to switch and knob settings being unsuitable for the next recording. In this manual, this state will be called the "initial setting." The control panel switches and knobs should be set as shown below.

Always return to this "initial setting" before proceeding to the next recording session.

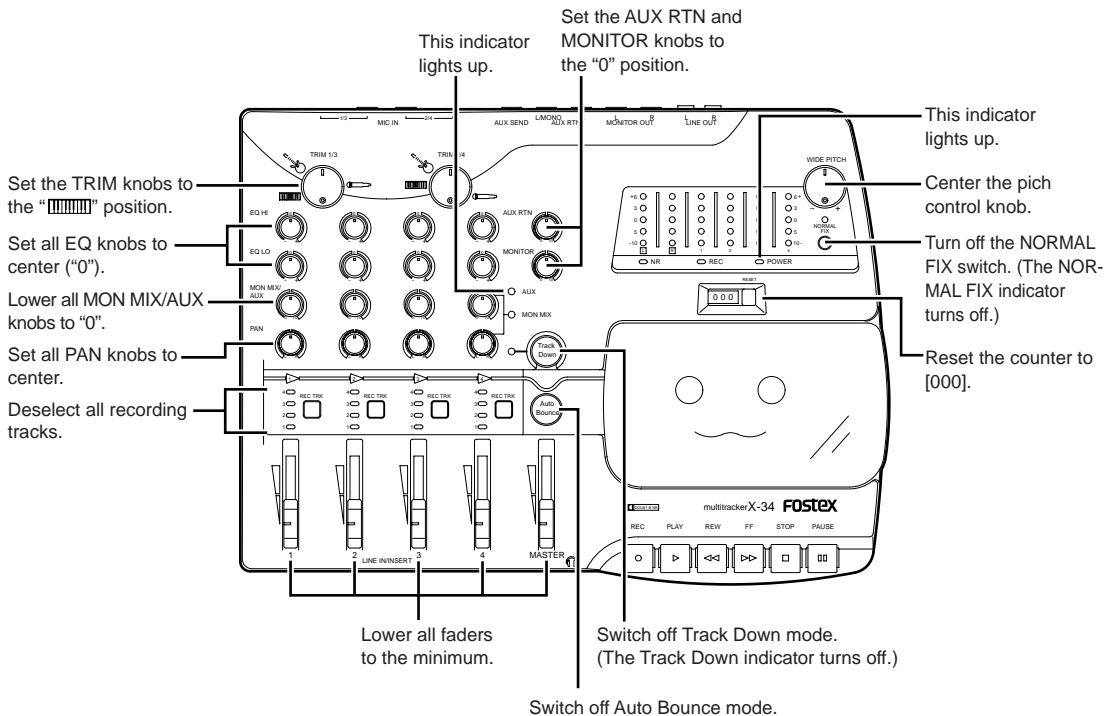

**Remember the following before you start to record!**

The X-34 includes jacks (or connectors) for musical instrument and mic inputs on the front and rear panels. The functions of these input jacks (or connectors) are explained below:

**Front panel LINE IN/INSERT jack**

Normally, a line level sound source with a 1/4" type plug is connected here. (You cannot plug in a microphone here.).

Signals applied to each input jack are recorded on the track selected by the corresponding REC TRK switch.

Therefore, by connecting four different sound sources to these LINE IN/INSERT jacks, you can record up to four tracks simultaneously.

These jacks can also serve as an insert point. For example, you can connect various effects here, such as a compressor for a mic input to a rear panel jack.

These jacks are used as insert points only for sound sources input to the rear panel (jack or XLR).

For information on connecting effects, refer to page 25.

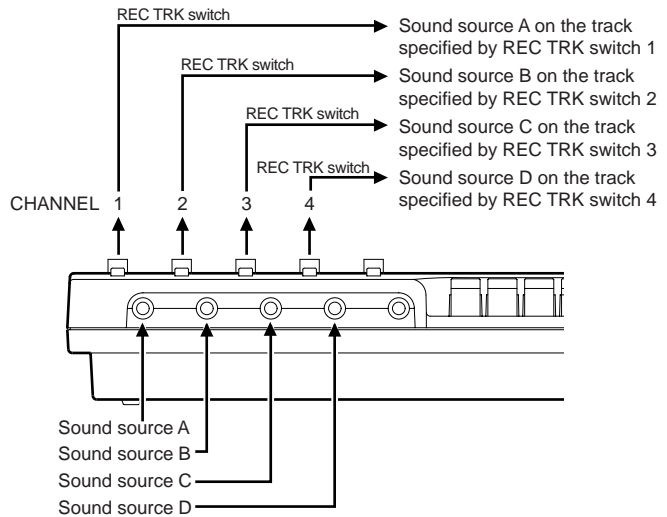

**Rear panel MIC IN (1/3, 2/4) jack**

Microphones are generally plugged in here.

Use the trim knob provided for each input to adjust the input level to match the output level of the connected sound source.

The Trim knobs attenuate the input level to accommodate inputs ranging from mic to line level.

Both 1/4" jacks and XLR connectors are provided, allowing for many types of sound sources.

**However, remember that priority is given to the 1/4" jack. If it is being used, the XLR connectors are ineffective.**

Unlike the front panel input jacks, signals input to MIC IN 1/3 will be routed to channels 1 and 3, and signals input to MIC IN 2/4 will be routed to channels 2 and 4.

**The REC TRK switch setting determines which tracks will be recorded.**

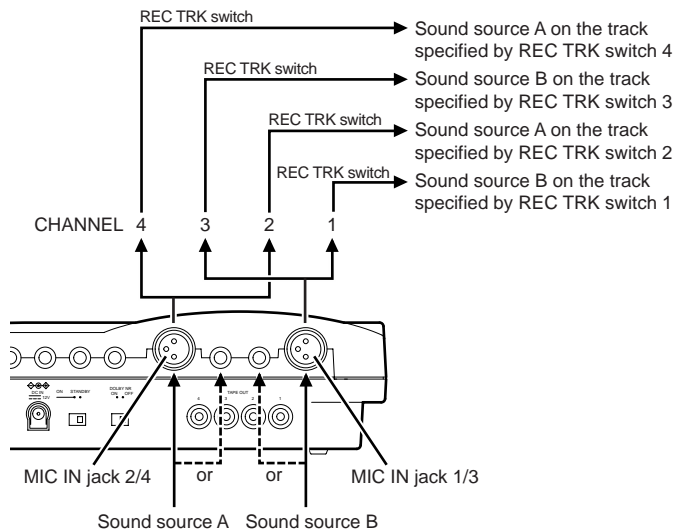

**<Using both MIC IN jack and LINE IN/INSERT jack>**

Keep the following information about the MIC IN and LINE IN/INSERT jacks in mind when recording sound sources using both types of input jacks.

The front panel LINE IN/INSERT jack has priority. For example, if you attempt to input different sound sources (Sound source A, Sound source B) simultaneously from the front panel LINE IN/INSERT jack 1 and the rear panel MIC IN jack 1/3, priority will be given to the LINE IN/INSERT jack 1 to send the signal to channel 1, and the signal from the MIC IN jack 1/3 will be sent to only channel 3.

Since Sound source A is routed to channel 1 and Sound source B is routed to channel 3, selecting a recording track using the corresponding REC TRK switches enables you to record Sound sources A and B simultaneously. The same applies to LINE IN/INSERT jack 3 and MIC IN jack 1/3.

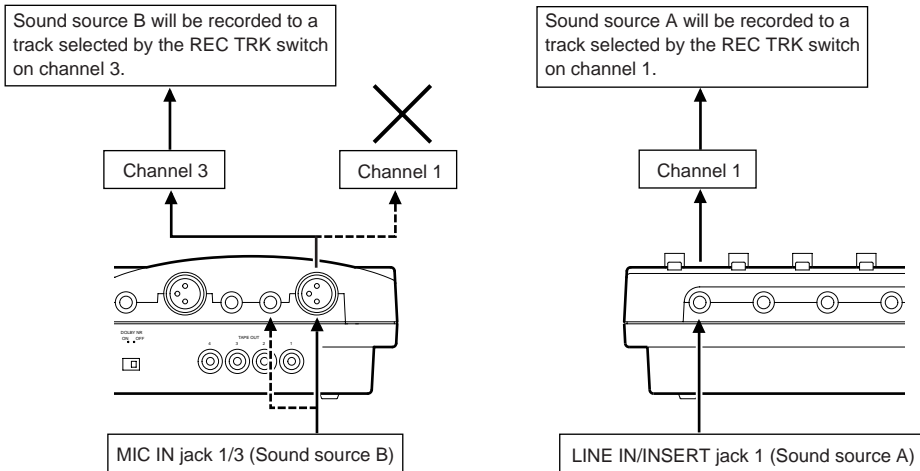

If you connect Sound sources A and B to LINE IN/INSERT jacks 1 and 3, and Sound source C to MIC IN jack 1/3, Sound source C will be ignored and cannot be recorded simultaneously. (The same applies to LINE IN/INSERT jacks 2 and 4 and MIC IN jack 2/4.)

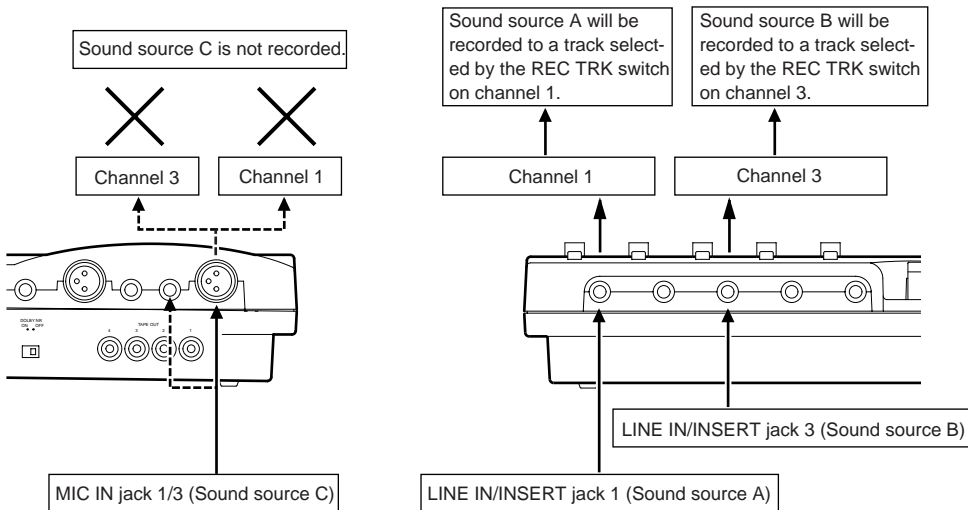

## Basic Recording - 1 (Recording from the front panel LINE IN/INSERT jack)

First, let's connect your musical instrument and try recording on a specific track.

In the following example, a synthesizer will be recorded on track 1. This and other explanations assume an AC adapter is connected to the X-34 and the X-34 is powered on.

\* Before proceeding to the next step, set the X-34 to its "initial settings" as explained on page 9. Also, make sure that the Track Down indicator is turned off.

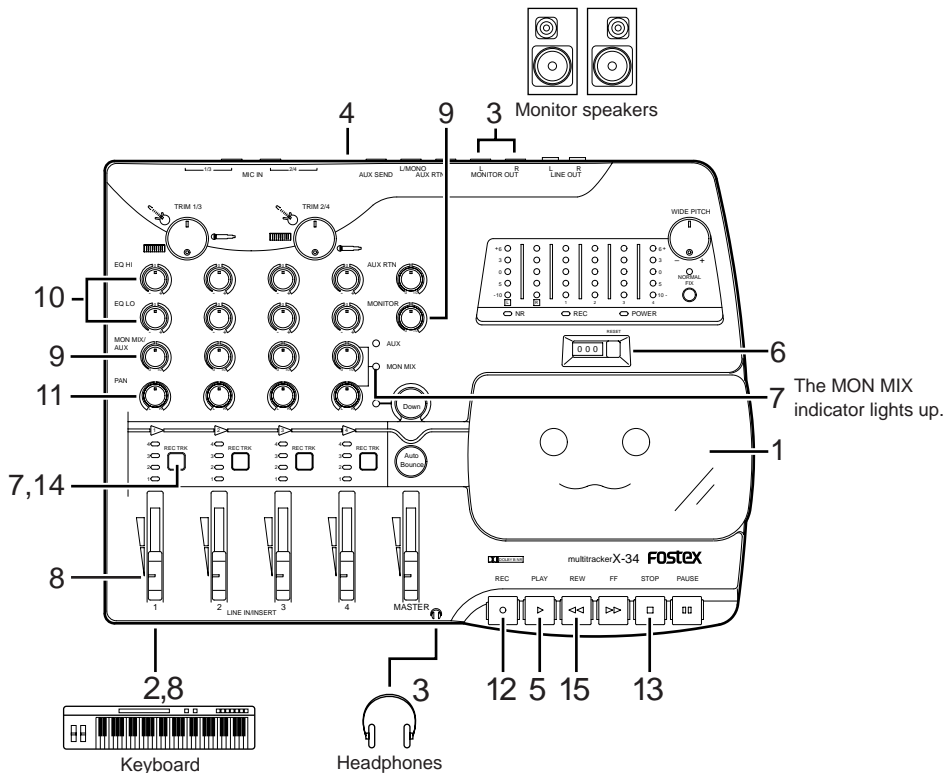

**1. Lift the cassette tray lid and load the cassette into the cassette tray.**

If a previously-recorded tape is being used, check that the rear side erasure prevention tab has not been broken off.

If it is, cover the hole with a piece of scotch tape.

**2. Use an instrument cable to connect the synthesizer output to the front panel LINE IN/INSERT jack 1.**

**3. Plug the headphones into the PHONES ( ) jack on the front panel, or connect the monitor speaker system to the MONITOR OUT jack on the rear panel.**

**4. Switch ON the Dolby B noise reduction switch.**

**5. Press the PLAY button to advance the tape a few seconds.**

This will wind past the leader at the head of the

recording tape. If a used tape is not completely rewound, press the REW button to wind to the beginning and repeat this step.

**6. After you wind past the leader tape, press the RESET button to set the counter to [000].**

**7. Press the REC TRK switch 1 once to place track 1 in REC READY mode.**

The record track indicator 1 will light up in red, and the MON MIX indicator will light up.

**<Note>**

You can, of course, record the sound source connected to LINE IN/INSERT jack 1 to any track other than track 1 using REC TRK switch 1 to select the desired track.

**<Note>**

When Track Down is "ON," the REC TRK switches are disabled. Also, if the Auto Bounce button or Track Down button is switched on and off while any one REC TRK switch is set to REC READY state, the selected REC TRK switch will be canceled. In this case, reselect the recording track using with the REC TRK switch.

**8. While playing the synthesizer, gradually raise the channel 1 input/playback level fader.**

*As the fader is raised, the level meter 1 will start to blink.*

*Adjust the recording level by raising the input/playback level fader to a point where the meter [3] blinks at maximum sound volume.*

**9. You can adjust the headphone or monitor speaker sound volume by turning the MONITOR knob, and the channel 1 MON MIX/AUX knob.**

**10. Use the EQ knobs on channel 1 to adjust the tone.**

**11. Position the monitor sound image using the channel 1 PAN knob.**

**<Note>**

If you had selected a track other than track 1 as the recording destination, use the MON MIX/AUX knob and PAN knob of the corresponding track channel. For example, if the sound source is input at LINE IN/INSERT 1 and to be recorded to track 2, use the MON MIX/AUX knob and the PAN knob on channel 2.

**12. After adjusting the recording level and tone, press the REC button (the PLAY button will also depress) to start recording.**

*The REC indicator lights up in red.*

**13. When you finish recording, press the STOP button.**

*Recording will be canceled (the REC indicator turns off).*

**14. Press REC TRK switch 1 repeatedly to turn off the record track indicator.**

**15. Press the REW button and rewind the tape to counter [000].**

*Try recording on tracks 2-4 in the same way.*

## Basic Recording - 2 (Recording with the rear panel MIC IN jack)

This section describes how to record a vocal on track 1 by plugging a microphone into the rear panel MIC IN jack 1/3.

\* Before proceeding to the next step, remember to reset the X-34 to its "initial settings." (See page 9.) Also, make sure that the Track Down indicator is turned off.

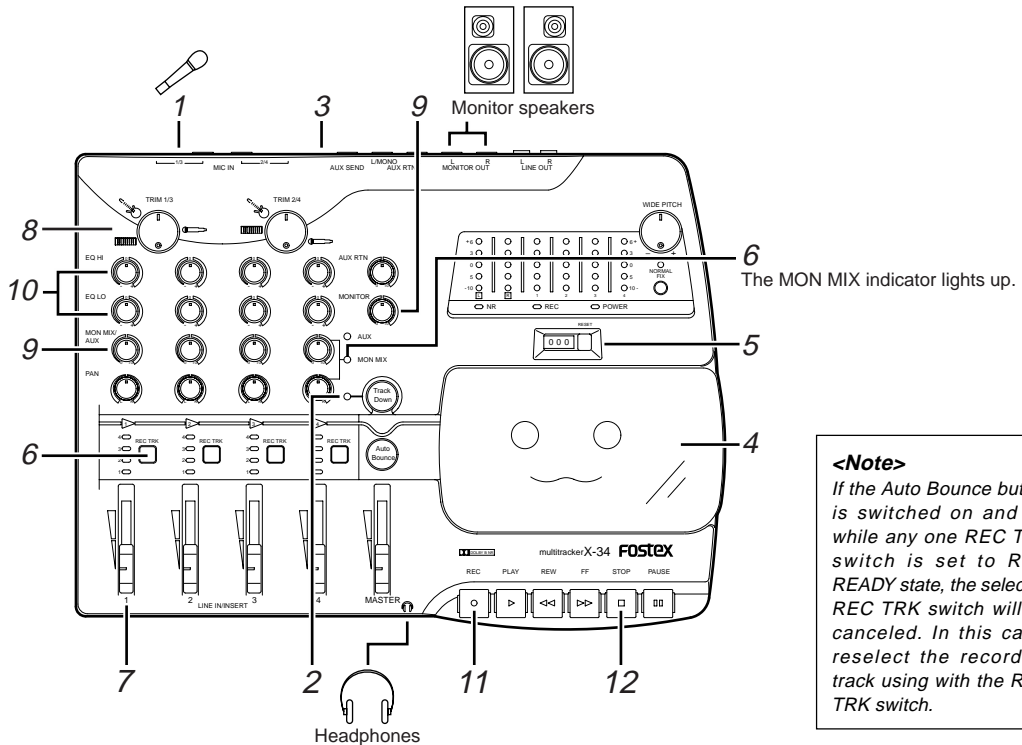

1. Plug a mic into the rear panel MIC IN jack 1/3 (1/4" or XLR).
2. Make sure that the Track Down indicator is turned off.

**<Note>**

When Track Down is "ON", the REC TRK switches are disabled.

3. Switch ON the Dolby B noise reduction switch.
4. If this is a new song, load a cassette in the transport and advance the tape to recording start position as previously described.
5. Reset the counter to [000] by pressing the RESET button.
6. Place track 1 in REC READY mode by pressing REC TRK switch 1.

Record track indicator 1 lights up in red.  
The signal from MIC IN jack 1/3 is also routed to channel 3.

If you also select track 3 by pressing the REC TRK switch on channel 3, the same signal can be recorded to tracks 1 and 3.

7. Raise the channel 1 input/playback level fader to the position shown right.
8. Adjust the recording level with the Trim 1/3 knob while talking into the microphone so that segments 0 - 3 on the level meter light up.
9. The headphone and monitor volume can be adjusted using the MONITOR knob and the channel 1 MON MIX/AUX knob.
10. Use the EQ knobs on channel 1 to adjust the tone.
11. After you adjust the recording level and tone, start recording by pressing the REC button. (The PLAY button also depresses.)

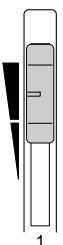

**12. When you finish recording, press the STOP button to stop the tape transport and press the REC TRK switch 1 repeatedly to deselect the recording track.**

The MON MIX indicator turns off, and the AUX indicator lights up.

**<NOTE>**

If you connect a microphone to MIC IN jack 2/4, the signal is routed to channels 2 and 4 (although you can use the REC TRK switch to route the signal to any desired track).

**Basic Playback Procedure**

Let's play back and listen to the recorded sound.

This procedure assumes different sounds have been recorded to tape on tracks 1 - 4.

\* Before proceeding to the next step, reset the X-34 to its "initial settings." (See page 9.)  
Make sure that the Track down indicator is turned off.

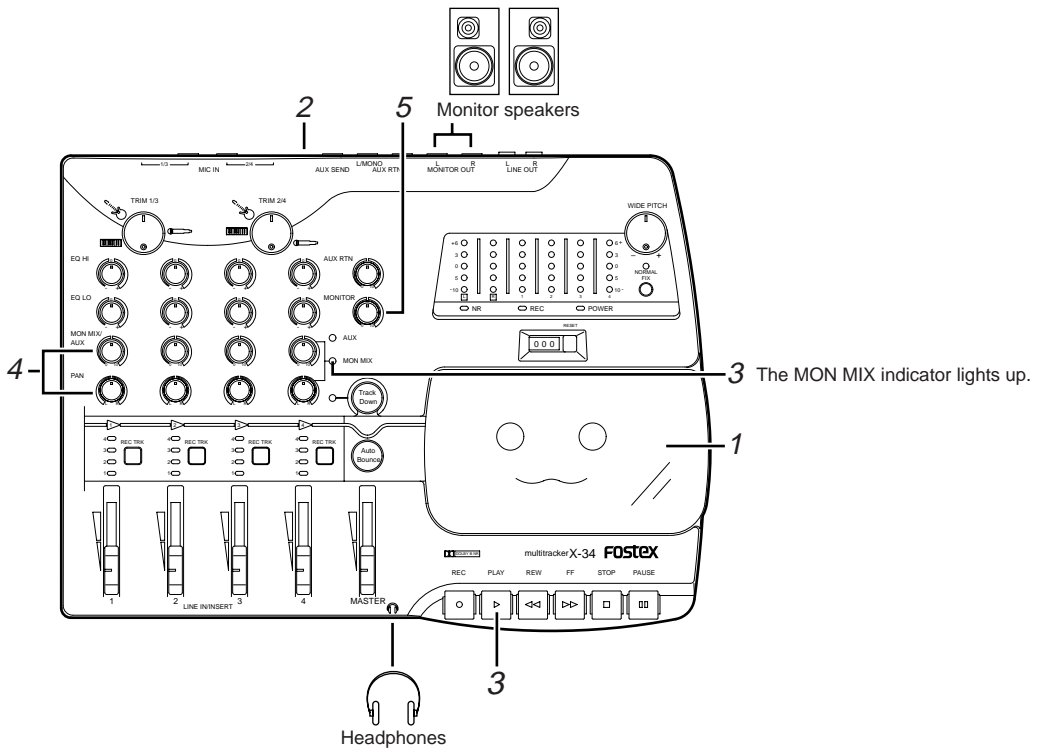

1. **Rewind the tape to counter [000].**
2. **Switch ON the Dolby B noise reduction switch.**
3. **Press the PLAY button to play back the tape.**  
The MON MIX indicator lights up.
4. **Gradually turn the MON MIX/AUX knobs for each channel to adjust the output of each track.**  
Adjust the PAN knobs for each channel to achieve the proper stereo image.

5. **Use the MONITOR knob to adjust the overall monitor volume.**

**<Note>**

If you monitor with headphones for several hours, do not raise the MONITOR knob too high. Otherwise, you could damage your hearing. Take a break occasionally to give your ears a rest.

You can also use Track Down mode to play back the recording. Refer to page 18 for more information.

## Multitrack Recording

You should now have a good understanding of the basic recording and playback operation of the X-34. Now let's try the X-34's multitrack recording functions.

The following sections explain overdubbing, which is a fundamental function in multitrack recording, and also the mixdown process, in which the sound recorded to four tracks is mixed and copied (dubbed) to a master recorder.

### Overdubbing

Overdubbing is a process that enables you to "layer" recorded sounds. This technique involves listening to (monitoring) a previously-recorded track while recording new performance to a different track.

For example, the rhythm section (drum machine) might be recorded on track 1. While you listen to the drum track, you record an electric bass to track 2. Thus, different sounds are recorded in "layers" on the four separate tracks.

In the example below, we assume that a drum machine is recorded on track 1. We then overdub an electric bass on track 2, a keyboard on track 3, and a vocal on track 4.

### <Overdubbing Electric Bass in Track 2 While Listening to the Drum Track>

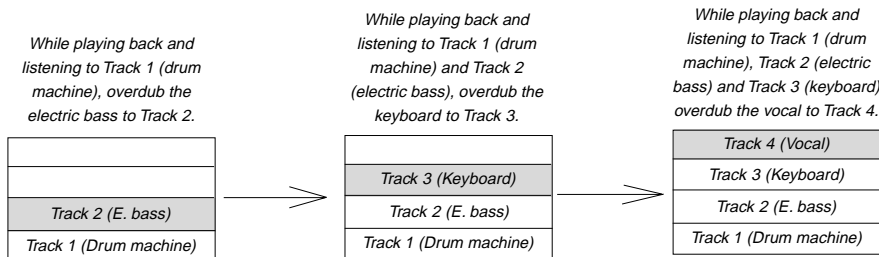

- \* Before starting to overdub, refer to "Basic Playback Procedure" and practice the electric bass track while listening to drums on track 1.
- \* Before you start, set the X-34 to its initial settings. (See page 9.)

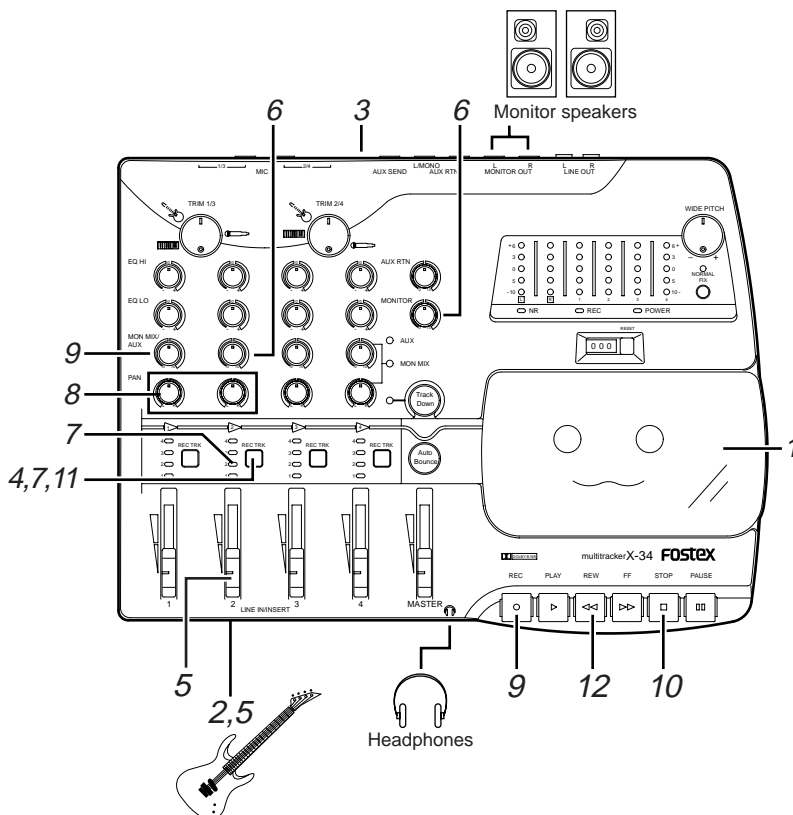



1. **Rewind tape to its starting position ([000]) for recording.**
2. **Plug the electric bass into front panel LINE IN/INSERT jack 2. (You can use any available LINE IN/INSERT jack.)**

**<Note>**

This is the simplest way to record a bass. You can also use an amplifier or a direct-input box to create different sounds.

3. **Switch ON the Dolby B noise reduction switch.**

### **Adjusting the Recording Level and Practicing your performance**

Before overdubbing, practice and adjust the level of the electric bass by listening to the prerecorded track sound.

4. **Press REC TRK switch 2 to select track 2 as a recording track.**  
*Track 2 enters REC READY mode.*
5. **While playing the electric bass, adjust the recording level by gradually raising the channel 2 input/playback level fader.**  
*The track 2 level indicator lights up.*
6. **Adjust the overall headphone or monitor volume using the MONITOR knob and the channel 2 MON MIX/AUX knob.**

### **Overdubbing Take**

7. **Make sure that the record track indicator on channel 2 is lit. Otherwise, press the REC TRK switch 2 to set track 2 in REC READY mode.**
8. **Adjust the placement of each channel in the stereo image using the PAN knobs.**
9. **Start recording your performance by pressing the REC button. (The PLAY button also depresses.)**  
*While listening to the track 1 playback, play the electric bass and overdub it to track 2.*  
*Adjust the track 1 sound (drum machine) using the channel 1 MON MIX/AUX knob.*
10. **When you have finished overdubbing, press the STOP button to stop the tape transport.**
11. **Press REC TRK switch 2 repeatedly to turn off the record track indicator.**
12. **Rewind the tape to counter [000] and play back sound on tracks 1 and 2. If you have questions, please refer to "Basic playback Procedure" on page 15.**

**In the same manner, overdub on tracks 3 and 4.**

## Mixdown (Track Down mode)

After all four tracks have been recorded, the next step is mixdown (Track Down mode).

Mixdown is the process of adjusting the sound volume and stereo image of what you recorded on tracks 1 - 4, and as a final process, mixing them to two channels (stereo) and dubbing (copying) it to a master recorder.

When you switch on the Track Down button, the X-34 enters Track Down mode.

You can use Track Down mode to play back a demo tape or recorded tape. In Track Down mode, all track sounds are routed to the corresponding channel level faders.



\* Before proceeding to the next step, set the X-34 to its "initial settings." (See page 9.)  
Make sure that the Track Down indicator is turned off.

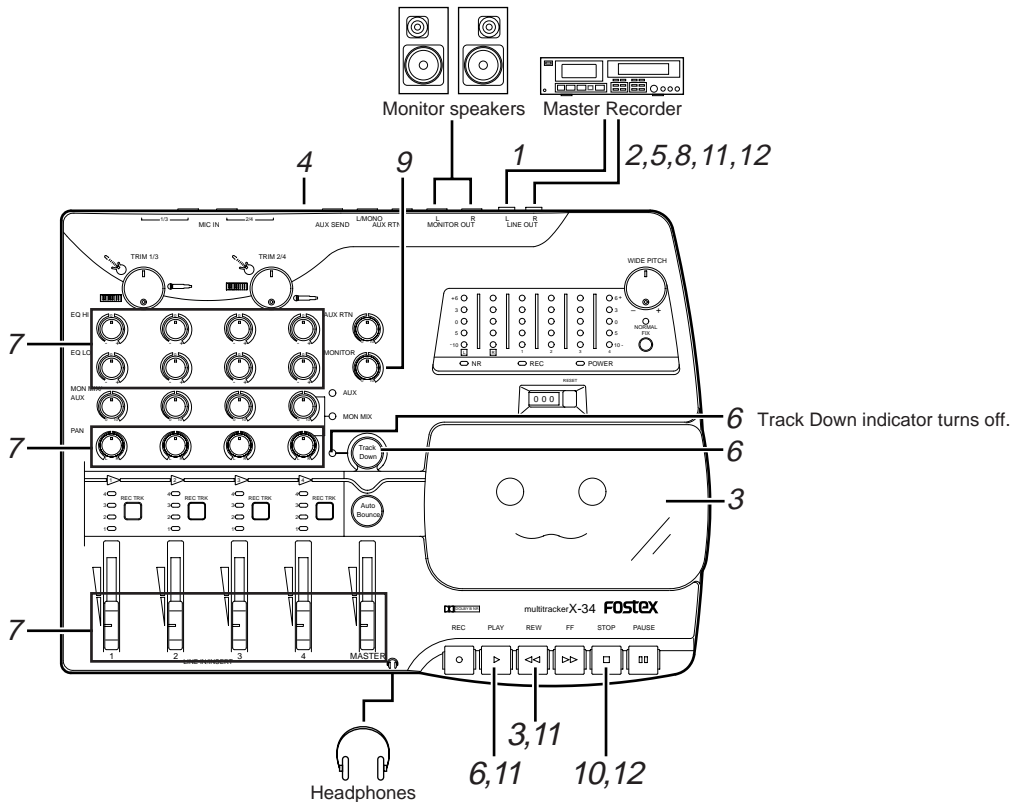

1. Connect the X-34 LINE OUT L, R jacks to the master recorder inputs (L, R).
2. Insert a tape in the master recorder and wind the tape to its start point.
3. Make sure that the overdubbed tape is inserted in the X-34, and wind to the beginning of the recorded tracks.
4. Switch ON Dolby B noise reduction.

### Adjust the Output Level/Recording Level

5. Set master recorder to record-standby.  
Typically, you will press the PAUSE button on the master recorder so that the master recorder level meters will respond. Because master recorders from different manufacturers work differently, please refer to the operating manual for the master recorder.
6. Press the X-34 Track Down button, then the PLAY button to play the tape from the beginning.  
The Track Down indicator lights up.
7. Use the channel faders to adjust the output level of each track (the level balance between tracks), and use the channel PAN knobs to adjust the left and right output balance, and the channel EQ knobs to adjust tonal color. Adjust the overall output level using the MASTER fader.
8. Adjust the recording level on the master recorder so that its level meter indicates the optimum level.

**<Note>**

There are no fixed rules for determining the playback sound image position of each track using the PAN knob at mixdown.  
This is where your creativity comes in. Try for a sound that pleases you!

- 9. You can adjust the headphone or monitor speaker volume using the MONITOR knob.
- 10. When you finish making these settings, rewind the tape to the beginning.

**Final Mixdown**

- 11. First place the master recorder in record mode, then press the PLAY button on the X-34.
- 12. When you finish the mixdown, stop both the X-34 and the master recorder.

**Advanced Operation**

In the "Basic Operation" section, you learned about the X-34's basic recording/playback and multitrack recording capabilities. This section explains "Punch in/out recording," "Ping-pong recording," "Tape sync" and "How to use the effects."

**Punch In/Out Recording**

"Punching in and out refers to recording "over" a section of an already-recorded tape. You can use this technique to fix mistakes or improve previously-recorded takes. Also, you can use the X-34's rehearsal mode to practice and adjust the recording level and the punch in/out timing before you actually record the take.

**<NOTE>**

To punch in, play the tape to the start of the section you want to re-record and, at a point between phrases and preferably on a beat, enter recording mode and record new material.  
The process of returning again to playback mode is called punching out.  
An optional foot switch (Fostex model 8051) is required to punch in and out on the X-34.

Punching in and out is illustrated below.

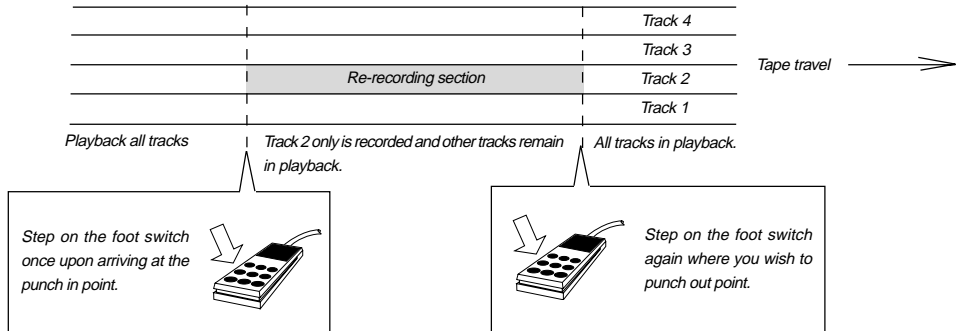

\* Before proceeding to the next step, set the X-34 to its "initial settings" as explained on page 9. Also, make sure that the Track Down indicator is turned off.

For example, part of the electric bass recorded on track 2 will be replaced during overdubbing. We assume that you have already loaded a prerecorded tape in the X-34 and rewound to the beginning of the recorded tracks.

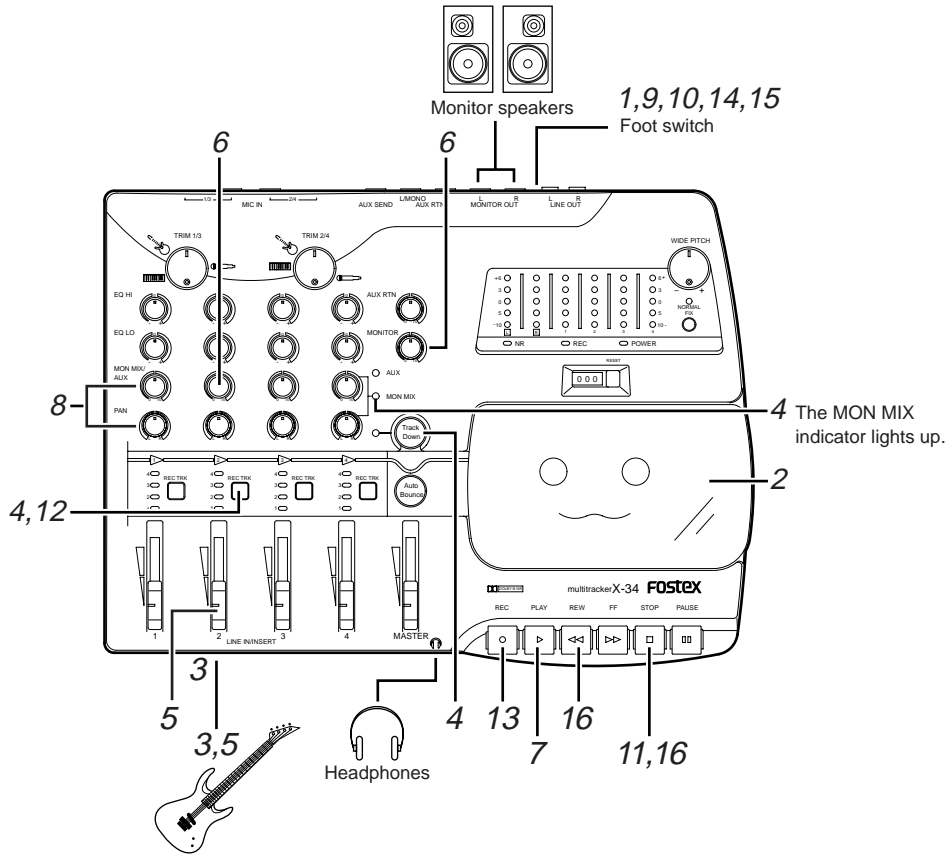

1. Plug the optional foot switch into the **PUNCH IN/OUT** jack.
  2. Advance the tape to a point just before where new material is to be inserted.
  3. Plug the electric bass into the front panel **LINE IN/INSERT** jack 2.
- Rehearsing the Punch In**
4. Make sure the **Track Down** indicator is turned off, then place track 2 in **REC READY** mode by pressing the **REC TRK** switch 2. The **REC TRK 2** indicator on channel 2 lights up, and the **REC** indicator flashes slowly.
  5. Raise the channel 2 input/playback level fader to adjust the recording level while you play the electric bass.
  6. You can adjust the overall headphones or monitor volume using the **MONITOR** knob and the channel 2 **MON MIX/AUX** knob.
  7. Press the **PLAY** button to start playback.
  8. Use the **MON MIX/AUX** and **PAN** knobs to adjust the output and stereo image for each track.
  9. Step on the foot switch when you reach the punch-in point and play your part. The **REC** indicator flashes faster. Only track 2 will enter input monitor mode. This means that you can hear the new bass part on track 2 along with the playback sound from other tracks.
  10. Step on the foot switch again when you wish to punch out. The **REC** indicator flashes more slowly, and the X-34 enters input monitoring mode.
  11. When you finish rehearsing, stop the transport by pressing the **STOP** button and rewind the tape. Because no recording takes place during rehearsal, repeat the process up to this point to set the recording level and get your playing technique down, and also practice the timing of the punch in and out. Punching in and out in tempo (on strong beats) can help camouflage the edit.

**Recording the Punch-in**

**12. Make sure that track 2 is in REC READY mode.**  
(If not, press the REC TRK switch on channel 2 to select track 2).

Record track indicator 2 on channel 2 lights up and the REC indicator flashes slowly.

**13. Press the REC button to start the tape from slightly before the punch-in point.**

The REC indicator flashes faster.  
It might be a good idea to play the bass in unison with the playback to get in sync for the punch in.

**14. Step on the foot switch at the punch in point.**

Track 2 will enter input monitor mode and recording mode (the REC indicator lights up continuously). The X-34 starts recording the electric bass on track 2. You can monitor your performance along with the playback from other tracks.

**15. Step on the foot switch again at the point you wish to punch out.**

The REC indicator again begins to flash fast. The recording mode will be canceled and all tracks will be in the playback mode.

**16. Upon completing the punch-in, press the STOP button to stop the transport, rewind the tape and listen to the results of your performance.**

**<NOTE>**  
Skill is required to match the newly replaced sound level to the pre-recorded sound.  
Try the following method:

1. While playing the track you want to punch in, adjust the input/playback level fader so that the meter indicates 0 - 3.
2. While rehearsing the new musical instrument, adjust the input/playback level fader so that the level meter lights up to the same degree as the playback tracks.

**Ping-pong Recording (Using the Auto Bounce Function)**

In a multitracker, the four tracks can be used effectively to record many sound sources. However, if you record on all four tracks, you may run out of tracks for other musical instruments or vocals. However, there is a method for clearing tracks to allow for more recording. In this method, called "ping-pong recording," playback sounds from a multiple number of recorded tracks are mixed and recorded to an empty track.

Ping-pong recording effectively lets you record a greater number of instruments or other sound sources.

**<For example, you can record six tracks using ping-pong recording shown in the schematic below>**

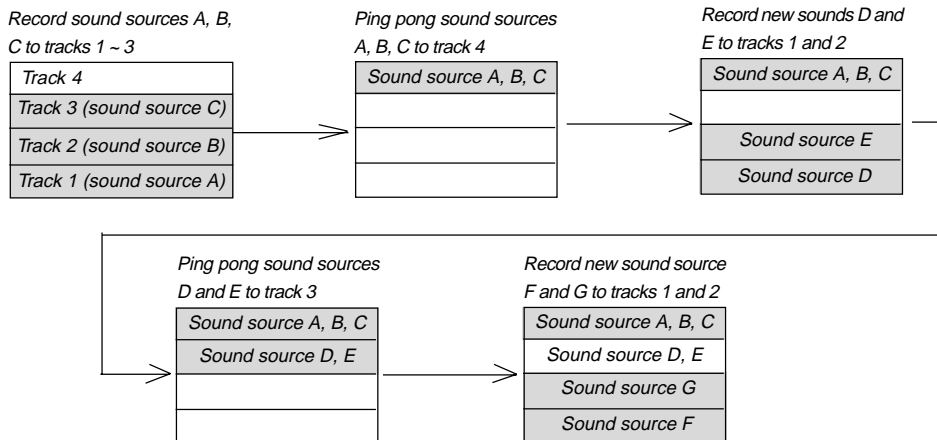

The X-34 utilizes an "Auto Bounce" ping-pong recording function.  
The Auto Bounce function can greatly simplify ping-pong recording.

Each time you press the Auto Bounce button, these indicators light up in the following order: 1 -> 2 -> 3 -> 4 -> OFF -> 1...

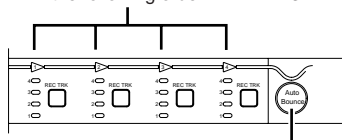

Use this button to turn Auto Bounce mode on or off. (Please note that this button is disabled if the Track Down indicator is on.)

**<Beware of oscillation during ping-pong recording>**

When you ping-pong record between adjacent tracks (such as from track 2 to track 1 or 3), oscillation may result if the gain control is raised too high. If this happens, immediately stop recording. If you are monitoring with headphones or an external monitor while the sound is oscillating, it could cause damage your hearing. After you stop recording, reduce the output (using the MON MIX/AUX knobs) to a suitable level, then resume recording. Also, avoid repeated ping-pong recording or the sound quality may deteriorate.

In this section, the sounds recorded on tracks 1 - 3 will mixed and ping-pong recorded to track 4.

\* Before proceeding to the next step, set the X-34 to its "initial settings" as explained on page 9. Also, make sure that the Track Down indicator is turned off.

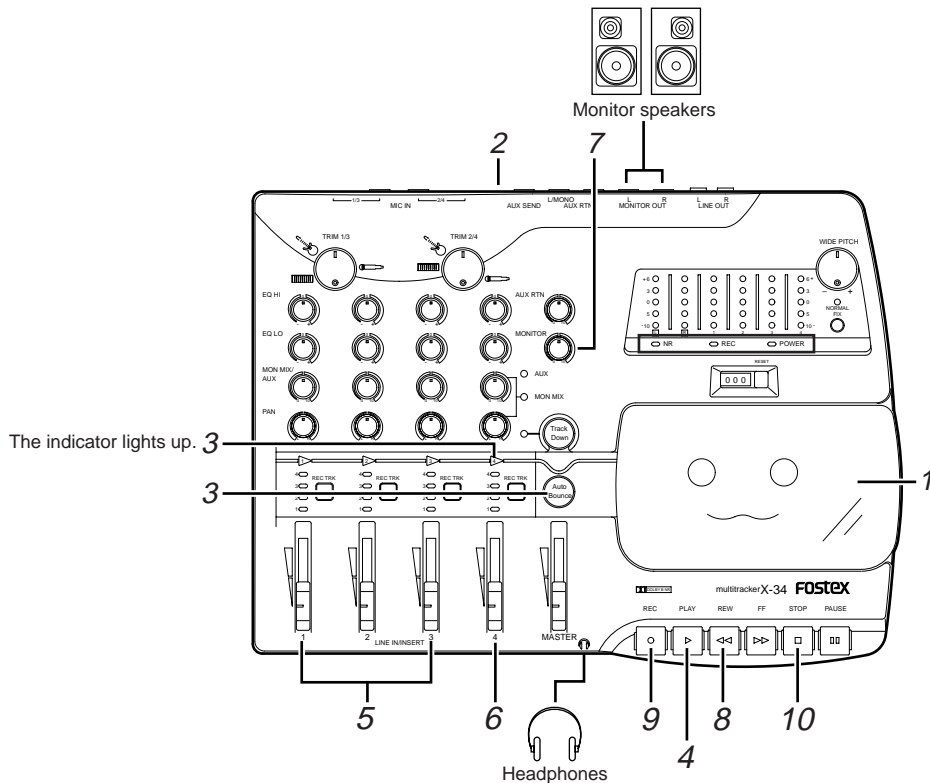

1. Insert the tape and rewind to the beginning of the recorded tracks.
2. Switch ON Dolby B noise reduction.
3. Press the Auto Bounce button repeatedly until the Auto Bounce indicator 4 lights up in green. Track 4 is now specified as the ping-pong destination.
4. Press the PLAY button to play back the tape.
5. Adjust tracks 1 -3 playback level using the channel 1 - 3 input/playback level faders.
6. Adjust the track 4 recording level using the channel 4 input/playback level fader.
7. Adjust the headphone or monitor volume using the MONITOR knob.
8. When you finish adjusting the recording level, rewind the tape to the beginning of the tracks.
9. Press the REC button to start recording. The REC indicator lights up.
10. When you finish ping-pong recording, stop the transport by pressing the STOP button.

**<Note>**

If you do not want to include a particular track in the Auto Bounce, lower its input fader to minimum.

Auto Bounce mode is canceled and Track Down mode is automatically selected. The REC indicator turns off. Rewind the tape and listen to the ping-pong recorded sound.

Subsequently, you can overdub new performances to tracks 1 - 3.

**<Monitoring>**

For monitoring, the PAN knob of the channel to which ping-pong is carried out is fully left (L) or right (R). The other channel PAN knobs are fully rotated in the opposite direction. Using these settings, you can separately monitor the sound of the ping-pong receiving channel (track 4 in this example) and the ping-pong source channels (tracks 1 - 3 in this example).

**<Notes on Auto Bounce recording>**

When Track Down is "ON," the Auto Bounce button is disabled. Also, if the Auto Bounce button is switched on and off while any one REC TRK switch is set to REC READY state, the selected REC TRK switch will be canceled. Also, pressing any REC TRK switch while Auto Bounce mode is "ON," will cancel Auto Bounce mode.

**Tape Sync**

Tape sync is a great function for synchronizing the automatic performance of a sequencer and drum machine (MIDI sound source) to a performance recorded on tape.

Here's why this function is so handy:

- 1) The number of tracks can be economized because automatic performances of MIDI equipment need not be recorded to tape.
- 2) Because the dynamic sound of an electronic musical instrument (synthesizer, drum machine, etc.) can be mixed down directly, you can obtain a higher quality sound.
- 3) Flexible editing, such as overdubbing an automated performance or replacing a drum machine track, is made possible.

**<NOTES>**

- \* In order to carry out tape sync, it is necessary to reserve track 4 for recording and playback of a sync signal called the "FSK signal." The FSK signal is a modulation into sound of the performance tempo information output from a sequencer or drum machine, called the "MIDI clock." This is one type of MIDI signal. A track recorded with this signal serves as the "conductor's baton," so to speak. When this signal is played back and sent to the sequencer or drum machine, the MIDI equipment starts performing in sync with the tempo of this signal.
- \* Some sequencers and drum machines cannot independently input or output FSK signals. When using this type of equipment, a MIDI/FSK converter is required. For details, please refer to the MIDI equipment operating manual.

**<IMPORTANT>**

After you record the FSK signal to track 4, be sure to de-select track 4 and completely retard the channel 4 fader before proceeding to mixdown.

## Recording a sync signal

1. Connect the FSK output of the MIDI/FSK converter to the LINE IN/INSERT 4 jack of the X-34, and connect a MIDI sequencer to the MIDI/FSK converter via MIDI.
2. Press the REC TRK 4 switch to select track 4 for recording.
3. Start playing the sequencer and adjust the recording level of sync signal using the channel 4 fader.
4. Stop the sequencer.
5. Press the REC button on the X-34 to start recording on track 4.
6. Start playing the MIDI sequencer.  
The sync signal will be recorded on track 4.  
It is recommended that you record the sync signal for a duration that exceeds the song. You cannot extend the sync signal recording later.

### <Tape Sync connection example>

Record other musical instruments first, then synchronize the MIDI sound source with the recordings to mix down the sound via the mixing console as shown below.

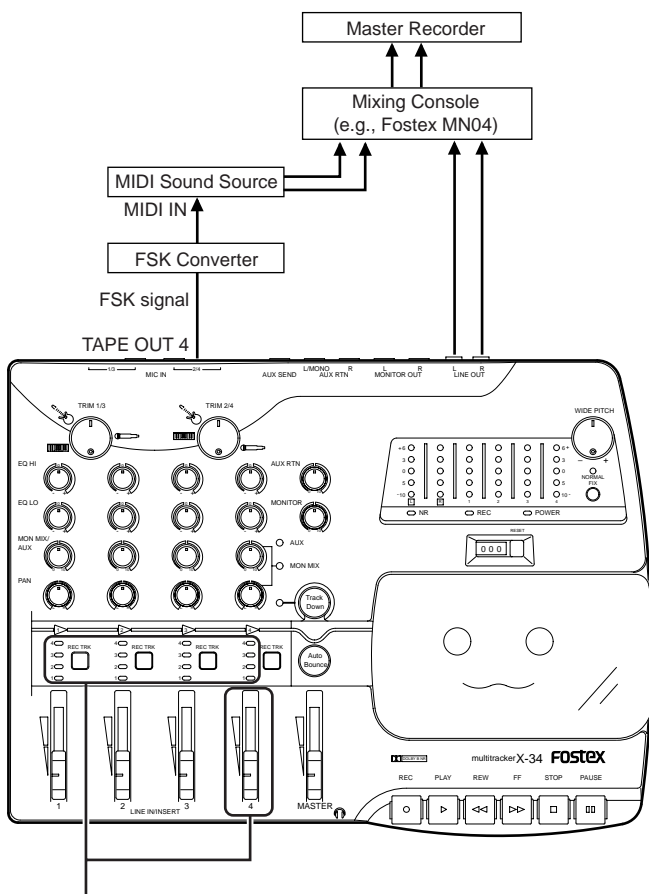

Before starting mixdown, lower the channel 4 fader to the minimum level and de-select all recording tracks.



## Applying Effects

You may apply effects to the X-34 signals during mixdown by connecting an external effects processor in line between the AUX SEND and AUX RTN connectors on the rear panel. The MON MIX/AUX knobs are used to adjust the amount of signal sent to the effects processor. The processed signals are returned to the X-34 via the AUX RTN connectors and mixed with the dry (no effect) sound. After adjusting the balance between the dry and wet sounds (using the AUX RTN knob), you can mix down to a connected master recorder.

You can also perform effect processing by connecting different effects, such as a compressor, limiter, noise gate, etc., to the LINE IN/INSERT jacks on the front panel during recording.

Choose the approach that suits your project.

### Using the AUX SEND and AUX RTN connectors to apply effects at mixdown:

In this example, while mixing the sound sources recorded on tracks 1 ~ 4 and copying (dubbing) the mix to a master recorder, you apply effects to the desired track.

In this example, reverb is applied to tracks 2 and 4.

Be aware that if you want to add effects to individual tracks, you must add them during the mixdown process. You will be able to add an effect to the entire recording later if you wish. However, you will not be able to add an effect to a specific track; individual tracks will be inaccessible.

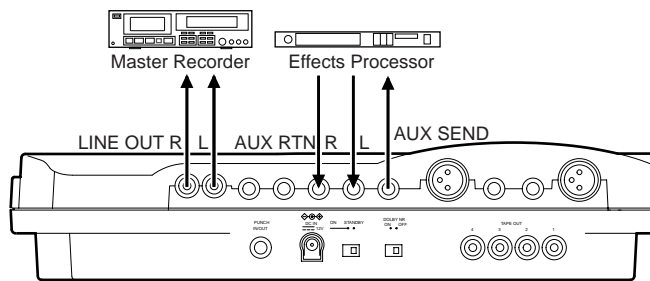

1. Connect the input of an external effects processor to the AUX SEND connector on the rear panel of the X-34.
2. Connect the outputs of the external effects processor to the AUX RTN connectors (L/MONO, R) on the rear panel of the X-34.
3. Set up the master recorder and the X-34 for mixdown rehearsal as described in steps 1-7 of the "Mixdown" section on page 18.
4. Play the tape and turn the MON MIX/AUX knobs on channel 2 and 4 clockwise to adjust the level of signals sent to the effects processor.
5. Set the parameters of the external effects processor, if necessary.
6. Use the AUX RTN knob to adjust the level of the effect signals.
7. Adjust the monitoring level using the MONITOR knob.
8. Adjust the entire output level using the MASTER fader.  
Refer to page 18 for more information on the mixdown steps.
9. If the level settings are satisfactory, rewind the tape.
10. Start recording on the master recorder, and start playing the tape on the X-34 to mixdown.

**Applying a compressor/limiter to the mic input during overdubbing!**

Using the X-34 insert (LINE IN/INSERT) jack on the front panel, you can apply a compressor/limiter to the mic sound (vocal) input to the rear panel MIC IN jack (1/4" or XLR).

The INSERT jack accepts a TRS (tip, ring, sleeve) 1/4" connector for bi-directional connection. The tip sends out the X-34 signal to the effects unit, and the ring inputs the processed signal from the effects unit to the X-34. This connection requires a special insert cable as shown in the figure below.

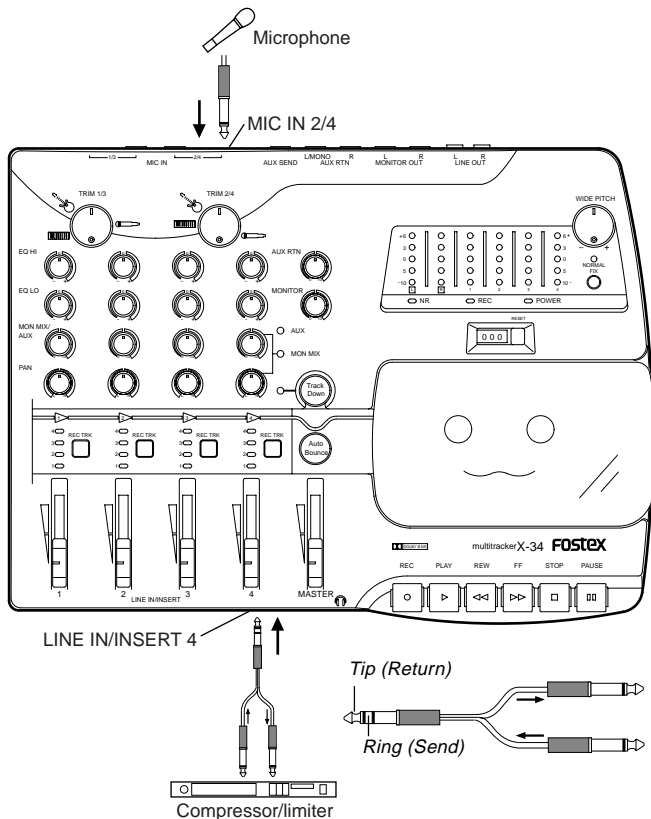

In this example, a microphone is plugged into the MIC IN jack 2/4 and a vocal is recorded to track 4.

1. Connect the microphone to one of the MIC IN jacks 2/4 (1/4" or XLR) on the rear panel of the X-34.
2. Connect the input/output of the compressor/limiter to the insert jack 4 as shown in the drawing.
3. Press the REC TRK switch on channel 4 once to select track 4 as the recording track.
4. While talking into the microphone, adjust the recording level using the Trim 2/4 knob until segments 0 - 3 on the level meter light up.
5. Adjust the effect signal on the compressor/limiter. Refer to the manual for the compressor/limiter for detailed effect settings.
6. Follow the instructions on page 16 for overdubbing. In this way, you can apply the compressor/limiter to only the vocal recorded to track 4.

## Troubleshooting

	<b>Problem</b>	<b>Points to check</b>	<b>Action</b>
<b>Sound trouble</b>	Wow, flutter, or dropouts	Are the capstan and pinch roller dirty?	Clean them.
		Is the tape damaged?	Use a new high-quality tape.
	Sound quality and level significantly different from when recorded.	Is the head dirty?	Clean the head.
		Are you using a tape other than a high-position tape?	Use a high-position tape (Type 2)
	No sound from the headphones or monitor speakers	Are the MON MIX/AUX knobs for each track and the MONITOR knob raised sufficiently?	Raise the knobs to the desired level.
<b>Recording trouble</b>	Unable to record on the desired track.	Have you selected the correct track using the REC TRK switch?	Check the input connection and recording track selection. Refer to pages xxx and xxx.
	Unable to ping-pong record.	Have you specified the ping-pong destination track using the Auto Bounce button?	Specify the destination track for ping-pong recording using the Auto Bounce button.
	Unable to select a recording track using the REC TRK switch.	Is the Track Down button turned on?	Make sure the Track Down mode is turned off. If not, press the Track Down button to turn off the Track Down indicator.
	Unable to apply effects during mixdown.	Are the channel fader, MON MIX/AUX knobs, and AUX RTN knob raised?	Raise the channel fader, MON MIX/AUX knobs, and AUX RTN knob to appropriate levels.
<b>Others</b>	Tape does not transport.	Is the cassette tape installed correctly?	Insert the tape correctly.
	Power is not turned on.	Is the AC adapter connected correctly?	Connect the AC adapter correctly.
	The MIDI sequencer does not synchronize with the X-34.	Is the FSK/MIDI converter set so that it will convert the sync signal recorded on track 4 to MIDI clock?	Check the FSK/MIDI converter setting.
		Is the MIDI sequencer set up so that it will synchronize with incoming clock?	Refer to the MIDI sequencer manual and check the setting.

## Maintenance

### 1. Cleaning the exterior

\* **For normal cleaning, use a soft dry cloth.**

For stubborn dirt, moisten a cloth in diluted detergent, wring it out firmly, and wipe off the dirt. Then wipe down the unit with a dry cloth.

Never use solvents such as alcohol, thinner or benzene, since these will damage the printing and finish of the exterior.

### 2. Cleaning the head, roller and capstan

\* **Record/playback head**

As the X-34 is used, the record/playback head will become coated with oxide residue from tapes. If this residue is allowed to build up, recordings will contain more noise, and dropouts may occur during playback. To prevent this, regular cleaning is important. Use a commercial cleaning kit to clean the head. If cleaning the head does not restore the sound quality, it is possible that the head is worn. Contact an authorized service station for repair.

\* **Capstan and pinch roller**

The capstan and pinch roller are important components that hold the tape and move it along at the correct speed. As with the head, these parts can also become dirty with oxide residue and dust, which will cause increased wow or flutter, or even damage the tape by pulling it out of the cassette. Since cassette tape is very thin, it is especially dangerous to use a cassette deck with dirty pinch rollers. As with the head, it is important to always keep these parts clean. Clean them using a cotton swab or gauze soaked in cleaning solution or isopropyl alcohol. Never use organic solvents such as lacquer thinner, since this will severely damage the pinch rollers.

### 3. Demagnetizing the head

After long periods of use, the head begins to develop a magnetic field in addition to the oxide residue described above. This can also occur if a magnet or a magnetized object (scissors, etc.) is allowed to come near the head or touch it. If the head or capstans become magnetized, frequency response will be degraded and noise will increase. In extreme cases, noise can be generated when you play previously-recorded tapes, rendering them useless.

Once a month or so, you should use a demagnetizer (head eraser) to demagnetize the head. Carefully read and follow the instructions included with your demagnetizer, and do not allow it to come near recorded tapes.

## Block Diagram

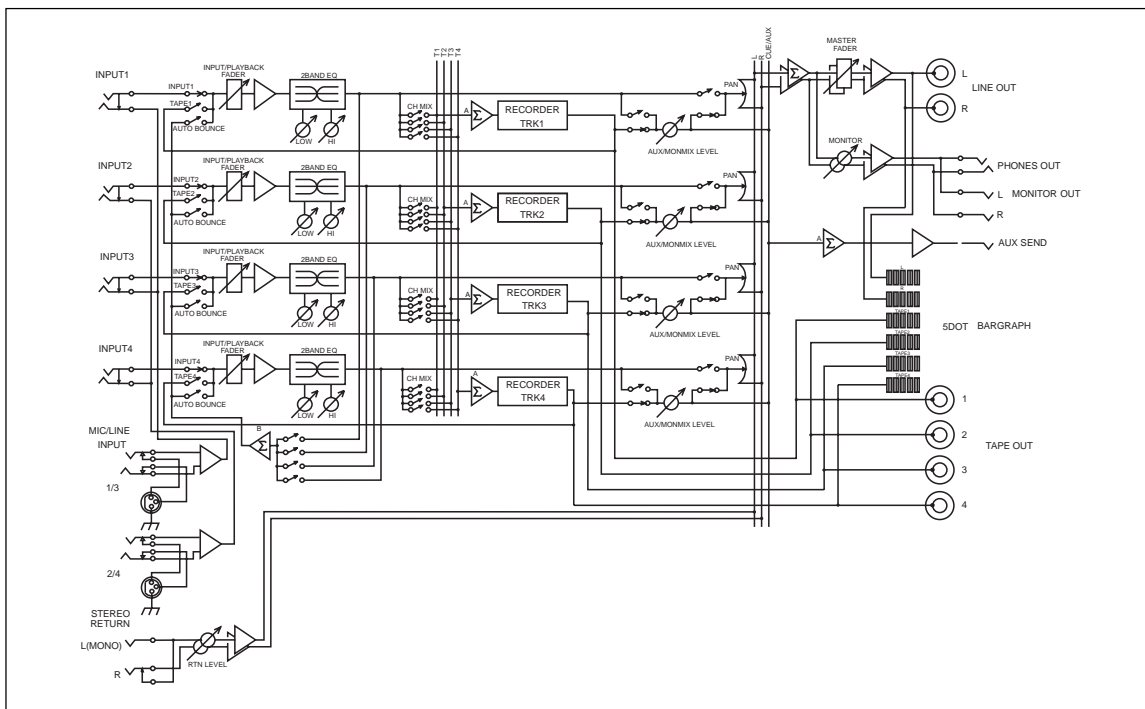

## Specifications

### MIC INPUT (x 2)

Connector	: XLR type connector (Balanced)
	: $\varnothing$ 6 PHONE jack (Unbalanced)
Input impedance	: 10k $\Omega$ or higher
Reference input level	: -50 ~ -10dBV

### LINE/INSERT (x 4)

#### When using the LINE IN jack:

Connector	: $\varnothing$ 6 PHONE jack
Input impedance	: 10k $\Omega$ or higher
Reference input level	: -10dBV

#### When using the INSERT jack:

Connector	: $\varnothing$ 6 STEREO PHONE jack (Tip :Return, Ring :Send)
-----------	--

### AUX RTN (L/MONO, R)

Connector	: $\varnothing$ 6 PHONE jack
Input impedance	: 7k $\Omega$ or higher
Reference input level	: -20dBV

### LINE OUT (L, R)

Connector	: RCA pin jack
Output load impedance	: 10k $\Omega$ or higher
Reference output level	: -10dBV

### TAPE OUT (x 4)

Connector	: RCA pin jack
Output load impedance	: 10k $\Omega$ or higher
Reference output level	: -10dBV

### PHONES

Connector	: $\varnothing$ 6 STEREO PHONE jack
Output load impedance	: 16 $\Omega$ or higher
Maximum output	: 20mW (at 32 $\Omega$ )

### AUX SEND

Connector	: $\varnothing$ 6 PHONE jack
Output load impedance	: 10k $\Omega$ or higher
Reference output level	: -10dBV

### MONITOR OUT (L/R)

Connector	: $\varnothing$ 6 PHONE jack
Output load impedance	: 10k $\Omega$ or higher
Reference output level	: -10dBV

**Recording Tape** : C-90 (TYPE-2 or HIGH position) or shorter

**Record tracks** : 4 tracks, one direction

**Tape speed** : 9.5 cm/s, 4.75cm/s

**Pitch control** : -50% - +12%

**Noise Reduction** : Dolby B noise reduction system

**EQ** : 2-band, shelving  
+/-12(HI : 10kHz, LO : 100Hz)

**Tape rewinding time** : 150 seconds (when a C-60 tape is used)

**Frequency response** : Mixer section; 20Hz ~ 20kHz  
Recorder section; 40Hz ~ 14kHz

**Heads** : 4-tracks, 4-channel recording/  
playback 4-tracks, 4-channel erase

**Power supply** : Fostex AC adapter, AD-12C  
DC 12V (12 ~ 16V), 11W

**Weight** : Approx. 1.7 kg (excluding the AC adapter)

**Dimensions** : 335 (W) x 75 (H) x 247(D) mm

\* Specifications and appearance are subject to change without notice for purpose of product improvement.

\* Dolby Noise Reduction is manufactured under license from Dolby Laboratories Licensing Corporation.

\* Dolby and the double-D symbol are trademarks of Dolby Laboratories Licensing Corporation.

### Declaration of EC Directive

This equipment is compatible with the EMC Directive (89/336/EEC) – Directive on approximation of member nation's ordinance concerning the electromagnetic compatibility and with the Low Voltage Directive (73/23/EEC) – Directive on approximation of member nation's ordinance concerning electric equipment designed to be used within the specified voltage range.

### The Affect of Immunity on This Equipment

The affect of the European specification EN50082-1 (coexistence of electromagnetic waves - common immunity specification) on this equipment are as shown below.

\* In the electrical fast transient / burst requirements, surge, conducted disturbances by radio-frequency fields, power frequency magnetic field, radiated electromagnetic field requirements and static electricity discharging environment, this could be affected by generation of noise in some cases.

### FOSTEX DISTRIBUTORS LIST IN EUROPE

\*Including non - EU countries. \* underlined: contracted distributors (as of August, 2000)

#### <AUSTRIA>

NAME: ATEC Audio-u. Videogeræte VertriebsgesmbH.

ADD: Im Winkel 5, A-2325 Velm, Austria

TEL: (+43) 2234-74004, FAX: (+43) 2234-74074

#### <BELGIUM>

NAME: EML Sound Industries NV

ADD: Bijvennestraat 1A, B3500 Hasselt, Belgium

TEL: (+32) 11-232355, FAX: (+32) 11-232172

#### <DENMARK>

NAME: SC Sound ApS

ADD: Malervej 2, DK-2630 Taastrup, Denmark

TEL: (+45) 4399-8877, FAX: (+45) 4399-8077

#### <FINLAND>

NAME: Noretron Oy Audio

ADD: P.O. Box 22, FIN-02631 Espoo, Finland

TEL: (+358) 9-5259330, FAX: (+358) 9-52593352

#### <FRANCE>

NAME: Musikengro

ADD: ZAC de Follieuses, B. P. 609, 01706 Les Echets, France

TEL: (+33) 472 26 27 00, FAX: (+33) 472 26 27 01

#### <GERMANY>

NAME: Studiosound & Music GmbH

ADD: Industriestrasse 20, D-35041 Marburg, F.R.Germany

TEL: (+49) 6421-92510, FAX: (+49) 6421-925119

#### <GREECE>

NAME: Bon Studio S. A.

ADD: 6 Zaimi Street, Exarchia, 106.83 Athens, Greece

TEL: (+30) 1-3809605-8, 3302059, FAX: (+30) 1-3845755

#### <ICELAND>

NAME: I. D. elrf. electronic Ltd.

ADD: Armula 38 108 Reykjavik, Iceland

TEL: (+354) 588 5010, FAX: (+354) 588 5011

#### <ITALY>

NAME: Recoton Italia Srl.

ADD: V. I Maggio, N 18, 40050 Quarto Inferiore, (BO) Italy

TEL: (+39) 051-768576, FAX: (+39) 051-768336

#### <THE NETHERLANDS>

NAME: IEMKE ROOS AUDIO B. V.

ADD: Kuiperbergweg 20, 1101 AG Amsterdam, The Netherlands

TEL: (+31) 20-697-2121, FAX: (+31) 20-697-4201

#### <NORWAY>

NAME: Siv. Ing. Benum A/S

ADD: P. O. Box 145 Vinderen, 0319 Oslo 3, Norway

TEL: (+47) 22-139900, FAX: (+47) 22-148259

#### <PORTUGAL>

NAME: Caius - Tecnologias Audio e Musica, Lda.

ADD: Rua de Santa Catarina, 131 4000 Porto, Portugal

TEL: (+351) 2-2086009/2001394

FAX: (+351) 2-2054760/2087488

#### <SPAIN>

NAME: Multitracker S. A.

ADD: C/Garcilaso No. 9, Madrid 28010, Spain

TEL: (+34) 91-4470700, 91-4470898

FAX: (+34) 91-5930716

#### <SWEDEN>

NAME: Professional Television AB

ADD: Kavallerivagen 24, 172 48 Sundbyberg, Sweden

TEL: (+46) 8-59798000, FAX: (+46) 8-59798001

#### <SWITZERLAND>

NAME: Audio Bauer Pro AG

ADD: Bernerstrasse-Nord 182, CH-8064 Zurich, Switzerland

TEL: (+41) 1-4323230, FAX: (+41) 1-4326558

#### <UK>

NAME: SCV London

ADD: 3A 6-24 Southgate Road, London N1 3JJ, England, UK

TEL: (+44) 171-923-1892, FAX: (+44) 171-241-3644

## Free Manuals Download Website

<http://myh66.com>

<http://usermanuals.us>

<http://www.somanuals.com>

<http://www.4manuals.cc>

<http://www.manual-lib.com>

<http://www.404manual.com>

<http://www.luxmanual.com>

<http://aubethermostatmanual.com>

Golf course search by state

<http://golfingnear.com>

Email search by domain

<http://emailbydomain.com>

Auto manuals search

<http://auto.somanuals.com>

TV manuals search

<http://tv.somanuals.com>