

# Owner's Manual

# Model XR-3

## MULTITRACKER

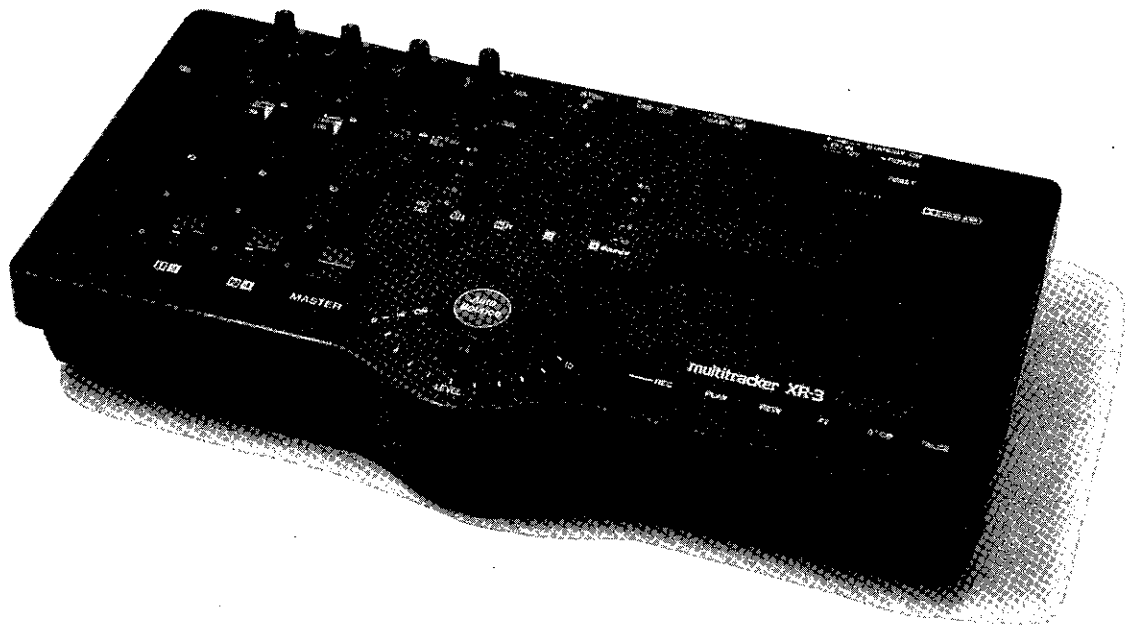

# Fostex®

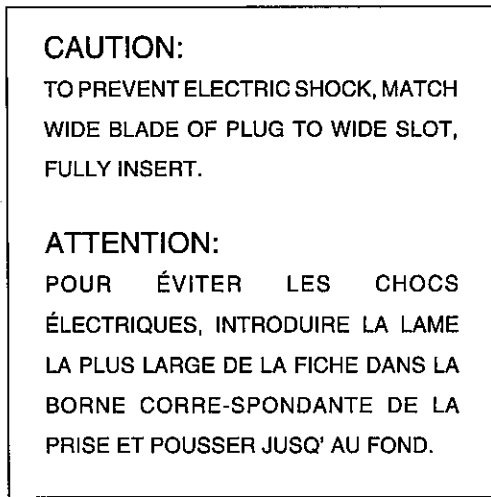
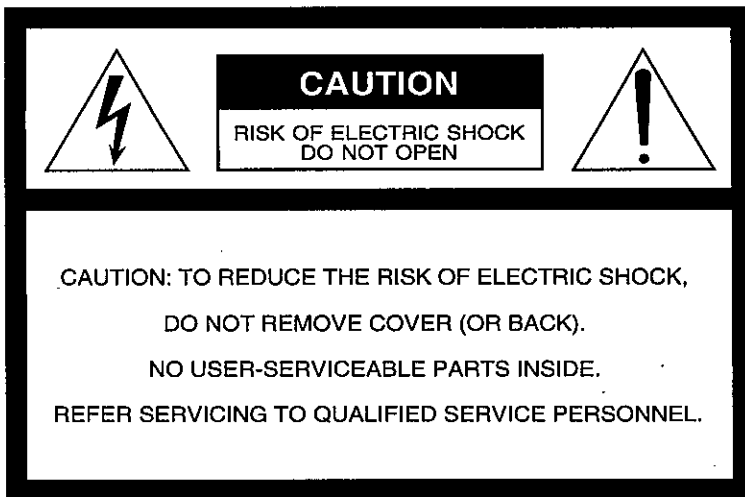

The lightning flash with the arrowhead symbol, within an equilateral triangle, is intended to alert the user to the presence of uninsulated "dangerous voltage" within the product's enclosure that may be of sufficient magnitude to constitute a risk of electric shock to persons.



The exclamation point within an equilateral triangle is intended to alert the user to the presence of important operating and maintenance (servicing) instructions in the literature accompanying the appliance.

**"WARNING"**

"TO REDUCE THE RISK OF FIRE OR ELECTRIC SHOCK, DO NOT EXPOSE THIS APPLIANCE TO RAIN OR MOISTURE."

**SAFETY INSTRUCTIONS**

1. Read Instructions – All the safety and operating instructions should be read before the appliance is operated.
2. Retain Instructions – The safety and operating instructions should be retained for future reference.
3. Heed Warnings – All warnings on the appliance and in the operating instructions should be adhered to.
4. Follow Instructions – All operating and use instructions should be followed.
5. Water and Moisture – The appliance should not be used near water – for example, near a bathtub, washbowl, kitchen sink, laundry tub, in a wet basement, or near a swimming pool, and the like.
6. Carts and Stands – The appliance should be used only with a cart or stand that is recommended by the manufacturer.



A appliance and cart combination should be moved with care. Quick stops, excessive force, and uneven surfaces may cause the appliance and cart combination to overturn.

7. Wall or Ceiling Mounting – The appliance should be mounted to a wall or ceiling only as recommended by the manufacturer.
8. Ventilation – The appliance should be situated so that its location or position does not interfere with its proper ventilation. For example, the appliance should not be situated on a bed, sofa, rug, or similar surface that may block the ventilation openings; or placed in a built-in installation, such as a bookcase or, cabinet that may impede the flow of air through the ventilation openings.

9. Heat – The appliance should be situated away from heat sources such as radiators, heat registers, stoves, or other appliances (including amplifiers) that produce heat.
10. Power Sources – The appliance should be connected to a power supply only of the type described in the operating instructions or as marked on the appliance.
11. Grounding or Polarization – The precautions that should be taken so that the grounding or polarization means of an appliance is not defeated.
12. Power Cord Protection – Power supply cords should be routed so that they are not likely to be walked on or pinched by items placed upon or against them, paying particular attention to cords at plugs, convenience receptacles, and the point where they exit from the appliance.
13. Cleaning – The appliance should be cleaned only as recommended by the manufacturer.
14. Nonuse Periods – The power cord of the appliance should be unplugged from the outlet when left unused for a long period of time.
15. Object and Liquid Entry – Care should be taken so that objects do not fall and liquids are not spilled into the enclosure through openings.
16. Damage Requiring Service – The appliance should be serviced by qualified service personnel when:
  - A. The power supply cord or the plug has been damaged; or
  - B. Objects have fallen, or liquid has been spilled into the appliance; or
  - C. The appliance has been exposed to rain; or
  - D. The appliance does not appear to operate normally or exhibits a marked change in performance; or
  - E. The appliance has been dropped, or the enclosure damaged.
17. Servicing – The user should not attempt to service the appliance beyond that described in the operating instructions. All other servicing should be referred to qualified service personnel.

# Introduction

Thank you for purchasing the Fostex XR-3.

The XR-3 has two inputs for line level and mic level (switching type), and offers four tracks and four channels with a non-directional built-in microphone. The XR-3 has been designed in such a way that even first-time users can easily perform multi-track recording, thanks to the minimal number of controls and the user-friendly panel indicators.

The XR-3 uses a tape speed of 9.5cm/s, making it the first double-speed system in this class of multi-trackers. Dolby B noise reduction makes higher-quality recordings possible. In addition, our own "Auto-bounce" function has made ping-pong recording much easier.

We hope you will enjoy and make the best use of the Fostex XR-3, which allows for "Quick & Take" recording. Read this instruction manual thoroughly before using the product in order to understand the XR-3's operations and to extend the useful life of the product.

## Table of Contents

### Precautions

About the power source .....	3
Installation .....	3

### CHAPTER 1. Precautions

Using a cassette tape .....	4
Multitrack recording .....	4
The difference between a track and a channel .....	4
Tape and tape speed .....	5

### CHAPTER 2. Control panel and front and rear panels

Control panel .....	7
Front panel .....	10
Rear panel .....	10

### CHAPTER 3. Basic Connection .....

### CHAPTER 4. Basic Guide "Let's Start Recording"

Initial setting of the XR-3 .....	12
Recording a musical instrument .....	13
Listening to the recorded sound .....	15
Recording with the internal microphone .....	16
Recording a vocal while listening to a recorded guitar sound ...	17
Listening to the recorded tracks .....	19
Mixdown .....	20

### CHAPTER 5. Application Guide

Punch In/Out Recording .....	22
Ping-pong recording (Auto-bounce function) .....	24
Tape Sync .....	26
Troubleshooting .....	27
Maintenance .....	28
Specifications .....	29
Block Diagram .....	30

## Precautions (Be sure to read this page before using the XR-3.)

### About the power source

- Connect the AC adaptor of the XR-3 to a domestic AC120V or 230V outlet.
- If you are using the product in an area where the power voltage is different from the specified voltage, consult the store where you purchased this product or the nearest your authorized service stations.
- Be sure to hold the main adaptor unit when removing it from an AC outlet. Pulling the cord may cause a short circuit or other malfunction.
- It is dangerous to use a frayed or worn cord. If the cord is damaged, stop using the product and have the cord repaired.
- Do not touch the AC adaptor with a wet hand. Otherwise, you may receive a dangerous electrical shock may be caused.
- Do not remove the cover of the main unit and AC adaptor, nor touch the inside of them. Otherwise, a dangerous electrical shock or malfunction may be caused. Should any liquid, flammable object, or metal (such as a pin) get inside, it may lead to a dangerous electrical shock or malfunction. Should any of these foreign objects get inside, remove the AC adaptor from the AC outlet and contact the store where you purchased this product, or the nearest your authorized service stations.
- First, make sure that all devices connected to the XR-3 are turned off, then turn the power on to the XR-3. In this way, you can avoid damage to the connected devices. When you are connecting or removing the cables from the inputs or outputs of the XR-3, first make sure that the level of the input faders or volume controls of the connected channels is set to "0."
- Even when you turn the power switch off (STANDBY) while the AC adaptor is connected, a small current always flows through the AC adaptor. Therefore, be sure to remove the AC adaptor when you are not going use the XR-3 for an extended period of time.
- For safety, be sure to use the dedicated AC adaptor that comes with the XR-3.

### Installation

- Do not subject the product to the following circumstances:
  - \* Extremely high or low temperatures, significant changes in temperature
  - \* Extreme humidity, or dusty conditions
  - \* Direct sunlight, or beside a heat-generating object such as a heater
  - \* Changes in the power voltage
  - \* Near a strong magnetic field (such as a TV or speakers)

## Precautions

Before using the XR-3, it is a good idea to understand the differences between a radio/cassette tape recorder that you might be accustomed to using (commonly called a "boom box") and a multitracker (abbreviated here as MTR).

### Using a cassette tape

Both a boom box and an MTR have four tracks for recording. However, the same cassette tape would be recorded differently, as shown in the following diagrams.

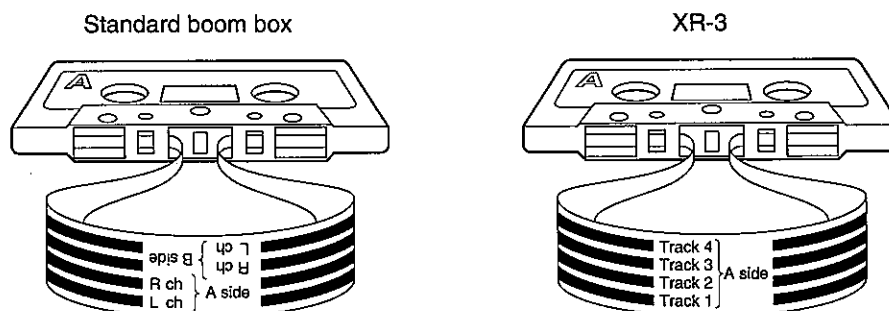

On the standard boom box, both the A side and B side of the tape can be used to record four tracks, as shown in the diagram. You need to flip the tape over to record the other side. On the contrary, the MTR uses either the A or B side of the tape to record four tracks. That is, you never flip the tape over.

### Multitrack recording

As explained in the previous paragraph, a boom box usually records data on each side of the tape in stereo (L, R).

On the other hand, you can record four tracks individually, or two tracks simultaneously, on the XR-3. In this way, you can record many different musical instruments on different tracks.

In addition, you can record a new sound on an empty track, while listening to sounds already recorded on the other track(s). (This operation is called "overdubbing." You can also mix multiple tracks while recording to another track. (This operation is called "ping-pong recording.") In this way, the MTR allows you to perform various recording techniques.

### The difference between a track and a channel

"Track" and "channel" are sometimes used to mean the same thing. However, in this manual, these are differentiated as follows:

The word "channel" is mainly used for mixer inputs/outputs, and the word "track" is used for recorder (tape) inputs/outputs.

For example, we might say, "recording the sound of the guitar connected to Channel 1 onto Track 1." The XR-3 has two inputs: Channel 1 and Channel 2. It also has four tracks for recording and playback: Tracks 1, 2, 3, and 4.

## Tape and tape speed

The XR-3 has been designed to use a high-position (CrO<sub>2</sub>, TYPE II) cassette tape, such as the Maxell XL-II or the TDK SA series, for best performance. We recommend that you use one of these tapes, or an equivalent.

The XR-3 also runs a tape at double speed (9.5cm/s), which is twice the speed of a standard boom box (4.75cm/s) for improved recording quality. Therefore, if you try to play back a tape that was recorded on the XR-3 on a boom box, it will not play back correctly because of the difference in the tape speed. If you wish to listen to an XR-3 tape on a boom box, first you need to dub the sounds to a master recorder (such as your boom box) using the XR-3's mixdown function. (Refer to page 20 for mixdown.)

The time duration you can record on a tape using the XR-3 varies depending on the type of tape, as follows:

Tape type	Recording time (one side)	
	Boom box	XR-3
C-30	Approx. 15 min.	Approx. 7.5 min.
C-46	Approx. 23 min.	Approx. 11.5 min.
C-60	Approx. 30 min.	Approx. 15 min.
C-90	Approx. 45 min.	Approx. 22.5 min.
C-120	Approx. 60 min.	Approx. 30 min.

**Note:**

Do not use a C-120 tape. This tape is very thin, and may easily become tangled or cut on the MTR, on which you are likely to repeat various operations in a session. We recommend that you use a C-90 or shorter tape.

Now, you understand some differences between the MTR and a boom box. In the next paragraph, we will explain the function of the XR-3's controls and switches so that you will can prepare to use the XR-3.

# Control panel and front and rear panels

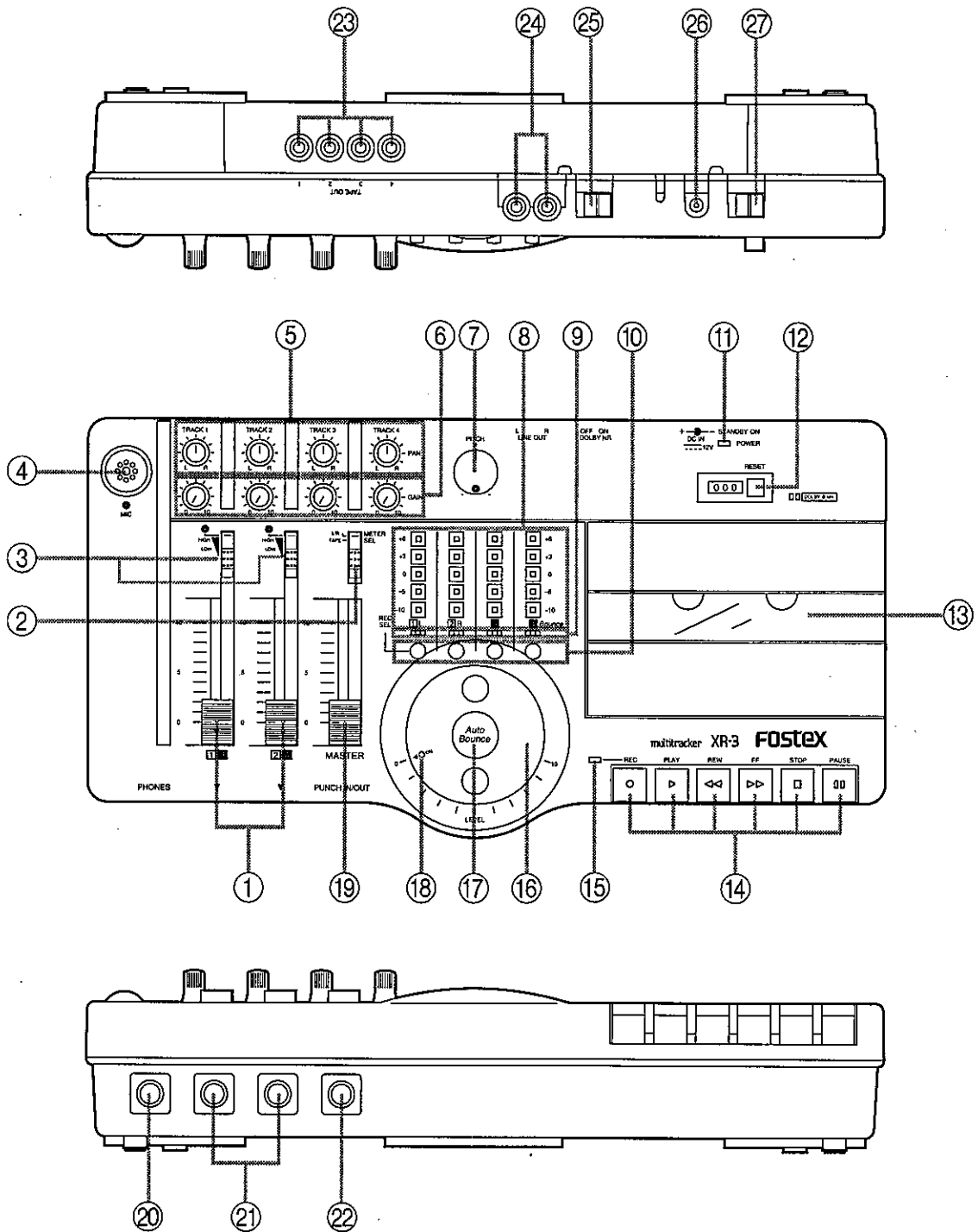

The words in square brackets [ ] refer to the printing on the front and rear panel.

## Control panel

### ① Input fader [1 3, 2 4]

This fader allows you to adjust the recording level of the musical instruments or external microphones connected to the Channel 1, 2 INPUT jacks, or the recording level of the internal microphone. Raising the fader will increase the recording level.

The optimum recording level is position 7–8, at which the Level Meter will light up.

### ② Meter Select switch [METER SEL L/R/TAPE]

This switch allows you to select the signal whose level is shown on the Level Meter.

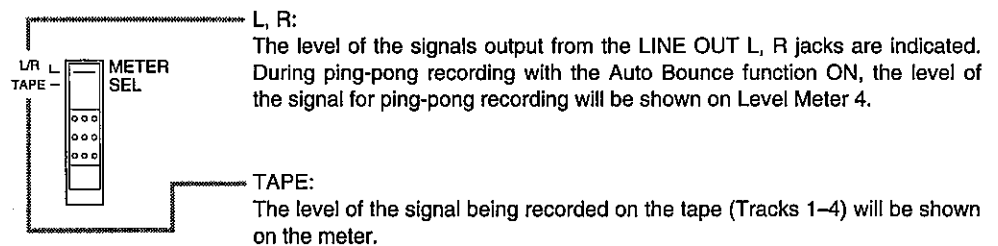

### ③ Input level/internal microphone switch

This switch is used to select an appropriate level according to the output level of the instruments (musical instruments and microphones) connected to the INPUT jacks and the internal microphone, as follows:

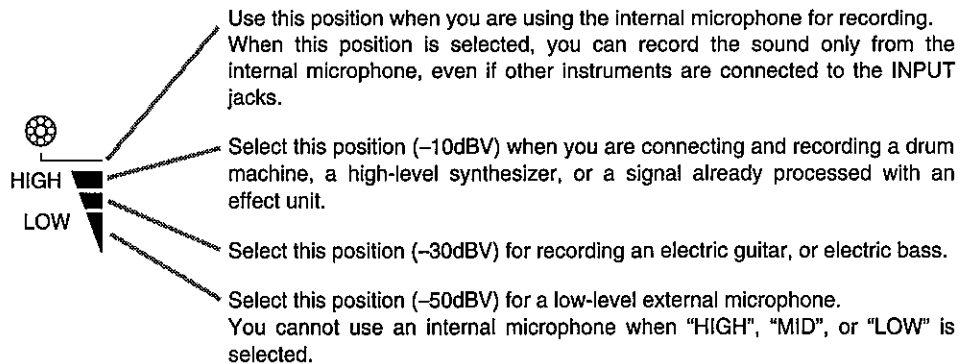

#### Note:

When using this switch, be sure to lower the corresponding channel INPUT fader to the lowest position.

### ④ Internal microphone (non-directional) [MIC]

When you are recording data using this microphone, turn the Input switch to "MIC." (In this case, the internal microphone has priority, and you cannot record the instruments or external microphones connected to the INPUT jacks.)

### ⑤ Panpot knob [PAN]

This knob allows you to adjust the position of the stereo image of each track for mixdown, or for when you are monitoring the sound by playing back the tape. Rotate the knob to the desired position.

### ⑥ Gain control [GAIN]

This knob allows you to adjust the playback level of the tape (Tracks 1–4).

For example, adjust this control knob to the optimum volume level to listen to the already recorded track during overdubbing.

### ⑦ Pitch control [PITCH]

This knob changes the tape speed in the range of  $\pm 10\%$ . Usually, set this knob to the center position "0" (normal speed - 9.5cm/s). Rotating the knob toward "-" decreases the speed, and rotating it toward "+" increases the speed.

**⑧ Level Meter**

This meter displays the level of the signal selected via the METER SEL switch.

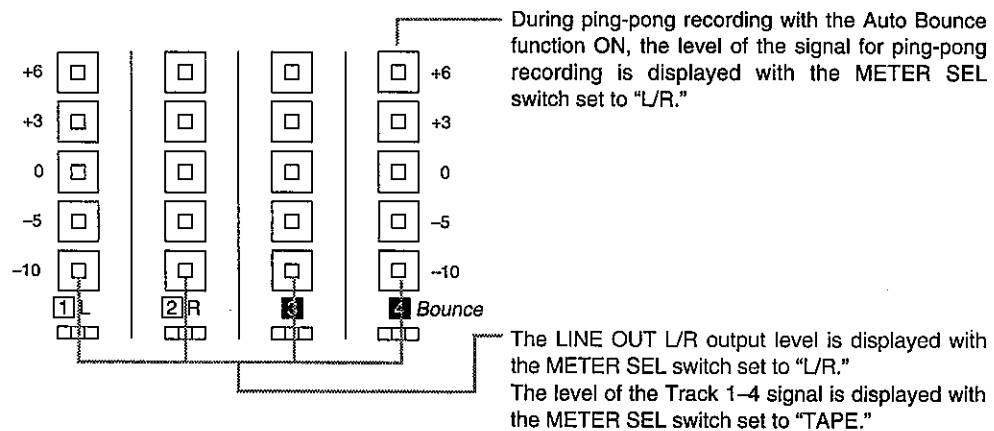
**⑨ Record Track indicator**

This indicator shows whether the track selected by the REC SEL button is in recording stand-by mode or is being recorded.

---

Flashing indicator: The track is in recording stand-by mode.

---

Illuminated indicator: The track is being recorded.

---

**⑩ Record Track Select switch [REC SEL]**

This switch allows you to select a recording track.

This switch combines Tracks 1 and 3 as a pair, and Tracks 2 and 4 as a second pair. When one pair is ON, the other pair is OFF. Therefore, you can select two tracks at a time—that is, Tracks 1 and 3, or Tracks 2 and 4.

**Note:**

When the Auto Bounce switch is on, you can select only one of four tracks. That is, only one REC SEL button will function.

The other thing you should note is that if a track has been selected for ping-pong recording, the selected REC SEL button will be cancelled when you turn the Auto Bounce switch OFF. In this case, you need to set the REC SEL button again.

---

**⑪ Power indicator**

This indicator is lit in green when the power to the XR-3 is turned on.

**⑫ Tape counter/Reset button [RESET]**

The tape counter displays the position of the tape.

Press the Reset button to reset the counter to [000].

**⑬ Deck transport**

This is where you insert a cassette tape.

Make sure that the XR-3 is stopped when you insert or remove the tape.

**⑭ Transport controls****PLAY button**

Press this button to play the tape.

**PAUSE button**

Press this button to stop the tape temporarily during playback or recording. (The PLAY button and/or RECORD button remain in the same position; however, the tape will be stopped.) Pressing the PAUSE button again will cancel the pause condition, and playback or recording will resume. This button does not function during the rewind/fast forward operation.

**STOP button**

Pressing this button during playback, recording, fast forward, or rewind will cancel all transport function buttons (PLAY, REC, FF, and REW) and stop the tape.



**FF button**

Pressing this button will fast forward the tape at a high speed.

**REW button**

Pressing this button will rewind the tape at a high speed.

**REC button**

When any of the Record Track indicators is flashing, press this button and the PLAY button simultaneously to start recording. (If the PAUSE button is on, the XR-3 engages recording stand-by mode, and the tape remains stopped.)

When recording starts, the Record indicator lights up, and the Record Track indicator of the selected track changes from flashing to lit.

**Note:**

---

This button is not effective if the record protect tub on the cassette tape is broken.

---

**⑮ Record indicator [REC]**

This indicator lights up in red in recording mode.

**⑯ Auto Bounce Level dial [Auto Bounce LEVEL]**

This dial allows you to adjust the final recording level of the tracks for ping-pong recording. First, adjust the track playback signal level using the GAIN control, then adjust the final level of ping-pong recording using this dial.

**⑰ Auto Bounce On/Off switch [Auto Bounce]**

This switch allows you to turn the Auto-bounce function (ping-pong) on/off. Pressing this switch once turns the function on, and pressing it again turns the function off.

**Note:**

---

You cannot set this switch OFF during ping-pong recording.

---

**⑱ Auto Bounce ON/OFF indicator**

This indicator lights up when the Auto Bounce switch is on, and it goes off when the switch is off.

**⑲ Master fader [MASTER]**

The Master fader allows you to adjust the volume level of the output level at LINE OUT L/R and the headphones.

## Front panel

### ⑳ Headphone jack [PHONES]

Connect your headphones here.

Use the MASTER fader to adjust the volume level.

### ㉑ Input jack [ 1 3, 2 4 ]

Connect the musical instruments or external microphones here for recording.

Be sure to set the Input Level switch to an appropriate position according to the type of the connected sound source.

Use a standard 1/4" phone jack.

### ㉒ Punch In/Out jack [PUNCH IN/OUT]

Connect an optional footswitch (Model 8051) here for punch in/out recording.

Refer to page 22 for a detailed explanation of punch in/out recording.

## Rear panel

### ㉓ Tape Out jack [TAPE OUT 1-4]

These jacks output the signal of Tracks 1-4 to an external mixing console or a signal processor. Jack 4 is also used as a SYNC OUT jack to transmit a sync signal to the connected MIDI sequencer or drum machine.

### ㉔ Line Out jack [LINE OUT L/R]

Connect these jacks to the INPUT jacks (L, R) of the master recorder for mixdown. You can also connect these to speaker monitors that have a built-in amplifier.

Use the MASTER fader to adjust the output level.

### ㉕ Dolby B Noise Reduction On/Off switch [NR ON/OFF]

This switch allows you to turn the Dolby B noise reduction system ON/OFF.

In general, turn this switch ON to achieve a higher recording/playback sound quality. Be sure to turn this switch ON when you are playing back a tape recorded with Dolby B NR.

### ㉖ DC IN connector [DC IN ----- 12V]

Connect the included AC adaptor here.

### ㉗ Power switch [ON-STANDBY]

This switch turns the power ON/OFF (STANDBY) to the XR-3.

When the AC adaptor is connected to the unit and the AC outlet, a small current always exists in the unit even if the power switch is OFF (STANDBY). Therefore, make sure to remove the AC adaptor from the AC outlet if you are not using the XR-3 for a long time of period or before you are go out.

# Basic Connection

Refer to the following diagrams for information on connecting the XR-3 input/output jacks to other devices or instruments.

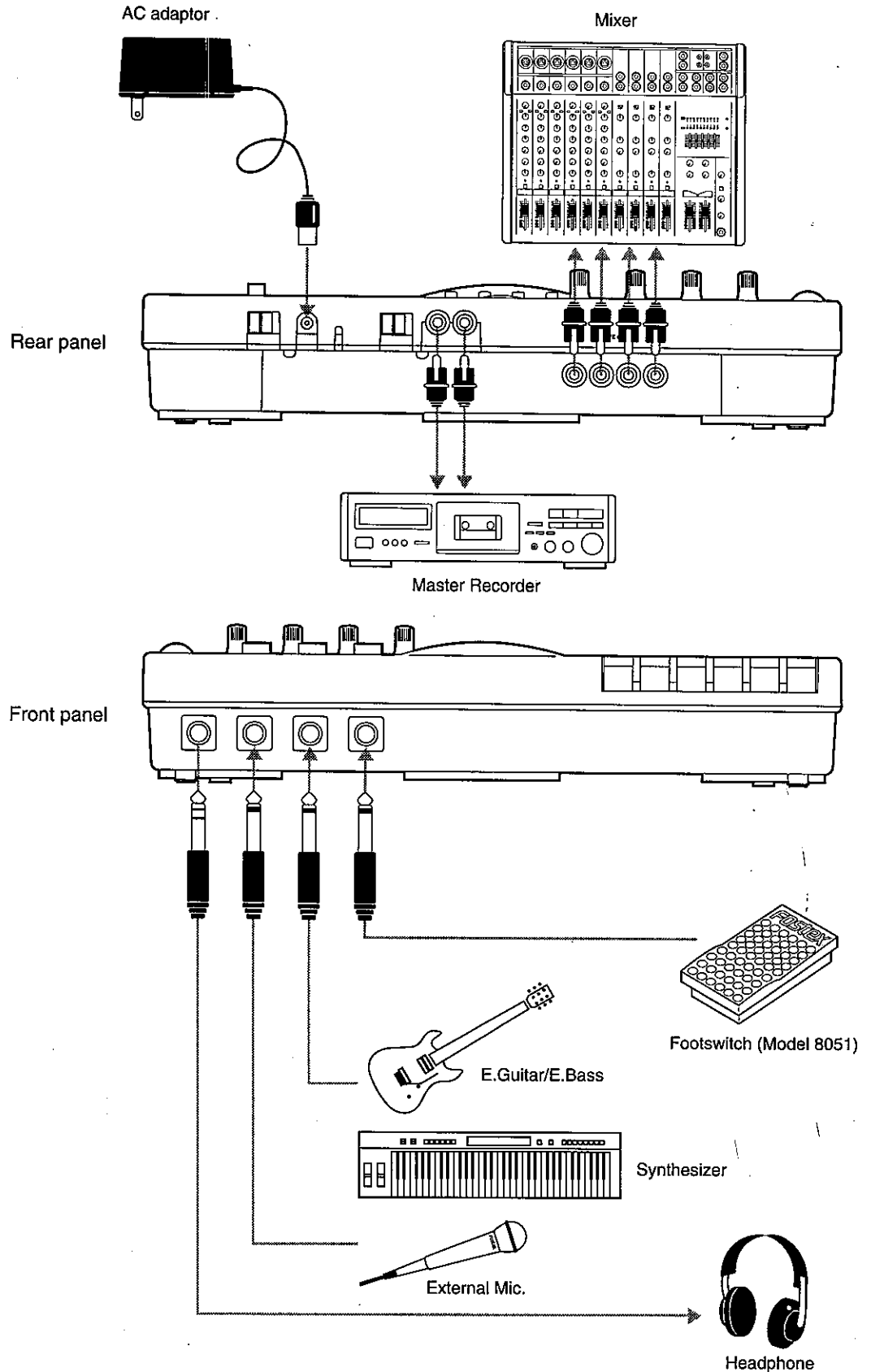

# Basic Guide "Let's Start Recording"

## Initial setting of the XR-3

You need to organize all the knobs and switches between steps or sessions. This means that you will set the position of the switches and knobs to their initial settings in order to avoid an unexpected problem that may be caused by operating the XR-3 with incorrect settings. These are called the "initial settings" in this manual.

The initial settings of all switches and knobs are shown in the following diagram.

Before proceeding to the next session, be sure to set the XR-3 to the "initial settings."

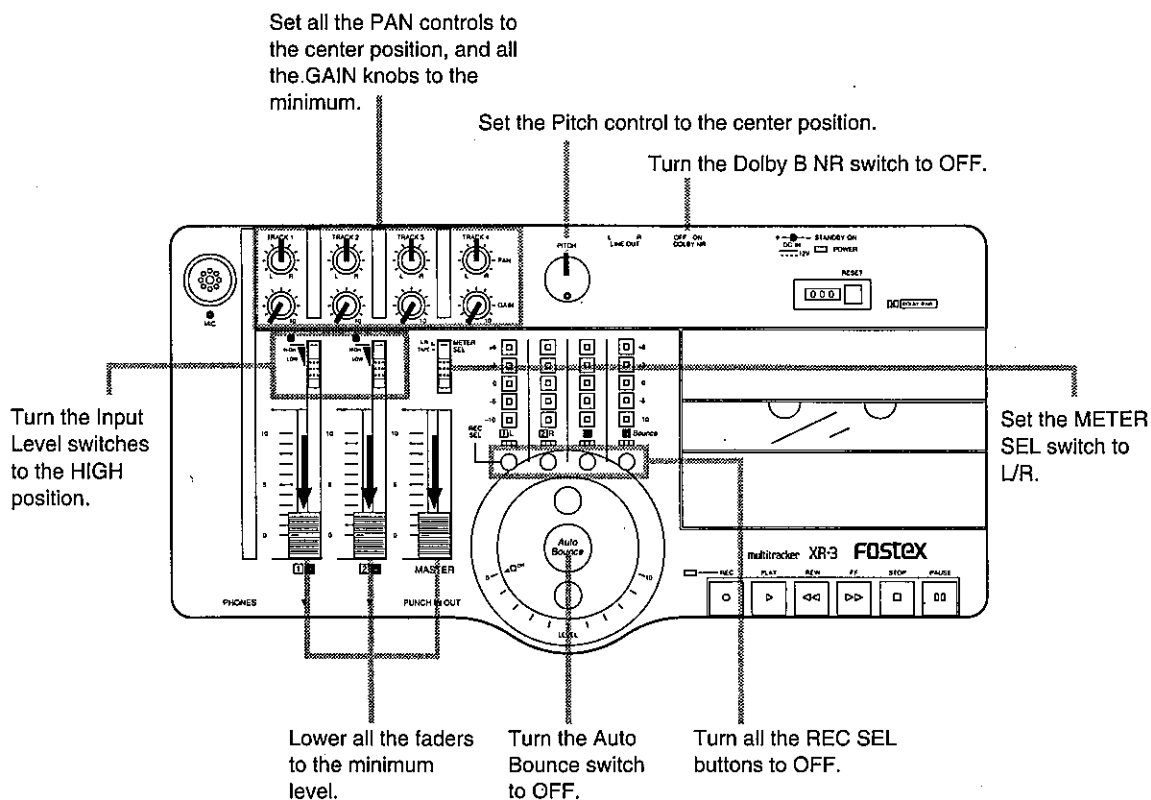

## Recording a musical instrument

Let's record a musical instrument sound to a track on the XR-3.  
In this example, we record a synthesizer to Track 1.

\* Reset the XR-3 to the initial settings, and follow the procedure below.

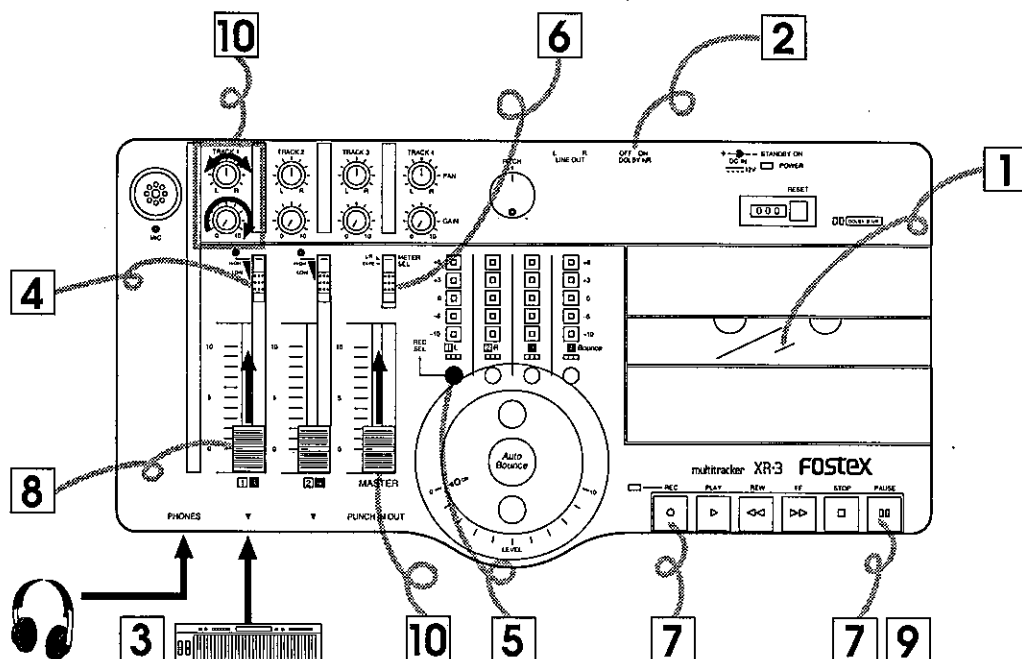

- 1** Insert a recording tape.
- 2** Turn the Dolby B NR switch ON.
- 3** Connect the instrument to the Channel 1 INPUT jack.
- 4** Set the Channel 1 Level switch to "HIGH." (The instrument sound will not be recorded if you set this switch to )
- 5** Turn the REC SEL button 1 ON.
- 6** Set the METER SEL switch to "TAPE."
- 7** Press the PAUSE button, then press the REC button.
- 8** Adjust the recording level using the Channel 1 INPUT fader while playing the synthesizer. Set the level to 0 – +3 such that the meter does not reach the maximum level.
- 9** Press the PAUSE button again to start recording, and start playing the synthesizer.
- 10** To monitor the recorded sound through the headphones, set the Track 1 GAIN control to MAX (all the way clockwise) and raise the MASTER fader gradually. Use the PAN control to adjust the balance of the monitor sound.

If you are recording data to any track other than Track 1, change the INPUT jack and the REC SEL button setting as shown in the following table:

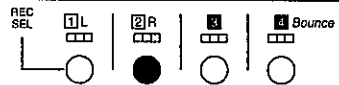
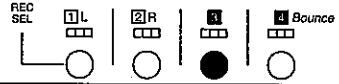
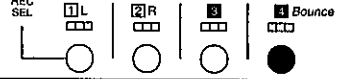
Recording track	INPUT jack	REC SEL button setting
2	Channel 2	
3	Channel 1	
4	Channel 2	

**Do not forget to set the Level switch according to the type of instruments connected to the INPUT jack!**

**One-Point Advice!**

You can connect two instruments to different INPUT jacks to record on two tracks simultaneously. In this case, remember the following relationship between the INPUT jack and recording track.

**Note:**

The instrument connected to Channel 1 will be recorded to Track 1 or Track 3 depending on the REC SEL button setting. The instrument connected to Channel 2 will be recorded to Track 2 or Track 4 depending on the REC SEL button setting.

**<Notes on the REC SEL button>**

When you are recording two tracks simultaneously, turning off (punch out) one of the REC SEL buttons may cause a click noise to be recorded on the tape, spoiling your valuable recording. Be careful if you wish to operate the REC SEL buttons during recording.

## Listening to the recorded sound

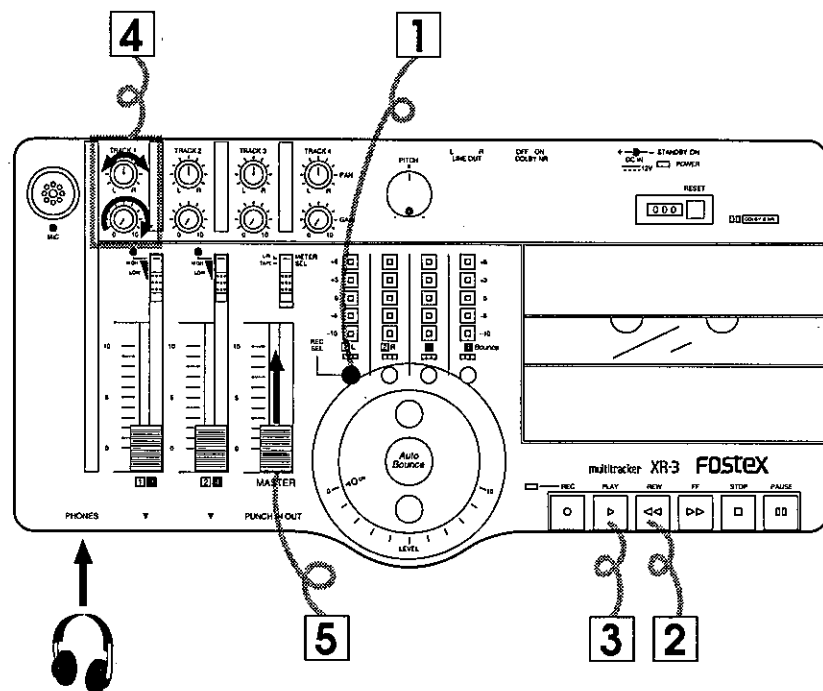

- 1 Turn REC SEL button 1 OFF.
- 2 Rewind the tape to the beginning.
- 3 Press the PLAY button.
- 4 Turn the Track 1 GAIN control to MAX (clockwise all the way), and use the PAN control to adjust the balance.
- 5 Raise the MASTER fader gradually to monitor the sound through the headphones.

### **One-Point Advice!**

During playback, it is a good idea to check how the sound pitch changes when you adjust the PITCH control knobs, and how the tone changes when you turn the DOLBY NR switch on/off.

#### **Note:**

Set the headphone monitoring volume to the optimum level. Avoid monitoring the sound at a high volume level for a long period of time to prevent injury to your ears.

## Recording with the internal microphone

Now, let's use the internal microphone for recording. The XR-3 has a built-in non-directional microphone that allows you to record vocal or acoustic guitar parts easily without connecting an external microphone.

As an example, we will record the acoustic guitar sound to Track 1.

Reset the XR-3 to the initial settings, and follow the procedure below.

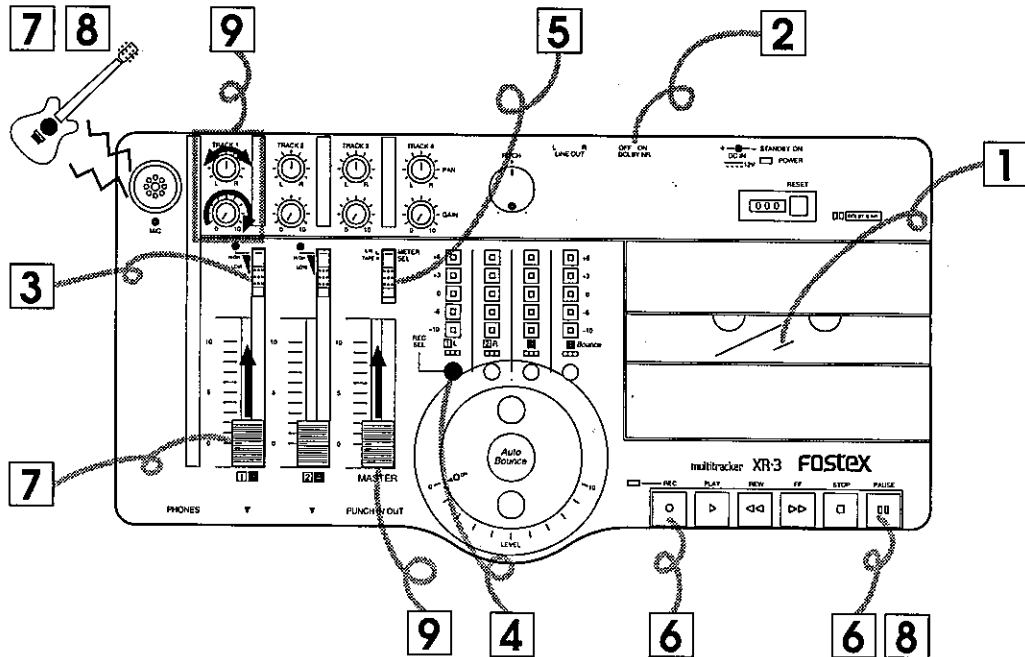

- 1 Insert a recording tape.
  - 2 Set the Dolby B NR switch to ON.
  - 3 Set the Channel 1 Input Level switch to "🎸."
  - 4 Turn REC SEL button 1 ON.
  - 5 Set the METER SEL switch to "TAPE."
  - 6 Press the PAUSE button, then press the REC button.
  - 7 Adjust the recording level using Channel 1 INPUT fader while playing the acoustic guitar. Set the level to 0 – +3 such that the meter does not reach the maximum level.
  - 8 Press the PAUSE button again to cancel pause mode and start recording, and start playing the guitar.
  - 9 Raise the MASTER fader gradually to monitor the sound through the headphones. Use the PAN control to adjust the monitor balance.
- If you are recording via the internal microphone to any track other than Track 1, change the Input Level switch and the REC SEL button settings as shown in the following table:

Recording track	Input Level switch	REC SEL button setting
2	Channel 2 → 🎸	REC SEL: [1] L, [2] R, [3] (off), [4] Bounce (off)
3	Channel 1 → 🎸	REC SEL: [1] L, [2] R, [3] (on), [4] Bounce (off)
4	Channel 2 → 🎸	REC SEL: [1] L, [2] R, [3] (off), [4] Bounce (on)



**One-Point Advice!**

As we explained in the previous synthesizer recording session, you can also record on two tracks simultaneously by switching the source for Channels 1 and 2 to the internal microphone and assigning recording tracks.

## Recording a vocal while listening to a recorded guitar sound

Now that you have learned how to connect the instruments and how to record the sound via the internal microphone on the desired track, let's record a vocal part through the internal microphone, while monitoring the recorded guitar sound.

This sound layering operation, unique to the MTR, is called "over-dubbing."

\* Reset the XR-3 to the initial settings, and follow the procedure below.

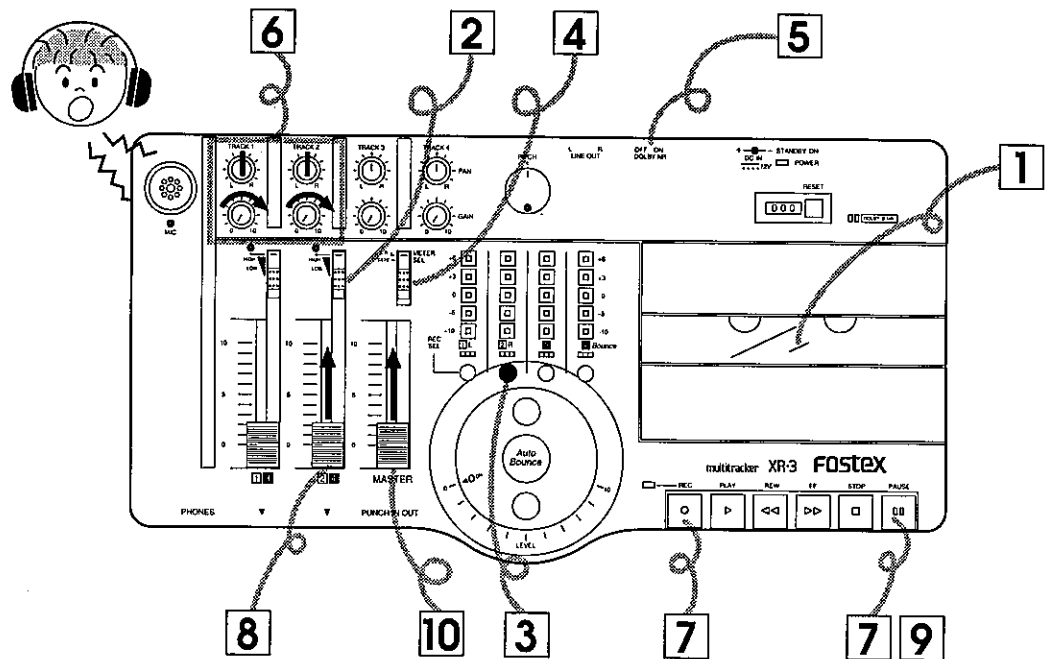

- 1** Insert a tape on which the data has been recorded to Track 1, and locate the beginning of the tape.
- 2** Set Channel 2 Input Level switch to "🎧."
- 3** Turn REC SEL button 2 ON.
- 4** Set the METER SEL switch to "TAPE."
- 5** Turn the Dolby B NR switch ON.
- 6** Set Track 2 GAIN control to the MAX position (all the way clockwise), and adjust the GAIN control for Track 1 to a slightly lower level. (Refer to One-Point Advice on the next page.)
- 7** Press the PAUSE button, then press the REC button.
- 8** Adjust the vocal recording level using the Channel 2 INPUT fader.
- 9** Press the PAUSE button again to cancel pause mode, and start recording the vocal part while listening to the guitar sound on Track 1.
- 10** Raise the MASTER fader gradually to monitor the sound through the headphones.

**One-Point Advice!**

It is a good idea to set the PAN controls to L or R separately for each track. This will separate the playback sound and recording sound clearly for easier monitoring through the headphones. If you set all the PAN controls to the center position, these two sounds are combined. Try various settings.

**What is overdubbing?**

Overdubbing is a recording method in which you layer the sound on the empty tracks while monitoring (listening to) the recorded sound on other track(s).

You will repeat this overdubbing technique to complete one song on the MTR. Basically, the following steps are used to overdub the sounds to four tracks.

**Step 1: Recording the drum machine to Track 1**

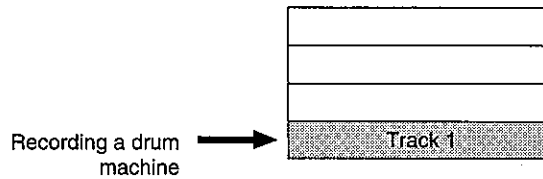

**Step 2: Overdubbing the bass guitar to Track 2 while monitoring the recorded drum machine**

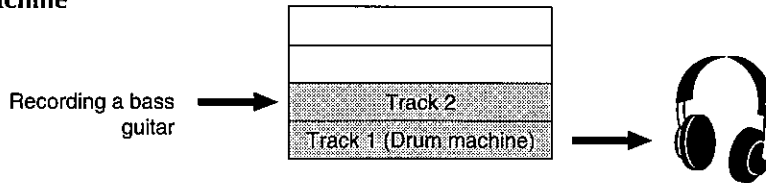

**Step 3: Overdubbing the guitar to Track 3 while monitoring the recorded drum machine and bass guitar**

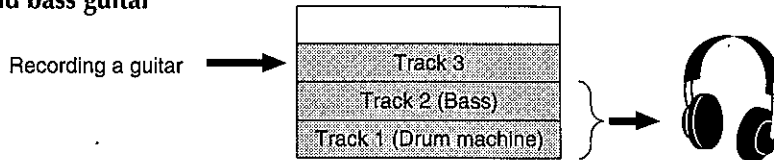

**Step 4: Overdubbing the vocal to Track 4 while monitoring Tracks 1, 2, and 3**

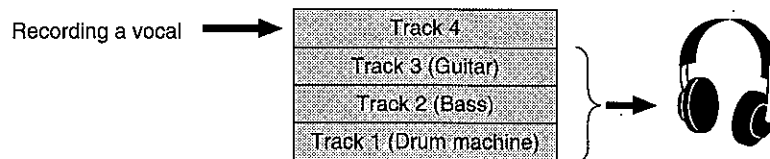

The following table shows the settings of the INPUT jacks, Input Level switches, the REC SEL buttons, and GAIN and PAN controls during the basic overdubbing operation (Step 1–Step 4). Refer to this table for Step 1–4 operation.

Step	INPUT jack	Input Level switch	REC SEL button	GAIN and PAN (Monitor section)
Step 1	Channel 1	Channel 1 → HIGH		
Step 2	Channel 2	Channel 2 → MID		
Step 3	Channel 1	Channel 1 → MID		
Step 4	Channel 2	Channel 2 → (Set this switch to "LOW" when you are using an external microphone.)		

### One-Point Advice 1

Be careful when you are setting the REC SEL buttons for the overdubbing steps. One incorrect setting may destroy your efforts.

### One-Point Advice 2

The settings of the monitor section (GAIN & PAN) shown in the table above are just an example. You can set the playback level lower, and the recording level higher. You can also pan all sounds to the center for monitoring. Adjust the GAIN and PAN controls to suit your taste.

## Listening to the recorded tracks

When you finish recording the song to the tracks, let's listen to the result.

- 1** Rewind the tape to the beginning.
- 2** Turn all the REC SEL buttons OFF.
- 3** Set the METER SEL switch to "L/R."
- 4** Press the PLAY button to start playback.
- 5** Adjust the track volume level and balance using the Track 1–4 GAIN control and PAN control, respectively.
- 6** Raise the MASTER fader gradually, and you will hear the sound of each track.

## Mixdown

Now that you have finished recording the sounds to Tracks 1–4, we will mix the sounds of these four tracks and record them onto the master recorder in stereo. This step is called "mixdown." After mixdown, you can playback the recorded tape on a boom box. First, reset the XR-3 to the initial settings.

### One-Point Advice!

The use of the PAN controls is different from that in overdubbing. In mixdown, the sounds of the four tracks are mixed in stereo. Use the PAN control of each track to set the desired stereo image. Refer to the following settings example:

Track	Type of musical instrument	PAN control position
Track 1	Drum machine	Center
Track 2	Bass guitar	Center
Track 3	Electric guitar (or synth)	Right
Track 4	Vocal	Left

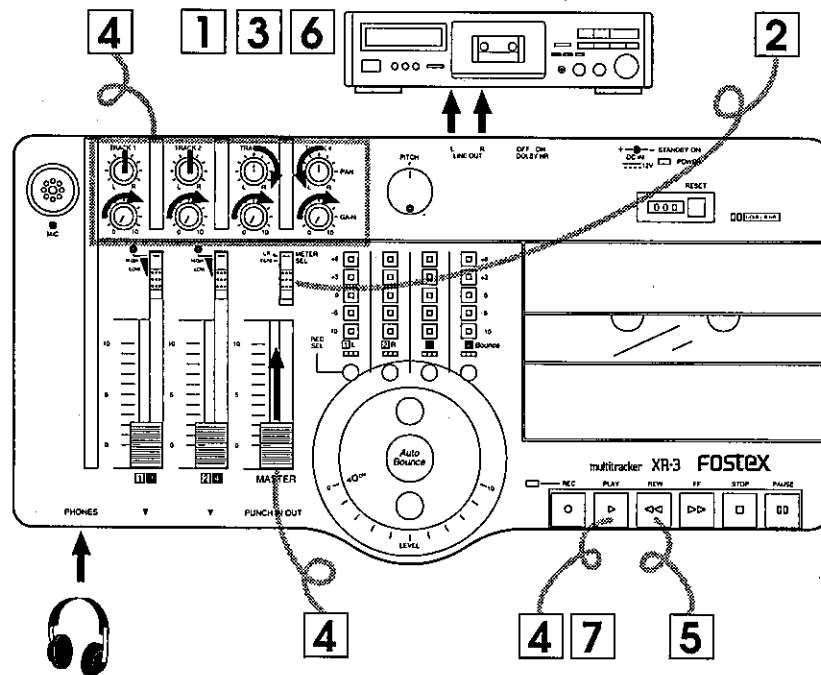

### Connections

- 1 Connect the LINE OUT L, R jacks and the master recorder INPUT jacks.
- 2 Set the METER SEL switch to "L/R."

### Rehearsal

- 3 Press the PAUSE button and REC button on the master recorder to place the recorder in REC-PAUSE mode.
- 4 While playing back the tape, adjust the track playback level and balance using the track GAIN control and PAN control respectively, and adjust the overall level of the signal output from LINE OUT L, R using the MASTER fader. (Check the level with the meter.) At this time, check the input level on the master recorder.

## Mixdown

- 5 Locate the beginning of the tape.
- 6 Start recording on the master recorder first.
- 7 Press the **PLAY** button on the XR-3 to start mixdown.

..... **One-Point Advice 1** .....

Applying reverb to the vocal sound on Track 4 during mixdown.

1. Connect the **TAPE OUT** jack 4 to the **INPUT** connector on the reverb unit.
2. Connect the **OUTPUT** connector on the reverb unit to the XR-3's Channel 1 **INPUT** jack (because we recorded the vocal part with the **PAN** control set to "L"). (All the **REC SEL** buttons remain **OFF**.)
3. Use the Channel 1 **INPUT** fader to adjust the level of the signal input from the reverb unit.
4. Start mixdown.  
You can mixdown with reverb applied to the vocal sound.

..... **One-Point Advice 2** .....

Recording additional instruments during mixdown

1. Connect an additional musical instrument to the **INPUT** jack, and set the **Input Level** switch accordingly. (All the **REC SEL** button will remain **OFF**.)  
The instrument connected to Channel 1 will be recorded to L on the master recorder, and the instrument connected to Channel 2 will be recorded to R.
2. Start mixdown.  
Play the instrument during mixdown. The new instrument sound will also be combined and mixed down.

# Application Guide

Now you understand how to perform basic recording and multi-track recording as described in the Basic Guide. Here, in the Application Guide, we will introduce you to more advanced recording methods: punch in/out recording, and ping-pong recording.

## Punch In/Out Recording

Punch in/out recording allows you to re-record part of a recorded track by placing the part in a temporary recording status.

This function is useful when you wish to replace an out-of-tune part of a vocal or a mistake in a phrase with a correct sound.

### One-Point Advice!

To perform punch in/out recording, first play back the tape to shortly before the part you wish to replace. Then start recording at the gap between the phrases. This is called "punch in." After recording the part correctly, return to playback status. This is called "punch out." You need to use an optional footswitch (Model 8051) to perform punch in/out recording.

The following diagram shows how punch-in/out recording is performed.

### <Example> Correcting a part on Track 4: (REC SEL switch 4→ ON)

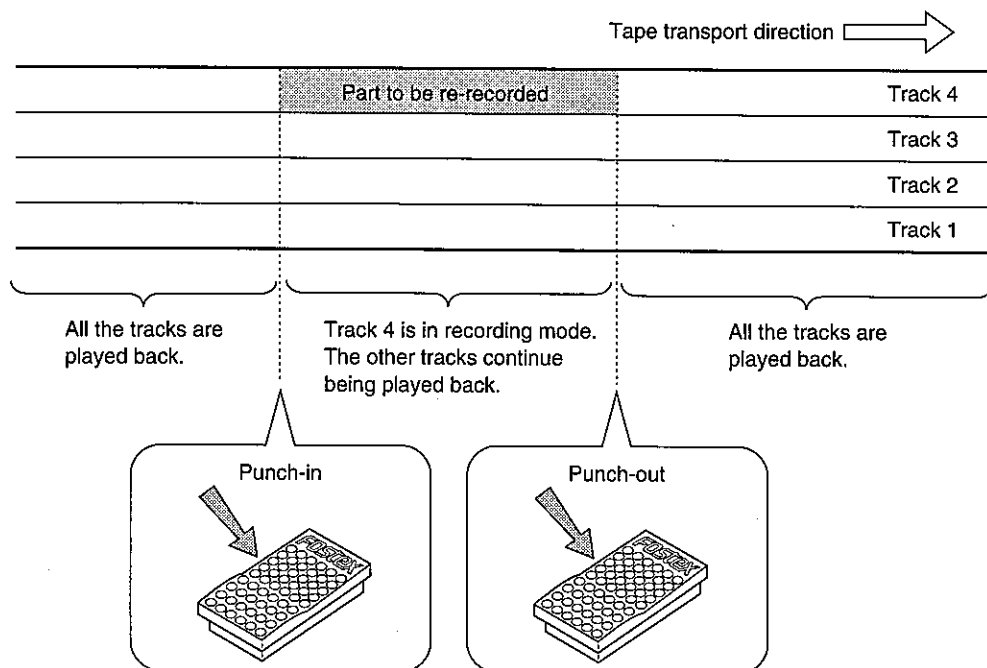

## <Example> Correcting a vocal mistake on Track 4

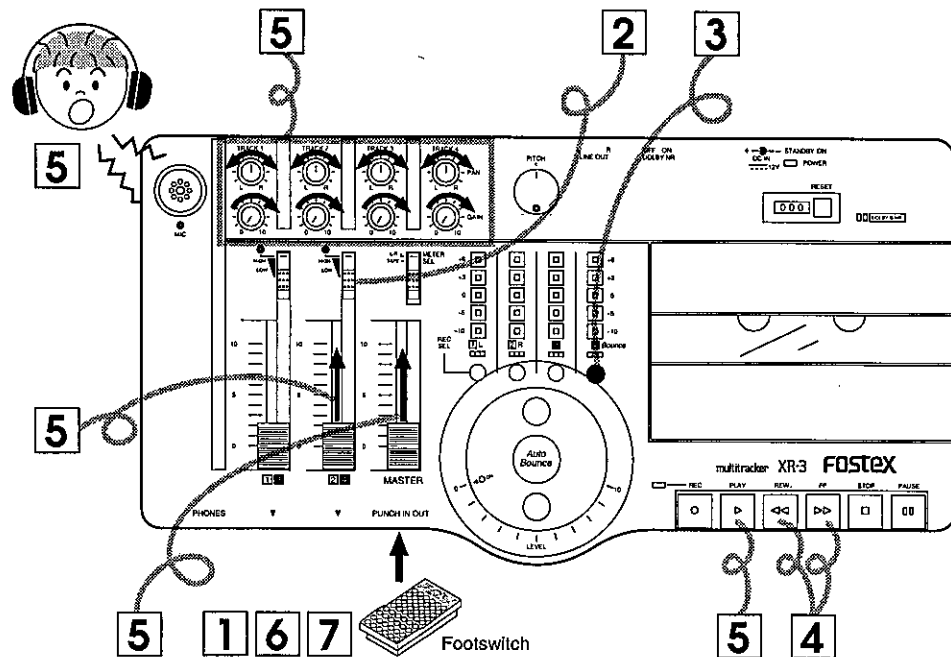

- 1** Connect a footswitch to the **PUNCH IN/OUT** jack.  
In this function, you will not use the **REC** button. You will press the footswitch shortly before the punch in part.
- 2** Set Channel 2 Input Level switch to "●".  
Set this switch to "LOW" when you are using an external microphone.
- 3** Turn the **REC SEL** button 4 to **ON**.
- 4** Locate the part on the tape just before the punch-in point.
- 5** Press the **PLAY** button and start singing along with the sound on Tracks 1–4.  
Use the Track 1–4 **GAIN** controls to adjust the Track 1–4 playback level, and use the **MASTER** fader to adjust the monitoring level. Use the Channel 2 **INPUT** fader to adjust the vocal recording level.
- 6** When the punch-in point is reached, press the footswitch.  
Track 4 will enter record mode, and a new vocal phrase will be recorded.
- 7** After recording, press the footswitch again. The XR-3 will drop out from recording and return to playback.

## Ping-pong recording (Auto-bounce function)

The MTR allows you to record multiple signals by using four tracks effectively. However, in this case, once you have finished recording all four tracks, you have no more available tracks on which to record.

This problem is solved by mixing the recorded multiple tracks down to an empty track to clear up those tracks. This step is called ping-pong recording.

Ping-pong recording allows you to overdub additional sounds to recorded tracks to layer multiple sounds.

### <Example> One-person seven-piece band through the use of ping-pong recording

① Record A, B and C on tracks 1-3

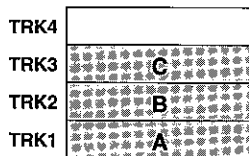

③ Record D and E on tracks 1 and 2

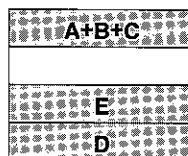

⑤ Record F and G on tracks 1 and 2

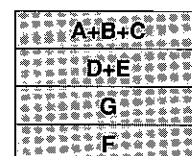

② Ping-pong record on track 4

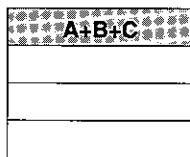

④ Ping-pong record D and E on track 3

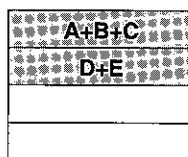

Result: a total of 7 recorded parts A-G!

The XR-3 employs an "Auto-bounce function" for ping-pong recording. This function has made ping-pong recording very easy.

### One-Point Advice!

#### These are the keys for the Auto-bounce function!

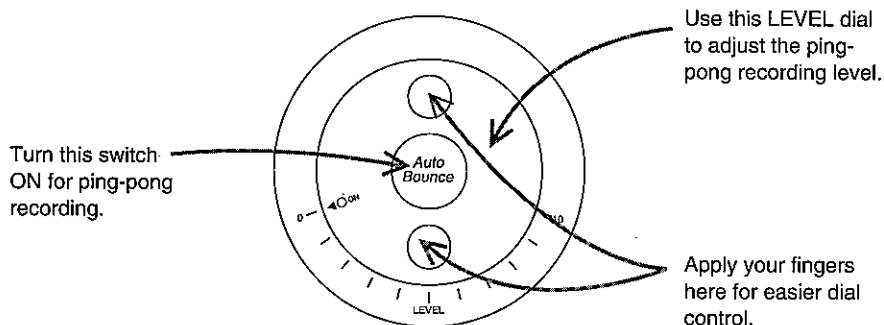

#### Be careful about oscillation during ping-pong recording

During ping-pong recording, raising the gain too high may generate oscillation. In this case, stop recording immediately.

Monitoring sound with oscillation through headphones or external monitor devices may impair your hearing ability.

After you stop recording, lower the output level (Gain control knobs or Auto Bounce LEVEL dial on the XR-3) to an appropriate gain level, and restart recording.



<Example> Mixing Tracks 1, 2, and 3, then ping-pong recording to Track 4

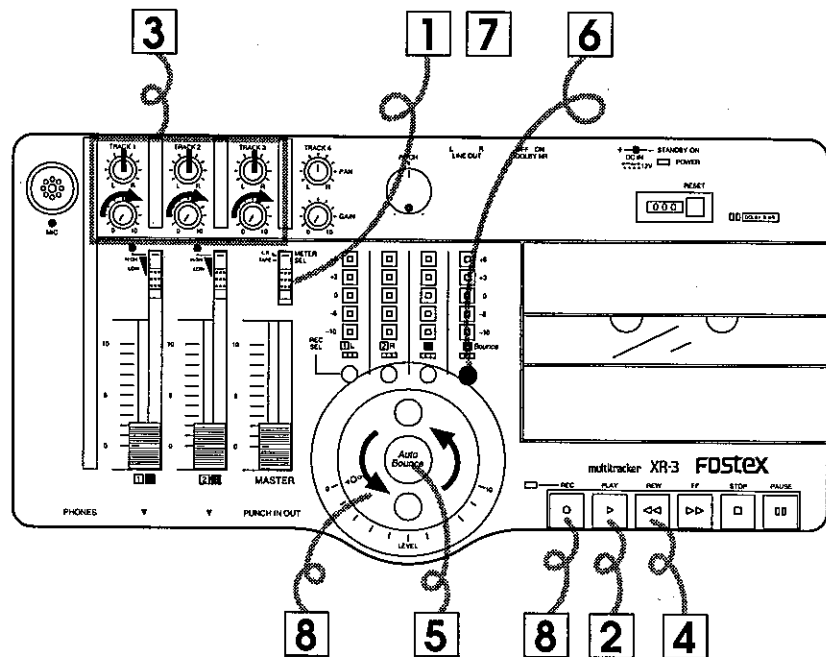

- 1 Set the METER SEL switch to "TAPE."
- 2 Press the PLAY button to play back the tape.
- 3 Use the Track 1-3 GAIN controls to adjust the track playback level.
- 4 Locate the beginning of the tape.
- 5 Turn the Auto Bounce switch ON. (Its LED will light up.)
- 6 Turn the REC SEL button 4 ON.
- 7 Set the METER SEL switch to "L/R."
- 8 Press the REC button to start ping-pong recording.  
Use the Auto Bounce LEVEL dial to adjust the level of the entire track. You can check the level of the signal to be ping-pong recorded with the right-most (4 Bounce) of the level meters.

To ping-pong record to other tracks, refer to the steps above and set the corresponding REC SEL button.

<Notes on the Auto-bounce function>

When the Auto Bounce switch is on, you can select only one of four tracks. That is, only one REC SEL button will function.

The other thing you should note is that if a track has been selected for ping-pong recording, the selected REC SEL button will be cancelled when you turn the Auto Bounce switch OFF. In this case, you need to set the REC SEL button again.

## Tape Sync

Tape sync refers to synchronizing a MIDI device, such as a sequencer or a drum machine, to the recorded sound. The tape sync operation has the following merits:

- ① You can save the number of tracks utilized, because you do not need to record MIDI performance data onto the tape.
- ② You can mixdown the dynamic sounds of electronic musical instruments, such as a synthesizer or drum machine directly, achieving better sound quality.
- ③ Tape sync allows for more flexible and advanced editing, such as overdubbing MIDI sequencing songs, replacing a rhythm pattern of the drum machine, etc.

### One-Point Advice!

You need to record and play back the "FSK signal" on Track 4 to achieve the tape sync operation.

The FSK signal is a sound signal created by modulating the MIDI clock (one of the MIDI signals) of the song tempo information output from sequencers and drum machines so that it can be recorded onto the tape. The track containing the FSK signal performs a role similar to an orchestra conductor. When you send the FSK signal to the sequencer or drum machine, the sequencer or drum machine will play back the song, synchronizing the signal.

#### Note:

Some MIDI devices are not able to input or output an FSK signal. If this is the case with your MIDI device, you will need a separate MIDI/FSK converter. For details, consult the manual for your MIDI device.

### <Connection example for tape sync>

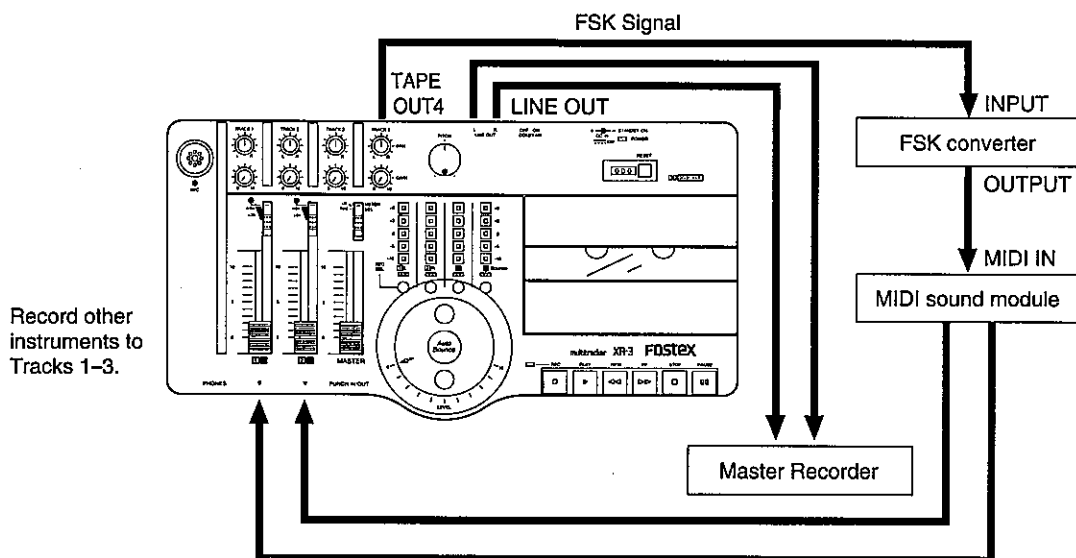

# Troubleshooting

	Problem	Points to check	Action
Sound trouble	• Wow, flutter, or dropouts	Are the capstan and pinch roller dirty?	Clean them.
		Is the tape damaged?	Use a new high-quality tape.
	• Sound quality and level significantly different from when recorded	Is the head dirty?	Clean the head.
		Are you using a tape other than a high-position tape?	Use a high-position tape (chrome, type II).
	• Significant distortion/noise	Did you set the INPUT fader and Input Level switch correctly?	Set them correctly.
	• Playback pitch different from when recorded	Is the PITCH control in the same position as when recorded?	Set the control in the same position.
• No sound from the headphones	Are the GAIN controls for each track and the MASTER fader raised?	Raise the fader.	
Recording trouble	• Cannot record on the desired track.	Is the REC SEL button set appropriately for the connected instrument?	Signal input to Channel 1 Input jack is recorded to Track 1 or 3, and signal input to Channel 2 Input jack is recorded to Track 2 or 4. Check the connection and settings.
	• Cannot record.	Is the write-protect tab broken on the cassette tape?	Attach a piece of scotch tape over the broken tab.
		Is the INPUT fader of the connected input channel raised correctly?	Raise the INPUT fader.
	• Cannot ping-pong record.	Is the Auto-bounce function ON?	Turn the Auto Bounce switch ON.
		Has the ping-pong track specified by the REC SEL button?	Specify the track for ping-pong recording.
Is the Auto Bounce LEVEL dial raised?		Rotate the dial to an appropriate level.	
Other troubles	• Tape does not transport.	Is the cassette tape installed correctly?	Insert the tape correctly.
	• Power is not turned on.	Is the AC adaptor connected correctly?	Connect the AC adaptor correctly.

---

# Maintenance

## • Cleaning

### **Cleaning the head**

As the XR-3 is used, the record/playback head will become coated with dust and oxide residue from the tapes. If this residue is allowed to build up, recordings will contain more noise, and dropouts may occur during playback. Even invisible dirt could cause the high range to be affected, creating a muffled sound. To prevent this, regular cleaning is important. Use a commercial cleaning kit etc. to clean the head.

### **Capstan and pinch roller**

The capstan and pinch roller are important parts that hold the tape and move it along at the correct speed. As with the head, these parts can also become dirty with oxide residue and dust, which will cause increased wow or flutter, or even damage the tape by pulling it out of the cassette.

Since cassette tape is very thin, it is especially dangerous to use a cassette deck with dirty pinch rollers. As with the head, it is important to always keep these parts clean. Clean them using a cotton swab or gauze soaked in cleaning solution or isopropyl alcohol. Never use organic solvents such as lacquer thinner, since this will severely damage the pinch rollers.

## **Demagnetizing the head**

After long periods of use, the head begins to develop a magnetic field in addition to the oxide residue described above. This can also occur if a magnet or a magnetized object (scissors, etc.) is allowed to come near the head or touch it. If the head or capstans become magnetized, frequency response will be degraded and noise will increase. In extreme cases, noise can be created on previously-recorded tapes that you playback, rendering them useless.

Once a month or so, you should use a demagnetizer (head eraser) to demagnetize the head. Carefully read and follow the instructions included with your demagnetizer, and do not allow it to come near recorded tapes.

# Specifications

<b>Inputs (×2)</b>	
Microphone impedance	: Less than 10 k $\Omega$
Input impedance	: 20 k $\Omega$ or higher
Normal input level	: HIGH: -10 dBV MID: -30 dBV LOW: -50 dBV
<b>Internal microphone</b>	: Condenser type × 1 (switchable)
<b>LINE OUT L, R</b>	
Output load impedance	: 10 k $\Omega$ or higher
Normal output level	: -10 dBV
<b>Tape output (TAPE OUT 1-4)</b>	
Output load impedance	: 10 k $\Omega$ or higher
Normal output level	: -10 dBV
<b>Headphone output (PHONES)</b>	
Output load impedance	: 8 - 50 $\Omega$
Maximum output	: 20 mW
<b>Recording tape</b>	: C-60, C-90 (Type II / High position) TDK SA, MAXELL XLIH or equivalent
<b>Record tracks</b>	: 4 tracks, one direction (simultaneous recording of up to two tracks possible)
<b>Noise reduction</b>	: Dolby B NR (internal) (switchable on/off)
<b>Tape speed</b>	: 9.5 cm/s
<b>Wow/flutter</b>	: $\pm 0.17\%$ (IEC/ANSI)
<b>Fast wind time</b>	: 120 seconds (C-60 tape)
<b>Pitch control</b>	: $\pm 10\%$
<b>Recording time</b>	: 22.5 minutes (C-90 tape)
<b>Frequency response</b>	
Mixer	: 20 Hz-20 kHz
Recorder	: 40 Hz-14 kHz
<b>Signal/noise ratio</b>	: 58 dB
<b>Crosstalk</b>	: Higher than 50 dB (1 kHz)
<b>Erase ratio</b>	: Higher than 70 dB (1 kHz)
<b>Heads</b>	
Rec/Play	: 4-track, 4-channel record/playback
Erase	: 4-track, 4-channel erase
<b>Power Requirement</b>	: DC12V (12-16V), 11W (Fostex AC adaptor, AD-12B)
<b>Weight</b>	: 1.5 kg (excludes AC adaptor)
<b>Dimensions (mm)</b>	: 355 (W) × 81 (H) × 188 (D)
<b>Accessory</b>	: AC adaptor (Model AD-12B)

- \* Specifications and appearance are subject to change without notice for product improvement.
- \* Dolby Noise Reduction is manufactured under license from Dolby Laboratories Licensing Corporation.
- \* Dolby and the double-D symbol are trademarks of Dolby Laboratories Licensing Corporation.

# Block Diagram

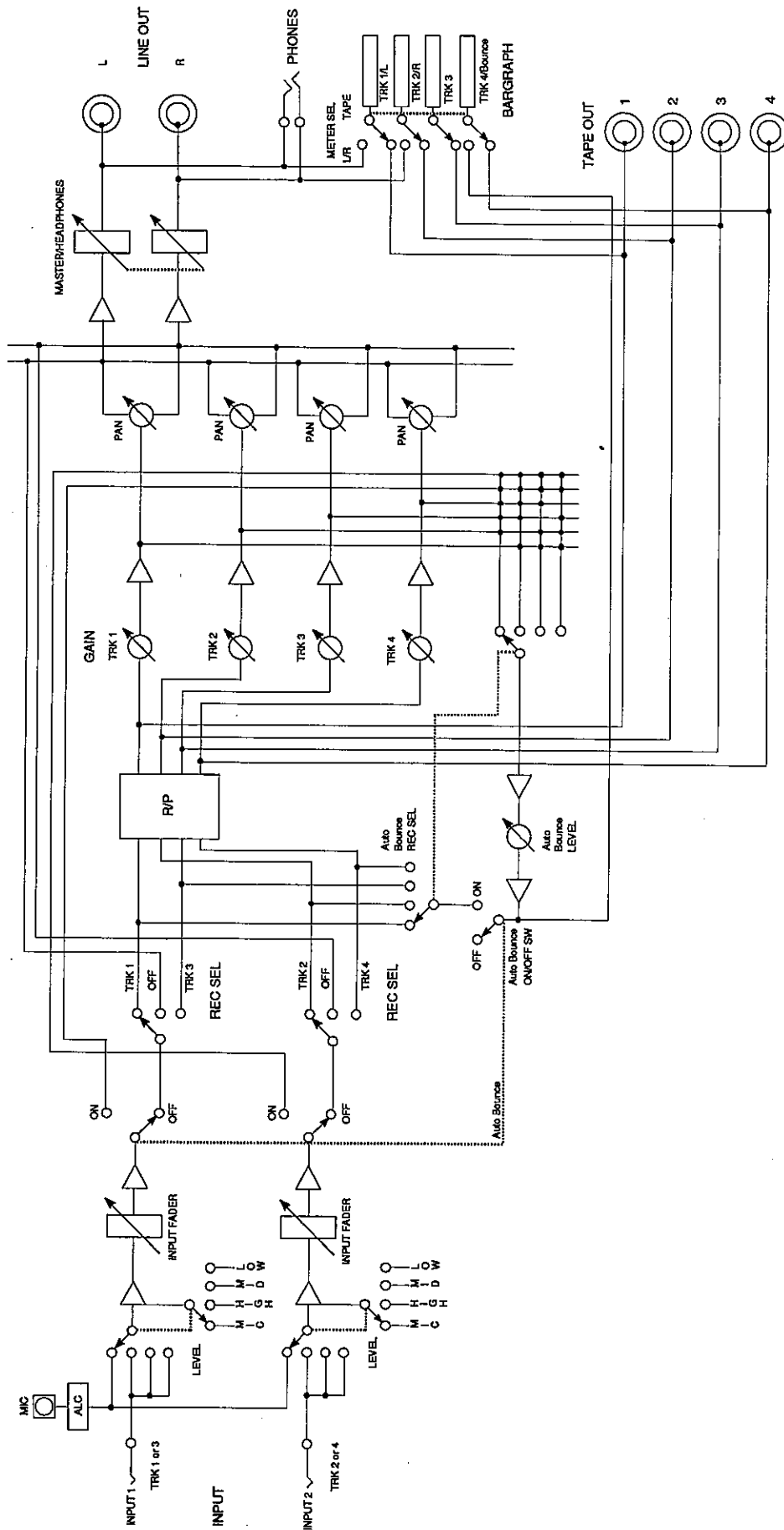



**Fostex**<sup>®</sup>

FOSTEX CORPORATION 3-2-35 Musashino, Akishima-shi, Tokyo, Japan 196  
FOSTEX CORPORATION OF AMERICA 15431, Blackburn Ave., Norwalk, CA 90650, U.S.A.

© PRINTED IN TAIWAN JULY, 1996 8288 355 100 1F

381054EA



## Free Manuals Download Website

<http://myh66.com>

<http://usermanuals.us>

<http://www.somanuals.com>

<http://www.4manuals.cc>

<http://www.manual-lib.com>

<http://www.404manual.com>

<http://www.luxmanual.com>

<http://aubethermostatmanual.com>

Golf course search by state

<http://golfingnear.com>

Email search by domain

<http://emailbydomain.com>

Auto manuals search

<http://auto.somanuals.com>

TV manuals search

<http://tv.somanuals.com>