

Digital Audio Patchbay
Model DP-8 Owner's Manual

Fostex

Fostex wishes to thank you for purchasing our Model DP-8.

The DP-8 is a digital audio patchbay for interconnecting eight inputs (OPTICAL IN x 6, COAXIAL IN x 2) and eight outputs (OPTICAL OUT x 6, COAXIAL OUT x 2) between digital audio equipment.

Individual INPUT SELECTORS are provided for all outputs, which allows selecting any input signal routed to the output.

By using the DP-8 between multiple units of digital equipment, complex connections can be assembled and all inputs and outputs controlled at one location.

Please read this Manual before using the DP-8.



CAUTION

RISK OF ELECTRIC SHOCK
DO NOT OPEN



CAUTION: TO REDUCE THE RISK OF ELECTRIC SHOCK,
DO NOT REMOVE COVER (OR BACK).
NO USER - SERVICEABLE PARTS INSIDE.
REFER SERVICING TO QUALIFIED SERVICE PERSONNEL.

CAUTION:

TO PREVENT ELECTRIC SHOCK, MATCH WIDE BLADE OF PLUG TO WIDE SLOT, FULLY INSERT.

ATTENTION:

POUR ÉVITER LES CHOCS ÉLECTRIQUES, INTRODUIRE LA LAME LA PLUS LARGE DE LA FICHE DANS LA BORNE CORRESPONDANTE DE LA PRISE ET POUSSER JUSQU' AU FOND.

"WARNING"

"TO REDUCE THE RISK OF FIRE OR ELECTRIC SHOCK,
DO NOT EXPOSE THIS APPLIANCE TO RAIN OR MOISTURE."



The lightning flash with arrowhead symbol, within an equilateral triangle, is intended to alert the user to the presence of uninsulated "dangerous voltage" within the product's enclosure that may be of sufficient magnitude to constitute a risk of electric shock to persons.



The exclamation point within an equilateral triangle is intended to alert the user to the presence of important operating and maintenance (servicing) instructions in the literature accompanying the appliance.

SAFETY INSTRUCTIONS

1. Read Instructions - All the safety and operating instructions should be read before the appliance is operated.
2. Retain Instructions - The safety and operating instructions should be retained for future reference.
3. Heed Warnings - All warnings on the appliance and in the operating instructions should be adhered to.
4. Follow Instructions - All operating and use instructions should be followed.
5. Water and Moisture - The appliance should not be used near water - for example, near a bathtub, washbowl, kitchen sink, laundry tub, in a wet basement, or near a swimming pool, and the like.
6. Carts and Stands - The appliance should be used only with a cart or stand that is recommended by the manufacturer.
7. Wall or Ceiling Mounting - The appliance should be mounted to a wall or ceiling only as recommended by the manufacturer.
8. Ventilation - The appliance should be situated so that its location or position does not interfere with its proper ventilation. For example, the appliance should not be situated on a bed, sofa, rug, or similar surface that may block the ventilation openings; or, placed in a built-in installation, such as a bookcase or cabinet that may impede the flow of air through the ventilation openings.
9. Heat - The appliance should be situated away from heat sources such as radiators, heat registers, stoves, or other appliances (including amplifiers) that produce heat.
10. Power Sources - The appliance should be connected to a power supply only of the type described in the operating instructions or as marked on the appliance.
11. Grounding or Polarization - The precautions that should be taken so that the grounding or polarization means of an appliance is not defeated.
12. Power Cord Protection - Power supply cords should be routed so that they are not likely to be walked on or pinched by items placed upon or against them, paying particular attention to cords at plugs, convenience receptacles, and the point where they exit from the appliance.
13. Cleaning - The appliance should be cleaned only as recommended by the manufacturer.
14. Nonuse Periods - The power cord of the appliance should be unplugged from the outlet when left unused for a long period of time.
15. Object and Liquid Entry - Care should be taken so that objects do not fall and liquids are not spilled into the enclosure through openings.
16. Damage Requiring Service - The appliance should be serviced by qualified service personnel when:
 - A. The power supply cord or the plug has been damaged; or
 - B. Objects have fallen, or liquid has been spilled into the appliance; or
 - C. The appliance has been exposed to rain; or
 - D. The appliance does not appear to operate normally or exhibits a marked change in performance; or
 - E. The appliance has been dropped, or the enclosure damaged.
17. Servicing - The user should not attempt to service the appliance beyond that described in the operating instructions. All other servicing should be referred to qualified service personnel.



An appliance and cart combination should be moved with care. Quick stops, excessive force, and uneven surfaces may cause the appliance and cart combination to overturn.

Notes on Operation

- 1. Turn down all sound volume controls before switching on power.**
When switching on or off power to the DP-8, turn down the sound volume controls on all external equipment connected. Otherwise, any sudden loud noise could damage your hearing or the equipment.
- 2. Switch off power before connecting external equipment.**
Before connecting external equipment to the DP-8, be sure to switch off all power to the external equipment.

- 3. Use a Fostex specified AC adaptor.**

Be sure to use an AC adaptor specified by Fostex. Otherwise, the polarity could be different.

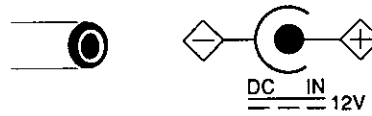

In the drawing at left, the inner element is indicated as the "plus" side and the supply voltage as DC 12V.

Function and Names of the Controls and Connectors

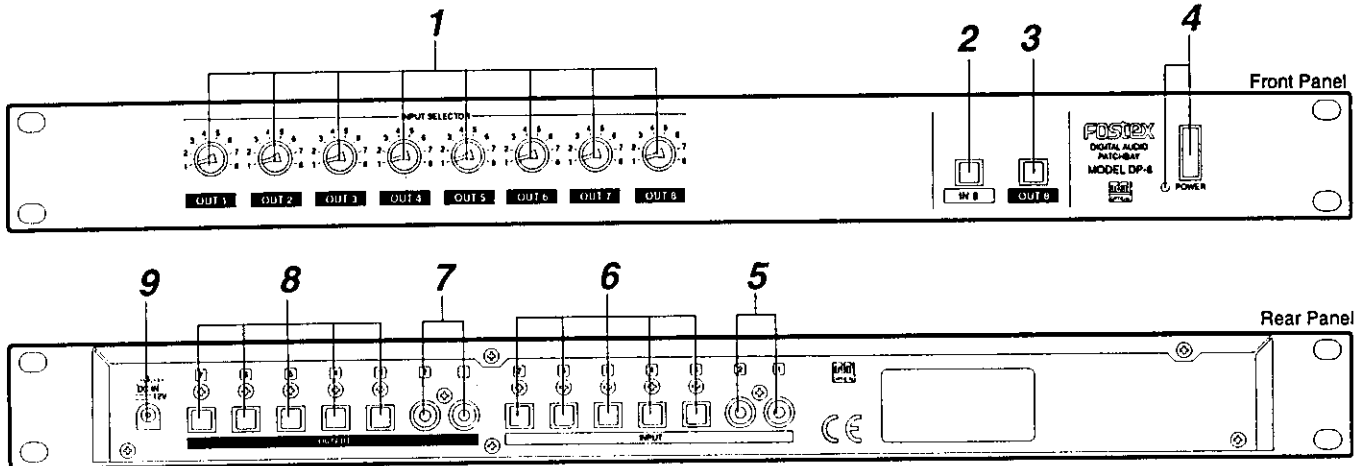

1. INPUT SELECTOR

Input signals which are output from each output connector are selected (See below for method in use).

<Example>

To output from OUTPUT 8 the signal input to INPUT 5. Set the INPUT SELECTOR for OUT 8 to "5".

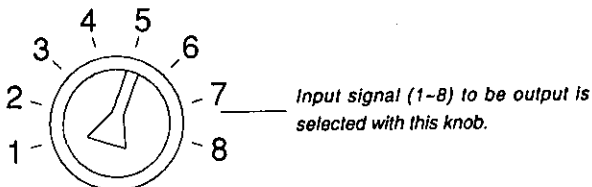

OUT 8

This indicates the connector name to which the signal is output.

5. Input connector 1, 2 [INPUT 1, 2]

The COAXIAL input connectors to which S/P DIF signals can be input.

6. Input connector 3-7 [INPUT 3-7]

The OPTICAL input connectors to which S/P DIF signals or A-dat OPTICAL signals can be input.

7. Output connector 1, 2 [OUTPUT 1, 2]

The COAXIAL output connectors where S/P DIF signals selected by the INPUT SELECTOR can be output.

<NOTE>

Use this only for output of S/P DIF signals.

If A-dat OPTICAL signal is output from this connector, operation of the connected external equipment might be unstable.

8. Output connectors 3-7 [OUTPUT 3-7]

The OPTICAL output connectors from which S/P DIF or A-dat OPTICAL signals selected by the INPUT SELECTOR can be output.

2. Input connector 8 [IN 8]

The OPTICAL input connector on the front panel. S/P DIF or A-dat OPTICAL signals can be input here the same as the rear panel OPTICAL input connectors 3-7.

3. Output connector 8 [OUT 8]

The OPTICAL output connector on the front panel. S/P DIF or A-dat OPTICAL signals will be output here the same as with the rear panel OPTICAL output connectors 3-7.

4. Power switch/POWER LED [POWER]

The On/Off switch for the DP-8.
The POWER LED will be lit when power is switched on.
Always switch this off when connecting external equipment to the DP-8.

9. DC IN connector [DC IN 12V]

The AC adaptor included in the DP-8 package is connected here.

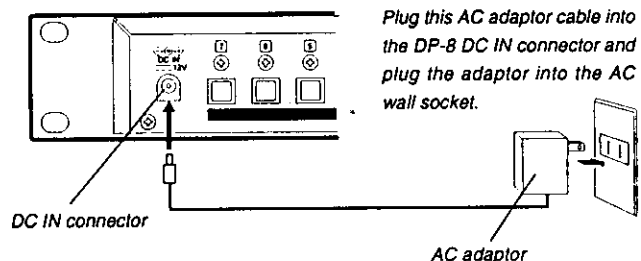

<CAUTION>

If you are not going to use the DP-8 for some time, unplug the adaptor from the wall AC socket.

Connecting Examples with External Equipment

As shown in the examples below, a maximum of eight external pieces of equipment can be interconnected. Use the INPUT SELECTOR provided for each output to select the desired input signal from the output connectors.

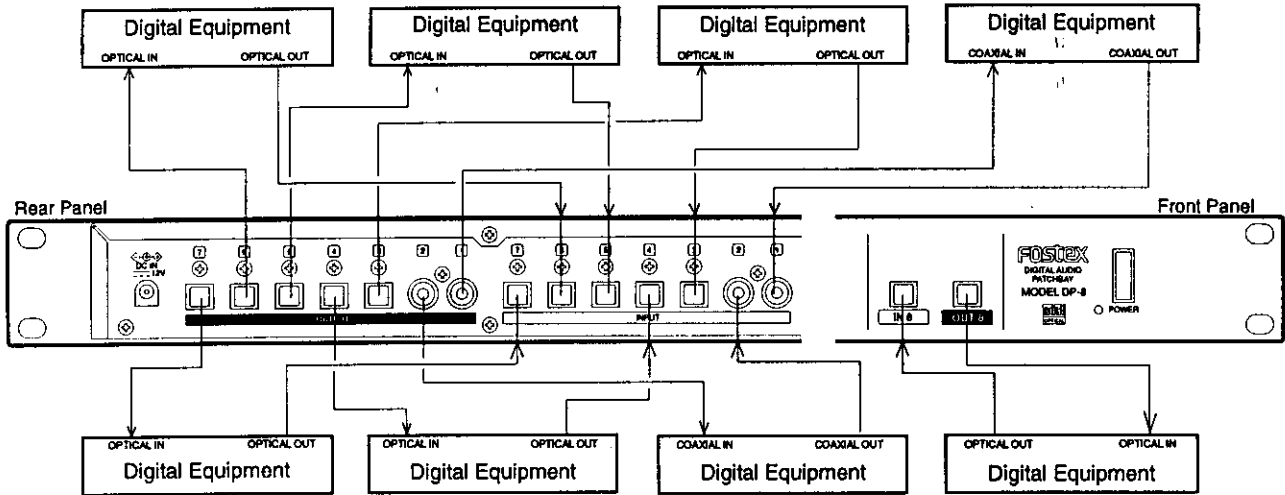

<NOTES>

* Avoid output from COAXIAL OUT (1 and 2) A-dat OPTICAL input signals because external equipment connected might not work correctly due to irregular output waveforms. Equipment requiring A-dat OPTICAL signals must always be connected to OPTICAL OUT (3 - 8).

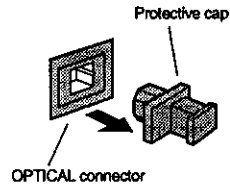

* Protective caps are attached to all OPTICAL IN/OUT connectors as shown at left. Remove this cap when connecting external digital equipment. Always insert this cap on any connector not in use.

<PRECAUTIONS IN CASCADE CONNECTION>

The Fostex DP-8 has been designed for single unit operation. Do not make cascade connections of multiple units of DP-8s. Doing so could cause problems with normal digital clock synchronization with any attached equipment because of increased jitter and duty ratio as shown in the diagram at right.

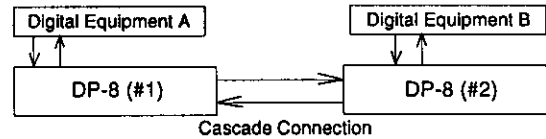

In the connection diagrammed, correct clock synchronization between A and B could be a problem. There is also a possibility of digital noise when transferring sound.

Internal Connections

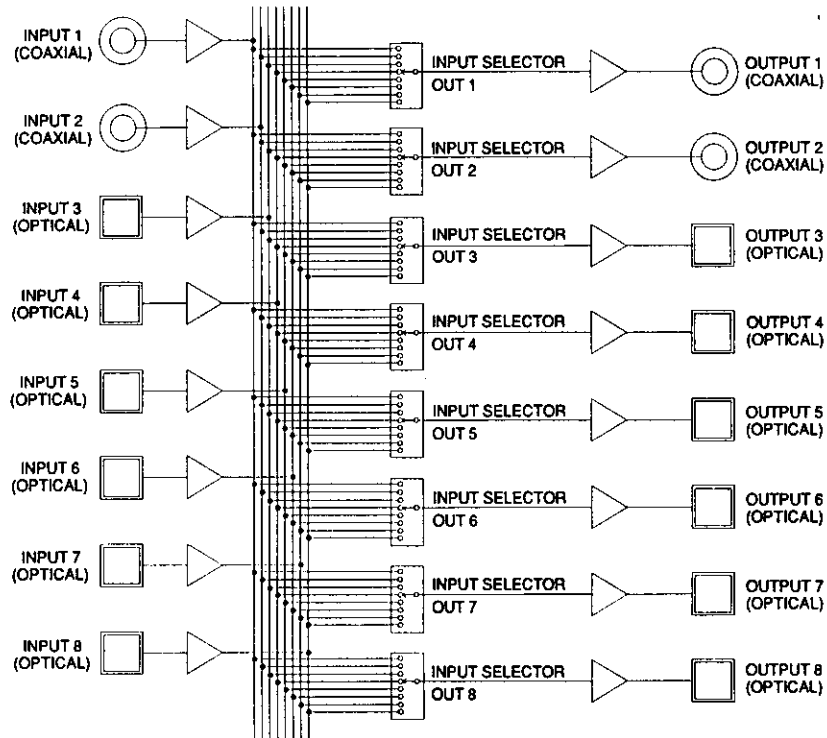

Specifications

INPUT (× 8)

<Input 1, 2 (COAXIAL IN)>

Connector : RCA pin jack
 Input Impedance : 75 Ω
 Standard Input Level : 0.5V p-p

<Input 3-8 (OPTICAL IN)>

Connector : Square OPTICAL
 Format Type : S/P DIF (IEC 958 part 3) and A-dat OPTICAL

OUTPUT (× 8)

<Output 1, 2 (COAXIAL OUT)>

Connector : RCA pin jack
 Output Impedance : 75 Ω
 Standard Output Level : 0.5V p-p (at 75 Ω load)

<Output 3-8 (OPTICAL OUT)>

Connector : Square OPTICAL
 Format Type : S/P DIF (IEC 958 part 3) and A-dat OPTICAL
 Sampling Frequency : 32kHz ~ 48kHz
 Power Supply : DC12V
 (Use exclusive AC adaptor)
 Current Consumption : 220mA
 Physical Dimensions (mm) : 482 (W) × 45 (H) × 113 (D)
 Weight : Main unit - Approx. 1.4kg
 : AC adaptor - Approx. 230g
 Accessories : AC adaptor × 1, Owner's Manual

* Product appearance and specifications subject to change without notice.

* A-dat and the  symbol are registered trade marks of the U. S. Alesis Corporation.

Declaration of EC Directive

This equipment is compatible with the EMC Directive (89/336/EEC) - Directive on approximation of member nation's ordinance concerning the electromagnetic compatibility and with the Low Voltage Directive (73/23/EEC) - Directive on approximation of member nation's ordinance concerning electric equipment designed to be used within the specified voltage range.

The Affect of Immunity on This Equipment

The affect of the European specification EN50082-1 (coexistence of electromagnetic waves - common immunity specification) on this equipment are as shown below.

* In the electrical fast transient / burst requirements, radiated electromagnetic field requirements and static electricity discharging environment, this could be affected by generation of noise and distortion in some cases.

FOSTEX DISTRIBUTORS LIST IN EUROPE * Including non - EU countries. * underlined: contracted distributors (as of November, 1997)

<AUSTRIA>

NAME: ATEC Audio-u. Videogeräte VertriebsgesmbH.
 ADD: Im Winkel 5, A-2325 Velm, Austria
 TEL: (+43) 2234-74004, FAX: (+43) 2234-74074

<BELGIUM>

NAME: EMI N. V.
 ADD: Bijvenestraat 1A, B3500 Hasselt, Belgium
 TEL: (+32) 11-232355, FAX: (+32) 11-232172

<DENMARK>

NAME: SC Sound ApS
 ADD: Malervej 2, DK-2630 Taastrup, Denmark
 TEL: (+45) 4399-8877, FAX: (+45) 4399-8077

<FINLAND>

NAME: Noretron Audio
 ADD: Tonttumuorinkuja 4, FIN-02200 Espoo, Finland
 TEL: (+358) 0-5259330, FAX: (+358) 0-52593352

<FRANCE>

NAME: Musikengro
 ADD: ZAC de Follhoues, B. P. 609, 01706 Les Echets, France
 TEL: (+33) 72 26 27 00, FAX: (+33) 72 26 27 01

<GERMANY>

NAME: Studiosound & Music GmbH
 ADD: Scheppe Gewissegasse 8, D-35039 Marburg, Germany
 TEL: (+49) 6421-12071, FAX: (+49) 6421-15522

<GREECE>

NAME: Bon Studio S. A.
 ADD: 6 Zalmi Street, Exarchia, 106.83 Athens, Greece
 TEL: (+30) 1-3809605-8, 3302059, FAX: (+30) 1-3845755

<ICELAND>

NAME: I. D. eirf. electronic Ltd.
 ADD: Armula 38 108 Reykjavik, Iceland
 TEL: (+354) 588 5010, FAX: (+354) 588 5011

<ITALY>

NAME: Recoton Italia Srl.
 ADD: V. 1 Maggio, N 18, 40050 Quarto Inferiore, (BO) Italy
 TEL: (+39) 51-768576, FAX: (+39) 51-768336

<THE NETHERLANDS>

NAME: IEMKE ROOS AUDIO B. V.
 ADD: Kuiperbergweg 20, 1101 AG Amsterdam, The Netherlands
 TEL: (+31) 20-697-2121, FAX: (+31) 20-697-4201

<NORWAY>

NAME: Siv. Ing. Benum A/S
 ADD: P. O. Box 145 Vinderen, 0319 Oslo 3, Norway
 TEL: (+47) 22-139900, FAX: (+47) 22-148259

<PORTUGAL>

NAME: Caius - Tecnologias Audio e Musica, Lda.
 ADD: Rua de Santa Catarina, 131 4000 Porto, Portugal
 TEL: (+351) 2-2084456/325400, FAX: (+351) 2-314760

<SPAIN>

NAME: Multitracker, S. A.
 ADD: C/Garcilaso No.9, Madrid 28010, Spain
 TEL: (+34) 1-4470700, 1-4470898, FAX: (+34) 1-5930716

<SWEDEN>

NAME: TTS Tal & Ton Studioteknik AB
 ADD: Gelbgjutarevagen 4, S-171 48 Solna, Sweden
 TEL: (+46) 8-7340750, FAX: (+46) 8-824476

<SWITZERLAND>

NAME: Audio Bauer Pro AG
 ADD: Bernerstrasse-Nord 182, CH-8064 Zurich, Switzerland
 TEL: (+41) 1-4323230, FAX: (+41) 1-4326558

<UK>

NAME: SCV London
 ADD: 3A 6-24 Southgate Road, London N1 3JJ, England, UK
 TEL: (+44) 171-923-1892, FAX: (+44) 171-241-3644

Fostex

FOSTEX CORPORATION

3-2-35 Musashino, Akishima-shi, Tokyo, Japan 196-0021

FOSTEX CORPORATION OF AMERICA

15431, Blackburn Ave., Norwalk, CA 90650, U. S. A.

Free Manuals Download Website

<http://myh66.com>

<http://usermanuals.us>

<http://www.somanuals.com>

<http://www.4manuals.cc>

<http://www.manual-lib.com>

<http://www.404manual.com>

<http://www.luxmanual.com>

<http://aubethermostatmanual.com>

Golf course search by state

<http://golfingnear.com>

Email search by domain

<http://emailbydomain.com>

Auto manuals search

<http://auto.somanuals.com>

TV manuals search

<http://tv.somanuals.com>