

Foundry NetIron M2404C and M2404F Metro Access Switches Installation Guide



4980 Great America Parkway
Santa Clara, CA 95054

Tel 408.207.1700

www.foundrynetworks.com

January 2007

Copyright © 2007 Foundry Networks, Inc. All rights reserved.

No part of this work may be reproduced in any form or by any means – graphic, electronic or mechanical, including photocopying, recording, taping or storage in an information retrieval system – without prior written permission of the copyright owner.

The trademarks, logos and service marks ("Marks") displayed herein are the property of Foundry or other third parties. You are not permitted to use these Marks without the prior written consent of Foundry or such appropriate third party.

Foundry Networks, BigIron, FastIron, IronView, JetCore, NetIron, ServerIron, Turbolron, IronWare, Edgelron, IronPoint, the Iron family of marks and the Foundry Logo are trademarks or registered trademarks of Foundry Networks, Inc. in the United States and other countries.

Safety Considerations

This equipment is for use in a restricted access area by qualified personnel only. To avoid electric shock, do not perform any servicing other than those contained in the unpacking instructions.

This equipment contains Electrostatic Discharge (ESD) sensitive components. Use ESD protection before servicing or installing components of this system.

CAUTION Changes or modifications made to this device that are not expressly approved by the party responsible for compliance could void the user's authority to operate the equipment.



CAUTION Remove the power cord from a power supply before you install it in or remove it from the device. Otherwise, the power supply or the device could be damaged as a result. (The device can be running while a power supply is being installed or removed, but the power supply itself should not be connected to a power source.)



CAUTION All devices with DC power supplies are intended for installation in restricted access areas only. A restricted access area is where access can be gained only by service personnel through the use of a special tool, lock and key, or other means of security, and is controlled by the authority responsible for the location.



WARNING The equipment is designed to be used with Class 1 Laser fiber optic transmitters which may endanger your eyes.



Do not look directly into the fiber optic cables or transmitter.

WARNING HIGH VOLTAGE



Disconnect the product from the power line before removing the cover. Any adjustment and maintenance of the opened device should be done only while the device is disconnected from its source of power and should only be performed by qualified personnel, authorized by Foundry Networks.

WARNING **GROUNDING**



Before connecting the product to the power line, make sure that the protective ground terminal of the device is connected to the safety ground conductor of the mains power cord.

The main power supply plug should only be inserted in a socket outlet provided with a connected safety ground. The protective action must not be negated by use of an extension cord (power cable) without a protective conductor (grounding). Any interruption of the protective (grounding) conductor or disconnection of the protective ground terminal can make the device unsafe to use. Intentional interruption is prohibited.

This equipment has a connection between the earthed conductor of the DC supply circuit and the grounding conductor.

WARNING **WIRING FOR NATIONAL POWER PLUG**



A mains power cable according to National Electrical Code (NEC) with molded IEC socket is supplied with each unit. The specific national mains power plug should be wired as follows:

- Brown lead Live (phase)
 - Blue lead Neutral
 - Green/Yellow lead Safety ground.
-

WARNING **LINE VOLTAGE**



Before connecting the product to the power line, make sure the voltage of the power source matches the requirements of the product, as marked on the label located near the power connectors.

WARNING **DC POWER SOURCE**



The DC power source should be protected with a branch circuit over-current protection rated at 10Amp, located in the building installation

Table of Contents

ABOUT THIS DOCUMENT	1
WHO SHOULD USE THIS GUIDE	1
HOW THIS DOCUMENT IS ORGANIZED	1
CONVENTIONS USED IN THIS DOCUMENT	2
RELATED PUBLICATIONS	2
OVERVIEW	3
INTRODUCTION	3
HARDWARE DESCRIPTION	4
FRONT PANEL	4
<i>NetIron M2404C Front Panel Main Components</i>	5
<i>NetIron M2404F Front Panel Main Components</i>	5
UNIT LEDs	6
PORT STATUS LEDs	7
<i>NetIron M2404C Port Status LEDs</i>	7
<i>NetIron M2404F Port Status LEDs</i>	7
<i>NetIron M2404F Dual-Mode Port Status LEDs</i>	8
REAR PANEL – WITH AC POWER-SUPPLY UNITS	9
<i>Panel Main Components</i>	9
REAR PANEL – WITH DC POWER-SUPPLY UNITS.....	10
<i>Panel Main Components</i>	10
POWER SUPPLY UNITS	10
BLANK COVERS	11
INSTALLATION AND SETUP	13
PACKING LIST	13
UNPACKING	13
RACK MOUNTING	13
<i>Rack Mounting Specifications</i>	14
ETHERNET CABLES	15
CONSOLE INTERFACE.....	15
DC POWER INSTALLATION.....	15
GROUNDING THE SWITCH	16
LASER SAFETY.....	17
INITIAL CONFIGURATION USING THE CONSOLE	18
INITIAL CONFIGURATION	18
SAVING CONFIGURATION IN A TEXT FILE	19
DOWNLOADING CONFIGURATION FROM BACKUP TEXT FILE.....	20
RELOADING FACTORY DEFAULTS CONFIGURATION	20
MONITORING/CONFIGURING CPU OPERATING TEMPERATURE.....	20
<i>Temperature Management Commands</i>	21
MONITORING THE POWER SUPPLIES STATUS	22
BUILT-IN SELF TEST (BIST)	23
BIST TEST RESULTS REVIEW	23
STARTUP EXECUTION OF BIST	24
SOFTWARE DOWNLOAD	26

SOFTWARE IMAGE NAMING CONVENTIONS	26
DOWNLOADING A SOFTWARE IMAGE TO THE SWITCH USING TFTP	26
<i>Preparing to Download an Image Using TFTP</i>	26
<i>Downloading a Device Software Image Using TFTP</i>	26
<i>Downloading a NI-M2404WebView Image Using TFTP</i>	28
SOFTWARE UPGRADE VIA ETHERNET PORT (OUTBAND).....	29
HOT-SWAPPING A POWER SUPPLY.....	30
SPECIFICATIONS	31
PHYSICAL SPECIFICATIONS	31
<i>Dimensions</i>	31
OPERATING CONDITIONS	31
MANAGEMENT FEATURES.....	32
SAFETY AND ELECTROMAGNETIC COMPATIBILITY	32
<i>Safety</i>	32
<i>EMC</i>	32
<i>FCC 47 CFR: 2003 part 15 subpart B, class A</i>	33
<i>CISPR 22 CLASS A Warning</i>	33
<i>VCCI (Japan) (Class A)</i>	33
APPENDIX A: CAUTIONS AND WARNINGS	34

About This Document

Who Should Use This Guide

The procedures in this manual are for trained and qualified service personnel who are proficient with network switching and routing concepts. Installation, replacement and maintenance of the equipment described in this guide may only be done by trained and qualified service personnel.

How This Document is Organized

This document contains the following chapters.

Chapter	Contains
1. About This Document	The intended audience and the organization of this document, the conventions used in this document, and reference to related publications.
2. Overview	An introductory description of the platform, a list of the product's main features and a partial list of the management options implemented by the device software image that is installed on the platform.
3. Hardware Description	The front components, including traffic ports, management ports and LEDs; The AC and DC power-supply options in the rear panel; base-board components and the hot-swappable power-supply units.
4. Installation and Setup	Packing list, instructions for unpacking, rack-mounting, desktop installation, Ethernet cables, DC power installation safety precautions, grounding, and Laser safety.
5. Initial Configuration Using the Console	How to use the Command Line Interface (CLI) to configure the platform and monitor its temperature, the power source status and the status of the fans.
6. Built-In Self Test (BIST)	Set of basic built in tests performed automatically at startup and optionally by user's request.
7. Software Download	How to upgrade the software via the network.
8. Hot-swapping Modules	How to replace an access module or a redundant power-supply unit without interrupting operation.
9. Specifications	Physical specifications, operating conditions and management features.

Conventions Used in this Document

This document uses the following formatting styles and conventions:

- CLI syntax and coded examples are represented by mono-space characters and enclosed in rectangular frames. Under this category:
 - Text issued by the device software is represented by `regular` characters.
 - In command syntax specifications, text to be entered by the user is represented as follows:

Command names and keywords appear as **bold upright** characters.

Argument values (numeric or literal) that the user must supply are represented by *bold italic* characters, enclosed in angle-brackets.

For example: `<a.b.c.d>` represents an IP address, `<0-4094>` represents a range of numerical values, and `<filename>` represents a character string.

- In coded examples, all text demonstrated as entered by the user appears in **bold upright** characters.
- Command names and keywords in other text structures (especially in instruction steps) appear in bold characters.
- Notes appear in bold characters and should never be ignored.

Related Publications

The software used for initial and network configuration of the device is described in the *Software User Guide*.

IMPORTANT NOTE

User Documentation for NetIron M2404 Software and the Java™-based graphical manager may be downloaded from the Foundry Website (www.foundrynetworks.com).

Overview

Introduction

High powered networks require a combination of speed and robust services support to be able to provide the intensive and fluctuating demands of their end users. To answer these requirements, the network needs to provide data transmission at wire speed performance in a non-blocking fashion. This switch is an enhanced Metro Ethernet CPE platform designed to provide wire speed non-blocking Layer-2 and Layer-3 switching architecture as well as Hierarchical Virtual Private LAN Services (HVPLS) hubs-and-spokes and MPLS based rings support.

The platform capabilities include Ethernet LAN/ Line services, use of advanced Hierarchical QoS (tens of thousands of queues) as well as Hierarchical Virtual Private LAN Services (HVPLS) hubs-and-spokes and MPLS based rings support. The platform offers services convergence such as voice, data and video over Gigabit Ethernet, Enhanced Gigabit Ethernet (MPLS/ VPLS).

There are two flavors to the NetIron M2404, the NetIron M2404C and the NetIron M2404F.

(1) NetIron M2404C accommodates 24 Fast Ethernet copper ports and 4 Gigabit Ethernet ports;

(2) NetIron M2404F accommodates 24 Fast Ethernet fiber ports and 4 Gigabit Ethernet ports.

The platforms are identical in their performance.

NOTE Throughout this guide, both switches are referred to as “NetIron M2404”, “the platform” or “the switch”, unless relating to a specific platform.



Figure 1: NetIron M2404F



Figure 2: NetIron M2404C

Hardware Description

Front Panel

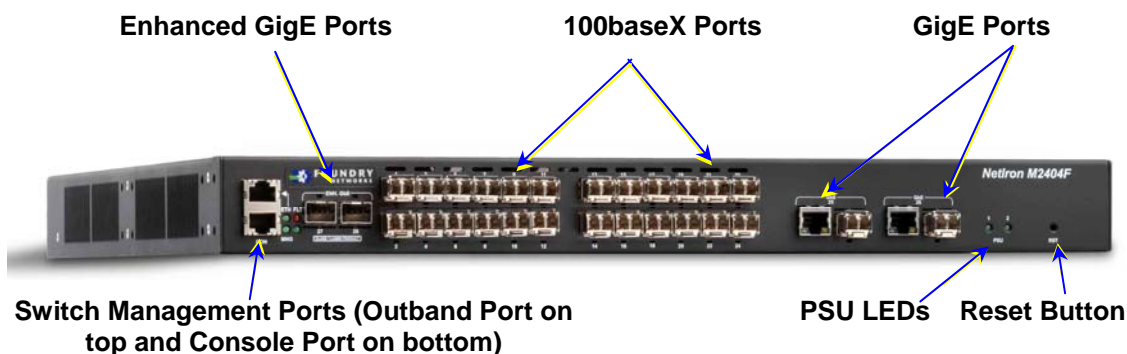

Figure 3: NetIron M2404F Platform Front Panel

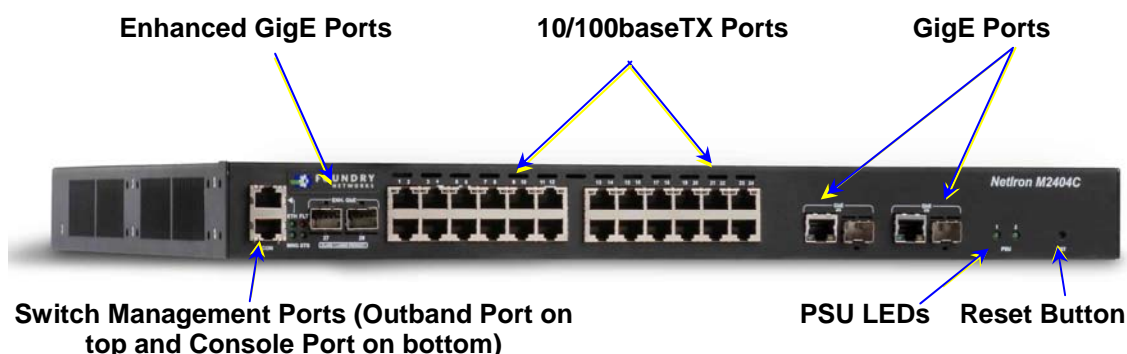

Figure 4: NetIron M2404C Platform Front Panel

To prepare for installation, make sure you have an ESD wrist strap that can be attached to a grounded metal surface. Put on the ESD wrist strap and ground yourself by attaching the clip end to a grounded metal surface (such as an equipment rack) to act as ground.

WARNING



For safety reasons, the ESD wrist strap should contain a series 1 meg ohm resistor.

To install an SFP transceiver into a port, do the following:

1. Put on the ESD wrist strap and ground yourself by attaching the clip end to a grounded metal surface (such as an equipment rack) to act as ground.
2. Remove the new module from its protective packaging.

3. Gently insert the SFP transceiver into the port until the module clicks into place. The module is keyed to prevent incorrect insertion. See [Figure 5](#).

Important Note

When inserting an SFP transceiver into ports marked 27 or 28, verify that the SFP is facing upside -down (as shown in figure below). All other SFP ports on the switch face right-side up.

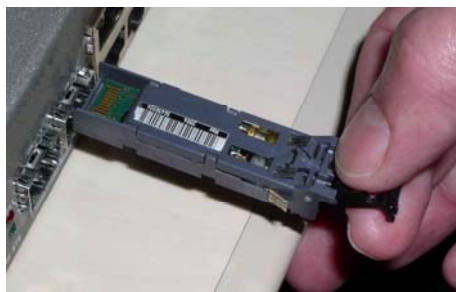

Figure 5: Inserting an SFP, upside-down, into the Enhanced GigE Slot

NetIron M2404C Front Panel Main Components

Component	Description
For NetIron M2404C: 10/100baseTX Ports	24 RJ-45 sockets with 10/100 Mbps LAN speed auto sensing, marked 1 to 24.
GigE Dual-Mode Ports	Two dual-mode 1000baseX interface (SFP) or 10/100/1000BaseT (RJ45) marked 25 and 26.
Enhanced GigE Ports	Two 1000baseX interface (SFP) marked 27 and 28. Please note that the SFP transceivers are inserted into the slot, belly- down , as shown in figure above.
Console Management Port	RJ45 socket for CLI configuration and management of the unit.
Ethernet Management Port	RJ45 socket with 10/100 Mbps LAN speed auto sensing for out-of-band Ethernet management and software update.
RST Button	Reset button. To avoid accidental activation, the button is recessed behind the panel. Press with a pin or a similar narrow object.

NetIron M2404F Front Panel Main Components

Component	Description
For NetIron M2404F: 100baseX Ports	24 SFP sockets marked 1 to 24.

Component	Description
GigE Dual-Mode Ports	Two dual-mode 1000baseX interface (SFP) or 10/100/1000BaseT (RJ45) marked 25 and 26.
Enhanced GigE Ports	Two 1000baseX interface (SFP) marked 27 and 28. Please note that the SFP transceivers are inserted into the slot, belly-down, as shown in figure above.
Console Management Port	RJ45 socket for CLI configuration and management of the unit.
Ethernet Management Port	RJ45 socket with 10/100 Mbps LAN speed auto sensing for out-of-band Ethernet management and software update.
RST Button	Reset button. To avoid accidental activation, the button is recessed behind the panel. Press with a pin or a similar narrow object.

Unit LEDs

The following describes the LEDs on the chassis.

Label	Function	Indication
ETH	Ethernet management interface status.	<ul style="list-style-type: none"> • Off – Link down. • Green – Link up. • Blinking green – activity.
FLT	Platform HW fault.	<ul style="list-style-type: none"> • Off – Switch hardware OK. • Red – CPU can't boot. • Blinking red – Failure during BIST.
MNG	CPU controller is processing management tasks.	<ul style="list-style-type: none"> • Off – No management activity. • Green – Management activity.
STS	General platform status.	<ul style="list-style-type: none"> • Off – Platform processing boot loader. • Green fast blink – Platform initializing application. • Green – Normal operation.
PSU #1	PSU #1 status.	<ul style="list-style-type: none"> • Green – PS #1 functioning. • Red – Problem in PS #1 or no power feed. • Off – PS #1 removed.
PSU #2	PSU #2 status.	<ul style="list-style-type: none"> • Green – PS #2 functioning. • Red – Problem in PS #2 or no power feed. • Off – PS #2 removed.

Port Status LEDs

A status LED is associated with each port.

Port Status	Indication
Link	Green
Activity	Blinking green
Fault/disabled	Amber

NetIron M2404C Port Status LEDs

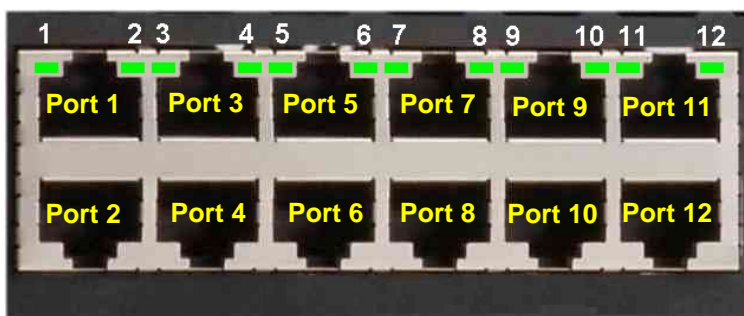

Figure 6: Location of NetIron M2404C Port Status LEDs

The port status LEDs (1 to 24) for NetIron M2404C are situated on the upper row of ports. The LED on the left side of each upper port is associated with that port. The LED on the right side of each upper port is associated with the port underneath that port.

NetIron M2404F Port Status LEDs

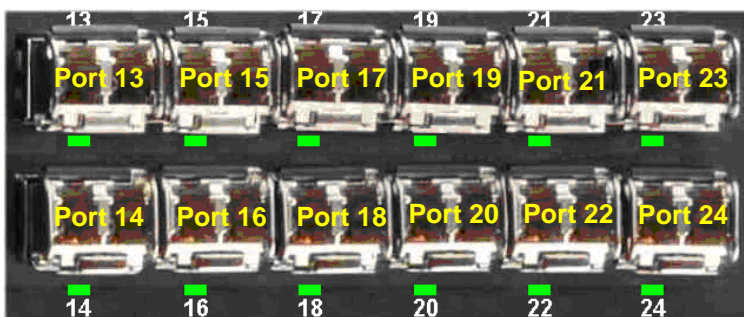

Figure 7: Location of NetIron M2404C Port Status LEDs

The port status LEDs (1 to 24) for NetIron M2404F are situated below each SFP.

NetIron M2404F Dual-Mode Port Status LEDs

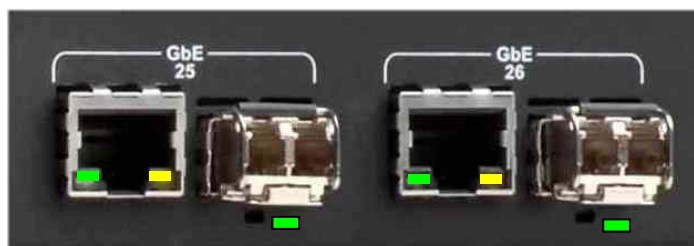

Figure 8: Location of NetIron M2404F Dual-Mode Port Status LEDs

Dual-mode port status LEDs are associated with dual-mode RJ45/SFP GiGE ports 25 and 26.

RJ-45 Indicators

RJ45 Dual-Mode Port Status	Indication
Link/Activity	Left LED is Green
Disabled	Right LED is Amber

SFP Indicators

SFP Dual-Mode Port Status	Indication
Link	Green
Activity	Blinking green
Disabled	Amber

Rear Panel – with AC Power-Supply Units

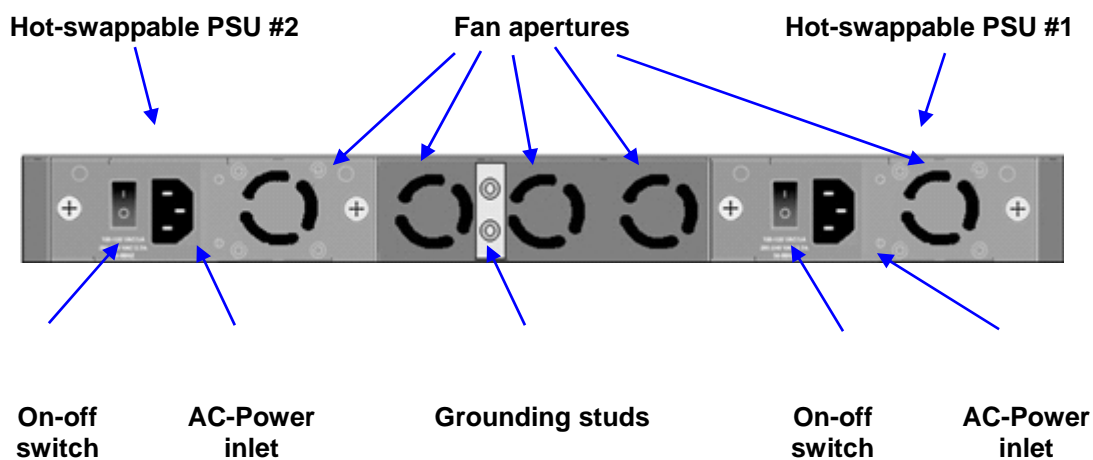

Figure 9: Rear Panel with AC PSUs

Panel Main Components

Two AC Power supplies	As specified in Power Supply Units .
Two grounding posts	Designed for a UL-listed two-hole long-barrel 5/8 10 AWG compression lug. <i>Burndy YAZV10-2TC14</i> or an equivalent is recommended.

Rear Panel – with DC Power-supply Units

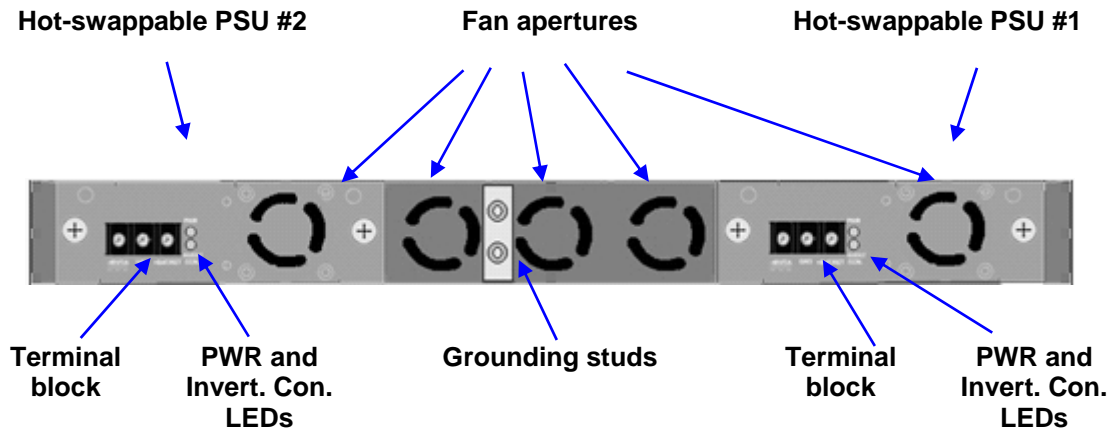

Figure 10: Rear Panel with DC PSUs

Panel Main Components

Two DC Power supplies	As specified in Power Supply Units .
Two grounding posts	Designed for a UL-listed two-hole long-barrel 5/8 10 AWG compression lug. <i>Burndy YAZV10-2TC14</i> or an equivalent is recommended.

Power Supply Units

Power is fed to the platform via two redundant hot-swappable power supply units (PSUs). The following PSU versions are available:

ACPS	Dual-range AC power supply: 100-120 VAC@ 5A or 200-240VAC@ 2.5A 50/60 Hz
DCPS	DC power supply: -48VDC Nominal @ 3A (minimum: -36V ; maximum -72VDC)



Figure 11: AC Power Supply Unit

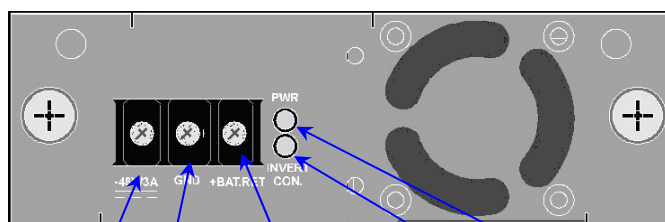

DC power-supply terminals:

-48V/3A **GND** **+BAT.RET**

LEDs:

INVERT CON. **PWR**

Figure 12: DC Power Supply Unit

The DC power supply panel has the following components:

Input terminals:

-48V/3A	Negative DC input terminal
GND	Ground terminal internally connected to the platform's ground line
+BAT.RET	Positive DC input terminal

NOTE Neither the **+BAT.RET** nor the **-48VDC** is connected to the **GND** terminal. If required, this can be performed externally by the user.



LEDs:

PWR	Glows green when power is on
INVERT CON.	Glows red to indicate inverted DC polarity

Blank Covers

To avoid overheating of the components by improper air-flow, always keep empty slots covered. Use the panel screws on the supplied blank faceplates and blank filler to fasten the blanks to the appropriate empty slots.

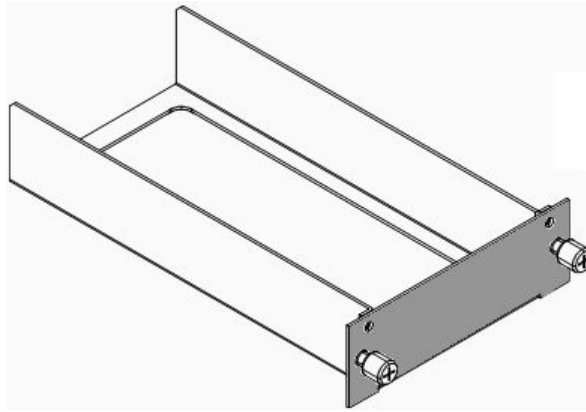

Figure 13 Blank Filler for Empty Power-Supply Slot

Installation and Setup

This section provides installation and setup instructions. The platform can be installed in a standard 19-inch rack or as a standalone unit in a desktop configuration.

Packing List

The shipping package includes the following items:

- NetIron M2404F /NetIron M2404C platform.
- One AC (**ACPS**) or DC (**DCPS**) power-supply unit, installed.
- One power cable.
- Two rack-mounting brackets with screws
- Console cable
- 1 Blank PSU filler
- Documentation CD

WARNING

If the installation requires a power cord other than the one supplied with the device, make sure you use a power cord displaying the mark of the safety agency that defines the regulations for power cords in your country. The mark is your assurance that the power cord can be used safely with the device.

Unpacking

The platform is factory tested and inspected prior to shipment. In case of damage to the unit during shipment, contact your local dealer.

It is recommended that you keep the shipping package until the unit has been installed and verified as operational. The platform, like all electronic devices with static sensitive components, should be handled with care.

Rack Mounting

The supplied mounting brackets can be attached to the sides of the chassis either flush with the front panel (flush-mounting) or midway between the front and rear panels (mid-mounting). Use the supplied screws to fasten the mounting brackets to the chassis in the required position (flush or mid-mounting).

Before mounting any equipment onto the rack, make sure that there is generous clearance behind the rack for proper ventilation and for easy access to the rear components. Do not place objects that might obstruct airflow behind the chassis.

WARNING



Make sure the rack or cabinet housing the device is adequately secured to prevent it from becoming unstable or falling over.

Rack Mounting Specifications

Width	Basic body: 440 mm (17.4") Overall, including brackets: 483 mm (19")
Height	44 mm (1.73") = 1 RU
Depth	414 mm (16.3")
Distance between mounting holes	Horizontal: 465 mm (18.3") Vertical: 31.75 mm (1.25") Vertical separation: 12.7 mm (0.5")

Note that there is no need to leave vertical spacing between units on a rack, as heat is dissipated through ventilation holes in the front, rear and sides of the unit.

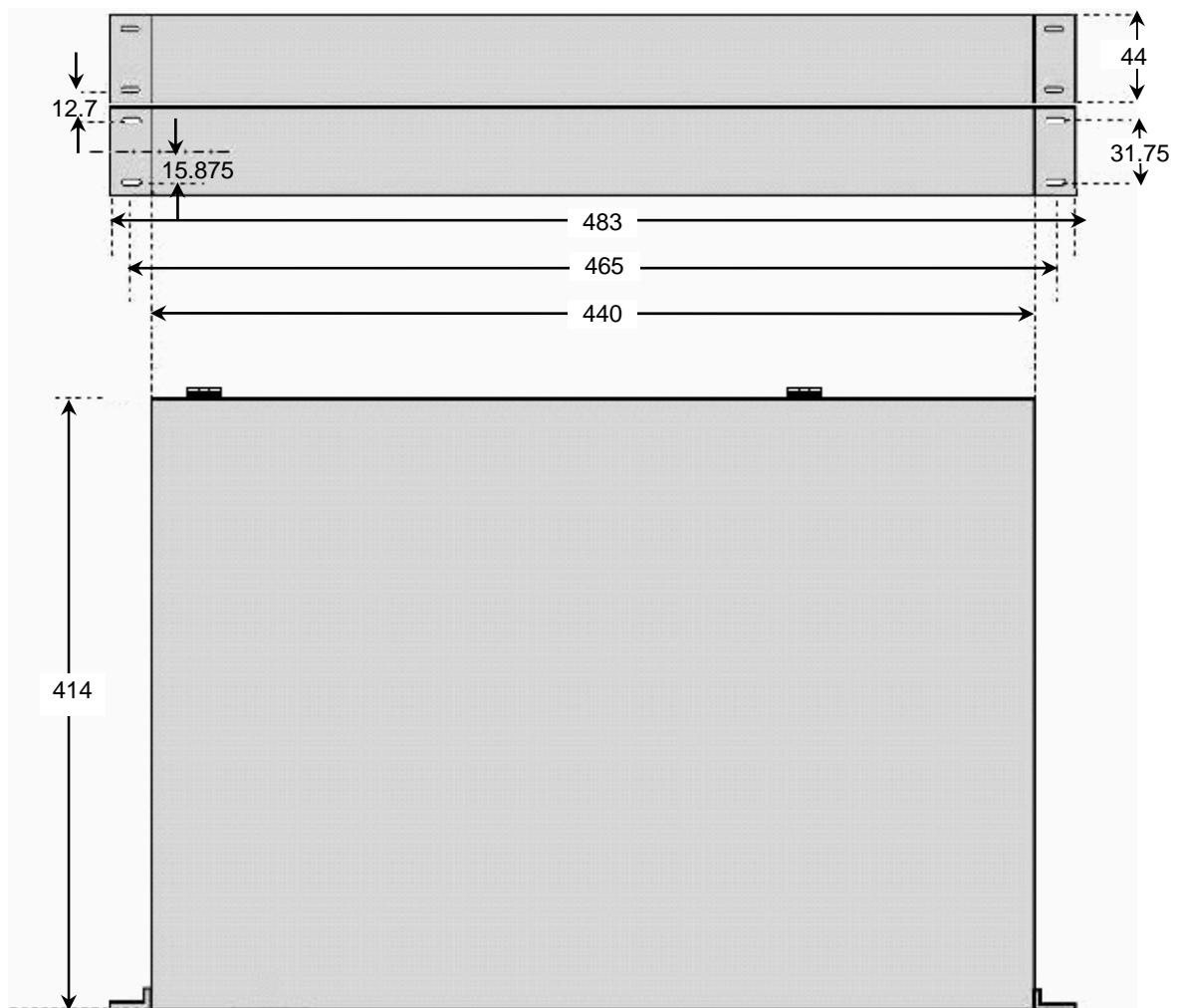

Figure 14: Dimensions in mm for Rack-mounting

Ethernet Cables

When connecting an RJ-45/RJ-48 port to an end station, workstation or server, use a standard RJ-45/RJ-48 pin-out cable.

Console Interface

A simple menu-driven interface provides for system initialization and diagnostics. The Console interface is EIA232 VT-100 compatible. The primary purpose of the terminal interface is to set basic operational parameters.

The terminal interface is password protected. By default there is no password set for the terminal interface.

Using the enclosed serial cable (see table below for wiring), connect the RJ-45 connector to the connector marked "Console" and the other side to the 9-pin serial port connector on the back of your PC.

The supplied cable has the following pinout:

Switch Side	PC Side
RJ-45 Pin #	DB-9 Female
3	2
2	3
5	5

NOTE You can also use a RJ-45/DB-9 cable.



DC Power installation

The DC supply source is to be located within the same premises as this equipment. The DC power source should be protected with a circuit breaker with a rating of 10Amp as disconnect device, connected to the non-grounding conductor. The unit shall be connected directly to the DC supply system; there shall be no switching or disconnecting devices in the earthed circuit conductor between the DC source and the point of connection of the grounding electrode conductor.

This equipment shall be located in the same immediate area (such as, adjacent cabinets) as any other equipment that has a connection between the earthed conductor of the same DC supply circuit and the grounding conductor, and also the point of grounding of the DC system. The DC system shall not be earthed elsewhere.

For each DC power block a set of a minimum 2x18AWG cables shall be used with suitable end terminal legs matching the conductor's gauge. Use a RED lead to for the positive conductor and a BLACK lead for the negative conductor. It is recommended that only UL listed components be used for the DC power connections.

CAUTION For a DC system, use a grounding wire of at least 10 American Wire Gauge (AWG). The 10 AWG wire should be attached to an agency-approved crimp connector, crimped with the proper tool. The crimp connector should allow for securement to both ground screws on the enclosure.



CAUTION For the DC input circuit to the system, make sure there is a Listed 10 amp circuit, minimum -48Vdc, double pole, on the input to the terminal block. The input wiring for connection to the product should be Listed copper wire, 18 AWG, marked VW-1, and rated minimum 90 deg. C.



NOTE There is no connection needed for GND. Only the ground wire is connected to the Grounding Stud.



Grounding the Switch

WARNING Before connecting power to the switch, make sure that both grounding posts in the rear panel are firmly connected to a reliable ground through a #10 AWG grounding wire terminated by a UL-listed two-hole long-barrel 5/8 10 AWG compression lug with hole size and spacing as shown in [Figure 15](#) below.



The *Burndy YAZV10-2TC14* or an equivalent UL-listed two-hole compression lug is recommended.

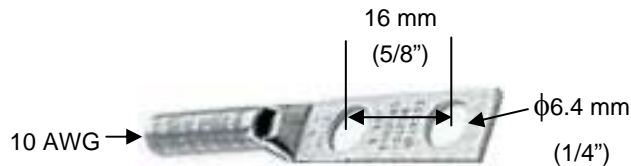

Figure 15: Compression Grounding Lug

To connect the switch to the ground, proceed as follows:

1. Prepare a minimum #10 AWG grounding wire terminated by a crimped two-hole lug with hole diameter and spacing as shown in [Figure 15](#). Use a suitable crimping tool to fasten the lug securely to the wire. Adhere to your company's policy as to the wire gauge and the number of crimps on the lug.

2. Remove the bolts and spring-washers from the grounding posts on the switch's rear panel, and clean the metal surface underneath with a dry cloth if necessary.
3. Apply some anti-oxidant onto the metal surface.
4. Mount the lug on the two grounding posts, replace the spring-washers and fasten the bolts. Avoid using excessive torque.
5. Connect the grounding wire to a reliable ground. If the switch is mounted in a rack, use a common ground for all devices on the rack, according to your company's policy.

Laser Safety

The device is provided with SFP sockets in which fiber optic transceivers may be installed. In order to meet the safety requirement of Class 1 fiber optic laser emission levels, only fiber optic transceivers which comply with IEC 60825-1 or IEC 60825-2 and FDA 21 CFR 1040.10 and CFR 1040.1 must be used.

Initial Configuration Using the Console

Initial Configuration

The Configuration command-language interface (CLI) is accessed by using a VT-100 (or compatible terminal) to the console port of the switch. The terminal port parameters are fixed at: 9600 bps, 8 data bits, 1 stop bit, no parity and without flow control. This provides a convenient method for initial setup of the switch. System parameters are stored in a non-volatile memory. They need to be set up only during the initial setup or when the system has been reset to the factory defaults.

The following keys are used to access the menu:

Enter	Ends an input line
Backspace	Clears last character in input mode
Tab	Auto-Completes a command

A screen similar to the following example appears on the Console Port at power up or reset:

```

////////////////////////////////////
//
// Foundry Networks
//
// Switch model   : NETIRON M2404F
// SW version    : 2.0.00   created January 12 2007 - 21:35:37 //
//
////////////////////////////////////

User Access Verification

Password:
    
```

There is no default password, press <Enter> for password.

NOTE You can configure the password later.



Type ? to display the available commands:

```

device-name>?
alias      An alias of a command
dir        List files in flash.
display    Display file.
enable     Turn on privileged mode command
exit       Exit current mode and down to previous mode
help       Description of the interactive help system
ls         List files in flash.
no         Negate a command or set to defaults
    
```

quit	Disconnect and logout
show	Show running system information
terminal	Terminal configuration setup
who	Display who is on vty

To continue initial configuration procedure perform the following steps:

1. Enter privileged (Enable) mode. Type the command: **enable**.
2. Enter configure mode. Type the command: **configure terminal**.
3. Set the switch IP address: Type the command: **ip address <aa.bb.cc.dd/yy>**, where **<aa.bb.cc.dd>** is the IP address assigned to the switch and **yy** is the number of bits in the netmask (e.g. netmask of 255.255.255.0 would be **/24**).
4. Set the default gateway IP address if the host is on a different subnet: Type the command: **ip route 0.0.0.0/0 <aa.bb.cc.dd>** where **<aa.bb.cc.dd>** is the IP address of the default gateway.
5. Return to privileged (Enable) mode: Type the command: **end**.
6. To verify if the IP addresses were set correctly, type: **show ip**.

Example:

```
device-name#show ip
IP-ADDR : 100.100.100.1 NET-MASK : 255.255.255.0
```

NOTE The **show** command can be used to display a variety of parameters: Setup Configuration and others. To view the show command options type: **show ?**



7. Type the command: **write** from privileged (Enable) mode.

At this point the Initial configuration setup is completed and the switch can be accessed using **Ping** or **Telnet** commands.

Saving Configuration in a Text File

A variety of TFTP Server programs can be used by the host computer where the software images and configuration files are located. The only information that is required by the TFTP Server is the location of the file on the host computer's file system.

It is recommended that the configuration be saved in an external text backup file. To write the backup configuration file, use the command **copy**.

To view the copy command options type: **copy ?**

```
device-name#copy ?
FILE-NAME          Source file. Format: [[device/]path]file-name
                   device: flash: - local file system
                   tftp://A.B.C.D - TFTP server
                   Example: tftp://1.1.1.1/directory/filename.bin
```

```

application      Application downloading image
java             Java downloading image
running-config   Copy running config...
startup-config   Startup configuration data

```

To write the backup configuration file, type:

```
device-name#copy startup-config <IP address> <filename>
```

<filename> is the file where the configuration file was saved.

Downloading Configuration from Backup Text File

The configuration file can be easily downloaded, using the **copy** command. Type:

```
copy tftp://<Server IP address>/<filename> startup-config
```

<filename> is the file where the configuration file was saved.

NOTE  The **copy** command uses TFTP protocol for its execution, so prior to using the **copy** command, verify that the TFTP Server program is executed by the addressed computer.

Reloading Factory Defaults Configuration

Use the **reload** command to reload the factory defaults configuration.

```

device-name#reload to-defaults
Restore factory setting and Reboot the Switch !
[y/n]: y
Rebooting ...

```

NOTE  The **reload to-defaults** command does NOT change the IP address and netmask of the switch.

Monitoring/Configuring CPU Operating Temperature

Should the temperature reach the configured upper limit, the unit will send an SNMP trap to the management station. If this occurs, the user is requested to make sure that all unit ventilation airways are free and disengaged and that the fans are functioning.

Temperature Management Commands

Viewing the Status:

```
device-name#show temperature
CPU Temperature = 28C / 82F

device-name#show temperature high-limit
CPU Temperature high limit = 20C / 68F
```

Configuring Temperature Management Parameters:

```
device-name#configure terminal
device-name(config)#monitor temperature
device-name(config monitor temperature C)#limit
NUMBER Value of limit for alerting current test
device-name(config monitor temperature C)#limit 70
```

Viewing the Temperature Setting from a Running Configuration:

```
device-name#show running-config
Building the configuration ...
! Current Configuration:
!
! Version 2.0
!
password alFhfHKwXHFLU
ip address 10.4.1.5 255.255.0.0
!

! Switch Monitoring configuration:
!
monitor temperature
enable
limit 70
!
```

Restoring the Default Value:

```
device-name#configure terminal
device-name(config)#monitor temperature
device-name(config monitor temperature C)#default
```

Monitoring the Power Supplies Status

Viewing the status during system boot:

```
BUILT-IN SELF TEST
-----
CPU Core Test      : Passed
CPU Interface Test : Passed
Data Buffer Test    : Passed
Power Supply Test  : Passed
On-board Power Test : Passed
Fan Test           : Passed
```

Viewing the status during operation:

The Power Supply status is available on the DC and dual-feed AC models only. The possible values are **OK**, **Failed**, and **Not Installed**.

```
device-name#show power-supply
Power supply 1      : OK
Power supply fan 1 : OK
```

Built-In Self Test (BIST)

The BIST performs a set of basic hardware and configuration validity tests. Tests in the BIST are sorted into several groups – for example, the tests of the Power Supply units belong to a Power Supply Test group.

Startup BIST - The BIST is performed automatically on startup. The results are summarized on the terminal before the switch banner.

BIST by request - A user may request BIST execution at any time by using a CLI command.

The current BIST status may be read and cleared by using CLI commands. When the BIST detects a failure in any of the tests, it causes the **Status** LED indicator to blink.

The switch supports the following tests:

- CPU Core Test
- CPU Interface Test
- Data Buffer Test
- Power Supply Test
- On-Board Power Test
- Fan Test
- Temperature Test.

[Table 1](#) describes the tests.

Table 1: Description of the Built-in Tests

Test	Description
CPU Core Test	Checks CPU block integrity
CPU Interface Test	Checks the existence of the UART (register write/read operation). Both COM1 and COM2 are checked.
Data Buffer Test	Checks the integrity of NVRAM database.
Power Supply Test	Checks the existence and status of the DC power supplies. If both DC power supplies are connected, the test will result with Passed . When one of the DC power supply is disconnected, the test will result with Failed .
Fan Test	Checks the status of the 3 fans.
On-Board Power Test	Checks the 5 On-Board Power levels: 3.2V, 2.5V, 1.8V, 1.5V and 1.25V.
Temperature Test	Validates temperature ranges inside the device and tests temperature sensors.

BIST Test Results Review

If any of the BIST tests fail, the FLT LED starts blinking. To display BIST results, perform the following steps:

1. Connect a terminal cable to Console port.

2. Re-power the unit, if required.
3. Use the **show self-test** command in Privileged (Enable) mode. If you prefer to display all BIST results, use the **show self-test full** command instead.

To invoke a BIST by Request at any time while the switch is running, use the **self-test** command in Privileged (Enable) mode.

The switch will automatically start up in debug mode when one of the five On-Board power levels deviates by 2% above or below the required level. See the explanation below.

Startup Execution of BIST

The startup BIST reports a summary of the results by BIST group. If all tests of the group pass, Passed is displayed for all groups.

```
Press any key to stop auto-boot...
0
auto-booting...

Uncompressing 4329228 bytes...
Loading image... 17671392

Init TFFS

BUILT-IN SELF TEST
-----
CPU Core Test       : Passed
CPU Interface Test  : Passed
Data Buffer Test     : Passed
Power Supply Test   : Passed
On-board Power Test : Passed
Fan Test            : Passed
```

If any test in the group except the On-Board Power fails, Failed is displayed for the entire group and the switch starts normally. In such cases, the switch starts in debug mode (switching disabled and the switch is running with the default configuration). If one of the On-Board Power level checks fails, the switch will not initialize the ports and will start in a special debug mode, as shown below:

```
Press any key to stop auto-boot...
0
auto-booting...

Uncompressing 4329228 bytes...
Loading image... 17671392

Init TFFS

BUILT-IN SELF TEST
-----
CPU Core Test       : Passed
CPU Interface Test  : Passed
Data Buffer Test     : Passed
Power Supply Test   : Passed
On-board Power Test : Passed
Fan Test            : Passed
```

```

////////////////////////////////////
//.....//
//  FOUNDRY NETWORKS //
// //
// Switch model   : FOUNDRY NETWORKS NETIRON M2404F 256M //
// SW version    : 2.0.00 created January 15 2007 - 21:35:37 //
// //
////////////////////////////////////

User Access Verification

Password:
device-name>

```

In this case, you can enter into Enable mode as usual, and examine the detailed Self-Test results.

For example:

```

device-name#self-test
Processing BIST by request...

CPU Core Test      :
  CPU Validation    - Passed

CPU Interface Test :
  UART Existence   - Passed

Data Buffer Test    :
  Application Image Validity - Passed
  Java Agent Image Validity - Passed
  PROM Device Access Validity - Passed

Power Supply Test  :
  Power Supply 1    - Passed
  Power Supply Fan 1 - Passed
  Power Supply 2    - Not installed
  Power Supply Fan 2 - Not installed

On-board Power Test :
  On-board Power 3.3V - Passed
  On-board Power 2.5V - Passed
  On-board Power 1.8V - Passed
  On-board Power 1.25V - Passed

Fan Test           :
  Fan 1            - Passed
  Fan 2            - Passed
  Fan 3            - Passed

Temperature Test   :
  Temperature      - Passed

```

Software Download

The executable software image contained on the platform can be upgraded via the network whenever new versions become available, reflecting changes in the MIBs or enhancements to the software. The software is stored in erasable Flash memory. It must be downloaded using the Trivial File Transfer Protocol (TFTP).

Software Image Naming Conventions

[Table 2](#) displays an example of typical software image names.

NOTE The image name is a typical example. The numbers in the name are illustrative and should not be regarded as the latest released version numbers.



Table 2: Typical Software Image Filename Example

Typical Application Image Name	Typical NI-M2404WebView Image Name
NetIron 2404 v2.0.00.bin	NI-M2404WebViewL3-V3.6.8.img

Downloading a Software Image to the Switch Using TFTP

Preparing to Download an Image Using TFTP

Before you begin to download a software image using TFTP, take the following precautions:

- Ensure that the workstation acting as TFTP server is configured properly.
- Ensure that the switch has a route to the TFTP server. The switch and the TFTP server must be in the same subnet if you do not have a router to route traffic between subnets. Use the **ping** command to check connectivity to the TFTP server.
- Ensure that the software image to be downloaded is in the correct directory on the TFTP server.
- Ensure that the permissions on the file are set correctly. Permissions on the file should be at least **read** for the specific username.
- A power outage (or other problem) during the download procedure can corrupt the Flash code. If the Flash code is corrupted, you can connect to the switch through the console port and download the application in the Loader by using the **download application** command.

Downloading a Device Software Image Using TFTP

To download a device software image to the switch from a TFTP server, proceed as follows:

1. Copy the device software image file to the appropriate TFTP directory on the workstation.
2. Log into the switch through the console port or through a Telnet session. If you log in using Telnet, your Telnet session will disconnect when you reset the switch to run the new software.
3. Make sure there is enough free space on the device file system. Use “dir” command for this. Free disk space should be at least 0.5MB larger then the downloaded application size.

Example:

```
device-name#dir
Listing Directory flash://:
d S      2048 Jun 30 2005 17:56 Boot/
d S      2048 Jan  1 1993 00:04 Etc/
d S      2048 Jun 14 2005 12:01 Java/
d S      2048 Jan  1 1980 00:00 Log/
d S      2048 Jul  5 2005 21:36 Usr/
d SH     2048 Jan  1 1980 00:00 Hidden/
-        260 Jan  1 1993 00:00 profile.cfg
-      43796 Jul  5 2005 21:26 dflt_startup_bin.cfg
-      5382 Jul  5 2005 21:26 dflt_startup.cfg

Free disk space 5655104
```

4. If there is not enough free space, delete unnecessary files. This is done by using “del” command.

```
device-name#del <filename>
```

Example:

```
device-name#del /Boot/Oldimage.bin
```

5. Download the device software image from the TFTP server using the **copy application** command in Privileged (Enable) mode:

```
device-name#copy application <TFTP URL> [<destination file name>]
```

Example:

```
device-name#copy application tftp://192.192.54.10/M2404Cv2.0.bin
```

NOTE The switch remains operational while the image is downloaded.



The application is downloaded into /Boot directory.

6. Configure the switch to boot with the newly downloaded image. This is done by selecting boot application and boot device.

```
device-name#config boot-param
device-name(boot param)#application <local application filename>
device-name(boot param)#device local
device-name(boot param)#exit
```

Example:

```
device-name#config boot
device-name(boot param)#application M2404v2.0.bin
device-name(boot param)#device local
device-name(boot param)#exit
```

7. Reset the switch using one of the **reload** commands. Note that, if you are connected to the switch through Telnet, your Telnet session will be disconnected.

Select from the following **reload** commands:

1. **reload save** - this command updates the device's startup configuration to match the running configuration and reboots the switch.
2. **reload to-defaults** – this command resets the device's startup configuration to match the factory defaults and reboots the switch.

After the execution of the command, confirmation is required [y/n]. Enter “y” to confirm the command.

Example with “reload” command:

```
device-name#reload save
Save current configuration and reboot the Switch ?
[y/n] : y
...
```

Example with “reload to-defaults” command:

```
device-name#reload to-defaults
Restore factory setting and reboot the Switch ?
[y/n] : y
...
```

8. After the switch reboots, use the **show version** command to check the version.

Downloading a NI-M2404WebView Image Using TFTP

To download a NI-M2404WebView software image to the switch from a TFTP server, proceed as follows:

1. Copy the software image file to the appropriate TFTP directory on the workstation.
2. Log into the switch through the console port or through a Telnet session.
3. Download the software image from the TFTP server using the **copy java** command in Privileged (Enable) mode:

```
device-name#copy java <TFTP URL> [<destination file name>]
```

Example:

```
device-name#copy java tftp://192.192.54.10/NI M2404WebViewL3-  
V3.3.9.img
```

NOTE The switch remains operational while the image is downloaded.



The Java image is downloaded into /Java directory.

4. Use the **show version** command to check the Java version on the switch.

Software Upgrade via Ethernet Port (Outband)

The switch has an Ethernet port which allows the user to access it for management purposes or software upgrades. This port, labeled ETH, is on the left side of the switch's front panel and is not one of the switched ports. In order to configure this port for IP, the following commands must be used (from config mode):

```
device-name(config)#interface Outband0  
device-name(config Outband0)#ip addr 10.1.1.7/8
```

This command will assign the IP address 10.1.1.7 and the netmask 255.0.0.0.

In order to see the current configuration of this IP interface, the following command should be used (from Privileged (Enable) mode):

```
device-name#show ip interfaces
```

In order to save the new Outband0 interface IP address, use the **write** command (from Privileged (Enable) mode).

Hot-swapping a Power Supply

The switch has two redundant power supplies, and can be operated when only one power supply is connected and powered on, or with both power supplies active. When both power supplies are active, you can remove or replace one power supply unit without interrupting the operation of the switch.

To extract a power-supply unit, release the panel screws on both sides of the unit and draw the unit out of its slot. Insert the replacement unit in the slot, push it carefully all the way in and fasten the panel screws.

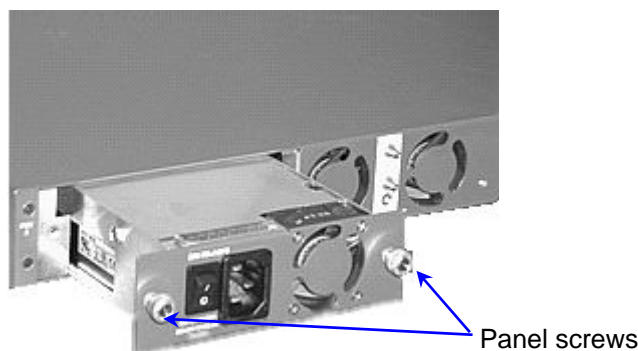

Figure 16: Extracting a Power-Supply Unit

CAUTION To avoid improper ventilation to the switch's internal circuitry and units, never leave an empty slot uncovered. If a removed power supply is not replaced, insert the supplied blank PSU filler into the slot and fasten it to the panel with the two screws.



NOTE Before extracting a power supply unit while the switch is running, verify that the other power supply is properly functioning, as indicated by the corresponding PSU LEDs on the front panel.



REMEMBER:

Both power-supply fans may function even if only one power supply is connected, to prevent overheating. A working fan does not indicate that the power supply on which it is assembled is active.

Specifications

Physical Specifications

Dimensions

Width	440 mm (17.4")	
Height	44 mm (1.73")	
Depth	419 mm (16.5")	
Weight	Chassis without PSU	3.7 kg (8.2 lbs)
	Each AC Power Supply	0.6 kg (1.3 lbs)
	Each DC Power Supply	0.6 kg (1.3 lbs)

Operating Conditions

AC power source	
Voltage:	100-120 VAC@ 5A or 200-240VAC@2.5A
Frequency:	50/60Hz
DC power source	
Voltage:	-48VDC typical (-36V to -60VDC) @ 3A
Operating temperature:	0 °C to 45 °C (32 °F to 104 °F)
Short term extended temperature:	-20°C – 60°C (-4°F - 140°F)
Humidity:	0 - 95% non-condensing
Relative Humidity:	5% to 90%, @45 °C (104 °F), non-condensing
Operating Altitude:	6,600 ft (2,012 m)
Storage Temperature:	-25 °C to 70 °C (-13 °F to 158 °F)
Storage Humidity:	95% maximum relative humidity, non-condensing
Storage Altitude:	15,000 ft (4,500 m) maximum

Environment:	The equipment is designed for use in indoor applications only.
---------------------	--

Management Features

Inband:	Integrated SNMP agent Java applet , Telnet and SSH
MIBs Supported:	MIB II, Bridge MIB, Private MIB ,RMON MIB (Groups 1,2,3,9)
Traps/Alarms:	SNMP traps to NMS
Console Port:	For initial configuration via dedicated RJ-45 connector EIA 232 protocol VT-100 compatible
Out-of-band Ethernet Port:	For Software Update via dedicated RJ-45 connector
Software Download:	Via TFTP

Safety and Electromagnetic Compatibility

Safety

EN/ UL 60950-1, CAN/CSA C22.2 No. 60950-1-03 and IEC 60950:2001

EMC

EN 55022: 1998 + A1:2000 class A, EN 300386 V1.3.1:2001, harmonized under EMC directive 89/336/EEC

EN55024 (CE mark) (Immunity) for Information Technology Equipment

ICES-003 (Canada) (Class A)

AS/NZ 55022 (Australia) (Class A)

VCCI CISPR 22 (Japan) (Class A)

ETSI 300 386 Telecommunication Centers

EN 61000-3-2

EN 61000-3-3

EN 61000-6-1

FCC 47 CFR: 2003 part 15 subpart B, class A

This equipment has been tested and found to comply with the limits for a Class A digital device, pursuant to Part 15 of the FCC Rules. These limits are designed to provide reasonable protection against harmful interference when the equipment is operated in a commercial environment. This equipment generates, uses, and can radiate radio frequency energy and, if not installed and used in accordance with the instruction manual, may cause harmful interference to radio communications. Operation of this equipment in a residential area is likely to cause harmful interference in which case the user will be required to correct the interference at his/her own expense.

Caution: Changes or modifications made to this device which are not expressly approved by the party responsible for compliance could void the user's authority to operate the equipment.

CISPR 22 CLASS A Warning

This is a class A product. In a domestic environment this product may cause radio interference in which case the user may be required to take adequate measures.

VCCI (Japan) (Class A)

This is a Class A product based on the standard of the Voluntary Control Council for Interference by Information Technology Equipment (VCCI). If this equipment is used in a domestic environment, radio disturbance may arise. When such trouble occurs, the user may be required to take corrective actions.

この装置は、情報処理装置等電波障害自主規制協議会（VCCI）の基準に基づくクラスA情報技術装置です。この装置を家庭環境で使用すると電波妨害を引き起こすことがあります。この場合には使用者が適切な対策を講ずるよう要求されることがあります。

Appendix A: Cautions and Warnings

Caution Statements

A caution calls your attention to a possible hazard that can damage equipment.

"Vorsicht" weist auf die Gefahr einer möglichen Beschädigung des Gerätes in.

Une mise en garde attire votre attention sur un risque possible d'endommagement de l'équipement. Ci-dessous, vous trouverez les mises en garde utilisées dans ce manuel.

Un mensaje de precaución le advierte sobre un posible peligro que pueda dañar el equipo. Las siguientes son precauciones utilizadas en este manual.

CAUTION: Remove the power cord from a power supply before you install it in or remove it from the device. Otherwise, the power supply or the device could be damaged as a result. (The device can be running while a power supply is being installed or removed, but the power supply itself should not be connected to a power source.)

VORSICHT: Trennen Sie das Stromkabel vom Netzteil ab, bevor es installiert oder vom Gerät entfernt wird. Andernfalls kann das Netzteil oder Gerät beschädigt werden. (Das Gerät kann während der Installation oder Entfernen eines Netzteils laufen. Allerdings sollte das Netzteil an keine Stromquelle angeschlossen sein.)

MISE EN GARDE : Afin d'éviter d'endommager le bloc d'alimentation, assurez-vous que le cordon d'alimentation ne soit pas connecté à une source de courant lorsque celui-ci est inséré or retiré du châssis. Le commutateur peut fonctionner en utilisant une source de courant alternative au bloc d'alimentation que l'on veut insérer ou enlever, mais il est important que celui que l'on insère ou retire ne soit pas raccordé électriquement.

PRECAUCIÓN Retire el cable de alimentación de un suministro de energía antes de instalarlo en él o de retirarlo del dispositivo. De no hacerse así, el suministro de energía o el dispositivo podrían resultar dañados. (El dispositivo puede estar funcionando mientras se está instalando o retirando un suministro de energía, pero el suministro de energía en sí no deberá estar conectado a una toma de corriente)

CAUTION: To avoid improper ventilation to the switch's internal circuitry and units, never leave an empty slot uncovered. If a removed power supply is not replaced, insert the supplied blank PSU filler into the slot and fasten it to the panel with the two screws.

VORSICHT: Ein leerer Steckplatz darf unter keinen Umständen zugedeckt werden, um eine mangelnde Be- und Entlüftung der Schaltkreise und Bauteile im Schalter auszuschließen. Falls ein abentferntes Netzteil nicht wieder ersetzt wird, benutzen Sie bitte die mitgelieferte Abdeck-Blende und schrauben Sie diese mit den beiden Schrauben an die Frontplatte

MISE EN GARDE : Pour éviter un dysfonctionnement du circuit de ventilation et ainsi un mauvais refroidissement des éléments qui composent le dispositif, ne laissez jamais un emplacement vide non couvert. Si un bloc d'alimentation enlevé n'est pas remplacé, insérez un cache de bloc d'alimentation dans l'emplacement vide et fixez-le au panneau avec les deux vis

PRECAUCIÓN: Para evitar una ventilación inadecuada a la circuitería interna y unidades del interruptor, no deje nunca un slot vacío al descubierto. Si un suministro de

energía retirado no se reemplaza, inserte el relleno PSU en blanco provisto en el slot y asegúrelo al panel con los dos tornillos.

-
- CAUTION:** Changes or modifications made to this device that are not expressly approved by the party responsible for compliance could void the user's authority to operate the equipment.
- VORSICHT:** Falls dieses Gerät verändert oder modifiziert wird, ohne die ausdrückliche Genehmigung der für die Einhaltung der Anforderungen verantwortlichen Partei einzuholen, kann dem Benutzer der weitere Betrieb des Gerätes untersagt werden.
- MISE EN GARDE:** Les modifications ou changements apportés à ce dispositif n'ayant pas été expressément approuvés par la partie responsable d'en évaluer la conformité peuvent annuler le droit de l'utilisateur à utiliser cet équipement.
- PRECAUCIÓN:** Los cambios o modificaciones realizados a este dispositivo que no estén expresamente aprobados por la parte responsable del cumplimiento de las normas podrían anular la autoridad del usuario para operar este equipo.

-
- CAUTION:** For a DC system, use a grounding wire of at least 10 American Wire Gauge (AWG). The 10 AWG wire should be attached to an agency-approved crimp connector, crimped with the proper tool. The crimp connector should allow for securement to both ground screws on the enclosure.
- VORSICHT:** Für ein Gleichstromsystem ist ein Erdungsdraht (wenigstens 10 AWG) erforderlich. Der 10 AWG-Draht sollte an einen behördlich genehmigten Crimpverbinder angebracht werden, der mit einem ordnungsgemäßen Werkzeug gecrimpt wurde. Der einzelne Crimpverbinder dient der Sicherung beider Erdungsschrauben am Gehäuse.
- MISE EN GARDE:** Pour les systèmes C.C., utilisez un fil de mise à la terre de calibre 10 AWG (American Wire Gauge) minimum. Ce fil doit être relié à un connecteur à sertir homologué, sertit avec l'outil approprié. Le connecteur à sertir unique devrait permettre le rattachement aux deux vis de borne de terre sur l'enveloppe.
- PRECAUCIÓN:** Para un sistema de corriente continua, utilice cable de conexión a tierra de calibre 10 AWG (Calibración de cables americana), por lo menos. El cable de AWG deberá acoplarse a un conector ondulado normalizado, ondulado con la herramienta apropiada. El conector ondulado simple deberá permitir fijación a los dos tornillos de conexión a tierra en el armario.

-
- CAUTION:** For the DC input circuit to the system, make sure there is a 10 amp circuit on the input to the terminal block.
- VORSICHT:** Für den Eingangs-Gleichstromkreis zum System ist ein 10 A-Leistungsschalter am Eingang zur Reihenklemme zu installieren.
- MISE EN GARDE:** Pour le circuit d'alimentation C.C. du système, assurez-vous de la présence d'un disjoncteur de 10 ampères sur l'entrée vers le bloc d'alimentation.
- PRECAUCIÓN:** Para el circuito de entrada de corriente continua al sistema, verifique que exista un cortacircuitos de 10 amperios en la entrada al bloque terminal.

Warning Statements

A warning calls your attention to a possible hazard that can cause injury or death. The following are the warnings used in this manual.

"Achtung" weist auf eine mögliche Gefährdung hin, die zu Verletzungen oder Tod führen können. Sie finden die folgenden Warnhinweise in diesem Handbuch:

Un avertissement attire votre attention sur un risque possible de blessure ou de décès. Ci-dessous, vous trouverez les avertissements utilisés dans ce manuel.

Una advertencia le llama la atención sobre cualquier posible peligro que pueda ocasionar daños personales o la muerte. A continuación se dan las advertencias utilizadas en este manual.

WARNING:	The procedures in this manual are for qualified service personnel.
ACHTUNG:	Die Verfahren in diesem Handbuch sind nur für qualifiziertes Wartungspersonal gedacht.
AVERTISSEMENT:	Les procédures décrites dans ce manuel doivent être effectuées par le personnel de service qualifié uniquement.
ADVERTENCIA:	Los procedimientos de este manual se han hecho para personal de servicio cualificado.

WARNING:	For safety reasons, the ESD wrist strap should contain a series 1 meg ohm resistor.
ACHTUNG:	Aus Sicherheitsgründen sollte ein EGB-Armband zum Schutz von elektronischen gefährdeten Bauelementen mit einem 1 Megaohm-Reihenwiderstand ausgestattet sein.
AVERTISSEMENT:	Pour des raisons de sécurité, la dragonne ESD doit contenir une résistance de série 1 méga ohm.
ADVERTENCIA:	Por razones de seguridad, la correa de muñeca ESD deberá contener un resistor en serie de 1 mega ohmio.

WARNING:	The equipment is designed to be used with Class 1 Laser fiber optic transmitters which may endanger your eyes. <i>Do not look directly into the fiber optic cables or transmitter.</i>
ACHTUNG:	Die Anlage ist für den Betrieb mit Lichtleitersendern der Klasse 1 ausgelegt, die Ihre Augen gefährden können. <i>Schauen Sie auf keinen Fall direkt in Lichtleiterkabel oder –sender.</i>
AVERTISSEMENT:	L'équipement est conçu pour être utilisé avec des transmetteurs laser par fibres optiques de classe 1 qui peuvent endommager vos yeux. <i>Ne regardez pas directement le transmetteur ou les câbles en fibres optiques.</i>
ADVERTENCIA:	El equipo está diseñado para utilizarlo con transmisores ópticos de fibra Láser de Clase 1 que pueden ser perjudiciales para los ojos. <i>No mire directamente a los cables o al transmisor ópticos de fibra.</i>

WARNING:	HIGH VOLTAGE
	Disconnect the product from the power line before removing the cover. Any adjustment and maintenance of the opened device should be done only while the device is disconnected from its source of power and

should only be performed by qualified personnel, authorized by Foundry Networks.

ACHTUNG:

Hochspannung

Trennen Sie das Gerät vom Netz, bevor Sie die Abdeckung abnehmen. Alle Einstellungs- und Wartungsarbeiten am geöffneten Gerät dürfen nur von Fachleuten durchgeführt werden, die eine Foundry Networks Zertifizierung nachweisen können. Diese Arbeiten dürfen nur an einem von seiner Stromquelle abgetrennten Gerät erfolgen.

AVERTISSEMENT :

Haute tension

Débranchez le produit de sa source d'alimentation avant de retirer le couvercle. Tout ajustement ou toute maintenance d'un dispositif ouvert doit être effectué uniquement lorsque le dispositif est hors tension et doit être effectué uniquement par du personnel qualifié, agréé par Foundry Networks.

ADVERTENCIA:

Alto voltaje

Desconecte el producto de la alimentación de corriente antes de retirar la cubierta. Cualquier ajuste o mantenimiento realizado al dispositivo abierto deberá hacerse únicamente cuando el dispositivo esté desconectado de su toma de corriente, y solo deberá ser realizada por personal calificado y autorizado por Foundry Networks.

WARNING:

GROUNDING

Before connecting the product to the power line, make sure that the protective ground terminal of the device is connected to the safety ground conductor of the mains power cord.

The main power supply plug should only be inserted in a socket outlet provided with a connected safety ground. The protective action must not be negated by use of an extension cord (power cable) without a protective conductor (grounding). Any interruption of the protective (grounding) conductor or disconnection of the protective ground terminal can make the device unsafe to use. Intentional interruption is prohibited.

This equipment has a connection between the earthed conductor of the DC supply circuit and the grounding conductor.

ACHTUNG:

ERDUNG

Stellen Sie sicher, dass der Schutzerdanschluss des Geräts an den Sicherheitserdleiter des Hauptnetzkabels angeschlossen ist, bevor das Gerät an das Netz angeschlossen wird.

Der Hauptnetzstecker darf nur in eine Steckdose mit angeschlossener Sicherheitserde gesteckt werden. Diese Schutzfunktion darf nicht durch den Gebrauch eines Verlängerungsstromkabels ohne Schutzleiter (Erde) außer Kraft gesetzt werden. Alle Unterbrechungen des Schutzerdleiters oder Abtrennen vom Schutzerdanschluss machen die Benutzung des Gerätes gefährlich. Eine absichtliche Unterbrechung ist verboten.

Diese Anlage weist einen Anschluss zwischen dem Erdleiter des Gleichstromkreises und dem Schutzleiter auf.

Avertissement :

Mise à la terre.

Avant de brancher l'unité à une source de courant, vérifiez que la prise de terre est branchée à la mise à la terre du câble d'alimentation secteur.

La prise d'alimentation principale doit être insérée uniquement dans une prise ayant un raccordement à la terre. Cette protection ne doit pas être remise en cause par l'utilisation d'une rallonge (câble d'alimentation) ne possédant pas de mise à la terre. Toute discontinuité du circuit de mise à la terre ou déconnexion de la prise de terre risque de rendre l'utilisation du dispositif dangereuse. Toute interruption intentionnelle est interdite.

Cet équipement possède un raccordement entre la mise à la terre du circuit d'alimentation continue (DC) et le câble de la mise à la terre.

ADVERTENCIA: CONEXIÓN A TIERRA

Antes de conectar el producto a la corriente, verifique que el terminal protector de conexión a tierra del dispositivo esté conectado al conductor de seguridad de conexión a tierra del cable de alimentación principal.

El enchufe del suministro de energía principal solo deberá insertarse en una toma de zócalo provista con una toma de tierra de seguridad conectada. No deberá denegarse la acción protectora por el uso de cable de extensión (cable de alimentación) sin un conductor protector (conexión a tierra). Cualquier interrupción del conductor protector (conexión a tierra) o la desconexión del terminal protector de conexión a tierra pueden hacer que el uso del dispositivo resulte peligroso. Esta prohibida la interrupción intencional.

Este equipo cuenta con una conexión entre el conductor conectado a tierra del circuito de suministro de CC y el conductor de conexión a tierra.

WARNING: WIRING FOR NATIONAL POWER PLUG

A mains power cable according to National Electrical Code (NEC) with molded IEC socket is supplied with each unit. The specific national mains power plug should be wired as follows:

Brown lead	Live (phase)
Blue lead	Neutral
Green/Yellow lead	Safety ground

ACHTUNG: VERDRAHTUNG DES NATIONAL-STECKERS

Ein Hauptnetzstromkabel gemäß NEC (National Electric Code der USA) mit in Kunststoff gegossener IEC-Buchse wird mit jeder Einheit geliefert. Der National-Hauptnetzstecker ist wie folgt zu verdrahten:

Braune Leitung	Stromführend (Phase)
Blaue Leitung	Neutral
Grünelbe Leitung	Sicherheitserde.

AVERTISSEMENT : CÂBLAGE POUR PRISE D'ALIMENTATION NATIONALE

Un câble d'alimentation secteur selon le code national de l'électricité (National Electric Code ou NEC) avec une prise IEC moulée est fourni avec chaque unité. La prise d'alimentation secteur nationale spécifique doit être câblée comme suit:

Fil marron	Phase
Fil bleu	Neutre
Fil vert/jaune	Terre

ADVERTENCIA: CABLEADO PARA ENCHUFE DE CORRIENTE NACIONAL

Con cada unidad se suministra un cable de alimentación principal según el Código eléctrico nacional (*National Electrical Code o NEC*) con zócalo IEC moldeado. El enchufe de alimentación principal específico deberá estar cableado de la manera siguiente:

Conductor marrón	Activo (fase)
Conductor azul	Neutro
Conductor verde/amarillo	Conexión a tierra de seguridad

WARNING: LINE VOLTAGE

Before connecting the product to the power line, make sure the voltage of the power source matches the requirements of the product, as marked on the label located near the power connectors

ACHTUNG: NETZSPANNUNG

Stellen Sie sicher, dass die Spannung der Stromquelle den Geräteanforderungen entspricht (siehe Etikett neben den Netzanschlüssen), bevor Sie das Gerät an das Netz anschließen.

AVERTISSEMENT : TENSION DU RÉSEAU

Avant de brancher le produit à l'alimentation électrique, vérifiez que le voltage de la source d'alimentation correspond aux spécifications du produit, telles qu'elles sont portées sur l'étiquette en regard des connecteurs d'alimentation.

ADVERTENCIA: VOLTAJE DE LÍNEA

Antes de conectar el producto a la línea de alimentación, verifique que el voltaje de la fuente de alimentación se ajusta a los requisitos del producto, según lo indicado en la etiqueta situada junto a los conectores de alimentación.

WARNING: DC POWER SOURCE

The DC power source should be protected with a branch circuit over-current protection rated at 10Amp, located in the building installation.

ACHTUNG: GLEICHSTROMQUELLE

Die Gleichstromquelle ist mit einem Zweigstromkreis mit Überstromschutz (10 A) in der Gebäudeinstallation zu schützen

AVERTISSEMENT : SOURCE D'ALIMENTATION C.C.

La source d'alimentation continue (DC) doit être protégée par disjoncteur de 10A, situé dans l'installation du bâtiment.

ADVERTENCIA: FUENTE DE ALIMENTACIÓN DE CC

La fuente de alimentación de CC deberá protegerse con un circuito en bifurcación contra sobretensión con capacidad nominal de 10 Amp, situado en la instalación del edificio

WARNING: Make sure the rack or cabinet housing the device is adequately secured to prevent it from becoming unstable or falling over.

ACHTUNG: Das Gestell oder der Schrank muss standfest und stabil aufgestellt werden.

AVERTISSEMENT: Vérifiez que le châssis ou l'armoire incluant l'unité est bien fixé afin qu'il ne devienne pas instable ou qu'il ne risque pas de tomber.

ADVERTENCIA: Verifique que el montante o el gabinete que alberga el dispositivo está asegurado adecuadamente para evitar que se haga inestable o que se caiga.

WARNING: Before connecting power to the switch, make sure that both grounding posts in the rear panel are firmly connected to a reliable ground through a #10 AWG grounding wire terminated by a UL-listed two-hole long-barrel 5/8 10 AWG compression lug with hole size and spacing as shown in [Figure 15](#).

The *Burndy YAZV10-2TC14* or an equivalent UL-listed two-hole compression lug is recommended.

ACHTUNG: Stellen Sie sicher, dass die beiden Erdungsstäbe in der Rückwand fest mit einem 2,59 mm dicken Draht (AWG 10) an eine zuverlässige Erde angeschlossen sind. Der Draht muss mit einem UL-zugelassenen langen Kabelschuh (5/8 AWG 10) mit zwei Löchern abgeschlossen werden. Für Lochdurchmesser und Abstand siehe die folgende Abbildung [Figure 15](#).

Als Kabelschuh wird das Modell *Burndy YAZV10-2TC14* oder ein gleichwertiger UL-zugelassener langer Kabelschuh mit zwei Löchern empfohlen

AVERTISSEMENT: Avant de brancher le commutateur à une source de courant, vérifiez que les fiches de mise à la terre du panneau arrière sont fermement connectées à une prise de terre fiable. Pour cela, utilisez un fil de mise à la terre de calibre 10 AWG se terminant par une cosse à compression 5/8 10 AWG cylindrique longue à deux trous, homologuée UL. Espacement et taille de trou sont indiqués dans [Figure 15](#) ci-dessous.

La cosse à compression deux trous homologuée UL *Burndy YAZV10-2TC14* ou équivalente est recommandée.

ADVERTENCIA: Antes de conectar la alimentación al interruptor, verifique que ambos postes de conexión a tierra del panel posterior estén bien conectados a una tierra de confianza por medio de un cable de conexión a tierra de calibre #10 AWG de 5/8 terminado en una garra de compresión de calibre 10 AWG de 5/8 de rodillo largo con dos agujeros listada por UL con tamaño de agujero, según se muestra en [Figure 15](#) más abajo.

Se recomienda *Burndy YAZV10-2TC14* o una garra de compresión con dos agujeros equivalente listada por UL.

Free Manuals Download Website

<http://myh66.com>

<http://usermanuals.us>

<http://www.somanuals.com>

<http://www.4manuals.cc>

<http://www.manual-lib.com>

<http://www.404manual.com>

<http://www.luxmanual.com>

<http://aubethermostatmanual.com>

Golf course search by state

<http://golfingnear.com>

Email search by domain

<http://emailbydomain.com>

Auto manuals search

<http://auto.somanuals.com>

TV manuals search

<http://tv.somanuals.com>