













Use & Care Manual

Electric Range

ES400 Controls, Self-Cleaning Oven
with Ceramic Glass Cooktop,
Convection Bake & Roast



Visit the Frigidaire Web Site at:
<http://www.frigidaire.com>

Welcome	2	
Important Safety Instructions ..	3-4	
Features at a Glance	5-6	
Setting Surface Controls ..	7-11	
Surface Cooking	11	
Before Setting Oven Controls Setting Warming Drawer Controls ..	12-14	
Control Pad Features	15	
Setting Oven Controls	16-26	
Self-Cleaning	27-30	
Adjusting Your Oven Temperature	30	
Care & Cleaning	31-34	
Before You Call Solutions to Common Problems	35-36	
Convection Cooking Tables	37	
Warranty	Back Cover	

READ AND SAVE THESE INSTRUCTIONS

P/N 316257124 (0305)

Note: This manual replaces P/N 316257106



Welcome & Congratulations

Questions?

1-800-944-9044

(United States)

1-866-729-5199

(Canada)

Please attach sales receipt here for future reference.

Congratulations on your purchase of a new range! At **Electrolux Home Products**, we are very proud of our product and are completely committed to providing you with the best service possible. Your satisfaction is our number one priority.

We know you'll enjoy your new range and **Thank You** for choosing our product. We hope you consider us for future purchases.

PLEASE CAREFULLY READ AND SAVE THESE INSTRUCTIONS

This Use & Care Manual provides specific operating instructions for your model. Use your range only as instructed in this manual. These instructions are not meant to cover every possible condition and situation that may occur. Common sense and caution must be practiced when installing, operating and maintaining any appliance.

Please record your model and serial numbers below for future reference.

Model Number: _____

Serial Number: _____

Purchase Date: _____

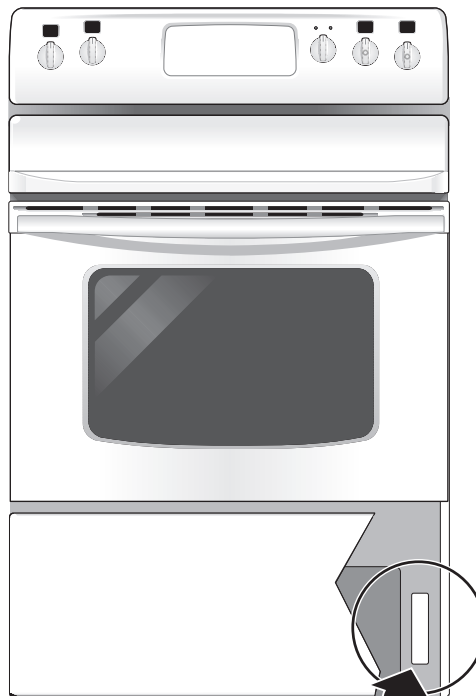

Serial plate location
Open storage or warmer drawer,
or remove lower panel
(on some models)

Product Registration

Register Your Product

The self-addressed **PRODUCT REGISTRATION CARD** should be filled in completely, signed and returned to Electrolux Home Products.

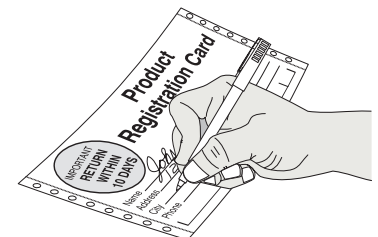

This Use & Care Manual contains general operating instructions for your range and feature information for several models. Your range **may not** have all the described features. The graphics shown are representational. The graphics on your range may not look exactly like those shown.

Important Safety Instructions



Read all instructions before using this appliance. Save these instructions for future reference.

This manual contains important safety symbols and instructions. Please remember these symbols and follow all instructions given.

⚠ WARNING This symbol will help alert you to situations that may cause serious bodily harm, death or property damage.

⚠ CAUTION This symbol will help alert you to situations that may cause bodily injury or property damage.

- **Remove all tape and packaging before using the range.**
Destroy the carton and plastic bags after unpacking the range. Never allow children to play with packaging material.
- **Proper Installation—Be sure your appliance is properly installed and grounded by a qualified technician in accordance with the National Electrical Code ANSI/NFPA No. 70 latest edition and local electrical code requirements.**
Install only per installation instructions provided in the literature package for this range.
Ask your dealer to recommend a qualified technician and an authorized repair service. Know how to disconnect the power to the range at the circuit breaker or fuse box in case of an emergency.
- **User servicing—Do not repair or replace any part of the appliance unless specifically recommended in the manuals.**
All other servicing should be done only by a qualified technician. This may reduce the risk of personal injury and damage to the range.
- **Never modify or alter the construction of a range by removing leveling legs, panels, wire covers, anti-tip brackets/screws, or any other part of the product.**

⚠ WARNING

- All ranges can tip.
- Injury to persons could result.
- Install anti-tip device packed with range.
- See Installation Instructions.



⚠ WARNING To reduce the risk of tipping, the range must be secured by properly installed anti-tip bracket provided with the range. To check if the bracket is installed properly, visually check that rear leveling leg is inserted into and fully secured by the anti-tip bracket by removing lower panel or storage drawer. For models with a warmer drawer, grasp the top rear edge of the range and carefully attempt to tilt it forward. Refer to the installation instructions for proper anti-tip bracket installation.



⚠ WARNING Stepping, leaning or sitting on the doors or drawers of this range can result in serious injuries and also cause damage to the range. Do not allow children to climb or play around the range. The weight of a child on an open door may cause the range to tip, resulting in serious burns or other injury.

⚠ WARNING Do not use the oven or warmer drawer (if equipped) for storage.

⚠ CAUTION Do not store items of interest to children in the cabinets above a range or on the backguard of a range. Children climbing on the range to reach items could be seriously injured.

⚠ WARNING Never Use Your Appliance for Warming or Heating the Room.

- **Storage in or on Appliance—Flammable materials should not be stored in an oven, warmer drawer, near surface units or in the storage drawer.** This includes paper, plastic and cloth items, such as cookbooks, plasticware and towels, as well as flammable liquids. Do not store explosives, such as aerosol cans, on or near the range.
- **Do Not Leave Children Alone—Children should not be left alone or unattended in the area where appliance is in use.** They should never be allowed to sit or stand on any part of the appliance.
- **DO NOT TOUCH SURFACE UNITS, AREAS NEAR THESE UNITS, HEATING ELEMENTS OR INTERIOR SURFACES OF THE OVEN.** Both surface units and oven heating elements may be hot even though they are dark in color. Areas near surface units may become hot enough to cause burns. During and after use, do not touch, or let clothing or other flammable materials touch these areas until they have had sufficient time to cool. Among these areas are the cook top, surfaces facing the cook top, the oven vent openings and surfaces near these openings, oven door and window.
- **Wear Proper Apparel—Loose-fitting or hanging garments should never be worn while using the appliance.** Do not let clothing or other flammable materials contact hot surfaces.
- **Do Not Use Water or Flour on Grease Fires—Smother the fire with a pan lid, or use baking soda, a dry chemical or foam-type extinguisher.**
- **When heating fat or grease, watch it closely.** Fat or grease may catch fire if allowed to become too hot.
- **Use Only Dry Potholders—Moist or damp potholders on hot surfaces may result in burns from steam.** Do not let potholders touch hot heating elements. Do not use a towel or other bulky cloth instead of a potholder.
- **Do Not Heat Unopened Food Containers—Buildup of pressure may cause container to burst and result in injury.**
- **Remove the oven door from any unused range if it is to be stored or discarded.**

IMPORTANT—Do not attempt to operate the range during a power failure. If the power fails, always turn off the range. If the range is not turned off and the power resumes, the range will begin to operate again. Once the power resumes, reset the clock and oven function.



Important Safety Instructions

IMPORTANT INSTRUCTIONS FOR USING YOUR COOKTOP

- **Know which knob controls each surface heating unit.** Place a pan of food on the unit before turning it on, and turn the unit off before removing the pan.
- **Use Proper Pan Size**—This appliance is equipped with one or more surface units of different sizes. Select utensils having flat bottoms large enough to cover the surface unit heating element. The use of undersized utensils will expose a portion of the heating element to direct contact and may result in ignition of clothing. Proper relationship of utensil to element will also improve efficiency.
- **Utensil Handles Should Be Turned Inward and Not Extend Over Adjacent Surface Elements**—To reduce the risk of burns, ignition of flammable materials, and spillage due to unintentional contact with the utensil, the handle of the utensil should be positioned so that it is turned inward, and does not extend over adjacent surface units.
- **Never Leave Surface Elements Unattended at High Heat Settings**—Boilovers cause smoking and greasy spillovers that may ignite, or a pan that has boiled dry may melt.
- **Do Not Immerse or Soak Removable Heating Elements**—Heating elements should never be immersed in water. Heating elements clean themselves during normal operation.
- **Glazed Cooking Utensils**—Only certain types of glass, glass/ceramic, ceramic, earthenware, or other glazed utensils are suitable for cook top service without breaking due to the sudden change in temperature. Check the manufacturer's recommendations for cook top use.
- **When flaming foods under a ventilating hood, turn the fan on.**

IMPORTANT INSTRUCTIONS FOR USING YOUR OVEN

- **Use Care When Opening Oven Door or Warmer Drawer (if equipped)**—Stand to the side of the range when opening the door of a hot oven. Let hot air or steam escape before you remove or replace food in the oven.
- **Keep Oven Vent Ducts Unobstructed.** The oven vent is located under the left rear surface element if your model is equipped with coil elements. The oven vent is located below the backguard for models equipped with ceramic-glass cook tops. Touching the surfaces in this area when the oven is operating may cause severe burns. Also, do not place plastic or heat-sensitive items on or near the oven vent. These items could melt or ignite.
- **Placement of Oven Racks.** Always place oven racks in desired location while oven is cool. If rack must be moved while oven is hot use extreme caution. Use potholders and grasp the rack with both hands to reposition. Do not let potholders contact the hot heating elements in the oven. Remove all utensils from the rack before moving.
- **Do not use the broiler pan without its insert.** The broiler pan and its insert allow dripping fat to drain and be kept away from the high heat of the broiler.
- **Do not cover the broiler insert with aluminum foil. Exposed fat and grease could ignite.**

- **Protective Liners**—Do not use aluminum foil to line the oven bottom. Only use aluminum foil as recommended in this manual. Improper installation of these liners may result in risk of electric shock, or fire.

SELF CLEANING OVENS

- **Clean in the self-cleaning cycle only the parts listed in this Use & Care Manual.** Before self-cleaning the oven, remove the broiler pan and any utensils or foods from the oven.
- **Do Not Use Oven Cleaners**—No commercial oven cleaner or oven liner protective coating of any kind should be used in or around any part of the oven.
- **Do Not Clean Door Gasket**—The door gasket is essential for a good seal. Care should be taken not to rub, damage or move the gasket.
- The health of some birds is extremely sensitive to the fumes given off during the self-cleaning cycle of any range. Move birds to another well-ventilated room.

IMPORTANT INSTRUCTIONS FOR CLEANING YOUR RANGE

- **Clean the range regularly to keep all parts free of grease that could catch fire.** Pay particular attention to the area near each surface element. Do not allow grease to accumulate.
- **Kitchen cleaners and aerosols**—Always follow the manufacturer's recommended directions for use. Be aware that excess residue from cleaners and aerosols may ignite causing damage and injury.
- **Clean Ventilating Hoods Frequently**—Grease should not be allowed to accumulate on the hood or filter. Follow manufacturer's instructions for cleaning.

FOR CERAMIC-GLASS COOK TOP MODELS

- **Do Not Cook on Broken Cook Top**—If cook top should break, cleaning solutions and spillovers may penetrate the broken cook top and create a risk of electric shock. Contact a qualified technician immediately.
- **Clean Cook Top with Caution**—If a wet sponge or cloth is used to wipe spills on a hot cooking area, be careful to avoid a steam burn. Some cleaners can produce noxious fumes if applied to a hot surface.

IMPORTANT SAFETY NOTICE

The California Safe Drinking Water and Toxic Enforcement Act requires the Governor of California to publish a list of substances known to the state to cause cancer, birth defects or other reproductive harm, and requires businesses to warn customers of potential exposure to such substances.

READ AND SAVE THESE INSTRUCTIONS

Features At A Glance

Note: The features of your range will vary according to model.



Your Electric Range Features At a Glance

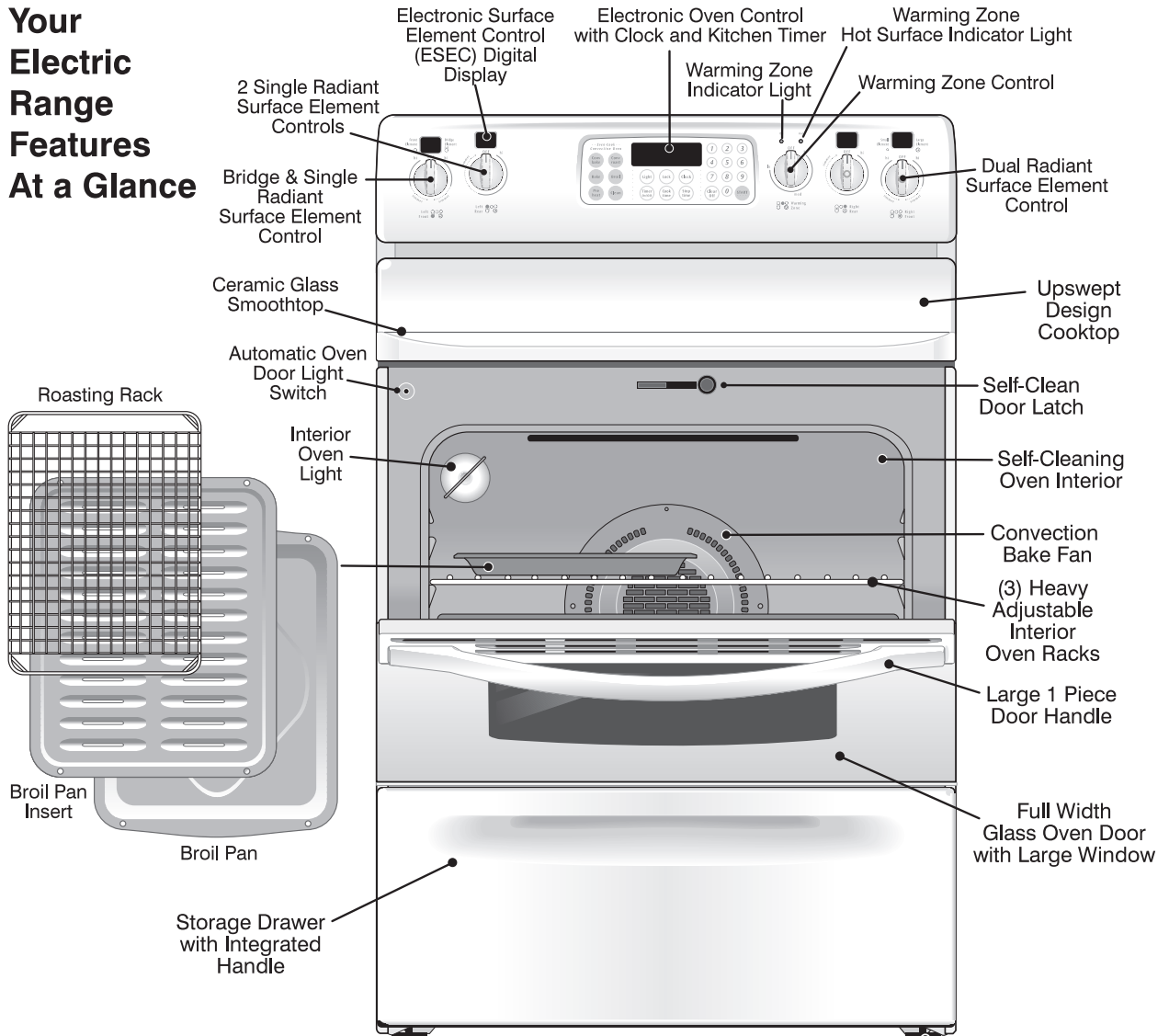

Ceramic Glass Smoothtop

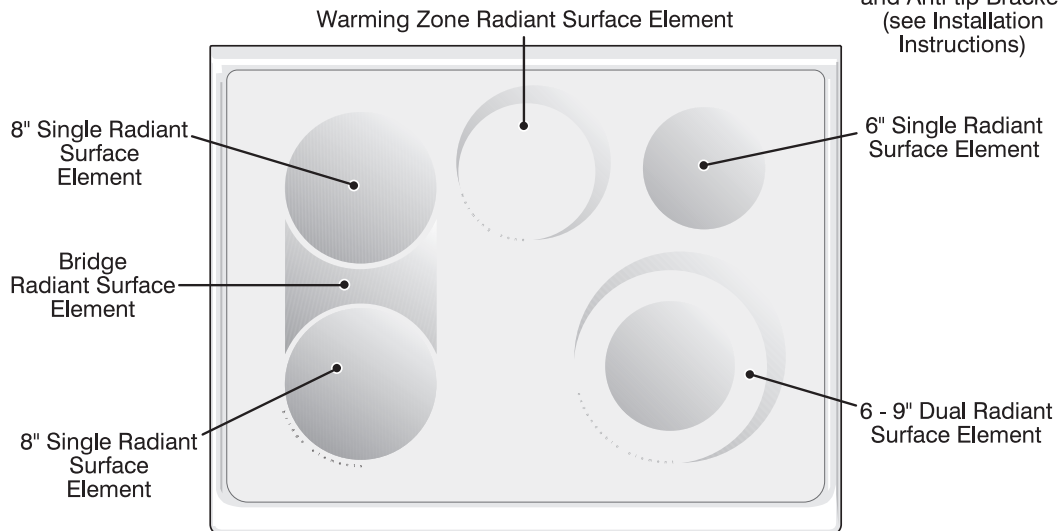



Features At A Glance

Note: The features of your range will vary according to model.

Your Electric Range Features At a Glance

(Stainless Steel models only)

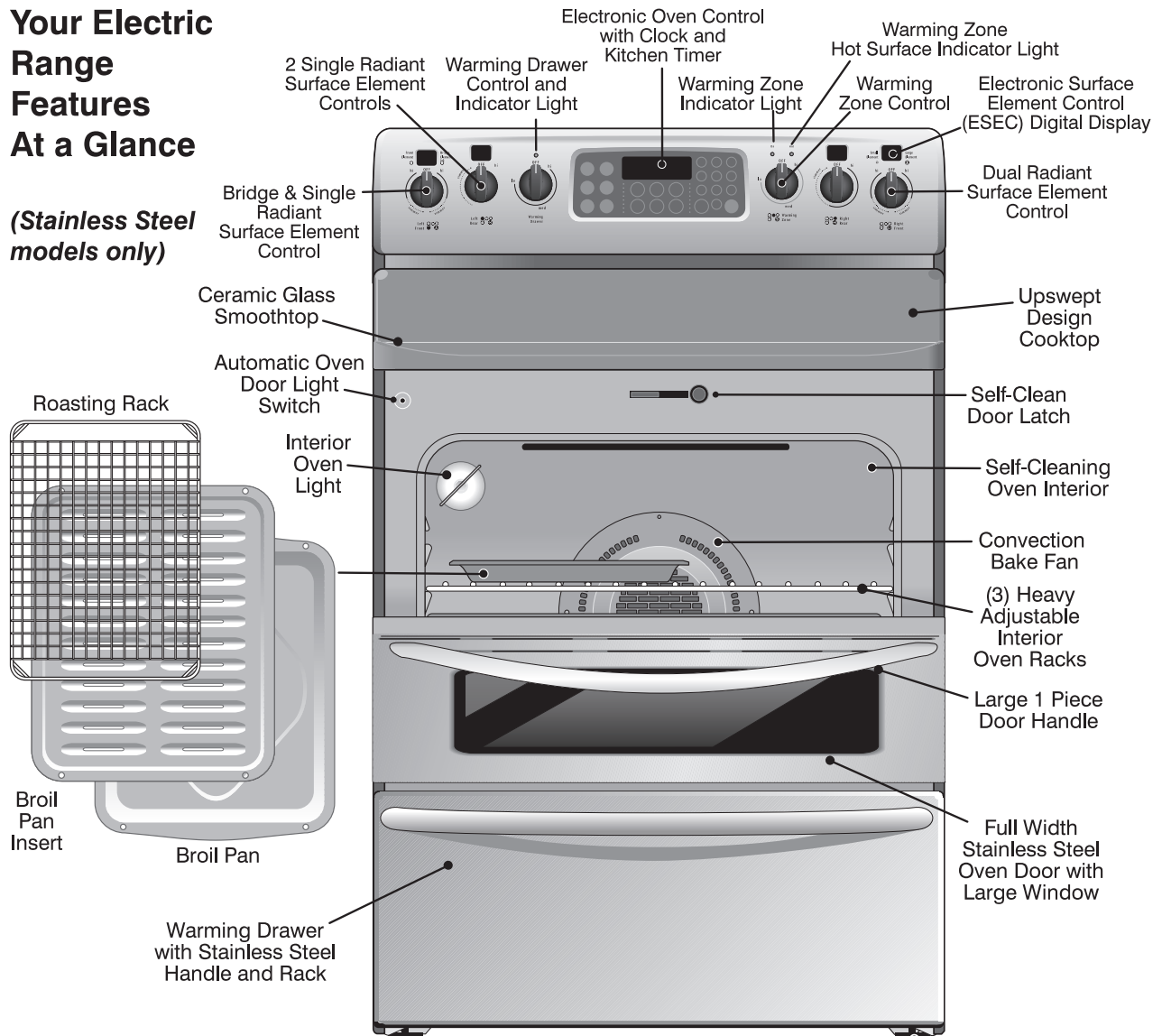

Ceramic Glass Smoothtop

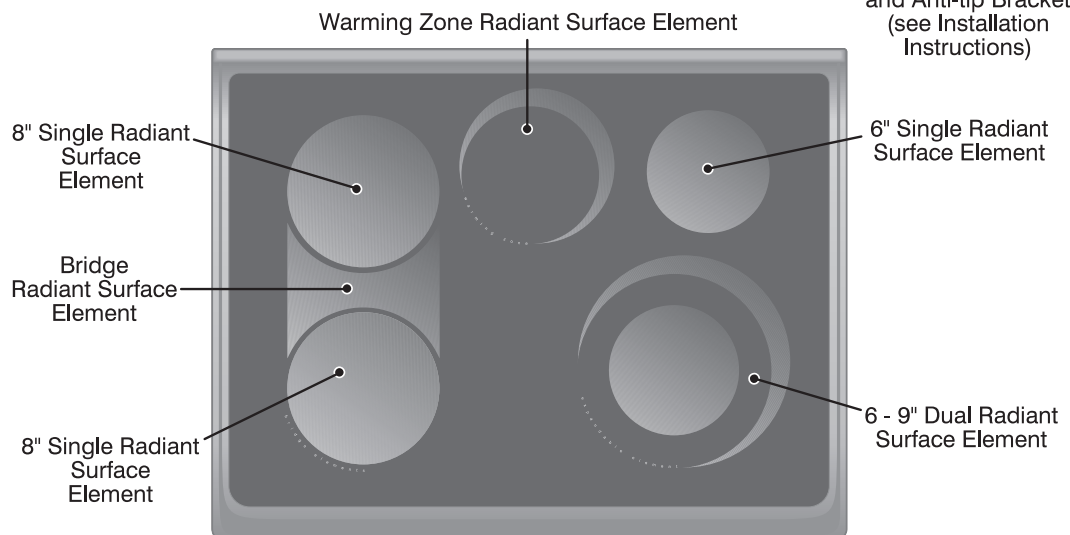

Setting Surface Controls

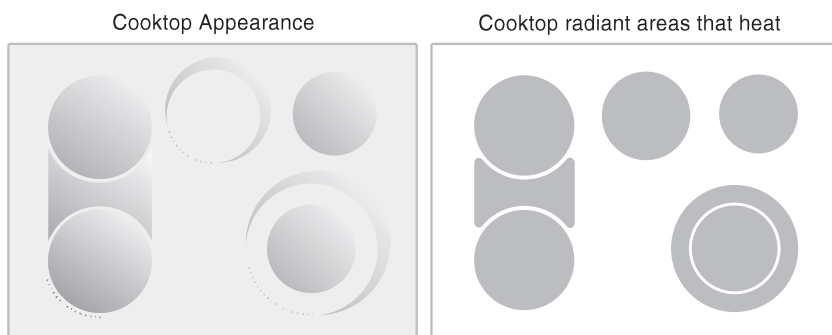

Figure 1

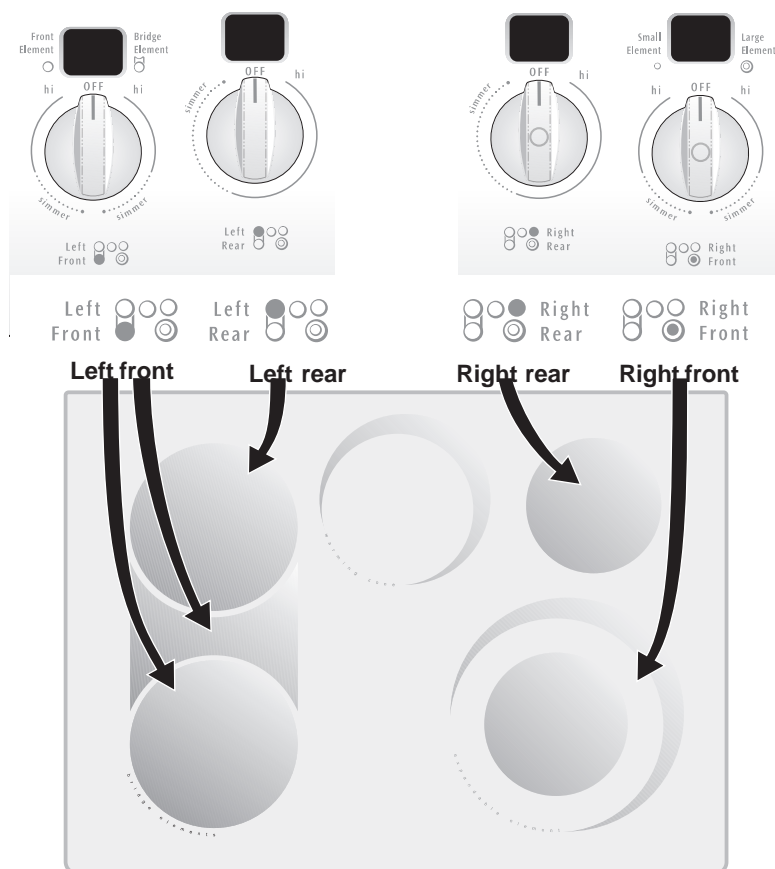

Figure 2

NOTE: Please read detailed instructions for ceramic glass cooktop cleaning in the **Care & Cleaning** section and **Before You Call** checklist sections of this Use and Care Manual.

NOTE: Radiant elements have a limiter that allows the element to cycle on and off, even at the HI setting. This helps to prevent damage to the ceramic smooth top. Cycling at the HI setting is normal and can occur if the cookware is too small for the radiant element or if the cookware bottom is not flat (Refer to page 11 for using correct cookware instructions with the cooktop).

About the Ceramic Glass Cooktop

The ceramic cooktop has radiant surface elements located below the surface of the glass. The design of the ceramic cooktop outlines the area of the surface element underneath. **Make sure** the diameter of the pan matches the diameter of the element outline on the cooktop (See Fig 1). Heat is transferred up through the surface of the cooktop to the cookware. Only flat-bottom cookware should be used. The type and size of cookware, the number of surface elements in use and the settings, are all factors that will affect the amount of heat that will spread to areas beyond the surface elements. The areas surrounding the elements may become **hot enough to cause burns**.

About the Radiant Surface Elements

The element temperature rises gradually and evenly. As the temperature rises, the element will glow red. To maintain the selected setting, the element will cycle on and off. The heating element retains enough heat to provide a uniform and consistent heat during the off cycle. For efficient cooking, turn off the element several minutes before cooking is complete. This will allow residual heat to complete the cooking process.

Locations of the Radiant Surface Elements and Controls

Your range is equipped with radiant surface burners with 6 different wattage ratings. The ability to heat food quicker and in larger volumes increases as the element wattage increases. The radiant surface elements are located on the cooktop as follows (See Figure 2); a smaller **6 inch** radiant element located at the right rear position; a **dual 6 or 9 inch** radiant element located at the right front position; a **Warmer Zone** radiant element at the center rear position (See page 12); and 2 (two) **8 inch** radiant elements located at both the left front and rear positions. Located between left front and rear elements is a **Bridge** radiant element.

The BRIDGE radiant element is controlled using the same knob that controls the left front radiant element position. See pages 10 and 11 for more information about using BRIDGE radiant element.



Setting Surface Controls

The Electronic Surface Element Control (ESEC)

The Electronic Surface Element Control (“ESEC”) feature includes 4 digital display windows. The ESEC feature provides a numeric digital setting for 4 of the radiant surface element positions on the cooktop, including shared settings at the left front knob control position for both the left front radiant element and the “Bridge” radiant element. Also the right front knob control position shares settings for the dual radiant element. These settings work the same way as normal knob setting indicators work except the settings are displayed in digital windows (Figures 1 thru 4).

The available ESEC Display Settings

The ESEC control provides various heat levels from **Hi** (Fig. 2) to **Lo** (Fig. 4) and **OFF** (Fig. 1). The settings from **Hi** to **3.0** decrease in increments of .5. The settings from **3.0** to **Lo** (Simmer settings) decrease in increments of .2 for more precise settings of lower heat levels.

Use the chart (Fig. 5) to determine the correct setting for the kind of food you are preparing. The Simmer settings are used to simmer and keep larger quantities of foods warm such as stews and soups. The lower Simmer settings are ideal for delicate foods and melting chocolate or butter.

Note: The size and type of cookware used will influence the setting needed for best cooking results.

CAUTION Radiant surface elements may appear to have cooled after they have been turned off. **The glass surface may still be hot** and burns may occur if the glass surface is touched before it has cooled sufficiently.

CAUTION Do not place plastic items such as salt and pepper shakers, spoon holders or plastic wrappings on top of the range when it is in use. These items could melt or ignite. Potholders, towels or wooden spoons could catch fire if placed too close to the surface elements.

Recommended Surface Cooking Settings

RECOMMENDED SETTINGS FOR SINGLE, BRIDGE & DUAL SURFACE ELEMENTS

Setting	Type of Cooking
HIGH (8 - Hi)	Start most foods, bring water to a boil, pan broiling
MEDIUM HIGH (5 - 8)	Continue a rapid boil, fry, deep fat fry
MEDIUM (3 - 5)	Maintain a slow boil, thicken sauces and gravies, steam vegetables
MEDIUM LOW (2 - 3)	Keep foods cooking, poach, stew
LOW (Lo - 2)	Keep warm, melt, simmer

Figure 5

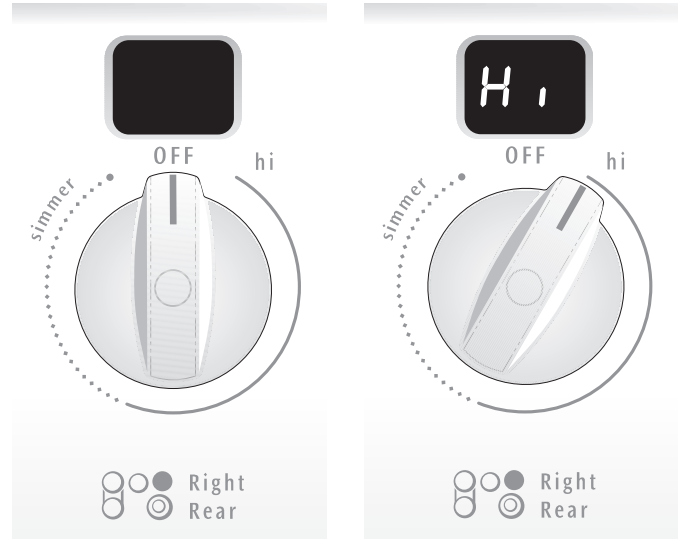

Figure 1

Figure 2

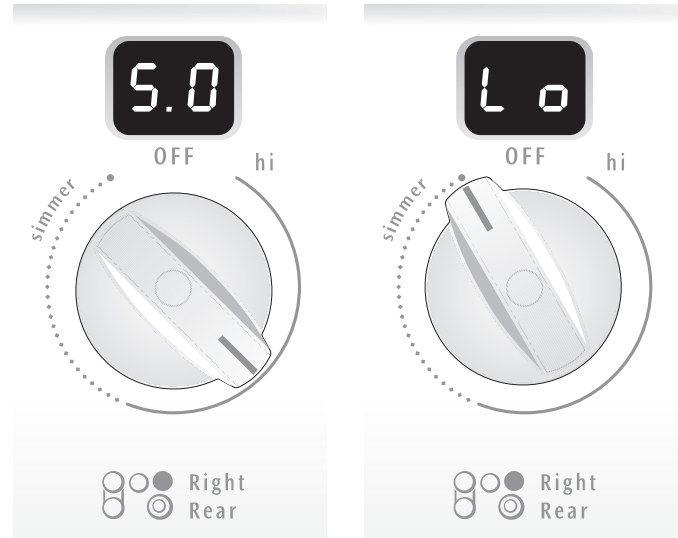

Figure 3

Figure 4

Setting Surface Controls



ESEC Hot Element Indicator Message (HE)

After using any of the single, dual or Bridge radiant element positions the cooktop will become very hot. Even after turning the control knob to OFF, the cooktop will remain hot for some time. The ESEC control monitors the temperature of the cooktop and displays the message "HE" (hot element) warning when the cooktop is still too hot to touch (See Fig.1). If the HE message appears in the window, the control can still be turned on again for use.

ESEC Error Indicator Message (Er)

An error message will be displayed (flashing "Er") at power up (or after a power failure) if ANY of the surface control knobs were left in the ON positions. If a power failure should occur, be sure to set all of the 4 surface control knobs to the OFF position (See Fig. 2). This will reset the surface controls.

Be sure to reset the clock (See page 16). Once the surface controls have been set to the OFF positions and the clock has been set with the correct time of day, the surface controls should return to normal operation. If the surface controls do not function and the "Er" message remains in any display after following these procedures, contact an authorized servicer for assistance.

ESEC Lockout Feature (- -)

The self-clean feature will not operate whenever a radiant surface element is ON. Conversely the ESEC feature will not operate during a self-clean cycle or when the Oven Lockout feature is active. Whenever the ESEC Lockout feature is active, " - - " may appear in any display window (See Fig. 3). If any of the surface elements are still hot during active Lockout, "HE" will appear in the window instead of the " - - " message.

The Single Radiant Surface Elements

The cooktop has single radiant surface elements at 2 locations; the right rear (Fig. 5) and left rear (Fig. 6) element positions. The BRIDGE element position can also be used as a single element (See Bridge Element Operating Instructions on pages 10-11).

To Operate the Single Surface Elements:

1. Place correctly sized cookware on the radiant surface element.
2. Push in and turn the surface control knob in either direction to the desired setting using the ESEC digital display window for the desired setting (Fig. 4). Turn (do not push) the knob to adjust the setting if desired. Start most cooking operations on a higher setting and then turn to a lower setting to finish cooking. Each surface element provides a constant amount of heat at each setting. A glowing red surface heating area extending beyond the bottom edge of the cookware indicates the cookware is **too small** for the surface heating area.
3. When cooking has completed, turn the surface control knob to OFF before removing the cookware. Note: The HE message will appear after turning the control knob to OFF if the cooktop is still hot and will remain on until the heating surface area has cooled sufficiently.

Note: See page 8, Figure 5 for recommended control settings.

CAUTION Radiant surface elements may appear to have cooled after they have been turned off. **The glass surface may still be hot** and burns may occur if the glass surface is touched before it has cooled sufficiently.

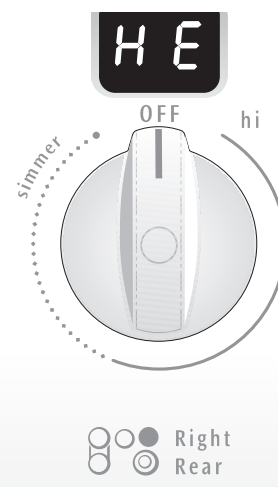

Figure 1

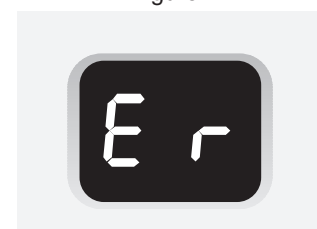

Figure 2

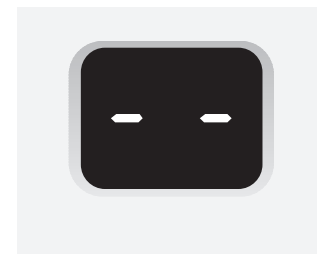

Figure 3

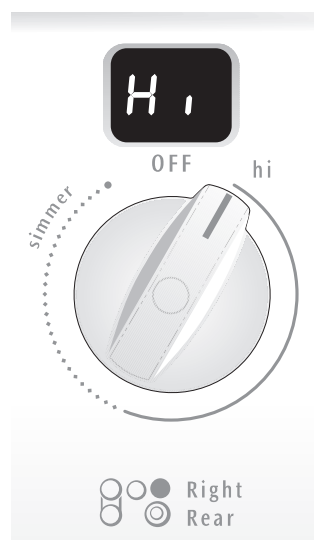

Figure 4

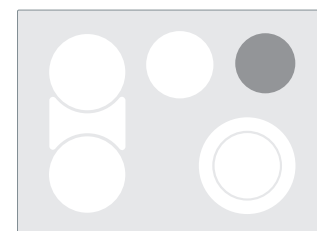

Figure 5
Right Rear Element

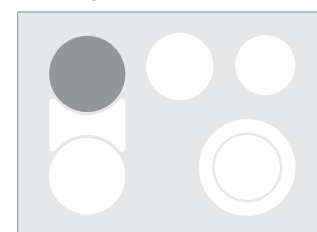

Figure 6
Left Rear Element



Setting Surface Controls



hi

Figure 1

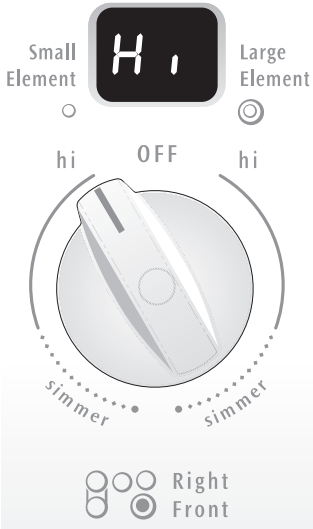

Figure 2



hi

Figure 4

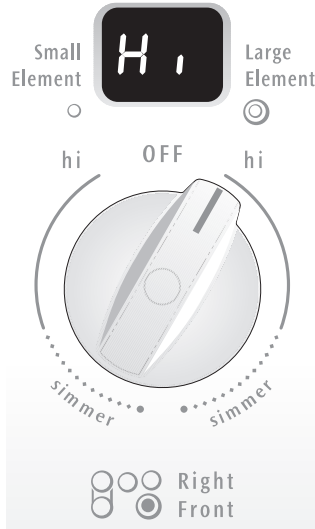

Figure 5

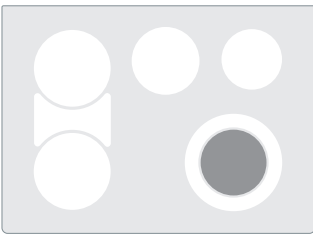

Figure 3

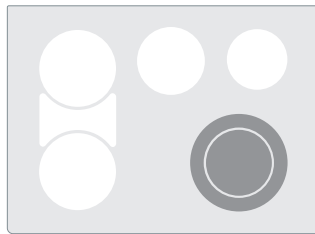

Figure 6

The Dual Surface Radiant Element

The cooktop is equipped with a dual radiant surface element located at the right front (See Fig. 4) position. Symbols on the control panel are used to indicate which coil of the dual radiant element will heat. The symbol shown in Figure 1 indicates that only the inner coil will heat. The symbol shown in Figure 4 indicates that both inner and outer coils will heat. You may switch from either coil setting at any time during cooking.

To Operate the Dual Surface Element:

1. Place correctly sized cookware on the dual surface element.
2. Push in and turn the control knob counterclockwise (See Fig. 2) for smaller cookware or clockwise (See Fig. 5) for larger cookware.
3. Use the ESEC digital display window for the desired setting. Turn (do not push) the knob to adjust the setting if needed. Start most cooking operations on a higher setting and then turn to a lower setting to finish cooking. Each surface element provides a constant amount of heat at each setting. A glowing red surface heating area extending beyond the bottom edge of the cookware indicates the cookware is **too small** for the surface heating area.
4. When cooking has completed, turn the surface control knob to OFF before removing the cookware. Note: The **HE** message will appear after turning the control knob to **OFF** if the cooktop is still hot and will remain on until the radiant heating surface area has cooled sufficiently. Note: See page 8, Figure 5 for recommended control settings.

CAUTION Radiant surface elements may appear to have cooled after they have been turned off. **The glass surface may still be hot** and burns may occur if the glass surface is touched before it has cooled sufficiently.

The Bridge Surface Radiant Element

The cooktop is equipped with a "BRIDGE" surface element located at the left front and middle (See Fig. 10) positions. The Bridge can be used when cooking with rectangular (like a griddle) or oval shaped cookware (Fig. 10). The element will maintain an even temperature setting across both portions of the Bridge. If needed for normal cookware, the Bridge element can work like a single element without the Bridge (See Fig. 8).

Bridge element operation symbols are located on the control panel on each side of the Bridge element control knob. These symbols indicate the direction to turn the control knob when operating the Bridge element. The symbol in Figure 7 indicates that only the single portion of the Bridge element will heat (See Fig. 8). The symbol in Figure 9 indicates that both the single and Bridge portions of the element will heat together (Fig. 10). You may switch from either of these settings at any time during cooking with the Bridge element.



Figure 7



Figure 9

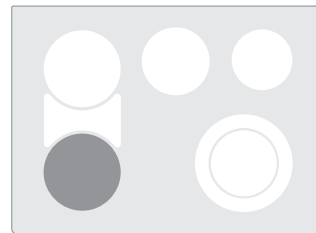

Figure 8
Bridge element without
Bridge portion.

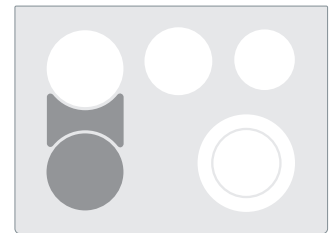

Figure 10
Bridge element with Bridge
portion.

Setting Surface Controls

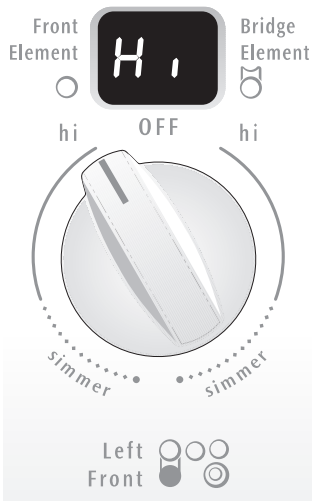

Figure 1

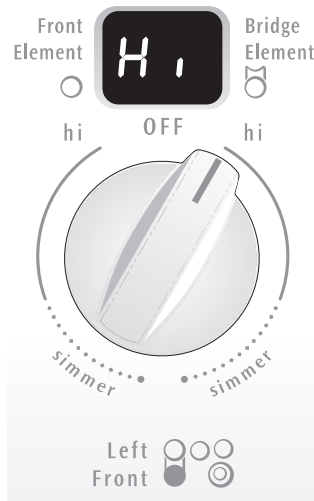

Figure 3

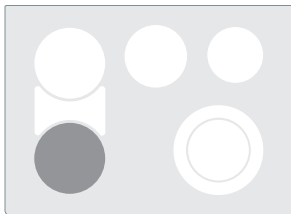

Figure 2

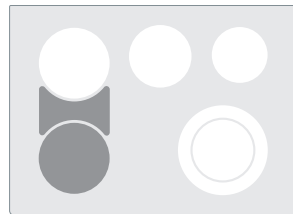

Figure 4

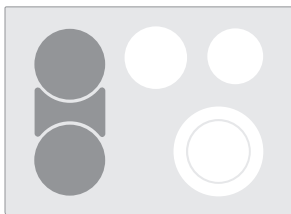

Figure 5

To Operate the Bridge Surface Element:

1. Place correctly sized cookware on the Bridge surface element.
2. Push in and turn the control knob counterclockwise (See Figs. 1 and 2) to heat the portion of the Bridge element for normal shaped cookware or clockwise (See Figs. 3 and 4) for larger or rectangular shaped cookware.
3. Use the ESEC digital display window for the desired setting. Turn (do not push) the knob to adjust the setting if needed. Start most cooking operations on a higher setting and then turn to a lower setting to finish cooking. Each surface element provides a constant amount of heat at each setting. A glowing red surface heating area extending beyond the bottom edge of the cookware indicates the cookware is **too small**. Please note that not all cookware will fit the Bridge element correctly.
4. When cooking has completed, turn the surface control knob to OFF before removing the cookware. The **HE** message will appear in the display after turning the control knob to **OFF** if the cooktop is still hot and will remain on until the radiant heating surface area has cooled sufficiently.

The BRIDGE element may also be used in combination with the left rear single element. Because these elements have 2 different controls, one element can be used to cook while the other element may be used to keep food warm (See Fig. 5).

CAUTION Radiant surface elements may appear to have cooled after they have been turned off. **The glass surface may still be hot** and burns may occur if the glass surface is touched before it has cooled sufficiently.

Surface Cooking



Using Proper Cookware

Cookware should have flat bottoms that make good contact with the entire surface heating element. Check for flatness by rotating a ruler across the bottom of the cookware (See Fig. 6).

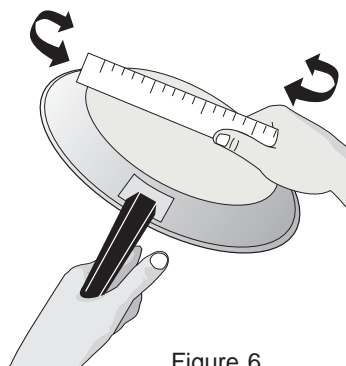
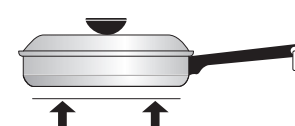

Figure 6

Be sure to follow the recommendations for using cookware as shown in Fig. 7.

Note: The size and type of cookware used will influence the setting needed for best cooking results.

*CORRECT



- Flat bottom and straight sides.
- Tight fitting lids.
- Weight of handle does not tilt pan. Pan is well balanced.
- Pan sizes match the amount of food to be prepared and the size of the surface element.
- Made of a material that conducts heat well.
- Easy to clean.
- Always match pot diameter to element surface diameter.

INCORRECT



- Curved and warped pan bottoms.



- Pan overhangs element by more than one-half inch.



- Pan is smaller than element.



- Heavy handle tilts pan.

Figure 7



Surface Cooking

Operating the Warming Zone

The purpose of the Warming Zone is to keep hot cooked foods at serving temperature. Use the Warming Zone to keep cooked foods hot such as; vegetables, gravies, casseroles, soups, stews, breads, pastries and oven-safe dinner plates. Always start with hot food. It is not recommended to heat cold food on the Warming Zone.

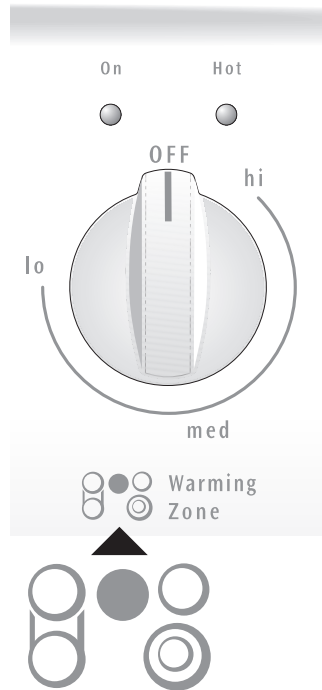

Figure 1

All food placed on the Warming Zone should be covered with a lid or aluminum foil to maintain quality. For best results, when warming pastries or breads, the cover should have an opening to allow moisture to escape. **Do not use plastic wrap to cover food. Plastic may melt onto the surface and be very difficult to clean.** Use only plates, utensils and cookware recommended for oven and cooktop use on the Warming Zone.

CAUTION Always use pot holders or oven mitts when removing food from the Warming Zone as cookware and plates will be hot.

To Set the Warming Zone Control:

1. To set the control, push in and turn the knob. The **On** indicator light will come on (See Fig. 1 and 2). The temperatures are approximate, and are designated by HI, MED and LO. However, the control can be set at any position between HI and LO for different levels of heating (Fig. 1).
2. When done, turn the control to OFF. The **Warming Zone Hot surface indicator light** will remain on until the **Warming Zone** cools to a moderate level (See Fig. 1 and 2).

Temperature Selection

Refer to the table for recommended Warming Zone food settings (Fig. 3). If a particular food is not listed, start with the medium level, and adjust as needed. Most foods can be kept at serving temperatures by using the medium level.

CAUTION The Warming Zone will not glow red when it is hot, but becomes hot enough to cause burns. Avoid placing hands on or near the Warming Zone until the Warming Zone Hot surface indicator light is off.

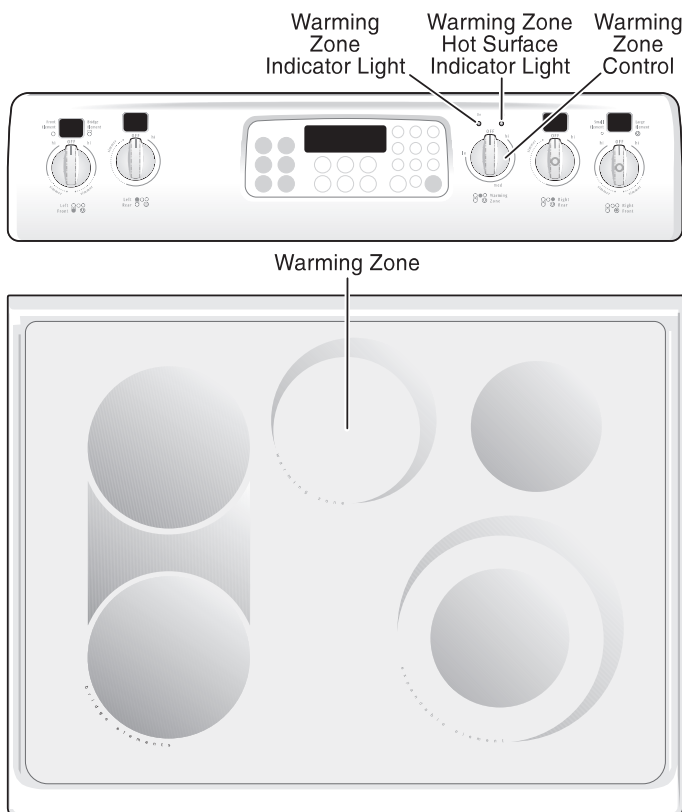

Figure 2

Warming Zone Recommended Food Settings Table	
Food Item	Heating Level
Hot Beverages	HI
Fried Foods	HI
Vegetables	MED
Soups (Cream)	MED
Stews	MED
Sauces	MED
Meats	MED
Gravies	LO
Eggs	LO
Dinner Plates with Food	LO
Casseroles	LO
Breads/Pasteries	LO

Figure 3

Before Setting Oven Controls



Arranging the Oven Racks

ALWAYS ARRANGE OVEN RACKS WHEN THE OVEN IS COOL (PRIOR TO OPERATING THE OVEN). Always use oven mitts when the oven is hot.

Oven Vent Location

The oven vent is located **below the backguard**. When the oven is on, hot air is released through the vents. This venting is necessary for proper air circulation in the oven and good baking results.

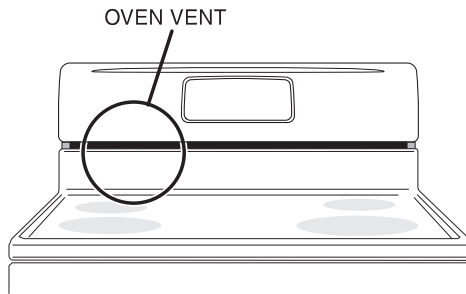

Removing and Replacing Oven Racks

To remove, pull the rack forward until it stops. Lift up front of rack and slide out. **To replace**, fit the rack onto the guides on the oven walls. Tilt the front of the rack upward and slide the rack back into place.

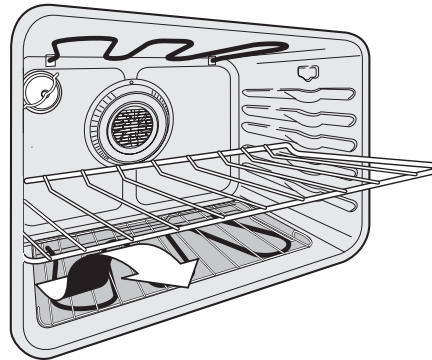

Arranging Oven Racks

To bake on a single rack, place the rack in position 3 or 4. **To bake on 2 racks**, place the racks in positions 2 and 4. To bake on 3 racks, place the racks in positions 1, 3 and 5. Use the 6th rack position (Roasting Shelf) for roasting large food items only.

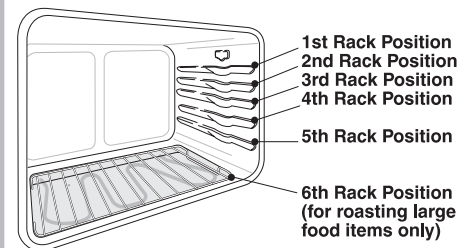

Air Circulation in the Oven

If using 1 rack, place in center of oven. If using multiple racks, stagger cookware as shown.

For best air circulation and baking results allow 2-4" (5-10 cm) around the cookware for proper air circulation and be sure pans and cookware do not touch each other, the oven door, sides or back of the oven cavity. The hot air must circulate around the pans and cookware in the oven for even heat to reach around the food.

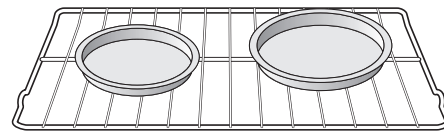

1 Oven Rack

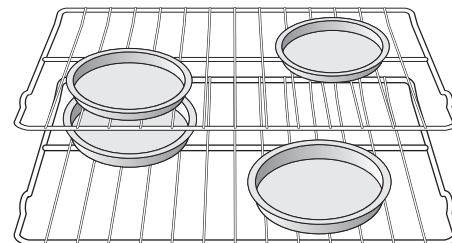

Multiple Oven Racks



Setting Warming Drawer Controls (some models)

Arranging Warming Drawer Rack Positions

The rack can be used in 2 ways:

- In the **upright position** to allow low profile food items to be placed both under and on top of the rack (for example, rolls or biscuits on top of the rack and a casserole dish underneath).
- In the **downward position** to allow you to place light weight food items and empty cookware (for example, rolls or pastries and dinner plates) on the rack.

Set the Warming Drawer rack in either position as shown below (Fig. 1).

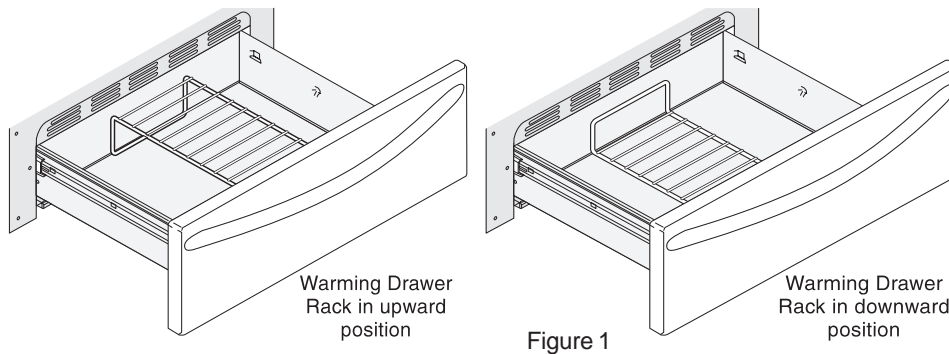
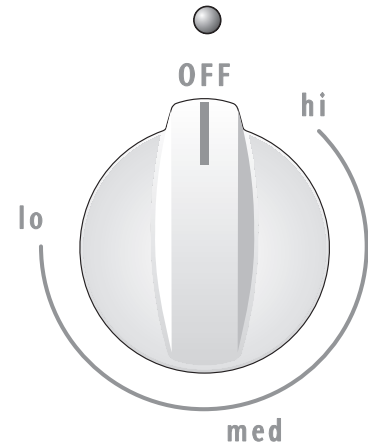

Figure 1

CAUTION Always use pot holders or oven mitts when removing food from the Warming Drawer as cookware and plates will be hot and you can be burned.



Warming Drawer

Figure 2

To Operate the Warming Drawer

The purpose of the Warming Drawer is to keep hot cooked foods at serving temperature. Always start with hot food. It is not recommended to heat cold food in the Warming Drawer.

All food placed in the Warming Drawer should be covered with a lid or aluminum foil to maintain quality. **Do not use plastic wrap to cover food. Plastic may melt onto the drawer and be very difficult to clean.** Use only utensils and cookware recommended for oven use in the Warming Drawer.

To Set the Warming Drawer Control

The control is used to select the temperature of the Warming Drawer. It is located on the control panel. To set the control, push in and turn the knob to the desired setting. The temperatures are approximate, and are designated by **HI** (high), **MED** (medium) and **LO** (low). To set the Warming Drawer control:

1. Turn the knob to select the desired temperature setting.
2. For best results, preheat the drawer before adding food. An empty drawer will preheat in approximately 15 minutes.
3. When done, turn the control to **OFF**.

Warming Drawer Temperature Selection

Recommended Warming Drawer food settings are shown in Figure 3. If a particular food is not listed, start with the MED setting. If more crispness is desired, remove the lid or aluminum foil from the food. Most foods can be kept at serving temperatures on the MED setting. When a combination of foods are to be kept warm (for example, a meat with 2 vegetables and rolls) use the HI setting. To avoid heat loss, do not open the Warming Drawer while in use.

Warming Drawer Indicator Light

The Warming Drawer indicator light is located above the Warming Drawer control knob (See Fig. 2). It turns on when the control is set, and stays on until the control is turned off. **The Warming Drawer will not operate during the self-clean cycle.**

Warming Drawer Recommended Food Settings Table	
Food Item	Setting
Bacon	HI
Hamburger Patties	HI
Poultry	HI
Pork Chops	HI
Fried Foods	HI
Pizza	HI
Gravies	MED
Casseroles	MED
Eggs	MED
Roasts (Beef, Pork, Lamb)	MED
Vegetables	MED
Biscuits	MED
Rolls, hard	MED
Pastries	MED
Rolls (soft)	LO
Empty Dinner Plates	LO

Figure 3

Control Pad Features



READ THE INSTRUCTIONS CAREFULLY BEFORE USING THE OVEN. For satisfactory use of your oven, become familiar with the various features and functions of the oven as described below. **Detailed instructions for each feature and function follow later in this Use & Care Manual.**

CONVECTION BAKE— Used to select the Convection Bake feature (See page 26).

CONVECTION ROAST— Used to select the Convection Roast feature (See page 25).

OVEN LIGHT— Used to turn the oven light on and off (See page 34).

OVEN LOCKOUT— Used to disable all oven features (See page 18).

CLOCK— Used to set the time of day. (See page 16).

0 THRU 9 NUMBER PADS— Used to enter temperature and times.

BROIL— Used to select variable Broil feature (See page 24).

BAKE— Used to enter the normal baking feature. (See page 21).

PREHEAT— Used to bring the oven temperature up before placing food (See page 20).

CLEAN— Used to select the self-cleaning feature (See page 28).

TIMER ON/OFF— Used to set or cancel the kitchen timer. The kitchen timer does not start or stop cooking (See page 17).

BAKE TIME— Used to enter the length of the baking time.

STOP TIME— Used with **BAKE, COOK TIME, and CLEAN** to program a delayed baking or delayed self-cleaning cycle stop time.

CLEAR/OFF— Used to cancel any oven mode previously entered except the oven lock out, time of day and minute timer. Press **CLEAR/OFF** to stop cooking.

START— Used to start all oven features (not used with Oven Light).

Minimum and Maximum Control Pad Settings

All of the features listed have minimum and maximum time or temperature settings that may be entered into the control. An ENTRY acceptance beep will sound each time a control pad is touched (the Oven Lockout pad is delayed by 3 seconds). An ENTRY ERROR tone (3 short beeps) will sound if the entry of the temperature or time is below the minimum or above the maximum settings for the feature.

FEATURE	MIN. TEMP. /TIME	MAX. TEMP. /TIME
PREHEAT TEMP.	170°F / 77°C	550°F / 288°C
BAKE TEMP.	170°F / 77°C	550°F / 288°C
BROIL TEMP.	400°F / 205°C	HI-550°F / 288°C
KITCHEN TIMER	12 Hr. 0:01 Min.	11:59 Hr./ Min.
	24 Hr. 0:01 Min.	11:59 Hr./ Min.
CLOCK TIME	12 Hr. 1:00 Hr./ Min.	12:59 Hr./ Min.
	24 Hr. 0:00 Hr./ Min.	11:59 Hr./ Min.
OVEN BAKE TIME	12 Hr. 0:01 Min.	11:59 Hr./ Min.
	24 Hr. 0:01 Min.	23:59 Hr./ Min.
STOP TIME	12 Hr. 1:00 Hr./ Min.	12:59 Hr./ Min.
	24 Hr. 0:00 Hr./ Min.	23:59 Hr./ Min.
CLEAN TIME	2 hours	4 hours
CONVECTIONBAKE	300°F / 149°C	550°F / 288°C



Setting Oven Controls

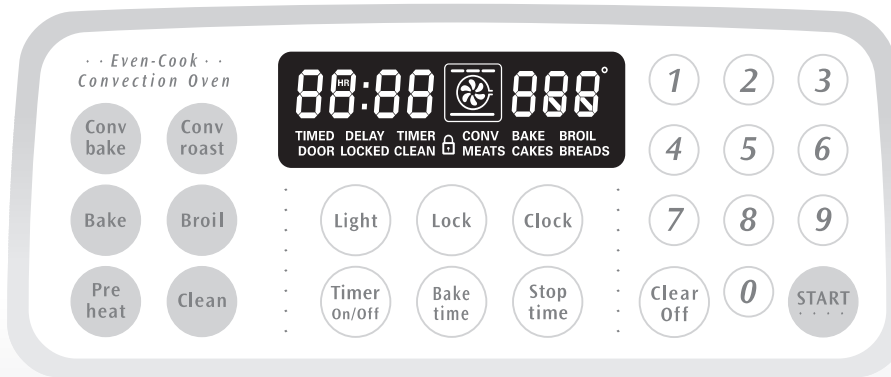





Setting the Clock





The **CLOCK**  pad is used to set the clock. The clock may be set for 12 or 24 hour time of day operation. The clock has been preset at the factory for the 12 hour operation. When the range is first plugged in, or when the power supply to the range has been interrupted, the timer in the display will flash with "PF" (power failure, See Fig. 1).

INSTRUCTIONS

To set the clock (example below for 1:30):

1. Press . "CLO" will appear in the display (Fig. 2).
2. Press    pads to set the time of day to 1:30 (Fig. 3).
- 3). "CLO" will appear in the display. Press . "CLO" will disappear and the clock will start (Fig. 4).

Changing between 12 or 24 hour time of day display:

1. Press and hold  for 6 seconds (Fig. 3). While holding the pad down, the current time of day will remain and "CLO" will disappear from the display (Fig. 4). CONTINUE holding the pad until the a beep is heard.
2. The display will show either "12:00" (Fig. 5) or "24:00" (Fig. 6).
3. Press  to switch between the 12 and 24 hour time of day display. The display will show either "12:00" (Fig. 5) or "24:00" (Fig. 6).
4. Press  to accept the change or press  to reject the change.
5. Reset the correct time as described in **To set the Clock** above. Please note that if the 24 hour time of day mode was chosen, the clock will now display time from 0:00 through 23:59 hours.

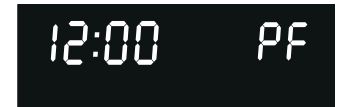

Figure 1

PRESS

DISPLAY

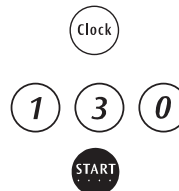

Figure 2



Figure 3

 for 6 seconds



Figure 4



Figure 5



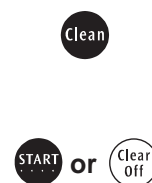

Figure 6



Setting Oven Controls







Setting Continuous Bake or 12 Hour Energy Saving

The **KITCHEN TIMER**  and **CLEAN**  pads control the Continuous Bake or 12 Hour Energy Saving features. The oven control has a factory preset built-in 12 Hour Energy Saving feature that will shut off the oven if the oven control is left on for more than 11 hours and 59 minutes. The oven can be programmed to override this feature for Continuous Baking.

INSTRUCTIONS

To set the control for Continuous Bake or 12 Hour Energy Saving features:

1. Press and hold  for 7 seconds (Fig.1). ":12" or ":- -" will appear in the display and the control will beep once.
2. Press  to switch between the 12 Hour Energy Saving and continuous bake features. Note: ":12" in the display indicates the control is set for the 12 Hour Energy Saving mode and ":- -" indicates the control is set for the Continuous Bake feature (Figures 2 and 3).
3. Press  to accept the change (Fig. 4; display will return to time of day) or press  to reject the change.

PRESS

 for 7 seconds



 or 

DISPLAY



Figure 1



Figure 2



Figure 3







Figure 4

Setting Kitchen Timer

The **KITCHEN TIMER**  pad controls the Kitchen Timer feature. The Kitchen Timer serves as an extra timer in the kitchen that will beep when the set time has run out. It does not start or stop cooking. The Kitchen Timer feature can be used during any of the other oven control functions. Refer to the "Minimum and Maximum Control Pad Settings" on page 15 for the time amount settings.

INSTRUCTIONS

To set the Kitchen Timer (example for 5 minutes):

1. Press . "0:00" will appear and "TIMER" will flash in the display (Fig. 5).
2. Press the number pads to set the desired time in the display (example ). Press . The time will begin to count down (Fig. 6) and "TIMER" will appear in the display. Note: If  is not pressed the timer will return to the time of day.
3. When the set time has run out, "End" will show in the display (Fig. 7), and 3 beeps every 60 seconds will sound until  is pressed.

PRESS





DISPLAY



Figure 5



Figure 6



Figure 7

To cancel the Kitchen Timer before the set time has run out:

Press . The display will return to the time of day.





Setting Oven Controls

Setting Oven Lockout Feature

The **Lock** pad controls the Oven Lockout feature. The Oven Lockout feature automatically locks the oven door and prevents the warmer drawer and ESEC Control from being turned on. It does not disable the clock, Kitchen Timer, Warmer Zone or the interior oven lights.

INSTRUCTIONS

PRESS

DISPLAY

To activate the Oven Lockout feature:

1. Press and hold **Lock** for three seconds (Fig. 1).
2. After 3 seconds the lock icon light () will appear, a beep will sound and "DOOR LOCKED" will flash in the display. Once the oven door is locked the "DOOR LOCKED" indicator will stop flashing and remain on along with the lock icon light.

Lock for 3 seconds

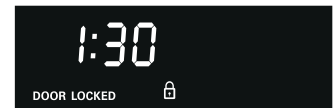



Figure 1

To reactivate normal oven operation:

1. Press and hold **Lock** for three seconds. A beep will sound. The "DOOR LOCKED" will continue to flash until the oven door has completely unlocked and the lock icon light () will clear (See Fig. 2).
2. The range is again fully operational.

Lock for 3 seconds

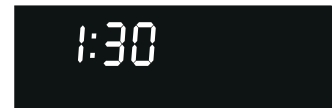

Figure 2

Setting Temperature Display — Fahrenheit or Celsius

The **BROIL** **Broil** and **CLEAN** **Clean** pads control the Fahrenheit or Celsius temperature display modes. The oven control can be programmed to display temperatures in Fahrenheit or Celsius. The oven has been preset at the factory to display in Fahrenheit.

INSTRUCTIONS

PRESS

DISPLAY

To change display from Fahrenheit to Celsius or Celsius to Fahrenheit:

1. To tell if the display is set for Fahrenheit or Celsius press and hold the **Broil** pad. "BROIL", "550°" will appear in the display (See Fig. 3) and continue to HOLD for 7 seconds. A beep will then sound. If "F" appears, the display is set to show temperatures in Fahrenheit (Fig. 4). If "C" appears, the display is set to show temperatures in Celsius (Fig. 5).
2. Press **Clean** to switch between Fahrenheit or Celsius display modes. The display will show either "F" (Fig. 4) or "C" (Fig. 5).
3. Press **START** to accept the change or press **Clear off** to reject the change.

Broil for 7seconds

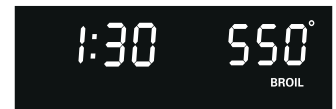

Figure 3

Clean

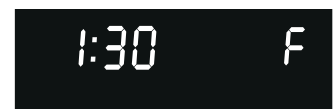

Figure 4

START or **Clear off**

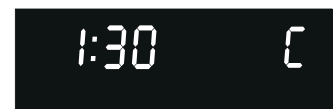
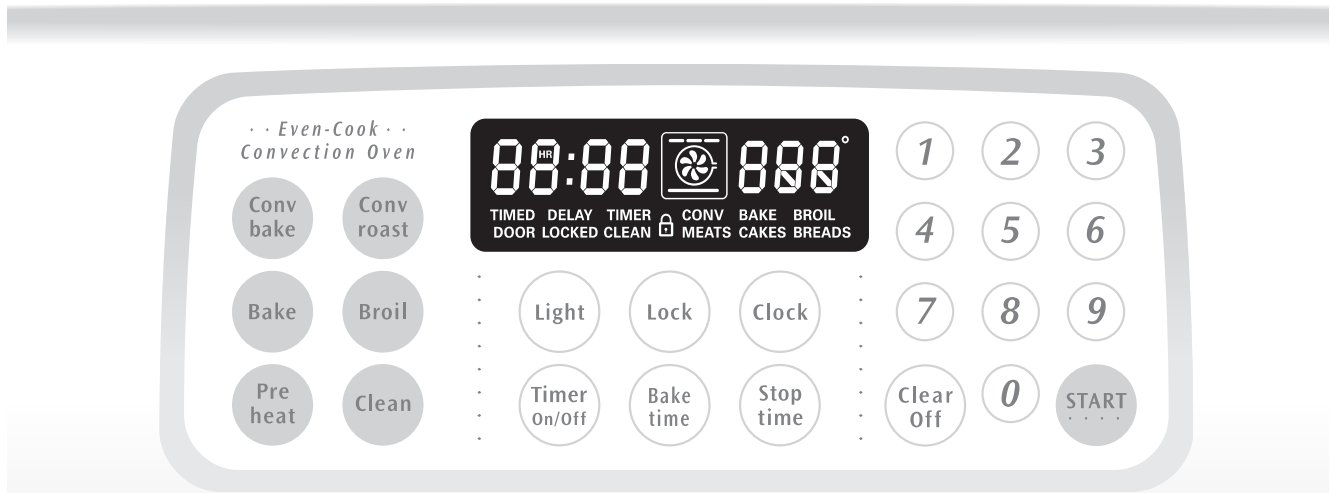



Figure 5

Setting Oven Controls



Setting Silent Control Operation





The **STOP TIME**  and **CLEAN**  pads control the Silent Control operation feature. The Silent Control operation feature allows the oven control to be operated without sounds or beeps whenever necessary. If desired the control can be programmed for silent operation and later returned to operating with all the normal sounds and beeps.

INSTRUCTIONS

PRESS

DISPLAY

To change control from normal sound operation to silent control operation:

- To tell if your range is set for normal or silent operation press and hold  for 7 seconds. "DELAY" will appear and flash in the display (Fig. 1). If ":SP" appears (Fig. 2), the control will operate with normal sounds and beeps. If ":-" appears (Fig.3), the control is in the silent operation mode.
- Press  to switch between normal sound operation and silent operation mode. The display will show either ":SP" (Fig. 2) or ":-" (Fig. 3).
- Press  to accept the change or press  to reject the change.

 for 7seconds

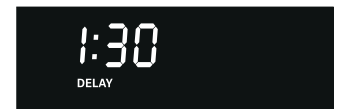

Figure 1



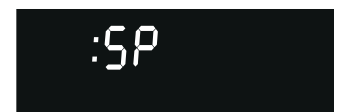

Figure 2

 or 



Figure 3



Setting Oven Controls

Setting Preheat





The **PREHEAT**  pad controls the Preheat feature. The Preheat feature will bring the oven up to temperature and then indicate when to place the food in the oven. Use this feature when recipes call for preheating. Preheating is not necessary when roasting or cooking casseroles. The oven can be programmed to preheat at any temperature between 170°F to 550°F.

INSTRUCTIONS

PRESS

DISPLAY

To set the Preheat temperature for 350°F:

1. Arrange the interior oven racks.
2. Press . " - - - °" and "BAKE" will appear in the display (Fig. 1).
3. Press   . "350°" and "PRE" will appear in the display (Fig. 2).
4. Press . "PRE" and "BAKE" will appear in the display as the oven heats and reaches 350°F (Fig 3).

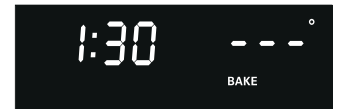
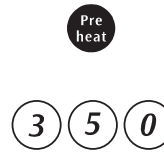

Figure 1

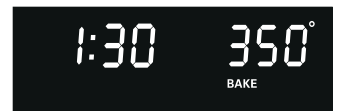

Figure 2



Figure 3



Figure 4







Note: After the oven has reached the desired temperature (this example, 350°F) the control will beep and the "PRE" light will turn off and oven temperature will be displayed (Fig. 4). If the beep was missed, a quick glance at the display with oven temperature showing in the oven display is a good way to check that the oven has already reached the preheat temperature. Once the oven has preheated, **PLACE FOOD IN THE OVEN**. The "BAKE" light will stay on.

Press  when baking is complete or to cancel the preheat feature.



To change Preheat temperature while oven is preheating (example changing from 350 to 425°F):

If it is necessary to change the preheat temperature while the oven is preheating to the original temperature:

1. While preheating, press . " - - - °" and "BAKE" will appear in the display (Fig. 5)
2. Enter the new preheat temperature. Press   . "425°" and "BAKE" will appear in the display (Fig. 6).
3. Press . "PRE" and "BAKE" will appear in the display as the oven heats to 425°F (Fig 7). A beep will sound once the oven temperature reaches 425°F and the display will show "425°" and "BAKE".
4. When baking is complete press .

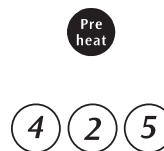

Figure 5



Figure 6



Figure 7

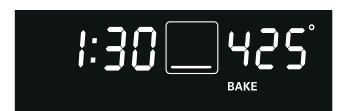



Figure 8

Setting Oven Controls





Setting Bake

The **BAKE**  pad controls normal baking. If preheating is necessary, refer to the **Pre heat**  Preheat Feature for instructions. The oven can be programmed to bake at any temperature from 170°F to 550°F (The sample shown below is for 350°F).

INSTRUCTIONS

To set the Bake Temperature to 350°F:

1. Arrange interior oven racks and place food in oven.
 2. Press **Bake** , " - - - ° " will appear in the display (Fig. 1).
 3. Press **3** **5** **0** (Fig. 2). "BAKE" will flash and "350°" will appear in the display.
 4. Press **START** . "BAKE" and "350°" will appear in the display (See Fig. 3).
- Note: A beep will sound once the oven temperature reaches 350° F.
- Pressing **Clear Off**  will cancel the Bake feature at any time.

PRESS

DISPLAY

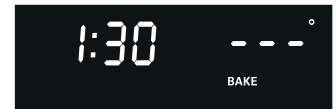

Figure 1

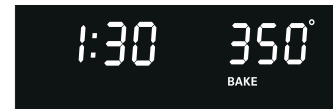

Figure 2



Figure 3



Figure 4





Figure 5



Figure 6

To change the Bake Temperature (example changing from 350° to 425°F):

1. After the oven has already been set to bake at 350°F and the oven temperature needs to be changed to 425°F, press **Bake**  (Fig.4) and " - - - ° " will show in the display.
2. Press **4** **2** **5** (Fig. 5). "425°" and "BAKE" will appear in the display.
3. Press **START** . "BAKE" and the new oven temperature "425°" will appear in the display (Fig 6).

Bake



4 2 5

START











Setting Oven Controls





Setting Timed Bake

The **BAKE**  and **BAKE TIME**  pads control the Timed Bake feature. The automatic timer of the Timed Baked feature will turn the oven **off** at the time you select in advance.

INSTRUCTIONS

To program the oven to begin baking immediately and to shut off automatically: (example below to bake at 350°F for 50 minutes):

1. Be sure the clock is set for the correct time of day.
2. Arrange interior oven rack(s) and place the food in the oven.
3. Press , " - - - °" will appear in the display (Fig. 1).
4. Press    (Fig. 2). "**BAKE**" will flash and "**350°**" will appear in the display.
5. Press . "**BAKE**" and "**350°**" will be displayed (See Fig. 3).
6. Press . "**TIMED**" will flash; "**BAKE**", "**0:00**" and "**350°**" will appear in the display (Fig.4).
7. Enter the desired baking time by pressing  . "**TIMED**" will flash and "**BAKE**", "**:50**" and "**350°**" will appear in the display (Fig. 5). Note: Baking time can be set for any amount of time between 1 minute to 11 hours and 59 minutes.
8. Press . Both the "**TIMED**" and "**BAKE**" icons will remain on in the display (Fig. 6). Once the Timed Bake feature has started, the current time of day will appear in the display.

Note: After the Timed Bake feature has activated, press  to display the bake time remaining in the Timed Bake mode. Once Timed Bake has started baking, a beep will sound when the oven temperature reaches the set temperature. The **BAKE TIME**  pad may also be used to set timed or delayed timed cooking with the **CONV ROAST**  or **CONV BAKE**  pads.

Press  when baking is complete or at any time to cancel the Timed Bake feature.

When the timed bake time runs out:

1. "**End**" will appear in the display and the oven will shut off automatically (Fig. 7).
2. The control will beep 4 times. The control will continue to beep 3 times each minute until  is pressed.

PRESS

DISPLAY

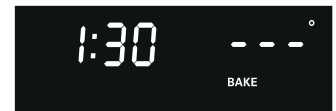

Figure 1

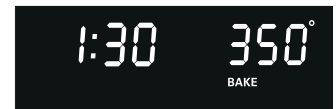

Figure 2



Figure 3



Figure 4



Figure 5

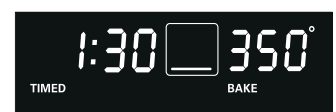

Figure 6

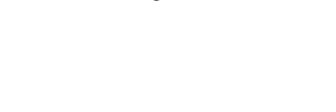

Figure 7



CAUTION Use caution with the **TIMED BAKE** or **DELAYED TIME BAKE** features. Use the automatic timer when cooking cured or frozen meats and most fruits and vegetables. Foods that can easily spoil such as milk, eggs, fish, meat or poultry, should be chilled in the refrigerator first. Even when chilled, they should not stand in the oven for more than 1 hour before cooking begins, and should be removed promptly when cooking is completed. Eating spoiled food can result in sickness from food poisoning.

Setting Oven Controls



















Setting Delayed Time Bake

The **BAKE** , **BAKE TIME**  and **STOP TIME**  pads control the Delayed Time Bake feature. The automatic timer of the Delayed Time Bake will turn the oven **on and off** at the time you select in advance.

INSTRUCTIONS

To program the oven for a delayed bake start time and to shut off automatically (example for baking at 350°F for 50 minutes and finishing at 5:30):

1. Be sure that the clock is set with the correct time of day.
2. Arrange interior oven rack(s) and place the food in the oven.
3. Press . "- - - °" will appear in the display (Fig. 1).
4. Press    (Fig. 2). "BAKE" will flash and "350°" will appear in the display.
5. Press . "BAKE" and "350°" will appear in the display (Fig. 3).
6. Press . "TIMED" will flash; "BAKE", "0:00" and "350°" will appear in the display (Fig. 4).
7. Enter the desired baking time using the number pads by pressing  . "TIMED" will flash; "BAKE", ":50" and "350°" will appear in the display (Fig. 5). Note: Baking time can be set for any amount of time from 1 minute to 11 hours and 59 minutes.
8. Press . "TIMED", "BAKE" and "350°" will be displayed (Fig. 6).
9. Press . Enter the desired stop time using the number pads    (Fig. 7).
10. Press . When Delayed Time Bake starts, the set oven temperature will disappear, "TIMED DELAY", "BAKE" and the current time of time of day will appear in the display (Fig. 8).

Note: Once Delayed Time Bake has started, press  to display the bake time remaining. Once Delayed Time Bake has started baking, a beep will sound when the oven temperature reaches the set temperature. Press  when baking has completed or at any time to cancel the Delayed Time Bake feature.

When the set bake time runs out:

1. "End" will appear in the display and the oven will shut off automatically (Fig. 9).
2. The control will beep 4 times. The control will continue to beep 3 times each minute until  is pressed.

PRESS

DISPLAY



Figure 1

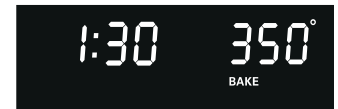

Figure 2



Figure 3



Figure 4



Figure 5

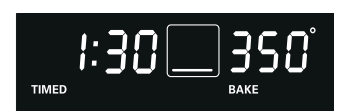

Figure 6

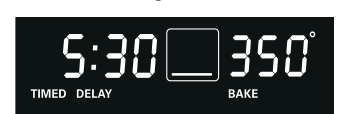

Figure 7

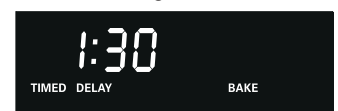

Figure 8



Figure 9





Setting Oven Controls

Setting Broil (for Electric Ranges) - The **Broil** pad controls the Broil feature. When broiling, heat radiates downward from the oven broiler element for even coverage. The Broil feature is preset to start broiling at 550°F however, the Broil feature temperature may be set between 400°F and 550°F.

The broil pan and broil pan insert used together allow dripping grease to drain and be kept away from the high heat of the oven broiler. **DO NOT** use the broil pan without the insert (See Fig. 5). **DO NOT cover the broil pan insert with foil.** The exposed grease could catch fire.

WARNING Should an oven fire occur, leave the oven door closed and turn off the oven. If the fire continues, throw baking soda on the fire or use a fire extinguisher. **DO NOT** put water or flour on the fire. Flour may be explosive and water can cause a grease fire to spread and cause personal injury.

INSTRUCTIONS

To set the oven to broil at the default setting (550°F):

1. Place the broiler pan insert on the broiler pan. Then place the food on the broiler pan insert. **DO NOT** use the broiler pan without the insert. **DO NOT** cover the broiler insert with foil. The exposed grease could ignite.
2. Arrange the interior oven rack and place the broiler pan on the rack. Be sure to center the broiler pan directly under the broiler element. **Make sure the oven door is in the broil stop position (See Fig. 4).**
3. Press **Broil**. "BROIL" will flash and "550°" will appear (Fig. 1).
4. If a lower broil temperature is desired (minimum broil temperature setting is 400°F), press the desired temperature before continuing to step 5.
5. Press **START**. The oven will begin to broil. "BROIL" and "550°" will appear in the display (Fig. 2).
6. Broil on one side until food is browned; turn and cook on the second side. Season and serve. **Note:** Always pull the rack out to the stop position before turning or removing food.
7. To cancel broiling or if finished broiling press **Clear Off** (Fig. 3).

PRESS

DISPLAY

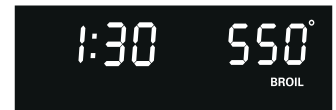

Figure 1



Figure 2

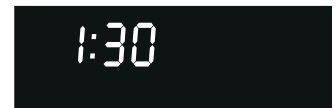

Figure 3

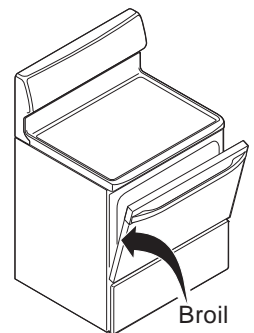

Figure 4 Broil Stop Position

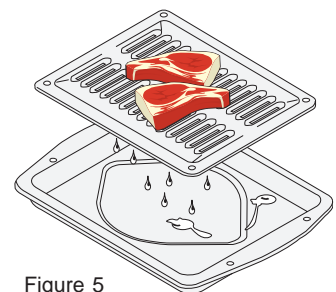

Figure 5

Broiling Times

Use the following table for approximate broiling times. Increase or decrease broiling times, or move the broiling pan to a different rack position to suit for doneness. If the food you are broiling is not listed in the table, follow the instructions provided in your cookbook and watch the item closely.

Electric Range Broiling Table Recommendations

Food Item	Rack Position	Temp Setting	Cook Time		Doneness
			1st side	2nd side	
Steak 1" thick	2nd	550° F	6:00	4:00	Rare
	2nd	550° F	7:00	5:00	Medium
Pork Chops 3/4" thick	2nd	550° F	8:00	6:00	Well
Chicken - Bone In	3rd	450° F	20:00	10:00	Well
Chicken - Boneless	2nd	450° F	8:00	6:00	Well
Fish	2nd	500° F	13:00	n/a	Well
Shrimp	3rd	550° F	5:00	n/a	Well
Hamburger 3/4" thick	2nd	550° F	9:00	7:00	Medium
	3rd	550° F	10:00	8:00	Well

Setting Oven Controls







Setting Convection Roast

The **CONV ROAST**  pad feature is used when cooking with meat. This pad has been designed to give optimum cook performance for roasting meats.

The CONVECTION ROAST pad combines a cook cycle with the convection fan and element to roast meats and poultry. Preheating is not necessary for meats and poultry. Heated air circulates around the food from all sides, sealing in juices and flavors. Foods are crispy brown on the outside while staying moist on the inside.

INSTRUCTIONS

To set the Convection Roast feature (example for Convection Roast at 350°F):

1. Arrange interior oven racks and place food in oven.
2. Press . "CONV" will flash and "---°" will be displayed (See Fig. 1).
3. Press   . "CONV" will flash and "350°" will appear in the display (See Fig. 2).
4. Press . "CONV", "350°" and the convection fan icon will also appear in the display (See Fig. 3).

Press  to stop Convection Roast, or to cancel Convection Roast at any time.

PRESS



DISPLAY



Figure 1



Figure 2



Figure 3

Convection Roasting Instructions

When using the Convection Roast pad, use the broiler pan and insert along with the roasting rack. The broiler pan will catch grease spills and the insert will help prevent grease splatters. The roasting rack will allow the heat to circulate around the meat.

CAUTION To prevent food from contacting the broil element and to prevent grease splattering, **DO NOT** use the roasting rack when broiling.

1. Place oven rack on bottom or next to the bottom rack position. See **Arranging Oven Racks** in this Use & Care Manual.
2. Place the insert in the broiler pan. The roasting rack fits on the insert allowing the heated air to circulate under the food for even cooking and helps to increase browning on the underside. Make sure the roasting rack is securely seated on the insert in the broiler pan. **DO NOT** use the broiler pan without the insert or cover the insert with aluminum foil.
3. Position food (fat side up) on the roasting rack (See Fig. 4).
4. Place the broiler pan on the oven rack.

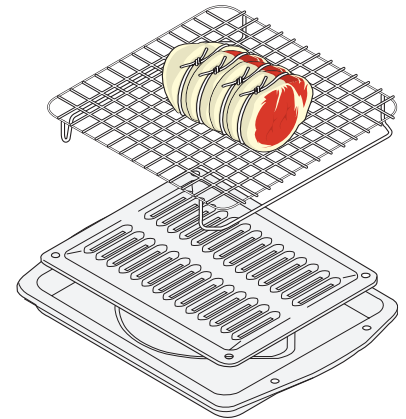





Figure 4

Note: The **BAKE TIME**  pad may be used to set timed or delayed timed cooking with the **CONV ROAST**  pad (refer to page 22, steps 6-8).



Setting Oven Controls

Setting Convection Bake

The **CONV BAKE**  pad controls the Convection Bake feature. Use the Convection Bake feature when cooking speed is desired. The oven can be programmed for Convection baking at any temperature between 300°F (149°C) to 550°F (288°C).

Benefits of Convection Bake:

- Some foods cook up to 30% faster, saving time and energy.
- Multiple rack baking.
- No special pans or bakeware needed.

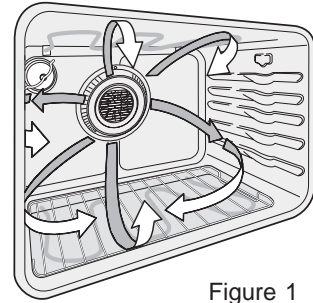

Air circulation during Convection Bake

Figure 1

Convection baking uses a fan to circulate the oven's heat evenly and continuously within the oven (See Figure 1). This improved heat distribution allows for fast, even cooking and browning results. It also gives better baking results when using two (2) or three (3) racks at the same time. Breads and pastries brown more evenly. Most foods cooked in a standard oven will cook faster and more evenly with Convection Bake.

Note: The **BAKE TIME**  pad may be used to set timed or delayed

timed cooking with the **CONV BAKE**  pad (refer to page 22 steps 6-8).

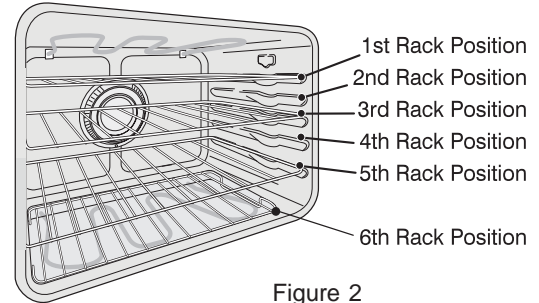







Figure 2

General Convection Bake Instructions

1. When using Convection Bake, decrease your normal cooking times as shown on page 37. Adjust the cook time for desired doneness as needed. Time reductions will vary depending on the amount and type of food to be cooked. Cookies and biscuits should be baked on pans with no sides or very low sides to allow heated air to circulate around the food. Food baked on pans with a dark finish will cook faster.
2. Preheating is not necessary when cooking casseroles with Convection Bake.
3. When using Convection Bake with a single rack, place oven rack in position 3 or 4. If cooking on multiple racks, place the oven racks in positions 1, 3 and 5 (for 3 racks) and positions 2 and 4 (for 2 racks; See Fig. 2).
4. **Layer cakes** will have better results when baked with the normal Bake feature.

INSTRUCTIONS

To set the oven for Convection Bake and temperature to 350°F:

1. Arrange interior oven racks and place food in oven.
2. Press . "**CONV BAKE**" will flash and "- - °" will appear in the display (Fig. 3).
3. Press   . "**CONV BAKE**" and "**350°**" will appear in the display.
4. Press . "**CONV BAKE**", "**PRE**" and the fan icon will appear in the display (See Fig. 5) until the oven reaches 350°F. A beep will sound once the oven temperature reaches 350°F and the display will then show "**350°**", "**CONV BAKE**" and the fan icon (See Fig. 6).

Note: The convection fan will come on AS SOON AS the oven has been set for Convection Bake. The oven icon display shows a rotating fan. This rotating fan icon indicates when the Convection Fan is operating (See Fig. 6).

Press  to stop Convection Bake or cancel Convection Bake at any time.

PRESS

DISPLAY



Figure 3



Figure 4



Figure 5

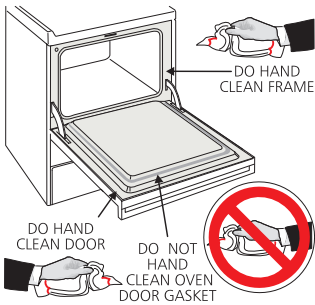

Figure 6



Self-Cleaning

Clean



CAUTION The health of some birds is extremely sensitive to the fumes given off during the self-cleaning cycle of any range. Move birds to another well-ventilated room.

Preparing for the Self-Clean Cycle

A self-cleaning oven cleans itself with high temperatures which eliminate soil completely or reduce it to a fine powdered ash you can wipe away with a damp cloth. These temperatures are well above normal cooking temperatures.

1. Adhere to the following cleaning precautions:
 - Allow the oven to cool before pre-cleaning.
 - Wear rubber gloves when cleaning and while wiping up the residue after the self-clean cycle.
 - **DO NOT** use oven cleaners or oven protective coatings in or around any part of the self-cleaning oven.
 - **DO NOT** clean the oven door gasket. The woven material of the oven door gasket is essential for a good seal. Care should be taken not to rub, damage or remove the gasket.
 - **DO NOT** use any cleaning materials on the oven door gasket. Doing so could cause damage.

2. **Remove the Searing Grill, Broiler Pan and Broiler Pan Insert, all utensils and any aluminum foil. These items cannot withstand high cleaning temperatures.**

CAUTION **DO NOT** line the oven walls, racks, bottom or any other part of the range with aluminum foil. Doing so will destroy heat distribution, produce poor baking results and cause permanent damage to the oven interior (aluminum foil will melt to the interior surface of the oven).

3. Oven racks should be removed, or else their finish will dull and their color turn slightly blue. If they do go through the self-clean cycle, wait until the oven has cooled, then remove the racks and rub their sides with wax paper or a cloth containing a small amount of baby or salad oil (this will make the racks glide easier back into their positions).
4. Remove any excess spill-overs in the oven cavity before starting the self-cleaning cycle. To clean, use hot, soapy water and a cloth. Large spill-overs can cause heavy smoke or fire when subjected to high temperatures. **DO NOT** allow food spills with a high sugar or acid content (such as milk, tomatoes, sauerkraut, fruit juices or pie filling) to remain on the surface as they may cause a dull spot even after cleaning.
5. Clean any soil from the oven frame, the door liner outside the oven door gasket, and the small area at the front center of the oven bottom. These areas heat sufficiently to burn soil on. Clean with soap and water.

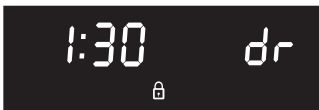
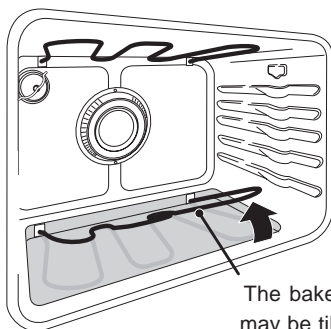

Figure 1

If at any time when setting the oven for the Self-Cleaning feature, the oven control continuously beeps and the display shows "dr"; close the oven door (See Figure 1).



The bake element may be tilted about 4 or 5 inches to clean oven bottom

Figure 2

NOTE: Prior to setting the Self-Clean cycle, any spills remaining on the oven bottom should be removed.

The bake element is designed to be tilted up using your hand from the front of the bake element (See Fig. 2). This will allow easier access to the oven bottom for cleaning. Be careful not to raise the element more than 4 or 5 inches from the resting position.



Self-Cleaning

To Start Self-Clean Cycle

The **CLEAN**  pad controls the Self-Cleaning feature. If you are planning to use the oven directly after a self-clean cycle remember to allow time for the oven to cool down and the oven door to unlock. This normally takes about one hour. So to self-clean for 3 hours will actually take about 4 hours to complete.





*It is recommend to use a 2 hour self-clean cycle for **light soils**, a 3 hour cycle for **average soils**, and a 4 hour cycle for **heavy soils** (to assure satisfactory results).

⚠ WARNING During the self-cleaning cycle, the outside of the range can become very hot to the touch. **DO NOT** leave small children unattended near the appliance; they may be burned if they touch the hot oven door surfaces.

⚠ CAUTION **DO NOT** force the oven door open. This can damage the automatic door locking system. Use care when opening the oven door after the self-cleaning cycle. Stand to the side of the oven when opening the door to allow hot air or steam to escape. The oven may still be **VERY HOT**.

INSTRUCTIONS

To set the controls for a 3 hour Self-Cleaning cycle to start immediately and shut off automatically:

1. Be sure the clock is set with the correct time of day and the oven door is closed.
2. Press . "CLEAN" will flash and "3:00" will show in the display (Fig. 1). The control will automatically clean for a 3 hour period (default self-cleaning cycle time). Note: If a 2 or 4 hour clean time is desired, press  for 2 hour or press  for a 4 hour clean time. Set the cleaning time based on the amount of soil you have; light, medium or heavy (*See above).
3. Press . The "DOOR LOCKED" icon will flash; "CLEAN" icon and the letters "CLn" will remain on in the display (Fig. 2).
4. As soon as the control is set, the motor driven oven door lock will begin to close automatically. Once the door has been locked the "DOOR LOCKED" indicator light will stop flashing and remain on. Also, the oven icon will appear in the display (Fig. 3).

Note: Allow about 15 seconds for the oven door lock to close.

When the Self-Clean Cycle has completed:

1. The time of day, the "DOOR LOCKED" and "CLEAN" icon will remain in the display (Fig. 4).
2. Once the oven has cooled down for approximately 1 HOUR, and the "DOOR LOCKED" icon is no longer displayed, the oven door can then be opened (Fig. 5).

Stopping or Interrupting a Self-Cleaning Cycle:

If it becomes necessary to stop or interrupt a self-cleaning cycle due to excessive smoke or fire in the oven:

1. Press .
2. Once the oven has cooled down for approximately 1 HOUR and the "DOOR LOCKED" icon is no longer displayed, the oven door can then be opened (Fig. 5).

PRESS

DISPLAY



Figure 1

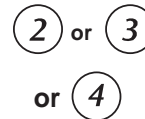

Figure 2



Figure 3



Figure 4





Figure 5



Self-Cleaning

Clean

To Start Delayed Self-Clean Cycle









The **CLEAN** , **STOP TIME**  pads and length of clean cycle, controls the Delayed Self-Clean operation. The automatic timer will turn the oven **on and off** at the time you select in advance. Be sure to review TO START THE SELF-CLEAN CYCLE for recommended clean times.

WARNING During the self-cleaning cycle, the outside of the range can become very hot to the touch. **DO NOT** leave small children unattended near the appliance.

CAUTION **DO NOT** force the oven door open. This can damage the automatic door locking system. Use care when opening the oven door after the self-cleaning cycle. Stand to the side of the oven when opening the door to allow hot air or steam to escape. The oven may still be VERY HOT.

INSTRUCTIONS

To set the control for the Self-Cleaning Cycle to start at a delayed time and shut off automatically: (example 3 hour self-clean cycle to finish at 9:00):

1. Be sure the clock is set with the correct time of day and the oven door is closed.
2. Press . "CLEAN" will flash and "3:00" will show in the display (Fig. 1). The control will automatically clean for a 3 hour period (default self-cleaning cycle time). Note: If a 2 or 4 hour clean time is desired, press  for 2 hour or press  for a 4 hour clean time. Set the cleaning time based on the amount of soil you have; light, medium or heavy (*See page 28).
3. Press . The "DOOR LOCKED" icon will flash; "CLEAN" icon and the letters "CLn" will remain on in the display (Fig. 2).
4. Press  (Fig. 3). Enter the desired stop time using the number pads    (Fig. 4).
5. Press . The "CLn" icon will turn off; "DELAY", "DOOR LOCKED" and "CLEAN" icons will remain on.
6. As soon as the control is set, the motor driven oven door lock will begin to close automatically and once the door has been locked the "DOOR LOCKED" indicator light will quit flashing and remain on. The oven icon will appear in the display (Fig. 5).
7. The control will calculate backward from the set stop time to determine when the self-cleaning cycle should begin. The self-cleaning cycle will come on automatically at the calculated time. At that time, the icon "DELAY" will go out; "CLEAN" and "CLn" will appear in the display (Fig. 6).

When the Self-Clean Cycle has completed:

1. The time of day, the "DOOR LOCKED" and "CLEAN" icon will remain in the display (Fig. 7).
2. Once the oven has cooled down for approximately 1 HOUR, and the icon "DOOR LOCKED" icon is no longer displayed, the oven door can then be opened (Fig. 8).

PRESS

DISPLAY



Figure 1



Figure 2



Figure 3



Figure 4

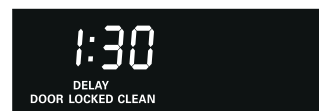

Figure 5



Figure 6



Figure 7



Figure 8





Self-Cleaning

To Start Delayed Self-Clean Cycle (cont'd)

INSTRUCTIONS

PRESS

DISPLAY

Stopping or Interrupting a Self-Cleaning Cycle

If it becomes necessary to stop or interrupt a self-cleaning cycle due to excessive smoke or fire in the oven:

1. Press .
2. Once the oven has cooled down for approximately 1 HOUR and the "DOOR LOCKED" icon is no longer displayed, the oven door can then be opened (Fig. 2-1).



Figure 2-1

Adjusting Oven Temperature

The temperature in the oven has been pre-set at the factory. When first using the oven, be sure to follow recipe times and temperatures. If you think the oven is too hot or too cool, the temperature in the oven can be adjusted. Before adjusting, test a recipe by using a temperature setting that is higher or lower than the recommended temperature. The baking results should help you to decide how much of an adjustment is needed.

Note: The oven temperature adjustments made with this feature will not change the Self-Clean cycle temperature.

INSTRUCTIONS

PRESS

DISPLAY

To adjust the oven temperature higher:





1. Press  for 6 seconds (Fig. 1).
2. To increase the temperature use the number pads to enter the desired change. (Example 30°F)   (Fig. 2). The temperature may be increased upwards as much as 35°F.
3. Press  to accept the temperature change and the display will return to the time of day (Fig. 3). Press  to reject the change if necessary.



Figure 1



Figure 2

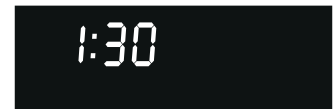

Figure 3

To adjust the oven temperature lower:







1. Press  for 6 seconds (Fig. 4).
2. To decrease the temperature use the number pads to enter the desired change. (Example -30°F)   and then press  (Fig. 5). The temperature may be decreased as much as 35°F.
3. Press  to accept the temperature change and the display will return to the time of day (Fig. 6). Press  to reject the change if necessary.



Figure 4



Figure 5

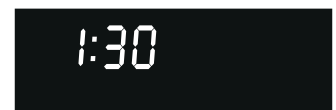

Figure 6

Care & Cleaning

(Cleaning Chart)



Surfaces

How to Clean

Aluminum & Vinyl

Use hot, soapy water and a cloth. Dry with a clean cloth.

Painted and Plastic Control Knobs, Body Parts, and Decorative Trim

For general cleaning, use hot, soapy water and a cloth. *For more difficult soils and built-up grease*, apply a liquid detergent directly onto the soil. Leave on soil for 30 to 60 minutes. Rinse with a damp cloth and dry. **DO NOT** use abrasive cleaners on any of these materials; they can scratch. To remove control knobs, turn to the OFF position; grasp firmly and pull straight off the shaft. To replace knobs after cleaning, line up the flat sides of both the knob and the shaft; then push the knob into place.

Before cleaning the control panel, turn all controls to OFF and remove the control knobs. To remove, pull each knob straight off the shaft. Clean using hot, soapy water and a dishcloth. Rinse with a clean water using a dishcloth. Be sure to squeeze excess water from the cloth before wiping the panel; especially when wiping around the controls. Excess water in or around the controls may cause damage to the appliance. To replace knobs after cleaning, line up the flat sides of both the knob and the shaft; then push the knob into place.

Stainless Steel, Chrome Control Panel, Decorative Trim

Clean **stainless steel** with hot, soapy water and a dishcloth. Rinse with clean water and a cloth. **Do not use cleaners with high concentrations of chlorides or chlorines.** Do not use harsh scrubbing cleaners. Only use kitchen cleaners that are especially made for cleaning stainless steel. Always be sure to rinse the cleaners from the surface as bluish stains may occur during heating that cannot be removed.

Porcelain Enamel Broiler Pan and Insert, Door Liner, Body Parts, Warming Drawer

Gentle scouring with a soapy scouring pad will remove most spots. Rinse with a 1:1 solution of clear water and ammonia. *If necessary*, cover difficult spots with an ammonia-soaked paper towel for 30 to 40 minutes. Rinse with clean water and a damp cloth, and then scrub with a soap-filled scouring pad. Rinse and wipe dry with a clean cloth. Remove all cleaners or the porcelain may become damaged during future heating. **DO NOT** use spray oven cleaners on the cooktop.

Oven Racks

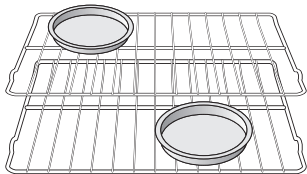

Oven racks should be removed from the oven during the self-clean cycle for cleaning. When removed, clean by using a mild, abrasive cleaner following manufacturer's instructions. Rinse with clean water and dry.

If the racks are cleaned in the self-clean cycle, their color will turn slightly blue and the finish will be dull. After the self-clean cycle is complete, and the oven has cooled, rub the sides of the racks with wax paper or a cloth containing a small amount of baby oil or salad oil (this will make the racks glide easier into the rack positions).

Oven Door



To clean oven door, wash with hot, soapy water and a clean cloth. **DO NOT** immerse the door in water.

DO NOT clean the oven door gasket. The oven door gasket is made of a woven material, on self cleaning models, which is essential for a good seal. Care should be taken not to rub, damage or remove the gasket.



Care & Cleaning

Cooktop Cleaning and Maintenance

Consistent and proper cleaning is essential to maintaining your ceramic glass cooktop.

Prior to using your cooktop for the first time, apply some of the cooktop cleaning cream supplied with your new range. Buff with a non-abrasive cloth or pad (such as a 3M Scotch-Brite® Blue Multi-Purpose *No Scratch* Scrub Sponge). This will make cleaning easier when soiled from cooking. The special cooktop cleaning cream leaves a protective finish on the glass to help prevent scratches and abrasions.

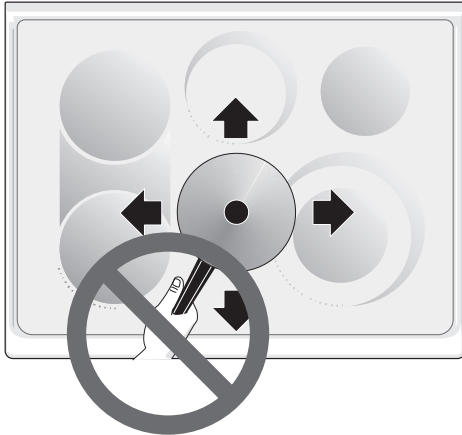

Sliding aluminum or copper clad bottom pans on the cooktop can cause metal markings on the cooktop surface. These marks should be removed **immediately** after the cooktop has cooled using the cooktop cleaning cream. Metal marks can become permanent if not removed prior to future use.

Cookware (cast iron, metal, ceramic or glass) with rough bottoms can mark or scratch the cooktop surface. **Do not slide anything metal or glass** across the cooktop. **Do not** use your cooktop as a cutting board or work surface in the kitchen. **Do not** cook foods directly on the cooktop surface without a pan. **Do not** drop heavy or hard objects on the glass cooktop, they may cause it to crack.

Cleaning Recommendations for the Ceramic Glass Cooktop

CAUTION Before cleaning the cooktop, be sure the controls are turned to **OFF** and the cooktop is **COOL**.

WARNING **DO NOT** use a cooktop cleaner on a hot cooktop. The fumes can be hazardous to your health, and can chemically damage the ceramic-glass surface.

For light to moderate soil:

Apply a few drops of the cooktop cleaning cream (**cleaner must be recommended for Ceramic cooktops**) directly to the cooktop. Use a paper towel or a 3M Scotch-Brite® Blue Multi-Purpose *No Scratch* Scrub Sponge to clean the entire cooktop surface. Make sure the cooktop is cleaned thoroughly, leaving no residue.

For heavy, burned on soil:

Apply a few drops of the cooktop cleaning cream (**cleaner must be recommended for Ceramic cooktops**) directly to the soiled area. Rub the soiled area using a 3M Scotch-Brite® Blue Multi-Purpose *No Scratch* Scrub Sponge, applying pressure as needed. Once the sponge has been used on the cooktop, do not use the sponge for any other purpose.

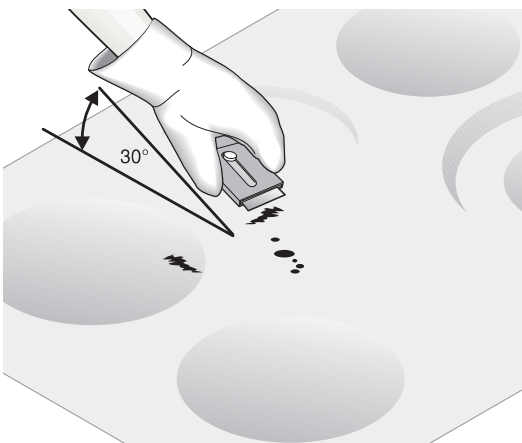

If soils remain, carefully scrape soils with a metal razor blade scraper, holding scraper at a 30 degree angle to the surface. Remove loosened soils with cooktop cleaner and buff surface clean.

Plastic or foods with a high sugar content:

These types of soils need be removed immediately if spilled or melted onto the ceramic cooktop surface. Permanent damage (such as pitting of the cooktop surface) may occur if not removed **immediately**. After turning the surface elements **OFF**, use a razor blade scraper or a metal spatula with a mitt and scrape the soil from the hot surface (as illustrated). Allow the cooktop to cool, and use the same method for heavy or burned on soils.

Care & Cleaning



Cleaning Recommendations for the Ceramic Glass Cooktop (cont'd)

Do not use the following on the ceramic glass cooktop:



- Do not use abrasive cleaners and scouring pads, such as metal and some nylon pads. They may scratch the cooktop, making it more difficult to clean.
- Do not use harsh cleaners, such as chlorine bleach, ammonia or oven cleaners, as they may etch or discolor the cooktop.
- Do not use dirty sponges, cloths or paper towels, as they can leave soil or lint on the cooktop which can burn and cause discoloration.

Note: Additional cooktop cleaning cream may be ordered by visiting the Frigidaire website at www.frigidaire.com

Removing and Replacing the Oven Door (all models)

CAUTION The door is heavy. For safe, temporary storage, lay the door flat with the inside of the door facing down.

To Remove Oven Door:

1. Open oven door completely (horizontal with floor - See Fig. 1).
2. Remove 2 screws located on the inside of the oven door liner (See **A** Fig. 2)
3. Insert the 2 screws into the door hinge holes located on the side of the hinge arm, one into each hinge (See **B** Fig. 2).
4. Close oven door until the door stops, (Do not force the door to close any further). The placement of these screws should keep door open in about a 45 degree position.
5. Grasp oven door firmly on both sides and slide door up and off hinges at the same angle. (See Fig. 3)
6. To clean oven door, follow the instructions provided in the Cleaning Chart at the beginning of the **Care & Cleaning** section (See Door Liner).

To Replace Oven Door:

1. Be sure the hinge arms remain at the 45 degree angle position. Be sure the screws are still locking the hinge arms from moving. If the screws fall out of the hinge holes, the hinge(s) may snap back against the oven frame and could pinch fingers or chip the porcelain finish on the oven front frame.
2. Hold door at the sides near the top while resting the lower front of door on your knee. Insert the door channels at the bottom of door over the door hinges, (See Fig. 3).
3. Allow the door to slide down into the door hinges evenly at the same 45 degree angle. The hinge arms should be inserted into the bottom corners as far as they can go.
4. Open door completely (horizontal with floor) and remove both screws from holes in door hinges.
5. Reinstall the 2 screws into the door liner (See **C** Fig. 2).
6. If the door is not in alignment with the oven frame, remove door and repeat the above steps.

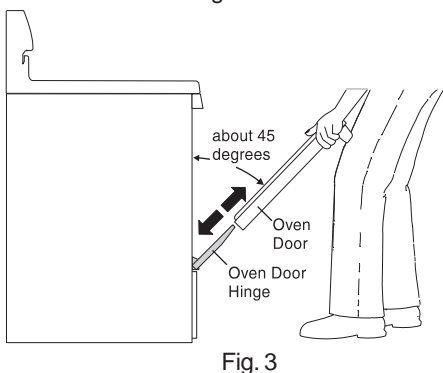
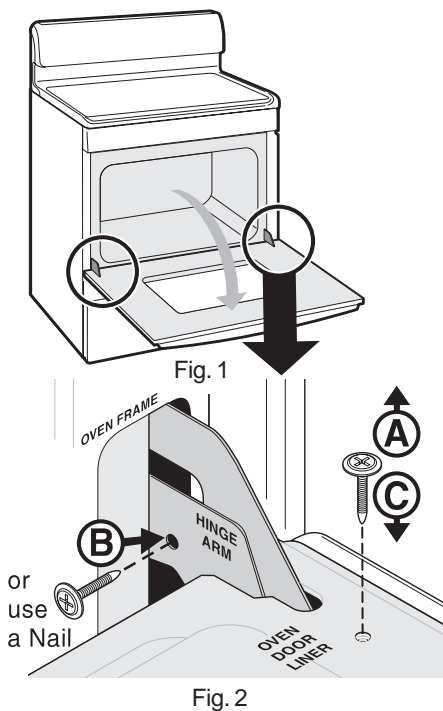



Care & Cleaning

Removing and Replacing the Warming Drawer (some models)

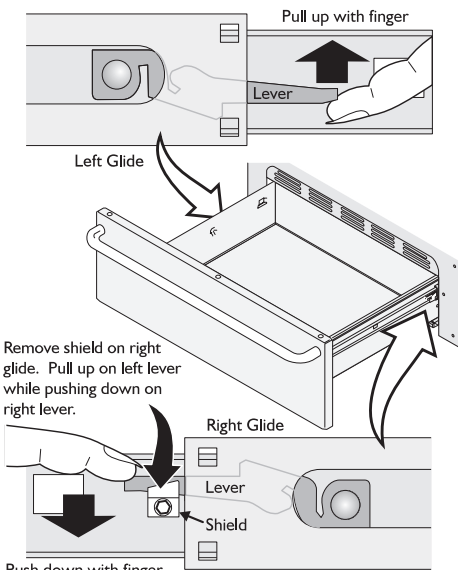

Figure 1

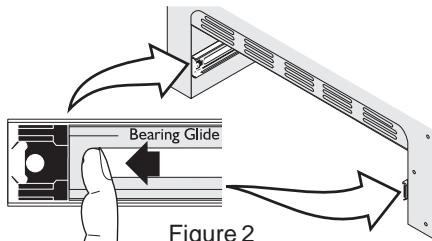

Figure 2

To Remove Warming Drawer:

1. **CAUTION** Turn power off before removing the Warming Drawer.
2. Open the drawer to the fully opened position.
3. On the right glide you will find a shield attached with a hex-head screw (See Figure 1). Using a 1/4" socket and ratchet remove the shield.
4. Locate glide lever on each side of drawer, pull up on the left glide lever and push down on the right glide lever.
5. Pull the drawer away from the range.

To Replace Warming Drawer:

1. Replace shield on the right glide of the drawer body.
2. **Pull the bearing glides to the front** of the chassis glide (See Figure 2).
3. Align the glide on each side of the drawer with the glide slots on the range.
4. Push the drawer into the range until levers "click" (approximately 2"). Pull the drawer open again to seat bearing glides into position. **If you do not hear the levers "click" or the bearing glides do not feel seated remove the drawer and repeat steps 2-4.** This will minimize possible damage to the bearing glides. Using a 1/4" socket and ratchet replace the shield.

NOTE: The Warming Drawer will **NOT** operate while in the "Self-Clean" and "Oven Lockout" modes.



WARNING Electrical Shock Hazard can occur and result in serious injury or death. Disconnect appliance from electric power before cleaning and servicing the Warming Drawer.

Operating and Replacing the Oven Light

CAUTION Be sure the range is unplugged and all parts are COOL before replacing the oven light. Wear a leather-faced glove for protection against possible broken glass.

To operate the Oven Light:

The interior oven light will automatically turn on when the oven door is opened. Press  to turn the light ON and OFF when the oven door is closed. The oven light is located at the rear wall of the oven interior and is covered with a glass shield held by a wire holder (See Fig. 3). The oven light glass shield must be in place whenever the oven is in use.

To Replace the Oven Light:

1. Turn electrical power off at the main source and unplug the range.
2. Press Wire Holder to one side to release the glass shield.
3. Replace the old bulb with a new 40 watt appliance bulb.
4. Replace Glass Shield over bulb and snap Wire Holder into place.
5. Turn power back on again at the main source (or plug in the range).
6. The clock will then need to be reset. To reset, see **Setting the Clock** in this Use & Care Manual.

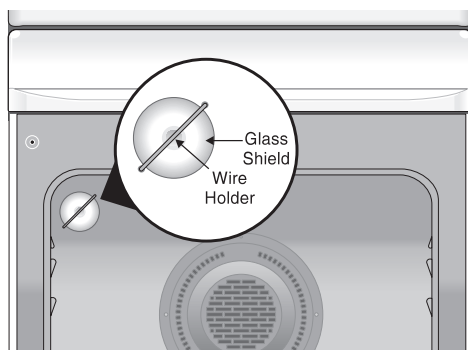

Figure 3

Care & Cleaning of Stainless Steel (Stainless Steel models only)

Some models are equipped with stainless steel exterior parts. Special care and cleaning are **required** for maintaining the appearance of stainless parts. Please refer to the table provided at the beginning of the **Care & Cleaning** section in this Use & Care Manual.

Before You Call

Solutions to Common Problems



Before you call for service, review this list. It may save you time and expense. The list includes common occurrences that are not the result of defective workmanship or materials in this appliance.

OCCURRENCE	POSSIBLE CAUSE/SOLUTION
Range is not level.	<p>Poor installation. Place oven rack in center of oven. Place a level on the oven rack. Adjust leveling legs at base of range until the rack is level. When range is level, cooktop may appear out of alignment if countertop is not level (See the Range Installation Instructions).</p> <p>Weak, unstable floor. Be sure floor is level and can adequately support range. Contact a carpenter to correct sagging or sloping floor.</p> <p>Kitchen cabinet misalignment may make range appear to be unlevel. Be sure cabinets are square and have sufficient room for range clearance.</p>
Cannot move appliance easily. Appliance must be accessible for service.	<p>Cabinets not square or are built in too tight. Contact a cabinet maker to correct the problem.</p> <p>Contact builder or installer to make appliance accessible.</p> <p>Carpeting interferes with range. Provide sufficient space so range can be lifted over carpet.</p>
Surface element too hot or not hot enough.	<p>Incorrect surface control setting. Make sure the correct control is set for the surface area you wish to heat.</p>
Surface element does not heat.	<p>Light-weight or warped cookware was used. Use only flat, evenly balanced, medium or heavy-weight cookware. Flat pans heat much better than warped pans. Cookware materials and weight of the material affect heating results. Heavy and medium-weight pans heat evenly. Because light-weight pans heat unevenly, foods may burn easily.</p>
Oven does not operate.	<p>No electrical power to the appliance. Check steps under Entire Appliance Does Not Operate in this Before You Call checklist.</p> <p>Be sure the oven controls are set correctly for the desired function. See the Setting Oven Controls section or Entire Appliance Does Not Operate in this Before You Call checklist.</p> <p>The clock must be set with the time of day in order to operate the oven.</p>
Entire appliance does not operate.	<p>Make sure electrical cord/plug is plugged tightly into outlet.</p> <p>Service wiring is not complete. Contact a Service for assistance.</p> <p>Electrical power outage. Check house lights to be sure. Call your local electric company for service.</p>
Oven light(s) does not work.	<p>Burned-out or loose bulb. See Operating and Replacing the Oven Lights section in this Use & Care Manual to replace or tighten the bulb(s).</p> <p>Electrical power outage. Check house lights to be sure. Call your local electric company for service.</p>
Oven smokes excessively during broiling.	<p>Meat is too close to the broil element. Reposition the rack to provide more clearance between the meat and the oven broil element.</p> <p>Meat is not properly prepared. Remove excess fat from meat. Remove remaining fatty edges to prevent the meat from curling, but do not cut into the lean of the meat.</p> <p>Broiler Pan used without the Broiler Pan Insert or insert is covered with foil. DO NOT use the Broiler Pan without the Broiler Pan Insert or cover the insert with foil.</p> <p>Broiler Pan/Insert or grease build-up underneath the 6th rack position. Clean grease from below the 6th rack position. Excessive smoking is caused by a build-up of grease or food spatters. If the Broiler Pan/Insert is used often, clean them on a regular basis.</p>





Before You Call

Solutions to Common Problems (cont'd)

OCCURRENCE	POSSIBLE CAUSE/SOLUTION
ESEC displays “ - - “ message.	The ESEC Control will display “ - - “ in the digital display windows indicating that the ESEC has a “Lockout” condition. This condition is normal when using the oven lockout or self-clean features. Wait for the Self-Clean cycle to completely finish or if using the Oven Lockout feature, press the Lock control pad to unlock the oven door.
Oven electronic control beeps and displays “F1, F2, F3, or F9.”	<p>This oven is equipped with a state of the art electronic oven controller. Among the many features is a full time oven circuit diagnostics system. The controller constantly monitors the internal circuitry as well as several crucial oven circuits to insure they are all operating correctly. If at any time one of these systems fails, the controller will immediately stop the current operation and beep continuously (flashing an error code of “F1, F2, F3, or F9” in the controller display window.</p> <p>Electronic control has detected a fault condition. Press CLEAR/OFF to clear the display and stop the beeping. Reprogram oven. If fault remains, record fault number. Press CLEAR/OFF and contact a Service.</p>
ESEC displays “Er” message.	ESEC control has detected a fault condition. Turn all surface control knobs to OFF and reset the clock with the correct time of day if necessary. If the “Er” message remains, contact a Service .
ESEC displays “F5, F6 or F7” message.	The ESEC control constantly monitors the internal circuitry as well as several circuits to insure they are all operating correctly. If at any time one of these systems fails, the ESEC will immediately stop the current operation and flash an error code of “F5, F6, or F7” in the digital display window. If any of these error messages remain or reappear in the display, contact a Service .
Oven control beeps when you try to enter times or temperatures	The oven control will only accept correct responses and/or the minimum number of allowable entries for the appropriate feature. The oven control is designed to prevent accidental entries. Review the instructions in this Use & Care Manual for the feature you are trying to use. Also review the minimum and maximum temperature entries for the feature you are trying to set on page 15 in this Use & Care Manual.
Poor baking results.	Many factors affect baking results. Make sure the proper rack position is being used. Center food in the oven and space pans to allow air to circulate. Allow the oven to preheat to the set temperature before placing food in the oven. Try adjusting the recipe's recommended temperature or baking time. If you feel the oven is cooking too hot or cool, see Adjusting the Oven Temperature in this Use & Care Manual.
Self-Cleaning cycle does not work.	<p>Controls are not set properly. Follow instructions in the Self-Cleaning section.</p> <p>The Self-Clean feature will not operate whenever a radiant surface element is on.</p> <p>Self-cleaning cycle was interrupted. Stop time must be set for 2, 3, or 4 hours past the start time. Follow steps shown in Stopping or Interrupting a Self-Clean Cycle in the Self-Cleaning section.</p>
Soil is not completely removed.	<p>Failure to clean bottom front, top of oven or door areas outside oven seal. These areas are not in the Self-Cleaning area, but get hot enough to burn on food residue. Clean these areas before starting the self-clean cycle. Burned-on residue may be cleaned with a stiff nylon brush and water or a nylon scrubber. Be careful not to damage the oven gasket.</p> <p>Excessive spill-overs in oven. Set Self-Clean cycle for a longer Self-Cleaning time.</p>
Flames inside oven or smoking from vent.	Excessive spill-overs in oven. This is normal, especially for pie spill-overs or large amounts of grease on the oven bottom. Wipe up excessive spill-overs before starting the self-clean cycle. If flames or excessive smoke are present, stop the Self-Clean cycle and follow the steps shown in Stopping or Interrupting the Self-Clean Cycle in the Self-Cleaning section.

Cooking Tables

Foods for  CONVECTION BAKE pad *Decrease normal cook time by:	
Frozen foods, pies, pastries and pizza	15-25 %
Refrigerator cookies	15-35 %
Refrigerator biscuits	15-30 %
Rolls & Breads	20-25%
Fresh Pies/Pastries	10-20 %
Begin with the maximum reduction in cook times and adjust as needed.	
*Recommended reduction in cook times based on brands of food items tested. Cook times may vary with your specific brand of food item.	

Foods for  CONVECTION ROAST pad *Decrease normal cook time by:	
Meats	15-30 %
Poultry (unstuffed)	20-30 %
Begin with the maximum reduction in cook times and adjust as needed.	
*Recommended reduction in cook times based on brands of food items tested. Cook times may vary with your specific brand of food item.	

Notes

Notes



RANGE WARRANTY

Your range is protected by this warranty

	WARRANTY PERIOD	THROUGH OUR AUTHORIZED SERVICERS, WE WILL:	THE CONSUMER WILL BE RESPONSIBLE FOR:
FULL ONE-YEAR WARRANTY	One year from original purchase date.	Pay all costs for repairing or replacing any parts of this appliance which prove to be defective in materials or workmanship.	Costs of service calls that are listed under NORMAL RESPONSIBILITIES OF THE CONSUMER.*
LIMITED 2ND-5TH YEAR WARRANTY (Glass Smoothtop, Seal & Elements)	Second through fifth years from original purchase date.	Provide a replacement for any defective surface heating element, deteriorated rubberized-silicone seal (upswept models only), or glass smoothtop that cracks due to thermal breakage (not customer abuse).	Diagnostic costs and any transportation and labor costs which are required because of service.
LIMITED WARRANTY (Applicable to the State of Alaska)	Time periods listed above.	All of the provisions of the full and limited warranties above and the exclusions listed below apply.	Costs of the technician's travel to the home and any costs for pick up and delivery of the appliance required because of service.

In the U.S.A., your appliance is warranted by Electrolux Home Products North America, a division of White Consolidated Industries, Inc. We authorize no person to change or add to any of our obligations under this warranty. Our obligations for service and parts under this warranty must be performed by us or an authorized Electrolux Home Products North America servicer. In Canada, your appliance is warranted by WCI Canada, Inc.

*NORMAL RESPONSIBILITIES OF THE CONSUMER

This warranty applies only to products in ordinary household use, and the consumer is responsible for the items listed below:

1. Proper use of the appliance in accordance with instructions provided with the product.
2. Proper installation by an authorized servicer in accordance with instructions provided with the appliance and in accordance with all local plumbing, electrical and/or gas codes.
3. Proper connection to a grounded power supply of sufficient voltage, replacement of blown fuses, repair of loose connections or defects in house wiring.
4. Expenses for making the appliance accessible for servicing, such as removal of trim, cupboards, shelves, etc., which are not a part of the appliance when it was shipped from the factory.
5. Damages to finish after installation.
6. Replacement of light bulbs and/or fluorescent tubes (on models with these features).

EXCLUSIONS

This warranty does not cover the following:

1. CONSEQUENTIAL OR INCIDENTAL DAMAGES SUCH AS PROPERTY DAMAGE AND INCIDENTAL EXPENSES RESULTING FROM ANY BREACH OF THIS WRITTEN OR ANY IMPLIED WARRANTY.
NOTE: Some states do not allow the exclusion or limitation of incidental or consequential damages, so this limitation or exclusion may not apply to you.
2. Service calls which do not involve malfunction or defects in workmanship or material, or for appliances not in ordinary household use. The consumer shall pay for such service calls.
3. Damages caused by services performed by servicers other than Electrolux Home Products North America or its authorized servicers; use of parts other than genuine Electrolux Home Products parts; obtained from persons other than such servicers; or external causes such as abuse, misuse, inadequate power supply or acts of God.
4. Products with original serial numbers that have been removed or altered and cannot be readily determined.

IF YOU NEED SERVICE

Keep your bill of sale, delivery slip, or some other appropriate payment record. The date on the bill establishes the warranty period should service be required. If service is performed, it is in your best interest to obtain and keep all receipts. This written warranty gives you specific legal rights. You may also have other rights that vary from state to state. Service under this warranty must be obtained by contacting Electrolux Home Products:

This warranty only applies in the 50 states of the U.S.A., Puerto Rico, and Canada. Product features or specifications as described or illustrated are subject to change without notice. All warranties are made by Electrolux Home Products North America, a division of White Consolidated Industries, Inc. In Canada, your appliance is warranted by WCI Canada, Inc.

03-U-RA-01 (rev. 01/2001)

USA
800•944•9044
 Electrolux Home Products North America
 P.O. Box 212378
 Augusta, GA 30917

Canada
866•213•9397 (English)
866•294•9911 (French)
 Electrolux Home Products North America
 6150 McLaughlin Road
 Mississauga, Ontario, Canada
 L5R 4C2

Free Manuals Download Website

<http://myh66.com>

<http://usermanuals.us>

<http://www.somanuals.com>

<http://www.4manuals.cc>

<http://www.manual-lib.com>

<http://www.404manual.com>

<http://www.luxmanual.com>

<http://aubethermostatmanual.com>

Golf course search by state

<http://golfingnear.com>

Email search by domain

<http://emailbydomain.com>

Auto manuals search

<http://auto.somanuals.com>

TV manuals search

<http://tv.somanuals.com>