

**OPERATOR'S MANUAL
FRYMASTER BIGLA30 SERIES GEN II LOV™
GAS FRYER**



This equipment chapter is to be installed in the Fryer Section of the *Equipment Manual*.

FOR YOUR SAFETY
Do Not Store or use gasoline or other flammable vapors and liquids in the vicinity of this or any other appliance.



MANUFACTURED
BY



**8700 Line Avenue
SHREVEPORT, LOUISIANA 71106
PHONE: 1-318-865-1711
TOLL FREE: 1-800-551-8633
1-800-24 FRYER
FAX: 1-318-219-7135**



TABLE OF CONTENTS

WARRANTY STATEMENT.....	Page i
INTRODUCTION.....	Page 1-1
INSTALLATION INSTRUCTIONS	Page 2-1
OPERATING INSTRUCTIONS.....	Page 3-1
M3000 COMPUTER INSTRUCTIONS	Page 4-1
OPERATING THE BUILT-IN FILTRATION SYSTEM.....	Page 5-1
PREVENTIVE MAINTENANCE	Page 6-1
OPERATOR TROUBLESHOOTING.....	Page 7-1

Frymaster L.L.C., 8700 Line Avenue, Shreveport, LA 71106
PHONE 318-865-1711 FAX 318-219-7135

PRINTED IN THE UNITED STATES

SERVICE HOTLINE 1-800-24-FRYER

FEBRUARY 2010

www.frymaster.com

Email: service@frymaster.com

* 8196286 *

NOTICE

IF, DURING THE WARRANTY PERIOD, THE CUSTOMER USES A PART FOR THIS MANITOWOC EQUIPMENT OTHER THAN AN **UNMODIFIED** NEW OR RECYCLED PART PURCHASED DIRECTLY FROM FRYMASTER DEAN, OR ANY OF ITS AUTHORIZED SERVICE CENTERS, AND/OR THE PART BEING USED IS MODIFIED FROM ITS ORIGINAL CONFIGURATION, THIS WARRANTY WILL BE VOID. FURTHER, FRYMASTER DEAN AND ITS AFFILIATES WILL NOT BE LIABLE FOR ANY CLAIMS, DAMAGES OR EXPENSES INCURRED BY THE CUSTOMER WHICH ARISE DIRECTLY OR INDIRECTLY, IN WHOLE OR IN PART, DUE TO THE INSTALLATION OF ANY MODIFIED PART AND/OR PART RECEIVED FROM AN UNAUTHORIZED SERVICE CENTER.

NOTICE

This appliance is intended for professional use only and is to be operated by qualified personnel only. A Frymaster DEAN Factory Authorized Service Agency (ASA) or other qualified professional should perform installation, maintenance, and repairs. Installation, maintenance, or repairs by unqualified personnel may void the manufacturer's warranty. See Chapter 1 of this manual for definitions of qualified personnel.

NOTICE

This equipment must be installed in accordance with the appropriate national and local codes of the country and/or region in which the appliance is installed. See **NATIONAL CODE REQUIREMENTS** in Chapter 2 of this manual for specifics.

NOTICE TO U.S. CUSTOMERS

This equipment is to be installed in compliance with the basic plumbing code of the Building Officials and Code Administrators International, Inc. (BOCA) and the Food Service Sanitation Manual of the U.S. Food and Drug Administration.

NOTICE

Drawings and photos used in this manual are intended to illustrate operational, cleaning and technical procedures and may not conform to onsite management operational procedures.

NOTICE TO OWNERS OF UNITS EQUIPPED WITH COMPUTERS

U.S.

This device complies with Part 15 of the FCC rules. Operation is subject to the following two conditions: 1) This device may not cause harmful interference, and 2) This device must accept any interference received, including interference that may cause undesired operation. While this device is a verified Class A device, it has been shown to meet the Class B limits.

CANADA

This digital apparatus does not exceed the Class A or B limits for radio noise emissions as set out by the ICES-003 standard of the Canadian Department of Communications.

Cet appareil numerique n'emmet pas de bruits radioelectriques depassany les limites de classe A et B prescrites dans la norme NMB-003 edictee par le Ministre des Communcations du Canada.

 **DANGER**

Improper installation, adjustment, maintenance or service, and unauthorized alterations or modifications can cause property damage, injury, or death. Read the installation, operating, and service instructions thoroughly before installing or servicing this equipment. Only qualified service personnel may convert this appliance to use a gas other than that for which it was originally configured.

 **DANGER**

No structural material on the fryer should be altered or removed to accommodate placement of the fryer under a hood. Questions? Call the Frymaster Dean Service Hotline at 1-800-551-8633.

⚠ DANGER

Adequate means must be provided to limit the movement of this appliance without depending upon the gas line connection. All fryers equipped with casters must be stabilized by installing restraining chains. If a flexible gas line is used, an additional restraining cable must be connected at all times when the fryer is in use.

⚠ DANGER

The front ledge of the fryer is not a step! Do not stand on the fryer. Serious injury can result from slips or contact with the hot oil.

⚠ DANGER

Do not store or use gasoline or other flammable liquids or vapors in the vicinity of this or any other appliance.

⚠ DANGER

Instructions to be followed in the event the operator smells gas or otherwise detects a gas leak must be posted in a prominent location. This information can be obtained from the local gas company or gas supplier.

⚠ DANGER

This product contains chemicals known to the state of California to cause cancer and/or birth defects or other reproductive harm.

Operation, installation, and servicing of this product could expose you to airborne particles of glasswool or ceramic fibers, crystalline silica, and/or carbon monoxide. Inhalation of airborne particles of glasswool or ceramic fibers is known to the State of California to cause cancer. Inhalation of carbon monoxide is known to the State of California to cause birth defects or other reproductive harm.

⚠ DANGER

The crumb tray in fryers equipped with a filter system must be emptied into a fireproof container at the end of frying operations each day. Some food particles can spontaneously combust if left soaking in certain shortening material.

⚠ WARNING

Do not bang fry baskets or other utensils on the fryer's joiner strip. The strip is present to seal the joint between the fry vessels. Banging fry baskets on the strip to dislodge shortening will distort the strip, adversely affecting its fit. It is designed for a tight fit and should only be removed for cleaning.

⚠ WARNING

To ensure the safe and efficient operation of the fryer and hood, the electrical plug for the 120-volt line, which powers the hood, must be fully engaged and locked in its pin and sleeve socket.

NOTICE

The Commonwealth of Massachusetts requires any and all gas products to be installed by a licensed plumber or pipe fitter.

NOTICE

The instructions in this manual for using a bulk oil system for filling and discarding oil are for an RTI system. These instructions may not be applicable to other bulk oil systems.

LOV™ GAS WARRANTY STATEMENT

Frymaster, L.L.C. makes the following limited warranties to the original purchaser only for this equipment and replacement parts:

A. WARRANTY PROVISIONS - FRYERS

1. Frymaster L.L.C. warrants all components against defects in material and workmanship for a period of two years.
2. All parts, with the exception of the frypot, O-rings and fuses, are warranted for two years after installation date of fryer.
3. If any parts, except fuses and filter O-rings, become defective during the first year after installation date, Frymaster will also pay straight-time labor costs up to two hours to replace the part, plus up to 100 miles/160 km of travel (50 miles/80 km each way).

B. WARRANTY PROVISIONS - FRYPOTS

1. Frymaster warrants the frypot assembly for fifteen (15) years. First ten (10) years parts and labor. Years eleven (11) through fifteen (15) frypot only. Components attached to the frypot, such as the high-limit, probe, gaskets, seals, ignitors and related fasteners, are also covered by the fifteen year warranty if replacement is necessitated by the frypot replacement. Components that are not part of the frypot assembly, such as the blower, gas valve, micro switches, doors and cabinetry are not covered by the frypot warranty. Leaks due to abuse or from threaded fittings such as probes, sensors, high-limits, drain valves or return piping are not included. If the frypot is found to be defective, Frymaster will replace the frypot, allowing up to the maximum time per the Frymaster time allowance chart hours of straight-time labor plus up to 100 miles/160 km of travel (50 miles/80 km each way) to change the frypot.
2. This warranty is limited to fryers operating on natural or propane (LP) gas. Fryers that operate on manufactured gas (also known as town gas or high-hydrogen gas) have a lifetime frypot warranty, parts only.

C. WARRANTY PROVISIONS – COMBUSTION CHAMBERS

1. Frymaster L.L.C. warrants the combustion chambers against defective material or workmanship for a period of ten years from the original installation date, parts and labor.
2. The combustion chamber consists of the infrared burners and the structural components to mount the burners. This warranty does not cover ancillary components, including the igniter, blower, high-limit thermostat, and temperature probe.
3. This warranty is limited to fryers operating on natural or propane (LP) gas.

E. PARTS RETURN

All defective in-warranty parts must be returned to a Frymaster Authorized Factory Service Center within 60 days for credit. After 60 days, no credit will be allowed.

F. WARRANTY EXCLUSIONS

This warranty does not cover equipment that has been damaged due to misuse, abuse, alteration, or accident such as:

- improper or unauthorized repair (including any frypot which is welded in the field);
- failure to follow proper installation instructions and/or scheduled maintenance procedures as prescribed in your MRC cards. Proof of scheduled maintenance is required to maintain the warranty;
- improper maintenance;
- damage in shipment;
- abnormal use;
- removal, alteration, or obliteration of either the rating plate or the date code on the heating elements;
- operating the frypot without shortening or other liquid in the frypot;
- no fryer will be warranted under the ten-year program for which a proper start-up form has not been received.

This warranty also does not cover:

- transportation or travel over 100 miles/160 km (50 miles/80 km each way), or travel over two hours;
- overtime or holiday charges;
- consequential damages (the cost of repairing or replacing other property which is damaged), loss of time, profits, use or any other incidental damages of any kind.

There are no implied warranties of merchantability or fitness for any particular use or purpose.

This warranty is applicable at the time of this printing and is subject to change.

BIGLA30 SERIES GEN II LOV™ GAS FRYER

CHAPTER 1: INTRODUCTION

NOTE: The Frymaster BIGLA30 fryer requires a start-up, demonstration and training before normal restaurant operations can begin.

1.1 General

Read the instructions in this manual thoroughly before attempting to operate this equipment. This manual covers all configurations of models and BIGLA30 LOV™ fryers. Models designated BIGLA30 are equipped with Foot-Print Pro built-in filtration systems. The fryers in this model family have most parts in common, and when discussed as a group, will be referred to as “LOV™ fryers.

Although similar in appearance to the BIPH55 McDonald’s fryers, the BIGLA30 LOV™ fryers feature a low oil volume frypot, auto top-off and an automatic intermittent filtration unit. The Euro-Look design incorporates a rounded topcap and a large round drain which ensures that fries and other debris will be washed into the filter pan. The BIGLA30 LOV™ fryers are controlled with an M3000 computer. Fryers in this series come in full- or split-vat arrangements, and can be purchased in batteries of up to five vats.

LOV™ high-efficiency gas fryers employ a unique infrared burner system that uses up to 43% less energy to cook the same volume as conventional open-burner fryers.

LOV™ gas fryers are of an open-frypot design with no tubes, which makes cleaning the stainless frypot quick and easy.

Heating is supplied by a pair of infrared burner assemblies mounted on each side of the frypot. A dedicated blower mounted on the front of the frypot supplies combustion air for the burners. LOV™ Gas fryers can be configured for natural gas, propane (LP), or manufactured gas, as required by the customer.

Each frypot is equipped with a temperature probe for precise temperature control.

All fryers in this series require an external source of AC electrical power. Units can be configured for voltages ranging from 100 VAC to 240 VAC.

BIGLA30 LOV™ fryers are shipped completely assembled. All fryers are shipped with a package of standard accessories. Each fryer is adjusted, tested, and inspected at the factory before crating for shipment.

This appliance is only for professional use and shall be used by qualified personnel only, as defined in Section 1.6.

1.2 Safety Information

Before attempting to operate your unit, read the instructions in this manual thoroughly. Throughout this manual, you will find notations enclosed in double-bordered boxes similar to the ones that follow.

 **CAUTION**

CAUTION boxes contain information about actions or conditions that *may cause or result in a malfunction of your system.*

 **WARNING**

WARNING boxes contain information about actions or conditions that *may cause or result in damage to your system*, and which may cause your system to malfunction.



DANGER

DANGER boxes contain information about actions or conditions that *may cause or result in injury to personnel*, and which may cause damage to your system and/or cause your system to malfunction.

Your fryer is equipped with automatic safety features:

1. High-temperature detection shuts off gas to the burner assembly should the controlling thermostat fail.
2. A safety circuit on units with filter systems prevents burner ignition with the drain valve open.

1.3 Computer Information for the M3000 Computers

FCC COMPLIANCE

This equipment has been tested and found to comply with the limits for a Class A digital device, pursuant to Part 15 of the FCC rules. While this device is a verified Class A device, it has been shown to meet the Class B limits. These limits are designed to provide reasonable protection against harmful interference when the equipment is operated in a commercial environment. This equipment generates, uses and can radiate radio frequency energy and, if not installed and used in accordance with the instruction manual, may cause harmful interference to radio communications.

Operation of the equipment in a residential area is likely to cause harmful interference in which case the user will be required to correct the interference at his own expense.

The user is cautioned that any changes or modifications not expressly approved by the party responsible for compliance could void the user's authority to operate the equipment.

If necessary, the user should consult the dealer or an experienced radio and television technician for additional suggestions.

The user may find the following booklet prepared by the Federal Communications Commission helpful: "How to Identify and Resolve Radio-TV Interference Problems". This booklet is available from the U.S. Government Printing Office, Washington, DC 20402, Stock No. 004-000-00345-4.

1.4 European Community (CE) Specific Information

The European Community (CE) has established certain specific standards regarding equipment of this type. Whenever a conflict exists between CE and non-CE standards, the information or instructions concerned are identified by means of shadowed boxes.

1.5 Installation, Operating, and Service Personnel

Operating information for Frymaster equipment has been prepared for use by qualified and/or authorized personnel only, as defined in Section 1.6. **All installation and service on Frymaster equipment must be performed by qualified, certified, licensed, and/or authorized installation or service personnel, as defined in Section 1.6.**

1.6 Definitions

QUALIFIED AND/OR AUTHORIZED OPERATING PERSONNEL

Qualified/authorized operating personnel are those who have carefully read the information in this manual and have familiarized themselves with the equipment functions, or who have had previous experience with the operation of the equipment covered in this manual.

QUALIFIED INSTALLATION PERSONNEL

Qualified installation personnel are individuals, firms, corporations, and/or companies which, either in person or through a representative, are engaged in and are responsible for the installation of gas-fired appliances. Qualified personnel must be experienced in such work, be familiar with all gas precautions involved, and have complied with all requirements of applicable national and local codes.

QUALIFIED SERVICE PERSONNEL

Qualified service personnel are those who are familiar with Frymaster equipment and who have been authorized by Frymaster, L.L.C. to perform service on the equipment. All authorized service personnel are required to be equipped with a complete set of service and parts manuals, and to stock a minimum amount of parts for Frymaster equipment. A list of Frymaster Authorized Service Agencies (ASA) is included with the fryer when shipped from the factory. *Failure to use qualified service personnel will void the Frymaster warranty on your equipment.*

1.7 Shipping Damage Claim Procedure

Your Frymaster equipment was carefully inspected and packed before leaving the factory. The transportation company assumes full responsibility for safe delivery upon its acceptance of the equipment for transport.

What to do if your equipment arrives damaged:

1. **File a claim for damages immediately**, regardless of the extent of damages.
2. **Inspect for and record all visible loss or damage**, and ensure that this information is noted on the freight bill or express receipt and is signed by the person making the delivery.
3. **Concealed loss or damage** that was unnoticed until the equipment was unpacked should be recorded and reported to the freight company or carrier **immediately** upon discovery. A concealed damage claim must be submitted within 15 days of the date of delivery. Ensure that the shipping container is retained for inspection.

***Frymaster* DOES NOT ASSUME RESPONSIBILITY FOR DAMAGE OR LOSS
INCURRED IN TRANSIT.**

1.8 Parts Ordering and Service Information

For non-routine maintenance or repairs, or for service information, contact your local Frymaster Authorized Service Agency (ASA). In order to assist you quickly, the Frymaster Authorized Service Agency (ASA) or Service Department representative requires certain information about your equipment. Most of this information is printed on a data plate affixed to the inside of the fryer door. Part numbers are found in the Service and Parts Manual. Parts orders may be placed directly with your local ASA or distributor. Included with fryers when shipped from the factory is a list of Frymaster ASAs. If you do not have access to this list, contact the Frymaster Service Department at 1-800-551-8633 or 1-318-865-1711.

When ordering parts, the following information is required:

Model Number: _____
Serial Number: _____
Type of Gas or Voltage: _____
Item Part Number: _____
Quantity Needed: _____

Service information may be obtained by contacting your local ASA/Distributor. Service may also be obtained by calling the Frymaster Service Department at 1-800-551-8633 or 1-318-865-1711 or by email at service@frymaster.com. When requesting service, please have the following information ready:

Model Number: _____
Serial Number: _____
Type of Gas: _____

In addition to the model number, serial number, and type of gas, please be prepared to describe the nature of the problem and have ready any other information that you think may be helpful in solving your problem.

RETAIN AND STORE THIS MANUAL IN A SAFE PLACE FOR FUTURE USE.

BIGLA30 SERIES GEN II LOV™ GAS FRYER

CHAPTER 2: INSTALLATION INSTRUCTIONS

2.1 General Installation Requirements

Proper installation is essential for the safe, efficient, trouble-free operation of this appliance.

Qualified, licensed, and/or authorized installation or service personnel, as defined in Section 1.6 of this manual, should perform all installation and service on Frymaster equipment.

Conversion of this appliance from one type of gas to another should only be performed by qualified, licensed, and/or authorized installation or service personnel as defined in Section 1.6 of this manual.

Failure to use qualified, licensed, and/or authorized installation or service personnel (as defined in Section 1.6 of this manual) to install, convert to another gas type or otherwise service this equipment will void the Frymaster warranty and may result in damage to the equipment or injury to personnel.

Where conflicts exist between instructions and information in this manual and local or national codes or regulations, installation and operation shall comply with the codes or regulations in force in the country in which the equipment is installed.

Service may be obtained by contacting your local Frymaster Dean Factory Authorized Service Agency.

 **DANGER**

Building codes prohibit a fryer with its open tank of hot oil being installed beside an open flame of any type, including those of broilers and ranges.

Upon arrival, inspect the fryer carefully for visible or concealed damage. (See **Shipping Damage Claim Procedure** in Section 1.7 of this manual.)

2.1.1 Clearance and Ventilation

The fryer(s) must be installed with a 6" (150 mm) clearance at both sides and back when installed adjacent to combustible construction; no clearance is required when installed adjacent to noncombustible construction. A minimum of 24" (600 mm) clearance should be provided at the front of the fryer.

 **WARNING**

Do not block the area around the base or under the fryers.

 **DANGER**

No structural material on the fryer should be altered or removed to accommodate placement of the fryer under a hood. Questions? Call the Frymaster Dean Service Hotline at 1-800-551-8633.

One of the most important considerations of efficient fryer operation is ventilation. Make sure the fryer is installed so that products of combustion are removed efficiently, and that the kitchen ventilation system does not produce drafts that interfere with burner operation.

The fryer flue opening must not be placed close to the intake of the exhaust fan, and the fryer must never have its flue extended in a “chimney” fashion. An extended flue will change the combustion characteristics of the fryer, causing longer recovery time. It also frequently causes delayed ignition. To provide the airflow necessary for good combustion and burner operation, the areas surrounding the fryer front, sides, and rear must be kept clear and unobstructed.

 **DANGER**

This appliance must be installed with sufficient ventilation to prevent the occurrence of unacceptable concentrations of substances harmful to the health of personnel in the room in which it is installed.

Fryers must be installed in an area with an adequate air supply and adequate ventilation. Adequate distances must be maintained from the flue outlet of the fryer to the lower edge of the ventilation filter bank. Filters should be installed at an angle of 45°. Place a drip tray beneath the lowest edge of the filter. For U.S. installation, NFPA standard No. 96 states, “A minimum distance of 18 in. (450 mm) should be maintained between the flue outlet and the lower edge of the grease filter.” *Frymaster recommends that the minimum distance be 24 in. (600 mm) from the flue outlet to the bottom edge of the filter when the appliance consumes more than 120,000 BTU per hour.*

For installations in the United States, information on construction and installation of ventilating hoods can be found in the NFPA standard cited above. A copy of the standard may be obtained from the National Fire Protection Association, Battery March Park, Quincy, MA 02269.

2.1.2 National Code Requirements

The type of gas for which the fryer is equipped is stamped on the data plate attached to the inside of the fryer door. Connect a fryer stamped “NAT” only to natural gas, those stamped “PRO” only to propane gas, and those stamped “MFG” only to manufactured gas.

Installation shall be made with a gas connector that complies with national and local codes, and, where applicable, CE codes. Quick-disconnect devices, if used, shall likewise comply with national, local, and, if applicable, CE codes. In the absence of local codes, installation must conform to the national Fuel Gas Code, ANSI Z223.1/NFPA 54 or the Natural Gas and Propane Installation code, CSA B149.1, as applicable including:

1. The appliance and its individual shutoff valve must be disconnected from the gas supply piping system during any pressure testing of the system at test pressures in excess of ½ psi (3.5 kPa).
2. The appliance must be isolated from the gas supply piping system by closing its individual manual shutoff valve during any pressure testing of the gas supply piping system at test pressures equal to or less than ½ psi (3.5 kPa).

2.1.3 Electrical Grounding Requirements

All electrically operated appliances must be grounded in accordance with all applicable national and local codes, and, where applicable, CE codes. In the absence of local codes, the appliance must be grounded in accordance with National Electrical Code, ANSI/NFPA 70, or the Canadian Electrical Code, CSA C22.2, as applicable. All units (cord connected or permanently connected) should be connected to a grounded power supply system. A wiring diagram is located on the inside of the fryer door. Refer to the rating plate on the inside of the fryer door for proper voltages.

⚠ DANGER

This appliance is equipped with a special (grounding) plug for your protection against electrical shock, and must be plugged directly into a properly grounded receptacle. Do not cut, remove, or otherwise bypass the grounding prong on this plug!

⚠ DANGER

This appliance requires electrical power for operation. Place the gas control valve in the OFF position in case of a prolonged power outage. Do not attempt to operate this appliance during a power outage.

⚠ WARNING

To ensure the safe and efficient operation of the fryer and hood, the electrical plug for the 120-volt line, which powers the hood, must be fully engaged and locked in its pin and sleeve socket.

2.1.4 Australian Requirements

To be installed in accordance with AS 5601 / AG 601, local authority, gas, electricity, and any other relevant statutory regulations.

2.2 Caster Installation

On an appliance with casters; the installation shall be made with a connector that complies with the Standard for Moveable Gas Appliances, ANSI Z21.69 • CSA 6.16, and a quick disconnect device that complies with the Standard for Quick-Disconnect Devices for Use With Gas Fuel, ANSI Z21.41 • CSA 6.9.

2.3 Pre-Connection Preparations

⚠ DANGER

DO NOT connect this appliance to the gas supply before completing each step in this section.

After the fryer has been positioned under the exhaust hood, ensure the following has been accomplished:

1. Adequate means must be provided to limit the movement of fryers without depending upon the gas line connector and the quick-disconnect device or its associated piping to limit the appliance movement. If a flexible gas hose is used, a restraining cable must be connected at all times when the fryer is in use. The restraining cable and installation instructions are packed with the flexible hose in the accessories box that was shipped with your unit.

⚠ DANGER

The appliance area must be kept free and clear of combustible material at all times.

2. Frymaster recommends that the minimum distance from the flue outlet to the bottom edge of the hood be 24 in. (600 mm) when the appliance consumes more than 120,000 BTU per hour.
NOTE: There are no built-in leveling devices on fryers equipped with casters. The floor where the fryer is to be installed must be level.

3. Test the fryer electrical system:
 - a. Plug the fryer electrical cord(s) into a grounded electrical receptacle. **NOTE: To ensure the safe and efficient operation of the fryer and hood, the electrical plug for the 120-volt line, which powers the hood, must be fully engaged and locked in its pin and sleeve socket.**
 - b. Place the power switch in the **ON** position.
 - For fryers having computers, verify that the display indicates **ON**.
 - If the store is equipped with a hood interlock system, the hood exhaust fan should be on. If not, the store hood interlock system is improperly wired and must be corrected.
 - c. Place the fryer power switch in the **OFF** position. Verify that the display indicates **OFF**. The hood exhaust system should be off when all computers display OFF.
4. Refer to the data plate on the inside of the fryer door to determine if the fryer burner is configured for the proper type of gas before connecting the fryer quick-disconnect device or piping from the gas supply line.
5. Verify the minimum and maximum gas supply pressures for the type of gas to be used in accordance with the accompanying tables.

CE Standard for Incoming Gas Pressures for Fryers Manufactured After April 1999					
Gas	Pressure (mbar) ⁽¹⁾	Orifice Diameter		Regulator Pressure	
		Single Vat	Dual Vat	Single Vat	Dual Vat
G20	20	2 x 3.40	2 x 3.40	7 mbar	7 mbar
G25	20 or 25	2 x 3.40	2 x 3.40	10 mbar	10 mbar
G30	28/30 or 50	2 x 2.05	2 x 2.05	17 mbar	17 mbar
G31	37 or 50	2 x 2.05	2 x 2.05	20 mbar	20 mbar

(1) mbar = 10,2 mm H₂O

Non-CE Standard for Incoming Gas Pressures		
Gas	Minimum	Maximum
Natural	6" W.C.	14" W.C.
	1.49 kPa	3.48 kPa
	14.93 mbar	34.84 mbar
LP	11" W.C.	14" W.C.
	2.74 kPa	3.48 kPa
	27.37 mbar	34.84 mbar

6. For fryers equipped with a FootPrint Pro system (BIGLA30 models) plug the electrical cord(s) into a power receptacle behind the fryer.

2.4 Connection to Gas Line

DANGER

Before connecting new pipe to this appliance, the pipe must be blown out thoroughly to remove all foreign material. Foreign material in the burner and gas controls will cause improper and dangerous operation.

DANGER

The appliance and its individual shutoff valve must be disconnected from the gas supply piping system during any pressure testing of the system at test pressures in excess of ½ PSI (3.45 kPa, 13.84 inches W.C.) to avoid damage to the fryer's gas tubes and gas valve(s).

⚠ DANGER

The appliance must be isolated from the gas supply piping system by closing its individual manual shutoff valve during any pressure testing of the gas supply piping system at test pressures equal to or less than ½ PSI (3.45 kPa, 13.84 inches W.C.)

⚠ DANGER

“Dry-firing” your unit will cause damage to the frypot and can cause a fire. Always ensure that cooking oil or water is in the frypot before firing the unit.

⚠ DANGER

All connections must be sealed with a joint compound suitable for the gas being used and all connections must be tested with a solution of soapy water before lighting any pilots.

Never use matches, candles, or any other ignition source to check for leaks. If gas odors are detected, shut off the gas supply to the appliance at the main shut-off valve and immediately contact the local gas company or an authorized service agency for service.

The size of the gas line used for installation is very important. If the line is too small, the gas pressure at the burner manifold will be low. This may cause slow recovery and delayed ignition. The incoming gas supply line should be a minimum of 1½” (38 mm) in diameter. Refer to the chart on the following page for the minimum sizes of connection piping.

Gas Connection Pipe Sizes			
(Minimum incoming pipe size should be 1 1/2" (41 mm))			
Gas	Single Unit	2 - 3 Units	4 or more units*
Natural	3/4" (22 mm)	1" (28 mm)	1 1/4" (36 mm)
Propane	1/2" (15 mm)	3/4" (22 mm)	1" (28 mm)
Manufactured	1" (28 mm)	1 1/4" (36 mm)	1 1/2" (41 mm)

* For distances of more than 20 feet (6 m) and/or more than 4 fittings or elbows, increase the connection by one pipe size.

The BIGLA30 LOV™ gas fryer has received the CE mark for the countries and gas categories indicated in the table on the following page. **NOTE:** The nominal heat input (QN) is 21kW except for AT, DE, LU and category 3P/B, which is 23kW.

CE Approved Gas Categories by Country			
COUNTRIES	CATEGORIES	GAS	PRESSURE (MBAR)
AUSTRIA (AT)	I12H3B/P	G20	20
		G30, G31	50
BELGIUM (BE)	I2E(R)B	G20, G25	20, 25
	I3+	G30, G31	28-30, 37
DENMARK (DK)	I12H3B/P	G20	20
		G30, G31	30
FRANCE (FR)	I12Esi3+	G20, G25	20, 25
		G30, G31	28-30, 37
	I12Esi3P	G20, G25	20, 25
		G31	50
FINLAND (FI)	I12H3B/P	G20	20
		G30, G31	30
GERMANY (DE)	I12ELL3B/P	G20, G25	20
		G30, G31	50
	I3P	G31	50
GREECE (GR)	I12H3+	G20	20
		G30, G31	28-30, 37
ITALY (IT)	I12H3+	G20	20
		G30, G31	28-30, 37
IRELAND (IE)	I12H3+	G20	20
		G30, G31	28-30, 37
LUXEMBOURG (LU)	I12E3B/P	G20	20
		G30, G31	50
NETHERLANDS (NL)	I12L3P	G25	25
		G31	50
	I12L3B/P	G25	25
		G30, G31	30
NORWAY (NO)	I3B/P	G30, G31	30
PORTUGAL (PT)	I12H3+	G20	20
		G30, G31	28-30, 37
SPAIN (ES)	I12H3+	G20	20
		G30, G31	28-30, 37
	I12H3P	G20 G31	20 37, 50
SWEDEN (SE)	I12H3B/P	G20	20
		G30, G31	30
UNITED KINGDOM (UK)	I12H3+	G20	20
		G30, G31	28-30, 37

CE Standard
Required airflow for the combustion air supply is 2m³/h per kW.

1. Connect the quick-disconnect hose to the fryer quick-disconnect fitting under the front of the fryer and to the building gas line.

NOTE: Some fryers are configured for a rigid connection to the gas supply line. These units are connected to the gas supply line at the rear of the unit.

When using thread compound, use very small amounts on male threads only. Use a pipe thread compound that is not affected by the chemical action of LP gases (Loctite™ PST56765 Sealant is one such compound). DO NOT apply compound to the first two threads. Doing so may allow some of the compound to enter the gas stream, resulting in clogging of burner orifices and/or the control valve.

2. Open the gas supply to the fryer and check all piping, fittings, and gas connections for leaks. A soap solution should be used for this purpose.

- Light the fryer following the procedures that are described in the “Lighting Instructions” found in Chapter 3 of this manual.

⚠ DANGER

“Dry-firing” your unit will cause damage to the frypot and can cause a fire. Always ensure that cooking oil or water is in the frypot before firing your unit.

- The burner manifold pressure should be checked at this time by the local gas company or an authorized service agent. The tables below and on the following page list the burner manifold gas pressures for the various gas types that can be used with this equipment.

CE Standard Burner Manifold Gas Pressures for Fryers Manufactured After April 1999		
Gas	Pressure (mbar)	
	Single Vat	Dual Vat
Natural Gas Lacq (G20) under 20 mbar	7	7
Natural Gas Groningue * (G25) under 25 mbar	10	10
Natural Gas Groningue (G25) under 20 mbar	10	10
Butane (G30) at 28/30 or 50 mbar	17	17
Propane (G31) under 37 or 50 mbar	20	20

* Belgian G25 = 7,0 mbar (single or dual)

Non-CE Standard Burner Manifold Gas Pressures	
Gas	Pressure
Natural	3" W.C. 0.73 kPa
Propane	8.25" W.C. 2.5 kPa

- Check the programmed temperature thermostat setting. (Refer to chapter 4 *M3000 Computer Instructions*) for the setpoint programming instructions for your particular controller.)

2.5 Converting to Another Gas Type

⚠ DANGER

This appliance was configured at the factory for a specific type of gas. Converting from one type of gas to another requires the installation of specific gas-conversion components. Conversion instructions are included with conversion kits.

Switching to a different type of gas without installing the proper conversion components may result in fire or explosion. NEVER ATTACH THIS APPLIANCE TO A GAS SUPPLY FOR WHICH IT IS NOT CONFIGURED!

Conversion of this appliance from one type of gas to another should only be performed by qualified, licensed, and authorized installation or service personnel, as defined in Section 1.6 of this manual.

BIGLA30 LOV™ gas fryers manufactured for Non-CE countries use different burners for each type gas. The burners in fryers built for propane gas have a special gray-colored coating on the burner tiles to enable them to withstand the higher caloric value of the propane gas. Burners designed for use in propane units may be used in natural gas applications, but not vice versa.

Non-CE Gas Conversion Kits

Natural Gas to Propane (LP) Gas

Full Vat: Part Number 826-2527

Dual Vat: Part Number 826-2529

Propane (LP) Gas to Natural Gas

Full Vat: Part Number 826-2528

Dual Vat: Part Number 826-2530

Non-CE Gas Conversion Kits for Australia

Natural Gas to Propane (LP) Gas

Full Vat: Part Number 826-2745

Dual Vat: Part Number 826-2746

Propane (LP) Gas to Natural Gas

Full Vat: Part Number 826-2747

Dual Vat: Part Number 826-2748

Units manufactured for export to CE countries are equipped with “universal” burners that may be used with either natural (G20, G25) gas or butane (G30) and propane (G31) gasses.

CE Gas Conversion Kits for Units with Gas Valve 810-1715

G20 or G25 (Natural) to G30 or G31 Gas:

Part Number 826-1196

G30 or G31 to G20 or G25 (Natural) Gas:

Part Number 826-1197

CE GAS CONVERSION INSTRUCTIONS

1. Between G20- and G25-type Natural Gas, adjust the gas pressure at the regulator. (Refer to the CE Standard Burner Manifold Gas Pressure Chart.) Do not change the orifice.
2. Between a 2nd family (G20 or G25) and a 3rd family gas (G30 Butane or G31 Propane):
 - a. Change the orifices.
 - b. Adjust the manifold pressure.
3. Remove the old rating plate and return to Frymaster. Affix the new rating plate included with the conversion kit in place of the old rating plate stating the gas has been converted.
4. If the destination language changes, replace the rating plate. Call your local service agency or KES for a label kit. The language of reference will be on the corner of the label.

2.6 After Fryers are Positioned at the Frying Station

⚠ DANGER

No structural material on the fryer should be altered or removed to accommodate placement of the fryer under a hood. Questions? Call the Frymaster Dean Service Hotline at 1-800-551-8633.

1. Once the fryer has been positioned at the frying station, use a carpenter's level placed across the top of the frypot to verify that the unit is level, both side-to-side and front-to-back.

To level fryers, adjust the casters being careful to ensure the fryer(s) are at the proper height in the frying station.

When the fryer is leveled in its final position, install the restraints provided by the KES to limit its movement so that it does not depend on or transmit stress to the connection. Install the restraints in accordance with the provided instructions. If the restraints are disconnected for service or other reasons, they must be reconnected before the fryer is used.

⚠ DANGER

Hot oil can cause severe burns. Avoid contact. Under all circumstances, oil must be removed from the fryer before attempting to move it to avoid spills, falls, and severe burns. Fryers may tip and cause personal injury if not secured in a stationary position.

⚠ DANGER

Adequate means must be provided to limit the movement of this appliance without depending on the connector and the quick-disconnect device or its associated piping to limit the appliance movement.

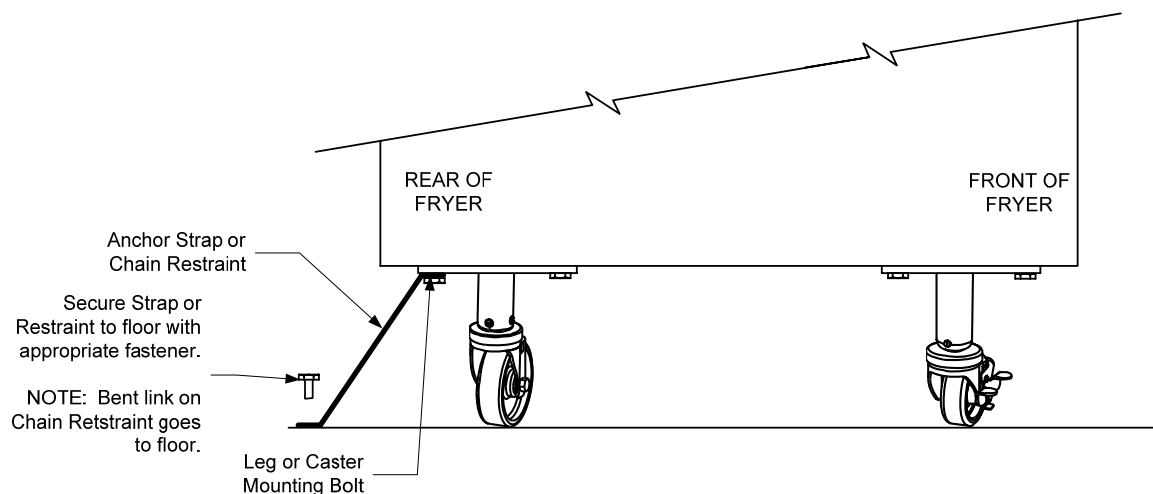

2. Clean, and fill frypot(s) with cooking oil. (See *Equipment Setup and Shutdown Procedures* in Chapter 3.)

BIGLA30 SERIES GEN II LOV™ GAS FRYER

CHAPTER 3: OPERATING INSTRUCTIONS

FINDING YOUR WAY AROUND THE BIGLA30 SERIES LOV™ GAS FRYER

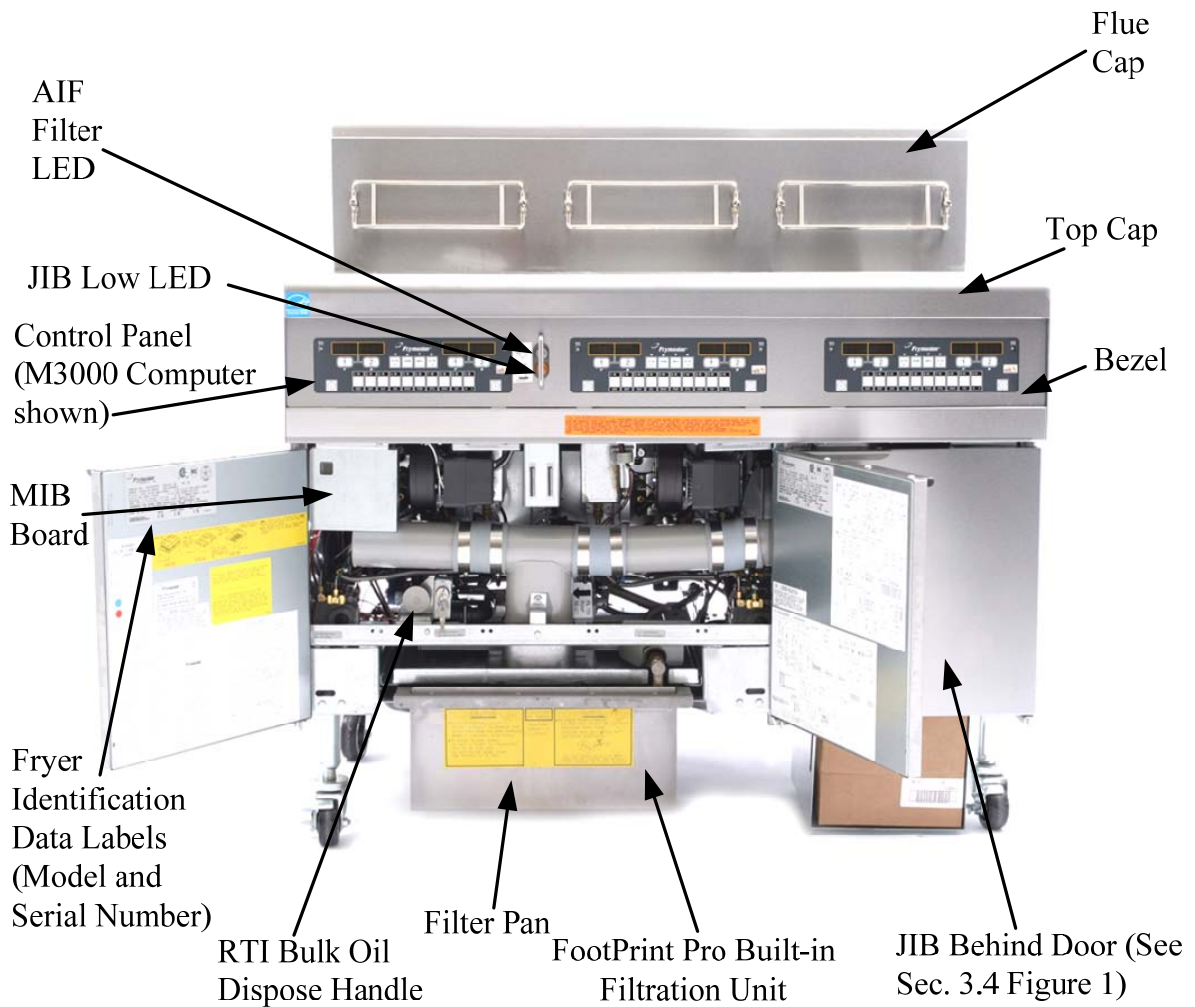

TYPICAL CONFIGURATION (BIGLA330 SHOWN)

NOTE: The appearance of your fryer may differ slightly from that shown depending upon configuration and date of manufacture.

3.1 Equipment Setup and Shutdown Procedures

⚠ WARNING

The on-site supervisor is responsible for ensuring that operators are made aware of the inherent hazards of operating a hot oil filtering system, particularly the aspects of oil filtration, draining and cleaning procedures.

⚠ CAUTION

Before lighting the fryer, make sure the fryer is OFF and the frypot drain valves are closed. Remove the basket support rack(s), if installed, and fill the frypot to the bottom OIL-LEVEL line.

3.1.1 Setup

⚠ WARNING

Never operate this appliance with an empty frypot. The frypot must be filled with water or oil before lighting the burners. Failure to do so will damage the frypot and may cause a fire.

⚠ DANGER

Remove all drops of water from the frypot before filling with oil. Failure to do so will cause spattering of hot liquid when the oil is heated to cooking temperature.

⚠ WARNING

The BIGLA30 is not intended to use solid shortening. Use only liquid shortening with this fryer. The use of solid shortening will clog the top off oil lines. The oil capacity of the BIGLA30 LOV™ gas fryer is 32 lbs. (3.8 gallons/14.5 liters) at 70°F (21°C) for a full-vat and 18 lbs. (2.2 gallons/8.33 liters) at 70°F (21°C) for each half of a dual-vat.

Prior to filling frypots with oil, ensure all drains are closed.

1. Fill the frypot with cooking oil to the bottom OIL LEVEL line located on the rear of the frypot. This will allow for oil expansion as heat is applied. Do not fill cold oil any higher than the bottom line; overflow may occur as heat expands the oil.
2. Ensure that the power cord(s) is/are plugged into the appropriate receptacle(s). Verify that the face of the plug is flush with the outlet plate, with no portion of the prongs visible.
3. Ensure that the oil level is at the *top* OIL LEVEL line when the oil *is at its cooking temperature*.

3.1.2 Lighting the Fryer

1. Press the computer ON/OFF switch to the OFF position.

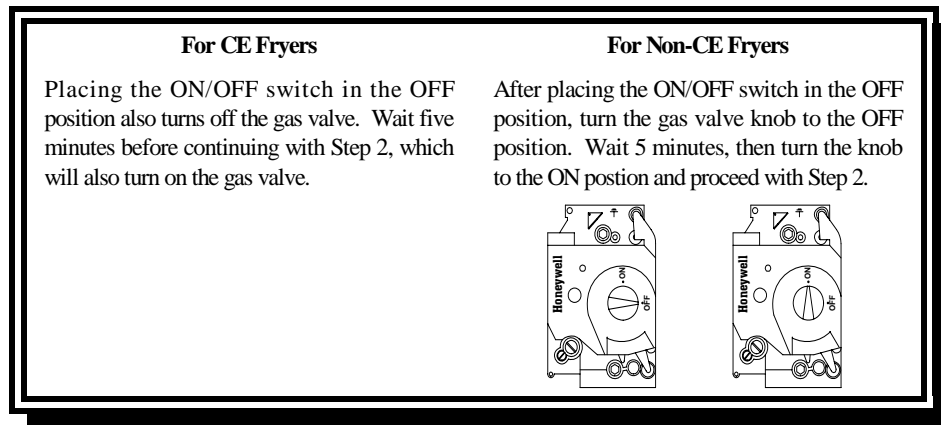

2. Press the computer ON/OFF switch to the ON position.
3. If the burners fail to light, press the ON/OFF switch to the OFF position and wait 60 seconds. Repeat step 2.
4. The fryer will automatically enter the melt cycle mode if the frypot temperature is below 180°F (82°C) and will display *MLT-CYCL* alternating with *LOW TEMP*. (**NOTE:** During the melt cycle, the burners will repeatedly fire for a few seconds, then go out for a longer period.) When the frypot temperature reaches 180°F (82°C), the unit will automatically switch to the heating mode and *LOW TEMP* is displayed until within 15°F (9°C) of setpoint. The burners will remain lit until the frypot temperature reaches the programmed cooking temperature. Once the fryer reaches setpoint, the computer display changes to the product or dashed lines and the fryer is ready for use.
5. After the burners have been lit for at least 90 seconds, observe the flames through the burner viewing ports located on each side of the combustion air blower.

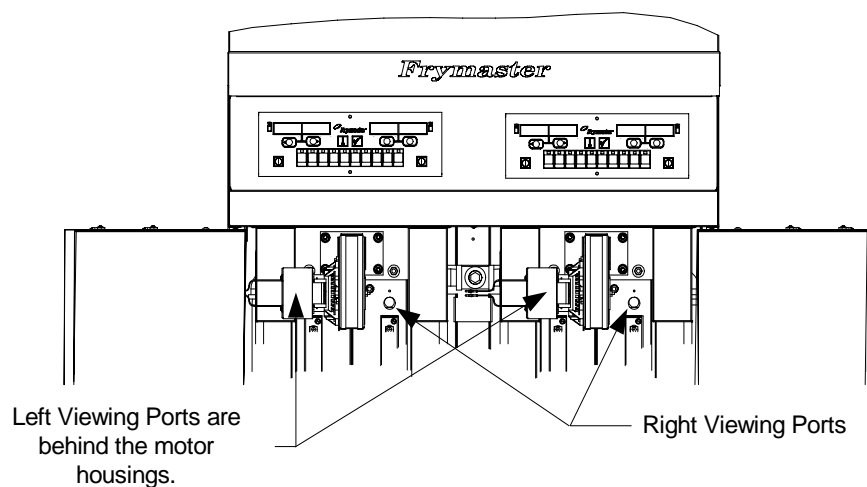

The optimum burn is a bright orange-red glow. If a blue flame is observed, or if there are dark spots on a burner face, adjust the air gas mixture as follows: On the side of the blower housing opposite the motor is a plate with a locking nut. Loosen the nut enough to allow the plate to be moved, then

adjust the position of the plate to open or close the air intake opening until a bright orange-red glow is obtained. Carefully hold the plate in position and tighten the locking nut.

3.1.3 Shutdown

For short-term shut down during the workday:

1. Place the computer ON/OFF switch in the **OFF** position and put the frypot covers in place.

When shutting the fryers down at closing time:

1. Place the computer ON/OFF switch in the **OFF** position to turn the fryer off.

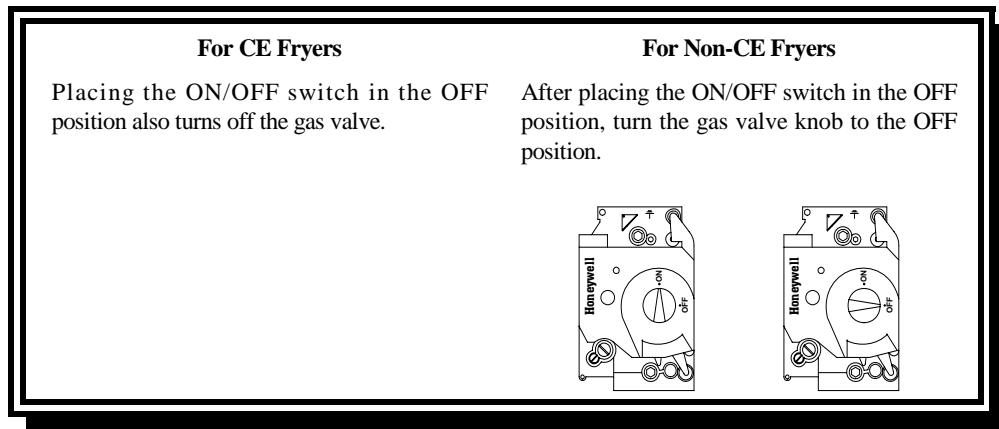

2. Filter the oil and clean the fryers (See Chapters 5 and 6).
3. Place the frypot covers on the frypots.

3.2 Operation

This fryer is equipped with M3000 computers (illustrated below). Refer to the *M3000 Computer Operating Instructions* in Chapter 4 for the computer programming and operating procedures.

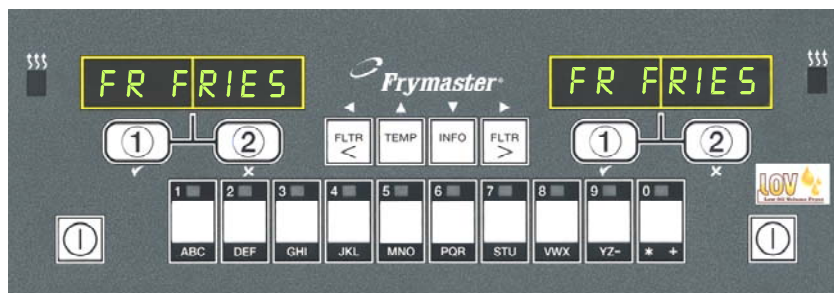

M3000 COMPUTER

Refer to Chapter 5 of this manual for operating instructions for the built-in filtration system.

3.3 Low Oil Volume Automatic Refill

When the Low Oil Volume (LOV™) system is in place on the fryer, the frypot oil levels are continually checked and topped off as necessary from a reservoir in the cabinet. The reservoir holds a 35 pound box of oil. In a typical operation this will last approximately two days. Components of the system are annotated at the right (see Figure 1).

NOTE: The system is intended to top off the frypots, not fill them. The frypots will require manual filling upon startup and after deep clean (boil-out).

3.4.1 Prepare the System for Use

Once the fryer is positioned under the hood install the JIB basket shipped in the accessories pack (see Figure 2).

3.4.2 Install the JIB

Remove the original lid from the oil container and foil liner. Replace with the provided cap, which has connected suction hardware. Ensure the feeder tube from the cap reaches to the bottom of the oil container.

Place the oil container inside the cabinet and slide it into place (as shown on the following page). Avoid catching the suction hardware on the cabinet interior as the container is placed in the fryer. The system is now ready for operation.

3.4.3 Changing the JIB

When the oil reservoir level is low, a orange LED is activated (see Figure 3). Once the reservoir is refilled and/or replaced, press and hold the orange reset button next to the JIB until the orange LED is no longer illuminated.

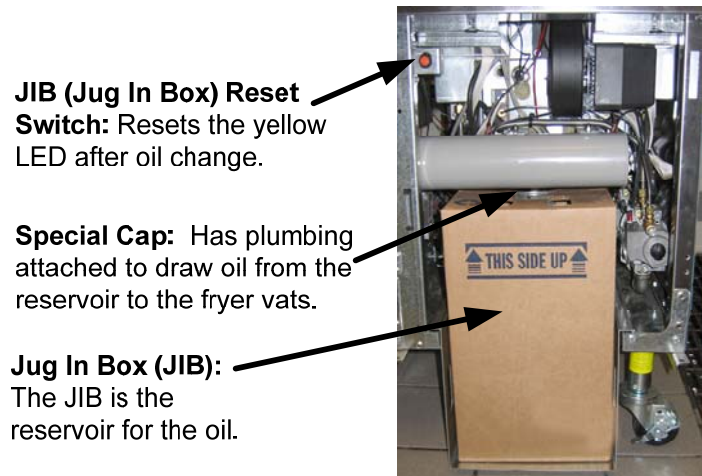

Figure 1

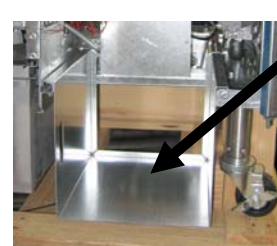

Figure 2



Figure 3

View looking at front of fryer

1. Open the cabinet and slide the JIB from the cabinet (see Figure 4).
2. Remove the cap and pour any remaining oil in the container into all fry vats equally (see Figure 5).



Figure 4



Figure 5

3. Place new JIB upright and remove the cap and foil seal (see Figure 6).
4. Put the tube in the new full container (see Figure 7).



Figure 6



Figure 7

WARNING: Do not add HOT or USED oil to a JIB.

5. Slide the JIB onto the shelf inside the fryer cabinet (as seen in Figure 4).
6. Press the JIB reset switch to turn the JIB LED on the front of the fryer off (see Figure 8).

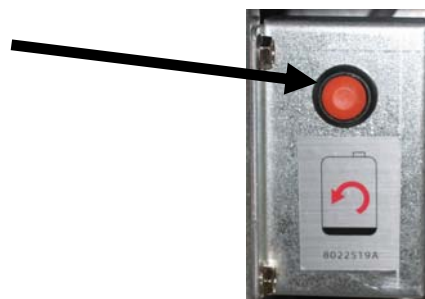

Figure 8

3.4.4 Bulk Oil Systems

Instructions for installing and using bulk oil systems are found in Appendix A located at the rear of this manual.

BIGLA30 SERIES GEN II LOV™ GAS FRYER

CHAPTER 4: M3000 COMPUTER INSTRUCTIONS

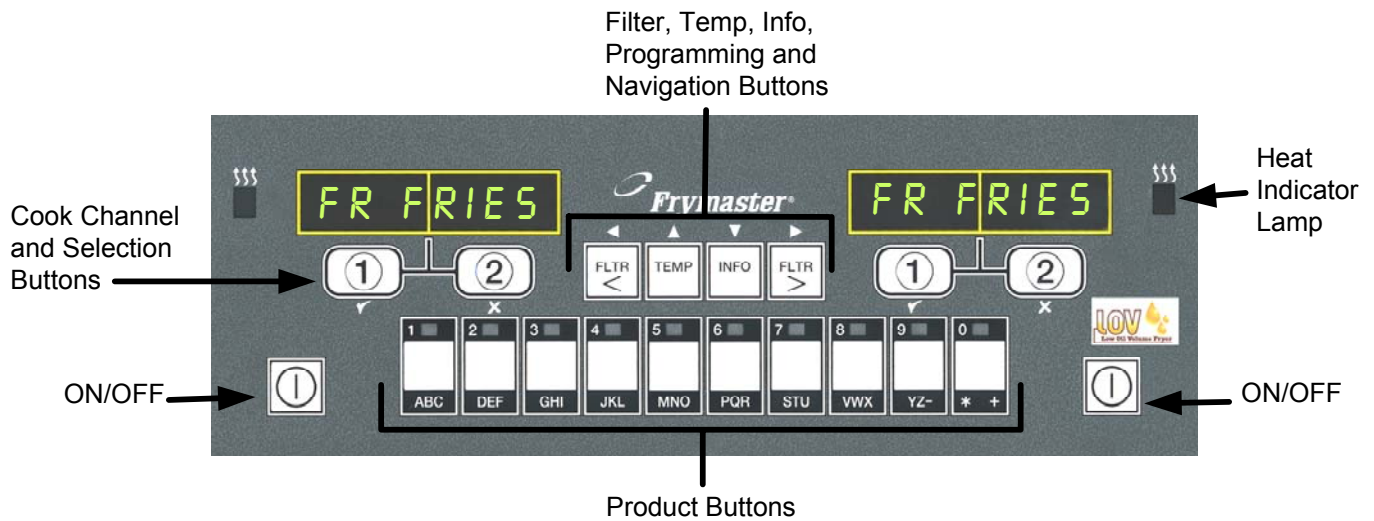

4.1 M3000 General Information

Welcome to the M3000, a computer that retains the one-button ease of the M2000 and 100B and the utility of 40-product menu capability. The computer is easy to use. One button push starts a cook cycle for an item cooked in a dedicated vat. The same flexible computer on a multi-product vat requires only two button pushes to launch a cook cycle. Just choose a menu item on a product button and press, and then press a cook channel button under the display showing the desired item. The computer can move seamlessly from McNuggets to Crispy Chicken to any added menu item.

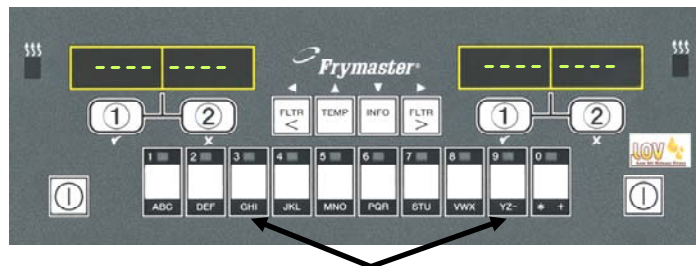

Pressing product buttons 3 or 9 displays McChick.

In a typical store setting, the M3000s on the three-vat fry station display FR FRIES (shown above) and will launch a cook cycle with one push of a cook channel button. On the chicken/filet station, the LED display shows dashed lines. To launch a cook cycle, press a product button and then press the cook channel button that corresponds with the location of the

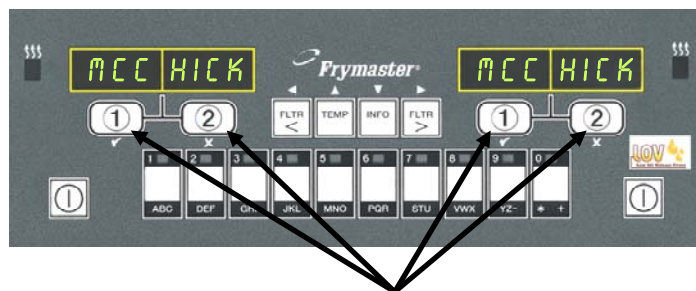

Pressing either cook cycle button under the McChick displays launches a cook cycle.

dropped basket. By pressing the product button for McChicken, McChick will appear in the display. Just press the cook channel button corresponding to the location of the appropriate dropped basket.

The M3000 will operate with electric and gas fryers, both full- and split-vat.

4.2 Basic Operation

Basic Operation

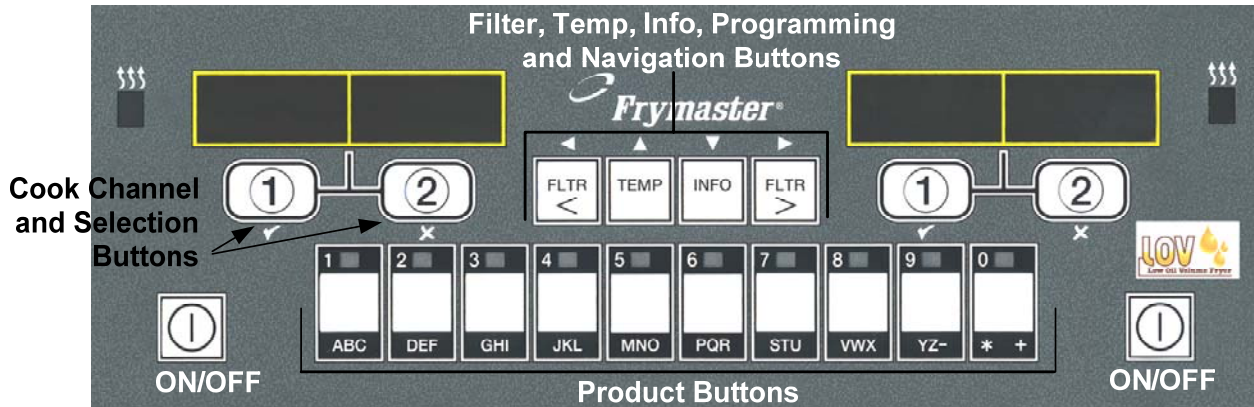

Turn Fryer ON

Press either button for full pot; press button on desired side on a split pot.



Turn Fryer OFF

Press either button for full pot; press button on desired side on a split pot.



Check Frypot Temperature

Press TEMP button once. Displays show frypot temperatures.



Check Frypot Setpoint

Press TEMP button twice. Displays show frypot setpoint temperatures.



Cancel Duty or Remove Alarm

Press button under active display.



Start One-Button Cook Cycle (Dedicated Mode)

Press either button under display showing desired item.



Start Two-Button Cook Cycle (Multi-Product Mode)

Press product button bearing icon for desired product. Press cook channel button to begin cook cycle.

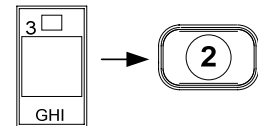

Change From Dedicated to Multi-Product Mode

Press and hold a Cook Channel button under displayed menu item for approximately three seconds until beep is heard. Display changes to dashed lines.



Change From Multi-Product Mode to Dedicated Mode



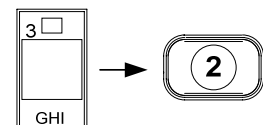

Press product button bearing icon for desired product. Press cook channel button under display showing desired item until beep is heard (approx three seconds).



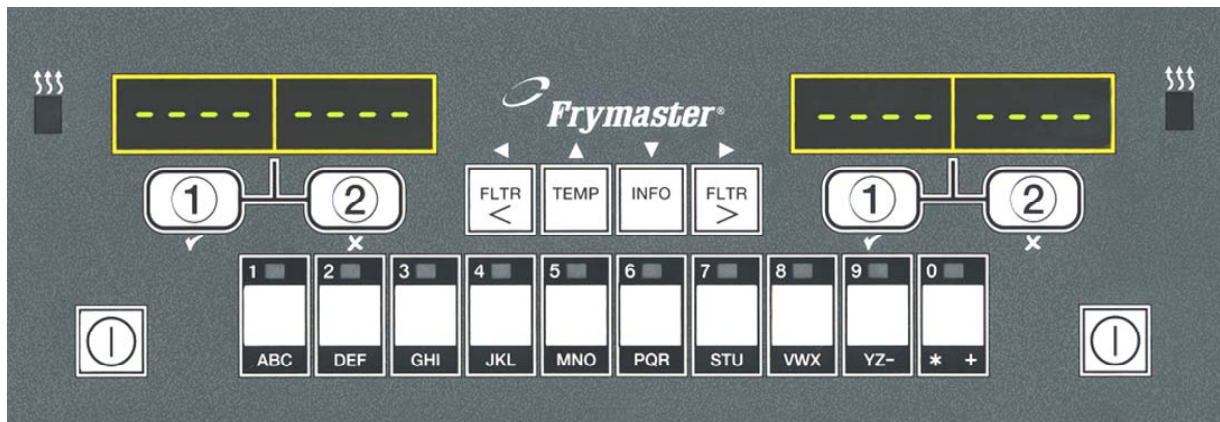

4.3 Cooking with Multi-Product Display

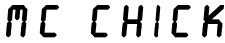
Cooking With Multi-Product Display







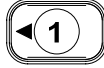

- 1 Dashed lines appear in both displays. 
- 2 Press a product button. 
- 3 Vat with appropriate setpoint displays: skip to step 5. 
- 4 Vat with inappropriate setpoint displays: 

If this occurs, change setpoint by pressing the button assigned to the product. 

When the chevrons appear, immediately press and hold cook channel button until a beep is heard (approx three seconds) and release. 
- 5 Press a cook channel button to begin cook cycle. 

NOTE: If error *REMOVE DISCARD PRODUCT* appears, press the cook channel button under the message to cancel alarm and remove error message.

- 6 Display alternates between product ID and remaining cook time. 
- 7 If a duty is required for this menu item, duty is displayed when it is time to perform a duty, such as shake. 
- 8 Press cook channel button under duty display to cancel alarm. 
- 9 Pull is displayed when the cook time is complete; an alarm sounds. 
- 10 Press cook channel button under pull display to cancel alarm. 
- 11 Dashed lines reappear under active display at the end of the cook cycle. 

4.4 Cooking with Dedicated Display

Cooking With Dedicated Display

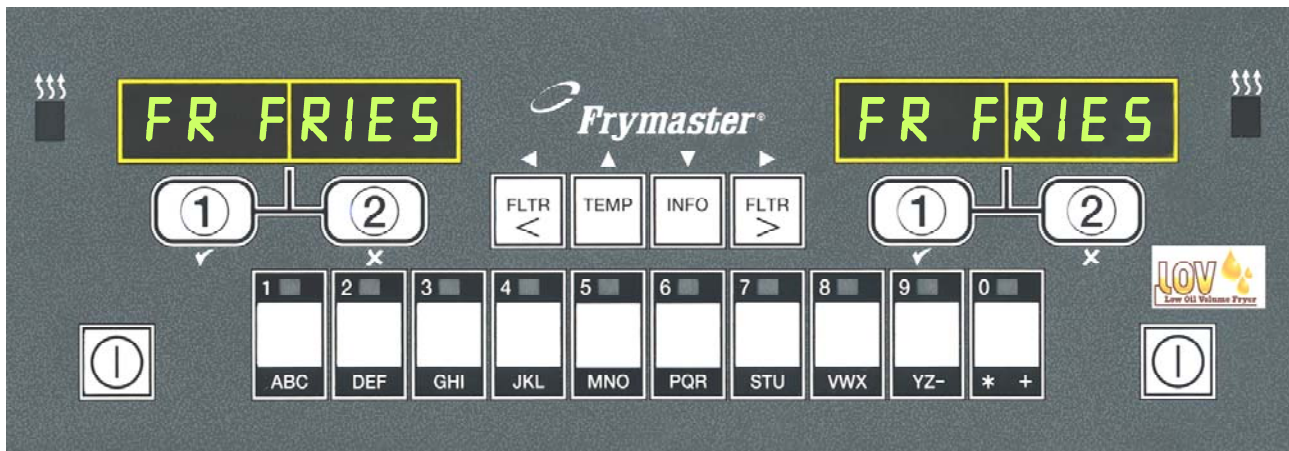

1 A menu item, such as FR FRIES shows in display

FR FRIES

2 Press a cook channel button to begin the cook cycle.

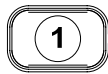

3 Display alternates between abbreviated product name and remaining cook time.

FRY ↔ 2:34

4 Duty is displayed when it is time to shake the fry basket.

DUTY

5 Press cook channel button to cancel alarm.

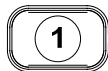

6 Pull is displayed when the cook cycle is complete.

PULL

7 Press cook channel button to cancel alarm.



8 Q 7 is displayed and alternates with FRY. As the quality time counts down.

Q 7 ↔ FRY

Q 1 ↔ FRY

9 Pressing the cook channel button now will launch a cook cycle and end the quality countdown.



10 QUAL is displayed when the quality time has elapsed.

QUAL

11 Pressing the cook channel button restores the display to FR FRIES and the unit is ready for cooking.



FR FRIES

4.5 Changing from Breakfast Setup to Lunch

Changing from Breakfast Setup to Lunch

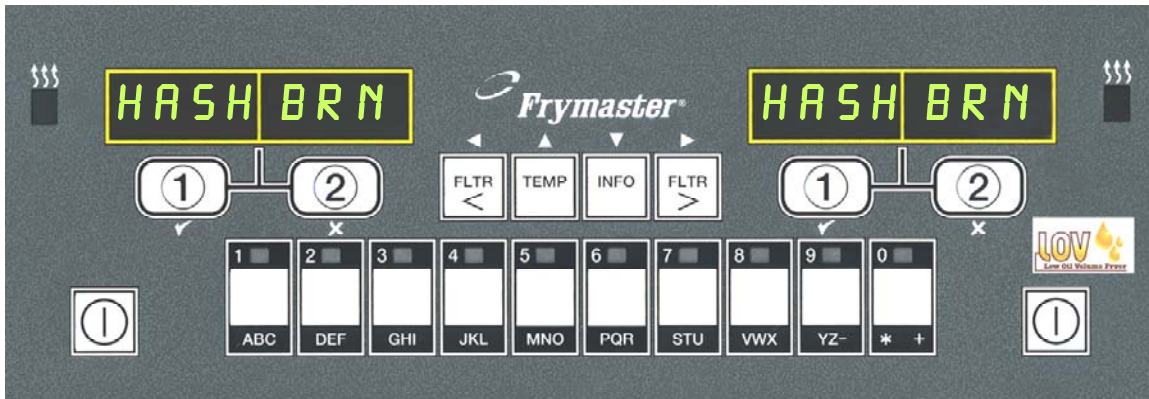

- 1 Press and quickly release product button for french fries.



- 2 Computer will change from HASH BRN to <<<< >>>>; an alarm will sound.

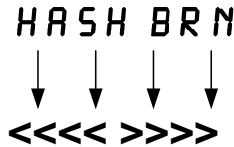

- 3 Press and hold the cook channel button under the display until a beep is heard (approximately three seconds) and release.

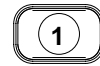

- 4 Display changes to FR FRIES.

Perform these steps on both sides to change both displays to FR FRIES

4.6 Changing from Lunch Setup to Breakfast

Changing from Lunch Setup to Breakfast

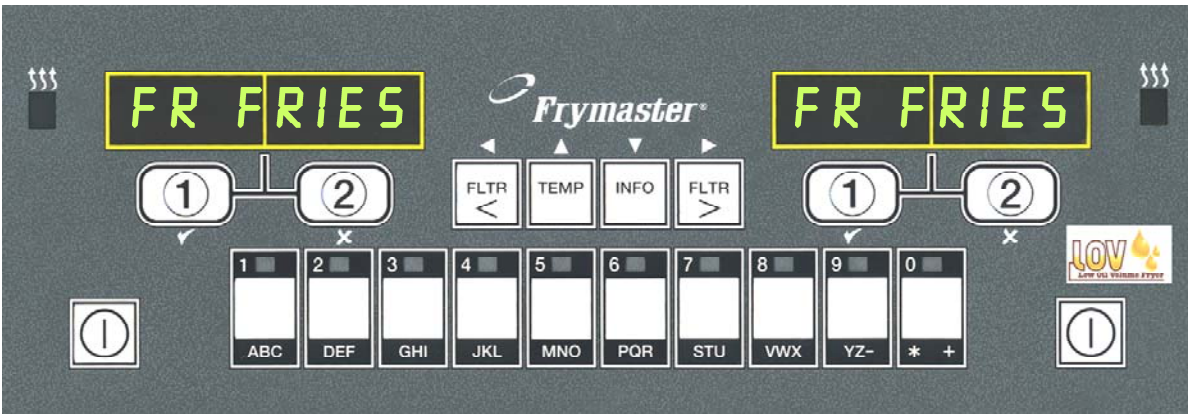

1 Computer displays **FR FRIES**

2 Press and quickly release product button for hash browns.



3 Computer display will change from FR FRIES to <<<< >>>>; an alarm sounds.

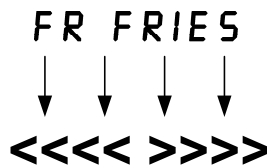

4 Press and hold the cook channel button under the display until a beep is heard (approximately three seconds) and release.



5 Display changes to LOW TEMP until setpoint is reached. **LOW TEMP**

6 Display changes to Hash Brn. **HASH BRN**

Perform these steps on both sides to change both displays to HASH BRN

4.7 M3000 Button Description and Functions

4.7.1 Navigation Buttons

The menu on the M3000 uses ◀ ▶ and ▲ ▼ buttons to navigate the various menus and submenus.

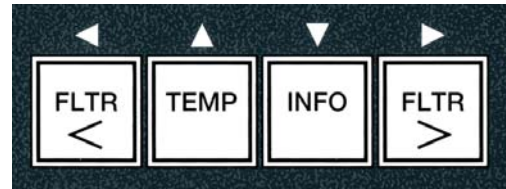

When programming, the left screen shows a menu or submenu item. The right screen is for data entry. Data is entered with alpha-numeric characters, scrolling through lists or by toggling between choices.



During programming if a button is not pushed within one minute, the computer returns to operation mode.

4.7.2 Filter, Temperature and Info Buttons

The < **FLTR** and **FLTR** > buttons (see Figure 1) are used to filter the left and right vats of a split vat or a full vat fryer on demand. The **FLTR** buttons, if pressed once displays the number of cook cycles remaining until a filtration prompt. When the **FLTR** button is pressed twice, the date and time of the last filter is displayed. The **TEMP** button, if pressed once while the fryer is on, displays current vat temperature on both sides. If the **TEMP** button is pressed twice while the fryer is on, it shows the setpoint temperatures of the vats. If the fryer is off, the display shows the current versions of software. The **INFO** button (see Figure 1), if pressed once when the fryer is on, shows the recovery time for each vat from the last test. Recovery is the time required for the fryer to raise the temperature of the oil 50°F (28°C) between 250°F (121°C) and 300°F (149°C). Maximum recovery time should not exceed 1:40 for electric or 2:25 for gas. If the **INFO** button is pressed and held for three seconds it shows information such as usage, filter statistics and last cook cycles (see page 4-34 for more details on the **INFO** button).

4.7.3 Cook Channel and Selection Buttons

The ✓ ✕ buttons are dual-function buttons shared with the number **1** and **2** buttons. They are located directly below the LED displays. Use these buttons to select or cancel functions. The ✕ button is used to back out of and exit submenus.

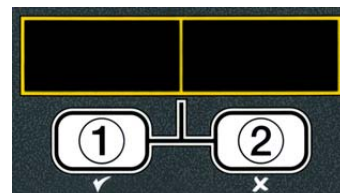

4.8 M3000 Menu Summary Tree

Reflected below are the major programming sections in the M3000 and the order in which submenu headings will be found under the sections in the Installation and Operation Manual.

Adding New Product Menu Items (Product Selection)	See section 4.10.2
Storing Product Menu Items in Product Buttons	See section 4.10.3
Draining, Refilling, and Disposing of Oil	See section 4.10.4

Filter Menu 4.11

- [Press and hold ◀ FLTR or FLTR ▶]
- Auto Filter
- Maint Filter
- Dispose
- Drain to Pan
- Fill Vat from Drain Pan
- Fill Vat from Bulk (Bulk Only)
- Pan to Waste (Bulk Only)

Programming

Level 1 Program 4.12

- [Press and hold TEMP and INFO buttons, 2 beeps, displays Level 1, enter 1234]
- Product Selection 4.10.2
 - Name
 - Cook Time
 - Temp
 - Cook ID
 - Duty Time 1
 - Duty Time 2
 - Qual Tmr
 - AIF Disable
 - Assign Btn
- AIF Clock 4.12.1
 - Disabled
 - Enabled
- Deep Clean Mode 4.12.2
- High-Limit Test 4.12.3
- Fryer Setup 4.9

Level 2 Program (Manager Level) 4.13

- [Press and hold TEMP and INFO buttons, 3 beeps, displays Level 2, enter 1234]
- Prod Comp Sensitivity for product 4.13.1
- E-Log Log of last 10 error codes 4.13.2
- Password Setup Change passwords 4.13.3
 - Setup [enter 1234]
 - Usage [enter 4321]
 - Level 1 [enter 1234]
 - Level 2 [enter 1234]
- Alert Tone Volume and Tone 4.13.4
 - Volume 1-9
 - Tone 1-3
- Filter After Sets number of cooks before filter prompt 4.13.5
- Filter Time Sets amount of time between filter cycles 4.13.6

Info Mode 4.14

- [Press and hold INFO for 3 seconds, displays Info Mode]
- Full/Split Vat Configuration
 - Filter Stats 4.14.1
 - Review Usage 4.14.2
 - Last Load 4.14.3

4.9 Fryer Setup Mode Programming

The computer, upon initial power up, when changing out a computer or accessed from Level 1, can have parameters set. The setup sets the time, date, date format, language, fryer type, vat type, oil system type and the temperature scale. These settings should only be changed by a technician.

The computer displays **OFF**.

1. Enter Level 1 programming mode by pressing the **TEMP** and **INFO** buttons simultaneously until **LEVEL 1** is displayed. The computer displays **ENTER CODE**.



2. Enter **1234**.

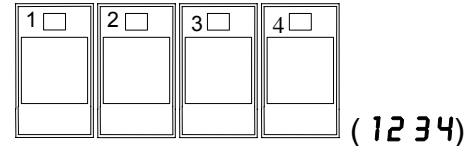

The computer displays **LEVEL 1 PROGRAM** for three seconds changing to **PRODUCT SELECTION**.

3. Press the **▲** button once to scroll to **FRYER SETUP**.
4. Press the **✓ (1 YES)** button.



The computer displays **ENTER CODE**.

5. Enter **1234**.

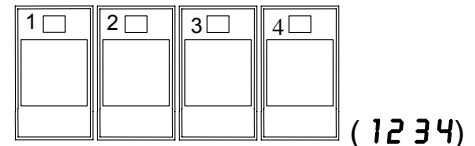

The computer displays **LANGUAGE** on the left and **ENGLISH** on the right.

6. Use the **◀** and **▶** buttons to scroll through the language menu.



7. With the desired language selection displayed, press the **✓ (1 YES)** button.



The computer displays **TEMP FORMAT** on the left and **F** on the right.

8. Use the **◀** and **▶** buttons to toggle between **F** and **C** temperature scales.



NOTE: **F** is used for Fahrenheit, **C** is used for Celsius.

9. With the desired selection displayed, press the **✓ (1 YES)** button.



The computer displays **TIME FORMAT** on the left and **12 HR** on the right.

10. Use the ◀ and ▶ buttons to toggle between **12HR** and **24HR**.



11. With the desired selection displayed, press the ✓ (1 **YES**) button .

The computer displays **ENTER TIME** on the left and current time on the right in **HH:MM** format. AM or PM is displayed if 12 hours system is chosen.

Example: 7:30 AM is entered 0730 if using the 12 hour format. 2:30 is entered 1430 if using 24 hour format. To change AM and PM use the ▲ ▼ buttons.

12. Enter time in hours and minutes using the number buttons 0-9.



13. With the desired selection displayed, press the ✓ (1 **YES**) button.



The computer displays **DATE FORMAT** on the left and **US** on the right.

14. Use the ◀ and ▶ buttons to toggle between **US** and **INTERNL**.



15. With the desired selection displayed, press the ✓ (1 **YES**) button.

The computer displays **ENTER DATE** on the left and **MM-DD-YY OR DD-MM-YY** on the right changing to the current date.

Example:

US Format – Dec. 5, 2008 is entered as 120508.

International Format – 5 Dec. 2008 is entered as 051208

16. Enter the date using the number buttons 0-9.



17. With the desired selection displayed, press the ✓ (1 **YES**) button.



The computer displays **FRYER TYPE** on the left and **ELEC** on the right.

18. Use the ◀ and ▶ buttons to toggle between **ELEC** and **GAS**.



19. With the desired selection displayed, press the ✓ (1 **YES**) button.

The computer displays **VAT TYPE** on the left and **SPLIT** on the right.

20. Use the ◀ and ▶ buttons to toggle between **SPLIT** and **FULL**.



21. With the desired selection displayed, press the ✓ (1 **YES**) button.

The computer displays **OIL SYSTEM** on the left and **JIB** on the right.

22. Use the ◀ and ▶ buttons to toggle between **JIB** and **BULK**.



NOTE: A **JIB** system uses a disposable JIB (Jug in a Box). A **BULK** system has large storage oil tanks that are connected to the fryer that fills a reservoir.

23. With the desired selection displayed, press the ✓ (1 **YES**) button.



The computer displays **LANGUAGE** on the left and **ENGLISH** on the right. Use the ▲ ▼ buttons to scroll and edit any additional fields.

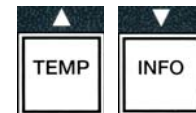

24. Press the ✕ (2) button to exit.



The computer displays **SETUP COMPLETE** changing to **OFF**.

4.10 M3000 Common Tasks

Covered in this section are common tasks used in stores:

1. Escaping out of a menu or sub-menu.
2. Adding new product items.
3. Storing menu items in product buttons.
4. Draining, disposing and refilling the vats.

4.10.1 Escape Menu Items

To escape or back out of **MENUS** and **SUB-MENUS**, press the ✕ (2) button.



4.10.2 Adding New Product Items to the Menu (PRODUCT SELECTION)

This function is used to add additional products to the computer menu.

To add a new product to the menu:

1. With the computer **OFF**, enter Level 1 programming mode by pressing the **TEMP** and **INFO** buttons simultaneously until **LEVEL 1** is displayed.



The computer displays **ENTER CODE**.

2. Enter **1234**.

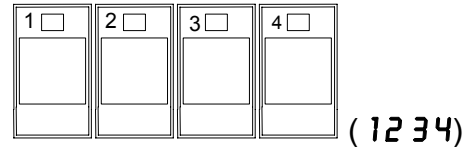

The computer displays **LEVEL 1 PROGRAM** for three seconds changing to **PRODUCT SELECTION**.

3. With **PRODUCT SELECTION** displayed, press the ✓ (1 **YES**) button to select a menu item.



The computer displays **PRODUCT SELECTION** for three seconds then displays **SELECT PRODUCT**.

4. With **SELECT PRODUCT** displayed on the left and **FR FRIES** displayed on the right use the ▼ button to advance through menu items until the menu item to be modified or a numbered spot is displayed (ex. **PROD 13**).



5. Press the ✓ (1 **YES**) button to select the product to modify.



The computer displays **MODIFY?** alternating with **YES NO**.





6. Press the ✓ (1 **YES**) button to modify selection or the ✕ (2 **NO**) button to return to **PRODUCT SELECTION**.

If yes is chosen, left display shows **NAME** and the right display shows product name (ex. **PROD 13**). The right display will show a blinking character.

7. Using the number keys, enter the first letter of the new product. Each key has three letters. Press until derived letter is displayed.



The full product name is limited to eight characters including spaces (ex. FR FRIES).

8. Press the  button to advance the cursor to the next display space. Use the #0 key to insert a space. The  button can be used to move the cursor back.



For example, to enter “**WINGS**”, press the #8 key two times until **W** appears in the display. Then use the  button to advance the cursor to the next display space. Press the #3 key until **I** appears. Continue on until **WINGS** is spelled out on the display.

9. Once the name appears as it is to be saved, press the  button to save the name and scroll to **COOK TIME**.



10. With **COOK TIME** displayed on the left and **:00** displayed on the right, use the number keys to enter the product cook time in minutes and seconds (ex. 3:10 as 310).



11. With the cook time entered, press the  (**INFO**) button to save the **COOK TIME** and scroll to **TEMP** (cook temperature).



12. With **TEMP** displayed on the left and **32F** displayed on the right, use the number keys to enter the cook temperature for the product (ex. 335° as 335).



13. With the cook temperature entered, press the  (**INFO**) button to save the cook temperature value and scroll to the **COOK ID**.



14. With **COOK ID** displayed on the left and a blinking **P 13** displayed on the right, use the instructions in step eight to enter a four-letter name for the menu item. This is the shortened name that alternates with the cook time during a cook cycle.

15. With the correct cook ID abbreviation entered, press the  (**INFO**) button to save the cook ID abbreviation and scroll to the **DUTY TIME 1** (Shake Time), which is used to set the time in the cook cycle the product should be shaken.



16. With **DUTY TIME 1** displayed on the left and **:00** displayed on the right, use the number keys to enter the time in minutes and seconds for the first duty to be performed (ex. shake the product after 30 seconds is entered as 30).



17. With **DUTY TIME 1** (shake time) entered, press the ▼ (**INFO**) button to save duty time one and scroll to **DUTY TIME 2**. If a product calls for a second duty to be preformed, it can be entered here. Use the instructions above to enter duty time two, otherwise press the ▼ (**INFO**) button to save the duty time and scroll to **QUAL TMR** (Quality Timer), which is used to set the hold time before the food is to be discarded.



18. With **QUAL TMR** displayed on the left and **:00** displayed on the right use the number keys to enter the time in minutes and seconds for the product hold time (ex. 7:00 minutes as 700).



19. With **QUAL TMR** (hold time) entered, press the ▼ (**INFO**) button to save the quality time and scroll to **AIF DISABLE**



20. With **AIF DISABLE** displayed on the left and **NO** displayed on the right use the ◀ and ▶ buttons to toggle between **YES** and **NO**. This feature, if set to yes, disables the AIF (auto intermittent filtration) for the programmed product. This is used to prevent co-mingling of product-specific oils.



21. If the **AIF DISABLE** selection is set to **NO** press the ▼ (**INFO**) button to save the AIF disable selection and scroll to the **ASSIGN BTN** selection.



The computer displays **ASSIGN BTN** on the left and the chosen product on the right.



To assign the entered product to a button, follow instructions below.

22. With the chosen product displayed on the right, and **ASSIGN BTN** on the left, press a button between 1-0 to assign the product. The LED in the chosen product button will illuminate (see photo above). To unassign a product from a button, press the button assigned to that product. The LED no longer illuminates.

23. Once the button is assigned, press the ▼ (**INFO**) button to save the assigned button.



The computer displays **NAME** on the left with the product (ex. **WINGS**) on the right.



* Note: If additional programming, to add other products, is necessary press the * (**2**) button once and then the ▼ button and return to step 4.

24. If no further programming is necessary, press the *** (2)** button. The computer displays the **SELECT PRODUCT** option with the product (ex. **FR FRIES**) on the right screen. Press the *** (2)** button again. Computer displays **LEVEL 1 PROGRAM** changing to the **PRODUCT SELECTION** prompt.



25. Press the *** (2)** button to quit and to return to **OFF**.



4.10.3 Storing Menu Items in Product Buttons

This function is used to store individual menu items to product buttons for one or two button cooking.

To store menu items to a specific button:

1. Perform steps 1-6 on pages 4-12.
2. The computer displays **NAME** on the left and the selected product (ex. **WINGS**) on the right.

3. Press the **▲** button to scroll to the **ASSIGN BTN** option used to assign a menu item to a specific product button.



4. The computer displays **ASSIGN BTN** on the left and **WINGS** on the right.

5. With **ASSIGN BTN** displayed on the left and the chosen product (ex. **WINGS**) displayed on the right, press a button between 1-0 to assign the product. The LED in the chosen product button will illuminate. To unassign a product from a button, press the button assigned to that product. The LED no longer illuminates.



6. Once the button is assigned, press the **▼ (INFO)** button to save the assigned button.



The computer displays **NAME** on the left with the product (ex. **WINGS**) on the right.

7. If no further programming is necessary, press the *** (2)** button twice to return to **LEVEL 1 PROGRAM** changing to the **PRODUCT SELECTION** prompt.



8. Press the *** (2)** button again to quit and to return to **OFF**.

4.10.4 Draining and Refilling Vats, and Disposing of Oil

When cooking oil is exhausted, drain the oil into an appropriate container for transport to the disposal container. Frymaster recommends a McDonald's Shortening Disposal Unit (MSDU). **Do not drain deep clean (boil-out) solution into an MSDU.** **NOTE:** If using an MSDU built before January 2004 the filter pan cover must be removed to allow the unit to be positioned beneath the drain. To remove the cover, lift up on the front edge slightly and slip the oil guard up and pull it straight out of the cabinet. Refer to the documentation furnished with your disposal unit for specific operating instructions. If a shortening disposal unit is not available, allow the oil to cool to 100°F (38°C), then drain the oil into a **METAL** container with a capacity of FOUR gallons (15 liters) or larger to prevent oil from spilling.

4.10.4.1 Disposal for Non-Bulk Oil Systems

This option is used to dispose of old oil into either an MSDU or a **METAL** pot.

1. Remove the filter pan and position the MSDU or **METAL** container with a capacity of **FOUR** gallons (15 liters) or larger under the fryer to drain the oil.
2. With the computer **OFF**, press and hold the **FLTR** button of the



The computer displays **FILTER MENU** for three seconds, changing to **MAINT FILTER**.

3. With **MAINT FILTER** displayed, press the ▼ (**INFO**) button to scroll to **DISPOSE**.



Computer displays **DISPOSE**.

4. Press the ✓ (**1 YES**) button to continue.



The computer display alternates between **DISPOSE?** and **YES NO**.

5. To dispose press the ✓ (**1 YES**) button to continue.



⚠ WARNING

NEVER drain deep clean (boil-out) solution into an MSDU. Deep Clean (boil-out) solution can cause damage to an MSDU.

⚠ DANGER

When draining oil into a disposal unit, do not fill above the maximum fill line located on the container.

⚠ DANGER

Allow oil to cool to 100°F (38°C) before draining into an appropriate **METAL** container for disposal.

⚠ DANGER

When draining oil into an appropriate METAL container, make sure the container will hold at least FOUR gallons (15 liters) or more, otherwise hot liquid could overflow and cause injury.

The computer displays *INSERT DISPOSAL UNIT*. Once the filter pan is removed the computer displays alternating with *IS DISPOSE UNIT IN PLACE?* and *YES NO*.

6. With the MSDU or a **METAL** container with a capacity of **FOUR** gallons (15 liters) or larger is in place, press the ✓ (**1 YES**) button to continue.



The heating source is disabled, the drain valve opens and the computer displays *DISPOSING* for 20 seconds.

The drain valve remains open and the computer displays *VAT EMPTY?* alternating with *YES*.



7. With the vat empty, press the ✓ (**1 YES**) button to continue .

The computer displays *CLN VAT COMPLETE?* alternating with *YES*.



8. Clean the vat with a scrub brush and when complete press the ✓ (**1 YES**) button to continue.

The drain valve closes and the vat is ready to be refilled with oil. Continue to next section if fryer is set to JIB.

4.10.4.2 Refilling JIB Oil Systems

JIB (Jug In Box) oil systems use oil stored in boxed jugs inside the fryer cabinet.

If the oil system was set to JIB during initial setup, the computer displays *MANUAL FILL VAT* alternating with *YES*.

1. Carefully pour oil into the pot until it reaches the low fill line in the fryer.

2. Press the ✓ (**1 YES**) button when vat is full.

The computer displays *OFF*.



4.10.4.3 Draining and Disposing Oil using Bulk Oil Systems

Bulk oil systems use a pump to move exhausted oil from the fryer to a holding tank. Additional plumbing is used to connect the bulk oil systems to the fryers.

⚠ WARNING

Ensure a filter pad is in place prior to draining or disposing of oil. Failure to insert a filter pad may result in clogged lines and/or pumps.

1. With the computer **OFF**, press and hold the **FLTR** button of the corresponding vat for three seconds.



The computer displays **FLTR MENU** for three seconds changing to **AUTO FILTER**.

2. Press the **▼ (INFO)** button and scroll to **DISPOSE**.
3. With **DISPOSE** displayed, press the **✓ (1 YES)** button to continue.



The computer display alternates between **DISPOSE?** and **YES NO**.

If the computer displays **RTI TANK FULL** alternating with **CONFIRM** see ***NOTE** on Page 4-19.



4. To dispose press the **✓ (1 YES)** button to continue.

If **INSERT PAN** is displayed, remove and replace the filter pan, ensuring that the pan is seated firmly into the fryer.



The computer displays **DRAINING**.

The drain valve remains open and the computer displays **VAT EMPTY?** alternating with **YES**.



5. When the vat is empty, press the **✓ (1 YES)** button to continue.

The computer displays **CLN VAT COMPLETE?** alternating with **YES**.

6. Clean the vat with a scrub brush and when complete press the **✓ (1 YES)** button to continue.



The computer displays **OPEN DISPOSE VALVE**.

7. Open the left cabinet door and unlock the valve if necessary. Pull the dispose valve completely forward to start disposal.



The computer displays **DISPOSING** for four minutes.

The pump transfers the waste oil from the pan to the bulk oil waste tanks.

When finished, the computer displays **REMOVE PAN**.

8. Remove the filter pan and ensure the pan is empty.

The computer display alternates between **IS PAN EMPTY?** and **YES NO**

9. Insert filter pan and press the **✕ (2)** button to run the pump again if the pan has oil remaining; otherwise continue to the next step.



10. Once the pan is empty, press the **✓ (1)** button.



The computer displays **CLOSE DISPOSE VALVE**.

11. Close the dispose valve by pushing the valve handle toward the rear of the fryer until it stops. Relock the valve if required by your manager.



The vat is ready to be refilled with oil. Continue to Section 4.10.4.4 to fill the vat, otherwise press the *** (2)** button to exit.

***NOTE:** If the computer displays **RTI TANK FULL** alternating with **CONFIRM** press the **✓ (1)** button and call the bulk oil waste provider. The display returns to **OFF**.

4.10.4.4 Refilling the Vat from Bulk Oil Systems after Disposal

The computer displays **FILL POT FROM BULK?** alternating with **YES NO**.

The bulk oil refill pump uses a momentary switch. It only pumps when the switch is depressed.

1. Press and hold the **✓ (1 YES)** button to refill the vat until the oil reaches the lower fill line.
2. With the vat full, release the **✓ (1 YES)** button.
3. Press the *** (2)** button, when the vat is full, to close the fill valve.



The computer displays **OFF**.

4.11 Filter Menu

The filter menu selections are used for filtering, draining, filling and disposing.

4.11.1 Accessing the Filter Menu

1. Press and hold the filter button for the selected vat for three seconds.



The computer displays **FILTER MENU** for three seconds, changing to **MAINT FILTER**.

2. Press the **▲** and **▼** buttons to scroll between:
 - a. **AUTO FILTER** See pg. 5-2
 - b. **MAINT FILTER** See pg. 5-8
 - c. **DISPOSE** See pg. 4-16
 - d. **DRAIN TO PAN** See pg. 4-20
 - e. **FILL VAT FROM DRAIN PAN** See pg. 4-21
 - f. **FILL VAT FROM BULK** See pg. 4-22
 - g. **PAN TO WASTE** See pg. 4-23

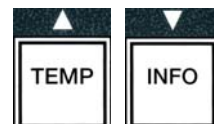

The first two menu items: **AUTO FILTER** and **MANTAINENCE (MANUAL) FILTER** are covered in Chapter 5. The other menu items are covered on the following pages.

The **DRAIN TO PAN** and **FILL VAT FROM DRAIN PAN** functions are used primarily for diagnostic purposes. They are used when oil is to be drained to the pan or returned to the frypot.

4.11.2 Drain to Pan

The drain to pan function drains the oil from the frypot to the filter pan.

1. With the computer **OFF**, press and hold the filter button for three seconds, for the selected vat to drain.



The computer displays **FILTER MENU** for three seconds, changing to **MAINT FILTER**.

2. Use the **▲** and **▼** buttons to scroll to **DRAIN TO PAN**.

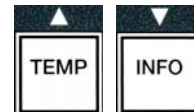

3. With **DRAIN TO PAN** displayed, press the **✓ (1)** to continue.

The computer displays **DRAIN TO PAN?** alternating with **YES NO**.



4. Press the **✓ (1 YES)** to continue drain to pan.

The heating source is disabled and the system checks that the pan is in place. If no pan is detected, the computer displays **INSERT PAN** until the pan is detected.

With the pan detected, the drain valve opens. The computer displays **DRAINING** for 20 seconds.

The computer displays **VAT EMPTY?** alternating with **YES**.

5. Press the **✓ (1 YES)** button if the vat is empty to continue.



The computer displays **FILL VAT FROM DRAIN PAN?** alternating with **YES NO** with an audible alarm. To refill the vat continue to the next step, otherwise skip to step 8.

6. Press the **✓ (1 YES)** button to refill the vat.



The computer displays **FILLING**. After filling the computer displays **IS VAT FULL?** alternating with **YES NO**.

If the vat is not full press the *** (2 NO)** button to run the filter pump again.



7. Press the **✓ (1 YES)** button if the vat is full to return to **OFF**.

8. Press the *** (2 NO)** button.



The computer displays **REMOVE PAN**.

⚠ DANGER

Open the filter pan slowly to avoid splashing of hot oil that may cause severe burns, slipping and falling.

9. Carefully pull the filter pan from the fryer.

The computer displays *IS PAN EMPTY?* alternating with *YES NO*.



NOTE: A small quantity of oil may remain in the pan after refilling.

10. If the pan is empty, press the ✓ (1 *YES*) button to return to *OFF*.

If the pan is not empty, press the ✖ (2 *NO*) button (see Figure 4.11.2.10) and return to *FILL VAT FROM DRAIN PAN?* alternating with *YES NO* after step 5.



If the pan is not empty and the fryer is using a bulk oil system, press the ✖ (2 *NO*) button and the computer displays *PAN TO WASTE?* alternating with *YES NO*.

11. Press the ✓ (1 *YES*) button to dispose of the oil to the bulk oil waste tanks. Skip to section 4.10.4.3 Disposing Oil Using Bulk Systems between step 6 and step 7.



4.11.3 Fill Vat from Drain Pan

Fill vat from drain pan selection is used to refill the frypot from the filter pan.

1. With the computer *OFF*, press and hold the filter button for the vat to be refilled for three seconds.



The computer displays *FILTER MENU* for three seconds, changing to *MAINT FILTER*.

2. Use the ▲ and ▼ buttons to scroll to *FILL VAT FROM DRAIN PAN*.

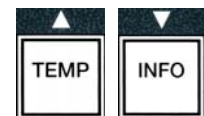

3. With *FILL VAT FROM DRAIN PAN* displayed, press the ✓ (1 *YES*) to continue.



The computer displays *FILL VAT FROM DRAIN PAN?* alternating with *YES NO*.

4. Press the ✓ (1 *YES*) button to continue.



System checks that the drain valve is closed. The return valve opens and the filter pump refills the vat.

The computer displays **FILLING** while the vat is refilling. After filling the computer displays **IS VAT FULL?** alternating with **YES NO**.

5. Press the ✓ (**1 YES**) button if vat is full to exit and return to **OFF**. If vat is not full press ✕ (**2 NO**) button to continue filling.



4.11.4 Fill Vat from Bulk

Fill vat from bulk selection is used when filling the frypot from a bulk oil system.

1. With the computer **OFF**, press and hold the filter button for the vat to be refilled for three seconds.



The computer displays **FILTER MENU** for three seconds, changing to **MAINT FILTER**.

2. Use the ▲ and ▼ buttons to scroll to **FILL VAT FROM BULK**.

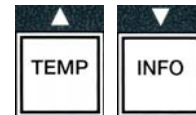

3. With **FILL VAT FROM BULK** displayed, press the ✓ (**1 YES**) button to continue.



The computer displays **FILL VAT FROM BULK?** alternating with **YES NO**.

4. Press the ✓ (**YES**) button to continue.



The computer displays **PRESS AND HOLD YES TO FILL** alternating with **YES**.

The return valve opens and the bulk pump is energized. The bulk oil refill pump uses a momentary switch. It only pumps as long as the switch is depressed.

5. Press and hold the ✓ (**YES**) button to fill the vat.



The computer displays **FILLING** while the vat is filling.

6. When the vat is filled to the lower fill line, release the ✓ (**1 YES**) button.

The computer displays **CONTINUE FILLING?** alternating with **YES NO**.



7. To continue filling return to step 5. Otherwise, press the ✕ (**2 NO**) button to exit and return to **OFF**.

4.11.5 Pan to Waste

Pan to waste selection is an option that allows bulk oil systems to pump excess oil in the pan to the bulk oil waste tanks without draining the existing oil in the frypot.

1. With the computer **OFF**, press and hold the filter button for the vat to be refilled for three seconds.



The computer displays **FILTER MENU** for three seconds, changing to **MAINT FILTER**.

2. Use the **▲** and **▼** buttons to scroll to **PAN TO WASTE**.

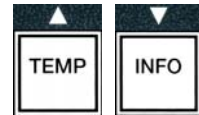

3. With **PAN TO WASTE** displayed, press the **✓ (1 YES)** button to continue.



The computer displays **PAN TO WASTE P** alternating with **YES NO**.

4. Press the **✓ (YES)** button and go to Section 4.10.4..3 page 4-18 and continue after step 6 or press *** (2 NO)** button to exit to filter menu.



4.12 Programming Level One

Level one programming is used to enter new products, control when AIF (auto intermittent filtration) is disabled and perform deep clean (boil-out) and high-limit test.

To enter Level 1 programming mode:

1. With the computer **OFF**, press the **TEMP** and **INFO** buttons simultaneously for **THREE** seconds until **LEVEL 1** is displayed; a chirp sounds.



The computer displays **ENTER CODE**.

2. Enter **1234**.

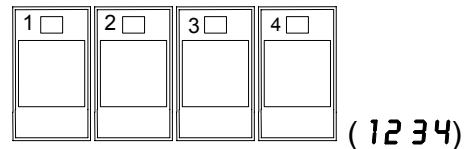

The computer displays **LEVEL 1 PROGRAM** for three seconds changing to **PRODUCT SELECTION**.

3. Press the ▲ and ▼ buttons to scroll between:

- a. **PRODUCT SELECTION** See pg. 4-12
- b. **AIF CLOCK** See pg. 4-24
- c. **DEEP CLEAN MODE** See pg. 4-25
- d. **HI LIMIT TEST** See pg. 4-30
- e. **FRYER SETUP** See pg. 4-9

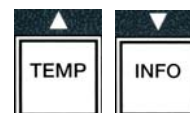

4. With the selection displayed, press the ✓ (1 YES) button to select chosen menu item.



4.12.1 AIF CLOCK

The AIF Clock mode allows programming of times to lock out the AIF (auto intermittent filtration) prompt. This is useful for busy times of the day, like the noon rush.

1. Perform steps 1-3 on page 4-23 through 4-24.
2. Use the ▼ (INFO) button to scroll to **AIF CLOCK**.
3. Press the ✓ (1 YES) button to continue.



The computer displays **AIF CLOCK** on the left and **DISABLED** on the right.

4. Use the ◀ and ▶ buttons to toggle between:
 - a. **DISABLED**
 - b. **ENABLED**



Set this function to **ENABLED** if there are times in which the AIF (auto intermittent filtration) feature is disabled (ex. noon rush).

5. With **ENABLED** displayed, press the ▼ button.



*Skip to step 12 if **DISABLED** is chosen.

6. With **ENABLED** displayed, press the ▲ and ▼ buttons (see Figure 4.12.2.5) to scroll between **M-F 1** thru **SUN 4**. (ex. On Monday – Friday no filtering is desired during a lunch rush from 11:30 AM until 1:30 PM. On the computer scroll to **M-F 1 12:00 AM**.)

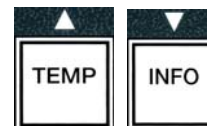

7. Using the number keys enter the start time when AIF should be suspended.



8. Press the ▲ and ▼ buttons to toggle from AM to PM.

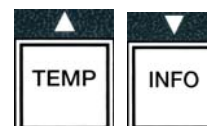

9. Press the ▼ (INFO) button. The computer displays **0 DUR**. This is the amount of time the AIF is to remain suspended.



10. Use the number keys to enter a time between 0 and 999 minutes (ex. 1½ hours is entered as 90 minutes). Enter **90** for this example. The computer displays **090 DUR**. Four different time periods to suspend filtration are available for each day or set of days. (M-F 1-4, Sat 1-4 and Sun 1-4)



11. Press the ▼ (INFO) button to accept time and move to the next time period.



12. When finished, press the ✖ button once to exit and return to **PRODUCT SELECTION** display.



13. Press the ✖ (2) button to quit and to return to **OFF**.



4.12.2 DEEP CLEAN MODE (BOIL-OUT)

The deep clean mode is used to remove carbonized oil from the frypot.

NOTE: Refer to Kay Chemical “Fryer Deep Clean Procedure” instructions to clean the LOV™ fryer.

1. Perform steps 1-3 on page 4-23 through 4-24.

The computer displays **DEEP CLEAN MODE**.

2. Press the ✓ (1 YES) button.



Bulk Oil System: Ensure a complete and clean filter pan is in place.

JIB Oil System: Ensure an MSDU or suitable metal container is in place under the drain with a capacity of **FOUR** gallons (15 liters) or more.

The computer displays **DEEP CLEAN?** alternating with **YES NO**.

3. Press the ✓ (1 YES) button.



4. **Full Vat:** Computer displays **IS OIL REMOVED?** alternating with **YES NO**.



Split Vat: Computer displays **DEEP CLEAN** alternating with **L R**.

Press the ✓ (1) or ✖ (2) button under the split vat to be cleaned. The computer displays **IS OIL REMOVED?** alternating with **YES NO***.



*If the bulk oil system waste tank is full, the computer displays **RTI TANK FULL** alternating with **CONFIRM**. Press the ✓ (1) button and call the bulk oil waste provider. The display returns to **OFF**.

⚠ DANGER

When draining oil into a disposal unit, do not fill above the maximum fill line located on the container.

⚠ DANGER

Allow oil to cool to 100°F (38°C) before draining into an appropriate METAL container for disposal.

⚠ DANGER

When draining oil into an appropriate MSDU or METAL container, make sure the container will hold at least FOUR gallons (15 liters) or more. Otherwise oil could overflow and can cause injury.

5. **Empty fry vat:** Press the ✓ (1 **YES**) button and skip to step 12.

Oil-filled Fry Vat: Press the ✖ (2 **NO**) button.



6. **JIB Oil System:** The computer displays **IS DISPOSAL UNIT IN PLACE?** alternating with **YES NO**. Ensure an MSDU or suitable metal container is in place under the drain with a capacity of **FOUR** gallons (15 liters) or larger is in place. Press the ✓ (1 **YES**) button to dispose the oil. The computer displays **DISPOSING** ending with **VAT EMPTY?** alternating with **YES**. Press the ✓ (1 **YES**) button and skip to step 12.



Bulk* Oil System: Computer displays **DRAINING**. Once the oil has drained into the filter pan the computer displays **VAT EMPTY?** alternating with **YES**. Press the ✓ (1 **YES**) button and continue.



*If **INSERT PAN** is displayed, remove and replace the filter pan.

Bulk Oil System: The computer displays **OPEN DISPOSE VALVE**.

7. **Bulk Oil System:** Open the left cabinet door and unlock the lock if necessary. Pull the dispose valve completely forward to start disposal.

Bulk Oil System: The computer displays **DISPOSING** for four minutes.

The pump transfers the waste oil from the pan to the bulk oil waste tanks.

Bulk Oil System: When finished, the computer displays **REMOVE PAN**.

8. **Bulk Oil System:** Remove the filter pan and ensure the pan is empty.

Bulk Oil System: The computer display alternates between **IS PAN EMPTY?** and **YES NO**

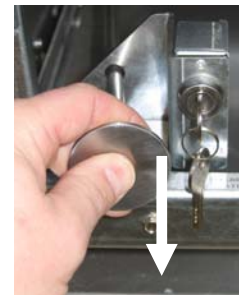

9. **Bulk Oil System:** Press the ✖ (2) button to run the pump again if the pan has oil remaining; otherwise continue to the next step.



10. **Bulk Oil System:** Once the pan is empty, press the ✓ (1) button (see Figure 4.10.4.3.10).



Bulk Oil System: The computer displays *CLOSE DISPOSE VALVE*.

11. **Bulk Oil System:** Close the dispose valve by pushing the valve handle until it stops.



Bulk Oil System: The computer displays *INSERT PAN*. Insert the pan.

12. **Bulk or JIB System:** The drain valve closes and the computer displays *SOLUTION ADDED?* alternating with *YES*. Fill frypot to be cleaned with water and cleaning solution mix. Referring to maintenance requirement card and Kay Chemical provided instructions “Fryer Deep Clean Procedure” for McDonald’s deep clean (boil-out) procedure.

13. **Bulk or JIB System:** Press the ✓ (1 YES) button to continue and start the cleaning procedure.



The computer displays *DEEP CLEAN*, alternating with a countdown timer starting at 60:00 minutes on the display. The vat heats to 195° F (91° C) for one hour. To cancel DEEP CLEAN, press and hold the ✖ (2) button for three seconds. The computer displays *IS SOLUTION REMOVED?* alternating with *YES*. Skip to step 15.

After one hour the heater shuts off and the computer displays *CLEAN DONE* with an alarm.

14. **Bulk or JIB System:** Press the ✓ (1 YES) button to silence the alarm.



15. **Bulk or JIB System:** The computer displays *IS SOLUTION REMOVED?* alternating with *YES*. Remove solution following Kay Chemical instructions.

16. **Bulk or JIB System:** Remove the filter pan and remove crumb basket, hold-down ring, filter pad and screen. Replace empty filter pan in fryer.

⚠ DANGER

Allow deep-clean (boil-out) solution to cool to 100°F (38°C) before disposal, otherwise hot liquid can cause injury.

NOTE: Refer to Kay Chemical provided instructions “Fryer Deep Clean Procedure” for instructions to remove cleaning solution.

17. **Bulk or JIB System:** Once the solution is removed, press the ✓ (1 YES) button.



18. **Bulk or JIB System:** The computer displays **SCRUB VAT COMPLETE?** alternating with **YES**. Press the ✓ (1 YES) button.



19. **Bulk or JIB System:** The computer displays **DRAINING**. The drain opens to drain the small amount of residual solution left in the vat. Rinse excess solution from vat.

20. **Bulk or JIB System:** The computer displays **RINSE COMPLETE?** alternating with **YES**. Press the ✓ (1 YES) button to continue when the vat is completely rinsed.



21. **Bulk or JIB System:** The computer displays **REMOVE PAN**. Remove the filter pan.

22. **Bulk or JIB System:** The computer displays **VAT AND PAN DRY?**, alternating with **YES**. Ensure the vat and pan are completely dry.

DANGER

Ensure that the frypot and filter pan are completely dry and free of water before filling with oil. Failure to do so will cause splattering of hot liquid when the oil is heated to cooking temperature.

23. **Bulk or JIB System:** The computer displays **INSERT PAN**. Reinstall screen, filter pad, hold down ring and crumb basket removed in step 16. Insert the filter pan.

24. **JIB system:** The computer displays **MANUAL FILL** alternating with **YES**. Press the ✓ (1 YES) button and display returns to **OFF**.



Bulk system: Go to Section 4.11.4 Fill Vat From Bulk on page 4-22 and begin after step 3.

4.12.3 HIGH-LIMIT TEST MODE

The high-limit test mode is used to test the high limit circuit. The high-limit test will destroy the oil. It should only be performed with old oil. Shut the fryer off and call for service immediately if the temperature reaches 460°F (238°C) without the second high-limit tripping and the computer displays **HIGH LIMIT FAILURE** alternating with **DISCONNECT POWER** with an alert tone during testing.

The test is cancelled at any time by turning the fryer off. When the fryer is turned back on, it returns to the operating mode and displays the product.

1. Perform steps 1-3 on pages 4-23 through 4-24.

Computer displays **HI LIMIT TEST**.

2. Press the ✓ (1 YES) button to continue the high-limit test.



The computer displays **HI-LIMIT?** alternating with **YES NO**.

3. Press the ✓ (1 YES) button to continue the test. If performing the test on a split vat press the ✓ (1 YES) button on the side which corresponds to the vat.



The computer displays **PRESS AND HOLD CHECK**.

4. Press and hold the ✓ (1 YES) button to initiate the high-limit test.



The vat begins to heat. The computer displays the actual vat temperature during the test. When the temperature reaches $410^{\circ}\text{F} \pm 10^{\circ}\text{F}$ ($210^{\circ}\text{C} \pm 12^{\circ}\text{C}$)*, the computer displays **HOT HI-1** alternating with the actual temperature (ex. **410F**) and continues heating.

***NOTE:** In computers used in the European Union (those with the CE mark), the temperature is 395°F (202°C).

The fryer continues heating until the second high limit trips. Generally this happens once the temperature reaches 423°F to 447°F (217°C to 231°C) for non-CE high limits and 405°F to 426°F (207°C to 219°C) for CE high limits.

Once the high-limit opens the computer displays **HELP HI-2** alternating with the actual temperature (ex. **430F**).

5. Release the **✓ (1 YES)** button.

If the high-limit fails, the computer displays **HIGH LIMIT FAILURE** alternating with **DISCONNECT POWER**. If this happens, disconnect power to the fryer and call for service immediately.

The vat stops heating and the computer displays the current temperature setting alternating with the actual temperature (ex. **430F**) until the temperature cools below 400°F (204°C).

6. Press the soft power button to cancel the alarm.



7. Once the temperature cools below 400°F (204°C) press the *** (2)** button once to exit the high-limit test.



8. Press the *** (2)** button again to exit to **OFF**.

9. Follow the procedures on page 4-16 to dispose of the oil.

4.13 Programming Level Two

To enter Level two programming mode:

1. With the computer **OFF** press the **TEMP** and **INFO** buttons simultaneously for 10 seconds until **LEVEL 2** is displayed; a third chirp sounds.

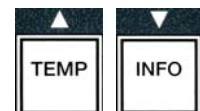

The computer displays **ENTER CODE**.

2. Enter **1234**.

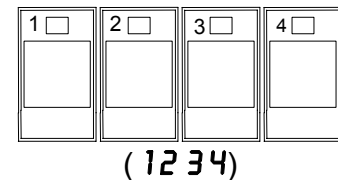

The computer displays **LEVEL 2 PROGRAM** for three seconds changing to **PRODUCT COMP**.

3. Press the ▲ and ▼ buttons to scroll between:
 - a. **PROD COMP** See pg. 4-30
 - b. **E-LOG** See pg. 4-31
 - c. **PASSWORD SETUP** See pg. 4-31
 - d. **ALERT TONE** See pg. 4-32
 - e. **FILTER AFTER** See pg. 4-33
 - f. **FILTER TIME** See pg. 4-34

NOTE:

Use the ◀ and ▶ buttons to move between positions within the selections.
 When entering numbers, press the corresponding button using the 0-9 keys.

Press the ▲ and ▼ buttons to accept input and move to the next or previous menu item.

4. With the desired selection displayed press the ✓ (1 YES) button.



4.13.1 PRODUCT COMP MODE

The product comp mode allows the product compensation (sensitivity) to be changed. Some menu items may need an adjustment, depending on their cooking characteristics. **Use caution when changing the product compensation, as it could have an adverse affect on the products cooking cycles.** The default setting for product compensation is set to four.

1. Perform steps 1-3 on pages 4-29 through 4-30.

Computer displays **PROD COMP**.



2. With **PROD COMP** displayed press the ✓ (1 YES) button.

Computer displays **PRODUCT SELECTION** changing to **SELECT PRODUCT**.

3. Use the ▲ and ▼ to scroll through the product list.



The computer displays the product selected.

4. With a product selected, press the ✓ (1 YES) button to select a product.



The computer displays **MODIFY?** alternating with **YES NO**.



5. Press the ✓ (1 YES) button to continue or the ✕ (2 NO) button to return to **LEVEL 2 PROGRAM**.

Computer displays **LOAD COMP** on left side with **4** or another value on the right. This is the sensitivity setting recommended for this product.

NOTE: It is highly recommended to NOT adjust this setting, as it could have an adverse effect on the product.

6. If changing this setting, enter a number between 0-9.



7. Press the * (2) button to accept selection.

8. Press the * (2) button two times to exit.



The computer displays **OFF**.

4.13.2 E-LOG MODE

The E-LOG mode is used to view the ten most recent error codes encountered on the fryer. These codes are displayed from 1-10 with the most recent displayed first. The time, date and error code are displayed.

1. Perform steps 1-3 on pages 4-29 through 4-30.

Computer displays **E-LOG**.



2. Press the ✓ (1 YES) button to accept selection.

Computer displays **NOW** on left and current date with current time on the right.

3. Use the ▼ button to scroll through the ten most recent error codes starting with “A” through “J”. Once the last error is displayed, use the ▲ button to scroll back to the top.



If no errors exist, the computer displays **NO ERRORS**. Errors are displayed by position A through J, the side of the error if a split vat, error code and time alternating with the date. An error code displaying and “L” indicates left side of a split vat and “R” indicates right side of a split vat where the error occurred (example –A R E06 06:34AM 12/09/08). Error codes are listed in section 7.2.5 of this manual.

4. Press the * (2) button two times to exit.



The computer displays **OFF**.

4.13.3 PASSWORD SETUP MODE

The password mode allows a restaurant manager to change passwords for various modes and levels.

1. Perform steps 1-3 on pages 4-29 through 4-30.

Computer displays **PASSWORD SETUP**.



2. Press the ✓ (1 YES) button to accept selection.

Computer displays **FRYER SETUP**.

3. Press the ▲ and ▼ buttons to scroll between:

- a. **FRYER SETUP** – Established password to enter **FRYER SETUP** mode. (Default is 1234)

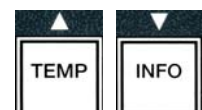

- b. **USAGE** – Established password to enter **USAGE** mode to reset usage statistics. (Default is 4321)
- c. **LEVEL 1** – Establishes password to enter **LEVEL 1** mode. (Default is 1234)
- d. **LEVEL 2** – Establishes password to enter **LEVEL 2** mode. (Default is 1234)

4. Press the ✓ (1 **YES**) button to accept selection.



The computer displays **MODIFY?** alternating with **YES NO**.

5. Press the ✓ (1 **YES**) button.



The computer displays **FRYER SETUP** on the left and **NEW PASSWORD** flashes for three seconds then **1234** or the current password is displayed on the right.

6. Using the 0-9 keys enter a new password or reenter the existing password.



7. Press the ✓ (1 **YES**) button.



The computer displays **CONFIRM** on the left and **1234** or the new password is displayed on the right.

8. Press the ✓ (1 **YES**) button to confirm.



The computer displays **PASSWORD SETUP** on the left. The right side is blank.

9. Repeat steps 3-8 to change or confirm fryer setup, usage, level one and level two passwords.

10. Press the ✕ (2) button again to exit.



The computer displays **OFF**.

4.13.4 ALERT TONE MODE

The alert tone volume is adjustable to nine levels and the tone is adjustable to three frequencies. Use different frequencies to distinguish protein or French fry stations.

1. Perform steps 1-3 on pages 4-29 through 4-30.

Computer displays **ALERT TONE**.



2. With the desired selection displayed, press the ✓ (1 **YES**) button.

The computer displays **VOLUME 1-9** on the left and **9** on the right.

- Use the number keys to set volume level. Select from nine levels of volume with 1 being the softest and 9 the loudest.



- Use the **▲** and **▼** buttons to scroll to **TONE 1-3**.

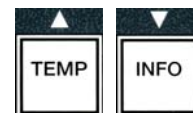

The computer displays **TONE 1-3** on the left and **1** on the right.

- Use the number keys, to set the tone frequency from 1 to 3.



- Press the *** (2)** button to return to product **LEVEL 2 PROGRAM** prompt.



- Press the *** (2)** button again to exit.



The computer displays **OFF**.

4.13.5 FILTER AFTER

The AIF filtration mode uses two measures before prompting to filter. One checks for cook cycles which is adjusted in this section and the other checks for time which is adjusted in the following section 4.13.6 FILTER TIME. The prompt for filtration is initiated by whichever occurs first; either the number of cycles elapsed or time elapsed.

The **FILTER AFTER** option is used to set the number of cooking cycles which occur before the filtration prompt is displayed.

- Perform steps 1-3 on page 4-29 through 4-30.

Scroll to **FILTER AFTER**.



- With **FILTER AFTER** displayed, press the **✓ (1 YES)** button.

The computer displays **FILTER AFTER** on the left and **0** or another number on the right.

- Use the number keys from 0 to 9 to enter the number of cook cycles before prompting to filter (ex. after every 12 cycles enter as 12).



The computer displays **FILTER AFTER** on the left and **12** on the right.

- Press the *** (2)** button to return to product **LEVEL 2 PROGRAM** prompt.



5. Press the * (2) button again to exit.

The computer displays **OFF**.



4.13.6 FILTER TIME

The **FILTER TIME** option is used to set the elapsed time before a filtration prompt. This option is useful in lower volume stores, where filtration is desired more often than the amount the cook cycles would generate.

1. Perform steps 1-3 on pages 4-29 through 4-30.

Scroll to **FILTER TIME**.



2. With **FILTER TIME** displayed, press the ✓ (1 YES) button.

The computer displays **FILTER TIME** on the left and **0** on the right.

3. Use the number keys from 0 to 9 to enter the amount of time in hours between filter prompts (ex. after every two hours, enter as 2).



The computer displays **FILTER TIME** on the left and **02** on the right.

4. Press the * (2) button to return to product **LEVEL 2 PROGRAM** prompt.



5. Press the * (2) button to exit.

The computer displays **OFF**.



4.14 INFO Mode

The **INFO** button is used to display information and navigate menus. Pressed once, it shows each vat's recovery time.

Press the **INFO** button for three seconds and it displays usage, filter statistics and last cook cycles.

To enter **INFO** mode:

1. Press the ▼ (INFO) button for three seconds.



The computer displays **INFO MODE** for three seconds changing to **FILTER STATS**.

2. Press the ▲ and ▼ buttons to scroll between:

FULL VAT CONFIGURATION

- a. **FILTER STATS** See pg. 4-35
- b. **REVIEW USAGE** See pg. 4-36
- c. **LAST LOAD** See pg. 4-37

SPLIT VAT CONFIGURATION

- a. **FILTER STATS** See pg. 4-35
- b. **REVIEW USAGE** See pg. 4-36
- c. **LAST LOAD L** See pg. 4-37
- d. **LAST LOAD R** See pg. 4-37

NOTE:

Use the ◀ and ▶ buttons to move between days within the selections.

Press the ▲ and ▼ buttons to move to other menu items.

3. With the desired selection displayed, press the ✓ (1 YES) button to select chosen menu item.



4.14.1 FILTER STATS MODE

The filter stats mode displays vat filtration counts and skipped filters by day and the average number of cook cycles per filter prompt.

1. Perform steps 1-3 on pages 4-34 through 4-35.

The computer displays **FILTER STATS**.

2. With the desired selection displayed, press the ✓ (1 YES) button.



The computer displays current day on the left side and current date on the right side.

3. Use the ◀ and ▶ buttons to scroll records; starting at the current day and going back one week.



4. Press the ▲ and ▼ buttons to scroll between:

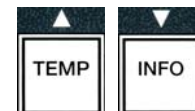

FULL VAT CONFIGURATION

- a. **DAY (TUE), DATE (07/03/07)** – Current day and date.
- b. **FILTERED # DAY.** – Number of times vat filtered and day.
- c. **FLT BPSD # DAY.** – Number of times filter was bypassed and day.
- d. **FLT AVG DAY.** – Average number of cook cycles per filter and day.

SPLIT VAT CONFIGURATION

- a. **DAY (WED), DATE (03/20/07)** – Current day and date.
- b. **L FILTERED # DAY** – Number of times left vat filtered and day.
- c. **L FLT BPSD # DAY** – Number of times left vat filter was bypassed and day.
- d. **L FLT AVG DAY** – Average number of cook cycles per filter/left vat and day.
- e. **R FILTERED # DAY** – Number of times right vat filtered and day.
- f. **R FLT BPSD # DAY** – Number of times right vat filter was bypassed and day.
- g. **R FLT AVG DAY** – Average number of cook cycles per filter/right vat and day.

5. Press the *** (2)** button to return to **INFO MODE** changing to **FILTER STATS** prompt.



6. Press the *** (2)** button again to quit.

The computer displays **OFF**.



4.14.2 REVIEW USAGE MODE

The review usage displays total cook cycles per vat, number of cook cycles per vat, number of cook cycles exited prior to completion, the number of hours the vat(s) have been on and the date of last usage reset.

1. Perform steps 1-3 on pages 4-34 through 4-35.

Scroll to **REVIEW USAGE**.



2. With **REVIEW USAGE** displayed, press the **✓ (1 YES)** button.

The computer displays **USAGE SINCE** changing to the date and time that the usage was last reset.

3. Press the **▲** and **▼** buttons to scroll between:

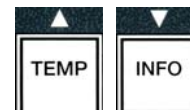

FULL VAT CONFIGURATION

- a. **USAGE SINCE TIME, DATE** – Usage since date and time of last reset.
- b. **TOTAL COOKS #** – Number of cook cycles for all products.
- c. **QUIT COOK #** – Number of cook cycles exited within first 30 seconds.
- d. **ON HRS #** – Number of hours the vat has been on.
- e. **RESET USAGE** – Resets usage counters.

SPLIT VAT CONFIGURATION

- a. **USAGE SINCE TIME, DATE** – Usage since time and date of last reset.
- b. **TOTAL COOKS #** – Number of cook cycles for all products.
- c. **QUIT COOK #** – Number of cook cycles exited within first 30 seconds.
- d. **L ON HRS #** – Number of hours the left vat has been on
- e. **R ON HRS #** – Number of hours the right vat has been on
- f. **RESET USAGE** – Resets usage counters.

- If resetting usage statistics, return to step 3 and scroll to **RESET USAGE**, otherwise skip to step 7.

The computer displays **RESET USAGE**.

- With the desired selection displayed, press the **✓ (1 YES)** button to select chosen menu item.



The computer displays **ENTER CODE**.

- Using the number keys enter **4321**. Note: Codes are changeable.

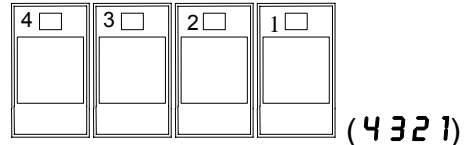

The computer displays **RESET USAGE COMPLETE** changing to **REVIEW USAGE**. Skip to step 8.

- Press the *** (2)** button to return to **INFO MODE** changing to **FILTER STATS** prompt.

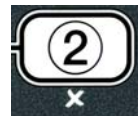

- Press the *** (2)** button to quit.

The computer displays **OFF**.



4.14.3 LAST LOAD MODE

The last load mode displays data for the last cook cycle.

- Perform steps 1-3 on pages 4-34 through 4-35.

The computer displays **LAST LOAD** for full vat configurations or **LOAD L** or **LOAD R** for split vat configurations.

- With the desired selection displayed, press the **✓ (1 YES)** button.



- Press the **▲** and **▼** buttons to scroll between:

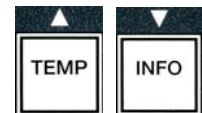

FULL / SPLIT VAT CONFIGURATION

- PRODUCT FRY** – Last product cooked.
- STARTED 02:34PM** – Time last cook cycle started.
- ACTUAL 3:15** – Actual cooking time including stretch time.
- PROGTIME 3:10** – Programmed cook time.
- MAX TEMP 337°** – Maximum oil temperature recorded during the cook cycle.
- MIN TEMP 310°** – Minimum oil temperature recorded during the cook cycle.
- AVG TEMP 335°** – Average oil temperature recorded during the cook cycle.
- HEAT ON 70** – Percentage of the cook time the heat source was on.
- READY YES** – Displays if the fryer was back to proper temperature before the cook cycle was started.

NOTE – Above numbers are examples. They do not reflect actual conditions.

4. Press the *** (2)** button to return to *INFO MODE* changing to *FILTER STATS* prompt.



5. Press the *** (2)** button again to quit.

The computer displays *OFF*.



BIGLA30 SERIES GEN II LOV™ GAS FRYER

CHAPTER 5: FILTRATION INSTRUCTIONS

5.1 Introduction

The FootPrint Pro filtration system allows the oil in one frypot to be safely and efficiently filtered while the other frypots in a battery remain in operation.

Section 5.2 covers preparation of the filter system for use. Operation of the system is covered in Section 5.3.

⚠ WARNING

The on-site supervisor is responsible for ensuring that operators are made aware of the inherent hazards of operating a hot oil filtering system, particularly the aspects of oil filtration, draining and cleaning procedures.

⚠ WARNING

The filter pad or paper MUST be replaced daily.

5.2 Preparing the Filter for Use

1. Pull the filter pan out from the cabinet and remove the crumb tray, hold-down ring, filter pad (or paper), and filter screen. (See Figure 1) Clean all metal parts with a solution of All Purpose Concentrate and hot water then dry thoroughly.

The pan cover must not be removed except for cleaning, interior access, or to allow a shortening disposal unit (MSDU) to be positioned under the drain. If using an MSDU built before January 2004 see instructions on page 4-16.

2. Inspect the filter pan connection fitting to ensure that both O-rings are in good condition. (See Figure 2)

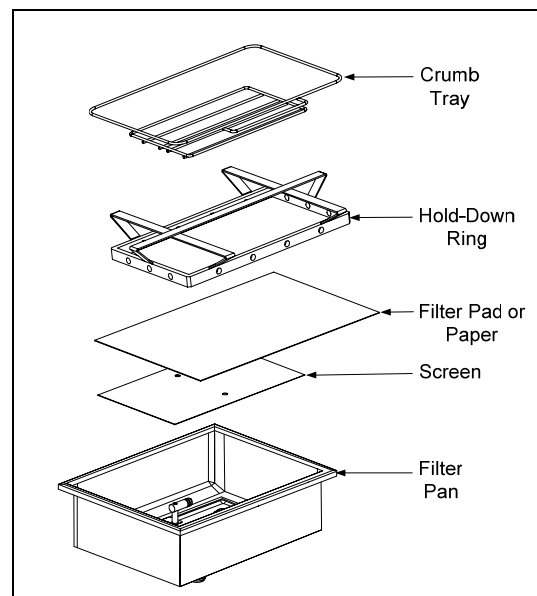

Figure 1

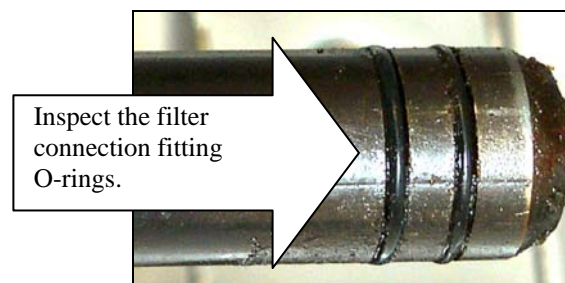

Figure 2

- Then in reverse order, place the metal filter screen in the center of the bottom of the pan, then lay a filter pad over the screen, ensuring that the **rough** side of the pad is up. Make sure that the pad is in between the embossed ridges of the filter pan. Then position the hold down ring on top of the pad. If using filter paper, lay a sheet of filter paper over the top of the pan overlapping on all sides. Position the hold down ring over the filter paper and lower the ring into the pan, allowing the paper to fold up and around the ring as it is pushed to the bottom of the pan. Then sprinkle 1 packet (8-ounces) of filter powder over the filter paper.
- Reinstall the crumb tray at the front of the pan. (See Figure 1)

DO NOT USE FILTER POWDER WITH THE PAD!

- Push the filter pan back into the fryer, positioning it under the fryer. Ensure “**F**” is displayed on the MIB board. The filtration system is now ready for use.

⚠ DANGER

Do not drain more than one frypot at a time into the built-in filtration unit to avoid overflow and spillage of hot oil that may cause severe burns, slipping and falling.

⚠ DANGER

The crumb tray in fryers equipped with a filter system must be emptied into a fireproof container at the end of frying operations each day. Some food particles can spontaneously combust if left soaking in certain shortening material.

⚠ WARNING

Do not bang fry baskets or other utensils on the fryer’s joiner strip. The strip is present to seal the joint between the fry vessels. Banging fry baskets on the strip to dislodge shortening will distort the strip, adversely affecting its fit. It is designed for a tight fit and should only be removed for cleaning.

5.3 Auto Intermittent Filtration (AIF)

Auto Intermittent Filtration (AIF) is a feature that, after a number of preset cook cycles or time, will automatically filter frypots.

An M3000 computer controls the Auto Intermittent Filtration (AIF) system on the LOV™ fryer. After a preset number of cook cycles or time the computer displays **FILTER NOW?** alternating with **YES NO**. The blue LED is activated simultaneously. The LED will turn off once a filtration cycle is started. If **NO** is selected or a cook cycle is started, the blue LED will go off and will prompt again soon to filter the oil.



- Press ✓ (1) **YES** to start filtration and ✗ (2) **NO** to cancel filtration.



If the oil level is too low, the computer displays **OIL LEVEL TOO LOW** alternating with **YES**. Press ✓ **(1) YES** to acknowledge issue and return to idle cook mode. Check to see if the JIB is low on oil. If JIB is not low and this continues to occur, contact your ASA.

If **YES** is chosen, **SKIM VAT** is displayed for ten seconds changing to **CONFIRM** alternating with **YES NO**. Skim the crumbs from the oil with a front to back motion, removing as many crumbs as possible from each vat. This is critical to optimizing usable oil life and quality in the oil.

Note: If **NO** is chosen in response to either **FILTER NOW** or **CONFIRM**, filtering is cancelled and the fryer resumes normal operation. The **FILTER NOW** prompt is displayed once the FILTER AFTER count is satisfied. This sequence repeats until yes is chosen.

If the filter pan is not fully engaged, the computer displays **INSERT PAN**. Once the filter pan is pushed fully into place, the computer displays **SKIM VAT**.

2. When ✓ **(1) YES** is chosen, the auto filtration cycle is started. The fryer displays **DRAINING**, **WASHING** and **FILLING** during the process.

Note: Simultaneous filtering of multiple vats does not occur.

Once filtering is complete the computer display changes to **LOW TEMP** until the fryer reaches setpoint.

Once fryer reaches setpoint and the computer display changes to the product name or dashed lines, the fryer is ready for use.

The complete filtering process takes roughly four minutes.

NOTE: If during filtration the filter pan is pulled, the filtration process stops and resumes once pan is reseated into place.

 **DANGER**
Keep all items out of drains. Closing actuators may cause damage or injury.

5.3.1 Auto Demand Filtration

Auto demand filtration is used to manually start an auto filtration.

1. The fryer **MUST** be at setpoint temperature.
With the computer on press and hold the **FLTR** button for three seconds.



The computer displays **FILTER MENU** for three seconds changing to **AUTO FILTER**.

2. Press the ✓ (1 YES) button to continue.

The computer displays **FILTER NOW?** Alternating with **YES/NO**.

3. Go to step 1 section 5.3 on page 5-2 to continue.



5.4 Troubleshooting the Auto Intermittent Filtration (AIF)

5.4.1 Incomplete Filtration

Should the AIF procedure fail after the filter pad was changed an error message is generated. Use the chart on page 5-6 to clear the error.

The computer displays **IS VAT FULL?** alternating with **YES NO**.

The MIB board displays three horizontal lines.

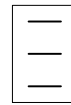

1. If the vat is full press the ✓ (1 YES) button to continue. The computer returns to idle cook mode or OFF.

If the pot is not filled completely continue to next step.

2. Press ✕ (2 NO) if pot is not filled completely.



The computer displays **FILLING** while the pump runs again. When the pump stops, the computer displays **IS VAT FULL?** alternating with **YES NO** again. If the vat is full go to step 1. If the vat is not completely filled continue.

3. Press ✕ (2 NO) if pot is not filled completely.



The computer displays **FILLING** while the pump runs again. When the pump stops, the computer displays **IS VAT FULL?** alternating with **YES NO** again. If the vat is full go to step 1. If the vat is not completely filled continue.

4. Press ✕ (2 NO) if pot is not filled completely. If this is the second consecutive sequence of incomplete filtration skip to step 8.

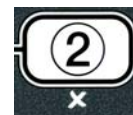

The computer displays **CHANGE FILTER PAD?** alternating with **YES NO** and an alarm.

5. Press ✓ (1 YES) to continue.

Pressing ✕ (2 NO) allows the fryer to return to cook mode in most cases for four minutes or 15 minutes if the pad is expired*, ending with the **CHANGE FILTER PAD?** alternating with **YES NO** display. This repeats until **YES** is chosen.



The computer displays **REMOVE PAN**.

***NOTE:** If the filter pad change time has expired, normally every 25 hours, the **CHANGE FILTER PADP** message repeats every 15 minutes instead of every four minutes.

6. Remove the pan. The computer display changes to **CHANGE PAD**. Change the filter pad and ensure the filter pan has been pulled forward, out of the cabinet for at least 30 seconds. Once the pan has been out for 30 seconds the computer displays **OFF**. Ensure the pan is dry and assembled correctly. Push the filter pan back into the fryer. Ensure “**A**” is displayed on the MIB board.
7. Switch the computer on. The computer displays **LOW TEMP** until the fryer reaches setpoint.
8. If a filtration error occurs six consecutive times, the return valve closes and the computer displays **SERVICE REQUIRED** alternating with **YES** and an alarm.
9. Press **✓ (1 YES)** to silence alarm and continue.

The computer displays **SYSTEM ERROR** and the error message for 15 seconds changing to **SYSTEM ERROR FIXED** alternating with **YES NO**.

10. Press *** (2 NO)** to continue cooking. Call your ASA to repair and reset the fryer. The error will be re-displayed every 15 minutes until the issue is repaired. Auto filtration and auto top off is disabled until the fryer is reset.



5.4.2 Clogged Drain Error

The clogged drain error occurs during auto filtration when the oil level sensor detects that oil has not completely drained from the frypot. This may be due to a clogged drain or an oil sensor failure. Follow the instructions on the computer display using the chart on page 5-7 to clear the error.

When this occurs the computer displays **CLEAR DRAIN** for 15 seconds changing to **IS DRAIN CLEARP** alternating with **YES**.

1. Clear debris from the drain using the fryer’s friend and press the **✓ (1 YES)** button to continue.
2. The computer displays **DRAINING**. Once the oil level sensor detects the oil has drained, normal auto filtration operation resumes.

5.4.3 Filter Error Flowchart

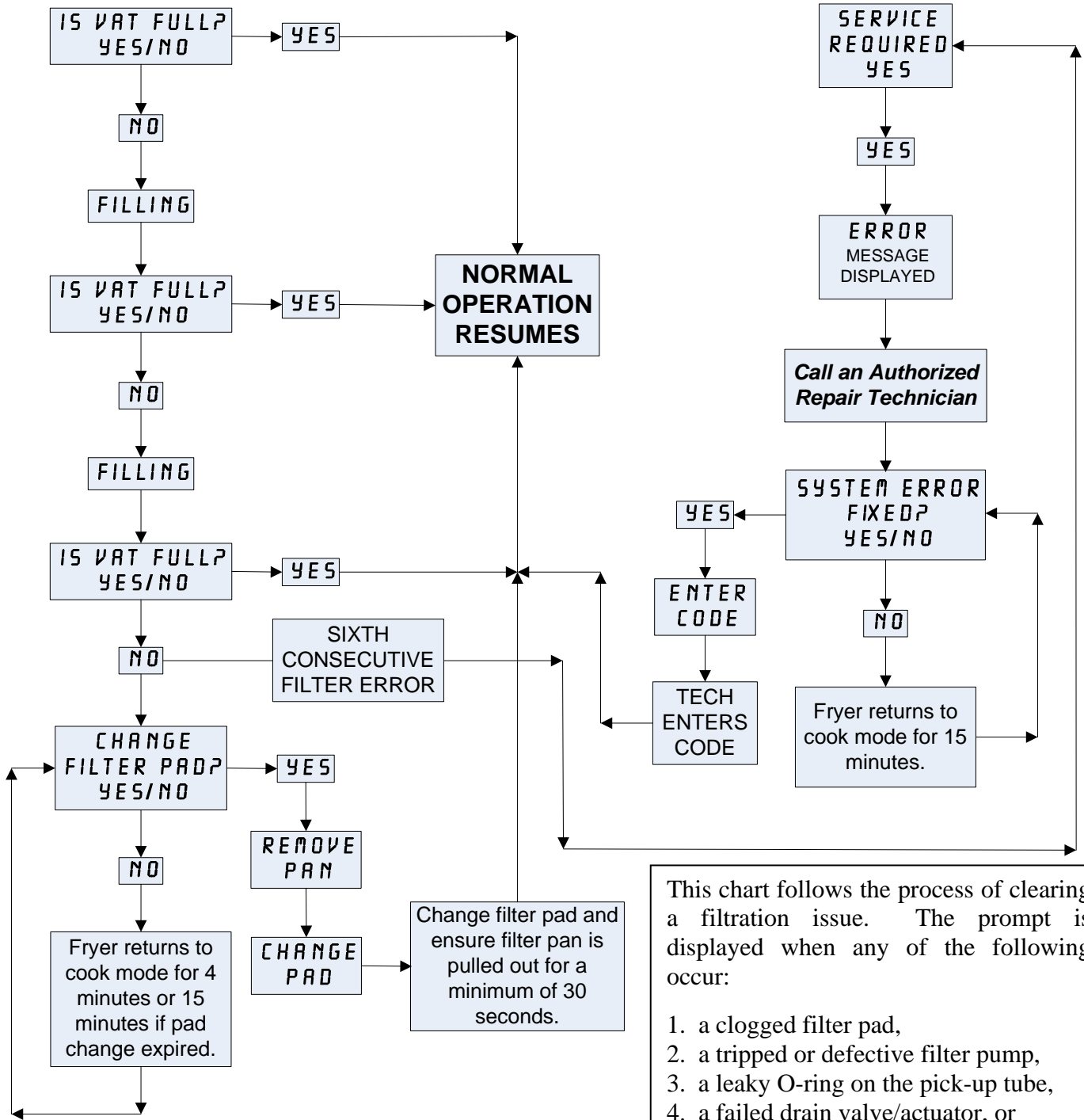

This chart follows the process of clearing a filtration issue. The prompt is displayed when any of the following occur:

1. a clogged filter pad,
2. a tripped or defective filter pump,
3. a leaky O-ring on the pick-up tube,
4. a failed drain valve/actuator, or
5. a failed return valve/actuator.

If the computer displays **SERVICE REQUIRED**, the fryer can be used in most cases by answering **NO** when the prompt for **SYSTEM ERROR FIXED? YES NO** is displayed. The message repeats every 15 minutes until the issue is repaired and fryer reset by a technician.

5.4.4 Clogged Drain or Oil Sensor Fail Flowchart

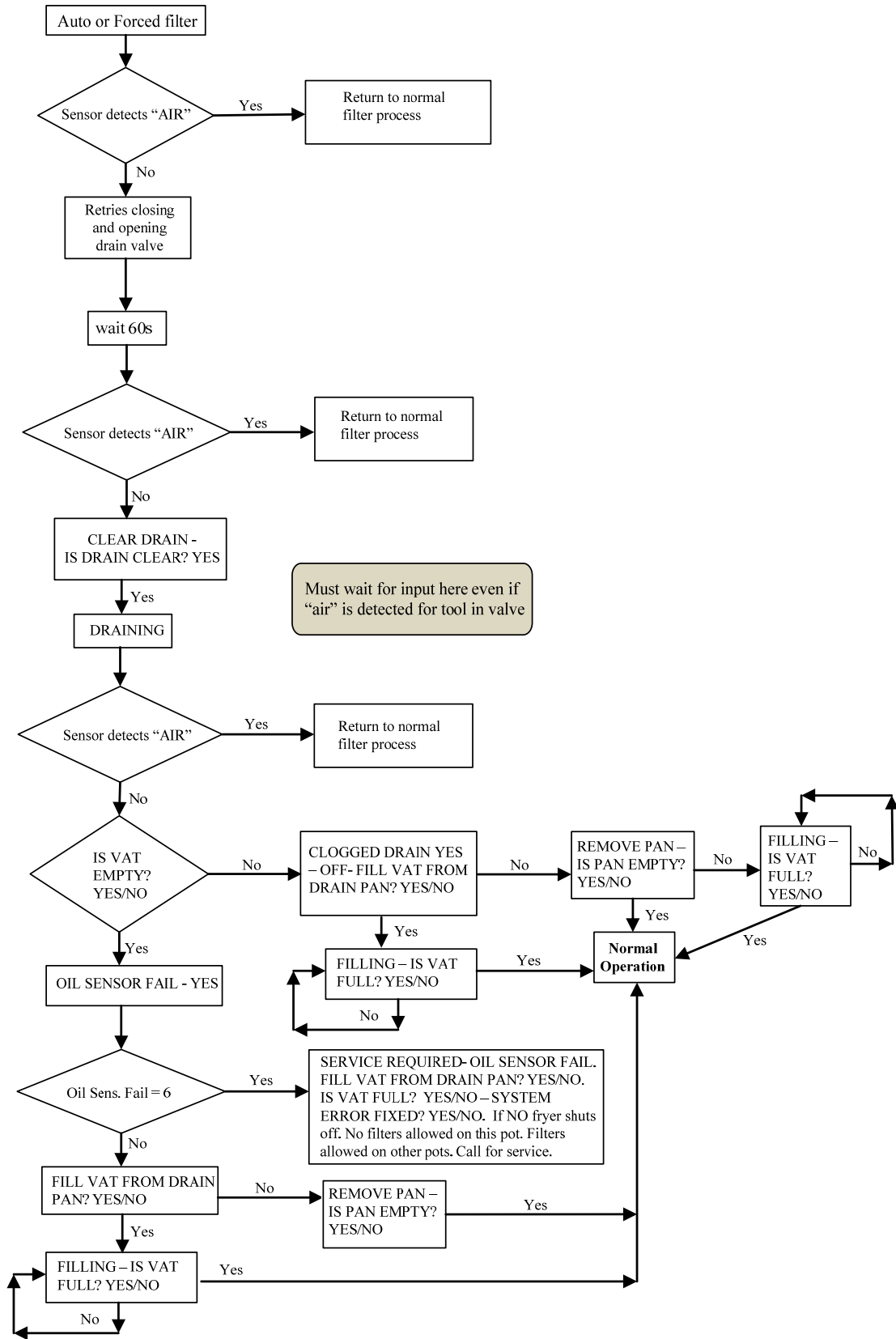

5.4.5 Filter Busy

When **FILTER BUSY** is displayed the MIB board is waiting on another vat to be filtered or waiting on another issue to clear. Wait 15 minutes to see if problem is corrected. If not, call your local ASA.

DANGER

Do not drain more than one frypot at a time into the built-in filtration unit to avoid overflow and spillage of hot oil that may cause severe burns, slipping and falling.

WARNING

The filter pump is equipped with a manual reset switch in case the filter motor overheats or an electrical fault occurs. If this switch trips, turn off power to the filter system and allow the pump motor to cool 20 minutes before attempting to reset the switch (see photo below).

WARNING

Use caution and wear appropriate safety equipment when resetting the filter pump reset switch. Resetting the switch must be accomplished with care to avoid the possibility of a serious burn from careless maneuvering around the drain tube and frypot.

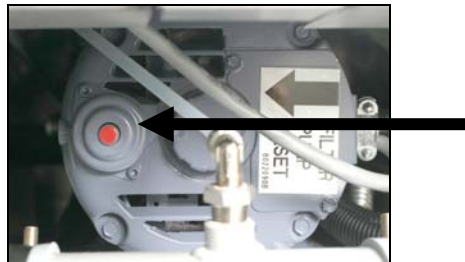

Filter Pump Reset Switch

5.5 Manual or End of Day Filtration (MAINT FLTR)

NOTICE

The filter pad or paper must be replaced daily.

DANGER

Do not drain more than one frypot at a time into the built-in filtration unit to avoid overflow and spillage of hot oil that may cause severe burns, slipping and falling.

Ensure that the filter pad or paper is replaced daily to keep the system operating correctly.

1. The fryer **MUST** be at setpoint temperature.
With the computer **ON** press and hold the **FLTR** button for three seconds.



Computer displays **FILTER MENU** for three seconds changing to **AUTO FILTER**.

2. Press the **▼ (INFO)** button to scroll to **MAINT FILTER**.



3. When the desired selection is displayed press the **✓ (1)** button to continue.



The computer displays **MAINT FILTER?** alternating with **YES NO**.

4. Press the **✓ (1 YES)** button to start the manual filtration process. If **CLOSE DISPOSE VALVE** is displayed, close the RTI dispose valve. Press the *** (2 NO)** button to exit.



If no pan is in place the computer displays **INSERT PAN** until a pan is detected. The computer displays **FILTERING** and oil drains from the frypot.



Keep all items out of drains. Closing actuators may cause damage or injury.

The computer display changes to **SCRUB VAT COMPLETE?** alternating with **YES**.

5. Clean the vat with a scrub brush and press the **✓ (1 YES)** button to continue when complete.



The computer displays **WASH VAT?** alternating with **YES**.

6. Press the **✓ (1 YES)** button to continue.



The computer displays **WASHING**.

The return valve opens and the pot is flushed with oil from the pan.

The filter pump shuts off and the computer displays **WASH AGAIN?** alternating with **YES NO**.



7. If the pot is clean of debris, press the *** (2 NO)** button to continue and skip the wash again cycle. If crumbs are still present, press the **✓ (1 YES)** button and the filter pump runs for another 30 seconds. This cycle repeats until the *** (2 NO)** button is pressed.

The computer displays **RINSING**. The drain valve closes and the filter pump continues to run and refills the pot.

The drain valve opens and remains open and the computer displays **RINSE AGAIN?** alternating with **YES NO**.

8. If the pot is clear of debris, press the **✖ (2 NO)** button to continue and skip the rinse again cycle. If rinse again is desired, press the **✓ (1 YES)** button and the rinse repeats. This cycle repeats until the **✖ (2 NO)** button is pressed.



⚠ DANGER

Keep all items out of drains. Closing actuators may cause damage or injury.

The computer displays **POLISH?** alternating with **YES NO**.

9. Press the **✓ (1 YES)** button to continue.



The filter pump turns on. The drain and return valves are open and oil is pumped through the frypot. The computer displays **POLISHING** alternating with a five minute countdown timer. When the timer expires, the filter pump shuts off. To exit polish press the **✖ (2 NO)** button.

The computer displays **FILL VAT?** alternating with **YES**.

10. Press the **✓ (YES)** button to continue.



The computer displays **FILLING**.

The drain valve closes and the filter pump turns on and refills the frypot. As the frypot fills, bubbles appear, the return valve closes and the pump shuts off. Once the system verifies the oil level, the top off pump will add oil if necessary.

The computer displays **IS VAT FULL?** alternating with **YES NO**.

11. Press the **✓ (YES)** button if the pot is filled. Press the **✖ (2 NO)** button to run the pump again*. If the vat oil level is not completely filled, check the filter pan to see if most of the oil has returned. The pan may have a small amount of oil. The computer displays **IS VAT FULL?** alternating with **YES NO** again.



12. Press the **✓ (YES)** button.



The computer displays **OFF**.

***NOTE: After a maintenance filtration it is normal to leave some oil in the pan and the level of oil may not return to the level prior to starting maintenance filtration. Answering YES after two attempts at refilling the vat enables auto top off to compensate for any loss of oil during filtration.**

BIGLA30 SERIES GEN II LOV™ GAS FRYER

CHAPTER 6: PREVENTATIVE MAINTENANCE

6.1 Fryer Preventive Maintenance Checks and Service

 **DANGER**

The crumb tray in fryers equipped with a filter system must be emptied into a fireproof container at the end of frying operations each day. Some food particles can spontaneously combust if left soaking in certain shortening material.

 **DANGER**

Never attempt to clean the fryer during the frying process or when the frypot is filled with hot oil. If water comes in contact with oil heated to frying temperature, it will cause spattering of the oil, which can result in severe burns to nearby personnel.

 **WARNING**

Use McDonald's All Purpose Concentrate. Read the directions for use and precautionary statements before use. Particular attention must be paid to the concentration of cleaner and the length of time the cleaner remains on the food-contact surfaces.

6.2 DAILY CHECKS AND SERVICE

6.2.1 Inspect Fryer and Accessories for Damage

Look for loose or frayed wires and cords, leaks, foreign material in frypot or inside cabinet, and any other indications that the fryer and accessories are not ready and safe for operation.

6.2.2 Clean Fryer Cabinet Inside and Out - Daily

Clean inside the fryer cabinet with dry, clean cloth. Wipe all accessible metal surfaces and components to remove accumulations of oil and dust.

Clean the outside of the fryer cabinet with a clean, damp cloth soaked with McDonald's All Purpose Concentrate, removing oil, dust, and lint from the fryer cabinet. Wipe with a clean, damp cloth.

6.2.3 Clean the Built-In Filtration System - Daily

 **WARNING**

Never operate the filter system without oil in the system.

 **WARNING**

Never use the filter pan to transport old oil to the disposal area.

 **WARNING**

Never drain water into the filter pan. Water will damage the filter pump.

There are no periodic preventive maintenance checks and services required for your FootPrint Pro Filtration System other than daily cleaning of the filter pan with a solution of hot water and McDonald's All Purpose Concentrate.

If you notice that the system is pumping slowly or not at all, verify that the filter pan screen is on the bottom of the filter pan, with the pad on top of the screen. Verify that the two O-ring(s) on the fitting at the right front of the filter pan are present and in good condition.

6.3 WEEKLY CHECKS AND SERVICE

6.3.1 Clean Behind Fryers

Clean behind fryers in accordance with the procedure detailed in the maintenance requirement card. Shut off and disconnect the gas. Use the manual gas shut-off valve to shut off the gas supply. The manual gas shut-off valve is located on the supply line before the quick disconnects. Then disconnect the gas line from the fryer via the quick disconnect.

WARNING

To ensure the safe and efficient operation of the fryer and hood, the electrical plug for the 120-volt line, which powers the hood, must be fully engaged and locked in its pin and sleeve socket.

6.3.2 Cleaning the Frypot - Quarterly

DANGER

Never operate the appliance with an empty frypot. The frypot must be filled with water or oil before lighting the burners. Failure to do so will damage the frypot and may cause a fire.

6.3.2.1 Deep Clean (Boiling Out) the Frypot

During normal usage of your fryer, a deposit of carbonized oil will gradually form on the inside of the frypot. This film should be periodically removed by following the deep-clean (boil-out) procedure contained in Kay Chemical "Fryer Deep Clean Procedure" instructions. *Refer to page 4-25 for specific details on setting up the computer for deep clean (boil-out) operation.*

DANGER

Allow oil to cool to 100°F (38°C) or lower before draining to an appropriate container for disposal.

WARNING

Never leave the fryer unattended during this process. If the solution overflows, press the ON/OFF switch to the OFF position immediately.

DANGER

Ensure that the frypot is completely free of water before filling with oil. When the oil is heated to cooking temperature, water in the frypot will cause splattering.



6.3.3 Clean Filter Pan, Detachable Parts and Accessories

As with the frypot, a deposit of carbonized oil will accumulate on the filter pan and detachable parts and accessories such as baskets, sediment trays, or fishplates.

Wipe the filter pan and all detachable parts and accessories with a clean dry cloth. Use a cloth dampened with a solution of McDonald's All Purpose Concentrate to remove accumulated carbonized oil. Rinse and thoroughly dry each part. DO NOT use steel wool or abrasive pads to clean these parts. The scratches that result from such scrubbing make subsequent cleanings more difficult.

6.4 BI-WEEKLY CHECKS AND SERVICE

6.4.1 Check M3000 Computer Set Point Accuracy

1. Insert a good-grade thermometer or pyrometer probe into the oil, with the end touching the fryer temperature-sensing probe.
2. When the computer display shows a series of dashes "----" or a product name (indicating that the frypot contents are within the cooking range), press the  switch once to display the temperature of the oil as sensed by the temperature probe.
3. Press the  switch twice to display the set point.
4. Note the temperature on the thermometer or pyrometer. Actual temperature and pyrometer readings should be within $\pm 5^{\circ}\text{F}$ (3°C) of each other. If not, contact a Factory Authorized Service Agency for assistance.

6.5 QUARTERLY CHECKS AND SERVICE

6.5.1 Clean Combustion Air Blower Assembly

1. Disconnect the blower wiring harness and remove the four blower mounting nuts. (See Figure 1 on below)

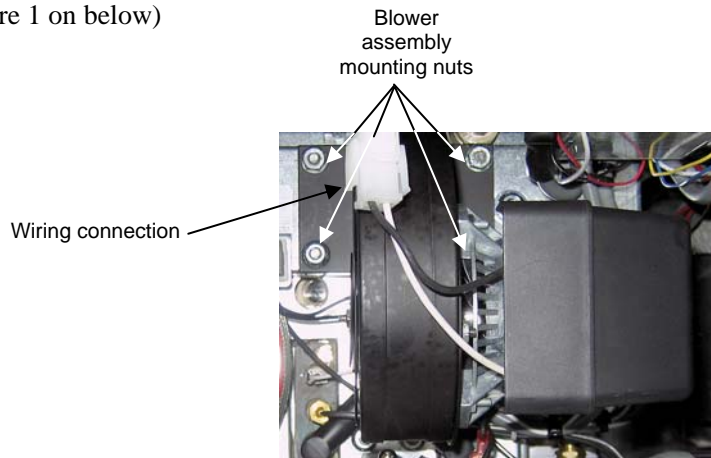

Figure 1

2. Remove the three fasteners that secure the blower motor assembly to the blower housing, and separate the two components. (See Figure 2)

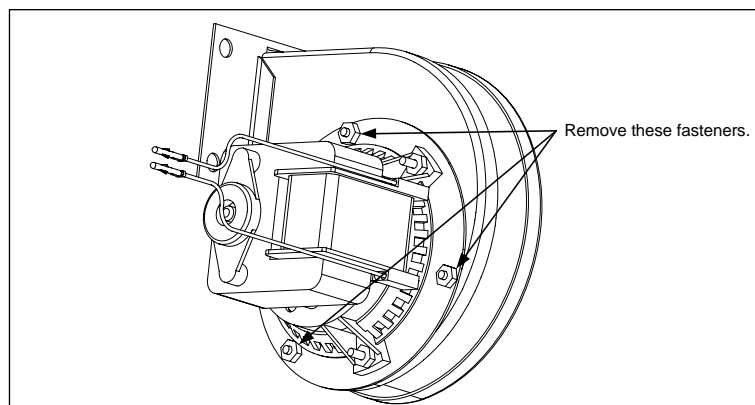

Figure 2

3. Wrap the motor with plastic wrap to prevent water from entering it. Spray degreaser or detergent on the blower wheel and the blower housing. Allow it to soak for five minutes. Rinse the wheel and housing with hot tap water, then dry with a clean cloth. (See Figure 3)

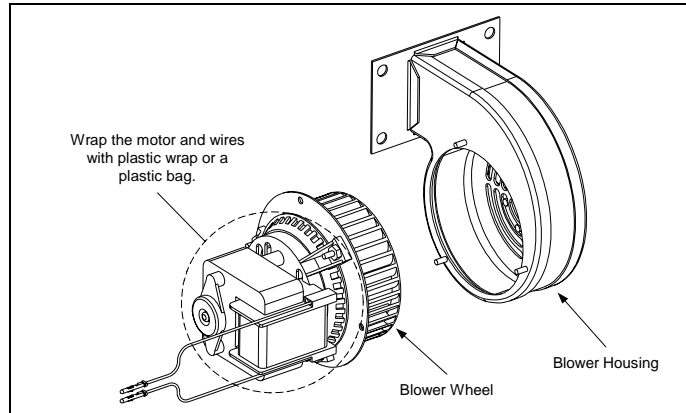

Figure 3

4. Remove the plastic wrap from the blower motor assembly. Reassemble the blower motor assembly and blower housing. Reinstall the blower assembly in the fryer.
5. Reinstall the blower shield or shield assembly.
6. Light the fryer in accordance with the procedure described in Chapter 3, Section 3.1.2.
7. After the burners have been lit for at least 90 seconds, observe the flames through the burner viewing ports located on each side of the combustion air blower. (See Figure 4)

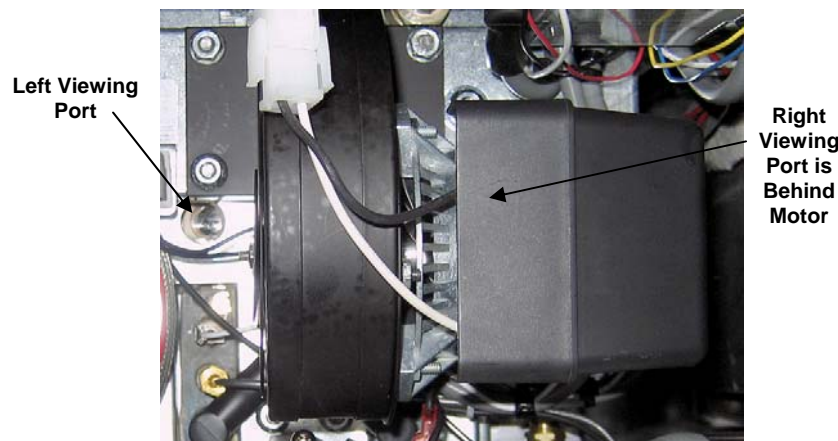
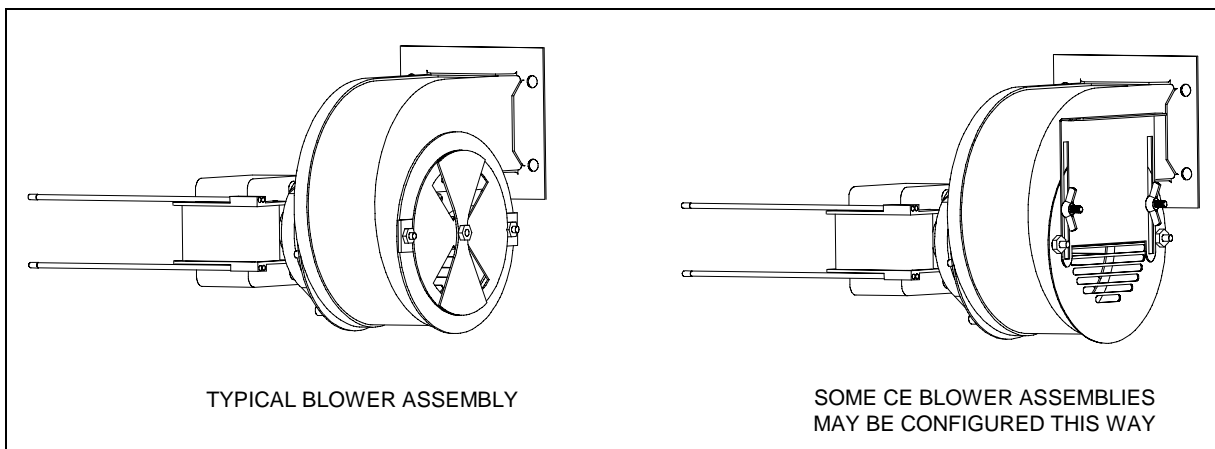

Figure 4

The air/gas mixture is properly adjusted when the burner manifold pressure is in accordance with the applicable table on page 2-7 and the burners display a bright orange-red glow. If a blue flame is observed, or if there are dark spots on a burner face, the air/gas mixture requires adjustment.

On the side of the blower housing opposite the motor is a plate with one or two locking nuts (see illustration on the following page). Loosen the nut(s) enough to allow the plate to be moved, then adjust the position of the plate to open or close the air intake opening until a bright orange-red glow is obtained. Carefully hold the plate in position and tighten the locking nut(s).



REPLACE THE O-RINGS

Refer to McDonald's MRC cards for specific details on replacing the O-rings on the filter connection.

6.6 SEMI-ANNUAL CHECKS AND SERVICE

6.6.1 Clean Gas Valve Vent Tube

NOTE: This procedure is not required for fryers configured for export to CE countries.

1. Set the fryer power switch and the gas valve to the OFF position.
2. Carefully unscrew the vent tube from the gas valve. **NOTE:** The vent tube may be straightened for ease in removal.
3. Pass a piece of ordinary binding wire through the tube to remove any obstruction.
4. Remove the wire and blow through the tube to ensure it is clear.
5. Reinstall the tube and bend it so that the opening is pointing downward.

6.6.2 Clean Oil Level Sensor

1. Drain the oil using the drain to pan option in the filter menu.
2. Use a no-scratch pad to clean carbonized oil off of the sensor (see photo right).
3. Return the oil using the fill vat from pan option in the filter menu.



6.7 Annual/Periodic System Inspection

This appliance should be inspected and adjusted periodically by qualified service personnel as part of a regular kitchen maintenance program.

Frymaster recommends that a Factory Authorized Service Technician inspect this appliance at least annually as follows:

6.7.1 Fryer

- Inspect the cabinet inside and out, front and rear for excess oil.
- Verify that debris or accumulations of solidified oil do not obstruct the flue opening.

- Verify that burners and associated components (i.e. gas valves, pilot assemblies, ignitors, etc.) are in good condition and functioning properly. Inspect all gas connections for leaks and verify that all connections are properly tightened.
- Verify that the burner manifold pressure is in accordance with that specified on the appliance's rating plate.
- Verify that the temperature and high-limit probes are properly connected, tightened and functioning properly, and that probe guards are present and properly installed.
- Verify that component box components (i.e. computer, transformers, relays, interface boards, etc.) are in good condition and free from oil and other debris. Inspect the component box wiring and verify that connections are tight and that wiring is in good condition.
- Verify that all safety features (i.e. reset switches, etc.) are present and functioning properly.
- Verify that the frypot is in good condition and free of leaks and that the frypot insulation is in serviceable condition.
- Verify that wiring harnesses and connections are tight and in good condition.

6.7.2 Built-In Filtration System

- Inspect all oil-return and drain lines for leaks and verify that all connections are tight.
- Inspect the filter pan for leaks and cleanliness. If there is a large accumulation of crumbs in the crumb basket, advise the owner/operator that the crumb basket should be emptied into a fireproof container and cleaned daily.
- Verify that all O-rings and seals are present and in good condition. Replace O-rings and seals if worn or damaged.
- Check filtration system integrity as follows:
 - Verify that filter pan cover is present and properly installed.
 - With the filter pan empty, place each vat into fill vat from drain pan selection (see section 4.11.3 on page 4-21), one at a time. Verify proper functioning of each oil return valve by activating the filter pump using the fill vat from drain pan selection. Verify that the pump activates and that bubbles appear in the cooking oil of the associated frypot.
 - Verify that the filter pan is properly prepared for filtering, then drain a frypot of oil heated to 350°F (177°C) into the filter pan by using the drain to pan selection (see section 4.11.2 on page 4-20). Now using the fill vat from pan drain pan selection (see section 4.11.3 on page 4-21), allow all oil to return to the frypot (indicated by bubbles in the cooking oil). Press the check button when all oil is returned. The frypot should have refilled in approximately 2 minutes and 30 seconds.

BIGLA30 SERIES GEN II LOV™ GAS FRYER

CHAPTER 7: OPERATOR TROUBLESHOOTING

7.1 Introduction

This chapter provides an easy reference guide to some of the common problems that may occur during the operation of your equipment. The troubleshooting guides that follow are intended to help you correct, or at least accurately diagnose, problems with your equipment. Although the chapter covers the most common problems reported, you may encounter problems that are not covered. In such instances, the Frymaster Technical Services staff will make every effort to help you identify and resolve the problem.

When troubleshooting a problem, always use a process of elimination starting with the simplest solution and working through to the most complex. Most importantly, always try to establish a clear idea of why a problem has occurred. Part of your corrective action involves taking steps to ensure that it doesn't happen again. If a controller malfunctions because of a poor connection, check all other connections. If a fuse continues to blow, find out why. Always keep in mind that failure of a small component may often be indicative of potential failure or incorrect functioning of a more important component or system.

If you are in doubt as to the proper action to take, do not hesitate to call the Frymaster Technical Service Department or your local Frymaster Factory Authorized Service Agency for assistance.

Before calling a servicer or the Frymaster HOTLINE (1-800-551-8633):

- **Verify that electrical cords are plugged in and that circuit breakers are on.**
- **Verify that gas line quick-disconnects are properly connected.**
- **Verify that any gas line cutoff valves are open.**
- **Verify that frypot drain valves are fully closed.**
- **Have your fryer's model and serial numbers ready to give the technician assisting you.**

 **DANGER**

Hot oil will cause severe burns. Never attempt to move this appliance when filled with hot oil or to transfer hot oil from one container to another.

 **DANGER**

This equipment should be unplugged when servicing, except when electrical circuit tests are required. Use extreme care when performing such tests.

This appliance may have more than one electrical power supply connection point. Disconnect all power cords before servicing.

Inspection, testing, and repair of electrical components should be performed by an authorized service agent only.

7.2 Troubleshooting Fryers

7.2.1 Computer and Heating Problems

PROBLEM	PROBABLE CAUSES	CORRECTIVE ACTION
No display on the computer.	A. Computer not turned on. B. No power to fryer. C. Failed computer or other component	A. Press the ON/OFF switch to turn the computer on. B. Verify that the fryer is plugged in and that the circuit breaker is not tripped. C. Call your ASA for assistance.
M3000 displays IS FAT FULL? YES NO after a filtration.	A filter error has occurred due to dirty or clogged filter pad or paper, clogged filter pumps, improperly installed filter pan components, worn or missing O-rings, cold oil or filter pump thermal overload.	Follow instructions on page 5-4 through 5-6 to clear the filter error. If problem persists, call your ASA for assistance.
M3000 display shows IS DRAIN CLEAR?	Drain is clogged and oil failed to drain.	Clear drain with Fryers Friend and press ✓ (1) YES button. Filtration will resume.
M3000 displays CHANGE FILTER PAD?	Filter error has occurred, filter pad clogged, 25 hour filter pad change prompt has occurred or change filter pad was ignored on a prior prompt.	Change the filter pad and ensure the filter pan has been removed from the fryer for a minimum of 30 seconds. Do NOT ignore CHANGE FILTER PAD prompts.
Fryer does not heat.	A. Drain valve not fully closed. B. Gas valve is not turned on. C. Manual gas shut off valve closed. D. Improperly connected quick-disconnect fitting on gas line. E. Obstructed or failed combustion air blower.	A. Check status of MIB – Ensure A is displayed. B. Turn the gas valve knob to the ON position. C. Verify that any in-line manual shut off and gas main valve is open. D. Verify that the quick-disconnect fitting on the flexible gas line is firmly connected to the fryer. E. Verify that combustion air blower is running. If not, call ASA for service. If combustion air blower is functional, clean and adjust per instructions in Chapter 6 of this manual.
Fryer is operating normally, but recovery is slow when cooking.	Dirty or obstructed combustion air blower.	Clean and adjust per instructions in Chapter 6 of this manual.
Fryer is operating normally, but produces a popping sound when burners ignite.	A. Dirty or obstructed combustion air blower. B. Dirty or obstructed gas valve vent tube (non-CE fryers only). C. Malfunctioning combustion air blower.	A. Clean and adjust per instructions in Chapter 6 of this manual. B. Clean per instructions in Chapter 6 of this manual. C. Call your ASA.
Computer locks up.	Computer error.	Remove and restore power to the computer. If problem persists, call your ASA for assistance.
M3000 display shows MISCONFIGURED ENERGY TYPE	Energy type in fryer setup is incorrect.	Set proper energy type. Press 1234 to enter setup to properly configure fryer.

7.2.2 Error Messages and Display Problems

Problem	Probable Causes	Corrective Action
M3000 display shows HOT-HI-1.	Frypot temperature is more than 410°F (210°C) or, in CE countries, 395°F (202°C).	Shut the fryer down immediately and call your ASA for assistance.
M3000 display shows REMOVE DISCARD.	A product cook is started that has a different setpoint than the current vat temperature.	Remove and discard product. Press the cook button under the display with the error to remove the error. Reset the setpoint of the vat before trying to cook product.
M3000 display shows RECOVERY FAULT and alarm sounds.	Recovery time exceeded maximum time limit.	Clear error and silence the alarm by pressing the ✓ button. Maximum recovery time for gas is 2:25. If the error continues call your ASA for assistance.
M3000 display is in wrong temperature scale (Fahrenheit or Celsius).	Incorrect display option programmed.	Toggle between F° to C° by pressing and holding ◀ and ▶ simultaneously until TECH MODE appears. Enter 1658 . The computer displays OFF . Turn the computer on to check temperature. If the desired scale is not displayed, repeat.
M3000 display shows HELP HI-2 or HIGH LIMIT FAILURE.	Failed high limit	Shut the fryer down immediately and call your ASA for assistance.
M3000 display shows TEMP PROBE FAILURE.	Problem with the temperature measuring circuitry including the probe or damaged computer wiring harness or connector.	Shut the fryer down and call your ASA for assistance.
M3000 display shows HEATING FAILURE.	Gas valve off, failed computer, failed transformer, open high-limit thermostat.	It is normal for this message to appear during startup if the lines have air in them. Check that the gas valve is on. If it continues, shut the fryer down and call your ASA for assistance.
M3000 displays SERVICE REQUIRED followed by an error message.	An error has occurred which requires a service technician.	Press ✖ (2 NO) to continue cooking and call your ASA for assistance. In some cases, cooking may not be allowed.

7.2.3 Filtration Problems

PROBLEM	PROBABLE CAUSES	CORRECTIVE ACTION
Fryer filters after each cook cycle.	Filter after setting incorrect.	Change or overwrite the filter after setting by re-entering the filter after value in level two. See section 4.13.5 on page 4-33.
MAINT FILTER (Manual Filter) won't start.	Temperature too low.	Ensure fryer is at setpoint before starting MAINT FILTER .
M3000 display shows FILTER BUSY.	A. Another filtration cycle or filter pad change is still in process. B. MIB has not cleared checking system.	A. Wait until the previous filtration cycle ends to start another filtration cycle. Change filter pad if prompted. B. Wait one minute and try again.

PROBLEM	PROBABLE CAUSES	CORRECTIVE ACTION
Drain valve or return valve stays open.	A. AIF board has failed. B. Actuator has failed.	Call your ASA for assistance.
Filter pump won't start or pump stops during filtering.	A. Power cord is not plugged in or circuit breaker is tripped. B. Pump motor has overheated causing the thermal overload switch to trip. C. Blockage in filter pump.	A. Verify that the power cord is fully plugged in and the circuit breaker is not tripped. B. If the motor is too hot to touch for more than a few seconds, the thermal overload switch has probably tripped. Allow the motor to cool at least 45 minutes then press the Pump Reset Switch (see page 5-7). C. Call your ASA for assistance.
M3000 display shows INSERT PAN.	A. Filter pan is not fully set into fryer. B. Missing filter pan magnet. C. Defective filter pan switch.	A. Pull filter pan out and fully reinsert into fryer. B. Ensure the filter pan magnet is in place and replace if missing. C. If the filter pan magnet is fully against the switch and computer continues to display INSERT PAN , switch is possibly defective.
Auto filtration won't start.	A. Oil level too low. B. Check that MIB board is not in manual mode. C. Check to see that the MIB cover is not damaged and depressing the buttons. D. AIF disable is set to yes, blue light doesn't light. E. Filter relay has failed.	A. Ensure oil level is above the top oil level sensor. B. Ensure MIB board is in "A" automatic mode. Power cycle the fryer. C. Remove and replace cover and see if filtration will start. D. Set AIF disable in Level 1 to no. E. Call your ASA for assistance.
Filter Pump runs, but oil return is very slow.	A. Improperly installed or prepared filter pan components.	A. Remove the oil from the filter pan and replace the filter pad, ensuring that the filter screen is in place under the pad. Verify, if using a pad, that the rough side is facing up. Verify that O-rings are present and in good condition on filter pan connection fitting.
M3000 display shows OIL SENSOR FAIL.	Oil sensor may have failed.	Call your ASA for assistance.

7.2.4 Auto Top Off Problems

Problem	Probable Causes	Corrective Action
Frypots top off cold.	Incorrect setpoint.	Ensure setpoint is correct.
One vat doesn't top off.	A. Filter error exists. B. Service required error exists C. Solenoid, pump, pin issue, RTD or ATO issue.	A. Clear filter error properly. If problem persists call your ASA for assistance. B. Call your ASA for assistance. C. Call your ASA for assistance.

Problem	Probable Causes	Corrective Action
Frypots won't top off.	<ul style="list-style-type: none"> A. Fryer temperature too low. B. Oil is too cold. C. JIB out of oil (yellow light illuminated) D. Service required error exists 	<ul style="list-style-type: none"> A. Fryer temperature must be at setpoint. B. Ensure that the oil in the JIB is above 70°F (21°C). C. Ensure the JIB is not out of oil. Replace JIB and reset yellow LED. If problem persists call your ASA for assistance. D. Call your ASA for assistance.

7.2.5 Bulk Oil System Problems

Problem	Probable Causes	Corrective Action
JIB won't fill.	<ul style="list-style-type: none"> A. Incorrect setup procedure. B. Another function is in process. C. Dispose valve not completely closed. D. Bulk oil tank is empty. E. Solenoid, pump or switch issue. 	<ul style="list-style-type: none"> A. Power cycle fryer by disconnecting and reconnecting 5-pin control power cord. B. If a filtration or any other filter menu function is in process or FILTER NOW? YES/NO, CONFIRM YES/NO, or SKIM VAT are displayed, wait until the process is complete and try again. C. Ensure the dispose valve handle is pushed fully closed. D. Call your bulk oil provider. E. Call you ASA for assistance.
JIB or vat filling slow.	<ul style="list-style-type: none"> A. Pump or line issues beyond the scope of operator troubleshooting. 	<ul style="list-style-type: none"> A. Contact your bulk oil provider.
Frypot won't fill.	<ul style="list-style-type: none"> A. Incorrect setup procedure. B. Dispose valve not completely closed. C. Bulk oil tank is empty. D. RTI pump issue. 	<ul style="list-style-type: none"> A. Power cycle fryer by disconnecting and reconnecting 5-pin control power cord. B. Ensure the dispose valve handle is pushed fully closed. C. Call your bulk oil provider. D. Call you ASA for assistance.

7.2.6 Error Log Codes

Code	ERROR MESSAGE	EXPLANATION
E03	ERROR TEMP PROBE FAILURE	TEMP Probe reading out of range
E04	HI 2 BAD	High limit reading is out of range.
E05	HOT HI 1	High limit temperature is past more than 410°F (210°C), or in CE countries, 395°F (202°C)
E06	HEATING FAILURE	A component has failed in the high limit circuit such as computer, interface board, contactor or open-high limit.
E07	ERROR MIB SOFTWARE	Internal MIB software error
E08	ERROR ATO BOARD	MIB detects ATO board connection lost; ATO board failure
E09	ERROR PUMP NOT FILLING	Dirty pad and it needs changed or it was bypassed; filter pump problem
E10	ERROR DRAIN VALVE NOT OPEN	Drain valve was trying to open and confirmation is missing

E11	ERROR DRAIN VALVE NOT CLOSED	Drain valve was trying to close and confirmation is missing
E12	ERROR RETURN VALVE NOT OPEN	Return valve was trying to open and confirmation is missing
E13	ERROR RETURN VALVE NOT CLOSED	Return valve was trying to close and confirmation is missing
E14	ERROR AIF BOARD	MIB detects AIF missing; AIF board failure
E15	ERROR MIB BOARD	Cooking computer detects MIB connections lost; MIB board failure
E16	ERROR AIF PROBE	AIF RTD reading out of range
E17	ERROR ATO PROBE	ATO RTD reading out of range
E18	Not used	
E19	M3000 CAN TX FULL	Connection between computers lost
E20	INVALID CODE LOCATION	SD card removed during update
E21	FILTER PAD PROCEDURE ERROR (Change Filter Pad)	25 hour timer has expired or dirty filter logic has activated
E22	OIL IN PAN ERROR	The MIB has reset the oil in pan flag.
E23	CLOGGED DRAIN (Gas)	Vat did not empty during filtration
E24	OIL LEVEL SENSOR FAILED (Gas)	Oil level sensor failed.
E25	RECOVERY FAULT	Recovery time exceeded maximum time limit.

BIGLA30 SERIES GEN II LOV™ GAS FRYER

APPENDIX A: RTI (BULK OIL) INSTRUCTIONS

NOTE: The instructions in this manual for using a bulk oil system for filling and discarding oil are for an RTI system. These instructions may not be applicable to other bulk oil systems.

A.1.1 Bulk Oil Systems

Bulk oil systems have large oil storage tanks, typically located in the rear of the restaurant, that are connected to a rear manifold on the fryer. Waste oil is pumped from the fryer, via the fitting located on the bottom, to the disposal tanks and fresh oil is pumped from the tanks, thru the fitting located on the top, to the fryer (see Figure 1). Remove the plate exposing the RTI connection and connect the RTI connection to the fryer (see Figure 2). Set the fryer to bulk through the setup mode and set all computers to bulk oil. See Section 4.9 on page 4-9. **It is imperative that the fryer system be completely power cycled after changing setup from JIB to Bulk.**

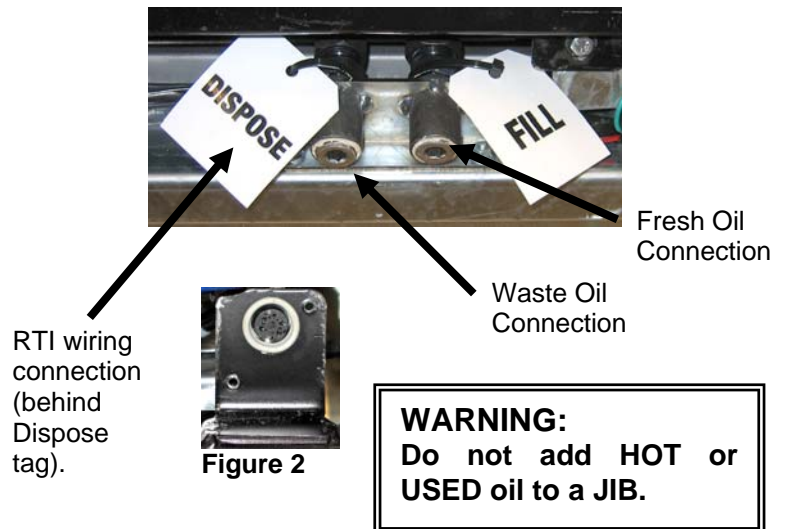

The LOV™ fryers, equipped for use with bulk oil systems, have an onboard fresh oil jug supplied by RTI. Remove the cap and insert the standard fitting into the jug with the metal cap resting on the lip of the jug. The oil is pumped in and out of the jug through the same fitting. (see Figure 3).

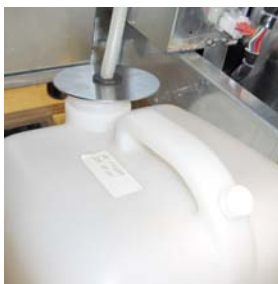

Figure 3

The momentary switch used to reset the JIB low LED is also used to fill the jug in an RTI system. After resetting the JIB LED, pressing and holding the momentary switch, located above the JIB, allows the operator to fill the jug from the bulk oil storage tank (see Figure 4).

To fill the jug, press and hold the JIB reset button until the jug is full, then release.*

NOTE: Do NOT overfill the jug.

For instructions on filling the vat from bulk, see Section 4.11.4 page 4-22.



Figure 4

* **NOTE:** It takes approximately twelve seconds from the time the fill JIB button is pressed until the RTI pump starts. It may take up to 20 seconds before the level in the JIB begins to rise. Typically it takes approximately three minutes to fill the JIB. It takes approximately one minute to fill a split vat and two minutes to fill a full vat.



Frymaster, L.L.C., 8700 Line Avenue, Shreveport, Louisiana 71106

TEL 1-318-865-1711

FAX (Parts) 1-318-688-2200

(Tech Support Fax) 1-318-219-7135

PRINTED IN THE UNITED STATES

SERVICE HOTLINE
1-800-551-8633

819-6286
FEBRUARY 2010

Free Manuals Download Website

<http://myh66.com>

<http://usermanuals.us>

<http://www.somanuals.com>

<http://www.4manuals.cc>

<http://www.manual-lib.com>

<http://www.404manual.com>

<http://www.luxmanual.com>

<http://aubethermostatmanual.com>

Golf course search by state

<http://golfingnear.com>

Email search by domain

<http://emailbydomain.com>

Auto manuals search

<http://auto.somanuals.com>

TV manuals search

<http://tv.somanuals.com>