



Installation & Operation Manual

# PROTECTOR® SERIES GAS FRYERS



Frymaster, a member of the Commercial Food Equipment Service Association, recommends using CFESA Certified Technicians.

24-Hour Service Hotline 1-800-551-8633

APRIL 2008

\* 8196339 \*

[www.frymaster.com](http://www.frymaster.com)

E-mail: [service@frymaster.com](mailto:service@frymaster.com)

**NOTICE**

IF, DURING THE WARRANTY PERIOD, THE CUSTOMER USES A PART FOR THIS ENODIS EQUIPMENT OTHER THAN AN **UNMODIFIED** NEW OR RECYCLED PART PURCHASED DIRECTLY FROM FRYMASTER DEAN, OR ANY OF ITS AUTHORIZED SERVICE CENTERS, AND/OR THE PART BEING USED IS MODIFIED FROM ITS ORIGINAL CONFIGURATION, THIS WARRANTY WILL BE VOID. FURTHER, FRYMASTER DEAN AND ITS AFFILIATES WILL NOT BE LIABLE FOR ANY CLAIMS, DAMAGES OR EXPENSES INCURRED BY THE CUSTOMER WHICH ARISE DIRECTLY OR INDIRECTLY, IN WHOLE OR IN PART, DUE TO THE INSTALLATION OF ANY MODIFIED PART AND/OR PART RECEIVED FROM AN UNAUTHORIZED SERVICE CENTER.

**NOTICE**

This appliance is intended for professional use only and is to be operated by qualified personnel only. A Frymaster DEAN Factory Authorized Service Center (FASC) or other qualified professional should perform installation, maintenance, and repairs. Installation, maintenance, or repairs by unqualified personnel may void the manufacturer's warranty. See Chapter 1 of this manual for definitions of qualified personnel.

**NOTICE**

This equipment must be installed in accordance with the appropriate national and local codes of the country and/or region in which the appliance is installed. See NATIONAL CODE REQUIREMENTS in Chapter 2 of this manual for specifics.

**NOTICE TO U.S. CUSTOMERS**

This equipment is to be installed in compliance with the basic plumbing code of the Building Officials and Code Administrators International, Inc. (BOCA) and the Food Service Sanitation Manual of the U.S. Food and Drug Administration.

**NOTICE**

Drawings and photos used in this manual are intended to illustrate operational, cleaning and technical procedures and may not conform to onsite management operational procedures.

**NOTICE TO OWNERS OF UNITS EQUIPPED WITH COMPUTERS**

**U.S.**

This device complies with Part 15 of the FCC rules. Operation is subject to the following two conditions: 1) This device may not cause harmful interference, and 2) This device must accept any interference received, including interference that may cause undesired operation. While this device is a verified Class A device, it has been shown to meet the Class B limits.

**CANADA**

This digital apparatus does not exceed the Class A or B limits for radio noise emissions as set out by the ICES-003 standard of the Canadian Department of Communications.

Cet appareil numérique n'émet pas de bruits radioélectriques dépassant les limites de classe A et B prescrites dans la norme NMB-003 édictée par le Ministre des Communications du Canada.

** DANGER**

Improper installation, adjustment, maintenance or service, and unauthorized alterations or modifications can cause property damage, injury, or death. Read the installation, operating, and service instructions thoroughly before installing or servicing this equipment. Only qualified service personnel may convert this appliance to use a gas other than that for which it was originally configured.

**⚠ DANGER**

No structural material on the fryer should be altered or removed to accommodate placement of the fryer under a hood. Questions? Call the Frymaster Dean Service Hotline at 1-800-551-8633.

**⚠ DANGER**

Adequate means must be provided to limit the movement of this appliance without depending upon the gas line connection. Single fryers equipped with legs must be stabilized by installing anchor straps. All fryers equipped with casters must be stabilized by installing restraining chains. If a flexible gas line is used, an additional restraining cable must be connected at all times when the fryer is in use.

**⚠ DANGER**

The front ledge of the fryer is not a step! Do not stand on the fryer. Serious injury can result from slips or contact with the hot oil.

**⚠ DANGER**

Do not store or use gasoline or other flammable liquids or vapors in the vicinity of this or any other appliance.

**⚠ DANGER**

Instructions to be followed in the event the operator smells gas or otherwise detects a gas leak must be posted in a prominent location. This information can be obtained from the local gas company or gas supplier.

**⚠ DANGER**

This product contains chemicals known to the state of California to cause cancer and/or birth defects or other reproductive harm.

Operation, installation, and servicing of this product could expose you to airborne particles of glasswool or ceramic fibers, crystalline silica, and/or carbon monoxide. Inhalation of airborne particles of glasswool or ceramic fibers is known to the State of California to cause cancer. Inhalation of carbon monoxide is known to the State of California to cause birth defects or other reproductive harm.

**⚠ DANGER**

The crumb tray in fryers equipped with a filter system must be emptied into a fireproof container at the end of frying operations each day. Some food particles can spontaneously combust if left soaking in certain shortening material.

**⚠ WARNING**

Do not bang fry baskets or other utensils on the fryer's joiner strip. The strip is present to seal the joint between the fry vessels. Banging fry baskets on the strip to dislodge shortening will distort the strip, adversely affecting its fit. It is designed for a tight fit and should only be removed for cleaning.

**NOTICE**

The Commonwealth of Massachusetts requires any and all gas products to be installed by a licensed plumber or pipe fitter.

# PROTECTOR® SERIES GAS FRYER

## CHAPTER 1: GENERAL INFORMATION

---

### 1.1 Applicability and Validity

The Protector® Series Gas Fryer with SMART4U® technology has been approved by the European Union for sale and installation in the following EU countries: AT, BE, DE, DK, ES, FI, FR, GB, IE, IT, LU, NL, NO, PT and SE.

This manual is applicable to and valid for all Protector® Series Gas Fryers sold in English-speaking countries, including those in the European Union. Where conflicts exist between instructions and information in this manual and local or national codes of the country in which the equipment is installed, installation and operation shall comply with those codes.

This appliance is only for professional use and shall be used by qualified personnel only, as defined in Section 1.7.

### 1.2 Safety Information

Before attempting to operate your unit, read the instructions in this manual thoroughly. Throughout this manual, you will find notations enclosed in double-bordered boxes similar to the ones that follow.

 **CAUTION**

**CAUTION** boxes contain information about actions or conditions that *may cause or result in a malfunction of your system.*

 **WARNING**

**WARNING** boxes contain information about actions or conditions that *may cause or result in damage to your system*, and which may cause your system to malfunction.

 **DANGER**

**DANGER** boxes contain information about actions or conditions that *may cause or result in injury to personnel*, and which may cause damage to your system and/or cause your system to malfunction.

Your fryer is equipped with automatic safety features:

1. High temperature detection shuts off gas to the burner assembly should the controlling thermostat fail.
2. An optional safety switch built into the drain valve prevents burner ignition with the drain valve even partially open.

### 1.3 Computer Information for the CM7 Computers

#### FCC COMPLIANCE

This equipment has been tested and found to comply with the limits for a Class A digital device, pursuant to Part 15 of the FCC rules. While this device is a verified Class A device, it has been shown to meet the Class B limits. These limits are designed to provide reasonable protection against harmful interference when the equipment is operated in a commercial environment. This equipment generates, uses and can radiate radio frequency energy and, if not installed and used in accordance with the instruction manual, may cause harmful interference to radio communications. Operation of the equipment in a residential area is likely to cause harmful interference in which case the user will be required to correct the interference at his own expense.

The user is cautioned that any changes or modifications not expressly approved by the party responsible for compliance could void the user's authority to operate the equipment.

If necessary, the user should consult the dealer or an experienced radio and television technician for additional suggestions.

The user may find the following booklet prepared by the Federal Communications Commission helpful: "How to Identify and Resolve Radio-TV Interference Problems". This booklet is available from the U.S. Government Printing Office, Washington, DC 20402, Stock No. 004-000-00345-4.

### 1.4 European Community (CE) Specific Information

The European Community (CE) has established certain specific standards regarding equipment of this type. Whenever a conflict exists between CE and non-CE standards, the information or instructions concerned are identified by means of shadowed boxes similar to the one below.

<b>Non-CE Standard for Incoming Gas Pressures</b>		
<b>Type</b>	<b>Minimum</b>	<b>Maximum</b>
Natural	6" W.C.	14" W.C.
	1.49 kPa	3.49 kPa
	14.68 mbar	34.72 mbar
LP	11" W.C.	14" W.C.
	2.74 kPa	3.49 kPa
	27.28 mbar	34.84 mbar

## 1.5 Equipment Description

Protector<sup>®</sup> Series high-efficiency gas fryers employ a unique infrared burner system that uses up to 43% less energy to cook the same volume as conventional open-burner fryers. Models in this series include FPGL30 variants. FPGL30 models have a built-in FootPrint Pro filtration system located under the leftmost two fryers in a battery.

All Protector<sup>®</sup> Series Gas fryers are of an open-frypot design with no tubes and have a hand-sized opening into the cold zone, which makes cleaning the stainless frypot quick and easy.

Heating is supplied by a pair of infrared burner assemblies mounted on each side of the frypot. Combustion air for the burners is supplied by a dedicated blower mounted on the front of the frypot. Protector<sup>®</sup> Series Gas fryers can be configured for natural gas, propane (LP), or manufactured gas, as required by the customer.

Each frypot is equipped with a temperature probe for precise temperature control.

All Protector<sup>®</sup> Series Gas fryers come standard with electronic ignition, melt cycle and boil-out mode. The Protector<sup>®</sup> Series Gas fryers are controlled with a CM-7 computer. Fryers in this series come in full pot arrangements, and can be purchased as two, three or four vat fryers.

All fryers in this series require an external source of AC electrical power. Units can be configured for voltages ranging from 100 VAC to 240 VAC.

FPGL30 fryers are shipped completely assembled. All fryers are shipped with a package of standard accessories. Each fryer is adjusted, tested, and inspected at the factory before crating for shipment.

## 1.6 Installation, Operating, and Service Personnel

Operating information for Frymaster equipment has been prepared for use by qualified and/or authorized personnel only, as defined in Section 1.7. **All installation and service on Frymaster equipment must be performed by qualified, certified, licensed, and/or authorized installation or service personnel, as defined in Section 1.7.**

## 1.7 Definitions

### QUALIFIED AND/OR AUTHORIZED OPERATING PERSONNEL

Qualified/authorized operating personnel are those who have carefully read the information in this manual and have familiarized themselves with the equipment functions, or who have had previous experience with the operation of the equipment covered in this manual.

## QUALIFIED INSTALLATION PERSONNEL

Qualified installation personnel are individuals, firms, corporations, and/or companies which, either in person or through a representative, are engaged in and are responsible for the installation of gas-fired appliances. Qualified personnel must be experienced in such work, be familiar with all gas precautions involved, and have complied with all requirements of applicable national and local codes.

## QUALIFIED SERVICE PERSONNEL

Qualified service personnel are those who are familiar with Frymaster equipment and who have been authorized by Frymaster, L.L.C. to perform service on the equipment. All authorized service personnel are required to be equipped with a complete set of service and parts manuals, and to stock a minimum amount of parts for Frymaster equipment. A list of Frymaster Factory Authorized Service Centers (FASC) is included with the fryer when shipped from the factory. ***Failure to use qualified service personnel will void the Frymaster warranty on your equipment.***

### 1.8 Shipping Damage Claim Procedure

Your Frymaster equipment was carefully inspected and packed before leaving the factory. The transportation company assumes full responsibility for safe delivery upon its acceptance of the equipment for transport.

#### What to do if your equipment arrives damaged:

1. **File a claim for damages immediately**, regardless of the extent of damages.
2. **Inspect for and record all visible loss or damage**, and ensure that this information is noted on the freight bill or express receipt and is signed by the person making the delivery.
3. **Concealed loss or damage** that was unnoticed until the equipment was unpacked should be recorded and reported to the freight company or carrier **immediately** upon discovery. A concealed damage claim must be submitted within 15 days of the date of delivery. Ensure that the shipping container is retained for inspection.

***Frymaster* DOES NOT ASSUME RESPONSIBILITY FOR DAMAGE OR LOSS  
INCURRED IN TRANSIT.**

### 1.9 Parts Ordering and Service Information

In order to assist you quickly, the Frymaster Factory Authorized Service Center (FASC) or Service Department representative requires certain information about your equipment. Most of this information is printed on a data plate affixed to the inside of the fryer door. Part numbers are found in the Service and Parts Manual. Parts orders may be placed directly with your local FASC or distributor. Included with fryers when shipped from the factory is a list of Frymaster FASCs. If you do not have access to this list, contact the Frymaster Service Department at 1-800-551-8633 or 1-318-865-1711 or by e-mail: [service@frymaster.com](mailto:service@frymaster.com).

When ordering parts, the following information is required:

Model Number: \_\_\_\_\_  
Serial Number: \_\_\_\_\_  
Type of Gas or Voltage: \_\_\_\_\_  
Item Part Number: \_\_\_\_\_  
Quantity Needed: \_\_\_\_\_

Service information may be obtained by contacting your local FASC/Distributor. Service may also be obtained by calling the Frymaster Service Department at 1-800-551-8633 or 1-318-865-1711 or by e-mail: [service@frymaster.com](mailto:service@frymaster.com). When requesting service, please have the following information ready:

Model Number: \_\_\_\_\_  
Serial Number: \_\_\_\_\_  
Type of Gas: \_\_\_\_\_

In addition to the model number, serial number, and type of gas, please be prepared to describe the nature of the problem and have ready any other information that you think may be helpful in solving your problem.

**RETAIN AND STORE THIS MANUAL IN A SAFE PLACE FOR FUTURE USE.**



# PROTECTOR® SERIES GAS FRYER

## CHAPTER 2: INSTALLATION INSTRUCTIONS

---

### 2.1 General Installation Requirements

Qualified, licensed, and/or authorized installation or service personnel, as defined in Section 1.7 of this manual, should perform all installation and service on Frymaster equipment.

Conversion of this appliance from one type of gas to another should only be performed by qualified, licensed, and/or authorized installation or service personnel as defined in Section 1.7 of this manual.

Failure to use qualified, licensed, and/or authorized installation or service personnel (as defined in Section 1.7 of this manual) to install, convert to another gas type or otherwise service this equipment will void the Frymaster warranty and may result in damage to the equipment or injury to personnel.

Where conflicts exist between instructions and information in this manual and local or national codes or regulations, installation and operation shall comply with the codes or regulations in force in the country in which the equipment is installed.

 **DANGER**

Building codes prohibit a fryer with its open tank of hot oil being installed beside an open flame of any type, including those of broilers and ranges.

Upon arrival, inspect the fryer carefully for visible or concealed damage. (See **Shipping Damage Claim Procedure** in Chapter 1.)

 **DANGER**

Frymaster appliances equipped with legs are for stationary installations. Appliances fitted with legs must be lifted during movement to avoid damage to the appliance and bodily injury. For movable installations, optional equipment casters must be used. Questions? Call 1-800-551-8633.

#### 2.1.1 Clearance and Ventilation

The fryer(s) must be installed with a 6" (150 mm) clearance at both sides and back when installed adjacent to combustible construction; no clearance is required when installed adjacent to noncombustible construction. A minimum of 24" (600 mm) clearance should be provided at the front of the fryer.

 **WARNING**

Do not block the area around the base or under the fryers.

**⚠ DANGER**

**No structural material on the fryer should be altered or removed to accommodate placement of the fryer under a hood. Questions? Call the Frymaster Dean Service Hotline at 1-800-551-8633.**

One of the most important considerations of efficient fryer operation is ventilation. Make sure the fryer is installed so that products of combustion are removed efficiently, and that the kitchen ventilation system does not produce drafts that interfere with burner operation.

The fryer flue opening must not be placed close to the intake of the exhaust fan, and the fryer must never have its flue extended in a “chimney” fashion. An extended flue will change the combustion characteristics of the fryer, causing longer recovery time. It also frequently causes delayed ignition. To provide the airflow necessary for good combustion and burner operation, the areas surrounding the fryer front, sides, and rear must be kept clear and unobstructed.

**⚠ DANGER**

**This appliance must be installed with sufficient ventilation to prevent the occurrence of unacceptable concentrations of substances harmful to the health of personnel in the room in which it is installed.**

Fryers must be installed in an area with an adequate air supply and adequate ventilation. Adequate distances must be maintained from the flue outlet of the fryer to the lower edge of the ventilation filter bank. Filters should be installed at an angle of 45°. Place a drip tray beneath the lowest edge of the filter. For U.S. installation, NFPA standard No. 96 states, “A minimum distance of 18 in. (450 mm) should be maintained between the flue outlet and the lower edge of the grease filter.” *Frymaster recommends that the minimum distance be 24 in. (600 mm) from the flue outlet to the bottom edge of the filter when the appliance consumes more than 120,000 BTU per hour.*

For installations in the United States, information on construction and installation of ventilating hoods can be found in the NFPA standard cited above. A copy of the standard may be obtained from the National Fire Protection Association, Battery March Park, Quincy, MA 02269.

### **2.1.2 National Code Requirements**

The type of gas for which the fryer is equipped is stamped on the data plate attached to the inside of the fryer door. Connect a fryer stamped “NAT” only to natural gas, those stamped “PRO” only to propane gas, and those stamped “MFG” only to manufactured gas.

Installation shall be made with a gas connector that complies with national and local codes, and, where applicable, CE codes. Quick-disconnect devices, if used, shall likewise comply with national, local, and, if applicable, CE codes. In the absence of local codes, installation must conform to the national Fuel Gas Code, ANSI Z223.1/NFPA 54 or the Natural Gas and Propane Installation code, CSA B149.1, as applicable including:

1. The appliance and its individual shutoff valve must be disconnected from the gas supply piping system during any pressure testing of the system at test pressures in excess of ½ psi (3.5 kPa).

2. The appliance must be isolated from the gas supply piping system by closing its individual manual shutoff valve during any pressure testing of the gas supply piping system at test pressures equal to or less than ½ psi (3.5 kPa).

### 2.1.3 Electrical Grounding Requirements

All electrically operated appliances must be grounded in accordance with all applicable national and local codes, and, where applicable, CE codes. In the absence of local codes, the appliance must be grounded in accordance with National Electrical Code, ANSI/NFPA 70, or the Canadian Electrical Code, CSA C22.2, as applicable. All units (cord connected or permanently connected) should be connected to a grounded power supply system. A wiring diagram is located on the inside of the fryer door. Refer to the rating plate on the inside of the fryer door for proper voltages.

 **DANGER**

**This appliance is equipped with a special (grounding) plug for your protection against electrical shock, and must be plugged directly into a properly grounded receptacle. Do not cut, remove, or otherwise bypass the grounding prong on this plug!**

 **DANGER**

**This appliance requires electrical power for operation. Place the gas control valve in the OFF position in case of a prolonged power outage. Do not attempt to operate this appliance during a power outage.**

### 2.1.4 Australian Requirements

To be installed in accordance with AS 5601 / AG 601, local authority, gas, electricity, and any other relevant statutory regulations.

## 2.2 Caster/Leg Installation

Depending upon the specific configuration ordered, your fryer may have been shipped without installed casters or legs. **DO NOT INSTALL THIS APPLIANCE WITHOUT CASTERS OR LEGS. If the appliance requires the installation of casters or legs, install them in accordance with the instructions included in your accessory package.**

On an appliance with casters; the installation shall be made with a connector that complies with the Standard for Moveable Gas Appliances, ANSI Z21.69 • CSA 6.16, and a quick disconnect device that complies with the Standard for Quick-Disconnect Devices for Use With Gas Fuel, ANSI Z21.41 • CSA 6.9.

## 2.3 Pre-Connection Preparations

 **DANGER**

**DO NOT connect this appliance to the gas supply before completing each step in this section.**

After the fryer has been positioned under the exhaust hood, ensure the following has been accomplished:

1. Adequate means must be provided to limit the movement of fryers without depending upon the gas line connections. If a flexible gas hose is used, a restraining cable must be connected at all times when the fryer is in use. The restraining cable and installation instructions are packed with the flexible hose in the accessories box that was shipped with your unit.

 **DANGER**

**Do not attach an apron drainboard to a single fryer. The fryer may become unstable, tip over, and cause injury. The appliance area must be kept free and clear of combustible material at all times.**

2. Level fryers equipped with legs by screwing out the legs approximately 1 inch then adjusting them so that the fryer is level and at the proper height in the exhaust hood. Frymaster recommends that the minimum distance from the flue outlet to the bottom edge of the hood be 24 in. (600 mm) when the appliance consumes more than 120,000 BTU per hour. **NOTE:** There are no built-in leveling devices on fryers equipped with casters. The floor where the fryer is to be installed must be level.
3. Test the fryer electrical system:
  - a. Plug the fryer electrical cord(s) into a grounded electrical receptacle.
  - b. Place the power switch in the **ON** position. Verify that the display indicates **CYCL**.
  - c. Place the fryer power switch in the **OFF** position. Verify that the display indicates **OFF**.
4. Refer to the data plate on the inside of the fryer door to determine if the fryer burner is configured for the proper type of gas before connecting the fryer quick-disconnect device or piping from the gas supply line.
5. Verify the minimum and maximum gas supply pressures for the type of gas to be used in accordance with the accompanying tables.

<b>CE Standard for Incoming Gas Pressures for Fryers Manufactured After April 1999</b>					
Gas	Pressure (mbar) <sup>(1)</sup>	Orifice Diameter		Regulator Pressure	
		Single Vat	Dual Vat	Single Vat	Dual Vat
G20	20	2 x 3.40	2 x 3.40	7 mbar	7 mbar
G25	20 or 25	2 x 3.40	2 x 3.40	10 mbar	10 mbar
G30	28/30 or 50	2 x 2.05	2 x 2.05	17 mbar	17 mbar
G31	37 or 50	2 x 2.05	2 x 2.05	20 mbar	20 mbar

(1) mbar = 10,2 mm H<sub>2</sub>O

<b>Non-CE Standard for Incoming Gas Pressures</b>		
Gas	Minimum	Maximum
Natural	6" W.C.	14" W.C.
	1.49 kPa	3.48 kPa
	14.93 mbar	34.84 mbar
LP	11" W.C.	14" W.C.
	2.74 kPa	3.48 kPa
	27.37 mbar	34.84 mbar

6. For fryers equipped with a FootPrint Pro system or basket lifts, plug the electrical cord(s) into a power receptacle behind the fryer.

## 2.4 Connection to Gas Line

**⚠ DANGER**

Before connecting new pipe to this appliance, the pipe must be blown out thoroughly to remove all foreign material. Foreign material in the burner and gas controls will cause improper and dangerous operation.

**⚠ DANGER**

The appliance and its individual shutoff valve must be disconnected from the gas supply piping system during any pressure testing of the system at test pressures in excess of ½ PSI (3.45 kPa, 13.84 inches W.C.) to avoid damage to the fryer's gas tubes and gas valve(s).

**⚠ DANGER**

The appliance must be isolated from the gas supply piping system by closing its individual manual shutoff valve during any pressure testing of the gas supply piping system at test pressures equal to or less than ½ PSI (3.45 kPa, 13.84 inches W.C.)

**⚠ DANGER**

“Dry-firing” your unit will cause damage to the frypot and can cause a fire. Always ensure that cooking oil or water is in the frypot before firing the unit.

**⚠ DANGER**

All connections must be sealed with a joint compound suitable for the gas being used and all connections must be tested with a solution of soapy water before lighting any pilots.

Never use matches, candles, or any other ignition source to check for leaks. If gas odors are detected, shut off the gas supply to the appliance at the main shut-off valve and immediately contact the local gas company or an authorized service agency for service.

The size of the gas line used for installation is very important. If the line is too small, the gas pressure at the burner manifold will be low. This may cause slow recovery and delayed ignition. The incoming gas supply line should be a minimum of 1½” (38 mm) in diameter. Refer to the chart below for the minimum sizes of connection piping.

<b>Gas Connection Pipe Sizes</b>			
(Minimum incoming pipe size should be 1 1/2" (41 mm))			
<b>Gas</b>	<b>Single Unit</b>	<b>2 - 3 Units</b>	<b>4 or more units*</b>
Natural	3/4" (22 mm)	1" (28 mm)	1 1/4" (36 mm)
Propane	1/2" (15 mm)	3/4" (22 mm)	1" (28 mm)
Manufactured	1" (28 mm)	1 1/4" (36 mm)	1 1/2" (41 mm)

\* For distances of more than 20 feet (6 m) and/or more than 4 fittings or elbows, increase the connection by one pipe size.

The Protector® Series gas fryer has received the CE mark for the countries and gas categories indicated in the table below. **NOTE:** The nominal heat input (QN) is 21kW except for AT, DE, LU and category 3P/B, which is 23kW.

CE Approved Gas Categories by Country			
COUNTRIES	CATEGORIES	GAS	PRESSURE (MBAR)
AUSTRIA (AT)	I12H3B/P	G20	20
		G30, G31	50
BELGIUM (BE)	I2E(R)B	G20, G25	20, 25
	I3+	G30, G31	28-30, 37
DENMARK (DK)	I12H3B/P	G20	20
		G30, G31	30
FRANCE (FR)	I12Esi3+	G20, G25	20, 25
		G30, G31	28-30, 37
	I12Esi3P	G20, G25	20, 25
		G31	50
FINLAND (FI)	I12H3B/P	G20	20
		G30, G31	30
GERMANY (DE)	I12ELL3B/P	G20, G25	20
		G30, G31	50
	I3P	G31	50
GREECE (GR)	I12H3+	G20	20
		G30, G31	28-30, 37
ITALY (IT)	I12H3+	G20	20
		G30, G31	28-30, 37
IRELAND (IE)	I12H3+	G20	20
		G30, G31	28-30, 37
LUXEMBOURG (LU)	I12E3B/P	G20	20
		G30, G31	50
NETHERLANDS (NL)	I12L3P	G25	25
		G31	50
	I12L3B/P	G25	25
		G30, G31	30
NORWAY (NO)	I3B/P	G30, G31	30
PORTUGAL (PT)	I12H3+	G20	20
		G30, G31	28-30, 37
SPAIN (ES)	I12H3+	G20	20
		G30, G31	28-30, 37
	I12H3P	G20	20
		G31	37, 50
SWEDEN (SE)	I12H3B/P	G20	20
		G30, G31	30
UNITED KINGDOM (UK)	I12H3+	G20	20
		G30, G31	28-30, 37

### CE Standard

**Required airflow for the combustion air supply is 2m<sup>3</sup>/h per kW.**

1. Connect the quick-disconnect hose to the fryer quick-disconnect under the fryer and to the building gas line.

**NOTE:** Some fryers are configured for a rigid connection to the gas supply line. These units are connected to the gas supply line at the rear of the unit.

When using thread compound, use very small amounts on male threads only. Use a pipe thread compound that is not affected by the chemical action of LP gases (Loctite™ PST56765 Sealant is one such compound). DO NOT apply compound to the first two threads. Doing so may allow some of the compound to enter the gas stream, resulting in clogging of burner orifices and/or the control valve.

2. Open the gas supply to the fryer and check all piping, fittings, and gas connections for leaks. A soap solution should be used for this purpose.
3. Close the fryer drain valve and fill the frypot with water and boil-out solution to the bottom OIL LEVEL line at the rear of the frypot. Light the fryer and perform the boil-out procedures that are described in the “Lighting Instructions” and “Boiling Out the Frypot” topics found in Chapter 3 of this manual.

**⚠ DANGER**

**“Dry-firing” your unit will cause damage to the frypot and can cause a fire. Always ensure that melted shortening, cooking oil, or water is in the frypot before firing your unit.**

4. The burner manifold pressure should be checked at this time by the local gas company or an authorized service agent. The tables below and on the following page list the burner manifold gas pressures for the various gas types that can be used with this equipment.

<b>CE Standard Burner Manifold Gas Pressures for Fryers Manufactured After April 1999</b>		
<b>Gas</b>	<b>Pressure (mbar)</b>	
	<b>Single Vat</b>	<b>Dual Vat</b>
Natural Gas Lacq (G20) under 20 mbar	7	7
Natural Gas Groningue * (G25) under 25 mbar	10	10
Natural Gas Groningue (G25) under 20 mbar	10	10
Butane (G30) at 28/30 or 50 mbar	17	17
Propane (G31) under 37 or 50 mbar	20	20

\* Belgian G25 = 7,0 mbar (single or dual)

<b>Non-CE Standard Burner Manifold Gas Pressures</b>	
<b>Gas</b>	<b>Pressure</b>
Natural	3" W.C. 0.73 kPa
Propane	8.25" W.C. 2.5 kPa

5. Check the programmed temperature thermostat setting. (Refer to chapter 4 *CM7 Computer Instructions*) for the setpoint programming instructions for your particular controller.)

## 2.5 Converting to another Gas Type

### DANGER

This appliance was configured at the factory for a specific type of gas. Converting from one type of gas to another requires the installation of specific gas-conversion components. Conversion instructions are included with conversion kits.

Switching to a different type of gas without installing the proper conversion components may result in fire or explosion. **NEVER ATTACH THIS APPLIANCE TO A GAS SUPPLY FOR WHICH IT IS NOT CONFIGURED!**

Conversion of this appliance from one type of gas to another should only be performed by qualified, licensed, and authorized installation or service personnel, as defined in Section 1.7 of this manual.

Protector® Series gas fryers manufactured for non-CE countries use different burners for each type gas. The burners in fryers built for Propane gas have a special gray-colored coating on the burner tiles to enable them to withstand the higher caloric value of the Propane gas. Burners designed for use in propane units may be used in natural gas applications, but not vice versa.

### Non-CE Gas Conversion Kits

#### Natural Gas to Propane (LP) Gas

Full Vat: Part Number 826-2527

Dual Vat: Part Number 826-2529

#### Propane (LP) Gas to Natural Gas

Full Vat: Part Number 826-2528

Dual Vat: Part Number 826-2530

Units manufactured for export to CE countries are equipped with “universal” burners that may be used with either Natural (G20, G25) gas or Butane (G30) and Propane (G31) gasses.

### CE Gas Conversion Kits for Units with Gas Valve 810-1715

G20 or G25 (Natural) to G30 or G31 Gas:

Part Number 826-1196

G30 or G31 to G20 or G25 (Natural) Gas:

Part Number 826-1197

### CE GAS CONVERSION INSTRUCTIONS

1. Between G20- and G25-type Natural Gas, adjust the gas pressure at the regulator. (Refer to the CE Standard Burner Manifold Gas Pressure Chart.) Do not change the orifice.
2. Between a 2<sup>nd</sup> family (G20 or G25) and a 3<sup>rd</sup> family gas (G30 Butane or G31 Propane):
  - a. Change the orifices.
  - b. Adjust the manifold pressure.
3. Remove the old rating plate and return to Frymaster. Affix the new rating plate included with the conversion kit in place of the old rating plate stating the gas has been converted.
4. If the destination language changes, replace the rating plate. Call your local service agency or KES for a label kit. The language of reference will be on the corner of the label.



## 2.6 Positioning the Fryer

1. Once the fryer has been positioned at the frying station, use a carpenter's level placed across the top of the frypot to verify that the unit is level, both side-to-side and front-to-back.

To level fryers, adjust the casters being careful to ensure the fryer(s) are at the proper height in the frying station.

When the fryer is leveled in its final position, install the restraints provided by the KES to limit its movement so that it does not depend on or transmit stress to the connection. Install the restraints in accordance with the provided instructions. If the restraints are disconnected for service or other reasons, they must be reconnected before the fryer is used.

### DANGER

Hot oil can cause severe burns. Avoid contact. Under all circumstances, oil must be removed from the fryer before attempting to move it to avoid spills, falls, and severe burns. Fryers may tip and cause personal injury if not secured in a stationary position.

### DANGER

Adequate means must be provided to limit the movement of this appliance without depending on the connector and the quick-disconnect device or its associated piping to limit the appliance movement.

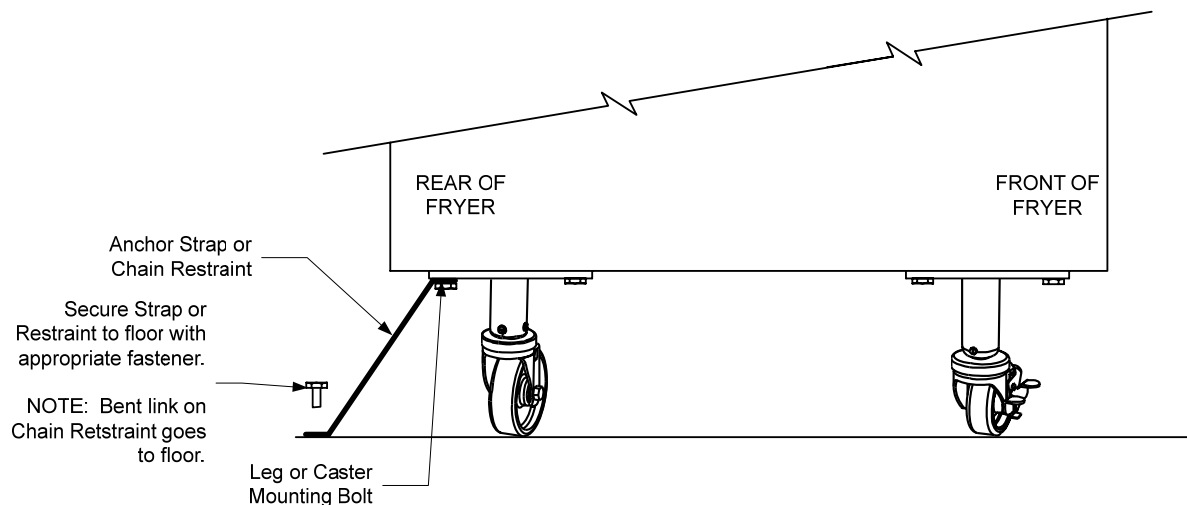

2. Close fryer drain-valve(s) and fill frypot with water to the bottom oil level line.
3. Boil out frypot(s) in accordance with the instructions in Section 4.11 on page 4-16 of this manual.
4. Drain, clean, and fill frypot(s) with cooking oil. (See *Equipment Setup and Shutdown Procedures* in Chapter 3.)

# PROTECTOR® SERIES GAS FRYER

## CHAPTER 3: OPERATING INSTRUCTIONS

### FINDING YOUR WAY AROUND THE PROTECTOR® SERIES GAS FRYER

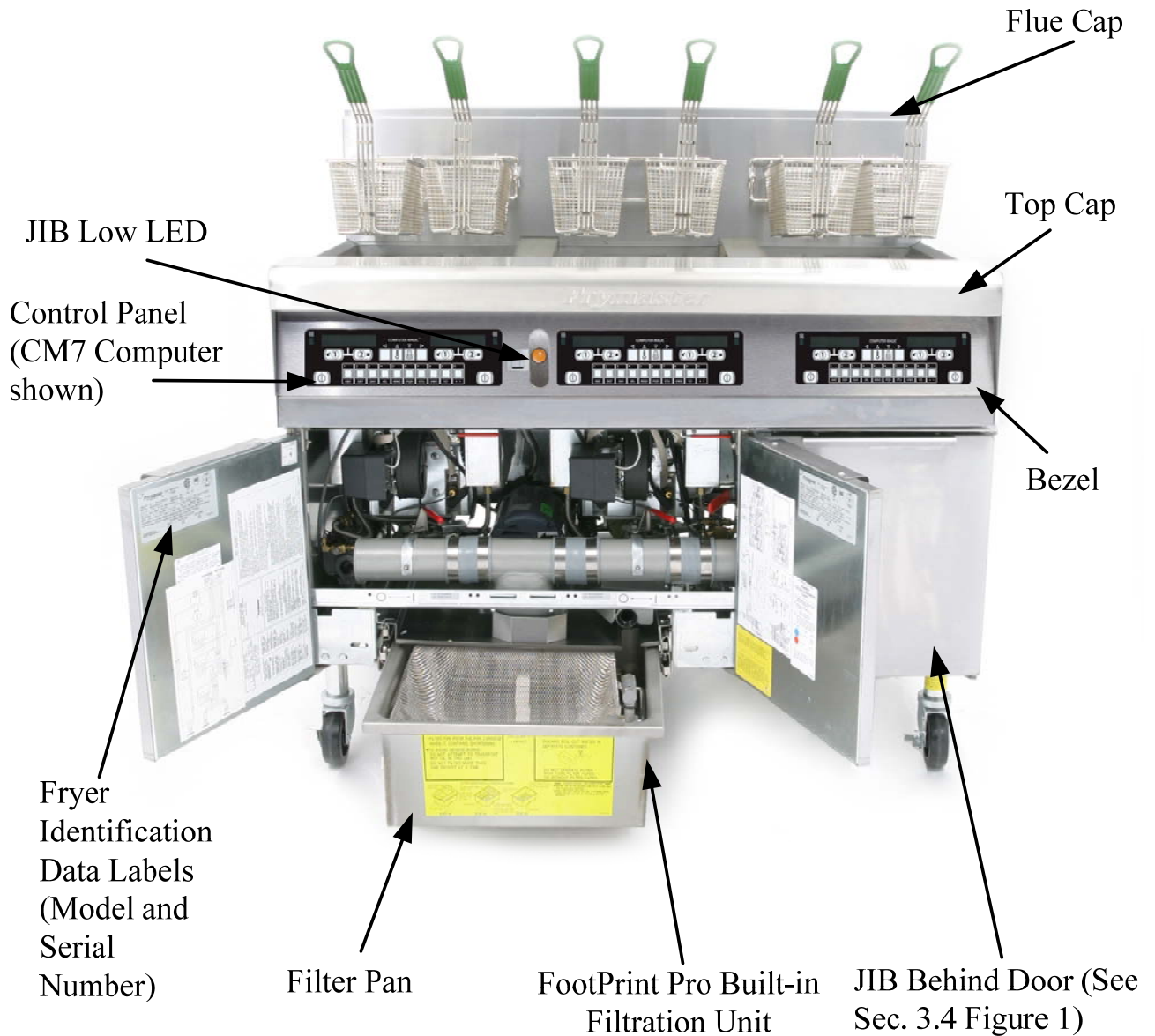

### 3.1 Controller Operation and Programming

Protector<sup>®</sup> Series gas fryers are equipped with CM-7 computers (illustrated below). Refer to the *CM7 Computer Operating Instructions in Chapter 4* for the computer programming and operating procedures.

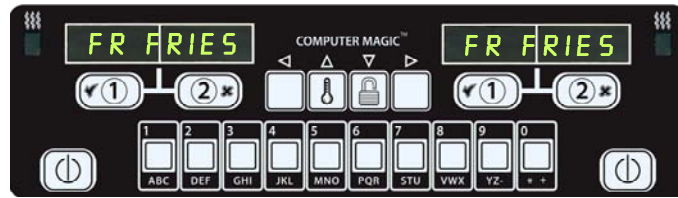

CM7 COMPUTER

### 3.2 Equipment Setup and Start-Up Procedures

#### **⚠ WARNING**

The on-site supervisor is responsible for ensuring that operators are made aware of the inherent hazards of operating a hot oil filtering system, particularly the aspects of oil filtration, draining and cleaning procedures.

#### **⚠ CAUTION**

If this is the first time the fryer is being used after installation, refer to Section 4.11 on page 4-16 for the boil-out procedure.

#### **⚠ CAUTION**

The cooking oil capacity of the Protector<sup>™</sup> Series gas fryer is 32 lbs. (3.8 gallons/14.5 liters) at 70°F (21°C) for a full-vat.

Before lighting the fryer, make sure the fryer is OFF and the frypot drain valve(s) is/are closed. Remove the basket support rack(s), if installed, and fill the frypot to the bottom OIL-LEVEL line.

#### 3.2.1 Setup

#### **⚠ WARNING**

Never operate this appliance with an empty frypot. The frypot must be filled with water or oil before lighting the burners. Failure to do so will damage the frypot and may cause a fire.

#### **⚠ DANGER**

Remove all drops of water from the frypot before filling with oil. Failure to do so will cause spattering of hot liquid when the oil is heated to cooking temperature.

#### **⚠ WARNING**

The Protector<sup>™</sup> is not intended to use solid shortening. Use only liquid shortening with this fryer. The use of solid shortening will clog the top off oil lines.

1. Fill the frypot with cooking oil to the bottom OIL LEVEL line located on the rear of the frypot. This will allow for oil expansion as heat is applied. Do not fill cold oil any higher than the bottom line; overflow may occur as heat expands the oil.
2. Ensure that the power cord(s) are plugged into the appropriate receptacle(s). Verify that the face of the plug is flush with the outlet plate, with no portion of the prongs visible.
3. Ensure that the oil level is at the *top* OIL LEVEL line when the oil is at its cooking temperature.

### 3.2.2 Lighting the Fryer

1. Press the computer ON/OFF switch to the OFF position.

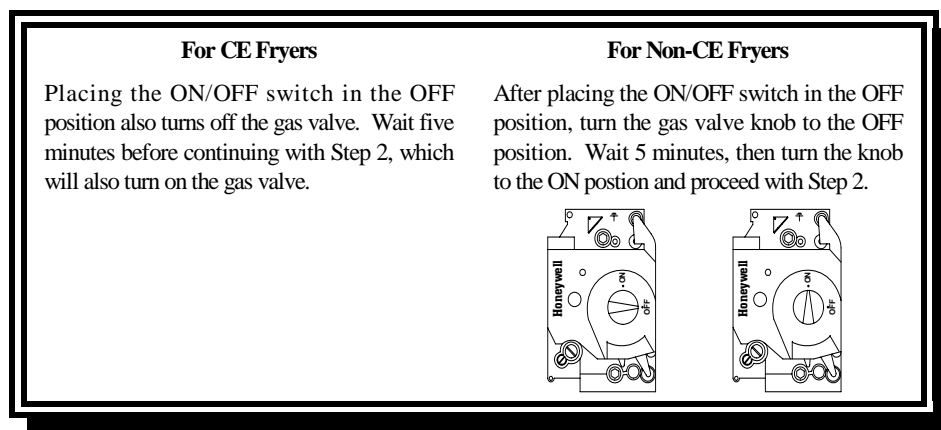

2. Press the computer ON/OFF switch to the ON position and set the thermostat or program the computer for normal cooking temperature.
3. If the burners fail to light, press the ON/OFF switch to the OFF position and wait 60 seconds. Repeat step 2.
4. The fryer will automatically enter the melt cycle mode if the frypot temperature is below 180°F (82°C). (**NOTE:** During the melt cycle, the burners will repeatedly fire for a few seconds, then go out for a longer period.) When the frypot temperature reaches 180°F (82°C), the unit will automatically switch to the heating mode. The burners will remain lit until the frypot temperature reaches the programmed cooking temperature.
5. After the burners have been lit for at least 90 seconds, observe the flames through the burner viewing ports located on each side of the combustion air blower.

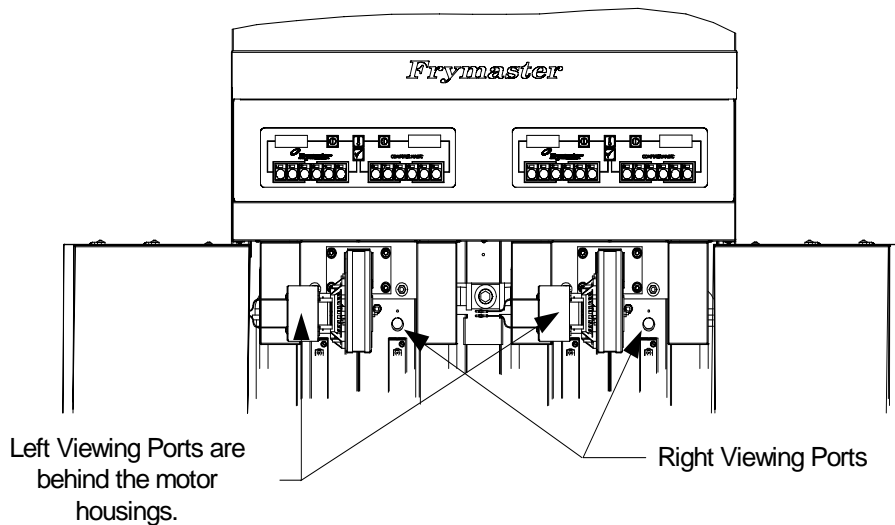

The optimum burn is a bright orange-red glow. If a blue flame is observed, or if there are dark spots on a burner face, adjust the air gas mixture as follows: On the side of the blower housing opposite the motor is a plate with a locking nut. Loosen the nut enough to allow the plate to be moved, then adjust the position of the plate to open or close the air intake opening until a bright orange-red glow is obtained. Carefully hold the plate in position and tighten the locking nut.

### 3.3 Boiling Out the Frypot

To ensure that the frypot is free of any contamination resulting from its manufacture, shipping, and handling during installation, the frypot must be boiled out before first use. Refer to page 4-16 for this procedure.

### 3.4 Shutting the Fryer Down

For short-term shut down during the workday, place the computer ON/OFF switch in the **OFF** position and put the frypot covers in place (if the fryer is so equipped).

When shutting the fryers down at closing time, place the computer ON/OFF switch in the **OFF** position. Then place the gas valve in the off position. See illustration below.

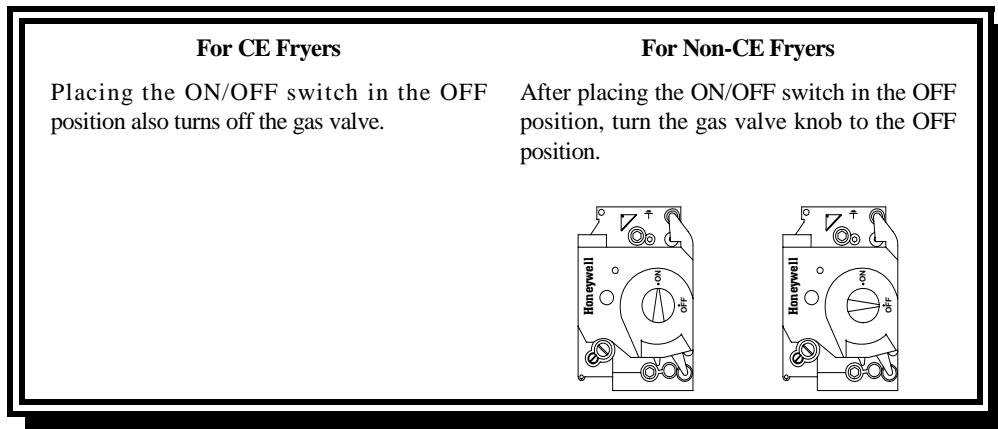

Put the frypot covers in place (if the fryer is so equipped).

### 3.5 Oil Attendant™ Automatic Top-Off

Oil is continually topped off in the frypots from a reservoir in the cabinet. The reservoir holds a 35 pound box of oil. In a typical operation this will last approximately two days before changing.

Components of the system are annotated at the right (see Figure 1).

**NOTE:** The system is intended to top off the frypots, not fill them. The frypots will require manual filling upon startup and after boil out.

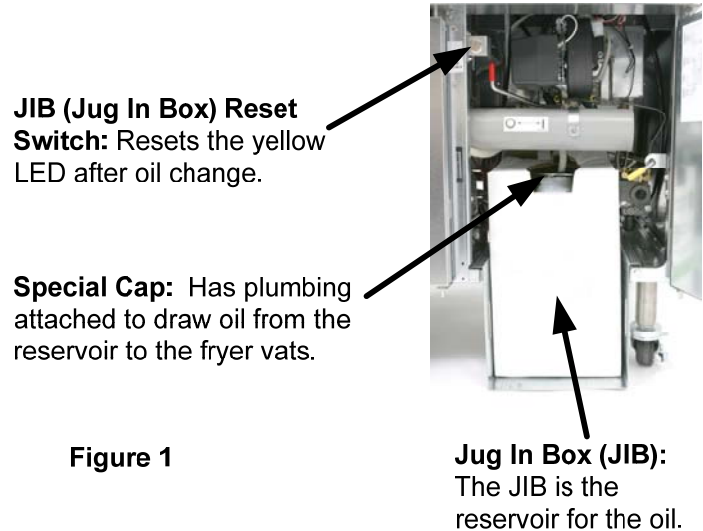

Figure 1

#### 3.5.1 Prepare the System for Use

To prepare the system for its initial operation, remove the cross brace (see Figure 2). Do not replace the screws. Do not remove cross brace before fryer is in its final position. Install the JIB basket shipped in the accessories pack. Follow these instructions to prepare the cabinet for the installation of the first box of oil and subsequent boxes of oil.

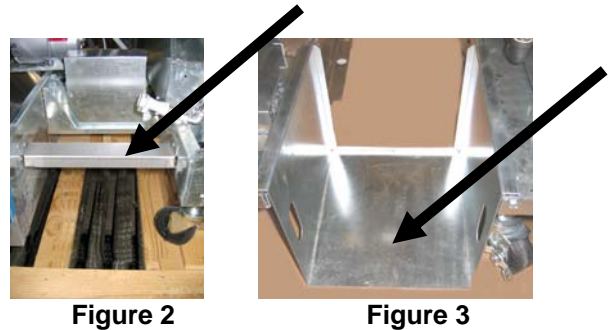

Figure 2

Figure 3

#### 3.5.2 Install the Oil Reservoir

Remove the original lid from the oil container and foil liner. Replace with the provided cap, which has connected suction hardware. Ensure the feeder tube from the cap reaches to the bottom of the oil container.

Place the oil container inside the cabinet and slide it into place (as shown on the following page). Avoid catching the suction hardware on the cabinet interior as the container is placed in the fryer.

The system is now ready for operation. As the fryer heats to preprogrammed temperatures, the system will energize and then slowly add oil to the frypot as needed, until the oil reaches an optimal level.

#### 3.5.3 Routine Oil Changes

When the oil reservoir level is low, the Oil Butler®, a yellow LED, is activated (see Figure 4). Once the reservoir is refilled and/or replaced, pressing the reset button above the JIB turns the LED off.

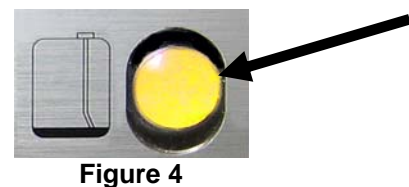

Figure 4

1. Open the cabinet and slide the JIB from the cabinet (see Figure 5).
2. Remove the cap and pour any remaining oil in the container into all fry vats equally (see Figure 6).



Figure 5



Figure 6

3. With the jug upright remove the cap and foil seal (see Figure 7).
4. Put the tube in the new full container (see Figure 8).



Figure 7



Figure 8

**WARNING: Do not add HOT or USED oil to a JIB.**

5. Slide the JIB onto the shelf inside the fryer cabinet (as seen in Figure 5).

6. Press the JIB reset switch to turn the JIB LED off (see Figure 9).



Figure 9

### 3.5.4 Bulk Oil Systems

If using a bulk oil system, see manufacturer's instructions for filling JIB and oil disposal.

**WARNING: Do not add HOT or USED oil to a JIB.**



# PROTECTOR® SERIES GAS FRYERS

## CHAPTER 4: CM7 COMPUTER INSTRUCTIONS

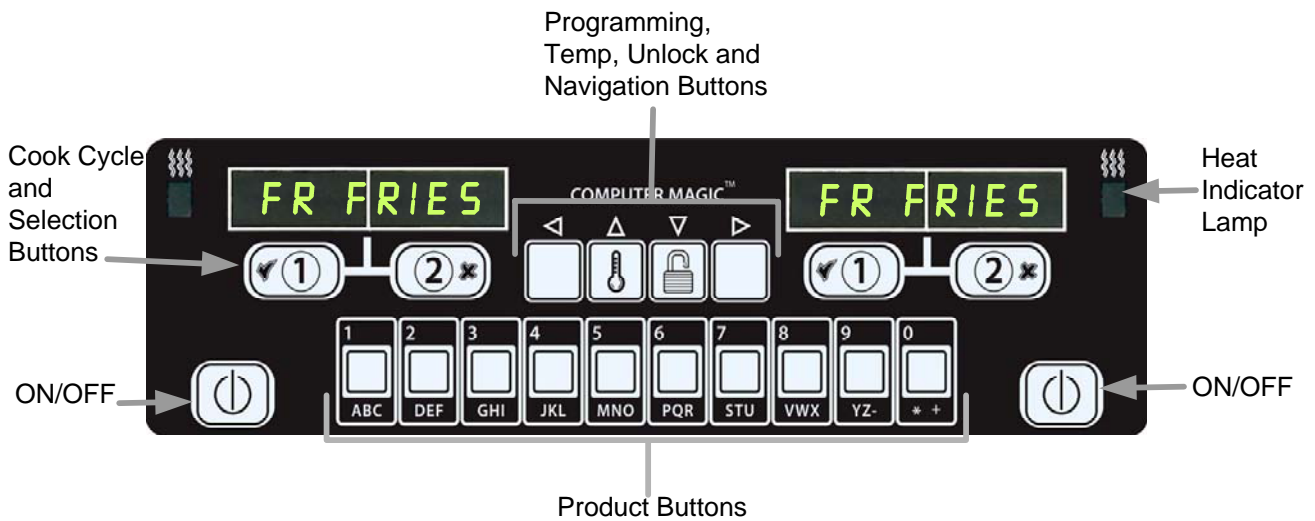

### 4.1 CM7 General Information

Welcome to the CM7, a computer that has one-button cooking and the utility of 40-product menu capability. The computer is easy to use. One button push starts a cook cycle for an item cooked in a dedicated vat. The same flexible computer on a multi-product vat requires only two button pushes to launch a cook cycle. Just choose a menu item on a product buttons and press, and then press a cook cycle button under the display showing the desired item. The computer can move seamlessly from Chicken Strips to Crispy Chicken to any added menu item.



Pressing assigned product buttons displays products.

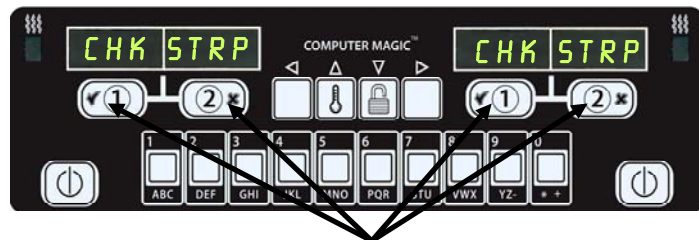

Pressing either cook cycle button under the **CHK STRP** displays launches a cook cycle.

In dedicated mode, the CM7 will display FR FRIES (shown above) and will launch a cook cycle with one push of a cook channel button. In multi-product mode (shown right), the LED display shows dashed lines. To launch a cook cycle, press a product button and then press the cook cycle button that corresponds with the location of the dropped basket. By pressing the product button for Chicken Strips, **CHK STRP** appears in the display. Just press the cook cycle button corresponding to the location of the appropriate dropped basket.



## 4.2 Basic Operation

# Basic Operation

Programming, Temperature,  
Unlock and Navigation Buttons

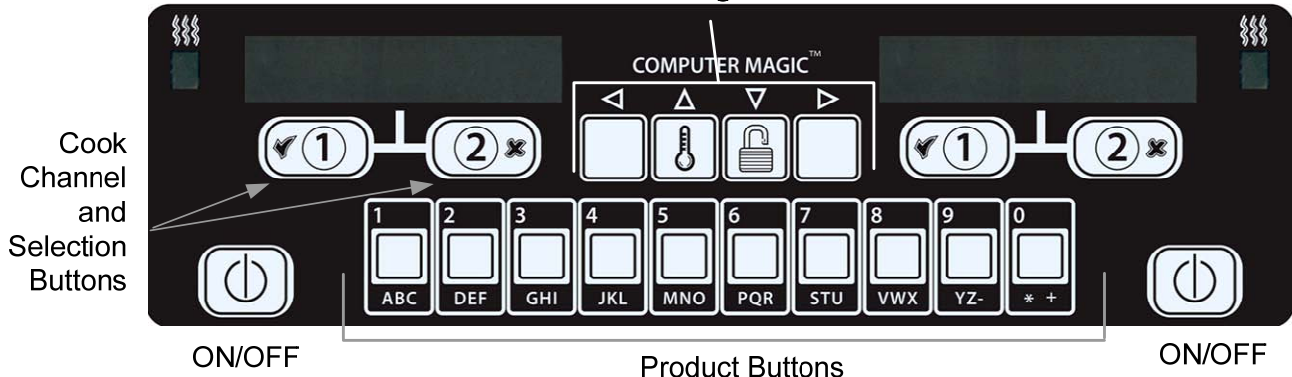

### Turn Fryer ON

Press right key for full pot;  
press key on desired side  
on a split pot.



### Turn Fryer OFF

Press right key for full pot;  
press key on desired side  
on a split pot.



### Check Frypot Temperature

Press Temp key once.  
Displays show frypot  
temperatures.



### Check Frypot Setpoint

Press Temp key twice.  
Displays show frypot  
setpoint temperatures.



### Cancel Shake or Remove Alarm

Press key under active  
display.

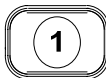

### Start One-Button Cook Cycle (Dedicated Mode)

Press key under display  
showing desired item.



### Product Buttons

### Start Two-Button Cook Cycle (Multi-Product Mode)

Press product key bearing  
icon for desired product.  
Press cook channel button  
to begin cook cycle.

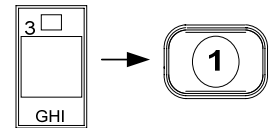

### Change From Dedicated to Multi-Product Mode

Press and hold Cook Channel  
button under displayed menu  
item for approximately three  
seconds until beep is heard.  
Display changes to dashed  
lines.



### Change From Multi-Product Mode to Dedicated Mode

Press product key bearing  
icon for desired product.  
Press cook channel button  
under display showing  
desired item until beep is  
heard (approx three  
seconds).

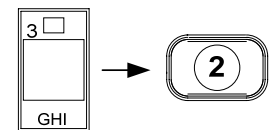

### 4.3 Cooking with Multi-Product Display

# Cooking With Multi-Product Display

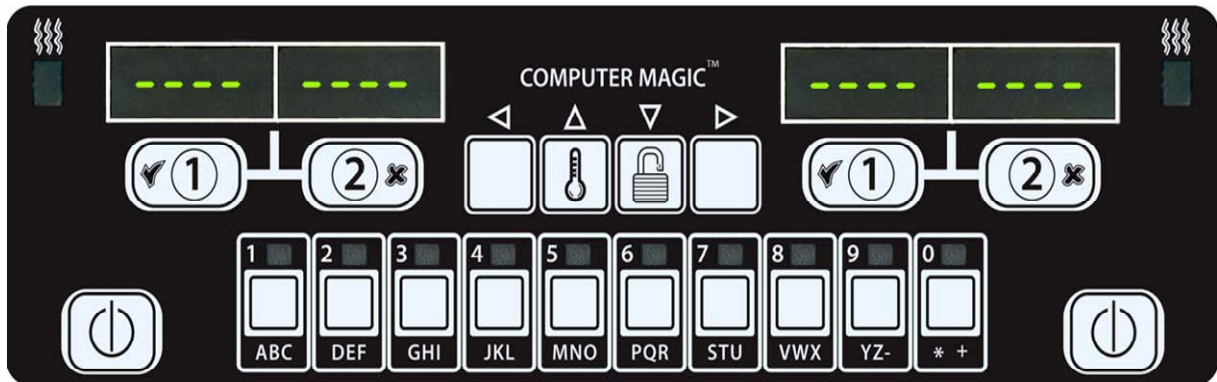

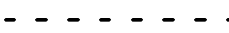
**1** Dashed lines appear in both displays. 

**2** Press a product button.



**3** Vat displays: **CHK STRP**

**4** Press a cook channel button to begin cook cycle.



**5** Display alternates between CK ST and remaining cook time.   
**CK ST**  
 ↑ ↓  
**2:34**

**6** If a shake is required for this menu item, SHAK is displayed when it is time to perform a shake. **SHAK**

**7** Press cook channel button under duty display to cancel alarm.



**8** Cook is displayed when the cook time is complete; an alarm sounds. **COOK**

**9** Press cook channel button under pull display to cancel alarm.



**10** Dashed lines reappear under active display at the end of the cook cycle. 

#### 4.4 Cooking with Dedicated Display

## Cooking With Dedicated Display

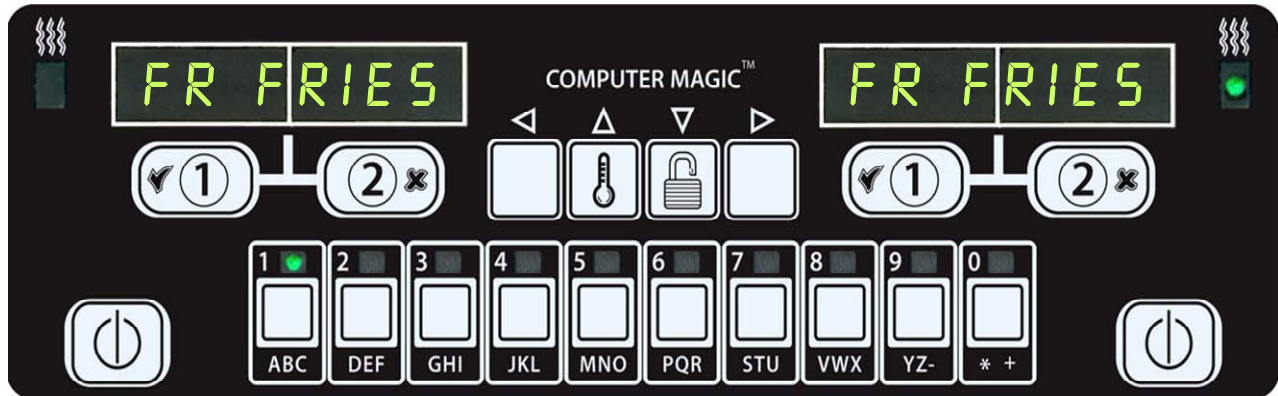

- |  |  |   |  |
|--|--|---|--|
| <p><b>1</b> A menu item, such as FR FRIES shows in display</p>                               |  | <p><b>8</b> H1 is displayed and alternates with FRIS. As the quality time counts down.</p>                            |  |
| <p><b>2</b> Press a cook channel button to begin the cook cycle.</p>                         |  | <p><b>9</b> Pressing the cook channel button now will launch a cook cycle and end the quality countdown.</p>          |  |
| <p><b>3</b> Display alternates between abbreviated product name and remaining cook time.</p> |  | <p><b>10</b> Hold is displayed when the quality time has elapsed.</p>   |  |
| <p><b>4</b> Shak is displayed when it is time to shake the fry basket.</p>                   |  | <p><b>11</b> Pressing the cook channel button restores the display to FR FRIES and the unit is ready for cooking.</p> |  |
| <p><b>5</b> Press cook channel button to cancel alarm.</p>                                   |  |   |  |
| <p><b>6</b> Cook is displayed when the cook cycle is complete.</p>                           |  |   |  |
| <p><b>7</b> Press cook channel button to cancel alarm.</p>                                   |  |   |  |

## 4.5 Changing from Breakfast Setup to Lunch

# Changing from Breakfast Setup to Lunch

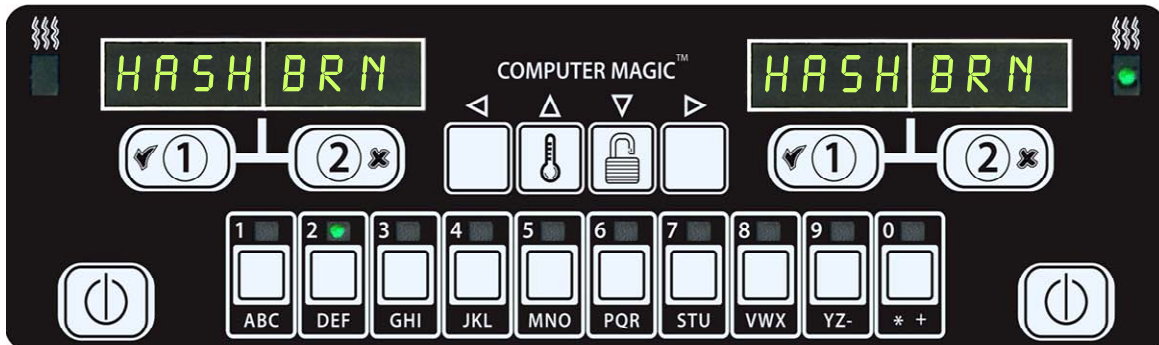

- 1 Press and quickly release product button for french fries.



- 2 Computer will change from HASH BRN to FR FRIES; a beep is heard.

HASH BRN  
↓ ↓ ↓ ↓  
FR FRIES

- 3 Press and hold the cook channel button under the display until a beep is heard.



- 4 Display changes to FR FR FRIES FRIES.

*Change both displays to FR FRIES*

## 4.6 Changing from Lunch Setup to Breakfast

# Changing from Lunch Setup to Breakfast

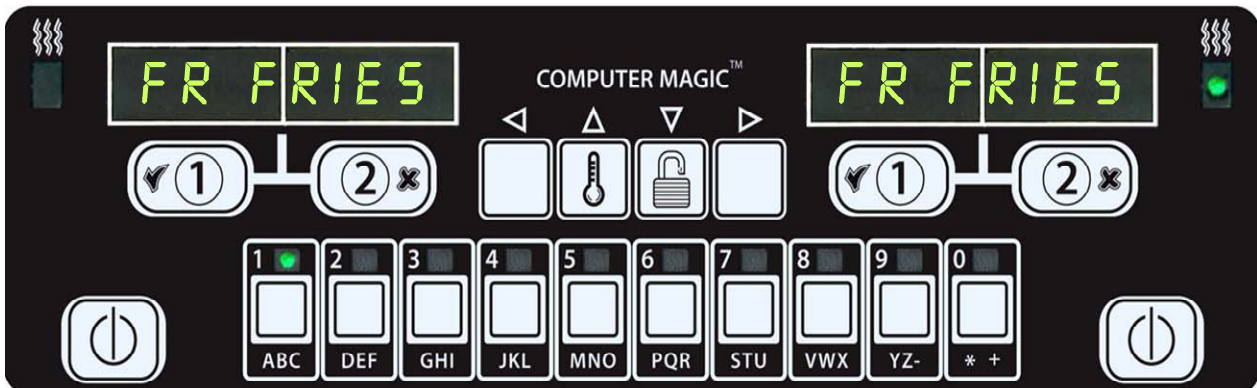

**1** Computer displays **FR FRIES**

**2** Press and quickly release product button for hash browns.



**3** Computer display will change from FR FRIES to HASH BRN; a beep sounds.

**FR FRIES**  
↓ ↓ ↓ ↓  
**HASH BRN**

**4** Press and hold the cook channel button under the display until a beep is heard.



**5** Display changes to Hash Brn. **HASH BRN**

## 4.7 CM7 Button Description and Functions

### 4.7.1 Navigation Buttons

The menu on the CM7 uses ◀ ▶ and ▲ ▼ buttons to navigate the various menus and submenus (see Figure 1).



Figure 1

When programming, the left screen shows a menu or submenu item. The right screen is for data entry. Data is entered with alpha-numeric characters, scrolling through lists or by toggling between choices.

During programming, if a button is not pushed within one minute, the computer returns to operation mode.

### 4.7.2 Temperature and Unlock Buttons

The **TEMP** button (see Figure 1), if pressed once while the fryer is on, displays current vat temperature on both sides. If the **TEMP** button is pressed twice, it shows the setpoint temperatures of the vats. If the fryer is off, the display shows the current versions of software. The **UNLOCK** button (see Figure 1), if pressed once while the fryer is on, shows the recovery time for each vat from the last test. Recovery displays the time required for the fryer to raise the temperature of the oil 50°F (28°C) between 250°F (121°C) and 300°F (149°C). Maximum recovery time should not exceed 1:40 for electric or 2:25 for gas. If the fryer is off, pressing the unlock button once allows access to Program Mode; pressing twice allows access to Manager Mode and pressing three times allows access to Tech Mode.

### 4.7.3 Cook Cycle and Selection Buttons

The ✓ and ✕ buttons are dual-function buttons shared with the number **1** and **2** buttons. They are located directly below the LED displays (see Figure 2). Use these buttons to select or cancel functions. The ✕ button is used to back out of submenus.

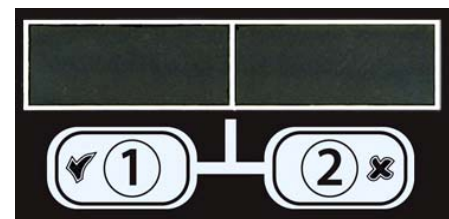

Figure 2

### 4.7.4 Melt Cycle and Cooking Displays

Once the computer is switched on, it displays **CYCL** during melt cycle until the oil reaches 180°F (82°C). The display changes to **LOW TEMP** until setpoint is reached. Once setpoint is reached, the computer will display dashed lines or the product name

## 4.8 CM7 Menu Summary Tree

Reflected below are the major programming sections in the CM7 and the order in which submenu headings will be found under the sections in the Installation and Operation Manual.

<b>Adding New Product Menu Items</b>	See section 4.10.2
<b>Storing Product Menu Items in Product Buttons</b>	See section 4.10.3
<b>Temperature Conversion from F° to C°</b>	See section 4.10.4

### CM7 Programming Menu

Programming	
└─ Program Mode.....	4.11
[With the fryer OFF, press the UNLOCK button once, displays <i>PROGRAM</i> . Press the ✓. Enter 1650]	
└─ Setpoint Temperature.....	4.11.1
└─ Product Selection.....	4.11.2
└─ Name	
└─ Cook Time	
└─ Cook ID	
└─ Shake Time	
└─ Hold Time	
└─ Filt After	
└─ Sensitivity	
└─ Assign Btn	
└─ Boil Out Mode.....	4.11.3
Manager Mode.....	4.12
[With the fryer OFF, press the UNLOCK button twice, displays <i>MANAGER</i> . Press the ✓. Enter 4321]	
└─ E-Log	
└─ Alert Tone	
└─ Volume 1-9	
└─ Tone 1-3	
Tech Mode.....	4.9
[With the fryer OFF, press the UNLOCK button three times, displays <i>TECH</i> . Press the ✓. Enter 7378]	
└─ Setup	
└─ Fryer Setup	

## 4.9 Setup Mode Programming

The computer, upon initial power up or when accessed from Tech Mode, enters setup mode. These parameters need to be set to allow the computers functions to operate correctly. The setup sets the time, date, date format, language, fryer type, vat type, oil system type and the temperature format. These settings should only be changed by a technician.

On initial power up the computer displays **OFF**

1. Press either soft power button (see Figure 3) or with the computer **OFF**, enter Tech Mode by pressing the **UNLOCK** button three times (see Figure 4).

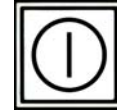

Figure 3



Figure 4

2. The computer displays **TECH** if initially powering up the computer or if entering setup through Tech Mode. Press the ✓ (1) button to continue (see Figure 5).



Figure 5

The computer displays **CODE**.

3. Enter **7378 (SERV)** (see Figure 6).

The computer displays **TECH MODE** changing to **SETUP**.

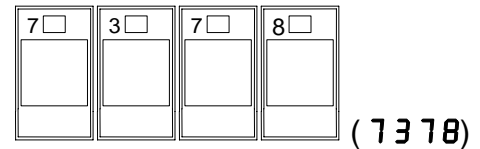

Figure 6

The computer displays **FRYER SETUP** changing to **TIME FORMAT**.

4. Press the ✓ (1) button to continue (see Figure 7).



Figure 7

Computer displays **TIME FORMAT** with format on the right.

5. Use the ◀ and ▶ buttons (see Figure 8) to toggle between **24HR** and **12HR**.



Figure 8

6. With the desired selection displayed, press the ✓ (1) button (see Figure 9).



Figure 9

The computer displays **ENTER TIME** on the left and **HH:MM** on the right.

Example: 7:30 AM is entered 0730 if using the 12 hour format. 2:30 is entered 1430 if using 24 hour format.

7. Enter time in hours and minutes using the number buttons 0-9 (see Figure 10).



Figure 10



8. With the desired selection displayed, press the ✓ (1) button (see Figure 11).



Figure 11

The computer displays **ENTER TIME** on the left and **AM** on the right if 12 hours system is chosen.

9. Use the ◀ and ▶ buttons (see Figure 12) to toggle between **AM** and **PM**.

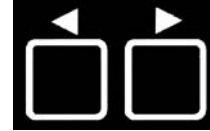

Figure 12

10. With the desired selection displayed, press the ✓ (1) button (see Figure 13).



Figure 13

The computer displays **DATE FORMAT** on the left and **US** on the right.

11. Use the ◀ and ▶ buttons (see Figure 14) to toggle between **US** and **INTERNL.**



Figure 14

The computer displays **ENTER DATE** on the left and **MM-DD-YY OR DD-MM-YY** on the right.

Example:

US Format – Mar. 15, 2007 is entered as 031507.

International Format – 15 Mar. 2007 is entered as 150307)

12. Enter the date using the number buttons 0-9 (see Figure 15).



Figure 15

13. With the desired selection displayed, press the ✓ (1) button (see Figure 16).



Figure 16

The computer displays **LANGUAGE** on the left and **ENGLISH** on the right.

14. Use the ◀ and ▶ buttons to scroll through the language menu (see Figure 17).



Figure 17

Current languages supported by the CM7 are: English, French, French Canadian, Spanish, Portuguese, German and Swedish.

15. With the desired selection displayed, press the ✓ (1) button (see Figure 18).



Figure 18

The computer displays **FRYER TYPE** on the left and **ELEC** on the right.

16. Use the ◀ and ▶ buttons (see Figure 19) to toggle between **ELEC** and **GAS**.



Figure 19

17. With the desired selection displayed, press the ✓ (1) button (see Figure 20).



Figure 20

The computer displays **VAT TYPE** on the left and **SPLIT** on the right.

18. Use the ◀ and ▶ buttons (see Figure 21) to toggle between **SPLIT** and **FULL**.



Figure 21

19. With the desired selection displayed, press the ✓ (1) button (see Figure 22).



Figure 22

The computer displays **OIL SYSTEM** on the left and **JIB** on the right.

20. Use the ◀ and ▶ buttons (see Figure 23) to toggle between **JIB** and **BULK**.



Figure 23

**NOTE:** A **JIB** system uses a disposable JIB (Jug in a Box). A **BULK** system has large storage oil tanks that are connected to the fryer.

21. With the desired selection displayed, press the ✓ (1) button (see Figure 24).



Figure 24

The computer displays **TEMPERATURE** on the left and **F** on the right.

22. Use the ◀ and ▶ buttons (see Figure 25) to toggle between **F** and **C** temperature scales.



Figure 25

**NOTE:** **F** is used for Fahrenheit, **C** is used for Celsius.

23. With the desired selection displayed, press the ✓ (1) button (see Figure 26).



Figure 26

The computer displays **FRYER SETUP** for three seconds then **OFF**.

## 4.10 CM7 Common Tasks

Covered in this section are common tasks used in stores:

1. Escaping out of a menu or sub-menu.
2. Adding new product items.
3. Storing menu items in product buttons.
4. Temperature conversion from F to C.

### 4.10.1 Escape Menu Items

To escape from **MENUS** or **SUB-MENUS**, press the **✕ (2)** button (Figure 27).



Figure 27

### 4.10.2 Adding New Product Items to the Menu

To add a new product to the menu:

1. With the computer **OFF**, enter Program mode by pressing the **UNLOCK** button once (see Figure 28).



Figure 28

The computer displays **PROGRAM**.

2. With the desired selection displayed, press the **✓ (1)** button (see Figure 29).



Figure 29

The computer displays **ENTER CODE** and sounds an audible alert.

3. Enter **1650** (see Figure 30).

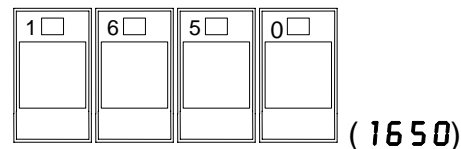

Figure 30

The computer displays **PROGRAM MODE** changing to **SETPOINT TEMPERATURE**.

4. Press the **✓ (1)** button to continue (see Figure 31).



Figure 31

Computer displays **TEMP** on the left and a temperature on the right.

5. Enter the desired cooking temperature using the number buttons 0-9 (see Figure 32).



Figure 32

- With the desired temperature entered, press the ▼ button (see Figure 33) two times to lock in the setpoint and continue.



Figure 33

The computer displays **PRODUCT SELECTION**.

- With **PRODUCT SELECTION** displayed, press the ✓ (1) button (see Figure 34).



Figure 34

Computer displays **PRODUCT SELECTION** changing to **SELECT PRODUCT**.

- With **SELECT PRODUCT** displayed on the left and **PROD 1** displayed on the right use the ► button (see Figure 35) to advance through menu items until the right display displays the menu item to be modified or the desired location for a new product.



Figure 35

- Press the ✓ (1) button to select the product to modify (see Figure 36).



Figure 36

The computer displays **MODIFY** alternating with **YES NO**.

- Press the ✓ (1 **YES**) button (see Figure 37).



Figure 37

The left display displays **NAME** and the right display displays a product name (ex. **PROD 1**). The right display shows a blinking cursor alternating with a blinking letter under the first character.

- Using the number keys, enter the first letter of the new product (see Figure 38). Press the key until the desired letter appears.



Figure 38

- Press the ► button to advance the cursor to the next display space (see Figure 39). Use the #0 key to insert a space. The ◀ button can be used to move the cursor back.



Figure 39

For example, to enter “**WINGS**”, press the #8 key two times until **W** appears in the display. Then use the ► button to advance the cursor to the next display space. Press the #3 key until **I** appears. Continue on until **WINGS** is spelled out on the display. Use no more than eight letters.

- With the name entered, press the ▼ button (see Figure 40) to save the name and scroll to **COOK TIME**.



Figure 40

- With **COOK TIME** displayed on the left and **:00** or a previously entered cook time displayed on the right, use the number keys (see Figure 41) to enter the product cook time in minutes and seconds (ex. 3:00 as 300).



Figure 41

15. Press the ▼ button (see Figure 42) to save the **COOK TIME** and scroll to the **COOK ID**.



Figure 42

16. A blinking **P 1** is displayed on the right. Follow the instructions in step eleven to enter a four-letter name for the products which alternates with the cook time during a cook cycle.

17. Press the ▼ button (see Figure 43) to save the cook ID abbreviation and scroll to the **SHAKE TIME**, which is used to set the time in the cook cycle the product should be shaken.



Figure 43

18. Use the number keys (see Figure 44) to enter the elapsed time in minutes and seconds, before a shake is required.



Figure 44

19. Press the ▼ button (see Figure 45) to save shake time and scroll to **HOLD TIME**. Hold time is the amount of time a product should be held before being discarded.



Figure 45

20. Use the number keys (see Figure 46) to enter the time in minutes and seconds the product should be held before discarding. (ex. If the product requires discarding after 10 minutes, enter 1000).



Figure 46

21. Press the ▼ button (see Figure 47) to save hold time and scroll to **FILT AFTER**. Filtration after is the number of cook cycles before a filter prompt.



Figure 47

22. Use the number keys (see Figure 48) to enter the number of cook cycles before the fryer prompts for filtration. (ex. If the product requires filtration after every six cook cycles, enter 6).



Figure 48

**NOTE:** Setting the **FILT AFTER** to “0” will disable filtration prompts.

23. Press the ▼ button (see Figure 49) to save **FILT AFTER** and scroll to **SENSITIVITY**.



Figure 49

Sensitivity is a built-in feature, which adjusts cooking time to compensate for the drop in frypot temperature when a product enters the oil. Different products vary in density, batch size, and temperature. Food products will also vary in cook time. A proper sensitivity setting will assure a high-quality product. Setting zero is the least sensitive and setting nine is the most sensitive. The default setting is 0. Some menu items may need an adjustment, depending on their cooking characteristics. A chart is provided on page 4-21 to assist in choosing a sensitivity setting. It is meant as a guide only and the settings may be changed to suit different needs. **Use caution when changing sensitivity, as it could have an adverse affect on the products cooking cycles.**

24. With **SENSITIVITY** displayed on the left and **0** displayed on the right, use the number keys (see Figure 49) to enter a number between 0-9.



Figure 49

25. Press the ▼ button (see Figure 50) to save sensitivity and scroll to **ASSIGN BTN**.



Figure 50

26. Press and hold for three seconds an unassigned button between 1-0 to assign the product. The LED in the chosen product button will illuminate (see Figure 51). To unassign a product from a button, press and hold the button assigned to that product for three seconds. The LED no longer illuminates.



Figure 51

27. Press the ▼ button (see Figure 52) to save the assigned button.



Figure 52

The computer displays **NAME** on the left with the product (ex. **WINGS**) on the right.

- \* Note: If additional programming, to add other products, is necessary press the \* (2) button (see Figure 53) once and then the ► button (see Figure 54) and return to step 8.



Figure 53



Figure 54

28. If no further programming is necessary, press the \* (2) button three times (see Figure 55). The computer displays **OFF**.



Figure 55

### 4.10.3 Storing Menu Items in Product Buttons

This function is used to store individual menu items in product buttons for one or two button cooking.

To store menu items to a specific button:

1. Perform steps 1-10 on pages 4-12 thru 4-13.
2. The computer displays **NAME** on the left and the selected product (ex. **WINGS**) on the right.
3. Press the ▲ button (see Figure 56) to scroll to the **ASSIGN BTN** option used to assign a menu item to a specific product button.
4. The computer displays **ASSIGN BTN** on the left and **WINGS** on the right.
5. Press and hold for three seconds a button between 1-0 to assign the product. The LED in the chosen product button will illuminate (see Figure 57). To unassign a product from a button, press and hold the button assigned to that product for three seconds. The LED no longer illuminates.



Figure 56



Figure 57



- Once the button is assigned, press the ▼ button (see Figure 58) to save the assigned button.



Figure 58

The computer displays **NAME** on the left with the product (ex. **WINGS**) on the right.

- If no further programming is necessary, press the ✖ (2) button (see Figure 59) twice to return to **SETPOINT TEMPERATURE** prompt.



Figure 59

- Press the ✖ (2) button again to exit and to return to **OFF** (see Figure 60).



Figure 60

#### 4.10.4 Temperature conversion from F° to C°.

- With the computer **OFF**, enter Tech mode by pressing the **UNLOCK** button three times (see Figure 61).



Figure 61

The computer displays **TECH**

- With the desired selection displayed, press the ✓ (1) button (see Figure 62).



Figure 62

The computer displays **CODE** and sounds an audible alert.

- Enter **1658** (see Figure 63).

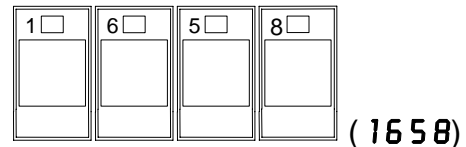

Figure 63

Switch computer on to see if temperature scale changed. If not, repeat steps 1-3.

### 4.11 Boil-Out Mode

Before the fryer is first used, it should be boiled out to ensure that residue from the manufacturing process has been eliminated. Also, after the fryer has been in use for a period of time, a hard film of caramelized oil will form on the inside of the frypot. This deposit must be periodically removed to maintain your fryer's efficiency.



**DANGER**

**Allow oil to cool to 100°F (38°C) or lower before draining to an appropriate METAL container for disposal.**

- Drain the frypot in accordance with Section 5.1 (page 5-1), *but do not refill with cooking oil.*
- After draining the frypot, clean all food particles and residual oil from the frypot and filter pan (if so equipped). **BE CAREFUL**, this material may still cause severe burns if it comes in contact with bare skin.
- Close the drain valve securely and fill the frypot with a solution of automatic dishwasher detergent (or commercially available boil-out solution) and cold water to the bottom **OIL-LEVEL** line.

**⚠ DANGER**

Never leave the fryer unattended during the boil-out process. If the boil-out solution boils over, press and hold the \* (2) button for five seconds, then release the button to cancel boil-out immediately and let the solution cool for a few minutes before resuming the process.

5. With the computer **OFF**, press the **UNLOCK** button once (see Figure 64).



Figure 64

The computer displays **PROGRAM**.

6. Press the ✓ (1) button (see Figure 65).



Figure 65

The computer displays **ENTER CODE** and sounds an audible alert.

7. Enter **1650** (see Figure 66).

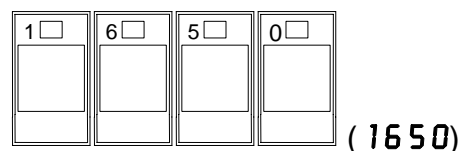

Figure 66

The computer displays **PROGRAM MODE** changing to **SETPOINT TEMPERATURE**.

8. Press the ▼ button to scroll to **BOIL-OUT MODE** (see Figure 67).



Figure 67

9. Press the ✓ (1) button to continue (see Figure 68).



Figure 68

The computer displays **BOIL OUT**, alternating with **YES NO**.

10. Press the ✓ (1 **YES**) button to continue the boil out process (see Figure 69).



Figure 69

**⚠ CAUTION**

Ensure the frypot is filled with a mixture of cold water and detergent before starting boil-out.

The computer displays **STRT BOIL**, alternating with **YES NO**.

11. Press the ✓ (1 **YES**) button to start boil-out (see Figure 70).



Figure 70

The computer displays **BOILOUT** on both sides. The fryer heats to 195°F (91°C).

12. Let the solution simmer for one hour. Do not allow the water level to drop below the bottom oil-level line in the frypot during the boil-out operation.

13. Press and hold the \* (2) button for five seconds. Release the button to cancel boil-out when it is finished. The fryer turns OFF. Drain the solution and close the drain valve.



14. Allow the solution to cool to 100°F (38°C), then drain into a METAL stockpot or similar METAL container. When draining is finished, close the fryer drain valve securely.

 **DANGER**

**Allow solution to cool to 100°F (38°C) before draining into an appropriate METAL container for disposal.**

 **WARNING**

**Do not drain boil-out solution into a shortening disposal unit (SDU), a built-in filtration unit, or a portable filter unit. These units are not intended for this purpose, and will be damaged by the solution.**

15. Add two gallons (7.6 liters) of water. Drain out the solution and clean the frypot(s) thoroughly.
16. Refill the frypot(s) with clean water. Rinse the frypot(s) twice, drain and dry with a clean towel. Thoroughly remove all water from the frypot and elements before refilling the frypot with oil.

 **DANGER**

**Ensure that the frypot is completely free of water before filling with oil. Failure to do so will cause splattering of hot liquid when the oil is heated to cooking temperature.**

#### 4.11.1 Clean Filter Pan, Detachable Parts and Accessories

As with the frypot, a deposit of carbonized oil will accumulate on the filter pan and detachable parts and accessories such as baskets, sediment trays, or fish plates.

Wipe the filter pan and all detachable parts and accessories with a clean cloth dampened with a detergent solution (or the parts can be run through a dishwasher). Rinse and thoroughly dry each part. **DO NOT** use steel wool or abrasive pads to clean these parts. The scratches that result from such scrubbing make subsequent cleanings more difficult.

 **WARNING**

**Use a commercial-grade cleaner formulated to effectively clean and sanitize food-contact surfaces. Read the directions for use and precautionary statements before use. Particular attention must be paid to the concentration of cleaner and the length of time the cleaner remains on the food-contact surfaces.**

## 4.12 Manager Mode

1. With the computer **OFF**, press the **UNLOCK** button twice (see Figure 71).

The computer displays **MANAGER** and sounds an audible alert.



2. Press the **✓ (1)** button (see Figure 72).

The computer displays **ENTER CODE** and sounds an audible alert.



3. Enter **4321** (see Figure 73).

The computer displays **MANAGER MODE** changing to **E-LOG**.

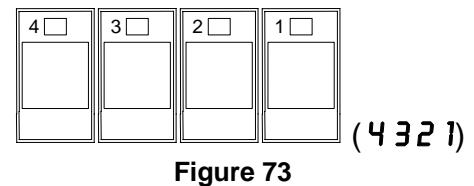

The E-LOG mode is used to view the ten most recent error codes encountered on the fryer. These codes are displayed from 1-10 with the most recent displayed first. The time, date and error code are displayed.

4. Press the **✓ (1)** button to accept selection (see Figure 81).



5. Use the **▲** and **▼** buttons to scroll through the ten most recent error codes.

If no errors exist, the computer displays **NO ERRORS**. Errors are displayed by error code, time and date.

### Error Codes:

**E01 - Right Remove Discard**

**E02 - Left Remove Discard**

**E03 - Probe Failure - Call Technician**

**E04 - Hi Limit 2 - Call Technician**

**E05 - Hot Hi 1 - Call Technician**

**E06 - Ignition Failure - Call Technician**

6. Press the **\* (2)** button (see Figure 75) once.

The computer displays **ALERT TONE**.



The alert tone mode allows a manager to adjust the volume to nine levels and the tone is adjustable to three frequencies. One of three audio frequencies may be chosen to distinguish fryers in kitchens with multiple fryers.

7. Press the **✓ (1)** button (see Figure 76).

Computer displays **VOLUME 1-9**.



8. Press the ✓ (1) button (see Figure 77).



Figure 77

The computer displays **VOLUME 1-9** on the left and **1** on the right.

9. Use the number keys to set volume level (see Figure 78). Select from nine levels of volume with 0 being off, 1 the softest and 9 the loudest.



Figure 78

10. Press the ▼ UNLOCK button to accept the selection and to scroll to **TONE 1-3** (see Figure 79).



Figure 79

Computer displays **TONE 1-3**.

11. Press the ✓ (1) button (see Figure 80).



Figure 80

The computer displays **TONE 1-3** on the left and **1** on the right.

12. Use the number keys, to set the tone frequency (see Figure 81). Select from three different frequencies.



Figure 81

13. Press the \* (2) button again (see Figure 82) to return to **MANAGER MODE** changing to **E-LOG**.



Figure 82

14. Press the \* (2) button again (see Figure 83) to quit and to return to **OFF**.



Figure 83

## 4.13 SENSITIVITY SETTINGS CHART

### *Sensitivity Settings for Various Products*

Product	350° F/176° C	Sensitivity Setting
<b>Chicken</b>		
chicken fillet, 1 ¼ oz.	3:25	5
chicken fillet (frozen), 4 oz.	4:20	5
chicken patty (frozen), 5 oz.	6:15	5
frozen chicken		5
fresh chicken, 9 pieces		5
<b>Potatoes</b>		
steak fries	3:43	5
regular fries, ½-inch	3:16	5
shoestrings, ¼-inch	1:50	5
shoestrings, 3/8-inch	2:40	5
tater tots	2:05	5
hash browns	2:05	5
farm fries	1:14	5
<b>Seafood</b>		
crab cakes	4:00	3
clam cakes	4:00	3
large scallops	3:25	3
small scallops	1:10	3
shrimp (35 to a lb.)	2:15	3
shrimp (40 to 75 to a lb.)	1:45	3
shrimp (75 to 100 to a lb.)	1:10	3
cod, 2 ½ oz.	3:25	7
flounder fillet, 7 oz.	4:35	3
flounder, whole, 10-12 oz.	6:25	3
cod fillet, 3 ½ oz.	4:35	7
perch, 5 oz.	4:30	3
haddock, 7 oz.	6:25	7
clams	2:00	3
oysters	1:10	4
strip clams (fresh)	0:35	4
strip clams (frozen)	0:45	4
<b>Vegetables</b>		
okra	4:30	4
eggplant	4:00	4
zucchini	3:00	4
mushrooms	3:45	4
onion rings (frozen)	3:00	4
cauliflower	1:45	4
<b>Other</b>		
corn dogs		4
chicken fried steak patty	5:00	5

**Note:** This chart is provided to assist in choosing a sensitivity setting. It is meant as a guide only and the settings may be changed to suit different needs.

# PROTECTOR® SERIES GAS FRYERS

## CHAPTER 5: FILTRATION INSTRUCTIONS

---

### WARNING

The on-site supervisor is responsible for ensuring that operators are made aware of the inherent hazards of operating a hot oil filtering system, particularly the aspects of oil filtration, draining and cleaning procedures.

### 5.1 Draining and Manual Filtering

### DANGER

Draining and filtering of cooking oil must be accomplished with care to avoid the possibility of a serious burn caused by careless handling. The oil to be filtered is at or near 350°F (177°C). Ensure all hoses are connected properly and drain handles are in their proper position before operating any switches or valves. Wear all appropriate safety equipment when draining and filtering oil.

### DANGER

Allow oil to cool to 100°F (38°C) before draining into an appropriate container for disposal.

### DANGER

Do not drain more than one frypot at a time into the built-in filtration unit to avoid overflow and spillage of hot oil that may cause severe burns, slipping and falling.

### DANGER

When draining oil into a disposal unit or portable filter unit, do not fill above the maximum fill line located on the container.

Oil must be drained into the filter pan, SDU or another suitable METAL container. (For safe, convenient draining and disposal of used oil or shortening, Frymaster recommends using the Frymaster Shortening Disposal Unit (SDU). The SDU is available through your local distributor.)

1. Turn the fryer power switch to the **OFF** position.
2. Position a METAL container with a sealable cover under the drainpipe. The METAL container must be able to withstand the heat of the oil and hold hot liquids. If you intend to reuse the oil or shortening, Frymaster recommends that a Frymaster filter cone holder and filter cone be used when a filter machine is not available. If you are using a Frymaster filter cone holder, be sure that the cone holder rests securely on the metal container.
3. Open the drain valve slowly to avoid splattering. If the drain valve becomes clogged with food particles, use the Fryer's Friend (poker-like tool) to clear the blockage.

**⚠ DANGER**

**NEVER attempt to clear a clogged drain valve from the front of the valve! Hot oil will rush out creating the potential for severe burns.**

**⚠ DANGER**

**DO NOT hammer on the drain valve with the cleanout rod or other objects. Damage to the ball inside will result in leaks and will void the Frymaster warranty.**

4. After draining the oil, clean all food particles and residual oil from the frypot. BE CAREFUL, this material may still cause severe burns if it comes in contact with bare skin.
5. Close the drain valve securely and fill the frypot with clean, filtered or fresh cooking oil to the bottom OIL-LEVEL line.

## **5.2 Preparing the Built-In Filtration System for Use**

The FootPrint Pro filtration system allows the oil in one frypot to be safely and efficiently filtered while the other frypots in a battery remain in operation. The FootPrint Pro filtration system is available in three different configurations:

- Filter Paper – includes crumb tray, large hold-down ring, and metal filter screen.
- Filter Pad – includes crumb tray, small hold-down ring, and metal filter screen.
- Magnasol Filter – includes crumb tray and Magnasol filter assembly.

Section 4.2.1 covers preparation of the Filter Paper and Filter Pad configurations for use. Refer to Section 4.2.2 for instructions on preparing the Magnasol Filter configuration for use. Operation of all three configurations is the same and is covered in section 4.3. Disassembly and reassembly of the Magnasol filter is covered in section 4.4.

## 5.2.1 Preparation for Use with Filter Paper or Filter Pad

1. Pull the filter pan out from the cabinet and remove the crumb tray, hold-down ring, filter paper and filter screen. (See Figure 1) Clean all components with a solution of detergent and hot water, then dry thoroughly.

The pan cover must not be removed except for cleaning, interior access, or to allow a shortening disposal unit (SDU) to be positioned under the drain. If using an SDU built before January 2004 see instructions on page 5-8.

2. Inspect the filter pan connection fitting to ensure that both O-rings are in good condition. (See Figure 2)

3. Then in reverse order, place the metal filter screen in the center of the bottom of the pan, then lay a sheet of filter paper on top of the screen, overlapping on all sides. (See Figure 1) If using a filter pad, ensure the rough side of the pad is up and lay the pad over the screen, making sure that the pad is in between the embossed ridges of the filter pan.

4. Position the hold-down ring over the filter paper and lower the ring into the pan, allowing the paper to rest on the sides of the filter pan. (See Figure 3)

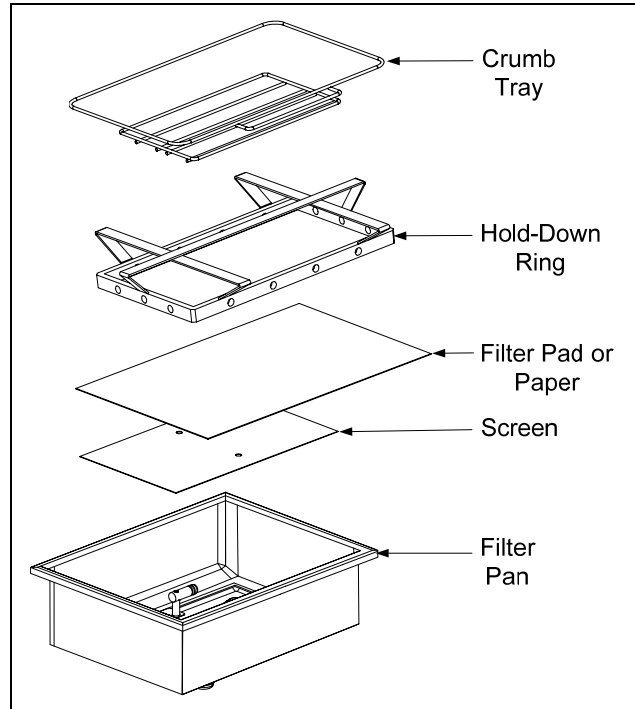

Figure 1

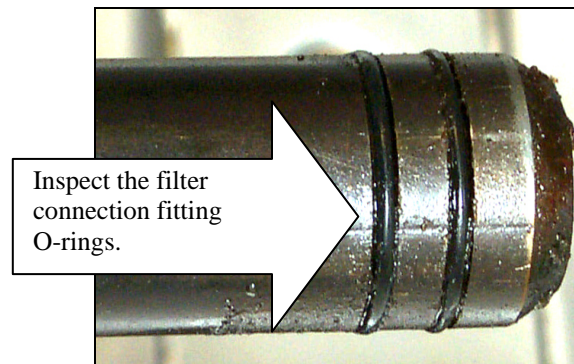

Figure 2



Figure 3



- When the hold-down ring is in position, if using filter paper, sprinkle one packet of filter powder evenly over the paper. (See Figure 4)

If using a filter pad, position the hold down ring on top of the pad. **DO NOT use filter powder with the pad.**



Figure 4

- Replace the crumb tray in the filter pan, then push the filter pan back into the fryer, positioning it under the drain.

### 5.2.2 Preparation for Use with the Magnasol Filter Assembly

- Pull the filter pan out from the cabinet and remove the crumb tray and Magnasol filter assembly (See Figure 5). Clean as directed in section 5.4.

The pan cover must not be removed except for cleaning, interior access, or to allow a shortening disposal unit (SDU) to be positioned under the drain.

**NOTE:** Refer to Section 5.4 for instructions on how to disassemble and reassemble the Magnasol filter screen assembly.

- Inspect the fitting on the bottom of the Magnasol filter assembly to ensure that the O-ring is present and in good condition. (See Figure 6)
- Inspect the filter pan connection fitting to ensure that both O-rings are present and in good condition. (See Figure 7)



Figure 5

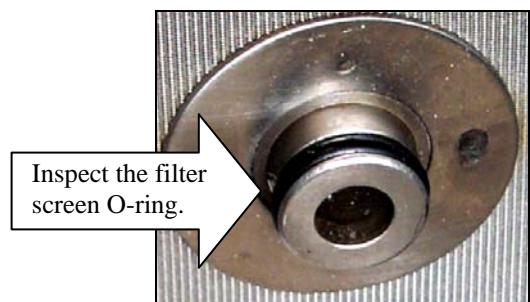

Figure 6

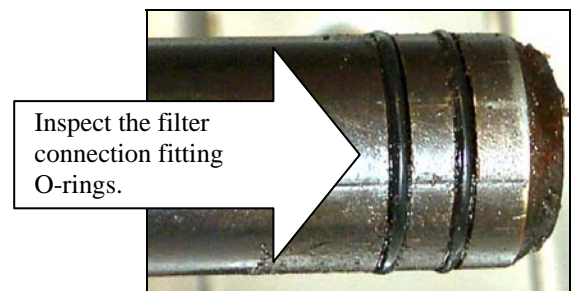

Figure 7



4. Replace the Magnasol filter assembly in the filter pan, ensuring that the fitting on the bottom of the assembly is securely seated in the port in the bottom of the pan. Sprinkle one packet of the Magnasol XL filter powder evenly over the screen.
5. Replace the crumb tray, then push the filter pan back into the fryer, positioning it all the way to the back of the cabinet.

### 5.3 Operation of the Filter

After a preset amount of cook cycles the computer will automatically display **FLTR NOW** alternating with **YES NO**.

1. Press the ✓ (1) button to continue (see Figure 8).



Figure 8

The computer displays **CNFM FLTR** alternating with **YES NO**.

2. Press the ✓ (1) button to continue (see Figure 9).



Figure 9

#### DANGER

Draining and filtering of cooking oil must be accomplished with care to avoid the possibility of a serious burn caused by careless handling. The oil to be filtered is at or near 350°F (177°C). Ensure drain handles are in their proper position before operating any switches or valves. Wear all appropriate safety equipment when draining and filtering cooking oil.

#### DANGER

NEVER attempt to drain cooking oil from the fryer with the burners lit! Doing so will cause irreparable damage to the frypot and may cause a flash fire. Doing so will also void the Frymaster warranty.

3. Ensure that the filter is prepared. See Sec. 5.2.
4. Make sure the oil is at operating temperature.
5. Drain the frypot into the filter pan by rotating the drain valve handle 90° (see Figure 10). If necessary, use the *Fryer's Friend* clean-out rod to clear the drain from **inside** the frypot.

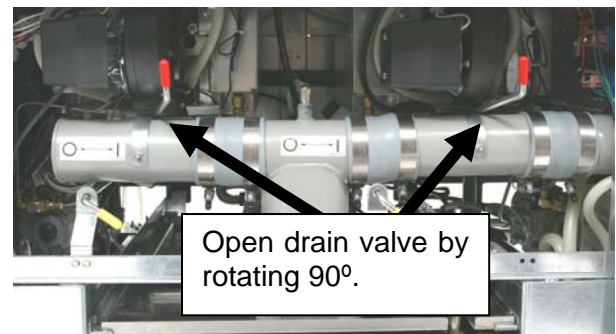

Figure 10

#### DANGER

Do not drain more than one frypot at a time into the built-in filtration unit to avoid overflow and spillage of hot oil that may cause severe burns, slipping and falling.

**⚠ DANGER**

**NEVER attempt to clear a clogged drain valve from the front of the valve! Hot oil will rush out creating the potential for severe burns.**

**⚠ DANGER**

**DO NOT hammer on the drain valve with the cleanout rod or other objects. Damage to the ball inside will result in leaks and will void the Frymaster warranty.**

6. After the oil has drained from the frypot, rotate the filter handle towards the “I” to start the pump and begin the filtering process. There may be a slight delay before the pump activates (see Figure 11).

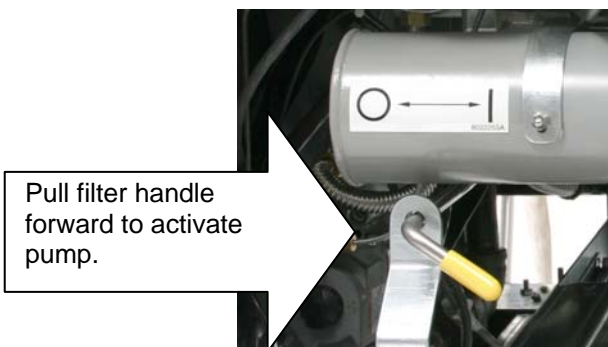

Figure 11

7. The filter pump draws the oil through the filter medium and circulates it back up to and through the frypot during a 5-minute process called polishing. Polishing cleans the oil by trapping solid particles in the filter medium.
8. After the oil is filtered (about 5 minutes), close the drain valve and allow the fryer to refill. Let the filter pump run 10 to 12 seconds after the oil begins to bubble. Turn the filter off.

The computer displays **FILTER DONE** alternating with **YES NO**.

9. Press the ✓ (1) button when filtration is finished (see Figure 12).

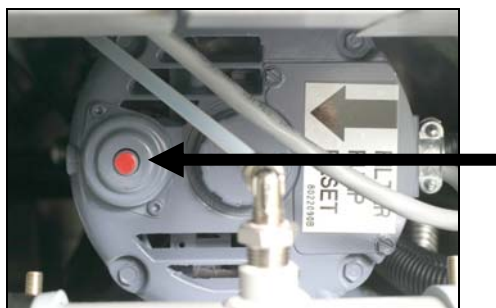

Figure 12

The computer displays **OFF**.

**⚠ WARNING**

**The filter pump is equipped with a manual reset switch in case the filter motor overheats or an electrical fault occurs. If this switch trips, turn off power to the filter system and allow the pump motor to cool 20 minutes before attempting to reset the switch (see photo below).**



Filter Pump Reset Switch

**⚠ WARNING**

Use caution and wear appropriate safety equipment when resetting the filter pump reset switch. Resetting the switch must be accomplished with care to avoid the possibility of a serious burn caused by careless maneuvering around a drain tube and around a frypot.

10. Ensure the drain valve is fully closed. (If the drain valve is not fully closed, the fryer will not operate.) Turn the fryer ON and allow the cooking oil to reach setpoint.

**⚠ DANGER**

The crumb tray in fryers equipped with a filter system must be emptied into a fireproof container at the end of frying operations each day. Some food particles can spontaneously combust if left soaking in certain shortening material.

**⚠ WARNING**

Do not bang fry baskets or other utensils on the fryer's joiner strip. The strip is present to seal the joint between the fry vessels. Banging fry baskets on the strip to dislodge shortening will distort the strip, adversely affecting its fit. It is designed for a tight fit and should only be removed for cleaning.

## 5.4 Disassembly and Reassembly of the Magnasol Filter

### Disassembly

1. Grasp the frame with your thumbs on the handles at the corner of the assembly and pull outward in opposite directions to separate the frame at the corner. Continue to open the frame (it will pivot at the opposite corner) until the outer screens and grid can be removed from the frame.

Step 2 - Separate the outer screens and grid.

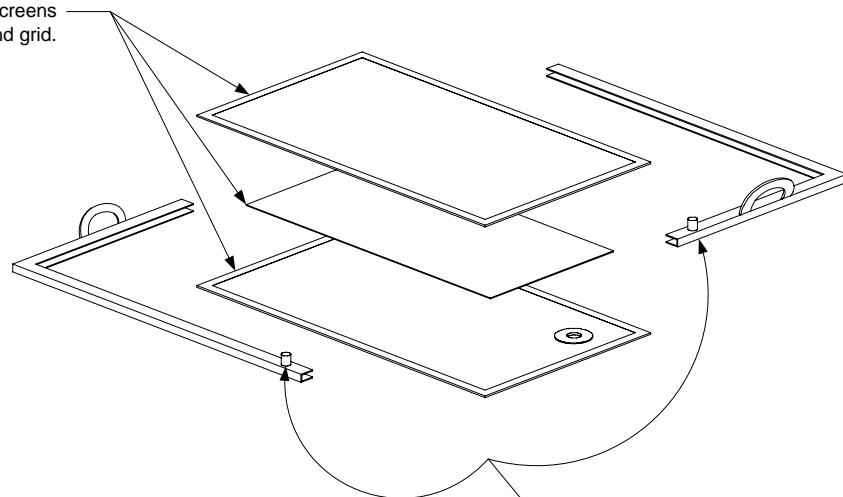

Step 1 - Grasp frame with thumbs on these handles and pull frame apart at corner.

2. Separate the outer screens and grid.

## Cleaning

1. Clean the two frame pieces, outer screens, and grid using a good quality degreaser and hot water from a spray nozzle. The groove in the seal frame pieces can be cleaned with the edge of a Scotch-Brite™ or similar cleaning pad.
2. At each scheduled boil-out, disassemble the leaf filter assembly and place in the frypot being boiled out. Follow the boil-out procedure in Section 4.11 page 4-16 of this manual.
3. Allow all filter assembly components to air dry or thoroughly dry with clean towels before reassembling.

## Reassembly

1. Place the two outer screens together and align their edges (see illustration below).
2. Insert the screens into one of the frame halves (it doesn't matter which one). Ensure that the fitting in the bottom screen is on the opposite side of the frame from the handle.
3. Slip the grid between the screens, ensuring that the grid is centered between the edges of the screens.
4. Connect the other half of the frame at the corner opposite the handles and pivot the frame onto the free edges of the screen.

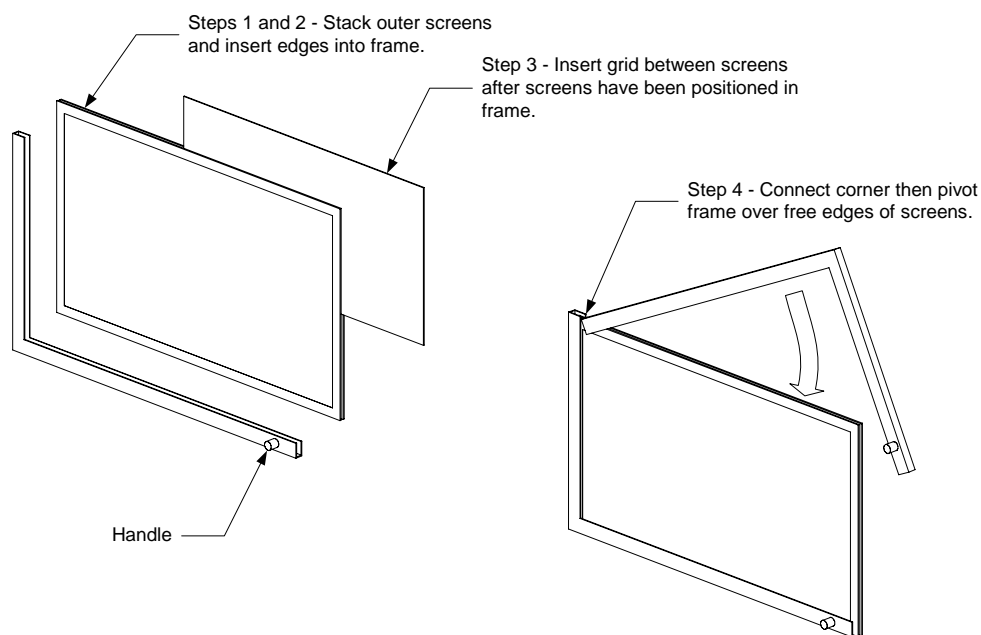

## 5.5 Draining and Disposing of Waste Oil

When cooking oil is exhausted, drain the oil into an appropriate METAL container for transport to the disposal container. Frymaster recommends the use of the Frymaster Shortening Disposal Unit (SDU). **NOTE:** If using an SDU built before January 2004 the filter pan cover must be removed to allow the unit to be positioned beneath the drain. To remove the lid, lift up on the front edge and pull it straight out of the cabinet. Refer to the documentation furnished with your disposal unit for specific operating instructions. If a shortening disposal unit is not available, allow the oil to cool to 100°F (38°C), then drain the oil into a METAL stockpot or similar METAL container. When draining is finished, close the fryer drain valve securely.

 **DANGER**

**Allow oil to cool to 100°F (38°C) before draining into an appropriate METAL container for disposal.**

 **DANGER**

**When draining oil into a disposal unit, do not fill above the maximum fill line located on the container.**

## 5.6 Using the “Optional” Oil Disposal

If the fryer is fitted with the optional oil disposal, ensure the filter pan is clean and ready for filtering. **DO NOT** discharge oil through a dirty or incomplete filter pan.

1. Ensure the oil is at operating temperature.
2. Turn the fryer off. Wear protective clothing and use caution. Hot oil can cause serious injury.
3. Open the drain valve of the frypot with oil to be discarded. Drain only one frypot at a time.
4. With the frypot drained and the oil to be discarded in the filter pan, close the drain valve. Ensure all other drain valves and oil-return valves are closed.
5. Ensure the oil disposal reservoir is not full and the fryer is properly connected to the oil disposal system.
6. Discharge the oil by engaging the discharge valve handle. The filter pump will come on and the oil will be pumped from the filter pan. Turn the pump off by disengaging the discharge valve handle when the filter pan empties. Repeat steps 1-6 if necessary to discharge the oil from other frypots. **DO NOT** discharge water or other liquids through the filter system.
7. Refill the fryer with fresh oil.

# PROTECTOR® SERIES GAS FRYERS

## CHAPTER 6: PREVENTIVE MAINTENANCE

---

### 6.1 FRYER PREVENTATIVE MAINTENANCE CHECKS AND SERVICE

 **DANGER**

The crumb tray in fryers equipped with a filter system must be emptied into a fire-proof container at the end of frying operations each day. Some food particles can spontaneously combust if left soaking in certain shortening material.

 **DANGER**

Never attempt to clean fryer during the cooking process or when the frypot is filled with hot oil. If water comes in contact with oil heated to cooking temperature, it can cause the oil to splatter and severely burn nearby personnel.

 **WARNING**

Use a commercial-grade cleaner formulated to effectively clean and sanitize food-contact surfaces. Read the directions for use and precautionary statements before use. Particular attention must be paid to the concentration of cleaner and the length of time the cleaner remains on the food-contact surfaces.

### 6.2 DAILY CHECKS AND SERVICE

#### 6.2.1 Inspect Fryer and Accessories for Damage

Look for loose or frayed wires and cords, leaks, foreign material in frypot or inside cabinet, and any other indications that the fryer and accessories are not ready and safe for operation.

#### 6.2.2 Clean Fryer Cabinet Inside and Out

Clean inside the fryer cabinet with dry, clean cloth. Wipe all accessible metal surfaces and components to remove accumulations of oil and dust.

Clean the outside of the fryer cabinet with a clean, damp cloth soaked with dishwashing detergent, removing oil, dust, and lint from the fryer cabinet.

#### 6.2.3 Clean the Built-in Filtration System Daily

 **WARNING**

**Never operate the filter system without oil in the system.**

 **WARNING**

**Never use the filter pan to transport old oil to the disposal area.**

 **WARNING**

**Never drain water into the filter pan. Water will damage the filter pump.**

There are no periodic preventive maintenance checks and services required for your FootPrint Pro Filtration System other than daily cleaning of the filter pan with a solution of hot water and detergent.

If you notice that the system is pumping slowly or not at all, verify that the filter pan screen is on the bottom of the filter pan, with the paper on top of the screen. (If the unit is equipped with a Magnasol filter screen rather than with the standard screen and paper system, verify that the O-ring on the bottom fitting of the screen is present and in good condition.) Verify that the two O-ring(s) on the fitting at the right front of the filter pan are present and in good condition.

## 6.3 WEEKLY CHECKS AND SERVICE

### 6.3.1 Drain and Clean Frypot

#### DANGER

**Never operate the appliance with an empty frypot. The frypot must be filled with water or oil before lighting the burners. Failure to do so will damage the frypot and may cause a fire.**



### 6.3.2 Boiling Out the Frypot

After the fryer has been in use for a period of time, a hard film of caramelized oil will form on the inside of the frypot. This deposit must be periodically removed to maintain your fryer's efficiency. See section 4.11 page 4-16 for instructions on boiling out the frypot.

## 6.4 MONTHLY CHECKS AND SERVICE

### 6.4.1 Check Computer Magic 7 Set Point Accuracy

*(This check applies only to units equipped with Computer Magic 7 Controllers.)*

1. Insert a good-grade thermometer or pyrometer probe into the oil, with the end touching the fryer temperature-sensing probe.
2. When the computer display shows a series of four dashes “----” with no dot between the first and second dashes (indicating that the frypot contents are within the cooking range), press the  switch once to display the temperature of the cooking oil as sensed by the temperature probe.
3. Press the  switch twice to display the set point.
4. Note the temperature on the thermometer or pyrometer. All three readings should be within  $\pm 5^{\circ}\text{F}$  ( $2^{\circ}\text{C}$ ) of each other. If not, contact a Factory Authorized Service Center for assistance.

## 6.5 QUARTERLY CHECKS AND SERVICE

### 6.5.1 Clean Combustion Air Blower Assembly

1. Disconnect the blower wiring harness and remove the four blower mounting nuts (see Figure 1 below).

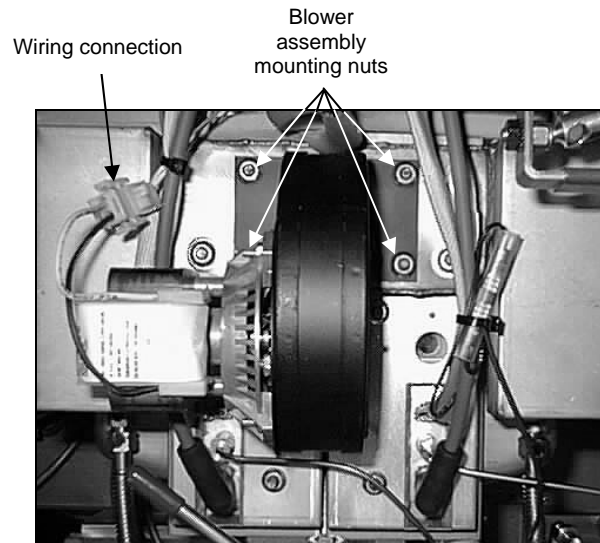

Figure 1

2. Remove the three fasteners that secure the blower motor assembly to the blower housing, and separate the two components (see Figure 2).

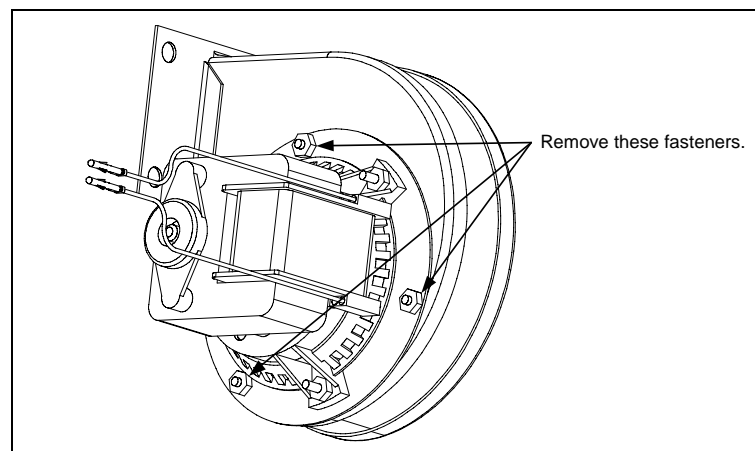
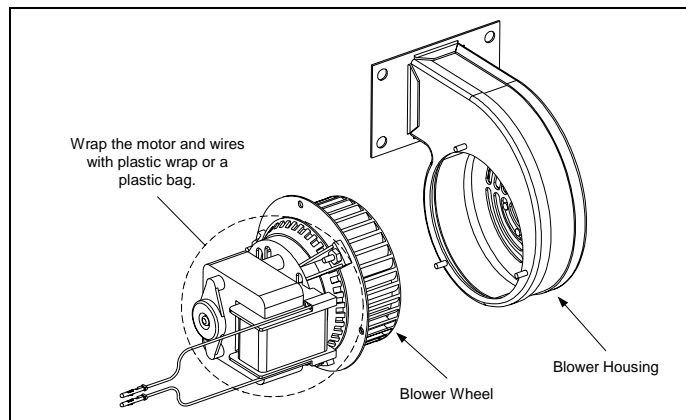

Figure 2



3. Wrap the motor with plastic wrap to prevent water from entering it. Spray degreaser or detergent on the blower wheel and the blower housing. Allow it to soak for five minutes. Rinse the wheel and housing with hot tap water, then dry with a clean cloth (see Figure 3).



**Figure 3**

4. Remove the plastic wrap from the blower motor assembly. Reassemble the blower motor assembly and blower housing. Reinstall the blower assembly in the fryer.
5. Reinstall the blower shield or shield assembly.
6. Light the fryer in accordance with the procedure described in Chapter 3, Section 3.2.2.
7. After the burners have been lit for at least 90 seconds, observe the flames through the burner viewing ports located on each side of the combustion air blower (see Figure 4).

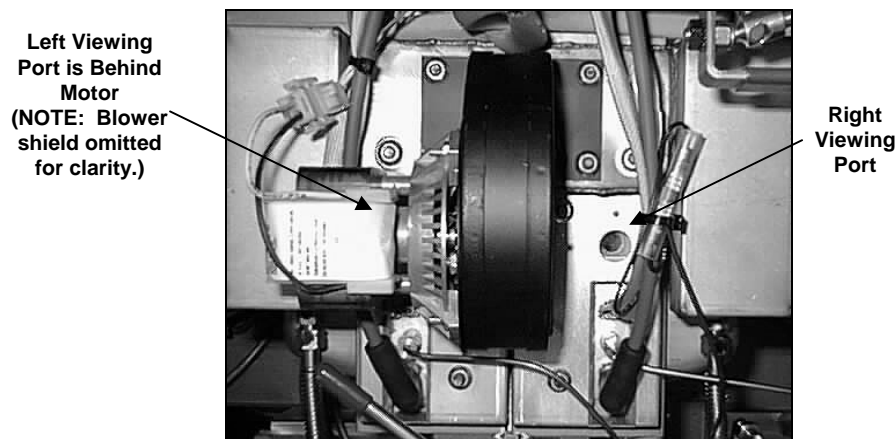
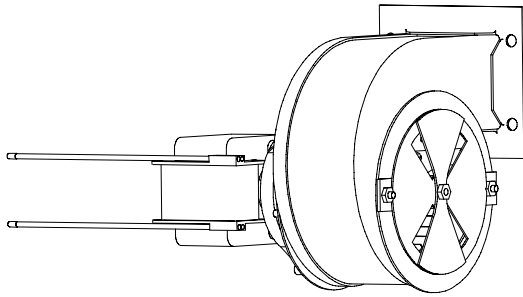

**Figure 4**

The air/gas mixture is properly adjusted when the burner manifold pressure is in accordance with the applicable table on page 2-7 and the burners display a bright orange-red glow. If a blue flame is observed, or if there are dark spots on a burner face, the air/gas mixture requires adjustment.

On the side of the blower housing opposite the motor is a plate with one or two locking nuts. Loosen the nut(s) enough to allow the plate to be moved, then adjust the position of the plate to open

or close the air intake opening until a bright orange-red glow is obtained. Carefully hold the plate in position and tighten the locking nut(s).



TYPICAL BLOWER ASSEMBLY

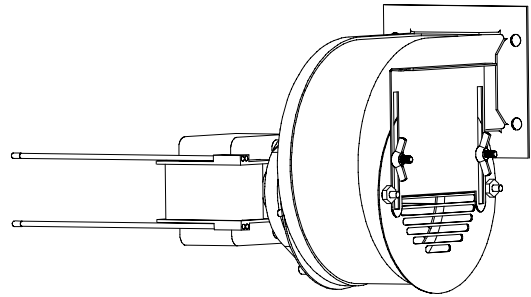

SOME CE BLOWER ASSEMBLIES  
MAY BE CONFIGURED THIS WAY

## 6.6 SEMI-ANNUAL CHECKS AND SERVICE

### 6.6.1 Clean Gas Valve Vent Tube

**NOTE:** This procedure is not required for fryers configured for export to CE countries.

1. Set the fryer power switch and the gas valve to the OFF position.
2. Carefully unscrew the vent tube from the gas valve. **NOTE:** The vent tube may be straightened for ease in removal.
3. Pass a piece of ordinary binding wire (.052 inch diameter) through the tube to remove any obstruction.
4. Remove the wire and blow through the tube to ensure it is clear.
5. Reinstall the tube and bend it so that the opening is pointing downward.

### 6.6.2 Check Burner Manifold Pressure

**⚠ DANGER**

This task should be performed by qualified service personnel only. Contact your FASC to arrange this service.

## 6.7 Annual/Periodic System Inspection

This appliance should be inspected and adjusted periodically by qualified service personnel as part of a regular kitchen maintenance program.

**Frymaster recommends that a Factory Authorized Service Technician inspect this appliance at least annually as follows:**

### **6.7.1 Fryer**

- Inspect the cabinet inside and out, front and rear for oil.
- Verify that the flue opening is not obstructed by debris or accumulations of solidified oil.
- Verify that burners and associated components (i.e. gas valves, pilot assemblies, ignitors, etc.) are in good condition and functioning properly. Inspect all gas connections for leaks and verify that all connections are properly tightened.
- Verify that the burner manifold pressure is in accordance with that specified on the appliance's rating plate.
- Verify that the temperature and high-limit probes are properly connected, tightened and functioning properly, and that probe guards are present and properly installed.
- Verify that component box components (i.e. computer, transformers, relays, interface boards, etc.) are in good condition and free from oil and other debris. Inspect the component box wiring and verify that connections are tight and that wiring is in good condition.
- Verify that all safety features (i.e. drain safety switches, reset switches, etc.) are present and functioning properly.
- Verify that the frypot is in good condition and free of leaks and that the frypot insulation is in serviceable condition.
- Verify that wiring harnesses and connections are tight and in good condition.

### **6.7.2 Built-In Filtration System**

- Inspect all oil-return and drain lines for leaks and verify that all connections are tight.
- Inspect the filter pan for leaks and cleanliness. If there is a large accumulation of crumbs in the crumb basket, advise the owner/operator that the crumb basket should be emptied into a fireproof container and cleaned daily.
- Verify that all O-rings and seals are present and in good condition. Replace O-rings and seals if worn or damaged.
- Check filtration system integrity as follows:
  - Verify that filter pan cover is present and properly installed.
  - With the filter pan empty, place each oil return handle, one at a time, in the ON position. Verify that the pump activates and that bubbles appear in the oil of the associated frypot.

- Close all oil return valves (i.e., place all oil return handles in the OFF position). Verify proper functioning of each oil return valve by activating the filter pump using the lever on one of the oil return microswitches. No air bubbles should be visible in any frypot.
  
- Verify that the filter pan is properly prepared for filtering, then drain a frypot of oil heated to 350°F (177°C) into the filter pan and close the frypot drain valve. Place the oil return handle in the ON position. Allow all cooking oil to return to the frypot (indicated by bubbles in the oil). Return the oil return handle to the OFF position. The frypot should have refilled in no more than 2 minutes and 30 seconds.

# PROTECTOR® SERIES GAS FRYERS

## CHAPTER 7: OPERATOR TROUBLESHOOTING

---

### 7.1 Introduction

This chapter provides an easy reference guide to some of the common problems that may occur during the operation of your equipment. The troubleshooting guides that follow are intended to help you correct, or at least accurately diagnose, problems with your equipment. Although the chapter covers the most common problems reported, you may encounter problems that are not covered. In such instances, the Frymaster Technical Services staff will make every effort to help you identify and resolve the problem.

When troubleshooting a problem, always use a process of elimination starting with the simplest solution and working through to the most complex. Most importantly, always try to establish a clear idea of why a problem has occurred. Part of your corrective action involves taking steps to ensure that it doesn't happen again. If a controller malfunctions because of a poor connection, check all other connections while you're at it. If a fuse continues to blow, find out why. Always keep in mind that failure of a small component may often be indicative of potential failure or incorrect functioning of a more important component or system.

If you are in doubt as to the proper action to take, do not hesitate to call the Frymaster Technical Service Department or your local Frymaster Factory Authorized Service Center for assistance.

***Before calling a servicer or the Frymaster HOTLINE (1-800-551-8633):***

- **Verify that electrical cords are plugged in and that circuit breakers are on.**
- **Verify that gas line quick-disconnects are properly connected.**
- **Verify that any gas line cutoff valves are open.**
- **Verify that frypot drain valves are fully closed.**
- **Have your fryer's model and serial numbers ready to give to the technician assisting you.**

 **DANGER**

**Hot oil will cause severe burns. Never attempt to move this appliance when filled with hot cooking oil or to transfer hot cooking oil from one container to another.**

 **DANGER**

**This equipment should be unplugged when servicing, except when electrical circuit tests are required. Use extreme care when performing such tests.**

**This appliance may have more than one electrical power supply connection point. Disconnect all power cords before servicing.**

**Inspection, testing, and repair of electrical components should be performed by an authorized service agent only.**

## 7.2 Troubleshooting Fryers

### 7.2.1 Computer and Heating Problems

PROBLEM	PROBABLE CAUSES	CORRECTIVE ACTION
<b>No display on the computer.</b>	A. Computer not turned on.	A. Press the ON/OFF switch to turn the computer on.
	B. No power to fryer.	B. Verify that the fryer is plugged in and that the circuit breaker is not tripped.
	C. Computer, wiring harness or other component has failed.	C. Call FASC.
<b>Fryer does not heat. Or Display shows HELP with alarm sounding. Heating indicator is on, but burners will not light.</b>	A. Drain valve not fully closed.	A. Verify that the drain valve is fully closed.
	B. Gas valve is not turned on.	B. Turn the gas valve knob to the <b>ON</b> position.
	C. Manual gas shut off valve closed.	C. Verify that any in-line manual shut off and main cut-off is open.
	D. Improperly connected quick-disconnect fitting on gas line.	D. Verify that the quick-disconnect fitting on the flexible gas line is firmly connected to the fryer.
	E. Obstructed or failed combustion air blower.	E. Verify that combustion air blower is running. If not, call FASC for service. If combustion air blower is functional, clean and adjust per instructions in Chapter 6 of this manual.
<b>Fryer is operating normally, but recovery is slow when cooking. Or Fryer is slow coming out of melt cycle and displays HELP a short time after coming out of melt cycle.</b>	Dirty or obstructed combustion air blower.	Clean and adjust per instructions in Chapter 6 of this manual.
<b>Fryer is operating normally, but produces a popping sound when burners ignite.</b>	A. Dirty or obstructed combustion air blower.	A. Clean and adjust per instructions in Chapter 6 of this manual.
	B. Dirty or obstructed gas valve vent tube (non-CE fryers only).	B. Clean per instructions in Chapter 6 of this manual.
	C. Malfunctioning combustion air blower.	C. If blower is slow to come up to speed, contact FASC for service.

<b>PROBLEM</b>	<b>PROBABLE CAUSES</b>	<b>CORRECTIVE ACTION</b>
<b>Heat indicator is on and blower is running, but burner will not ignite.</b>	Blown fuse on interface board or ignition module.	Replace fuse.

## 7.2.2 Error Messages and Display Problems

<b>Problem</b>	<b>Probable Causes</b>	<b>Corrective Action</b>
<b>CM7 display is in wrong temperature scale (Fahrenheit or Celsius).</b>	Incorrect display option programmed.	See page 4-16 for instructions.
<b>CM 7 display shows IGNITION FAILURE.</b>	Open drain valve or problem with latching circuitry.	Verify that the drain valve is fully closed. If the problem continues call your FASC.
<b>CM7 display shows HOT-HI- 1.</b>	Frypot temperature is more than 410°F (210°C) or, in CE countries, 395°F (202°C).	This is an indication of a malfunction in the temperature control circuitry, including a failure of the high-limit thermostat. Shut the fryer down immediately and call your FASC.
<b>CM 7 display shows HIGH TEMP.</b>	Fryer temp is above setpoint.	Ensure setpoint is set correctly. If problem persists call your FASC.
<b>CM7 display shows LOW TEMP.</b>	Frypot temperature is between 180°F (82°C) and 315°F (157°C).	This display is normal when the fryer is first turned on and may appear for a short while if a large batch of frozen product is added to the frypot. If the display never goes out, the fryer is not heating. Shut the fryer down and call your FASC.
<b>CM7 display shows PROBE FAILURE.</b>	Problem with the temperature measuring circuitry including the probe.	Shut the fryer down and call your FASC.
<b>CM7 display shows IGNITION FAILURE.</b>	Open drain valve, failed computer, failed transformer, open high-limit thermostat.	Verify that the drain valves are fully closed. Using the ON/OFF switch, turn the computer OFF and then ON again. If this does not correct the problem, call your FASC.
<b>CM 7 display shows HOT-HI - 1.</b>	Frypot temperature is more than 410°F (210°C) or, in CE countries, 395°F (202°C).	Call your FASC.

<b>Problem</b>	<b>Probable Causes</b>	<b>Corrective Action</b>
<b>Heat indicator off upon initial startup. Display shows <i>H</i> or <i>HOT</i> with alarm sounding.</b>	Failed computer, damaged wiring harness or connector.	Call your FASC.
<b>Computer locks up.</b>	Computer error.	Turn the computer OFF and then ON again. If problem persists, contact your FASC.

### 7.2.3 Filtration Problems

<b>PROBLEM</b>	<b>PROBABLE CAUSES</b>	<b>CORRECTIVE ACTION</b>
<b>Filter Pump won't start.</b>  <b>OR</b>  <b>Pump stops during filtering.</b>	A. Power cord is not plugged in or circuit breaker is tripped.	A. Verify that the power cord is fully plugged in. Is so, verify that circuit breaker is not tripped.
	B. Pump motor has overheated causing the thermal overload switch to trip.	B. If the motor is too hot to touch for more than a few seconds, the thermal overload switch has probably tripped. Allow the motor to cool at least 45 minutes then press the Pump Reset Switch.
	C. Failed filter handle microswitch.  <i>Test:</i> If this is a multi-pot fryer, attempt to operate the pump using a different handle. If the pump starts, the handle microswitch is either out of alignment or has failed.  When the handle is placed in the ON position, the lever on the microswitch should be firmly pressed against the switch. If so, the switch has failed. If not, the switch is loose and/or misaligned.	C. If the switch is loose, tighten the nuts and bolts holding it in place, ensuring that when the handle is placed in the ON position, the lever on the microswitch is pressed firmly against the switch.  If the switch has failed, call FASC.
	D. Filter pump blockage.  <i>Test:</i> Close the drain valve and pull the filter pan out from the fryer. Activate the pump. If the pump motor hums for a short time then stops, the probable cause is blockage of the pump itself.	D. Pump blockages are usually caused by sediment build-up in the pump due to improperly sized or installed filter paper and failure to use the crumb screen. Call FASC.



PROBLEM	PROBABLE CAUSES	CORRECTIVE ACTION
<b>Filter pump runs, but oil return is very slow and bubbling oil occurs.</b>	<p>A. Paper/screen clogged.</p> <p>B. Improperly installed filter pan components.</p> <p>C. Attempting to filter with oil that is not hot enough.</p>	<p>A. Paper/screen needs changed or cleaned.</p> <p>B. If using filter paper configuration, verify that filter screen is in bottom of pan with paper on top of screen.</p> <p>Verify that O-rings are present and in good condition on filter pan connection fitting.</p> <p>C. In order to properly filter, the oil should be at or near 350°F (177°C).</p>
<b>Filter pump runs but oil does not return to frypot and there is no bubbling oil.</b>	<p>Blockage in filter pan suction tube.</p> <p><b>Test:</b> Close the drain valve and pull the filter pan out from the fryer. Activate the pump. If bubbling oil occurs, there is a blockage in the filter pan suction tube.</p>	<p>The blockage may be caused by sediment buildup. Use a thin, flexible wire to remove the blockage. If the blockage cannot be removed, call FASC.</p>

#### 7.2.4 Auto Top-Off Problems

Problem	Probable Causes	Corrective Action
<b>Frypots won't top off.</b>	<p>A. Fryer temperature too low.</p> <p>B. Temperature of oil too cold.</p> <p>C. Supply line out of JIB.</p> <p>D. CM7 not readdressed after ATO switch was switched on.</p>	<p>A. Fryer temperature must be at least 300°F (149°C).</p> <p>B. Ensure that oil is above 70°F (21°C).</p> <p>C. Ensure supply line is in JIB.</p> <p>D. Switch all CM7 computers off and then on again to readdress system.</p> <p>If problem persists call your FASC.</p>

#### 7.2.5 Basket Lift Problems

PROBLEM	PROBABLE CAUSES	CORRECTIVE ACTION
<b>Basket lift movement is jerky and/or noisy.</b>	Basket lift rods need lubrication.	Apply a light coating of Lubriplate™ or similar lightweight white grease to the rod and bushings.



**Enodis**<sup>®</sup>  
One Company, Countless Solutions

**Frymaster, L.L.C., 8700 Line Avenue, Shreveport, Louisiana 71106**

**TEL 1-318-865-1711 FAX (Parts) 1-318-219-7140 FAX (Tech Support) 1-318-219-7135**

**PRINTED IN THE UNITED STATES**

**SERVICE HOTLINE  
1-800-551-8633**

**819-6339  
APRIL 2007**

## Free Manuals Download Website

<http://myh66.com>

<http://usermanuals.us>

<http://www.somanuals.com>

<http://www.4manuals.cc>

<http://www.manual-lib.com>

<http://www.404manual.com>

<http://www.luxmanual.com>

<http://aubethermostatmanual.com>

Golf course search by state

<http://golfingnear.com>

Email search by domain

<http://emailbydomain.com>

Auto manuals search

<http://auto.somanuals.com>

TV manuals search

<http://tv.somanuals.com>