



Service, Parts Manual for 6, 3-Row Models

UHC-HD

**Frymaster**



Frymaster, a member of the Commercial Food Equipment Service Association, recommends using CFESA Certified Technicians.

* 8196606 *

24-Hour Service Hotline
1-800-551-8633

Price: \$6.00

819-6606
OCT 10

NOTICE

IF, DURING THE WARRANTY PERIOD, THE CUSTOMER USES A PART FOR THIS ENODIS EQUIPMENT OTHER THAN AN UNMODIFIED NEW OR RECYCLED PART PURCHASED DIRECTLY FROM FRYMASTER DEAN, OR ANY OF ITS AUTHORIZED SERVICE CENTERS, AND/OR THE PART BEING USED IS MODIFIED FROM ITS ORIGINAL CONFIGURATION, THIS WARRANTY WILL BE VOID. FURTHER, FRYMASTER DEAN AND ITS AFFILIATES WILL NOT BE LIABLE FOR ANY CLAIMS, DAMAGES OR EXPENSES INCURRED BY THE CUSTOMER WHICH ARISE DIRECTLY OR INDIRECTLY, IN WHOLE OR IN PART, DUE TO THE INSTALLATION OF ANY MODIFIED PART AND/OR PART RECEIVED FROM AN UNAUTHORIZED SERVICE CENTER.

THE CABINET IS NOT SUITABLE FOR OUTDOOR USE. WHEN OPERATING THIS UNIT, IT MUST BE PLACED ON A HORIZONTAL SURFACE.

THE CABINET IS NOT SUITABLE FOR INSTALLATION IN AN AREA WHERE A WATER JET CAN BE USED. THIS APPLIANCE MUST NOT BE CLEANED WITH A WATER JET.

FOR YOUR SAFETY

DO NOT STORE OR USE GASOLINE OR OTHER FLAMMABLE VAPORS AND LIQUIDS IN THE VICINITY OF THIS OR ANY OTHER APPLIANCE.

DO NOT OPERATE OR SERVICE THE CABINET WITHOUT FIRST READING THIS MANUAL.

DO NOT OPERATE THE CABINET UNLESS IT HAS BEEN PROPERLY INSTALLED AND CHECKED.

DO NOT OPERATE THE CABINET UNLESS ALL SERVICE AND ACCESS PANELS ARE IN PLACE AND PROPERLY SECURED.

DO NOT ATTEMPT TO REPAIR OR REPLACE ANY COMPONENT OF THE CABINET UNLESS ALL POWER TO THE UNIT HAS BEEN DISCONNECTED.

USE CAUTION WHEN SETTING UP, OPERATING, OR CLEANING THE CABINET TO AVOID CONTACT WITH HEATED SURFACES.

USE CAUTION WHEN LIFTING THE UHC-D. THE UNIT WEIGHS 200 POUNDS. THREE TO FOUR PEOPLE, USING STANDARD SAFE LIFTING PRACTICES, WILL BE NECESSARY TO HANDLE THE CABINET.

Table of Contents



Theory of Operation	1-1
Service/Software Procedures	2-1
Troubleshooting	3-1
Illustrated Parts List	4-1
Wiring Diagrams	5-1

Cabinet Service Procedures

1 Functional Description

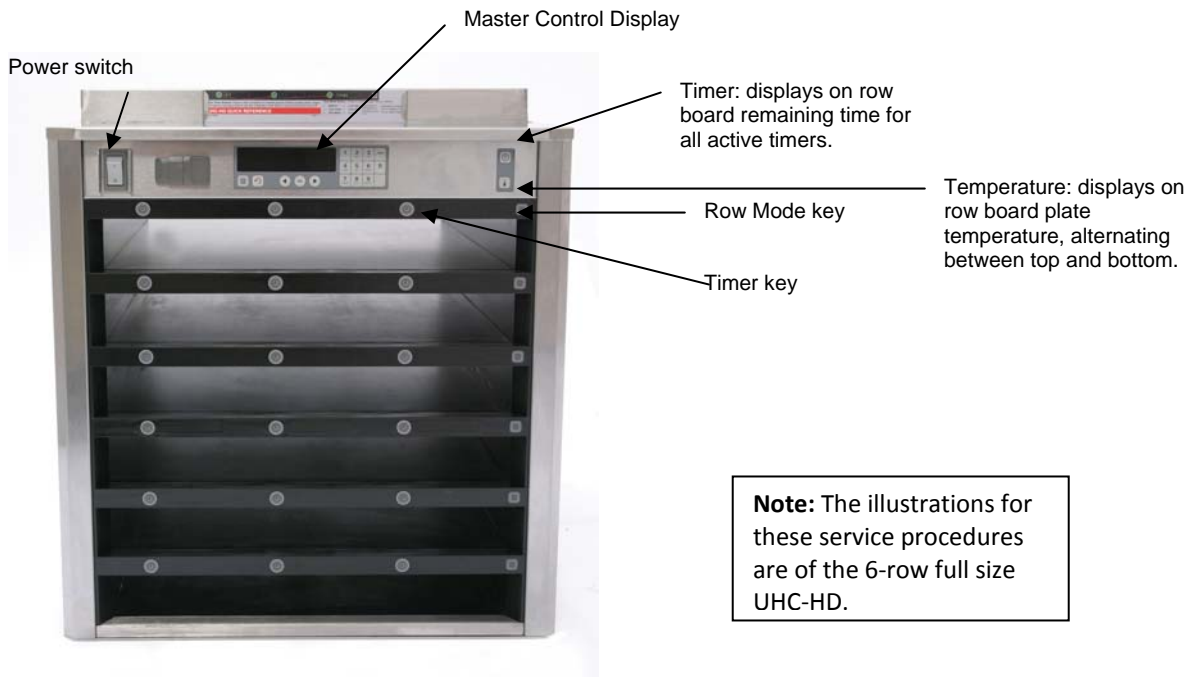

1.2 Theory of Operation

The cabinet operates on 208-250VAC 50 or 60 cycle single-phase power. The main switch activates a relay, which supplies line voltage to two distribution boards, three cooling fans and a power supply. The power supply provides 5VDC to the master control board and the distribution boards.

A ribbon cable connects the master control board to both distribution boards. Ribbon cables also connect the distribution boards to the displays. The resistance of RTD's, attached to the heater plates, is monitored by the distribution boards. The board switches power through solid-state relays to the heater plates when the resistance, which is used as an indicator of temperature, falls out of the range for the product held in the cabinet.

The switch, relay, master control, master control board, LON board, LON filter, cooling fans and power supply are mounted under the top of the unit. The cabinet is programmed using the key pad on the front bezel.

Cabinet Service Procedures

1.3 Start Up Indicators and Test Points

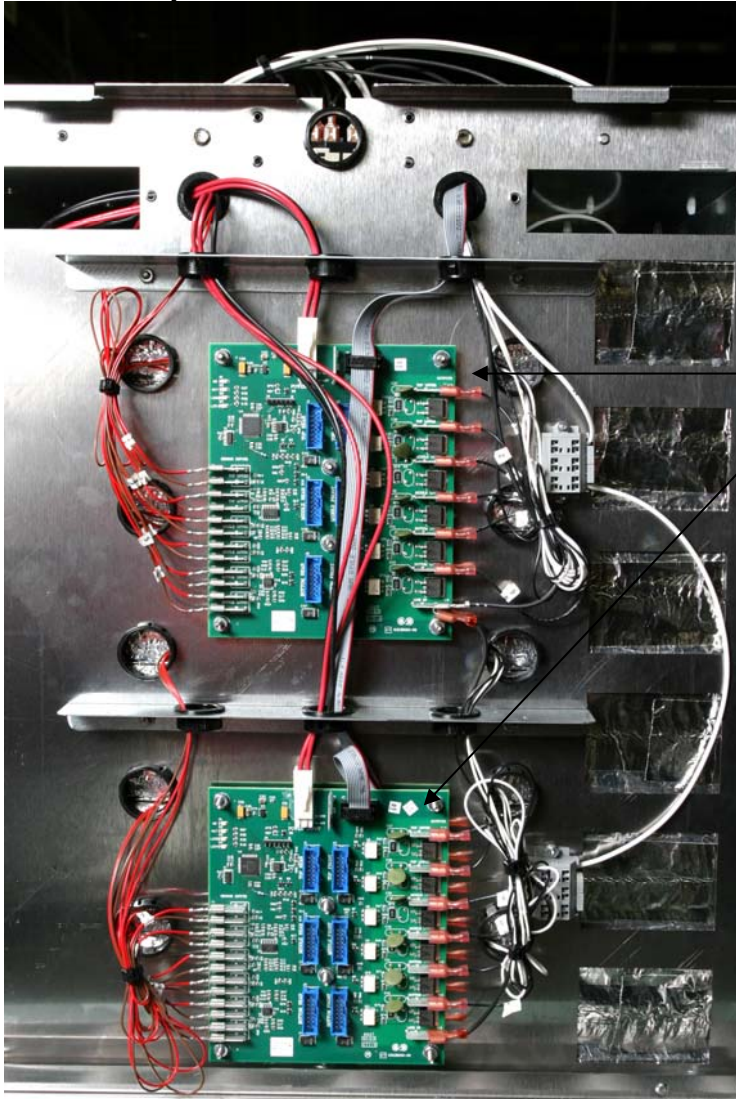

Distribution boards shown with ribbon cables removed.

Upon startup, the cabinet beeps. LED's on the distribution boards flash. The displays show the version number of the cabinet's firmware and then the row's status.

Cabinet Service Procedures

2 Service Procedures

DANGER: Failure to disconnect power from the unit before servicing could result in serious injury or death. The cabinet power switch **DOES NOT** disconnect all incoming power to the cabinet.



Fig. 1: The sides are held in place by screws near the base of the unit on each side.

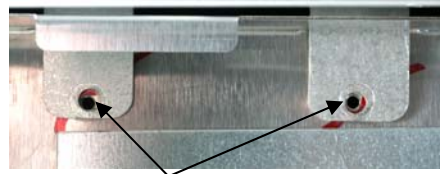
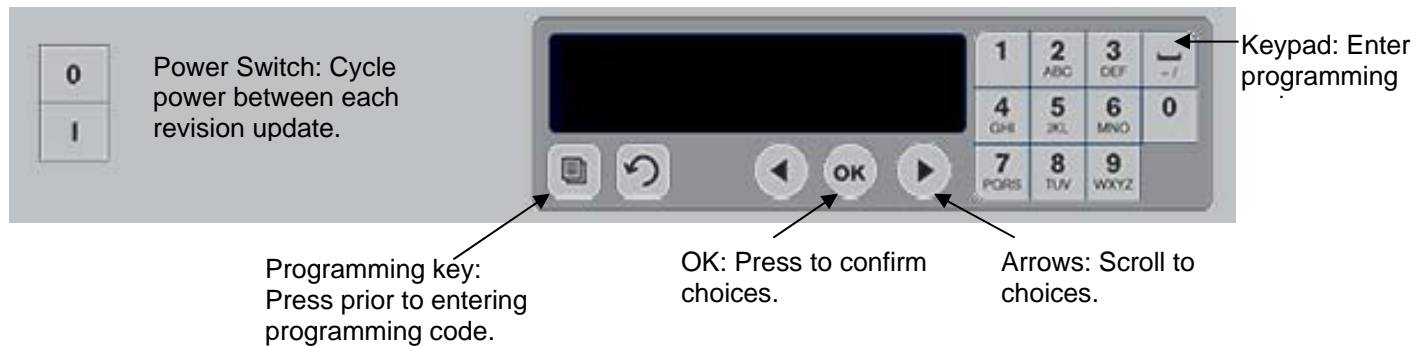

Fig. 2: Tabs in the topcap extend to holes in the cabinet. The top is secured with at the tabs with screws.

2.1 Updating Software/Capturing Configurations

The five sections of software on the cabinet can be updated individually. To ensure compatibility between cabinet software and replacement boards, the software should be updated to the latest version at any board replacement. Follow the directions below.



Software updates use the master control display to enter programming codes, scroll to areas to be revised, respond to questions and exit. The control is annotated above. The arrow and OK buttons are illuminated when active.

Check Existing Versions

1. With the unit powered up, press the programming key.
2. Screen scrolls Enter Access Sequence.
3. Enter 090809 on keypad.
4. Press OK.
5. Scroll with arrow keys to view all software revision numbers:
 - Main
 - Boot Loader
 - Master Display
 - Distribution Board
 - Row Display
6. Press OK.

NOTE: If the master control displays an error message during the install process, turn the cabinet off for 30 seconds and back on. Repeat install steps.

Cabinet Service Procedures

Update: Boards

1. Turn power off.
2. Insert flash drive in USB port located on cabinet bezel.
3. Turn power on.
4. Cabinet displays version numbers followed by current menu setting.
5. Press programming key.
6. Screen scrolls Enter Access Sequence.
7. Enter 98765 with keypad.
8. Press OK.
9. Scroll with arrow key until software section (**see loading sequence box**) to be updated is displayed on master control board.
10. Press OK.
11. Screen displays Copying Files, Please Wait. This takes several minutes.
12. Screen messages will vary, depending on software section being installed. Follow screen instructions.
13. Screen displays Complete.
14. Press OK.
15. Screen displays Main Boot Loading and a percentage of completion.
16. After 100% is displayed, screen goes blank and returns to menu display.
17. Turn cabinet off for 30 seconds and back on.

Loading Sequence

Software should be loaded in this sequence:

- Main Board
- Language
- Row Display
- Distribution Boards

If the software update only involves a few of the components, following the loading sequence, skipping the unneeded component.

Incompatibility Message

The cabinet can display an incompatibility message during software upgrades. The buttons will remain active. Follow the loading sequence and the incompatibility is corrected as the software components are loaded.

Update: Language File

1. With the unit on, press program button.
2. Enter 090709 with the keypad.
3. Press OK.
4. Screen displays Reconfigure OK or Cancel.
5. Press OK.
6. Screen displays Please Wait Lang Bin.
7. Screen displays 9 files copied.
8. Press OK.
9. Screen returns to normal display.
10. Turn cabinet off for 30 seconds and back on.

Capture Cabinet Menus/Configurations

The menu items and cabinet configurations in a cabinet can be captured and used to configure cabinets with identical software setups. Follow the instructions below to capture the menus and configuration from a cabinet.

1. Insert an empty flash drive in the USB socket on the cabinet with menus and configurations to be copied.
2. Press the programming key.
3. Enter 759248 with the keypad.
4. Press OK.
5. The master control will display
COPY FROM UHC TO



The configuration of a cabinet can be captured on an empty flash drive for transfer to cabinets with the same software setup.

Cabinet Service Procedures

USB.

6. Press OK.
7. The master control displays *PLEASE WAIT...* as files are transferred to the flash drive, changing to the number of files copied when the process is complete.
8. Press OK.
9. Remove flash drive.
10. Cabinet returns to normal display.

Configure Cabinet with Menu/Configuration Captured on another Cabinet

1. Place a flash drive with only a captured menu/cabinet configuration in the root file into the USB port of a cabinet to be identically configured.
2. Press the programming key and enter 090709 with the keypad.
3. Press OK.
4. The master control will display *RECONFIGURE OK OR CANCEL.*
5. Press OK.
6. The master control will display *PLEASE WAIT...* as the files are updated, changing to the number of files copied.
7. Press OK.
8. The cabinet will return to the original menu setting, changing row position displays to match items introduced with the configuration transfer.



A cabinet configuration can be transferred to multiple cabinets with a captured configuration held on a flash drive.

Cabinet Access Codes	
Code	Function
759248	Capture cabinet configuration to flash drive
98765	Load software updates from USB drive
1955	Enter manual programming mode (see operation manual).
4557	LON Works service pin
090809	View software versions
1111	Service test mode
090709	Update language file

Cabinet Service Procedures

2.2 Placing the cabinet in Service Mode

The cabinet can be put in service mode, a diagnostic settings which allows the heater plates to be controlled individually, brightness settings on the displays adjusted and re-addressing for unique arrangements of bezels. Follow the steps below :



Switching Heater Plates Off Individually

When troubleshooting, it may be useful to switch heater plates off individually. Follow the instructions below:

1. Press the programming key.
2. Enter 1111 at the Enter Access Sequence prompt.
3. The screen will scroll Row 1 Top Heater Off; pressing OK turns it back on.
4. Voltage can be measured between the plate-specific heater leads on the distribution board and the common block to the right of the distribution board as the heater plates are switched, individually, on and off.
5. Scroll to other plates with ◀▶.
6. Ensure the plates are on before backing out of the Service Mode with the ⏪.

Adjusting Display Brightness

When multiple row positions are timing the same item, the display with the least remaining time is the brightest. All others are dimmer as are positions not actively timing a product. The relative brightness of the bright display and the dim display can be adjusted. Follow the instructions below:

1. Press the programming key.
2. Enter 1111 at the Enter Access Sequence prompt.
3. Press OK.
4. The screen will scroll Row 1 Top Heater Off.
5. Scroll with ▶ through all the Heater Plate prompts until the screen displays Press OK to Adjust Bright Row Display.
6. Press OK.
7. The cabinet's row displays become
Decrease Increase 88888 20
8. Press the timer button next to the Decrease display to lessen the brightness; the number displayed at the right will decrease. Press the timer button next to the Increase display to increase the brightness; 20 is the maximum.
9. Press OK. The display becomes Adjust Dim Intensity. The cabinet's row displays become
Decrease Increase 88888 03
10. Press the timer button next to the Decrease display to lessen the brightness; the number displayed at the right will decrease. Press the timer button next to the Increase display to increase the brightness; 1 is the minimum.
11. Press OK.
12. Cabinet returns to menu display.

Cabinet Service Procedures

Readdressing the Cabinet

Addressing, or assigning a position-specific component such as a display or distribution board, is done automatically by the cabinet on startup. Communication errors can occur on start-up after a board installation however. If so, follow the instructions below to readdress the cabinet. This process can also be used during troubleshooting when displays are connected out of synch with their associated bezel on the same row level.

1. Press the programming key.
2. Enter 1111 at the Enter Access Sequence prompt.
3. The screen will scroll Row 1 Top Heater Off.
4. Scroll with ► through all the Heater Plate prompts until the screen displays Press OK to Re-Address.
5. Press OK.
6. Screen Displays Please Power Cycle Off.
7. Turn the cabinet off and back on.
8. The cabinet will start in the normal start-up sequence.

Cabinet Service Procedures

2.3 Accessing the Electronic Components

1. The component shelf is accessed by removing two screws on each side of the unit (**Fig. 1**).
2. Lift and remove the sides, which exposes screws that hold the top in place (**Fig. 2**).
3. The components are annotated below (**Fig. 3**).

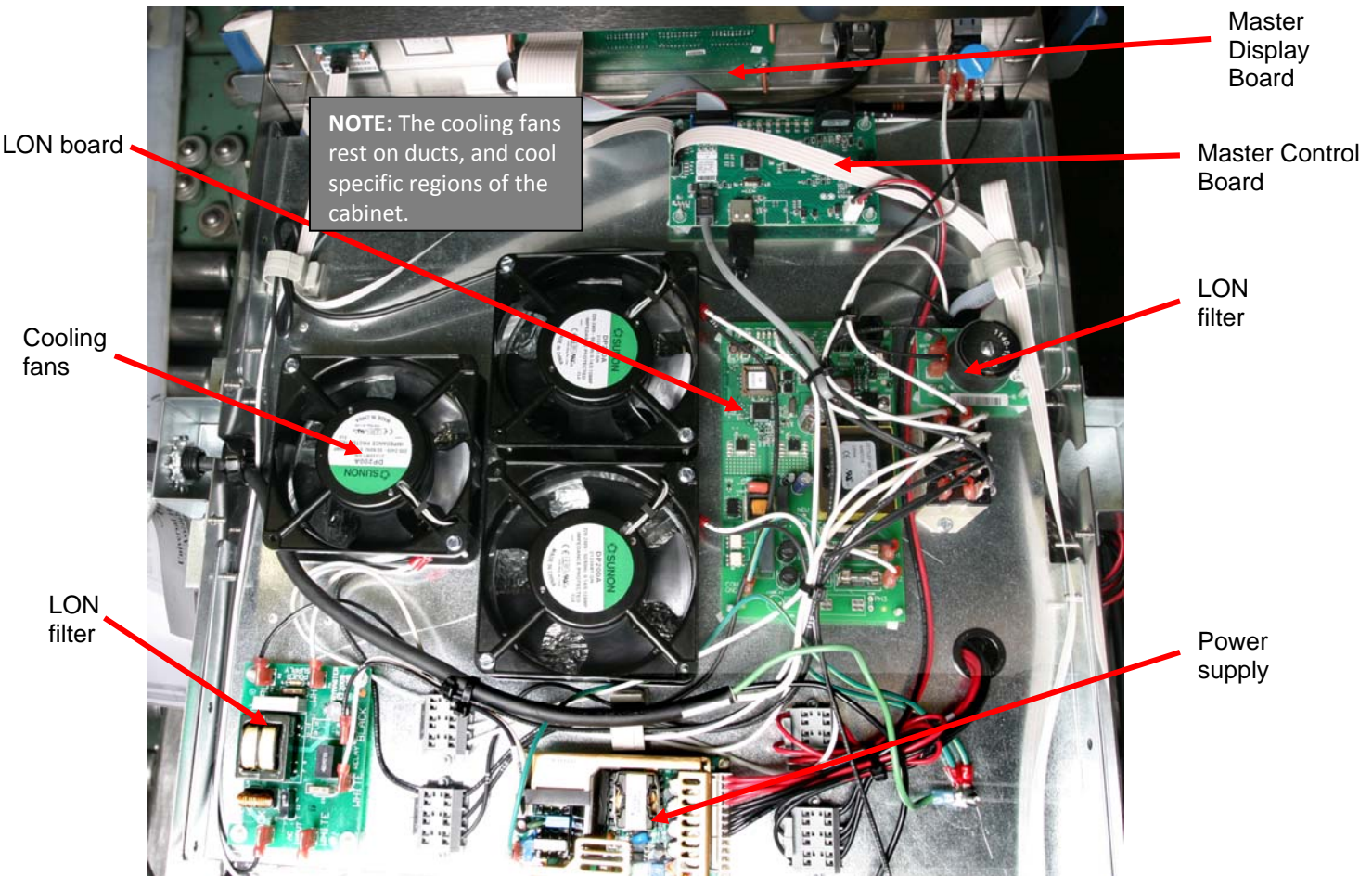

Figure 3

All the components are readily removed. There are no replaceable components on the circuit boards.

2.4 Circuit Board LED Diagnostics

Master Control Board:

- **HB LED** is a heartbeat; should be flashing when in the normal in- use mode. Flash rate is not critical.
- **ACT LED** similar to HB but flashes at a faster rate.
- **OK LED** toggles each time a valid communication packet is sent and received. Normally a very fast flicker.



Fig. 4: Master Control Board LED's

Cabinet Service Procedures

- **ERR LED** toggles when a communication error is detected; it's not unusual to see a flash, but regular flashing means communications problems.
- **LED5 and LED6** used for programming/debugging; have no diagnostic function.
- **LED7** When lit, the master control is executing a time or temp query operation on the front side.
- **LED8** When lit, the master control is executing a time or temp query operation on the back side.

Distribution Board

- **HB LED** is a heartbeat LED; toggles on / off to indicate processor is running.
- **ACT LED** flashes when it receives a valid communication packet; it should be flashing every few seconds or faster.
- **LED3** Toggles if there is a communications error on a packet directed to the distribution board. Can flash on occasion; shouldn't flash regularly.
- **LED1** flashes if there is voltage being applied to one or more heaters on that distribution board; one or more plate is calling for heat.



Fig. 5: Distribution Board LED's

2.5 Tests

2.5.1 Power Supply

1. Disconnect power and check all terminals and connections for loose or disconnected wires.
2. Apply power and check for 5VDC at the power-in terminal on the distribution board and chassis ground.

2.5.2 RTD

1. Remove the leads from the suspect RTD and test for resistance. Selected temperatures and resistances are show in chart at right.

NOTE: After testing, reconnect all leads to their original positions.

2.5.3 Distribution Boards

1. Check for line voltage between the heater plate terminal on the board and the terminal block for the

Sensor (°F)	Resistance	Sensor (°C)
60	106.065	15.55
70	108.224	21.11
80	110.380	26.66
90	112.532	32.22
100	114.680	37.77
110	116.825	43.33
120	118.966	48.88
130	121.104	54.44
140	123.239	60.00
150	125.369	65.55
160	127.496	71.11
170	129.620	76.66
180	131.740	82.22
190	133.856	87.77
200	135.969	93.33
210	138.078	98.88
220	140.184	104.44
230	142.286	110.00
240	144.385	115.55
250	146.480	121.11
260	148.570	126.66

RTD resistance chart

Cabinet Service Procedures

suspect heater. Note: Line voltage is only seen when the row is calling for heat.

2. Check for line voltage between the power input terminal and the terminal block.
3. Check for +5VDC at the power-in terminal and the terminal block for the power supply.

NOTE: After testing, reconnect all connections to their original positions.

2.5.4 Display

1. Remove power from unit.
2. Connect the ribbon cable from a suspect display to the connector of a properly working display to isolate the problem to the display or the distribution board.
3. Reapply power to cabinet.

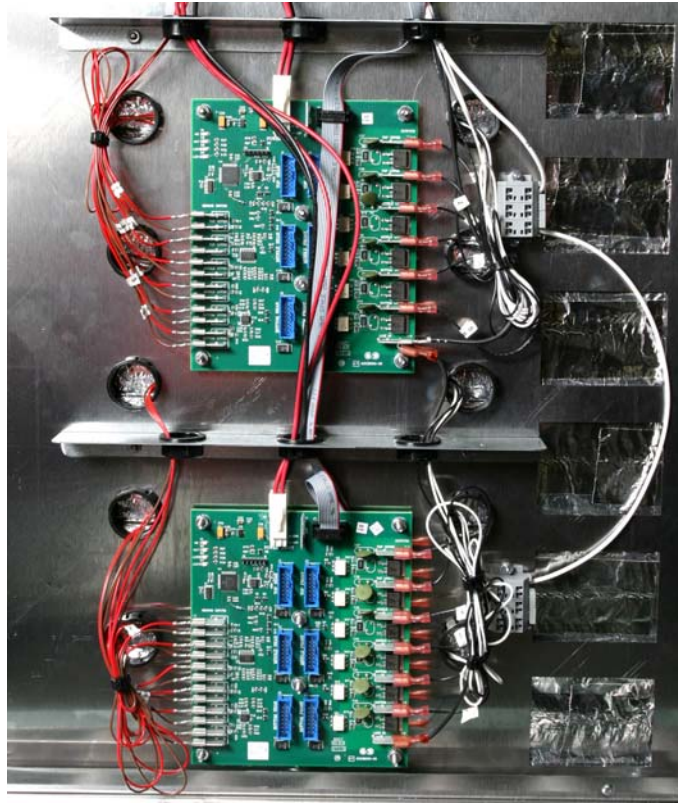

Fig. 6: Distribution board shown with display cables removed.

2.5.5 Shorted Triac

1. Turn the suspect row off and measure voltage between the suspect heater lead on the distribution board and the terminal block. With the row off, there should be no line voltage. If the triac is shorted, you will measure AC line voltage. If the triac is half waving, you will get DC voltage of approximately one-half the line AC voltage.

2.5.6 Heater Plate

1. Disconnect power to the cabinet. Remove side and top panels. Disconnect the black heater lead and the RTD leads (brown and red) of the suspect plate from distribution board. Measure resistance of the heater from the black lead to any terminal on the white terminal block. Resistance should be 140-150 ohms.
2. Measure resistance across the brown and red RTD leads. Resistance must be within a range of 104-148 ohms. Resistance at room temperature is approximately 107 ohms. See chart on **Page 2-4** for resistance at different temperatures. If either resistance is incorrect, replace the heater plate.

2.5.7 Display Meanings

1. ROW TEMP HIGH OR ROW TEMP LOW and no audible alarm. This is normal when the row is changing temperature in association with a menu change.
2. LLLL means the RTD indicates a temperature below 50°F (10°C). Unit will automatically heat at 20 percent until temperature is above 50°F (10°C), then operate normally.

Cabinet Service Procedures

3. HHHH means RTD indicates the temperature is above 255°F (124°C), but below "Open" circuit resistance, which causes SENS ALARM.
4. UHC VERSION _ _ _ (version number will vary) appears for five seconds when the unit is turned on.
5. The cabinet also displays a variety of error messages, which are shown on page 3-1.

2.6 Removing/Replacing Bezels

1. Remove power from unit.
2. Remove screws at the base of each side and remove side panels. (See figure 7.)
3. Unplug the bezel from the distribution board.
4. Plug the replacement bezel into the distribution board, return power to the unit and test the bezel/cabinet for accurate operation.
5. Remove replacement bezel and remove power from the unit.
6. Loosen the hex nut which secures the row and remove the allen screw, which holds the bezel. Also remove, if present, the small bezel-securing screw. (See photo below.)
7. Push, if necessary, on the mounted bezel through the access port in the inner panel to loosen the bezel. (See Figure 8 below.)
8. Remove bezel; clean and degrease the groove in the heater plate.
9. Route ribbon cable for the new bezel through the inner panel of the cabinet and press the new bezel into place. Ensure it is firmly seated and tighten hex nuts and replace allen screws.
10. Return sides and reposition cabinet for operation.



Fig. 7: Two screws (see arrows) at the base of each side of the cabinet secure the sides.

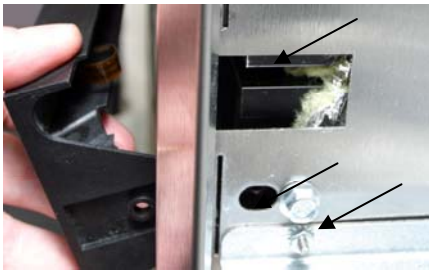

Fig. 8: Loosen the hex bolt and remove the allen screw (arrows, upper photo). Some row positions may have an additional screw securing the bezel to the cabinet (lower photo). Push through the access port (arrow, upper photo), if necessary, to remove the bezel from the cabinet .

Cabinet Service Procedures

2.6. 1 Removing/Replacing a Distribution Board or Communication Board

1. Remove power.
2. Remove and mark the wires on the faulty component.
3. Remove the board by lifting it from its standoffs.
4. Position the new board and attach wires.
5. Reapply power.
6. Run readdress steps on page 2-4.

2.6.2 Removing a Row

1. Remove the sides and top as shown in earlier steps. Disconnect the faulty row from the distribution board, and terminal block.
2. Remove the bezels on each end of the affected row, as shown in earlier steps, and the necessary adjacent bezels to remove the row.

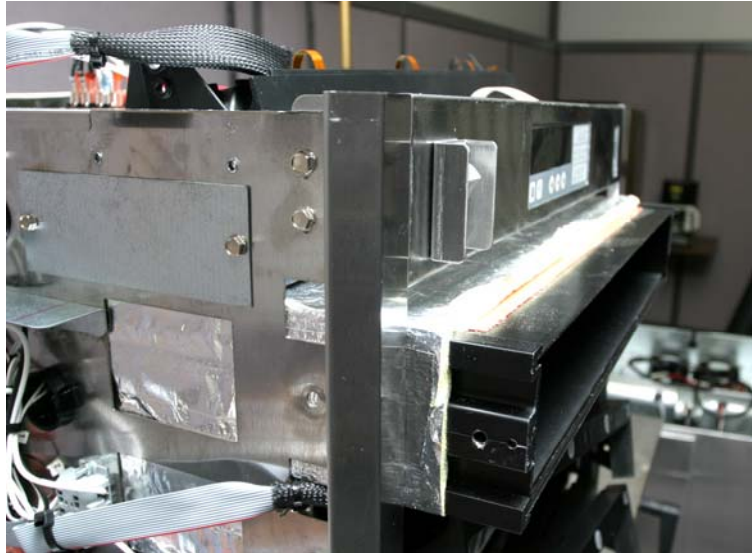

Fig. 9: A row is shown partially removed from the cabinet.

3. Remove wire wraps from wiring harness holding heater and control wires for affected row.
4. Lifting slightly, carefully slide the malfunctioning row out of the cabinet. Do not allow the row to contact or damage the controls of the unit below (Fig. 9).

2.6.3 Replace Heater Plate/RTD

1. Remove row as shown above.
2. Run your fingers around the outside surface of the row assembly. There are four raised areas. These are the setscrews, which hold the heater plate to the spacer. Punch holes in the insulation, directly above the location of the setscrews. (Fig. 10, 11).
3. Use an allen wrench to loosen the four spacer-setscrews along the edges of the plate.
4. Slide the malfunctioning plate out of the spacer.
5. Slide the replacement plate into position. Make sure the plate is inserted squarely. Tighten set screws.
6. Route the wires to one end of the row and wire tie the power wires together. Also wire tie the RTD wires together. Stand the row on the opposite end adjacent to the cabinet and feed the wires into the cabinet.
7. Carefully slide the row far enough into the cabinet to be stable.
8. On the opposite side, reach into the cavity and direct the wires through the appropriate grommets to reach the power and RTD connections on the distribution board.



Fig. 10, 11: Find the set screws under the foil insulation and push through with an allen wrench.

Cabinet Service Procedures

- Slide the row assembly completely into the cabinet and return the spacers between the heater plates. Ensure the row is evenly positioned in the cabinet. There must be sufficient space to allow the bezel tabs to fit between the outside row plate and the cabinet interior wall.
- Replace the bezels.



Fig. 12: The heater plate slides from the insulation.

⚠ CAUTION

**Ensure the heater plate setscrews are tightened securely to the spacer.
Tightening the setscrews will ensure the plate is properly grounded.**

Cabinet Troubleshooting

The master control display and the row displays show error messages when there is a problem. The messages are shown in the matrix below along with possible causes and diagnostic tests.

Error Message	Cause	Tests
CALL SERVICE ROW DISPLAY ERROR Row number also displayed *	The master control board has lost communication with the specified board.	<ul style="list-style-type: none"> • Turn the cabinet off and back on. • Ensure there are no software incompatibilities. • Inspect ribbon cable connections.
CALL SERVICE DISTRIBUTION BOARD 0 ERROR *	The master control board has lost communication with the top distribution board.	<ul style="list-style-type: none"> • A display connection can produce this display. Before replacing a distribution board, remove power from the unit and disconnect the displays from the affected distribution board. Return power to the unit and, one at a time, plug in the displays, cycling power each time. If the problem is display-related it will go away with the affected display disconnected.
CALL SERVICE DISTRIBUTION BOARD 1 ERROR *	The master control board has lost communication with the bottom distribution board.	
CALL SERVICE RATE OF RISE TOP **	Row's top plate failed to reach required temperature in prescribed time window after startup or when switching between menus.	<ul style="list-style-type: none"> • Turn the cabinet off and on, which can clear the problem if it is software related. • Check top plate RTD output against chart on page 2-4. • Enter service code (see page 2-1) and switch top plate on and off to ensure it is responding to cabinet circuits.
CALL SERVICE RATE OF RISE BOT **	Row's bottom plate failed to reach required temperature in prescribed time window after startup or when switching between menus.	<ul style="list-style-type: none"> • Turn the cabinet off and on, which can clear the problem if it is software related. • Check bottom plate RTD output against chart on page 2-4. • Enter service code (see page 2-1) and switch bottom plate on and off to ensure it is responding to cabinet circuits.
CALL SERVICE TOP ROW TEMP TOO HIGH **	RTD sensor is producing a reading that is out of range. The problem can be a failed RTD, heater or distribution board.	<ul style="list-style-type: none"> • Compare plate temperature to displayed temperature. • Compare plate RTD resistance to chart on page 2-4. • Switch plate on/off with service code to ensure it is responding to cabinet circuits. • With plate on and calling for heat, check amp draw on leads between distribution board and heater plate. Amp draw on a properly functioning plate should be 1.67.
CALL SERVICE BOT ROW TEMP TOO HIGH **		
CALL SERVICE TOP ROW TEMP TOO COOL **		
CALL SERVICE BOT ROW TEMP TOO COOL **		
CALL SERVICE TOP SENSOR ERROR HI TEMP **		
CALL SERVICE BOT SENSOR ERROR HI TEMP **		
CALL SERVICE TOP SENSOR ERROR LOW TEMP **		
CALL SERVICE BOT SENSOR ERROR LOW TEMP **		

* Shown on master control display. ** Shown on affected row display.

Cabinet Troubleshooting

Failure modes not accompanied by a master control display are shown below with possible causes and tests.

Symptom	Possible Causes	Tests
Unit fails to power up; fans don't run.	<ul style="list-style-type: none"> ● No power to cord. ● Blown 20 amp fuse. ● Circuit breaker open. 	<ul style="list-style-type: none"> ● Check for line voltage at the switch and the transformer. ● Reset circuit breaker.
Unit powers up and fans run; a display fails to light.	<ul style="list-style-type: none"> ● Broken or improperly seated ribbon cable. ● Defective display. 	<ul style="list-style-type: none"> ● Switch ribbon cable from functioning display to failed component to isolate problem.
Unit powers up and fans run; all displays fail to light.	<ul style="list-style-type: none"> ● Failed power supply. 	<ul style="list-style-type: none"> ● Check for 5VDC at communication board and distribution boards.
Rows heat improperly or not at all.	<ul style="list-style-type: none"> ● Improper wiring on distribution board. ● Defective distribution board. ● Defective heater. ● Defective sensor. 	<ul style="list-style-type: none"> ● Ensure heater leads and power inputs on the distribution boards are properly seated. ● Test for 208VAC input on distribution board and 208VAC output from heater leads to heater plate when the unit is calling for heat. ● Switch power leads from properly operating row to faulty row to isolate problem. ● Check resistance of RTD lead against temperature chart. See Page 2-4. ● Switch RTD lead from properly operating row to faulty row to isolate problem. ● Test continuity of heater plate.

Cabinet Parts

Parts Lists, Exploded Views

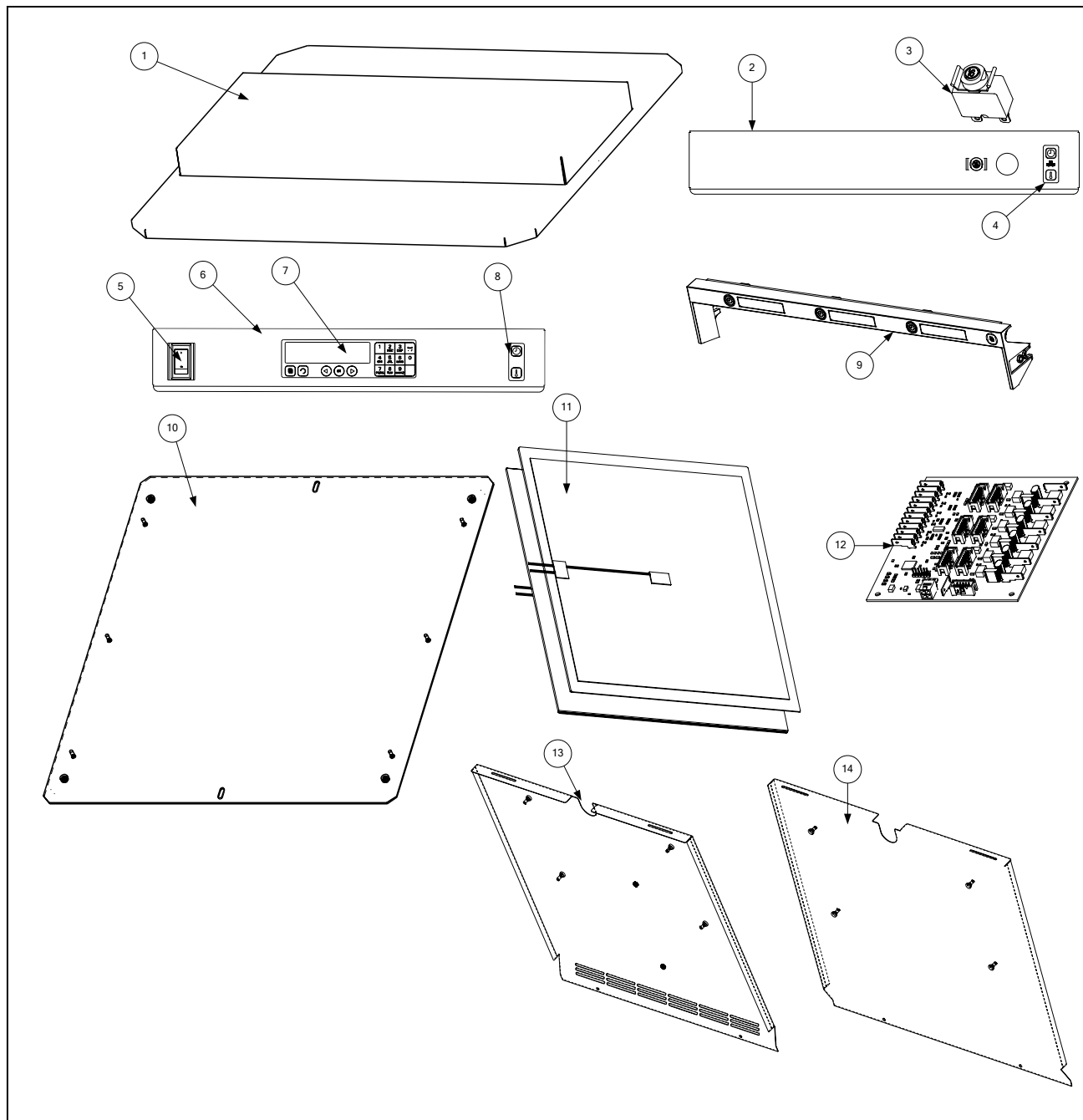

Item	Part Number	Description
1	108-1897	Top Cap
2	823-7636	Rear Fascia
3	807-4882	Circuit Breaker, 16 amp
4	807-5111	Time/Temperature switch
5	807-4911	Power switch
6	823-7513	Front fascia
7	807-5112	Master control overlay with ribbon cable
*	807-5156	Master display board (circuit board in master display assembly)

Cabinet Parts

Item	Part Number	Description
8	807-5111	Time/Temperature switch
9	826-2781	Bezel, with boards, front with short ribbon cable
*	826-2782	Bezel with boards, rear, with long ribbon cable
10	108-1190	Base
11	807-4857	Heater plate/RTD
12	807-4860	Distribution board
13	108-1633	Side, left, vented
14	108-1632	Side right, not vented

Component Shelf

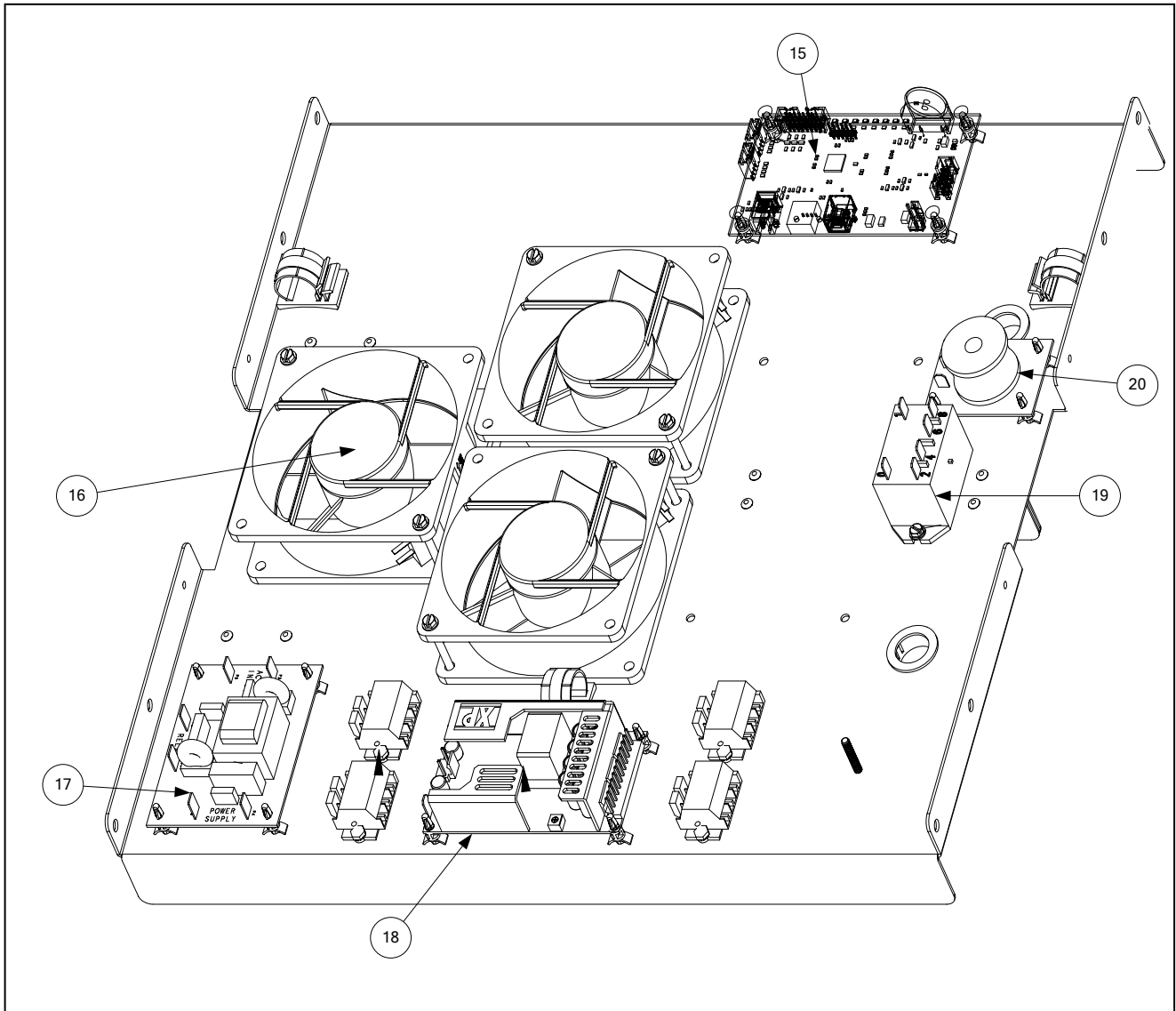

Item	Part Number	Description
15	807-5150	Master control board
16	807-2665	Blower
17	807-4951	LON board, domestic
*	807-4952	LON board, international

Cabinet Parts

Item	Part Number	Description
18	807-4868	Power Supply
19	807-3490	Power relay
20	406-0011	UHC-HD Single Filter Board
*		Ribbon Cables
*	807-4916	Time/Temp 18" used for front fascia
*	807-4917	Time/Temp 32" used for rear fascia
*	807-4875	Master distribution
*	807-4922	Power to upper distribution board
*	807-4923	Power to lower distribution board

*Not Illustrated

Wiring Diagram, Delta Power, L1-L2

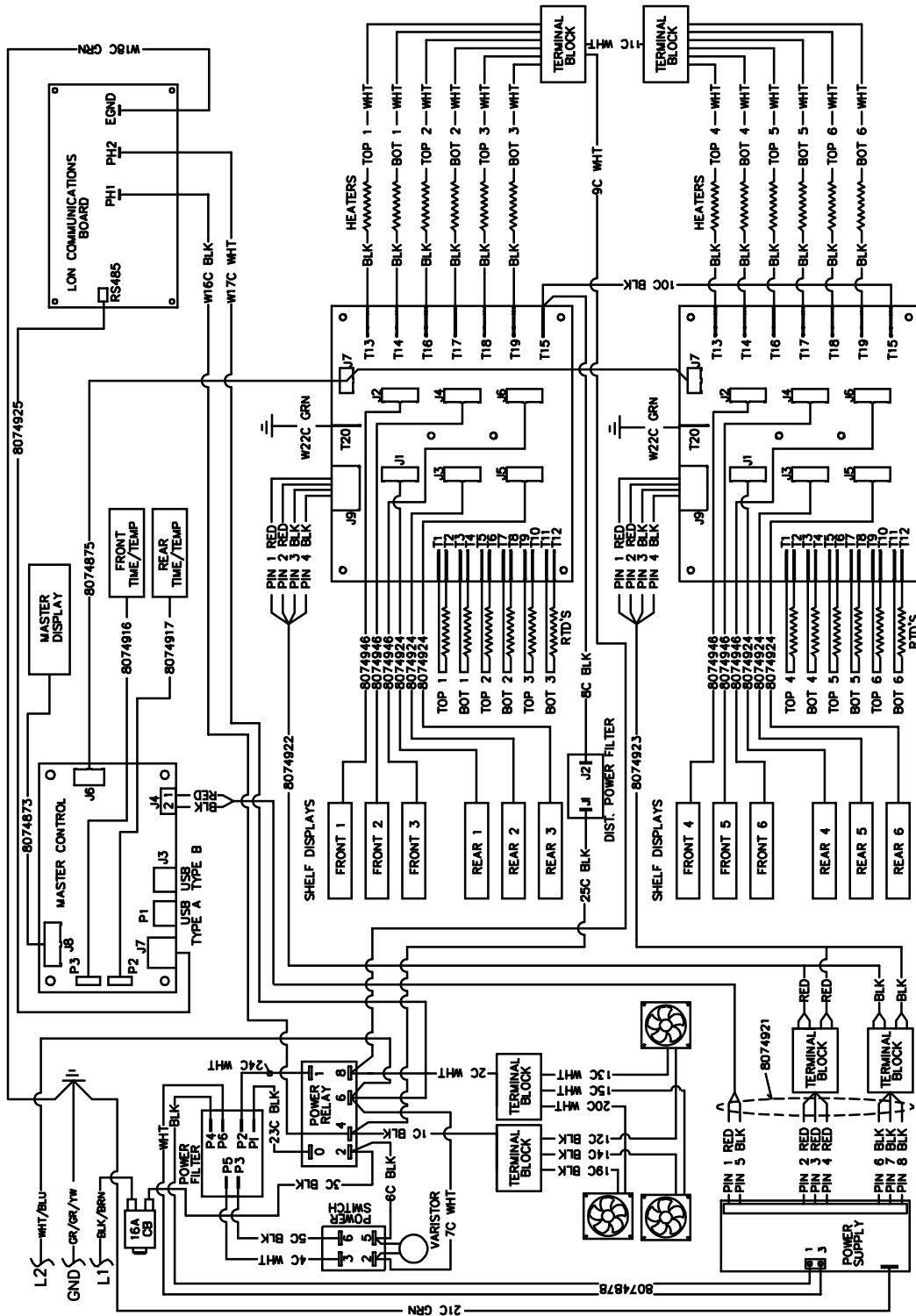

8051817H

Cabinet Wiring Diagrams

UHC-HD, WYE Power, L1-N

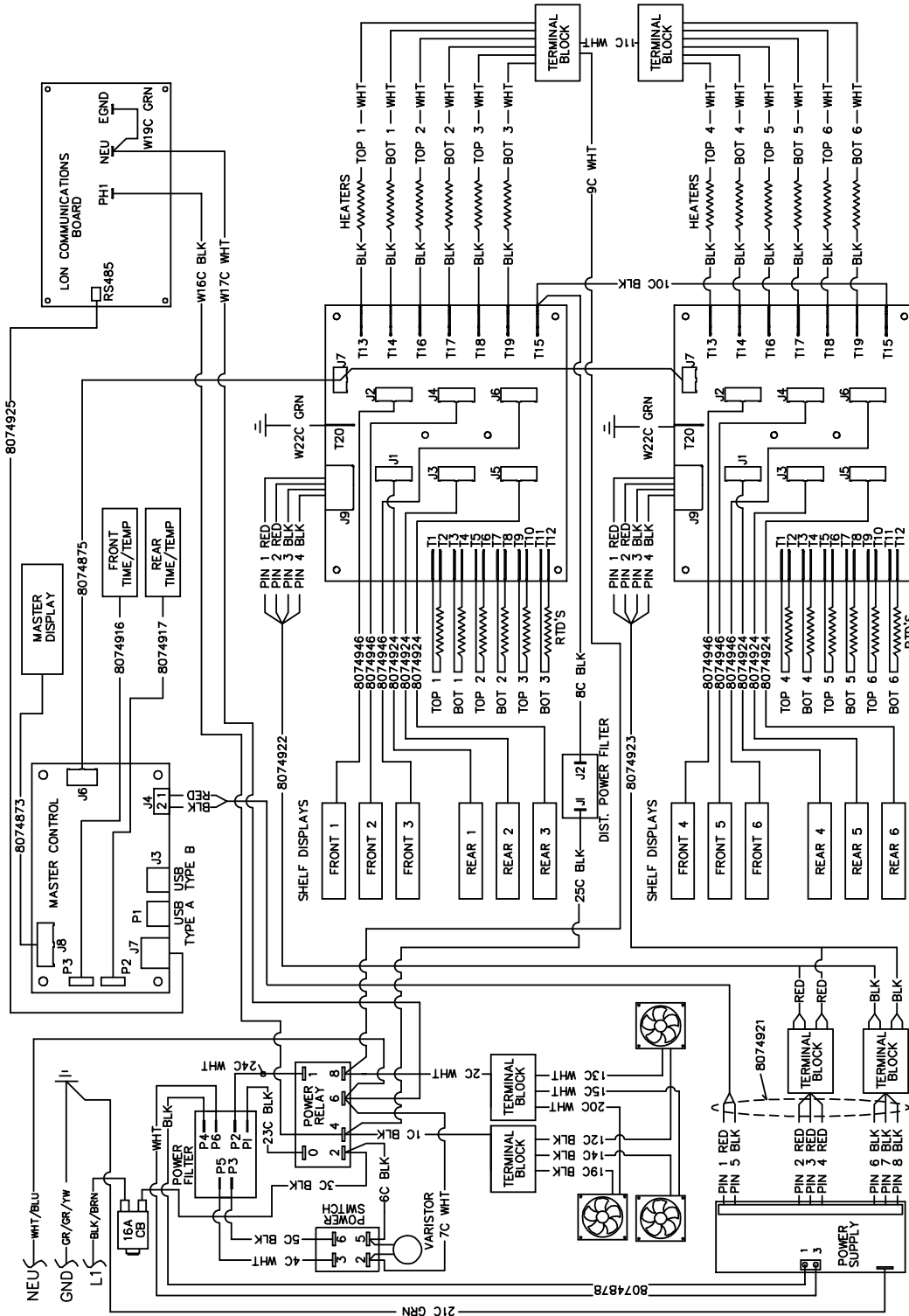

8051815H



Frymaster, L.L.C., 8700 Line Avenue, Shreveport, Louisiana 71106

TEL 1-318-865-1711 FAX (Parts) 1-318-219-7140 FAX (Tech Support) 1-318-219-7135

PRINTED IN THE UNITED STATES

SERVICE HOTLINE
1-800-551-8633

Price: \$6.00
819-6606
OCT 2010

Free Manuals Download Website

<http://myh66.com>

<http://usermanuals.us>

<http://www.somanuals.com>

<http://www.4manuals.cc>

<http://www.manual-lib.com>

<http://www.404manual.com>

<http://www.luxmanual.com>

<http://aubethermostatmanual.com>

Golf course search by state

<http://golfingnear.com>

Email search by domain

<http://emailbydomain.com>

Auto manuals search

<http://auto.somanuals.com>

TV manuals search

<http://tv.somanuals.com>