



**Y/KSCF/C/HC18G High Efficiency
Cool Zone Series Gas Fryers
Installation and Operation Manual**



 **Frymaster**

CFESA
Commercial Food Equipment Service Association

Frymaster, a member of the Commercial Food Equipment Service Association, recommends using CFESA Certified Technicians.

24-Hour Service Hotline 1-800-551-8633

Price: \$10.00

*** 8196329 *
APR 2011**

Please read all sections of this manual and retain for future reference.

NOTICE

This appliance is intended for professional use only and is to be operated by qualified personnel only. A Frymaster and Dean Factory Authorized Servicer (FAS) or other qualified professional should perform installation, maintenance, and repairs. Installation, maintenance, or repairs by unqualified personnel may void the manufacturer's warranty. See Chapter 1 of this manual for definitions of qualified personnel.

NOTICE

IF, DURING THE WARRANTY PERIOD, THE CUSTOMER USES A PART FOR THIS MANITOWOC FOOD SERVICE EQUIPMENT OTHER THAN AN UNMODIFIED NEW OR RECYCLED PART PURCHASED DIRECTLY FROM FRYMASTER DEAN, OR ANY OF ITS AUTHORIZED SERVICE CENTERS, AND/OR THE PART BEING USED IS MODIFIED FROM ITS ORIGINAL CONFIGURATION, THIS WARRANTY WILL BE VOID. FURTHER, FRYMASTER DEAN AND ITS AFFILIATES WILL NOT BE LIABLE FOR ANY CLAIMS, DAMAGES OR EXPENSES INCURRED BY THE CUSTOMER WHICH ARISE DIRECTLY OR INDIRECTLY, IN WHOLE OR IN PART, DUE TO THE INSTALLATION OF ANY MODIFIED PART AND/OR PART RECEIVED FROM AN UNAUTHORIZED SERVICE CENTER.

NOTICE

This equipment must be installed in accordance with the appropriate national and local codes of the country and/or region in which the appliance is installed.

NOTICE

Drawings and photos used in this manual are intended to illustrate operational, cleaning and technical procedures and may not conform to onsite management operational procedures.

NOTICE TO OWNERS OF UNITS EQUIPPED WITH CONTROLLERS

U.S.

This device complies with Part 15 of the FCC rules. Operation is subject to the following two conditions: 1) This device may not cause harmful interference, and 2) This device must accept any interference received, including interference that may cause undesired operation. While this device is a verified Class A device, it has been shown to meet Class B limits.

Canada

This digital apparatus does not exceed the Class A or B limits for radio noise emissions as set out by the ICES-003 standard of the Canadian Department of Communications.

Cet appareil numérique n'émet pas de bruits radioélectriques dépassant les limites de classe A et B prescrites dans la norme NMB-003 édictée par le Ministre des Communications du Canada.

 DANGER

Improper installation, adjustment, maintenance or service, and unauthorized alterations or modifications can cause property damage, injury, or death. Read the installation, operating and service instructions thoroughly before installing or servicing this equipment. Only qualified service personnel may convert this appliance to use a gas other than that for which it was originally configured. See Chapter 1 of this manual for definition of qualified service personnel.

⚠ DANGER

Adequate means must be provided to limit the movement of this appliance without depending upon the gas line connection. Single fryers equipped with legs must be stabilized by installing anchor straps. All fryers equipped with casters must be stabilized by installing restraining chains. If a flexible gas line is used, an additional restraining cable must be connected at all times when the fryer is in use.

⚠ DANGER

The front ledge of the fryer is not a step. Do not stand on the fryer. Serious injury can result from slips or contact with the hot oil.

⚠ DANGER

Do not store or use gasoline or other flammable vapors and liquids in the vicinity of this or any other appliance.

⚠ DANGER

Instructions to be followed in the event the operator smells gas or otherwise detects a gas leak must be posted in a prominent location. This information can be obtained from the local gas company or gas supplier.

⚠ DANGER

The crumb tray in fryers equipped with a filter system must be emptied into a fireproof container at the end of frying operations each day. Some food particles can spontaneously combust if left soaking in certain shortening material. Additional information can be obtained in the filtration manual included with the system.

⚠ WARNING

No structural material on the fryer should be altered or removed to accommodate placement of the fryer under a hood. Questions? Call the Frymaster Dean Service Hotline at 1-800-551-8633.

⚠ WARNING

Do not bang fry baskets or other utensils on the fryer's joiner strip. The strip is present to seal the joint between the frypot. Banging fry baskets on the strip to dislodge shortening will distort the strip, adversely affecting its fit. It is designed for a tight fit and should only be removed for cleaning.



Y/KSCF/C/HC18G Cool Zone Gas Fryers

INSTALLATION & OPERATION MANUAL

TABLE OF CONTENTS

	Page #
1. INTRODUCTION.....	1-1
2. IMPORTANT INFORMATION.....	2-1
3. INSTALLATION INSTRUCTIONS.....	3-1
4. DAILY OPERATION.....	4-1
5. FILTRATION.....	5-1
6. PREVENTATIVE MAINTENANCE.....	6-1
7. TROUBLESHOOTING.....	7-1

Y/KSCF/C/HC18G HIGH EFFICIENCY COOL ZONE SERIES GAS FRYERS

CHAPTER 1: INTRODUCTION

1.1 After Purchase

In order to improve service, have the following chart filled in by the Factory Authorized Servicer who installed this equipment.

Authorized Servicer Technician/FAS	_____
Address	_____ _____
Telephone/Fax	_____
Model Number	_____
Serial Number	_____
Gas Type	_____

1.2 Ordering Parts

Customers may order parts directly from their local factory authorized servicer (FAS). If the telephone number of your FAS is not listed above, call the Frymaster Service Hotline telephone number, 1-800-551-8633.

To speed up your order, provide the model number, serial number, gas type, part needed, item part number (if known), and quantity needed.

1.3 Service Information

Call the Frymaster Service Hotline, 1-800-551-8633, for the location of your nearest factory authorized servicer (FAS). To assist you more efficiently, always provide the service technician with the model number, gas type, serial number, and the nature of the problem.

1.4 Controller Information

This equipment has been tested and found to comply with the limits for a Class A digital device, pursuant to Part 15 of the FCC rules. While this device is a verified Class A device, it has been shown to meet the Class B limits. These limits are designed to provide reasonable protection against harmful interference when the equipment is operated in a commercial environment. This equipment generates, uses, and can radiate radio frequency energy and, if not installed and used in accordance with the instruction manual, may cause harmful interference to radio communications. Operation of the equipment in a residential area is likely to cause harmful interference in which case the user will be required to correct the interference at his own expense.

The user is cautioned that any changes or modifications not expressly approved by the party responsible for compliance could void the user's authority to operate the equipment.

If necessary, the user should consult the dealer or an experienced radio and television technician for additional suggestions.

The user may find the following booklet prepared by the Federal Communications Commission helpful: "How to Identify and Resolve Radio-TV Interference Problems". This booklet is available from the U.S. Government Printing Office, Washington, DC 20402, Stock No. 004-000-00345-4.

1.5 Safety Information

Before attempting to operate your unit, read the instructions in this manual thoroughly.

Throughout this manual, you will find notations enclosed in double-bordered boxes similar to the ones below.

 **CAUTION**

CAUTION boxes contain information about actions or conditions that *may cause or result in a malfunction of your system.*

 **WARNING**

WARNING boxes contain information about actions or conditions that *may cause or result in damage to your system*, and which may cause your system to malfunction.

1.5 Safety Information (cont.)

 **DANGER**

DANGER boxes contain information about actions or conditions, which *may cause or result in injury to personnel*, may cause damage to your system, and/or cause your system to malfunction.

1.6 Service Personnel

- A. Qualified and/or Authorized Operating Personnel:** Qualified/authorized operating personnel are those who have carefully read the information in this manual and have familiarized themselves with the equipment functions, or have had previous experience with the operation of equipment covered in this manual.
- B. Qualified Installation Personnel:** Qualified/authorized personnel are those who have carefully read the information in this manual and have familiarized themselves with the equipment functions, or who have had previous experience with the operation of the equipment covered in this manual.
- C. Qualified Service Personnel:** Qualified service personnel are those who are familiar with Frymaster equipment and are authorized by Frymaster to perform service on Frymaster equipment. All authorized service personnel are required to be equipped with a complete set of service parts manuals and stock a minimum amount of parts for Frymaster equipment. A list of Frymaster Factory Authorized Servicers (FAS's) was included with the fryer when shipped from the factory. *Failure to use qualified service personnel will void the Frymaster warranty on your equipment.*

Y/KSCF/C/HC18G HIGH EFFICIENCY COOL ZONE SERIES GAS FRYERS

CHAPTER 2: IMPORTANT INFORMATION

2.1 Receiving and Unpacking Equipment

- A. Check that the container is upright. Use an outward prying motion - *no hammering* - to remove the carton. Unpack the fryer carefully and remove all accessories from the carton. Do not discard or misplace these, as they will be needed.
- B. After unpacking, immediately check the equipment for visible signs of shipping damage. If damage has occurred, contact the carrier and file the appropriate freight claims. Do not contact the factory. Shipping damage responsibility is between the carrier and the dealer.

If your equipment arrives damaged:

1. File claim for damages immediately, regardless of extent of damage.
2. Visible loss or damage: Be sure this is noted on the freight bill or express receipt and is signed by the person making the delivery.
3. Concealed loss or damage: If damage is unnoticed until equipment is unpacked, notify freight company or carrier immediately, and file a concealed damage claim. This should be done within fifteen (15) days of date of delivery. Be sure to retain container for inspection.

NOTE: Frymaster Does Not Assume Responsibility for Damage or Loss Incurred in Transit.

- C. **Frying systems with built-in filtration:** Take off the filter support brace and remove the filter pan from the cabinet.
- D. Remove all plastic skin from sides, front, and doors of the fryer(s). Failure to do this prior to initial fryer operation will make it very difficult to remove later.

2.2 General

Upon arrival, inspect the fryer carefully for visible or concealed damage. (See *Receiving and Unpacking Equipment*, Section 2.1.)

The Frymaster Y/KSCF/C/HC18G High Efficiency Cool Zone Series Fryers are energy-efficient, gas-fired units, design-certified by the International Approval Services (AGA/CGA), Gaz de France, and NSF International and manufactured to their basic performance and application specifications.

All units are shipped completely assembled with accessories packed inside the frypots. All units are adjusted, tested, and inspected at the factory before shipment. Sizes, weights, and input rates of all models are listed in this manual.

2.3 Principles of Operation

The incoming gas flows through orifices and is mixed with air in the burners to create the correct ratio for proper combustion. The mixture is ignited at the front end of each heat tube by the pilot light. Internal diffusers slow the flame as it goes through the burner tube. This slow, turbulent flame increases heat transfer to the walls of the tubes to heating the oil more efficiently.

2.4 Rating Plate

This is attached to the inside of the front door panel. Information provided includes the model and serial number of the fryer, BTU/hr (kW/hr) input of the burners, outlet gas pressure in inches W.C. (mbars), and whether the unit has natural (G20/25) or propane (G31) gas orifices.

2.5 Pre-Installation

 **DANGER**

This appliance is equipped with a three-prong (grounding) plug for your protection against electrical shock and must be plugged directly into a properly grounded three-prong receptacle. Do not cut, remove, or otherwise bypass the grounding prong on this plug.

A. **General:** Only licensed personnel should install any gas-fired equipment.

1. A manual gas shut-off valve must be installed in the gas supply line ahead of the fryers for safety and ease of future service.
2. The Frymaster Y/KSCF/C/HC18G gas fryers require 120 volts (AC) 60-cycle electrical service for U.S./Canada/Mexico installations. Fryers are equipped with a 16-3 SJT grounded flexible power cord for a direct connection to the power supply. Amperage draw for each unit depends on the accessories supplied with the unit. See detailed instructions packaged with the fryer line-up.

 **DANGER**

No structural material on the fryer should be altered or removed to accommodate placement of the fryer under a hood. Questions? Call the Frymaster Service Hotline at 1-800-551-8633.

2.5 Pre-Installation (cont.)

 **DANGER**

This appliance must be installed with sufficient ventilation to prevent the occurrence of unacceptable concentrations of substances harmful to the health of personnel in the room in which it is installed.

B. Clearances: The fryer area must be free of all combustibles. This unit is design-certified for the following installations:

1. Commercial installation only; **not** for household use.
2. Non-combustible floor installation equipped with factory-supplied 6-inch (15-cm) adjustable legs or 5-inch (13-cm) casters;
3. Combustible construction with a minimum clearance of 6-inches (15-cm) side and 6-inches (15-cm) rear, and equipped with factory-supplied 6-inch (15-cm) adjustable legs or 5-inch (13-cm) casters.

C. Installation Standards

<p>1. U.S. installations must meet:</p> <p>American National Standard Institute ANSI Z83.11 American Gas Association 8501 E. Pleasant Valley Road Cleveland, OH 44131</p> <p>National Electrical Code ANSI/NFPA #70 American National Standard Institute 1430 Broadway New York, NY 10018</p> <p>NFPA Standards #96 and #211 National Fire Protection Association 470 Atlantic Avenue Boston, MA 02110</p>	<p>2. Canadian installations must meet:</p> <p>CAN 1-B149 Installation Codes Canadian Gas Association 55 Scarsdale Road Don Mills, ONT, M3B 2R3</p> <p>Canadian Electric Code c22.1, part 1 Canadian Standards Association 178 Rexdale Blvd. Rexdale, ONT, M9W 1R3</p> <p>3. Australian installations must meet:</p> <p>AS5601/AG601 Installation Codes Standards Australia International 25 Raglan Street South Melbourne, VIC 3205</p>
---	---

2.6 Air Supply and Ventilation



Do not connect this appliance to the gas supply before reviewing each step in this section.

- A. Keep the area around the fryer clear to prevent obstruction of combustion and ventilation airflow and to allow for service and maintenance. Always adhere to the following:
1. Do not connect this fryer to an exhaust duct.
 2. Follow installation and adjustment procedure to ensure adequate airflow to the fryer system.
 3. A heavy-duty, commercial fryer's combustion wastes must vent to the outside of the building. A deep-fat fryer must be installed under a powered exhaust hood, or an exhaust fan must be provided in the wall above the unit. Exhaust gas temperatures are approximately 800-1000°F (427-538°C). Check air movement during installation. Strong exhaust fans in the exhaust hood or in the overall air conditioning system can produce slight air drafts in the room and cause erratic burner flames or improper fryer operation.
 4. Do not place the fryer's flue outlet directly into the plenum of the hood, as it will affect the gas combustion of the fryer.
 5. **Never** use the interior of the fryer cabinet for storage or store items on shelving over or behind the fryer. Exhaust temperatures can exceed 800°F (427°C) and may damage or melt items stored in or near the fryer.
 6. Adequate distance must be maintained from the flue outlet of the fryer(s) to the lower edge of the filter bank. Per NFPA Standards No. 96, a minimum of 18-inches (45-cm) should be maintained between the flue(s) and the lower edge of the exhaust hood filter.
 7. Filters and drip troughs should be part of an industrial hood, but consult local codes before constructing and installing any hood. The duct system, the exhaust hood, and the filter bank must be cleaned on a regular basis and kept free of grease.

2.7 Equipment Installed at High Altitudes

- A. The fryer input rating [BTU/hr (kW/hr)] is for elevations up to 2,000 feet (610 m). For elevations above 2,000 feet (610 m), the rating should be reduced 4% for each additional 1,000 feet (305 m) above sea level.
- B. The correct orifices are installed at the factory if operating altitude is known at time of the customer's order.

2.8 Restraining the Fryer

⚠ DANGER

No structural material on the fryer should be altered or removed to accommodate placement of the fryer under a hood. Questions? Call the Frymaster Dean Service Hotline at 1-800-551-8633.

1. Once the fryer has been positioned at the frying station, use a carpenter's level placed across the top of the frypot to verify that the unit is level, both side-to-side and front-to-back.
 - To level fryers equipped with legs, the bottom of the legs can be screwed out up to one inch for leveling. Legs should also be adjusted so that the fryer(s) are at the proper height in the frying station.
 - For fryers equipped with casters, there are no built-in leveling devices. The floor where the fryers are installed must be level.
2. With the fryer level in its final position, install the restraints provided with the unit to limit its movement so that it does not depend on or transmit stress to the electrical conduits/connections or the gas supply line. Install the restraints in accordance with the provided instructions (see illustration below). If disconnected for service or other reasons, the restraints must be reconnected before the fryer is used.

⚠ DANGER

Adequate means must be provided to limit the movement of this appliance without depending on or transmitting stress to the electrical conduit. A restraint kit is provided with the fryer. If the restraint kit is missing contact your local Frymaster Factory Authorized Servicer (FAS) for part number 826-0900.

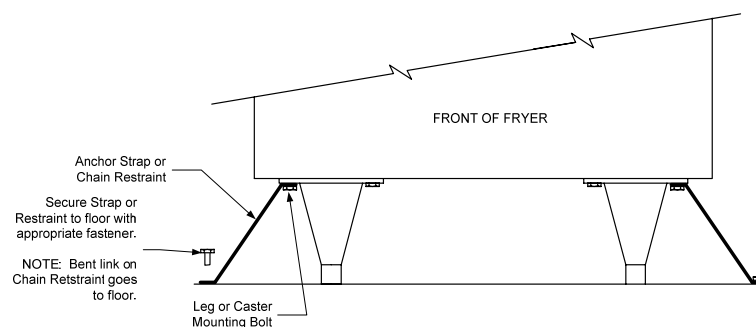

NOTE: If you need to relocate a fryer installed with legs, remove all weight from each leg before moving. If a leg is damaged, contact your service agent for immediate repair or replacement.

Y/KSCF/C/HC18G HIGH EFFICIENCY COOL ZONE SERIES GAS FRYERS
CHAPTER 2: IMPORTANT INFORMATION

 **DANGER**

Hot oil can cause severe burns. Avoid contact. Under all circumstances, oil must be removed from the fryer before attempting to move it to avoid oil spills, falls and severe burns. This fryer may tip and cause personal injury if not secured in a stationary position.

 **DANGER**

Do not attach an apron drain board to a single unit. The appliance may become unstable, tip over, and cause injury. The appliance area must be free and clear of combustible material at all times.

Y/KSCF/C/HC18G HIGH EFFICIENCY COOL ZONE SERIES GAS FRYERS

CHAPTER 3: INSTALLATION INSTRUCTIONS

3.1 Installing the Fryer

Qualified, licensed, authorized installation or service personnel only (as defined in Section 1.6) should perform the following:

1. Installation and service of Frymaster equipment;
2. Conversion of this appliance from one gas type to another.

Failure to use qualified, licensed, and/or authorized installation or service personnel to install, convert to another gas type, or otherwise service this equipment will void the Frymaster warranty and may result in damage to the equipment or injury to personnel.

Where conflicts exist between instructions and information in this manual and local code or national codes and regulations, installation and operation shall comply with the codes or regulations in force in the country in which the equipment is installed.

- A. **Initial Installation:** If installed with legs, do not push against any unit edges to adjust its position. Use a pallet or lift jack to lift it slightly and place it where it is to be installed.
- B. **Relocating the Fryer:** If relocating a fryer installed with legs, remove all weight from each leg before moving.

NOTE: If a leg becomes damaged during movement, contact your service agent for immediate repair or replacement.

 **DANGER**

Building codes prohibit a fryer with an open tank of oil being installed beside an open flame of any type, including those of broilers and ranges.

3.2 Leg and Caster Installation

 **DANGER**

Frymaster fryers equipped with legs are for permanent installations. Fryers fitted with legs must be lifted during movement to avoid damage and possible bodily injury. For a moveable or portable installation, optional equipment casters must be used. Questions? Call 1-800-551-8633

A. General

1. Because neither legs nor rigid rear casters are secure for long transit, install them near the area of use. This unit cannot be curb mounted and must be equipped with the legs and rear rigid casters provided.

3.2 Leg and Caster Installation (cont.)

2. When positioning the fryer, gently lower it into position to prevent undue strain to the legs and internal mounting hardware. If possible, use a pallet or lift jack to lift and position the fryer. Tilting the fryer may damage the legs.
3. The rigid casters must be installed on the fryer rear channel assembly only.

B. Installation

1. Remove unit from pallet.
2. Carefully raise unit with forklift, pallet jack, or other steady means.
3. Place one lock washer on each hex head screw.
4. Insert hex head screws with lock washers [1/4-20 threads by 3/4" (19 mm) long] through bolt holes of leg mounting plates and mount to the front channel. Mount rigid casters to the rear channel following the same procedure. Locknuts have been attached to the topside of the base mounting plates at the factory to capture hex head screws as they are screwed in.
5. Tighten the bolts to 50 in-lbf (5.65 joules) minimum torque.
6. After legs and rear rigid casters are installed, proceed to Step 3.3, *Leveling the Fryer*, to ensure the fryer is level before use.



WARNING

For caster retrofit, the unit must be at room temperature and drained of shortening before installing the casters.

3.3 Leveling the Fryer

- A. Place a level across the top of the fryer and level the unit front-to-back. If the fryer is uneven side-to-side, a platform or other surface adjustment is needed; there is no side-to-side level adjustments on a fryer equipped with caster/leg combinations (If a fryer is equipped with legs only, side to side level adjustments can be made. If a fryer is equipped with casters only, no level adjustments to the fryer can be made.). If the fryer is not level, the unit may not function efficiently, the oil may not drain properly for filtering, and it may not match adjacent units in a multi-fryer battery.

3.3 Leveling the Fryer (cont.)

- **Legs (Only)**

1. Adjust leg height with an adjustable or $1\frac{1}{16}$ -inch (27-mm) open-end wrench by turning the hex bullet on the bottom of the leg.
2. The hex bullet is for minor leg height adjustment only. Do not adjust more than 1 inch (25 mm).
3. When leveling the unit, the leg body should be held firmly to keep the leg from bending or rotating while turning the hex bullet foot to the required height.

- **Rigid Casters (Only)**

1. Install rigid casters on the fryer rear channel only. Legs must be installed on the front channel.
2. There are no level-adjustments for the rigid casters.

B. If the floor is uneven or has a decided slope, place the fryer on a smooth platform.

C. If the fryer is moved, re-level the fryer following the instructions given in Steps 3.3, A-C.

D. Installing Optional Swivel Casters

1. Install non-locking casters only at the rear of the unit.
2. Locking casters must be installed at the front of the unit. Locking casters allow the fryer to be "locked" in position for safe operations.
3. Follow the same instructions for leg installations as given above in Steps 3.2, B1-B5.

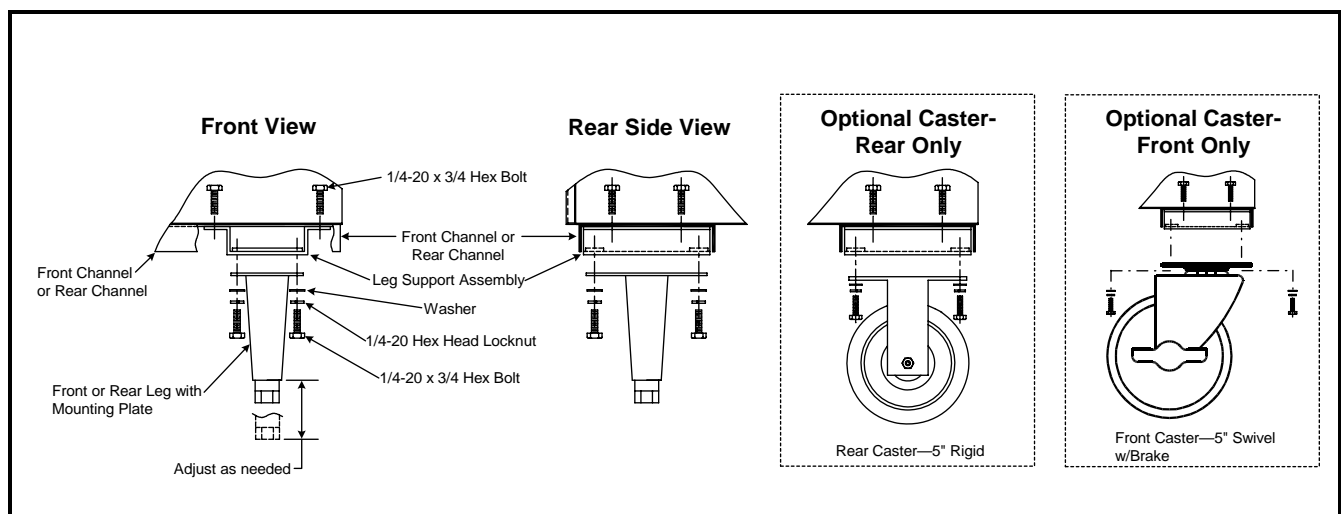

Leg and Caster (Optional) Mounting Installation

3.3 Leveling the Fryer (cont.)

ANSI Z83.11/11a-(Latest Edition) requires a fryer be restrained to prevent tipping when installed in order to avoid the splashing of hot liquid. The means of restraint may be the manner of installation, such as connection to battery of appliances or installing the fryer in an alcove, or by separate means, such as adequate ties (chains, straps, etc.). A bracket has been provided on the fryer back panel for this purpose.

NOTE: The installation must be inspected after it is complete to ensure it meets the intent of these instructions. The on-site supervisor and/or operator(s) should be informed that the appliance is installed with restraints. If restraints are removed to move fryer (e.g., to clean beneath and behind, to relocate) ensure that they are re-installed when fryer is returned to its permanently installed position.

For information on fryer restraints, see **Section 2.8**.

3.4 Gas Connections

The gas supply (service) line must be the same size or greater than the fryer inlet line. YSCFH18G gas fryers are equipped with a 3/4-inch (22-mm) male inlet. The gas supply line must be sized to accommodate all gas-fired equipment connected to that gas supply. Consult local gas companies/suppliers or your local contractor for minimum supply line requirements.
Supply Line Specifications

The gas supply lines must be sized as indicated in the chart below, based on the total number of fryers connected to the main gas supply.

Gas Types	Recommended Gas Supply Line Sizes		
	Number of Fryers		
	1	2 to 3	4 or more*
Natural Gas	3/4" (22 mm)	1" (28 mm)	1 1/4" (35 mm)
Propane Gas	1/2" (15 mm)	3/4" (22 mm)	1" (28 mm)

* When exceeding 18 feet (6 meters) for a configuration of more than four fryers, it is necessary to provide a 1 1/4" (35 mm) rigid gas connection.

 **DANGER**

All connections must be sealed with a joint compound suitable for the gas being used and all connections must be tested with a solution of soapy water before lighting any pilots.

Never use matches, candles, or any other ignition source to check for leaks. If gas odors are detected, shut off the gas supply to the appliance at the main shut-off valve and immediately contact the local gas company or an authorized service agency for service.

3.4 Gas Connections (cont.)

 **DANGER**

"Dry-firing" your unit will cause damage to the frypot and can cause a fire. Before firing the unit, always ensure that melted shortening, cooking oil, or water is in the frypot.

 **DANGER**

Before connecting new pipe to this appliance, the pipe must be blown out thoroughly to remove all foreign material. Foreign material in the burner and gas controls will cause improper and dangerous operation.

Rigid Connections

Check any installer-supplied intake pipe(s) visually and clean metal particles or other foreign matter from the threads before installing into a service line. If the intake pipes are not clear of all foreign matter, the orifices will clog when gas pressure is applied. When using thread compound on gas piping, use very small amounts and only on male threads. Use a pipe thread compound that is not affected by the chemical action of LP gases. DO NOT apply thread compound to the first two pipe threads—doing so will cause clogging of the burner orifices and control valve.

Manual Shut-off Valve

This gas service supplier-installed valve must be installed in the gas service line ahead of the fryers in the gas stream and in a position where it can be reached quickly in the event of an emergency.

Regulating Gas Pressure

The fryer and its individual shut-off valve must be disconnected from the gas supply piping system during any pressure testing of the gas supply system, especially if the test pressures are in excess of ½ PSI (3,45 kPa/35 mbar).

External gas regulators are not normally required on this fryer. A safety control valve protects the fryer against pressure fluctuations. If the incoming pressure is in excess of ½ PSI (3,45 kPa/35 mbar), a step-down regulator is required.

 **DANGER**

When pressure-testing incoming gas supply lines, disconnect the fryer from the gas line if the test pressure is 3,45 kPa (½ PSI, 14" W.C.) or greater to avoid damage to the fryer's gas piping and gas valve(s).

3.4 Gas Connections (cont.)

- A. **Manifold Pressure:** Your local service technician should check the manifold pressure with a manometer.
1. Check the rating plate for manifold gas pressures. Natural gas units normally require 4" W.C., and propane units normally require 11" W.C. gas pressure.
 2. Confirm that the arrow forged into the bottom of the regulator body, which indicates gas flow direction, is pointed downstream towards the fryers. The air vent cap is also part of the regulator and should not be removed.
 3. If a vent line from the gas pressure regulator is used, it should be installed in accordance with local codes or in the absence of local codes, with the National Fuel Gas Code, ANSI Z223.1-(Latest Edition).

 **WARNING**

Use a diluted soap solution to find potentially dangerous gas leaks when making new connections.

- B. **Regulators:** Gas regulators can be adjusted in the field, but no adjustments should be made unless the regulator is out of adjustment or serious pressure fluctuations are observed.
- C. Only qualified service personnel should make adjustments to the regulators.
- D. **Orifices:** The fryer can be ordered to operate on any available gas. The correct combination gas valve, appropriate burner orifices, and pilot burners are installed at the factory. While the valve can be adjusted in the field, only qualified service personnel should make any adjustments with the proper test equipment.

 **DANGER**

If gas odors are detected, the gas supply must be shut off at the main shut-off valve. The local gas company or FAS should be contacted immediately to fix the problem.

E. Flexible Couplings, Connectors and Casters:

1. If the fryer is to be installed with flexible couplings and/or quick-disconnect fittings, the installer must use a heavy-duty AGA design-certified commercial flexible connector of at least 3/4" NPT (with suitable strain-relief attachments), in compliance with the Standard for Connectors for Movable Gas Appliances, ANSI Z21.69-(Latest Edition) and Addenda Z21.69a-(Latest Edition). Quick disconnect devices must comply with the Standard for Quick-Disconnect Devices for Use with Gas Fuel, ANSI Z21.41-(Latest Edition).

3.4 Gas Connections (cont.)

2. For an appliance equipped with casters, the installation shall be made with a connector that complies with the Standard for Connectors for Movable Gas Appliances, ANSI Z21.69, or Connectors for Moveable Gas Appliances, CAN/CGA-6.16. A quick-disconnect device that complies with the Standard for Quick-Disconnect Devices for Use with Gas Fuel, ANSI Z21.41, or Quick-Disconnect Devices for Use with Gas Fuel, CANI-6.9, must be used. Under no circumstances are the connector and the quick-disconnect device or its associated piping to be used to limit fryer movement.
3. The fryer must be restrained by means independent of the flexible coupling or connector in order to limit the movement of the fryer. Clips are located on the back panel of the fryer for the attachment of restraints.
4. If it is necessary to disconnect the restraint, it must be reconnected after the fryer has been returned to its originally installed position.

 **WARNING**

Do not attach accessories to this fryer unless fryer is secured from tipping. Personal injury may result.

- F. After hook-up, bleed the gas line of air to ensure that the pilot light will ignite quickly and evenly.

 **WARNING**

Qualified personnel MUST perform any adaptation, modification, or gas conversion, if required. Failure to use qualified personnel will void the Frymaster warranty.

3.5 Adjustments/Adaptation To Different Gases

- A. Proper operation of appliances requires the operator to scrupulously inspect the following:
 1. Gas inputs and pressures;
 2. Voltage and polarities of electrical power supplies.
- B. Frymaster gas fryers are manufactured to use the type of gas and pressure specified on the rating plate. When changing gas, **adaptation must be performed by qualified personnel.** Failure to use qualified personnel will void the Frymaster warranty.

Nominal "Qn" Heat Input for the Y/KSCF/C/HC18G High Efficiency Cool Zone Gas fryer is 25 kW.

3.6 Gas Conversion: Procedures

⚠ DANGER

This appliance was configured at the factory for a specific type of gas. Converting from one gas type to another requires the installation of specific gas-conversion components.

Switching to a different type of gas without installing the proper conversion components may result in fire or explosion. **NEVER ATTACH THIS APPLIANCE TO A GAS SUPPLY FOR WHICH IT IS NOT CONFIGURED!**

Conversion of this appliance from one type of gas to another should only be performed by qualified, licensed, and authorized installation or service personnel, as defined in Section 1.6 of this manual.

See below for gas valve illustration when performing the following conversions.

Conversion from one gas family to another (e.g. changing from natural gas to propane) requires special components and parts. Contact a Factory Authorized Service Agent for requirements and part numbers.

Conversions can only be executed by qualified, factory-authorized personnel.

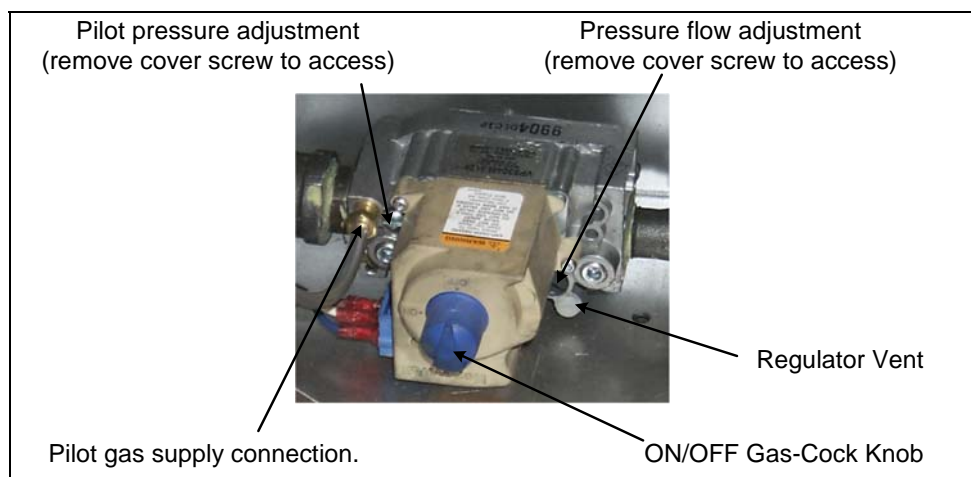

Non-CE Gas Valve

3.7 Electrical Connections

 **DANGER**

This fryer is equipped with a three-prong (grounding) plug for protection against electrical shock and must be plugged directly into a properly grounded, three-prong receptacle. **DO NOT CUT, REMOVE, OR OTHERWISE BYPASS THE GROUNDING PRONG ON THIS PLUG!**

 **DANGER**

This appliance requires electrical power for operation. Place the gas valve in the **OFF** position in case of a prolonged power outage. Do not attempt to operate this appliance during a power outage.

Refer to the rating plate and wiring diagram located inside the front door. The fryer is equipped with a 120VAC/60Hz system for USA/Canada/Mexico operations. All electrically operated appliances must be electrically grounded in accordance with local codes or, in the absence of local codes, with the National Electrical Code (ANSI/NFPA 70) or the Canadian Electrical Code (CSA C22.2). Do not cut or remove the ground prong from the power cord plug. Do not attempt to use this appliance in a power outage.

3.8 Safety Switches

A. Fryer with KFC-1 Computer

NOTE: For **FAST-equipped** fryers, see the Fast manual for operation instructions.

This fryer/filter system is equipped with a drain valve safety switch and a frypot float-switch on each of the two-battered fryers. Drain-valve safety switches de-energize the control circuit during the filter process, thus providing an additional safety feature. Always leave the computer ON when filtering.

The KFC-1 computer monitors cooking operations. The computer logs the number of cook sequences and locks out the cook cycle after a preset number is reached. The drain-valve must be opened, the oil must be filtered, and the drain-valve closed before the KFC-1 computer will allow a cook cycle. After filtering, always allow the frypot to refill with oil and heat to setpoint before engaging a cook cycle.

See the accompanying *KFC-1 SMS Cooking Computer User Manual* for more detailed information.

Y/KSCF/C/HC18G HIGH EFFICIENCY COOL ZONE SERIES GAS FRYERS
CHAPTER 3: INSTALLATION INSTRUCTIONS

3.8 Safety Switches (cont.)

B. Other Fryer/Filter Switches

1. **Drain Valve Microswitch:** The computer will display DRAIN OPEN when the drain valve is opened. The computer will lockout, preventing any cooking operation until EXIT/COOL FILTER is pressed.



A microswitch is located on the red handle at the drain valve.

2. **Float-Switch:** Located in the frypot. Designed as a safety switch, it deactivates the gas valve, preventing burner ignition until the oil level extends above the heating tubes.
3. **High-limit Reset:** Located in the right fryer cabinet under the control panel. This switch is used to reset the high-limit if the cooking medium has reached high temperature safety limits. The high-limit sensor bulb is mounted inside the frypot between the two left-most burner tubes.

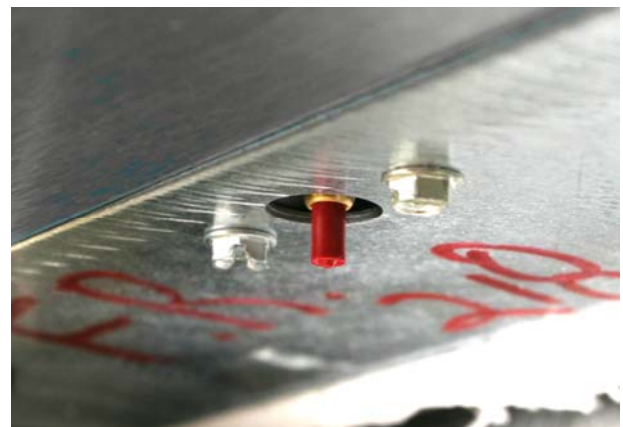
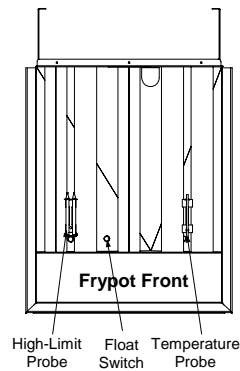

The hi-limit reset is accessible in the fryer cabinet under the controller.

3.8 Safety Switches (cont.)

C. Filtering: Drain Valve and Oil Return Handles

1. **Drain Valve Handle: RED HANDLE.**
Push the red handle (located in the fryer cabinet) to the right to open the drain valve when filtering. After all oil has drained from the frypot and/or polishing is complete, push the red handle left to close the drain valve.
2. **Oil Return Handles: YELLOW LABEL.**
The oil-return handles to the left and right in the fryer cabinet return oil at the rear of the pot, which flushes oil across the bottom of the vat, washing debris toward the drain. The oil-return handles in the center of the cabinet return oil through the over-the-top system. Ensure the faucet is positioned over the emptied vat before running oil through the over-the-top return system.
See Chapter 5 for more information on filtering.
See Chapter 7 for troubleshooting information.

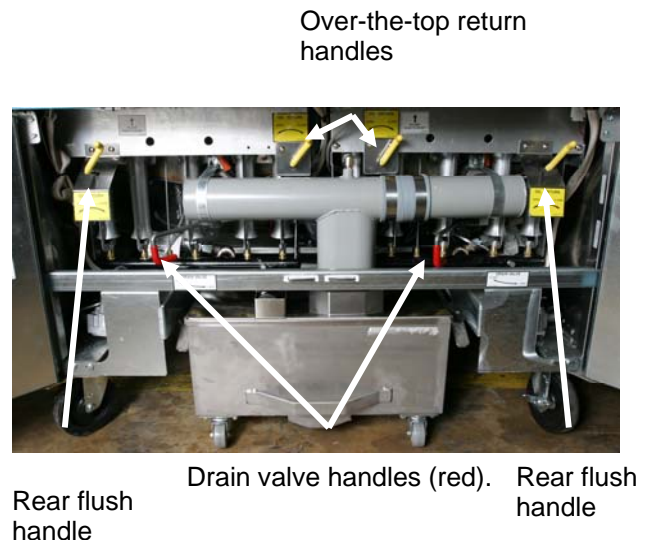

⚠ DANGER

Always ensure that the over-the-top oil return faucet is located over the frypot or an appropriate container before activating the over-the-top oil return system. If not, the hot oil will spill and may cause burns.

⚠ DANGER

Allow oil to cool to 100°F (38°C) before draining into a metal container, stockpot, or disposal unit.

⚠ DANGER

When draining oil into a disposal unit or portable filter unit, do not fill above the maximum fill line located on the container.

3.9 Initial Cleaning Before Startup

New units are wiped clean with solvents at the factory to remove any visible signs of dirt, oil, and grease remaining from the manufacturing process. Then, they are coated lightly with oil. Wash thoroughly with hot, soapy water to remove any film residue and dust or debris before food preparation. Then, rinse and wipe dry. In addition, wash any accessories shipped with the unit. Close the drain valve completely and remove the crumb screen. Ensure the screws securing the temperature probe to the bracket between heating tubes are tight.

 **WARNING**

All droplets of water must be removed from the frypot before filling with shortening. Failure to do so will cause hot oil to splatter and injure the operator.

3.10 Final Preparation

1. The Y/KSCF/C/HC18G frypot shortening capacity is approximately 40.5 kg (90 lb).
2. Ensure fryer power switches are OFF.
3. **Cooking Oil:** Fill the fryer to the bottom OIL LEVEL line scribed into the back of the frypot. Replace the basket support screen.

 **WARNING**

Never operate fryer without enough oil, shortening, or water in the frypot to cover the heating tubes.

 **WARNING**

NEVER set a complete block of solid shortening on top of heating tubes. To do so will damage the frypot and increase the potential for flash-point shortening temperatures and subsequent fire.

4. **Solid Shortening:** Either pre-melt solid shortening on another appliance first or cut it into small pieces and pack it tightly into the cool zone at the bottom of the frypot. Take care not to disturb the temperature probe or high-limit thermostat. If solid shortening is packed into the frypot, ensure the float switch is in the "up" position.
5. **FAST Controller:** See the Fast manual for operation of a Fast-equipped fryer.

3.10 Final Preparation (cont.)

NOTE: If the float switch is blocked in "down position" with solid shortening, the fryer will not heat. Always ensure that the float switch is in the "up" position when packing solid shortening into frypot.

6. **KFC-1 Cooking Computer:** Turn computer ON (this also turns the *fryer* ON if equipped with electronic ignition). The computer will cycle the burners ON and OFF (melt cycle). This is indicated by heat icons located on either side of the KFC-1 product buttons, which will cycle ON and OFF with the fryer. The computer will display LOW until the shortening reaches 180°F (82°C).

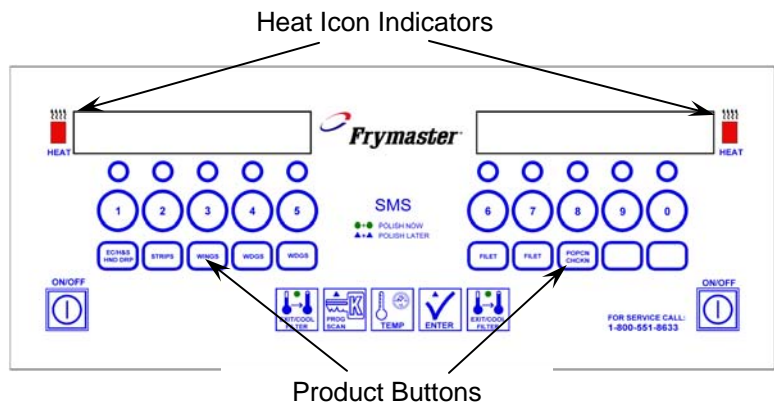

At 180° F (82°C), the fryer goes into continuous heat mode. The computer will display actual oil temperature until setpoint is reached. At setpoint temperature, the computer will display **DROP**.

NOTE: For **FAST-equipped** fryers, see the Fast manual for operation instructions.

7. After shortening reaches the setpoint temperature, let the burners cycle at least four times, then insert a thermometer or pyrometer near the temperature sensing probe within 1 inch of the temperature probe and approximately 3-in. (7.5-mm) deep into the shortening. When the burners cycle on after the fourth time, the thermometer should read within $\pm 5^{\circ}\text{F}$ ($\pm 2^{\circ}\text{C}$) of the computer temperature setting.
8. When the frypot is filled and the shortening melted, replace the basket-support screen over the heating tubes.

WARNING

Do not bang fry baskets or other utensils on the fryer's joiner strip. The strip is present to seal the joint between the frypots. Banging fry baskets on the strip to dislodge shortening will distort the strip, adversely affecting its fit. It is designed for a tight fit and should only be removed for cleaning.

For pilot lighting instructions, see Chapter 4.
For filtration instructions, see Chapter 5.

Y/KSCF/C/HC18G HIGH EFFICIENCY COOL ZONE SERIES GAS FRYERS

CHAPTER 4: DAILY OPERATION

4.1 General Use

1. At opening, always check that the power switch and the controller are OFF.
2. For consistent quality product, convenience, and long-term savings, use a high-quality liquid shortening.
3. If using solid shortening, never melt a block of shortening by placing an entire block in the fryer vessel. Cut it into small pieces and pack it around fryer components.
4. Although 350°F (177°C) is the recommended temperature for most cooking operations, set the fryer at the lowest possible temperature which produces a high quality end product while ensuring maximum life for your oil.

4.2 Start-Up Procedures

1. If the fryer is empty, pour enough oil into the frypot to fill it to the bottom OIL LEVEL line scribed on the rear wall. If solid shortening is used, melt the shortening following procedures in Section 3.10, *Final Preparation*.
2. A. **Pilot lighting procedures – Standing Pilot:**
 - a. Turn off the manual shut-off valve on the incoming service line.
 - b. Turn the operating thermostat to OFF.
 - c. Depress the Pilot Off button (red) on the combination safety gas valve to turn it off.
 - d. Wait at least five minutes for any accumulated gas to disperse.
 - e. Open the manual shut-off valve on the incoming service line.
 - f. Press and hold the white pilot light button and repeatedly press the piezo ignitor button until the pilot lights. Release the white button after approximately 45-60 seconds.
 - g. If the pilot does not stay lit, depress the white pilot light button and re-light the pilot (repeat Step f above). Hold the button in longer before releasing. Trapped air may necessitate re-lighting the pilot several times until gas flow is constant.
 - h. When the pilot stays lit, release the white pilot light button.
 - i. Turn the thermostat to any ON setting and ensure the main burner ignites from the pilot.

Y/KSCF/C/HC18G HIGH EFFICIENCY COOL ZONE SERIES GAS FRYERS
CHAPTER 4: DAILY OPERATION

4.2 Start-Up Procedures (cont.)

B. Pilot lighting procedure – Electronic Ignition

- a. Turn gas "ON."
- b. Turn electric power "ON" with the appropriate rocker switch or controller/controller.
- c. The ignition module will energize the pilot gas supply and the ignitor. The ignitor spark will ignite the pilot gas. The presence of the pilot flame is then proven by a flame sensor, which sends a signal to the main gas supply, opening the valve. The operating thermostat or controller/controller controls the fryer after ignition.

⚠ WARNING

In the event of prolonged power failure, the ignition module will shut down and lock out the system. Turn the unit power "OFF" and then back "ON" after power has been re-established.

- d. If the pilot flame fails, the ignition module will shut down and lock out the system. To restart, turn the electric power "OFF," wait approximately 5 minutes for the system to recycle itself, and then turn the power "ON" again. Repeat Steps a-c.
3. KFC-1 Cooking Controller: Turn the controller ON and select cooking program as described in the KFC-1 SMS Cooking Controller User Guide.

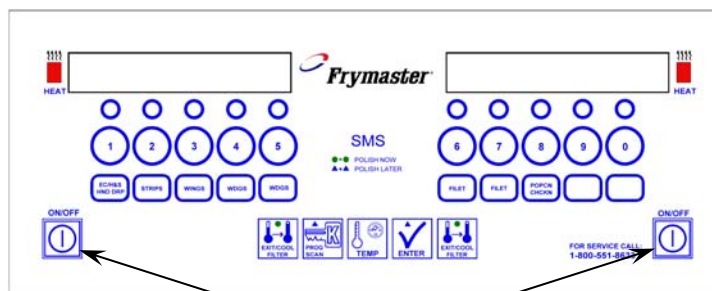

ON/OFF Buttons

NOTE: For **FAST-equipped** fryers, see the Fast manual for operation instructions.

4.3 Filtering

 **DANGER**

When filtering, never leave the filter unattended. The filtered oil is at or near 350°F (177°C). Ensure all hoses are connected properly and drain handles are in their proper position prior to operating any switches or valves.

 **DANGER**

The crumb tray in fryers equipped with a filter system must be emptied into a fireproof container at the end of frying operations each day. Some food particles can spontaneously combust if left soaking in certain shortening material.

 **WARNING**

Filter one frypot at a time. The filter pan is designed to safely hold the oil from one fryer only.

1. The KFC-1 Controller must remain ON during filter operations for proper filter function.

NOTE: For **FAST-equipped** fryers, see the Fast manual for operation instructions.

2. Filter the shortening **at least once daily** or more frequently if cooking is heavy. This assures the longest life possible for the shortening, a better taste to the food being prepared, and minimizes flavors being transferred from batch to batch.
3. If using solid shortening, clear return lines before turning off the filter motor by allowing the pump to run for approximately 15-30 seconds once air bubbles appear in the frypot from the oil return line. Failure to do so increases the likelihood that solid shortening will solidify and clog the lines.

NOTE: If using over-the-top oil return, allow the faucet to sputter for 15-30 seconds.

See Chapter 5 for detailed filtration procedures.

4.4 Closing

1. When closing at night, filter shortening in all fryers and drain the filter lines. Cover the open tanks of oil. Turn the controller OFF.
2. When shutting down for periods longer than overnight, drain shortening and clean the frypot thoroughly. After cleaning, discard the shortening or filter it and return it to the frypot. Cover the frypot with the appropriate frypot cover. Turn both the power switch and controller OFF.

Y/KSCF/C/HC18G HIGH EFFICIENCY COOL ZONE SERIES GAS FRYERS

CHAPTER 5: FILTRATION

5.1 General

WARNING

The on-site supervisor is responsible for ensuring that operators are made aware of the inherent hazards of operating a hot oil filtering system, particularly the aspects of oil filtration, draining, and cleaning procedures.

To conduct filter operations with the KFC-1 Cooking Computer installed on the fryer, **ALWAYS** leave the computer **ON** when filtering. The computer must sense the drain valves opening and closing in order to allow fryer operation.

For consistent product quality, convenience, and long-term savings use a high-quality liquid shortening or vegetable oil.

If using solid shortening, always ensure the return lines are clear before turning off the filter pump. Hang any flexible lines up to drain. Solid shortening will solidify as it cools and clog the lines.

5.2 Filter Preparation

Assemble filtering tools. These are supplied with the filter starter kit (at right):

- **L-shaped Teflon Brush:** Used to clean frypot sides, heating tubes, and to dislodge sediment during filtration or oil change.
- **Clean-out Rod:** Used to dislodge heavy debris in the drain tube (when needed).
- **Filter Powder.**
- **Filter Paper.**



The following tools are not required, but are recommended to make the filtering task easier.

- **Measuring Cup:** Used to measure filter powder.
- **Stainless Steel Crumb Scoop:** Used to remove large debris from oil prior to filtering.

NOTE: Always wear oil-resistant, insulated gloves and/or protective gear when working with hot oil.

5.2 Filter Preparation (cont.)

1. Put on protective gear/gloves. Pull the filter pan out of the filter cabinet. Remove cover.

2. Remove crumb screen. If crumbs are present in the crumb screen, empty the screen into a fireproof container. Thoroughly wash the screen in hot, soapy water, rinse, then dry.

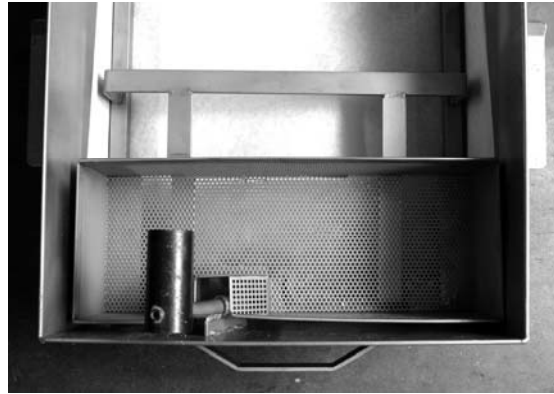

3. Remove the hold-down ring.



4. Remove and discard old filter paper sheet from the filter pan.



Y/KSCF/C/HC18G HIGH EFFICIENCY COOL ZONE SERIES GAS FRYERS
CHAPTER 5: FILTRATION

5. Remove the filter screen from the bottom of the pan.



6. Thoroughly clean the pan and all pan components as described for the crumb screen (Step 2).

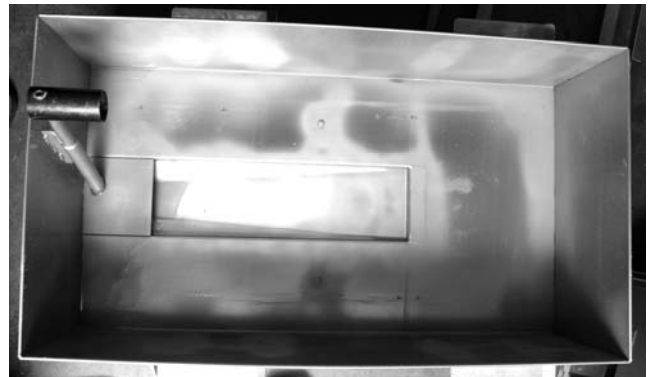

7. Inspect the pickup tube and ensure vent hole is open and free of shortening/debris.

8. Replace filter screen and drape one sheet of filter paper across the filter pan. **The filter screen must be installed prior to filter paper placement or the filter won't operate correctly.**

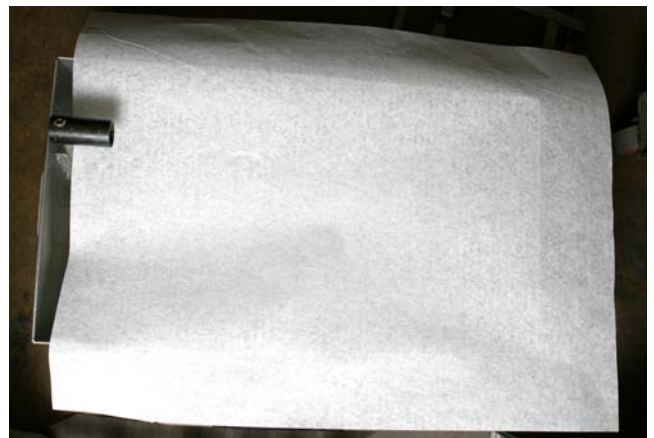

Y/KSCF/C/HC18G HIGH EFFICIENCY COOL ZONE SERIES GAS FRYERS

CHAPTER 5: FILTRATION

9. Reinstall the hold-down ring. Ensure filter paper is properly aligned under the hold-down ring. Press the filter paper into place with the hold-down ring, ensuring the paper laps against the walls of the filter pan.

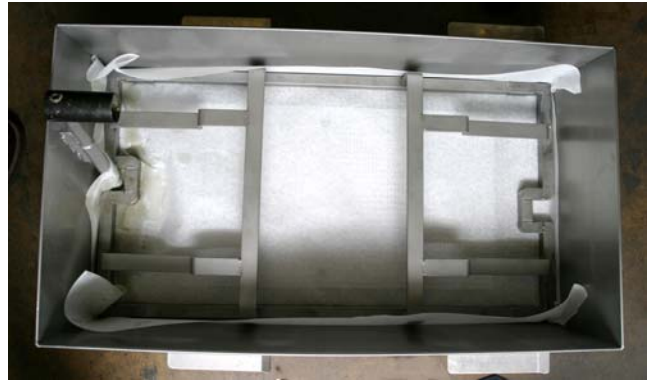

10. Sprinkle 1 cup (8 ounces/227 grams) of filter powder evenly over the paper. Use a measuring cup or scoop to evenly distribute filter powder over the filter sheet.



11. Replace the crumb screen. Ensure crumb screen is cleaned throughout the workday.
12. Return pan cover to the filter pan.
13. Return filter pan to fryer cabinet, ensuring that the two drainpipe extensions are directly over the opening in the filter pan cover.

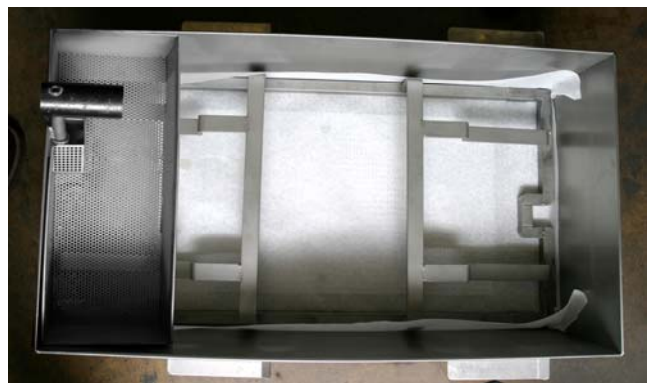

5.3 Filter Operations

NOTE: When *left* and *right* are indicated, refer to the operator's left and right.

DANGER

Draining and filtering of cooking oil or shortening must be accomplished with care to avoid a serious burn caused by careless handling. The oil to be filtered is at or near 350°F (177°C). Ensure all hoses are connected properly and drain handles are in their proper position before operating any switches or valves. Wear all appropriate safety equipment when draining and filtering oil.

Y/KSCF/C/HC18G HIGH EFFICIENCY COOL ZONE SERIES GAS FRYERS
CHAPTER 5: FILTRATION

⚠ DANGER

Always ensure that the over-the-top oil return faucet is located over the frypot or an appropriate container before activating the over-the-top oil return system. If not, the hot oil will spill and may cause burns.

⚠ DANGER

Allow oil to cool to 100°F (38°C) before draining into a metal container, stockpot, or disposal unit.

⚠ DANGER

Do not drain more than one frypot at a time into the built-in filtration unit to avoid overflow and spillage of hot oil.

⚠ DANGER

When draining oil into a disposal unit or portable filter unit, do not fill above the maximum fill line located on the container.

1. Remove large debris floating in the oil.

NOTE: Always heat oil to operating temperature before filtering.



Remove large debris from frypot prior to filtering.

5.3 Filter Operations (cont.)

2. Remove the support grid from the frypot using the clean-out rod. Stir the oil with the L-shaped Teflon brush to suspend debris prior to draining.



Removing support grid from frypot prior to draining.

3. Open the fryer drain valve by pushing the red handle (under the frypot to be filtered) to the right until it is completely open. Continue stirring the oil.



Push the red handle right to open drain valve. Oil will start to drain into filter pan.

5.3 Filter Operations (cont.)

4. Use the L-shaped brush to scrub the frypot, and to assist in sediment removal. Brush the frypot sides and between the tubes to remove debris. Use the clean-out rod to clear the drain if necessary.
5. Open the oil return valve by pushing one of the oil return valves to the left. Oil-return handles on the far sides of the cabinet return oil to the frypot through rear ports, which flush debris from the bottom of the frypot. The two return valve handles in the center of the cabinet return oil through the top-mounted faucet. Ensure the faucet is over the drained frypot before attempting to return oil through the faucet.



Use the L-shaped brush to loosen debris as oil drains from the frypot.



The levers on the right and left of the cabinet return oil through rear ports in the frypot. The center-mounted levers return oil through a top-mounted faucet. In all cases, a yellow lever returns oil to the frypot directly above it.

⚠ DANGER

Always ensure that the over-the-top oil return faucet is located over the frypot or an appropriate container before activating the over-the-top oil return system. If not, the hot oil will spill and may cause burns.

5.3 Filter Operations (cont.)

6. Close the red drain valve by pushing the handle to the right until it stops. The fryer will not operate unless the computer senses a closed drain microswitch circuit. Leave the oil return handle (yellow label) open to allow pump to run and frypot to fill with filtered oil.
7. When filtering is complete:

- **Rear Flush Oil Return:** Allow the filter to pump bubbles into the fryer for 15-30 seconds to ensure the oil return lines are clear of oil.

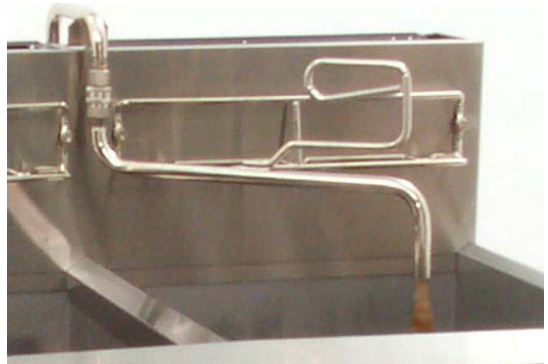

- **Over-the-top Oil Return:** Allow the faucet to sputter for 15-30 seconds to ensure the oil return lines are clear of oil.



8. Turn off the filter by turning the oil return handle to the left, into the CLOSED position. This closes the oil return valve under the filtered frypot and stops the filter pump motor.

⚠ DANGER
The crumb tray in fryers equipped with a filter system **MUST** be emptied into a fireproof container at the end of frying operations each day. Some food particles can spontaneously combust if left soaking in oil.



Empty contents of the crumb screen into a fireproof container immediately after filtering is complete.

Y/KSCF/C/HC18G HIGH EFFICIENCY COOL ZONE SERIES GAS FRYERS
CHAPTER 5: FILTRATION

9. Repeat Steps 1 and 2 in Section 5.2. Remove crumb screen and empty debris into a fireproof container. If possible, wash all filter pan components in hot, soapy water. Rinse and dry thoroughly (Section 5.2, Step 7). If not, the filter pan should be thoroughly cleaned at the close of each day, as previously described.

Filtration system troubleshooting information can be found in Chapter 7.

Y/KSCF/C/HC18G HIGH EFFICIENCY COOL ZONE SERIES GAS FRYERS

CHAPTER 6: PREVENTATIVE MAINTENANCE

Well-maintained equipment operates more efficiently and lasts longer. Keep the fryer clean during the day and thoroughly clean it at the end of each day.

DANGER

Never attempt to clean the fryer during the cooking process or when the frypot is filled with hot oil. If water comes in contact with oil heated to cooking temperature, it will cause spattering of the oil, which can result in severe burns to nearby personnel.

6.1 Daily

Wash all removable parts. Clean all exterior surfaces. Do not use cleansers, steel wool, or any other abrasive material on stainless steel. Filter the oil and replace it if necessary. Filter oil more often under heavy use conditions (e.g., frying heavily breaded products).

WARNING

Use a commercial-grade cleaner formulated to effectively clean and sanitize food-contact surfaces. Read the directions for use and precautionary statements before use. Particular attention must be paid to the concentration of cleaner and the length of time the cleaner remains on the food-contact surfaces.

WARNING

Water MUST NOT be allowed to drain into the filter pan or filter system. Irreversible damage will result if water is allowed into the system, and all applicable warranties will be voided.

6.2 Weekly

Completely drain the frypot into either the filter or a steel container. Do not use a plastic bucket or glass container.

- Clean the frypot with a high grade cleaner or hot water and a strong detergent.
- Close the drain valve and refill with either the cleaning solution or water and detergent.
- Scrub frypot walls and heating tubes. Then drain frypot and rinse in clear water.
- Once cleaning is completed, drain, rinse, and dry thoroughly.
- Refill with shortening as directed in Section 3.10 of this manual.

6.3 Periodic/Annual

This appliance should be inspected and adjusted periodically by qualified service personnel as part of a regular kitchen maintenance program.

Frymaster and Dean recommend that a Factory Authorized Servicer should inspect this appliance at least annually, as follows:

- Inspect the cabinet **inside-and-out, front-and-rear** for excessive oil build-up.
- Verify that debris or accumulations of solidified oil or shortening do not obstruct the flue opening.
- Verify that burners and associated components (e.g., gas valves, pilot assemblies, ignitors) are in good condition and functioning properly. Inspect all gas connections for leaks and verify that all connections are properly tightened.
- Verify that the burner manifold pressure matches the pressure specified on the fryer's rating plate.
- Verify that the temperature and high-limit probes are connected, tightened, and functioning properly, and that mounting hardware and probe guard are present and properly installed.
- Verify that component box components (e.g., computer/controller, transformers, relays, interface boards) are in good condition and free of oil build-up and other debris. Inspect the component box wiring and verify that connections are tight and that wiring is in good condition.
- Verify that all safety features (e.g., drain safety switches, reset switches) are present and functioning properly.
- Verify that the frypot/cookpot is in good condition and free of leaks and that the frypot/cookpot insulation is in serviceable condition. Verify that the frypot tube diffusers are present and in good condition (i.e. no visible deterioration or damage).
- Verify that wiring harnesses and connections are tight and in good condition.

Built-in Filtration:

- Inspect all oil-return and drain lines for leaks and verify that all connections are tight.
- Inspect the filter pan for leaks and cleanliness. If there is a large accumulation of crumbs in the crumb basket, advise the owner/operator that the crumb basket should be emptied into a fireproof container and cleaned daily.
- Verify that all O-rings and seals, including those on quick-disconnect fittings, are present and in good condition. Replace O-rings and seals if worn or damaged.

6.3 Periodic/ Annual (cont.)

Check filtration system integrity as follows:

- With the filter pan empty, place each oil return handle in the OPEN position, one at a time. Using rear flush oil return, verify that the pump activates and that bubbles appear in the oil of the associated frypot. Using over-the-top oil return, verify that the pump activates and that the faucet sputters.
- Close all oil return valves (i.e., place all oil return handles in the CLOSED position). Verify proper functioning of each oil return valve by activating the filter pump using the lever on one of the oil return handle microswitches. No air bubbles should be visible in any frypot and the over-the-top faucet should not sputter.
- Verify that the filter pan is properly prepared for filtering, then drain a frypot of oil heated to 350°F (177°C) into the filter pan and close the frypot drain valve. Place the oil return handle in the OPEN position. Allow all oil to return to the frypot. The frypot should refill in no more than 2 minutes and 30 seconds. Move the oil return handle to the CLOSED position when the oil return lines are clear of oil (indicated by bubbles in the oil in the frypot or sputtering in the over-the-top faucet).

To ensure good fryer health and a safe environment, the fryer should be checked and adjusted periodically by qualified service personnel as part of a regular kitchen maintenance program.

6.4 Stainless Steel

All stainless steel fryer outer parts should be wiped regularly with hot, soapy water during the day and with a liquid cleaner designed for this material at the end of each day.

- Do not use steel wool, abrasive cloths, cleansers, or powders!
- Do not use a metal knife, spatula, or any other metal tool to scrape stainless steel! Scratches are almost impossible to remove.
- If it is necessary to scrape the stainless steel to remove any encrusted materials, soak the area to loosen the material and use a wood or nylon scraper only.

Y/KSCF/C/HC18G HIGH EFFICIENCY COOL ZONE SERIES GAS FRYERS

CHAPTER 7: TROUBLESHOOTING

7.1 Introduction

This section provides an easy reference guide to some of the common problems that may occur during the operation of this equipment. The troubleshooting guides that follow are intended to help correct, or at least accurately diagnose, problems with this equipment. Although this chapter covers the most common problems reported, you may encounter problems, which are not addressed. In such instances, the Frymaster Dean Technical Service staff will make every effort to help you identify and resolve the problem.

When troubleshooting a problem, always use a process of elimination starting with the simplest solution and working through to the most complex. Never overlook the obvious – anyone can forget to plug in a cord or fail to close a valve completely. Most importantly, always try to establish a clear idea of why a problem has occurred. Part of any corrective action involves taking steps to ensure that it doesn't happen again. If a controller malfunctions because of a poor connection, check all other connections, too. If a fuse continues to blow, find out why. Always keep in mind that the failure of a small component may often be indicative of potential failure or incorrect functioning of a more important component or system.

Before calling a service agent or the Frymaster Dean HOTLINE (1-800-551-8633):

- **Verify that electrical cords are plugged in and that circuit breakers are on;**
- **Verify that frypot drain valves are fully closed;**
- **Verify that gas line is properly connected.**

 **DANGER**

Never attempt to move a fryer containing hot cooking oil or to transfer hot cooking oil from one container to another.

 **DANGER**

Use extreme care when testing electrical circuits. Live circuits will be exposed.

 **WARNING**

Inspection, testing, and repair of electrical components should be performed only by qualified service personnel. The equipment should be unplugged when servicing, except when electrical tests are required.

 **DANGER**

NEVER use open flame to melt solidified shortening-blockage in the filtration system. Open flame increases the chance of fire and operator injury.

7.2 Fryer Troubleshooting

For FAST-equipped fryers, consult the FAST controller manual. These steps apply to the KFC-1 SMS controller only.

<p align="center">7.2.1</p>	<p align="center">Controller fails to turn ON when ON/OFF button is pressed.</p>	<ol style="list-style-type: none"> 1. Check wall circuit breakers. Reset, if needed. 2. Check fryer connection to external power source. 3. Disconnect fryer from power supply. 4. A power surge or outage may have temporarily locked out controller. <p>If the fryer still fails to turn ON when the ON/OFF button is pressed, contact an authorized service agent.</p>
<p align="center">7.2.2</p>	<p align="center">Controller is ON, but the gas valves fail to energize.</p>	<ol style="list-style-type: none"> 1. Ensure float-switch is not stuck in "down" position. Contact a FAS for service if float-switch is defective. 2. If the KFC-1 SMS controller displays HELP, reset high-limit thermostat (located in the fryer cabinet under the control panel). Contact a FAS for service if high-limit will not reset.

7.2 Fryer Troubleshooting (cont.)

<p align="center">7.2.3</p>	<p align="center">Actual frypot temperature differs from the controller setpoint temperature.</p>	<ol style="list-style-type: none"> 1. Turn fryer ON. 2. Select a product number and allow the fryer to heat for approximately 30 minutes to stabilize shortening temperature at desired setpoint. 3. Place a thermometer near the temperature sensing probe within 1 inch of the temperature probe and approximately 3-in. (75-mm) deep into the shortening. (see illustration, Page 7-3). 4. Press the KFC-1 SMS controller temperature button to check the frypot temperature. Press the controller temperature button twice to view setpoint temperature for the product number chosen.
<p align="center">7.2.3 (cont.)</p>	<p align="center">Actual frypot temperature differs from controller setpoint temperature.</p>	<ol style="list-style-type: none"> 5. The thermometer temperature should be within $\pm 10^{\circ}\text{F}$ ($\pm 5^{\circ}\text{C}$) of the KFC-1 SMS controller display temperature. <p>Yes: System is maintaining temperature properly.</p>

7.2 Fryer Troubleshooting (cont.)

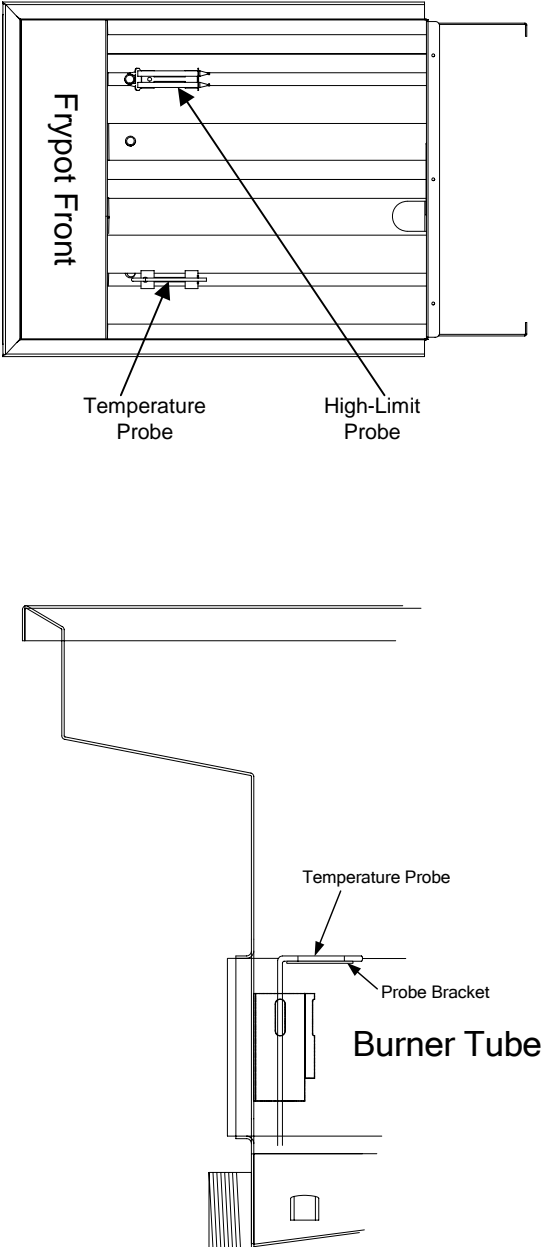
 <p>The top diagram shows a front view of the fryer's frypot. It is labeled 'Frypot Front'. Two probes are shown: a 'Temperature Probe' and a 'High-Limit Probe'. Arrows point from the labels to the respective probes. The bottom diagram is a side view showing the 'Temperature Probe' mounted on a 'Probe Bracket' above a 'Burner Tube'.</p>	<p>No: Ensure the probe tip is $\frac{1}{8}$" from the top of the burner tubes (see illustration). If the probe adjustment is correct, the controller probe circuit may be faulty. If probe adjustment is incorrect, it will require adjustment.</p> <ol style="list-style-type: none">6. Contact your authorized service agent if any of the following occurs during this test:<ol style="list-style-type: none">a. Controller probe circuit is suspected as faulty.b. Temperature probe needs adjustment.c. KFC-1 SMS controller fails to call for heat during the calibration test.
--	--

7.2 Fryer Troubleshooting (cont.)

<p align="center">7.2.4</p>	<p>DRAIN OPEN message remains after closing drain valve.</p>	<ol style="list-style-type: none"> 1. KFC-1 SMS controller was turned OFF while draining frypot. 2. Close drain valve. Turn KFC-1 SMS controller OFF and ON again. Controller display will read ON. 3. Open drain valve. The KFC-1 SMS controller display will read DRAIN OPEN. After 30 seconds the controller display will read FILL. 4. Close drain valve. 5. Fill frypot with shortening. Press EXIT/COOL FILTER when ready to cook. 6. If the KFC-1 SMS controller message DRAIN OPEN remains after Steps 1-4, contact an authorized service agent. Possible malfunctions are: <ol style="list-style-type: none"> a. Drain microswitch may be faulty. b. Drain circuit is suspect. c. KFC-1 SMS controller is suspect.
<p align="center">7.2.5</p>	<p>Pump motor won't start or stops during filtering.</p>	<ol style="list-style-type: none"> 1. The motor thermal overload has tripped. If the thermal overload trips, wait approximately 45 minutes. Press the button on the end of the filter motor. 2. If you have to do this repeatedly, stop resetting the overload and contact an authorized service agent. <p>NOTE: This is usually caused by allowing large particles of food to enter the pump during filtering. Ensure that the filter paper and crumb screen are properly in place.</p>

Fryer Troubleshooting (cont.)

<p>7.2.6</p>	<p>Main burner malfunctions.</p>	<p>A. Main burner will not ignite; no gas is present at main burner.</p> <ol style="list-style-type: none"> 1. Check that float switch is not stuck in the "down" position. 2. Check and reset the high-limit switch. 3. The combination gas valve and/or electronic ignition system may be defective; Contact a FAS for service. <p>B. Main burner flames are small and appear lazy; shortening does not come up to temperature quickly. Contact a FAS for service.</p> <p>C. Fryer will not reach setpoint temperature and/or runs erratically.</p> <ol style="list-style-type: none"> 1. Incorrect location or adjustment of sensor probe. Contact a FAS for service. 2. Defective temperature sensor. Contact a FAS for service. <p>D. Fryer shortening temperature cannot be controlled; fryer runs at high-limit temperature. Possible causes are:</p> <ol style="list-style-type: none"> 1. Defective operating thermostat. Contact a FAS for service. 2. Defective temperature probe. Contact a FAS for service.
---------------------	---	---

7.3 Filtration System Troubleshooting

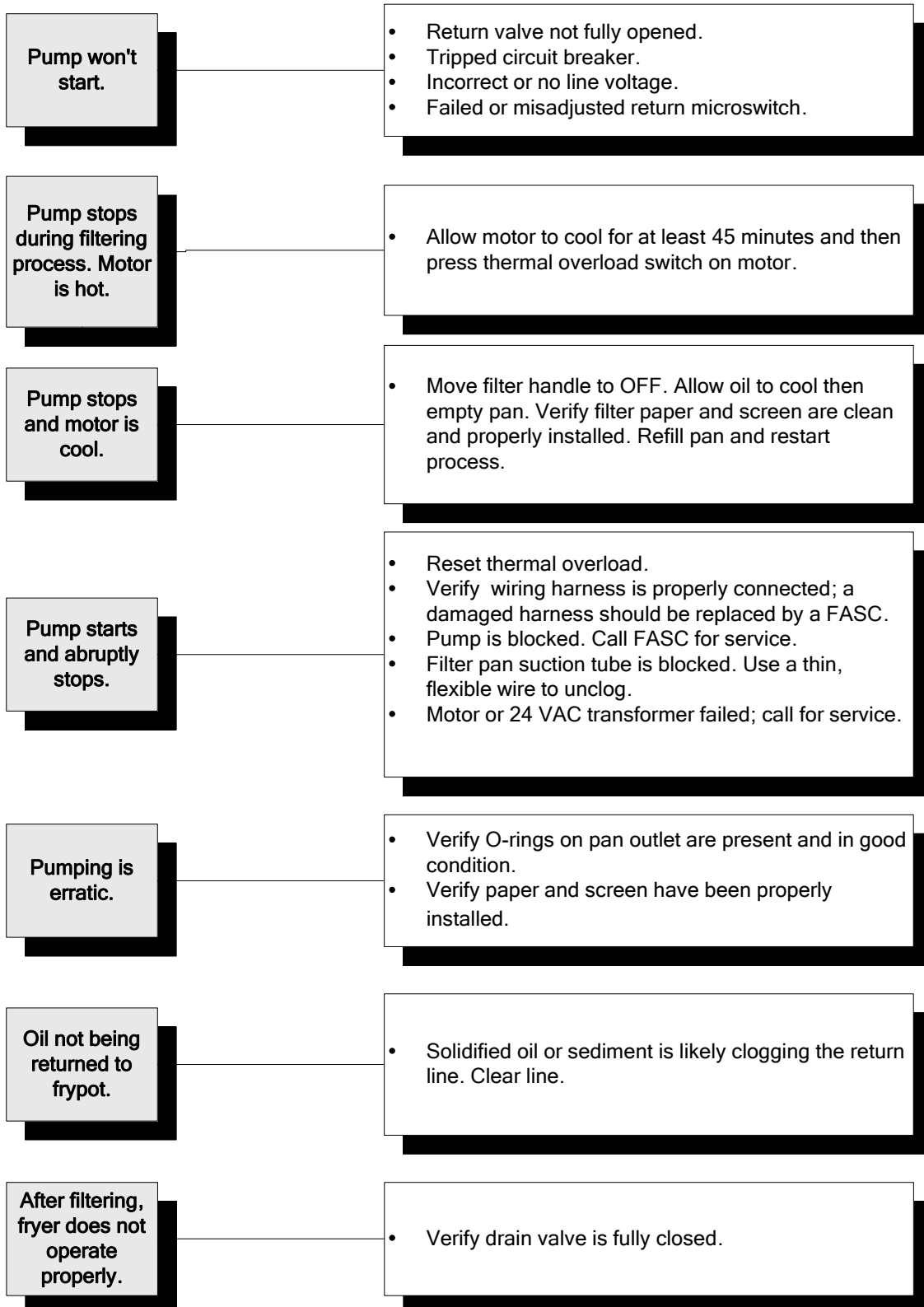

Y/KSCF/C/HC18G HIGH EFFICIENCY COOL ZONE SERIES GAS FRYERS

CHAPTER 7: TROUBLESHOOTING

7.4 Wiring Diagrams

7.4.1 FAST controller Non-CE

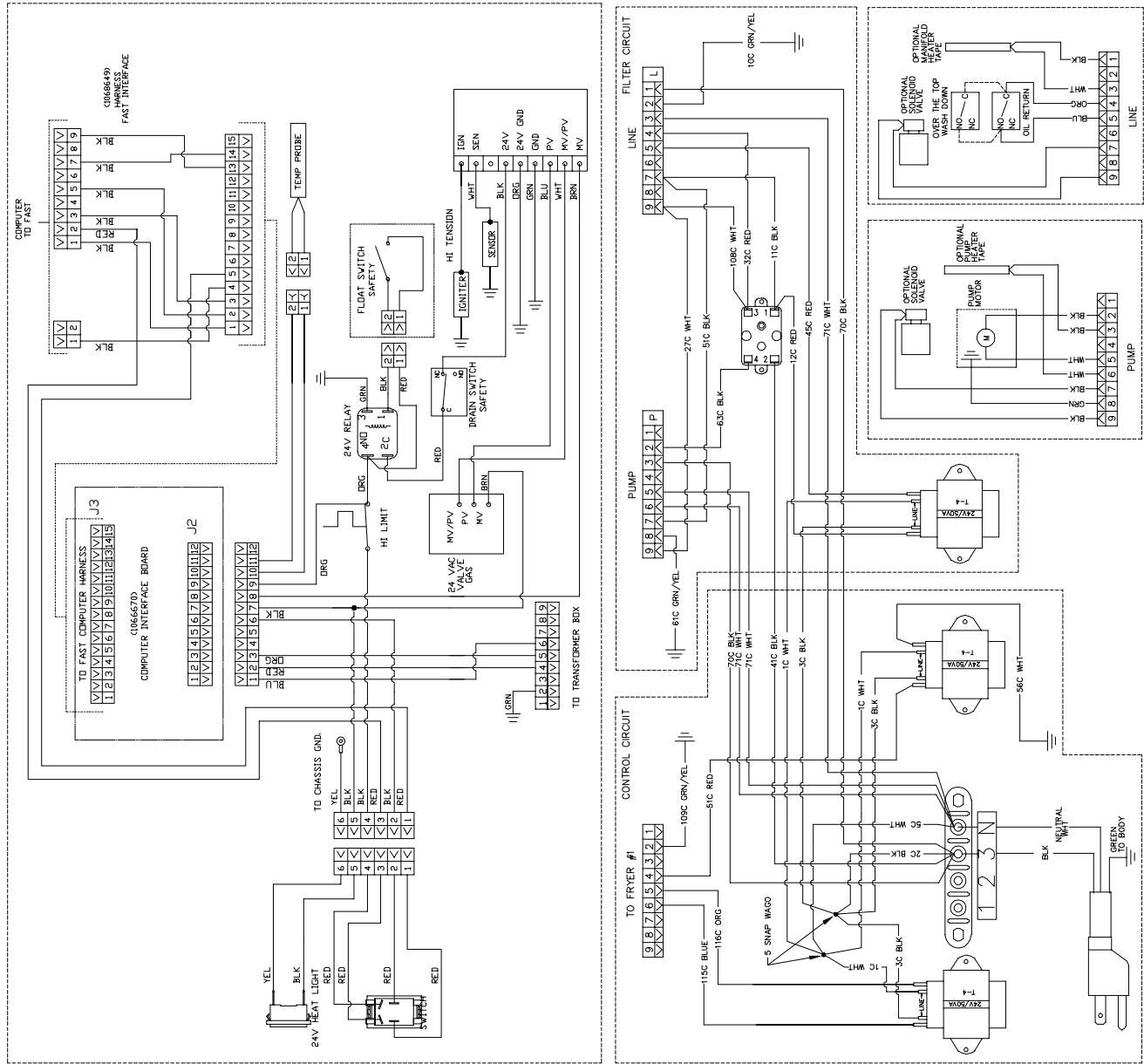

8051705C

Y/KSCF/C/HC18G HIGH EFFICIENCY COOL ZONE SERIES GAS FRYERS
CHAPTER 7: TROUBLESHOOTING

7.4.2 FAST Controller CE

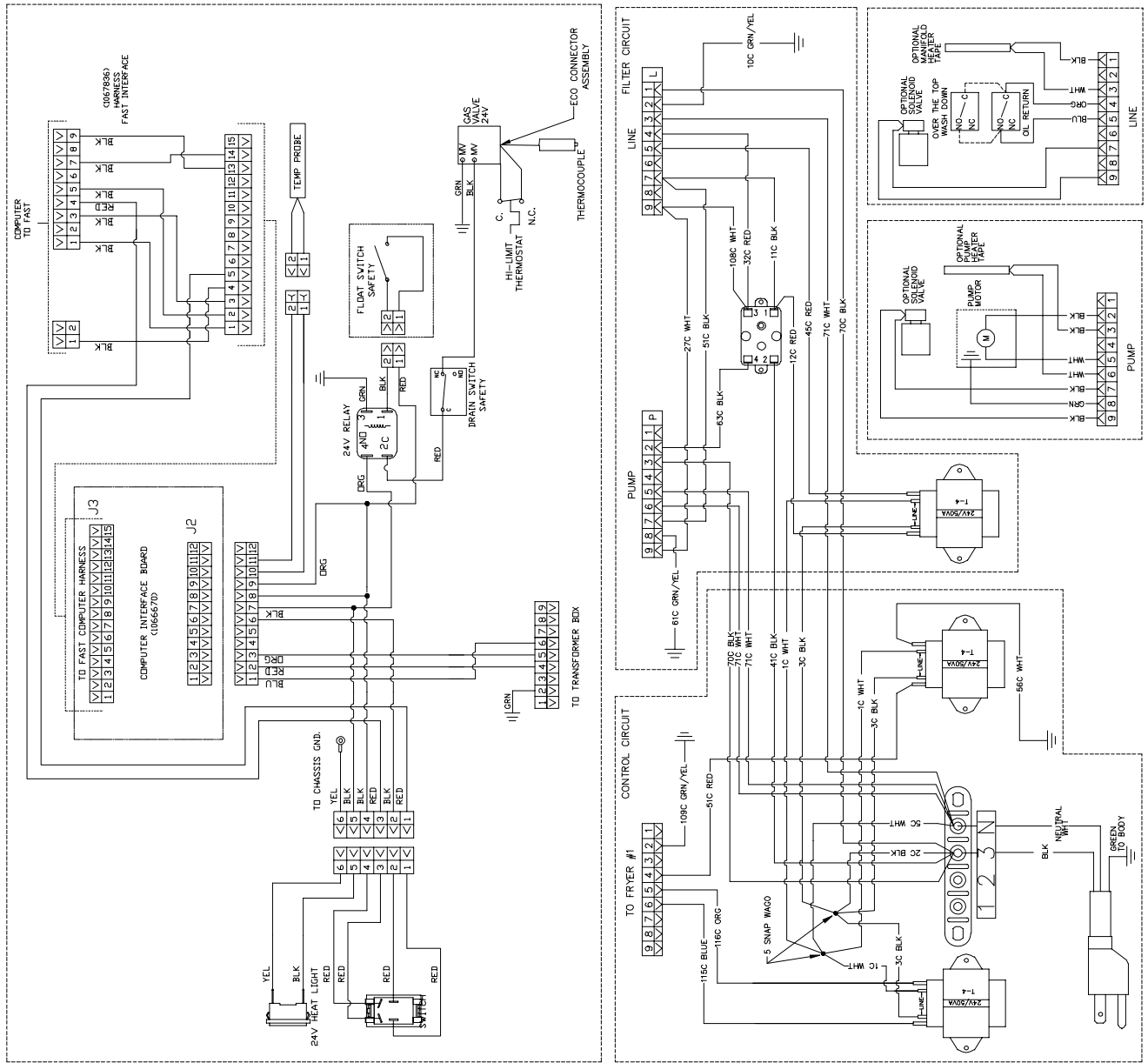

8051760B

7.4.2 FAST Controller India

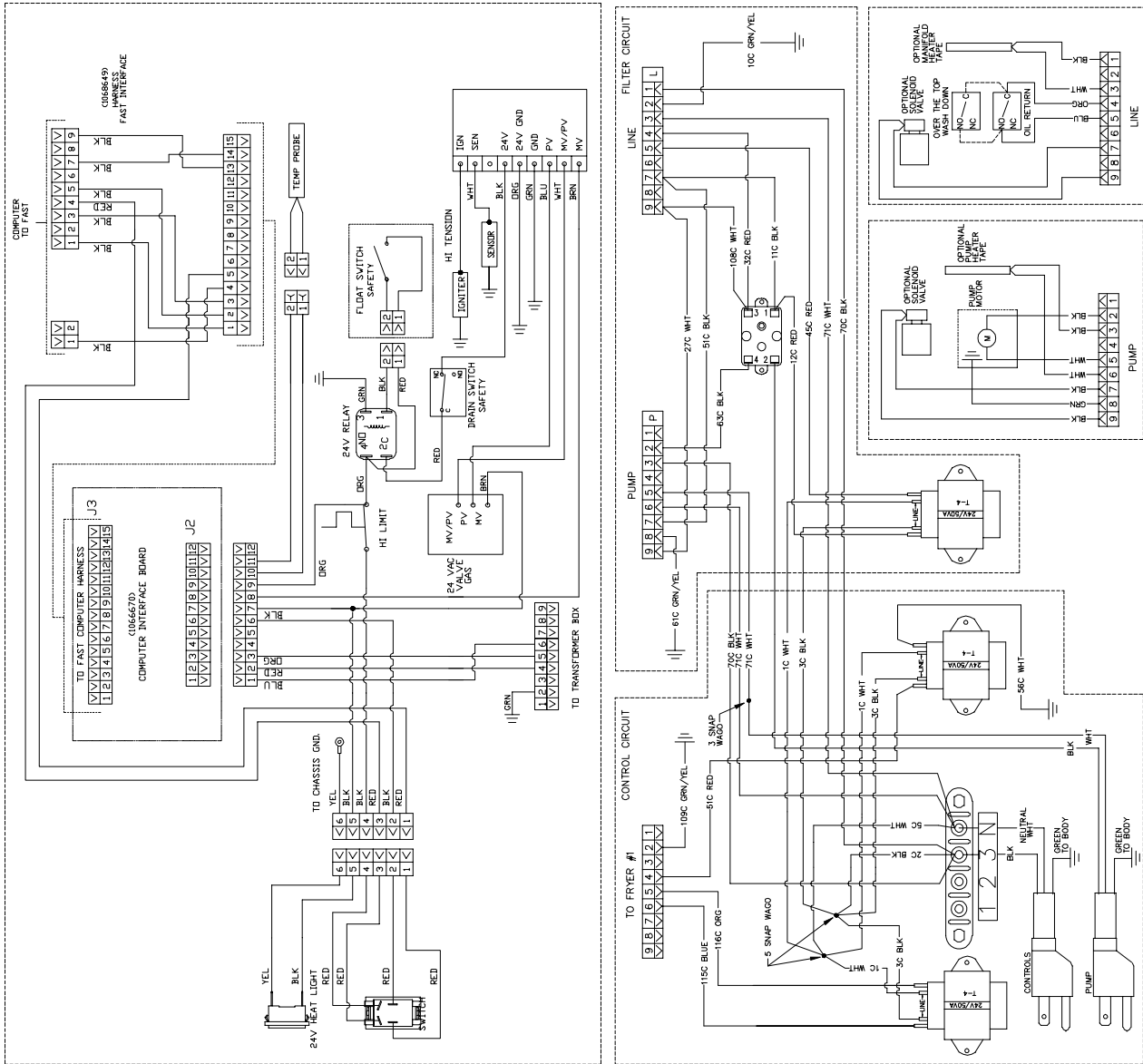

8051847A

Y/KSCF/C/HC18G HIGH EFFICIENCY COOL ZONE SERIES GAS FRYERS

CHAPTER 7: TROUBLESHOOTING

7.4.3 KFC-1 Controller

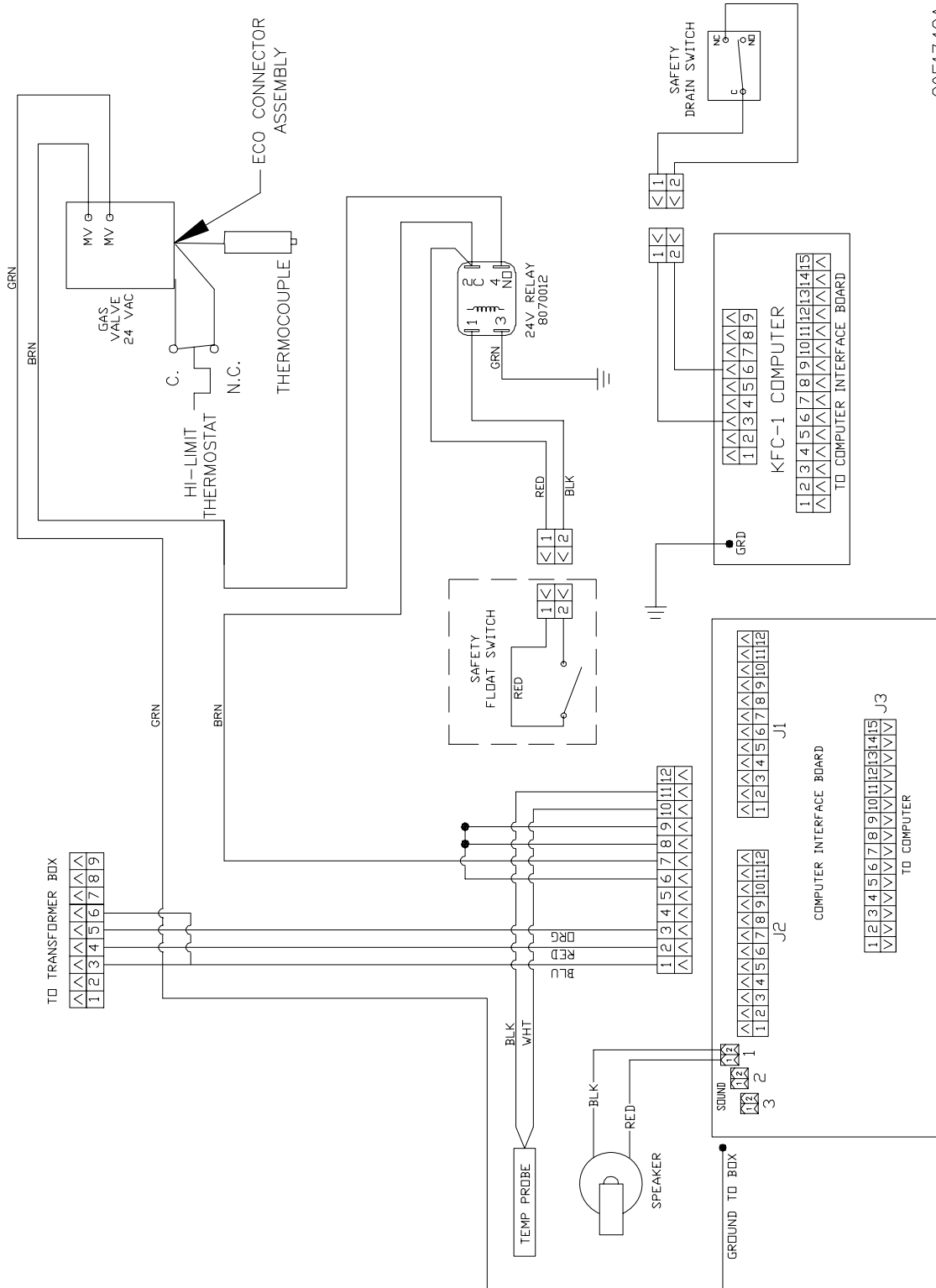

8051749A

THIS PAGE INTENTIONALLY LEFT BLANK



Frymaster, L.L.C., 8700 Line Avenue, Shreveport, Louisiana 71106

TEL 1-318-865-1711

FAX (Parts) 1-318-688-2200

(Tech Support Fax) 1-318-219-7135

PRINTED IN THE UNITED STATES

SERVICE HOTLINE
1-800-551-8633

819-6329
APR 2011

Free Manuals Download Website

<http://myh66.com>

<http://usermanuals.us>

<http://www.somanuals.com>

<http://www.4manuals.cc>

<http://www.manual-lib.com>

<http://www.404manual.com>

<http://www.luxmanual.com>

<http://aubethermostatmanual.com>

Golf course search by state

<http://golfingnear.com>

Email search by domain

<http://emailbydomain.com>

Auto manuals search

<http://auto.somanuals.com>

TV manuals search

<http://tv.somanuals.com>