



Installation & Operation Manual

YFPRE1817E

YFPRE1817E

 **Frymaster**[®]



Frymaster, a member of the Commercial Food Equipment Service Association, recommends using CFESA Certified Technicians.

24-Hour Service Hotline 1-800-551-8633

* 8196383 *^{JULY 09}

www.frymaster.com

E-mail: service@frymaster.com

NOTICE

IF, DURING THE WARRANTY PERIOD, THE CUSTOMER USES A PART FOR THIS ENODIS EQUIPMENT OTHER THAN AN **UNMODIFIED** NEW OR RECYCLED PART PURCHASED DIRECTLY FROM FRYMASTER DEAN, OR ANY OF ITS AUTHORIZED SERVICE CENTERS, AND/OR THE PART BEING USED IS MODIFIED FROM ITS ORIGINAL CONFIGURATION, THIS WARRANTY WILL BE VOID. FURTHER, FRYMASTER DEAN AND ITS AFFILIATES WILL NOT BE LIABLE FOR ANY CLAIMS, DAMAGES OR EXPENSES INCURRED BY THE CUSTOMER WHICH ARISE DIRECTLY OR INDIRECTLY, IN WHOLE OR IN PART, DUE TO THE INSTALLATION OF ANY MODIFIED PART AND/OR PART RECEIVED FROM AN UNAUTHORIZED SERVICE CENTER.

NOTICE

This appliance is intended for professional use only and is to be operated by qualified personnel only. A Frymaster Dean Factory Authorized Service Center (FASC) or other qualified professional should perform installation, maintenance, and repairs. Installation, maintenance, or repairs by unqualified personnel may void the manufacturer's warranty. See Chapter 1 of this manual for definitions of qualified personnel.

NOTICE

This equipment must be installed in accordance with the appropriate national and local codes of the country and/or region in which the appliance is installed. See **NATIONAL CODE REQUIREMENTS** in Chapter 2 of this manual for specifics.

NOTICE TO U.S. CUSTOMERS

This equipment is to be installed in compliance with the basic plumbing code of the Building Officials and Code Administrators International, Inc. (BOCA) and the Food Service Sanitation Manual of the U.S. Food and Drug Administration.

NOTICE

Drawings and photos used in this manual are intended to illustrate operational, cleaning and technical procedures and may not conform to onsite management operational procedures.

NOTICE TO OWNERS OF UNITS EQUIPPED WITH COMPUTERS

U.S.

This device complies with Part 15 of the FCC rules. Operation is subject to the following two conditions: 1) This device may not cause harmful interference, and 2) This device must accept any interference received, including interference that may cause undesired operation. While this device is a verified Class A device, it has been shown to meet the Class B limits.

CANADA

This digital apparatus does not exceed the Class A or B limits for radio noise emissions as set out by the ICES-003 standard of the Canadian Department of Communications.

Cet appareil numérique n'émet pas de bruits radioélectriques dépassant les limites de classe A et B prescrites dans la norme NMB-003 édictée par le Ministre des Communications du Canada.

 DANGER

Improper installation, adjustment, maintenance or service, and unauthorized alterations or modifications can cause property damage, injury, or death. Read the installation, operating, and service instructions thoroughly before installing or servicing this equipment.

⚠ DANGER

The front ledge of this appliance is not a step! Do not stand on the appliance. Serious injury can result from slips or contact with the hot cooking oil/shortening.

⚠ DANGER

Do not store or use gasoline or other flammable liquids or vapors in the vicinity of this or any other appliance.

⚠ DANGER

The crumb tray in fryers equipped with a filter system must be emptied into a fireproof container at the end of frying operations each day. Some food particles can spontaneously combust if left soaking in certain shortening material.

⚠ WARNING

Do not bang fry baskets or other utensils on the fryer's joiner strip. The strip is present to seal the joint between the fry vessels. Banging fry baskets on the strip to dislodge shortening will distort the strip, adversely affecting its fit. It is designed for a tight fit and should only be removed for cleaning.

⚠ DANGER

Adequate means must be provided to limit the movement of this appliance without depending on or transmitting stress to the electrical conduit. A restraint kit is provided with the fryer. If the restraint kit is missing contact your local Frymaster Factory Authorized Service Center (FASC) for part number 826-0900.

⚠ DANGER

Prior to movement, testing, maintenance and any repair on your Frymaster fryer, disconnect all electrical power from the fryer.



**YFPRE18E Electric Fryer
Installation and Operation Manual**

TABLE OF CONTENTS

CHAPTER 1: Introduction	
1.1	General Information 1-1
1.2	Safety Information..... 1-1
1.3	Computer Information..... 1-2
1.4	Installation, Operating and Service Personnel 1-2
1.5	Definitions 1-2
1.6	Shipping Damage Claim Procedure 1-3
1.7	Service Information..... 1-3
CHAPTER 2: Installation Instructions	
2.1	General Installation Requirements 2-1
2.2	Power Requirements..... 2-3
2.3	Positioning the Fryer Station..... 2-3
CHAPTER 3: Operating Instructions	
3.1	Setup and Shutdown Procedures 3-2
3.2	Controller..... 3-3
CHAPTER 4: Filtration Instructions	
4.1	Built-in Filtration..... 4-1
4.2	Preparing the Built-In Filtration System for Use 4-2
4.3	Operational Overview 4-4
4.4	Filter Operation 4-6
CHAPTER 5: Preventive Maintenance	
5.1	Cleaning the Fryer 5-1
5.1.1	Daily Checks and Service..... 5-1
5.1.3	Weekly Checks and Service 5-2
5.2	Annual/Periodic System Inspection 5-2
CHAPTER 6: Operator Troubleshooting	
6.1	Introduction 6-1
6.2	Troubleshooting..... 6-2

YFPRE18E ELECTRIC FRYERS

CHAPTER 1: INTRODUCTION

1.1 General

Read the instructions in this manual thoroughly before attempting to operate this equipment. This manual covers current configurations of YFPRE18E.

1.2 Safety Information

Before attempting to operate your unit, read the instructions in this manual thoroughly.

Throughout this manual, you will find notations enclosed in double-bordered boxes similar to the one below.

 **DANGER**

Hot cooking oil causes severe burns. Never attempt to move a fryer containing hot oil or to transfer hot oil from one container to another.

 **CAUTION** boxes contain information about actions or conditions that *may cause or result in a malfunction of your system*.

 **WARNING** boxes contain information about actions or conditions that *may cause or result in damage to your system*, and which may cause your system to malfunction.

 **DANGER** boxes contain information about actions or conditions that *may cause or result in injury to personnel*, and which may cause damage to your system and/or cause your system to malfunction.

Fryers in this series are equipped with the following automatic safety features:

1. Two high-temperature detection features shut off power to the elements should the temperature controls fail.
2. A safety switch built into the drain valve prevents the elements from heating with the drain valve even partially open.

1.3 Computer Information

This equipment has been tested and found to comply with the limits for a Class A digital device, pursuant to Part 15 of the FCC rules. While this device is a verified Class A device, it has been shown to meet the Class B limits. These limits are designed to provide reasonable protection against harmful interference when the equipment is operated in a commercial environment. This equipment generates, uses and can radiate radio frequency energy and, if not installed and used in accordance with the instruction manual, may cause harmful interference to radio communications. Operation of

the equipment in a residential area is likely to cause harmful interference in which case the user will be required to correct the interference at their own expense.

The user is cautioned that any changes or modifications not expressly approved by the party responsible for compliance could void the user's authority to operate the equipment.

If necessary, the user should consult the dealer or an experienced radio and television technician for additional suggestions.

The user may find the following booklet prepared by the Federal Communications Commission helpful: "How to Identify and Resolve Radio-TV Interference Problems". This booklet is available from the U.S. Government Printing Office, Washington, DC 20402, Stock No. 004-000-00345-4.

1.4 Installation, Operating, and Service Personnel

Operating information for Frymaster equipment has been prepared for use by qualified and/or authorized personnel only, as defined in Section 1.6. **All installation and service on Frymaster equipment must be performed by qualified, certified, licensed, and/or authorized installation or service personnel, as defined in Section 1.6.**

1.5 Definitions

QUALIFIED AND/OR AUTHORIZED OPERATING PERSONNEL

Qualified/authorized operating personnel are those who have carefully read the information in this manual and have familiarized themselves with the equipment functions, or who have had previous experience with the operation of the equipment covered in this manual.

QUALIFIED INSTALLATION PERSONNEL

Qualified installation personnel are individuals, firms, corporations, and/or companies which, either in person or through a representative, are engaged in and are responsible for the installation of electrical appliances. Qualified personnel must be experienced in such work, be familiar with all electrical precautions involved, and have complied with all requirements of applicable national and local codes.

QUALIFIED SERVICE PERSONNEL

Qualified service personnel are those who are familiar with Frymaster equipment and who have been authorized by Frymaster, L.L.C. to perform service on the equipment. All authorized service personnel are required to be equipped with a complete set of service and parts manuals, and to stock a minimum amount of parts for Frymaster equipment. A list of Frymaster Factory Authorized Service Centers (FASC) is included with the fryer when shipped from the factory. ***Failure to use qualified service personnel will void the Frymaster warranty on your equipment.***

1.6 Shipping Damage Claim Procedure

What to do if your equipment arrives damaged:

Please note that this equipment was carefully inspected and packed by skilled personnel before leaving the factory. Frymaster does not assume responsibility for damage or loss incurred in transit. The freight company assumes full responsibility for safe delivery upon acceptance of the equipment.

1. File Claim for Damages Immediately—Regardless of extent of damage.
2. Visible Loss or Damage—Be sure this is noted on the freight bill or express receipt and is signed by the person making the delivery.
3. Concealed Loss or Damage—If damage is unnoticed until equipment is unpacked, notify the freight company or carrier immediately and file a concealed damage claim. This should be done within 15 days of date of delivery. Be sure to retain container for inspection.

1.7 Service Information

For non-routine maintenance or repairs, or for service information, contact your local Frymaster Authorized Service Center (FASC). Service information may also be obtained by calling the Frymaster Technical Services Department (1-800-24FRYER) or by e-mail at service@frymaster.com. The following information will be needed in order to assist you efficiently:

Model Number _____

Serial Number _____

Voltage _____

Nature of the Problem _____

RETAIN AND STORE THIS MANUAL IN A SAFE PLACE FOR FUTURE USE.

YFPRE18E ELECTRIC FRYER

CHAPTER 2: INSTALLATION INSTRUCTIONS

2.1 General

Proper installation is essential for the safe, efficient, trouble-free operation of this appliance.

Qualified, licensed, and/or authorized installation or service personnel, as defined in Section 1.6 of this manual, should perform all installation and service on Frymaster equipment.

Failure to use qualified, licensed, and/or authorized installation or service personnel (as defined in Section 1.6 of this manual) to install or otherwise service this equipment will void the Frymaster warranty and may result in damage to the equipment or injury to personnel.

Where conflicts exist between instructions and information in this manual and local or national codes or regulations, installation and operation shall comply with the codes or regulations in force in the country in which the equipment is installed.

Service may be obtained by contacting your local Factory Authorized Service Center.

NOTICE

All fryers shipped without factory supplied cords and plug assemblies must be hardwired using flexible conduit to the terminal block located on the rear of the fryer. These fryers should be wired to NEC specifications. Hardwired units must include installation of restraint devices.

DANGER

Adequate means must be provided to limit the movement of this appliance without depending on or transmitting stress to the electrical conduit. **A restraint kit is provided with the fryer. If the restraint kit is missing contact your local Frymaster Factory Authorized Service Center (FASC) for part number 826-0900.**

NOTICE

If this equipment is wired directly into the electrical power supply, a means for disconnection from the supply having a contact separation of at least 3-mm in all poles must be incorporated in the fixed wiring.

NOTICE

This equipment must be positioned so that the plug is accessible unless other means for disconnection from the power supply (e.g., a circuit breaker) is provided.

NOTICE

If this appliance is permanently connected to fixed wiring, it must be connected by means of copper wires having a temperature rating of not less than 167°F (75°C).

NOTICE

If the electrical power supply cord is damaged, it must be replaced by a Frymaster Dean Factory Authorized Service Center technician or a similarly qualified person in order to avoid a hazard.

⚠ DANGER

This appliance must be connected to a power supply having the same voltage and phase as specified on the rating plate located on the inside of the appliance door.

⚠ DANGER

All wiring connections for this appliance must be made in accordance with the wiring diagram(s) furnished with the appliance. Refer to the wiring diagram(s) affixed to the inside of the appliance door when installing or servicing this equipment.

⚠ DANGER

Frymaster appliances equipped with legs are for stationary installations. Appliances fitted with legs must be lifted during movement to avoid damage to the appliance and bodily injury. For movable installations, optional equipment casters must be used. Questions? Call 1-800-551-8633.

⚠ DANGER

Do not attach an apron drainboard to a single fryer. The fryer may become unstable, tip over and cause injury. The appliance area must be kept free and clear of combustible material at all times.

In the event of a power failure, the fryer(s) will automatically shut down. If this occurs, turn the power switch OFF. Do not attempt to start the fryer(s) until power is restored.

This appliance must be kept free and clear of combustible material, except that it may be installed on combustible floors.

A clearance of 6 inches (15cm) must be provided at both sides and back adjacent to combustible construction. A minimum of 24 inches (61cm) should be provided at the front of the equipment for servicing and proper operation.

⚠ WARNING

Do not block the area around the base or under the fryers.

⚠ DANGER

Prior to movement, testing, maintenance and any repair on your Frymaster fryer, disconnect all electrical power from the fryer.

2.1.2 Electrical Grounding Requirements

All electrically operated appliances must be grounded in accordance with all applicable national and local codes, and, where applicable, CE codes. A wiring diagram is located on the inside of the fryer door. Refer to the rating plate on the inside of the fryer door for proper voltages.

2.1.3 Australian Requirements

To be installed in accordance with AS 5601 / AG 601, local authority, gas, electricity, and any other relevant statutory regulations.

2.2 Power Requirements

Three (3) Phase Requirements					
MODEL	VOLTAGE	WIRE SERVICE	MINIMUM WIRE SIZE		AMPS (per leg)
			AWG	(mm)	
YFPRE1817E	208	3	6	(4.11)	48
	240	3	6	(4.11)	41
	480	3	6	(4.11)	21
	220/380	4	6	(4.11)	26
	240/415	4	6	(4.11)	24
	230/400	4	6	(4.11)	25

2.3 After Fryers Are Positioned At the Frying Station

DANGER

No structural material on the fryer should be altered or removed to accommodate placement of the fryer under a hood. Questions? Call the Frymaster Dean Service Hotline at 1-800-551-8633.

- Once the fryer has been positioned at the frying station, use a carpenter's level placed across the top of the frypot to verify that the unit is level, both side-to-side and front-to-back.

To level fryers equipped with legs, the bottom of the legs can be screwed out up to one inch for leveling. Legs should also be adjusted so that the fryer(s) are at the proper height in the frying station.

For fryers equipped with casters, there are no built-in leveling devices. The floor where the fryers are installed must be level.

When the fryer is leveled in its final position, install the restraints provided with the unit to limit its movement so that it does not depend on or transmit stress to the electrical conduit or connection. Install the restraints in accordance with the provided instructions (see illustration below). If the restraints are disconnected for service or other reasons, they must be reconnected before the fryer is used.

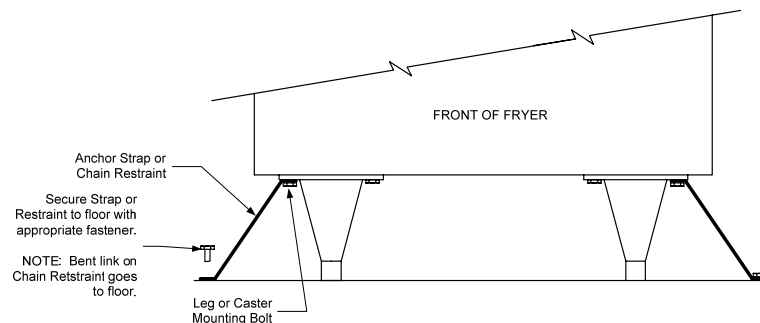

NOTE: If you need to relocate a fryer installed with legs, remove all weight from each leg before moving. If a leg becomes damaged, contact your service agent for immediate repair or replacement.

 **DANGER**

Hot oil can cause severe burns. Avoid contact. Under all circumstances, oil must be removed from the fryer before attempting to move it to avoid oil spills, falls and severe burns. This fryer may tip and cause personal injury if not secured in a stationary position.

2. Close fryer drain-valve(s) and fill frypot with water to the bottom oil level line.
4. Clean, and fill frypot(s) with cooking oil. (See *Equipment Setup and Shutdown Procedures* in Chapter 3.)

YFPRE18E ELECTRIC FRYER

CHAPTER 3: OPERATING INSTRUCTIONS

FINDING YOUR WAY AROUND THE YFPRE18E ELECTRIC FRYER

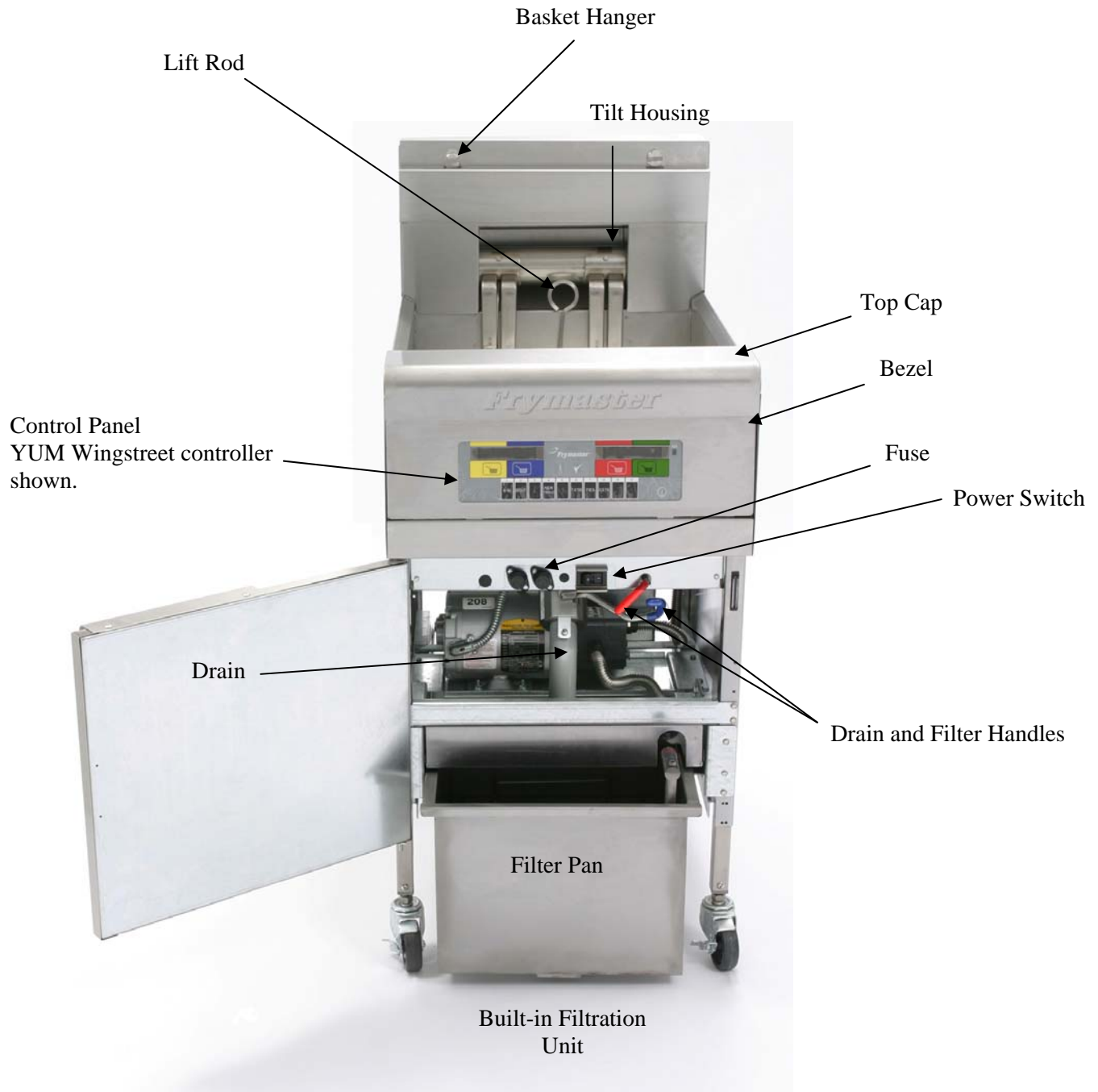

TYPICAL CONFIGURATION (YFPRE1817E SHOWN)

NOTE: The appearance of your fryer may differ slightly from that shown depending upon the configuration and date of manufacture.

3.1 Equipment Setup and Shutdown Procedures

Setup

⚠ DANGER

Never operate the appliance with an empty frypot. The frypot must be filled to the fill line with water, oil or shortening before energizing the elements. Failure to do so will result in irreparable damage to the elements and may cause a fire.

⚠ DANGER

Remove all drops of water from the frypot before filling with oil. Failure to do so will cause spattering of hot liquid when the oil is heated to cooking temperature.

1. Fill the frypot with oil to the bottom OIL LEVEL line located on the rear of the frypot. This will allow for oil expansion as heat is applied. Do not fill cold oil any higher than the bottom line; overflow may occur as heat expands the oil.

NOTE: If solid shortening is used, first raise the elements, then pack the shortening into the bottom of the frypot. Lower the elements, and then pack the shortening around and over the elements. It may be necessary to add shortening to bring the level up to the proper mark after the packed shortening has melted.

⚠ DANGER

Never set a complete block of solid shortening on top of the heating elements.

When using solid shortening, always pre-melt the shortening before adding it to the frypot. If the shortening is not pre-melted, it must be packed down into the bottom of the frypot and between the elements, and the fryer must be started in the melt-cycle mode.

Never cancel the melt-cycle mode when using solid shortening. Doing so will result in damage to the elements and increase the potential for a flash fire.

2. Ensure that the power cord(s) is/are plugged into the appropriate receptacle(s). Verify that the face of the plug is flush with the outlet plate, with no portion of the prongs visible.
3. Ensure that the power is switched on. The fryer is equipped with a master switch located behind the fryer door cabinet on the front panel of the component box, next to the fuse. See page 3-1.
4. Ensure that the computer / controller is switched ON.
5. Ensure that the oil level is at the *top* OIL LEVEL line when the oil *is at its cooking temperature*. It may be necessary to add oil or shortening to bring the level up to the proper mark, *after it has reached cooking temperature*.

Shutdown

1. Turn the fryer off.
2. Filter the cooking oil and clean the fryers (See Chapters 4 and 5).
3. Place the frypot covers on the frypots.

3.2 Controllers

This fryer will be equipped the following YUM Wingstreet controller:

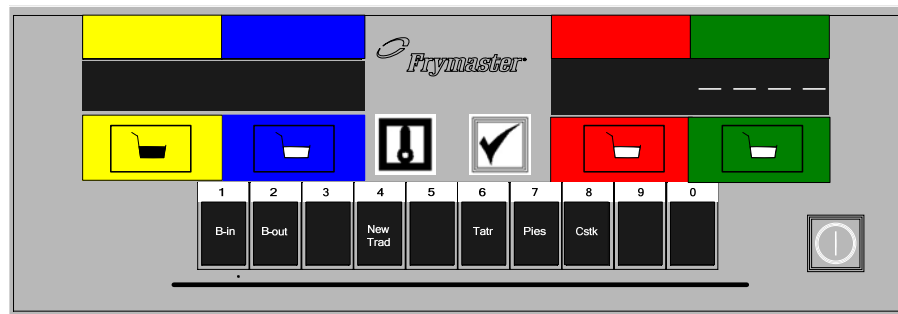

CAUTION

If this is the first time the fryer is being used after installation, refer to the frypot Boil-Out Procedure on Page 5-2.

Refer to the separate *Frymaster Wingstreet Controller User's Manual* furnished with your fryer for the specific controller operating instructions. An overview for the controller is provided below.

Overview

Temperature Key

Press once for current temperature, twice for setpoint.

Lane Keys

Press to initiate cook cycle. SELP appears in left display; press a menu key immediately after pressing the cook key to launch a cook cycle for the chosen product. Also used to move through programming steps. Press second (blue) key to advance, first (yellow) key to go back.

Checkmark Key

Used to enter and confirm programming modes.

Status Indicator

Displays OFF when fryer is off, dashed lines when fryer is at setpoint. Displays HI, LO and HOT when the fryer is out of temperature range.

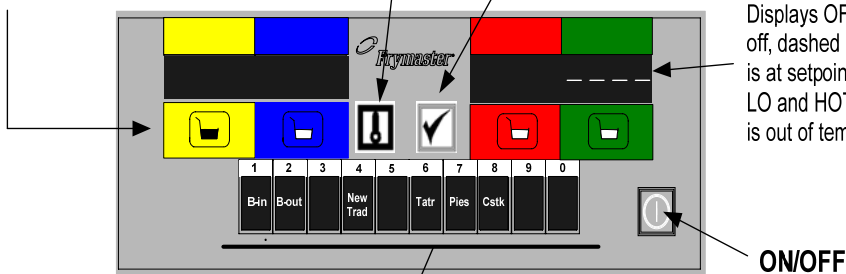

Menu Keys

Press a menu key immediately after pressing a lane key to launch a cook cycle for the desired product. The keys are also used to enter names of products. Each button, when repeatedly pressed, accesses multiple letters or symbols. See example below.

1	2	3	4	5	6	7	8	9	0
ABC	DEF	GHI	JKL	MNO	PQR	STU	VWX	YZ	* blank space + 0

Basic Operation

Turn Fryer ON

- 1: OFF appears in status display when controller is off.
- 2: Press ON/OFF button.
- 3: LO-- appears in status display.
- 4: Dashed lines appear in the status display when the fryer is at setpoint.

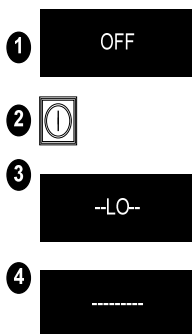

Launch Cook Cycle

- 1: Press a lane key.
- 2: SELP (Select Product) appears in the window above the pressed button. The display changes to SEL PROD in about five seconds.
- 3: Press the menu key for the desired product.
- 4: The display changes to the cooktime for the product and then alternates between remaining cooktime and the product name.
- 5: OUT appears at the end of the cook cycle.
- 6: Press Lane key to eliminate OUT display.

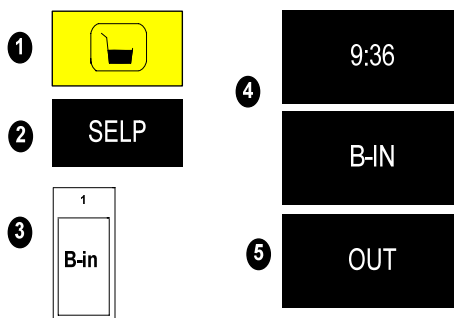

NOTE: To halt a cook cycle, press and hold the lane key under the displayed item for about five seconds.

YFPRE18E ELECTRIC FRYER

CHAPTER 4: BUILT-IN FILTRATION

 **WARNING**

Drawings and photos used in this manual are intended to illustrate operational, cleaning and technical procedures and may not conform to on-site management operational procedures.

 **WARNING**

The on-site supervisor is responsible for ensuring that operators are made aware of the inherent hazards of operating a hot oil filtration system, particularly the aspects of oil filtration, draining and cleaning procedures.

 **WARNING**

When operating the filtration system, never leave the filter unattended. The action of the oil moving through the hose lines could jolt a flexible return hose (where applicable) out of the filter pan, spraying hot oil and causing severe burns.

 **DANGER**

The crumb tray in fryers equipped with a filter system must be emptied into a fireproof container at the end of frying operations each day. Some food particles can spontaneously combust if left soaking in certain shortening material.

IMPORTANT

Cooking oil should be filtered at least daily, or more frequently if cooking is heavy. This assures the longest life possible for the oil and minimizes flavor transfer.

YFPRE18E ELECTRIC FRYER

CHAPTER 4: BUILT-IN FILTRATION

4.1 General

Frymaster YFPRE18E fryers come equipped with a built-in filtration system. Photos used in the procedure illustrations may differ slightly from the filter unit that came with the frying system. The following procedures apply to all YFPRE18E fryers equipped with built-in filter systems.

4.2 Filtration Preparation

On initial installation and before each use, remove all loose parts from the filter, wash the filter pan and all accessories in hot, soapy water and dry thoroughly.

4.2.1 Assembling the Filter

The YFPRE18E filter system uses a filter pad held in place by a hold-down ring to filter impurities and debris from the cooking oil. The filter pan is assembled with the following components (see illustration):

1. Filter pan.
2. Filter support grid.
3. Filter pad
4. Hold-down ring.
5. Crumb screen.

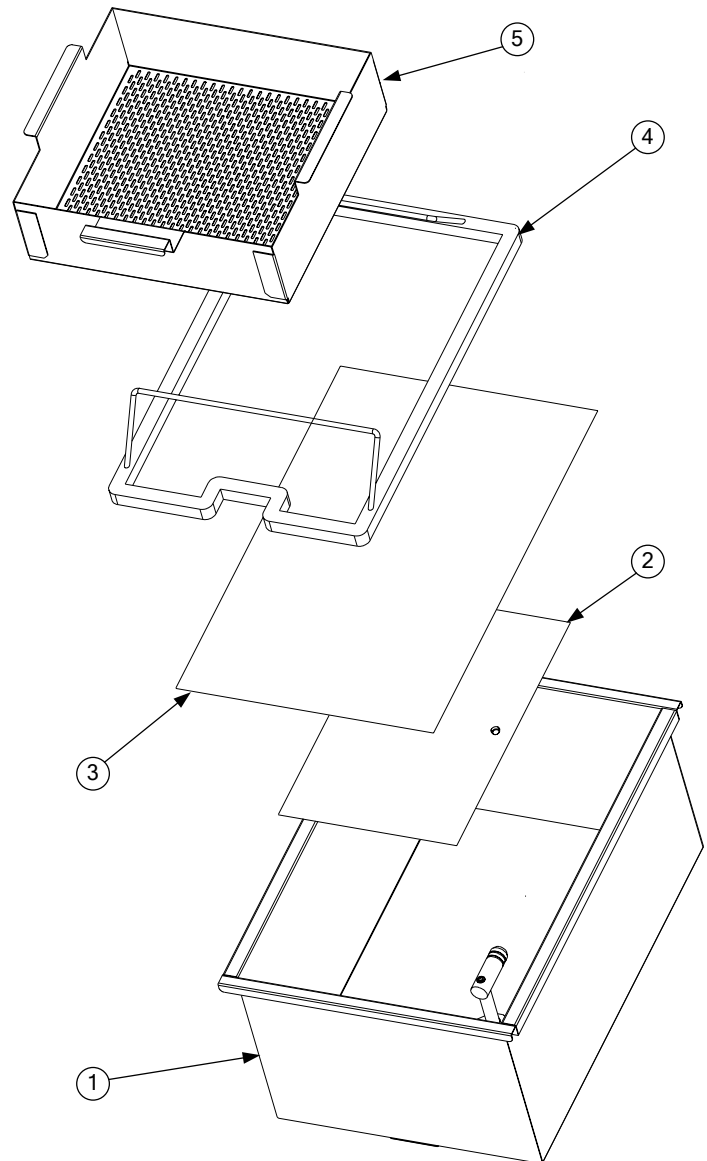

YFPRE18E ELECTRIC FRYER CHAPTER 4: BUILT-IN FILTRATION

4.2.1 Assembling the Filter (cont.)

Assemble the filter as follows:

1. Place the support grid in the bottom of filter pan.
2. Place the filter pad on top of the grid, encircling the pick-up tube with the notch in the filter pad.
3. Position the hold-down ring on top of the filter pad. The notch goes around the pick-up tube.
4. Place the crumb screen in the filter pan. Allow the crumb screen to rest on the top edges of the hold-down ring.
5. Place filter pan cover onto the filter pan assembly. Ensure the front cover is correctly positioned over the slip fitting.

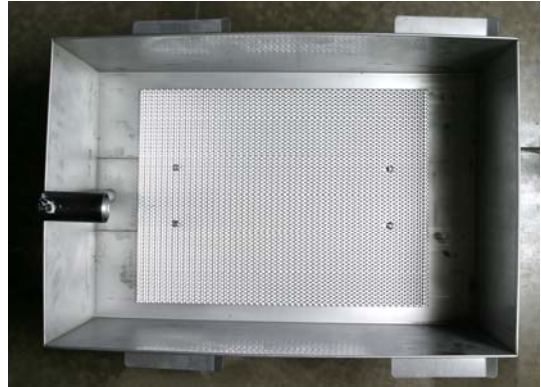

Support grid properly placed in filter pan.



The hold-down ring is shown resting on the filter pad. The notches in both are turned toward the pick-up tube.



The filter pan is shown with the pad, hold-down ring and crumb tray in place.

YFPRE18E ELECTRIC FRYER

CHAPTER 4: BUILT-IN FILTRATION

4.2.2 Installing the Filter

Slide the filter inside the fryer cabinet. Ensure the male-female slip-fitting coupling is fully engaged.



The filter pan is shown partially inserted under the fryer.

4.3 Daily Filtration Operation

DANGER

Use caution and wear proper protective clothing. The oil to be filtered is at or near 350°F (177°C). Ensure all hoses are connected properly and drain handles are in their proper position prior to operating any switches or valves. Failure to do this can result in severe burns.

NOTICE

Drawings and photos used in this manual are intended to illustrate operational, cleaning and technical procedures and may not conform to on-site management operational procedures.

4.3.1 General Overview

The filter pump is turned on only after the oil is brought to operating temperature and drained into the prepared filter pan. The filter motor is then engaged and oil is drawn through the filter pad and pumped back into the frypot. The frypot's drain remains open during the filtering process. Allow the oil to cycle through the filter pad for approximately 30 minutes. At the end of 30 minutes, close the drain valve and allow the pump to fill the frypot to the top OIL LEVEL line. Leave the pump running for 15-30 seconds after bubbles appear in the frypot to ensure all oil is pumped from the drain pan and the lines.

YFPRE18E ELECTRIC FRYER CHAPTER 4: BUILT-IN FILTRATION

4.3.2 Filtering Tools

Assemble tools to be used for filtering. These are supplied with the filter starter kit included with the fryer/filter system:

- Frypot/Filter Brush - used to clean frypot and filter pan sides and bottom and to dislodge sediment during filtration or shortening/oil change.
- Clean-Out Rod (design may vary) - used to dislodge heavy debris in the drain tube (when needed).
- Filter Pad – Frymaster part number: 810-3527.

The following tools are not required, but are recommended to make the filtering task easier.

- Stainless Steel Crumb Scoop – for removing large debris from oil prior to filtering.

Note: Always wear oil-resistant, insulated gloves and/or protective gear when working with hot oil.

4.4 Operating the Filter

 **DANGER**

Draining and filtering of cooking oil must be accomplished with care to avoid the possibility of a serious burn caused by careless handling. The oil to be filtered is at or near 350°F (177°C). Ensure all hoses are connected properly and drain handles are in their proper position before operating any switches or valves. Wear all appropriate safety equipment when draining and filtering cooking oil or shortening.

 **DANGER**

Allow oil to cool to 100°F (38°C) before draining into an appropriate container for disposal.

 **DANGER**

Do not drain more than one frypot at a time into the built-in filtration unit to avoid overflow and spillage of hot oil/shortening.

YFPRE18E ELECTRIC FRYER CHAPTER 4: BUILT-IN FILTRATION

DANGER

When draining oil into a disposal unit or portable filter unit, do not fill above the maximum fill line located on the container.

DANGER

NEVER attempt to drain cooking oil from the fryer with the burner lit! Doing so will result in a flash fire if the oil splashes onto the burner. Also, applying burner heat to an empty frypot will severely damage the frypot and void all applicable warranties

DANGER

NEVER attempt to clear a clogged drain valve from the front of the valve! Hot oil or shortening will rush out creating the potential for severe burns.

DO NOT hammer on the drain valve with the cleanout rod or other objects. Damage to the ball inside will result in leaks and will void all applicable warranties.

4.4.1 Pan Preparation

See Section 4.2.1– *Assembling the Filter*, and Section 4.2.2– *Installing the Filter*

4.4.2 Filter Operation

CAUTION

NEVER operate the filter unit unless cooking oil/shortening is at operating temperature [$\sim 350^{\circ}\text{F}$ ($\sim 177^{\circ}\text{C}$)].

1. Turn the fryer off. Ensure the filter pan assembly is prepared as described in Section 4
2. .2.1– *Assembling the Filter.*
3. Remove fry baskets from frypot. Prior to filtering, skim large debris from the oil. Use extreme caution, as oil is at or near operating temperature, 350°F / 177°C).
4. Remove the support grid from the frypot using the clean-out rod or tongs. Stir the oil with the L-shaped Teflon brush to suspend debris prior to draining.



Prior to filtering, skim any large debris from oil in frypot.

YFPRE18E ELECTRIC FRYER

CHAPTER 4: BUILT-IN FILTRATION

4.4.2 Filter Operation (cont.)



The blue handle drains the frypot. The red handle operates the filter pump.

5. After ensuring the filter pan is correctly positioned under the drain tube and the pan is properly connected, open the drain valve by pulling the blue handle to the left. Drain only one frypot at a time.
6. After all oil has drained from the frypot into the filter pan, twist the red handle to open the oil return line and activate the filter pump.
7. Oil will begin to pump from the filter pan into the frypot. If the frypot has sediment deposits, clean with the cleaning brush included with the fryer.
8. Allow the oil to circulate for approximately 30 minutes (process known as "polishing") to remove suspended particles.
9. After the filter cycle is complete, close the drain valve (push the blue handle to the left until it stops) and allow the fryer to refill.
10. After all oil is pumped back into the frypot, bubbles will form, indicating air in the oil return lines. Allow the oil to bubble for 10-15 seconds to ensure all oil is evacuated from the return lines. Twist the red handle to close the oil return valve and deactivate the filter pump.
11. If the oil level is low, add oil until the level is at the top OIL LEVEL line. Remember, the oil is at operating temperature.
12. Replace the frypot grid, using care not to splash hot oil. Turn the fryer on.

**YFPRE18E ELECTRIC FRYER
CHAPTER 4: BUILT-IN FILTRATION**

4.4.2 Filter Operation (cont.)



Empty the filter pan crumb tray into a fire-proof container at the end of frying operations each day. **DO NOT ALLOW CRUMBS TO ACCUMULATE IN TRAY.**

13. Do not allow crumbs to accumulate in the crumb tray. The crumb tray **MUST** be emptied into a fireproof container at the end of frying operations **EACH** day (see **DANGER** statement below).

⚠ DANGER

The crumb tray in fryers equipped with a filter system must be emptied into a fireproof container at the end of frying operations each day. Some food particles can spontaneously combust if left soaking in certain shortening material.

⚠ WARNING

Do not bang fry baskets or other utensils on the fryer's joiner strip. The strip is present to seal the joint between the frypots. Banging fry baskets on the strip to dislodge shortening will distort the strip, adversely affecting its fit. It is designed for a tight fit and should only be removed for cleaning.

YFPRE18E ELECTRIC FRYER

CHAPTER 5: PREVENTATIVE MAINTENANCE

5.1 Cleaning the Fryer

 **DANGER**

Never attempt to clean the fryer during the frying process or when the frypot is filled with hot oil. If water comes in contact with oil heated to frying temperature, it will cause spattering of the oil, which can result in severe burns to nearby personnel.

 **WARNING**

Use a commercial-grade cleaner formulated to effectively clean and sanitize food-contact surfaces. Read the directions for use and precautionary statements before use. Particular attention must be paid to the concentration of cleaner and the length of time the cleaner remains on the food-contact surfaces.

5.1.1 Clean Inside and Outside of the Fryer Cabinet – Daily

Clean inside the fryer cabinet with a dry, clean cloth. Wipe all accessible metal surfaces and components to remove accumulated oil and dust.

Clean outside the fryer cabinet with a clean, damp cloth soaked with detergent. Wipe with a clean, damp cloth.

5.1.2 Clean the Built-in Filtration System – Daily

 **WARNING**

Never drain water into the filter pan. Water will damage the filter pump.

There are no periodic preventive maintenance checks and services required for your filtration system other than daily cleaning of the filter pan and associated components with a solution of hot water and detergent.

5.1.3 Clean the Frypot and Heating Elements- Weekly

⚠ DANGER

Never operate the appliance with an empty frypot. The frypot must be filled to the fill line with water, oil or shortening before energizing the elements. Failure to do so will result in irreparable damage to the elements and may cause a fire.

5.2 Annual/Periodic System Inspection

This appliance should be inspected and adjusted periodically by qualified service personnel as part of a regular kitchen maintenance program.

Frymaster recommends that this appliance be inspected at least annually by a Factory Authorized Service Technician as follows:

5.2.1 Fryer

- Inspect the cabinet inside and out, front and rear for excessive oil.
- Verify that the heating element wires are in good condition and that leads have no visible fraying or insulation damage and that they are free of oil.
- Verify that heating elements are in good condition with no carbon/caramelized oil build-up. Inspect the elements for signs of extensive dry-firing.
- Verify that the tilt mechanism is working properly when lifting and lowering elements, and that the element wires are not binding and/or chafing.
- Verify the heating-element amp-draw is within the allowed range as indicated on the appliance's rating plate.
- Verify that the temperature and high-limit probes are properly connected, tightened and functioning properly, and that mounting hardware and probe guards are present and properly installed.
- Verify that component box and contactor box components (i.e. computer/controller, relays, interface boards, transformers, contactors, etc.) are in good condition and free from oil and other debris.
- Verify that component box and contactor box wiring connections are tight and that wiring is in good condition.
- Verify that all safety features (i.e. contactor shields, drain safety switches, reset switches, etc.) are present and functioning properly.
- Verify that the frypot is in good condition and free of leaks and that the frypot insulation is in serviceable condition.
- Verify that all wiring harnesses and connections are tight and in good condition.

5.2.2 Built-In Filtration System

 **DANGER**

The crumb tray in fryers equipped with a filter system must be emptied into a fireproof container at the end of frying operations each day. Some food particles can spontaneously combust if left soaking in certain shortening material.

- Inspect all oil-return and drain lines for leaks and verify that all connections are tight.
- Inspect the filter pan for leaks and cleanliness. If there is a large accumulation of crumbs in the crumb basket, advise the owner/operator that the crumb basket should be emptied into a fireproof container and cleaned daily.
- Verify that all O-rings and seals (including those on the quick-disconnect fittings) are present and in good condition. Replace O-rings and seals if worn or damaged.
- Check filtration system integrity as follows:
- Verify that filter pan cover is present and properly installed.
- With the filter pan empty, place each oil return handle, one at a time, in the ON position. Verify that the pump activates and that bubbles appear in the oil of the associated frypot.
- Close all oil return valves (i.e., place all oil return handles in the OFF position). Verify proper functioning of each oil return valve by activating the filter pump using the lever on one of the oil return handle microswitches. No air bubbles should be visible in any frypot.
- Verify that the filter pan is properly prepared for filtering, and then drain a frypot of oil heated to 350°F (177°C) into the filter pan and close the frypot drain valve. Place the oil return handle in the ON position. Allow all oil to return to the frypot, indicated by bubbles in the oil. Return the oil return handle to the OFF position. The frypot should have refilled in no more than 2 minutes and 30 seconds.

YFPRE18E ELECTRIC FRYER

CHAPTER 6: OPERATOR TROUBLESHOOTING

6.1 Introduction

This section provides an easy reference guide to some of the common problems that may occur during the operation of this equipment. The troubleshooting guides that follow are intended to help correct, or at least accurately diagnose, problems with this equipment. Although the chapter covers the most common problems reported, you may encounter problems that are not covered. In such instances, the Frymaster Technical Services staff will make every effort to help you identify and resolve the problem.

When troubleshooting a problem, always use a process of elimination starting with the simplest solution and working through to the most complex. Never overlook the obvious – anyone can forget to plug in a cord or fail to close a valve completely. Most importantly, always try to establish a clear idea of why a problem has occurred. Part of any corrective action involves taking steps to ensure that it doesn't happen again. If a controller malfunctions because of a poor connection, check all other connections, too. If a fuse continues to blow, find out why. Always keep in mind that failure of a small component may often be indicative of potential failure or incorrect functioning of a more important component or system.

Before calling a service agent or the Frymaster HOTLINE (1-800-551-8633):

- **Verify that electrical cords are plugged in and that circuit breakers are on.**
- **Verify that frypot drain valves are fully closed.**

 **DANGER**

Hot oil will cause severe burns. Never attempt to move this appliance when filled with hot oil or to transfer hot oil from one container to another.

 **DANGER**

This equipment should be unplugged when servicing, except when electrical circuit tests are required. Use extreme care when performing such tests.

This appliance may have more than one electrical power supply connection point. Disconnect all power cords before servicing.

Inspection, testing, and repair of electrical components should be performed by an authorized service agent only.

6.2 Troubleshooting

6.2.1 Controller and Heating Problems

Problem	Probable Causes	Corrective Action
Controller won't activate.	A. Power cord is not plugged in or circuit breaker is tripped.	A. Plug power cord in and verify that circuit breaker is not tripped.
	B. Controller or power supply component or interface board has failed.	B. If any of the components in the power supply system (including the transformer and interface board) fail, power will not be supplied to the controller and it will not function. Call FASC.
Fryer does not heat.	A. Drain valve is open.	A. A drain safety switch prevents the heating element from being energized if the drain valve is not fully closed. Verify that the drain valve is fully closed.
	B. One or more other components have failed.	B. If the circuitry in the fryer control system cannot determine the frypot temperature, the system will not allow the element to be energized or will de-energize the element. Call FASC.

Problem	Probable Causes	Corrective Action
Fryer repeatedly cycles on and off when first started.	Fryer is in melt-cycle mode.	This is normal behavior. Refer to the separate <i>YUM! Wingstreet Controller Manual</i> .
Fryer heats until high limit trips with heat indicator ON.	Temperature probe or controller has failed.	Turn fryer off and call FASC.
Fryer heats until high limit trips without heat indicator ON.	Contact or controller has failed.	Call FASC.
Fryer stops heating with heat indicator ON.	The high limit thermostat or contactor has failed.	Call FASC.

6.2.2 Filtration Problems

Problem	Probable Causes	Corrective Action
Filter pump won't start.	A. Power cord is not plugged in or circuit breaker is tripped.	A. Verify that the power cord is fully plugged in. If so, verify that circuit breaker is not tripped.
	B. Pump motor has overheated causing the thermal overload switch to trip.	B. If the motor is too hot to touch for more than a few seconds, the thermal overload switch has probably tripped. Allow the motor to cool at least 45 minutes then press the Pump Reset Switch.
	C. Blockage in filter pump. Test: Close the drain valve and pull the filter pan out from the fryer. Activate the pump. If the pump motor hums for a short time and then stops, the probable cause is blockage of the pump itself.	C. Pump blockages are usually caused by sediment buildup in the pump due to improperly sized or installed filter paper and failure to use the crumb screen. Call FASC.

Problem	Probable Causes	Corrective Action
<p>Filter pump runs but oil does not return to frypot and there is no bubbling oil.</p>	<p>Blockage in filter pan suction tube.</p> <p>Test: Close the drain valve and pull the filter pan out from the fryer. Activate the pump. If bubbling oil occurs, there is a blockage in the filter pan suction tube.</p>	<p>The blockage may be caused by sediment buildup or, if solid shortening is used, solidified shortening in the tube. Use a thin, flexible wire to remove the blockage. If the blockage cannot be removed, call FASC.</p>
<p>Filter pump runs, but oil return is very slow and bubbling oil occurs.</p>	<p>A. Improperly installed filter pan components.</p>	<p>A. If using filter paper or pad configuration, verify that filter screen is in bottom of pan with paper or pad on top of screen.</p> <p>Verify that O-rings are present and in good condition on filter pan connection fitting.</p> <p>If using Magnasol filter assembly, verify that O-ring is present and in good condition on filter screen fitting.</p>
	<p>B. Attempting to filter with oil that is not hot enough.</p>	<p>B. In order to properly filter, the oil or shortening should be at or near 350°F (177°C).</p>

THIS PAGE INTENTIONALLY LEFT BLANK



Frymaster, L.L.C., 8700 Line Avenue, Shreveport, Louisiana 71106

TEL 1-318-865-1711

FAX (Parts) 1-318-688-2200

(Tech Support) 1-318-219-7135

PRINTED IN THE UNITED STATES

SERVICE HOTLINE
1-800-551-8633

819-6383
JULY 2009

Free Manuals Download Website

<http://myh66.com>

<http://usermanuals.us>

<http://www.somanuals.com>

<http://www.4manuals.cc>

<http://www.manual-lib.com>

<http://www.404manual.com>

<http://www.luxmanual.com>

<http://aubethermostatmanual.com>

Golf course search by state

<http://golfingnear.com>

Email search by domain

<http://emailbydomain.com>

Auto manuals search

<http://auto.somanuals.com>

TV manuals search

<http://tv.somanuals.com>