



35mm camera

Zoom Date 125SR
Zoom Date 125S

OWNER'S MANUAL

CONTENTS

FEATURES 2
 PART NAMES 3
 Liquid Crystal Display 6
 Viewfinder 7

1. PRELIMINARY STEPS

ATTACHING THE STRAP 8
 INSERTING THE BATTERY 9
 TURNING ON YOUR CAMERA 11
 CHECKING YOUR BATTERY 12
 SETTING THE DATE
 (YEAR-MONTH-DAY/HOUR-MINUTE) 13
 SELECTING THE DATE MODE 16

2. USING YOUR CAMERA

LOADING THE CAMERA 17
 USING YOUR CAMERA 21
 USING THE AUTO-FOCUS LOCK 26
 UNLOADING THE FILM OR REMOVING
 FILM IN MID-ROLL 28

3. ADVANCED TECHNIQUES

SELECTING THE EXPOSURE MODE 31
 Effective flash range 33

2

USING THE SELF-TIMER 39
 USING THE REMOTE CONTROLLER
 (on the Zoom Date 125SR only) 41
 TROUBLE SHOOTING 44
 COMMON SENSE CAMERA CARE 46
 SPECIFICATIONS 47
 IMPORTANT SAFETY NOTICE 49

FEATURES

- Fujinon 38-125mm Auto Focus Zoom Lens
- Sure-loading System with Automatic Pre-winding
- Automatic Exposure and Automatic Flash Operation
- Date/Time Imprinting
- Red-Eye Reduction Flash

	<p>The “CE” mark certifies that this product satisfies the requirements of the EU (European Union) regarding safety, public health, environment and consumer protection.(“CE” is the abbreviation of Conformité Européenne.) This product is in conformity with Directive 89/336/EEC.</p>
---	--

PART NAMES

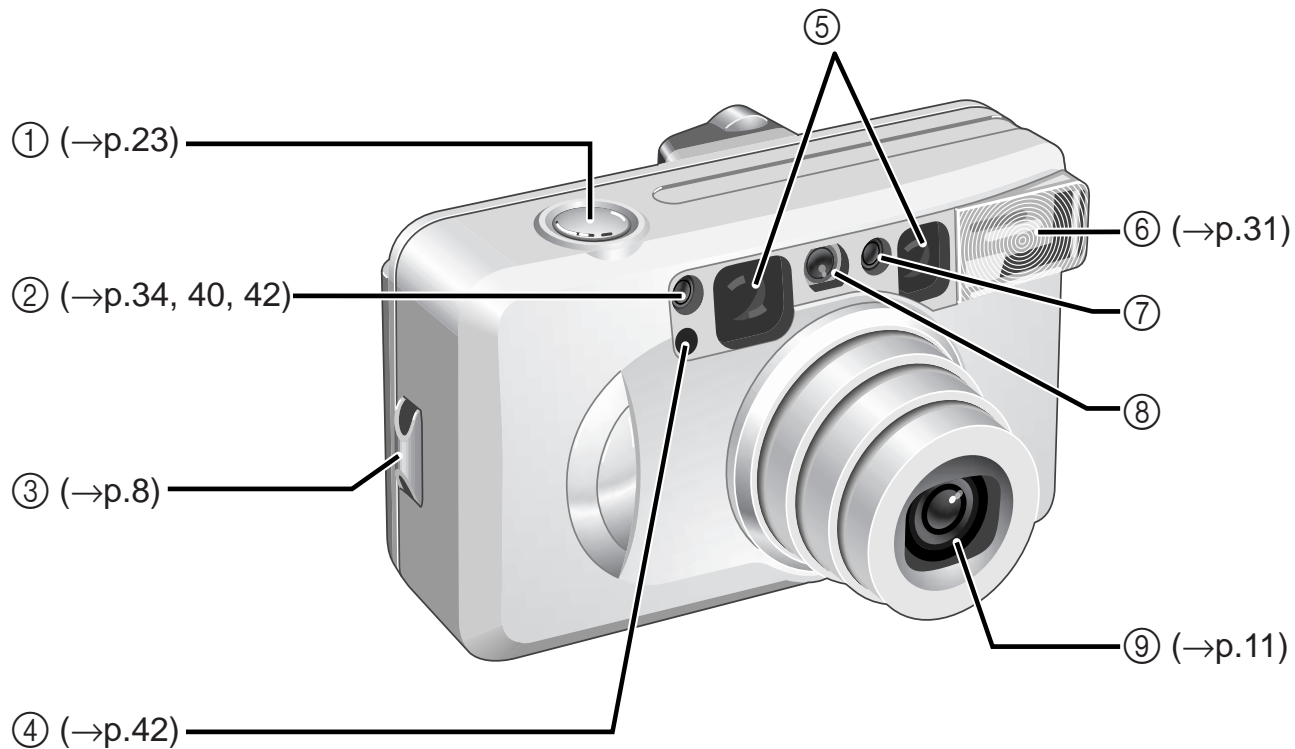

- ① Shutter Release Button
- ② Red-eye Reduction/
Self-Timer/Remote
Controller* Lamp
- ③ Strap Lug
- ④ Remote Controller
Sensor*
- ⑤ AF (Auto-Focus) Window
- ⑥ Flash
- ⑦ AE Light Sensor
- ⑧ Viewfinder Window
- ⑨ Fujinon Lens/ Lens Cover

* : on the Zoom Date 125SR only

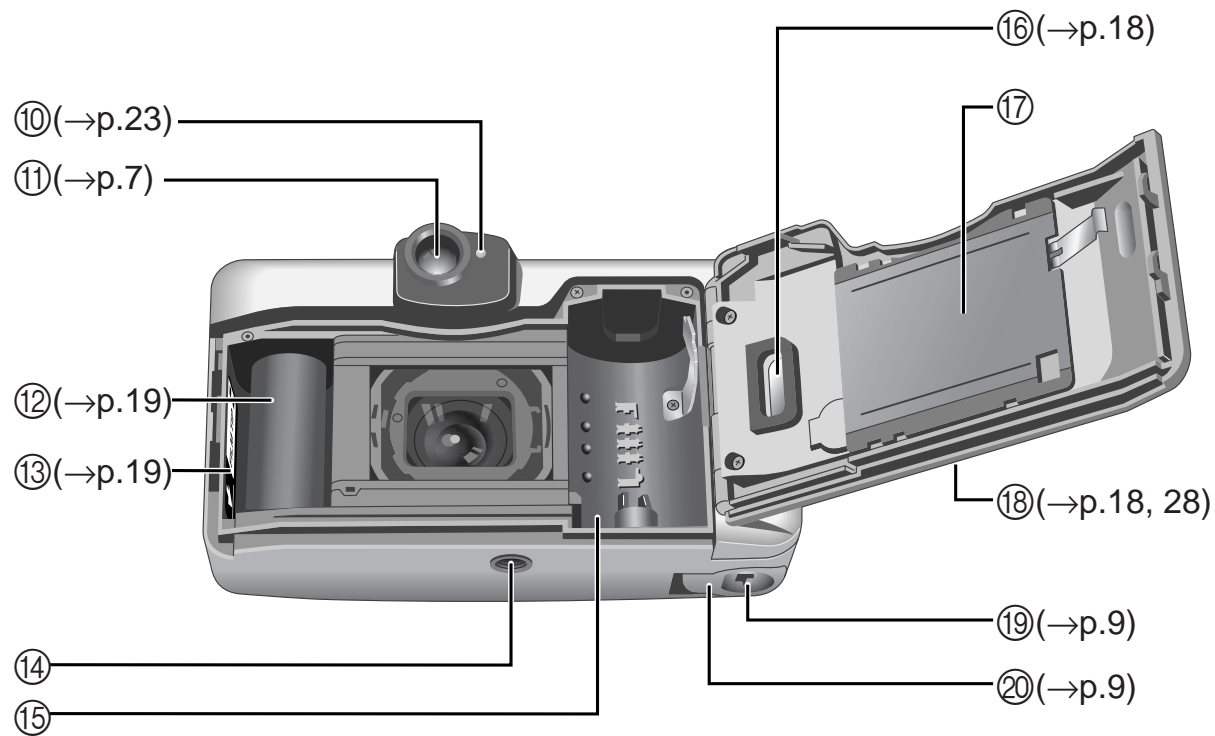

- ⑩ AF Lamp (green)
- ⑪ Viewfinder Eye-piece
- ⑫ Film Take-up Spool
- ⑬ FILM TIP Mark
- ⑭ Tripod Socket
- ⑮ Film Chamber
- ⑯ Film Confirmation Window
- ⑰ Film Pressure Plate
- ⑱ Camera Back
- ⑲ Battery Compartment Cover Release Knob
- ⑳ Battery Compartment Cover

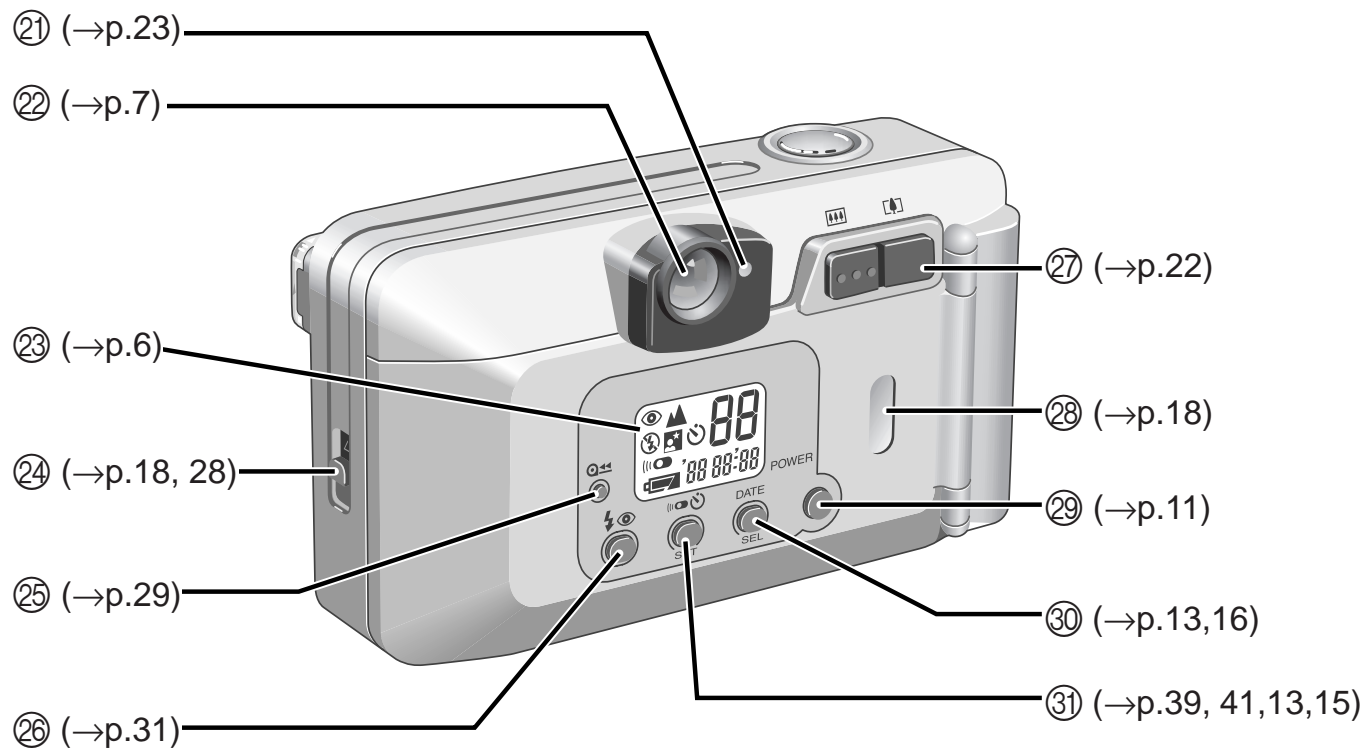

- ②① AF Lamp (green)
- ②② Viewfinder Eye-piece
- ②③ Liquid Crystal Display
- ②④ Camera Back Lock
- ②⑤ Mid-Roll Rewind Button
- ②⑥ Exposure Mode Button
- ②⑦ Zoom Button
- ②⑧ Film Confirmation Window
- ②⑨ Power Button
- ③⑩ DATE/SEL (Date Select) Button
- ③⑪ Self-timer/Remote Control*/SET (Date Set) Button

* : on the Zoom Date 125SR only

Liquid Crystal Display

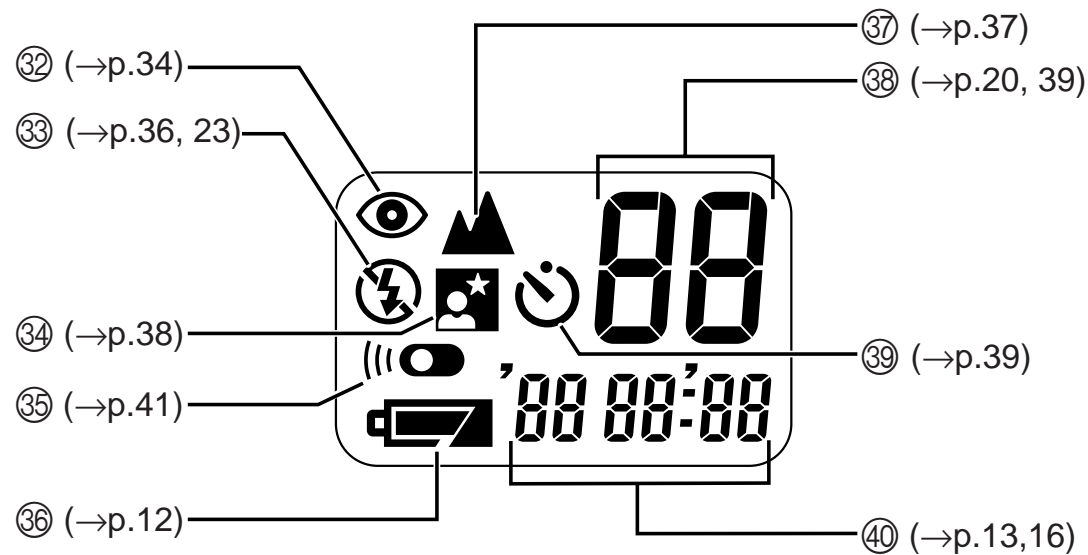

- ③② Red-eye Reduction Flash Mode
- ③③ ⚡ Back Light Compensation Flash Mode/
Ⓜ Flash-off Mode/
⚡ Flash Charging
- ③④ Night Portrait (Slow Sync) Mode
- ③⑤ Remote Control Mode*
- ③⑥ Battery Status
- ③⑦ Landscape Mode
- ③⑧ Exposure Counter/Self-timer Count
- ③⑨ Self-timer Mode
- ④⑩ Date Display

* : on the Zoom Date 125SR only

Viewfinder

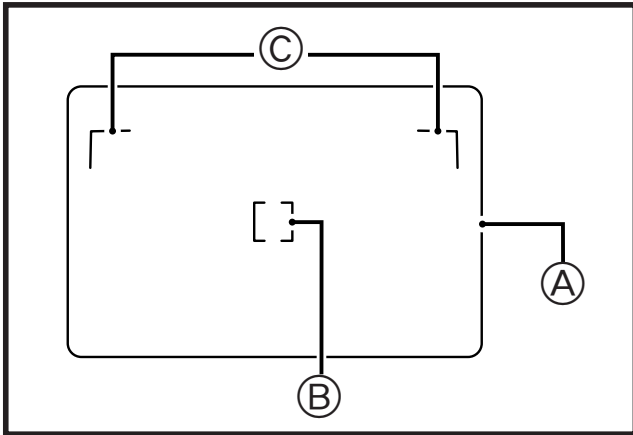

Ⓐ : Framing area

Compose the image within this area.

Ⓑ : AF (Auto-focus) spot

Position this spot over the main subject in your picture.

Ⓒ : Parallax correction guides

When taking pictures at close distances (Closer than 1.5 m/4.9 ft.), use these indicators as a guide when composing your picture. (→p.24)

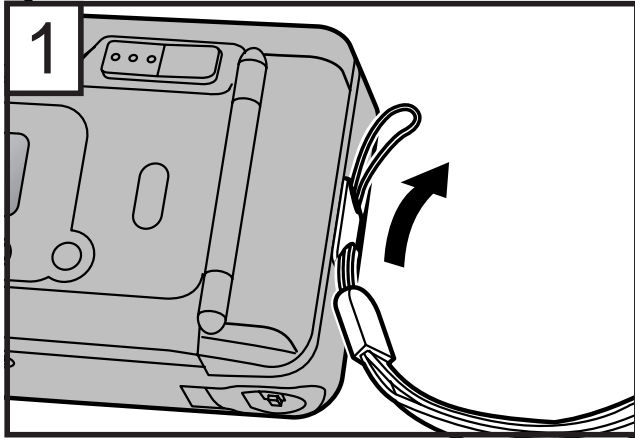

1. PRELIMINARY STEPS

ATTACHING THE STRAP

Slip the thin cord on the carrying strap through the strap lug on the side of the camera leaving a loop. Slide the thick part of the strap through this loop and pull tight. Take up any slack to make sure the strap is securely attached to the camera.

Do not use a strap made for cellular phones or similar electronic products. These straps are usually too light or weak to hold your camera securely. For safety, use only straps designed for cameras.

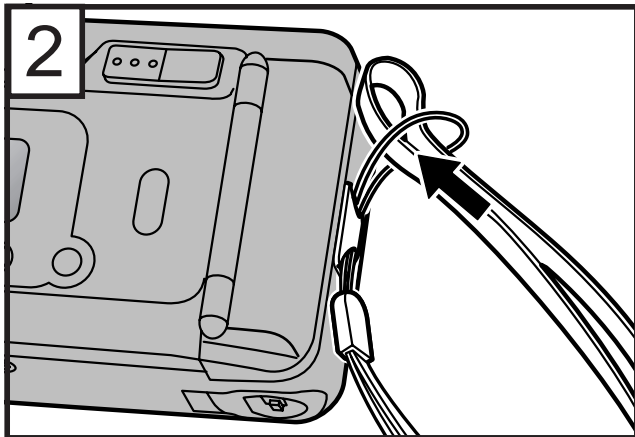

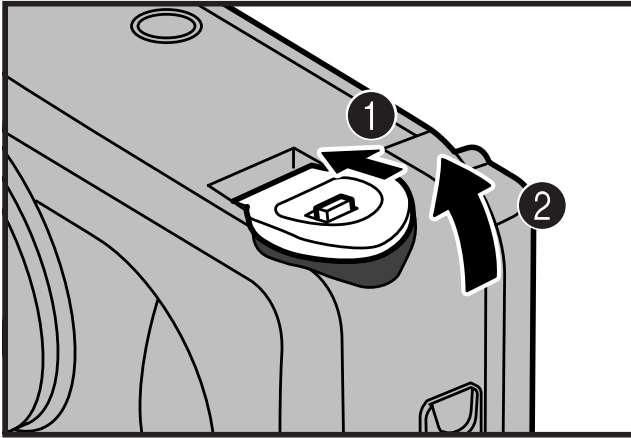

INSERTING THE BATTERY

Your camera requires one 3V lithium battery, type CR123A/DL 123A.

To insert the battery:

- ① Move the battery compartment cover release knob in the direction of the arrow.
- ② Flip open the battery compartment cover.

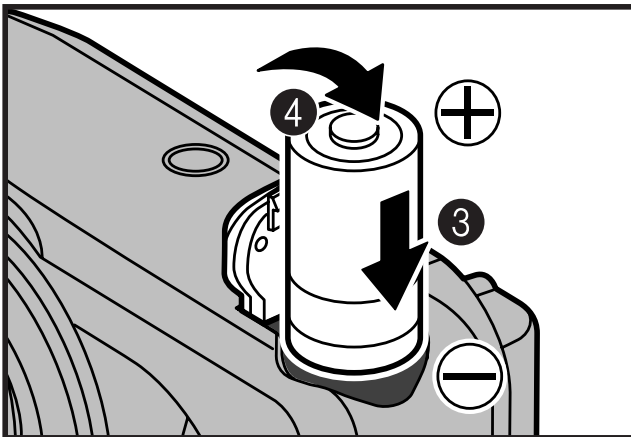

- ③ Insert the battery following the instructions shown in the diagram on the inside of the battery compartment cover. Important: Pay careful attention to the polarity of the battery as indicated by the \oplus and \ominus markings on the battery. The battery must be inserted the correct way or the camera will not function.
- ④ When the battery has been inserted correctly, close the battery compartment cover by pressing it until it snaps into place. If it does not snap into place, do not force it but recheck the position of the battery to make sure it fits properly.

- * Do not apply excessive force when opening or closing the battery compartment cover.
- * One new lithium battery should be sufficient for approx. 350 exposures (based on our test conditions).
- * When traveling, take extra batteries to provide power for extra exposures. This is particularly important if you visit areas where new batteries may be difficult to obtain.
- * Check the battery capacity symbol before using your camera. (→p.12)
- * After changing the battery, reset the date to assure accurate date/time recording. (→p.13)

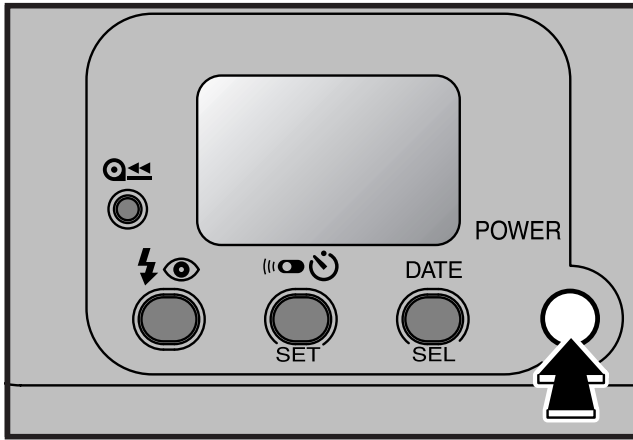

TURNING ON YOUR CAMERA

Before you can use your camera, you must turn the power on. First press the power button which turns on the power. Pressing this button a second time will turn the power off.

- ☞ When you turn your camera on, the lens cover will open and the initial display will appear on the LCD.
- * When you are finished using your camera, turn the power off to conserve your battery. If the power supply is left on for more than 7 minutes without the camera being used, the camera will automatically turn itself off.

Before you turn the camera on, make sure that the lens is not blocked to prevent any interference with the lens movement as it extends into its picture-taking position.

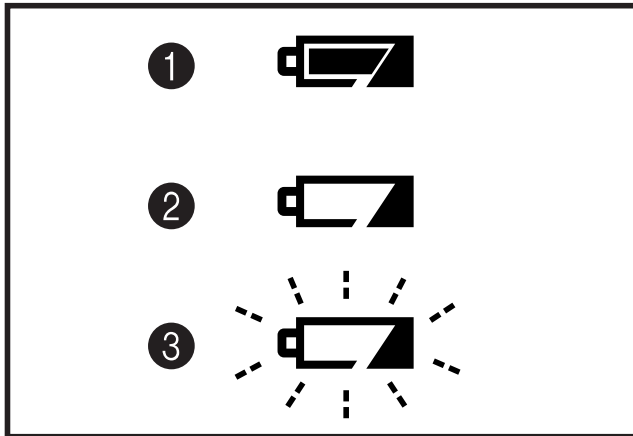

CHECKING YOUR BATTERY

To determine the condition of the battery in your camera, turn the camera on and check the battery capacity indicator on the LCD panel.

- ① Lit : Battery capacity is OK.
- ② Lit : Battery capacity is low. Replace with a new battery.
- ③ Blinks: Shutter cannot be released because battery is exhausted. Replace with a new battery.

- * Check the battery capacity before you using your camera.
- * The battery can be replaced even while there is a partially-exposed film in the camera.

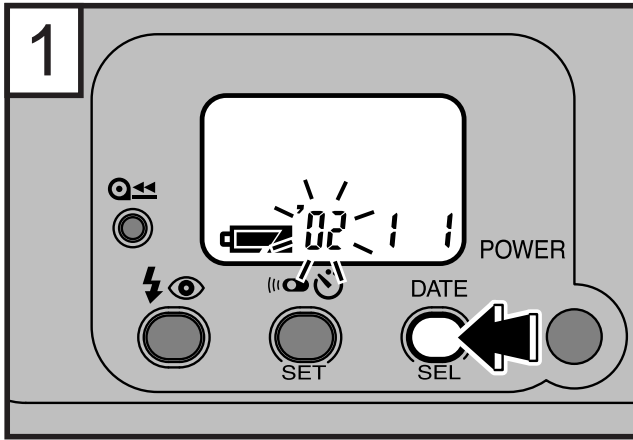

SETTING THE DATE (YEAR-MONTH-DAY/ HOUR-MINUTE)

Setting the date

Turn the camera on and then press the DATE button.

☞ The “Year” blinks and the camera will enter the date/time setting mode. You can set:

Year : '02 to '32 (2002 to 2032)

Month : 1 to 12 Day : 1 to 31

Time : 0 to 23 hours; 00 to 59 minutes

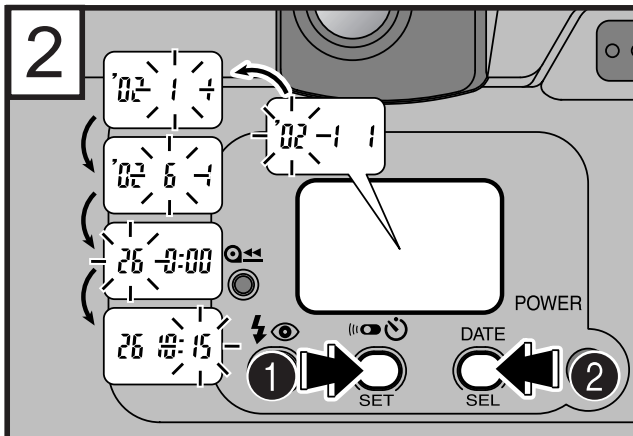

① Press the SET button to change the blinking setting.

② Press the SEL button to select the next part of the date/time information.

☞ Each press of the SEL button selects a different element in the date/time information in the following order:

Year→Month→Day→Hours→Minutes

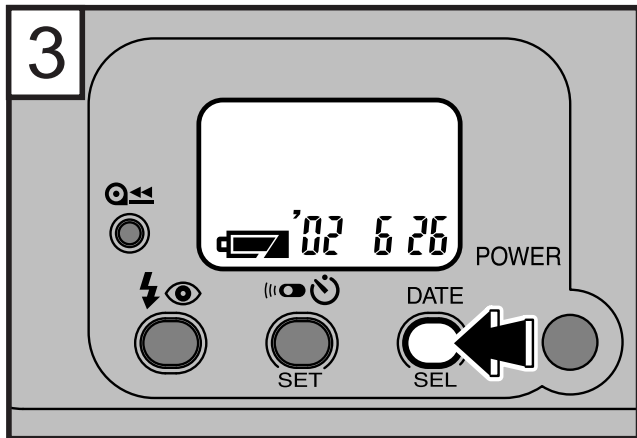

To cancel the date/time setting mode, press the DATE/SEL button after changing the “Minutes”.

☞ To set the time (hour or minute) by the radio, press in the DATE/SEL button when the time signal indicates zero.

* The year, month, and day will change together with the hour and minute.

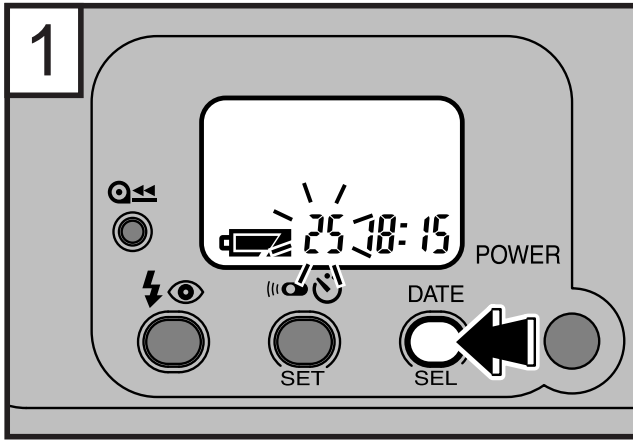

Changing the date

Turn the camera on and then hold down the DATE button for at least 2 seconds or longer.

☞ The “Day” blinks and the date change mode is entered.

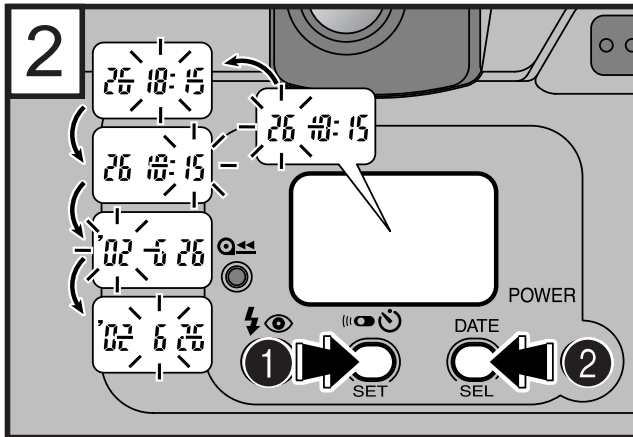

Using the procedure described in steps 2 ① to ② on page 13, set the date with the SET and SEL buttons.

☞ Each press of the SEL button selects a different element in the date/time information in the following order:

Day→Hours→Minutes→Year→Month

☞ Press the DATE/SEL button after changing the “Month”.



SELECTING THE DATE MODE

The date and time (year-month-day/ hour-minute) will be imprinted at the lower right of the photograph.

- * The date display printed on the front of the picture may not be clearly visible against a dark background.

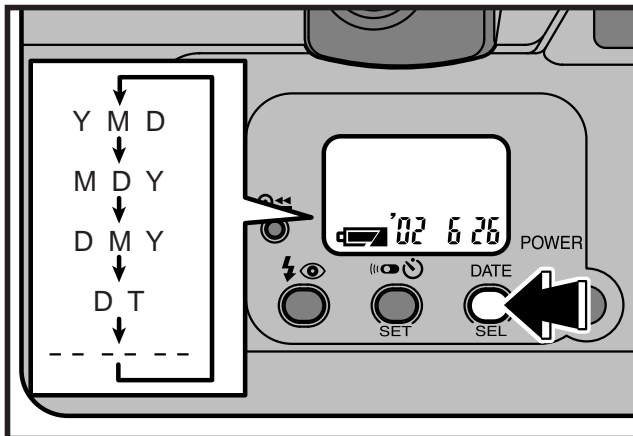

Y : Year M : Month D : Day T : Time

Turn the camera on, and then press the DATE button to enter date/time mode. The date/time mode changes in the order shown in the illustration.

- * If “- - - - -” is chosen, no date will appear on the photograph.

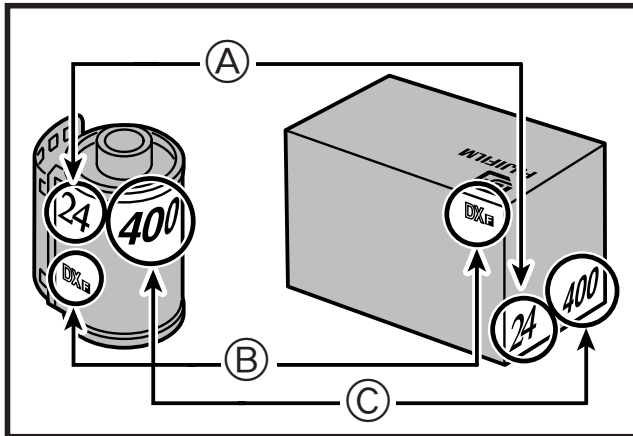

2. USING YOUR CAMERA

LOADING THE CAMERA

Your camera uses standard 35mm film available anywhere. Almost all 35mm films will have a DX coding symbol on the film box and on the cassette itself. Information you will see includes:

- Ⓐ : Number of exposures
- Ⓑ : DX code symbol
- Ⓒ : Film speed (sensitivity to light or ISO rating)

- If non-DX coded film is used, the camera's automatic exposure system automatically sets itself to ISO 100.
- Always load and remove film from your camera away from direct sunlight.

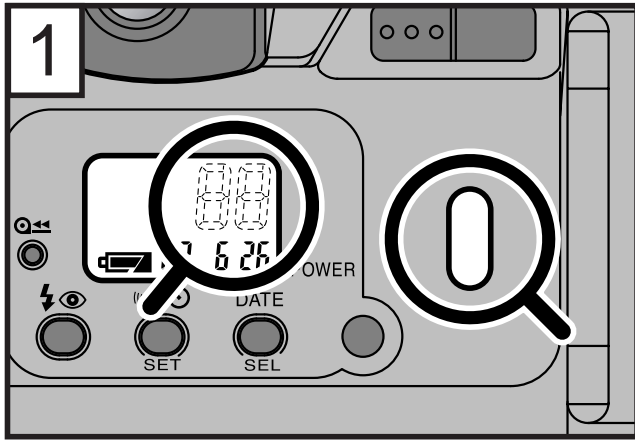

Check that there is not a film in the camera and that the exposure counter is not displayed.

* Never open the camera back while film is in your camera. Before replacing the film, refer to page 29.

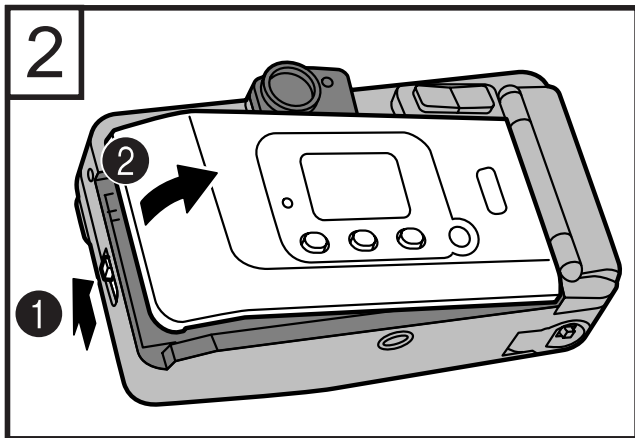

① To load the film, slide camera back lock in the direction of the arrow as shown in the picture at left.

② Open the camera back as shown.

* Never apply excessive force when opening or closing the camera back.

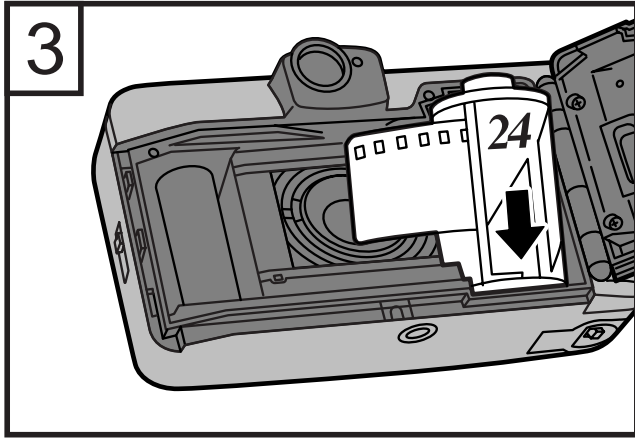

Insert the roll of film. Keep the long end of the spool in the film cassette at the top of the film compartment as shown in the drawing.

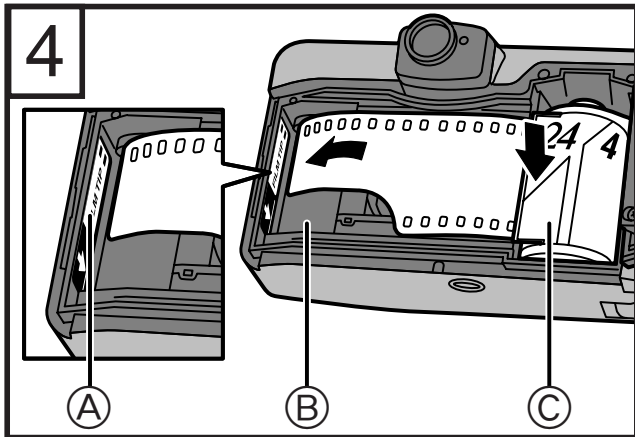

- Ⓐ : FILM TIP mark
- Ⓑ : Film take-up spool
- Ⓒ : Film cassette

While holding the film cassette in place, pull the end of the film out to the FILM TIP mark and place it on top of the spool.

- * Hold the film cassette down so that it does not pop out of the film compartment.
- * Make sure the end of the film is correctly threaded onto the spool.
- * If you should pull the film out too far, remove the film cassette and rotate the longer end of the spool slowly to rewind some of the exposed film and adjust the leader to the correct length to reach the FILM TIP mark. Be careful not to rewind the leader completely into the cassette.

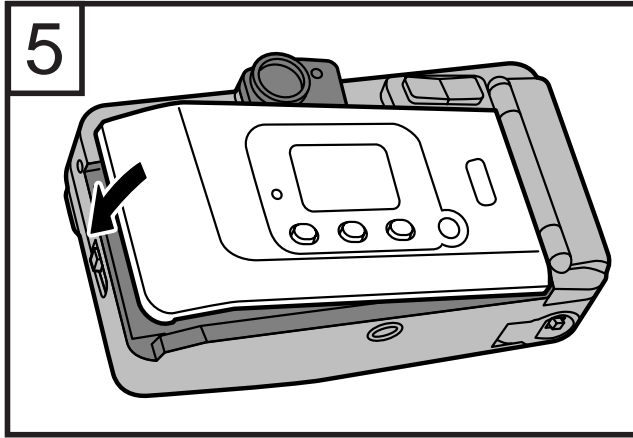

Close the camera back.

☞ The film advances automatically.

* The type, number of exposures, and speed of the film that has been loaded may be checked with the film confirmation window.

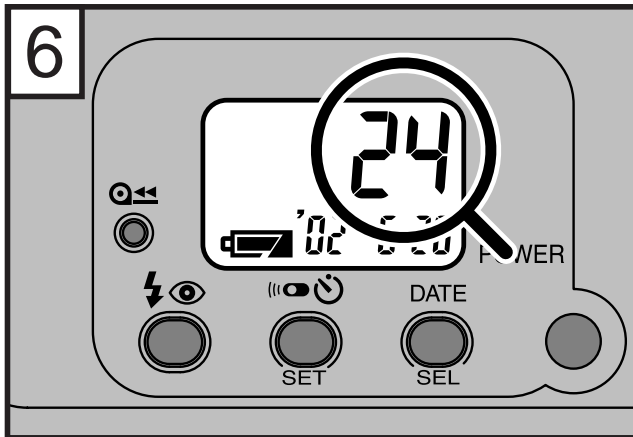

Check the exposure counter (telling the number of exposures remaining).

If the film is not loaded correctly, the film counter is not displayed on the LCD. In this case, insert the film again making sure it is loaded correctly to permit taking pictures.

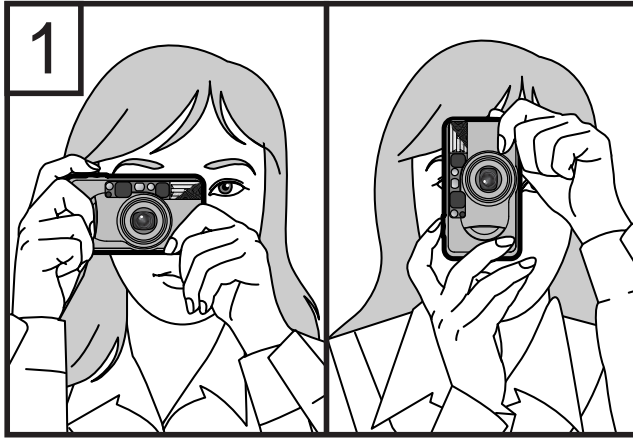

USING YOUR CAMERA

Turn the camera on and hold it firmly using both hands as shown in the illustration.

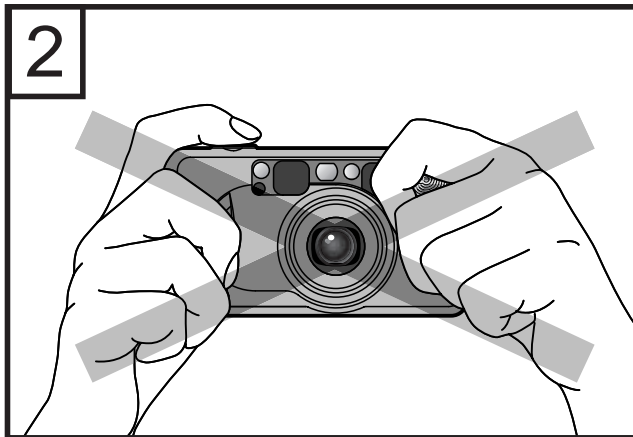

☞ When taking vertical pictures, hold the camera with the flash unit at the top.

Before taking important, once-in-a-lifetime pictures such as weddings or special events, take a few test shots to make sure your camera is functioning correctly. If you purchased your camera before going on a trip, shoot a roll or two to familiarize yourself with the operation of the camera. And don't forget to get an extra set of batteries. You should also keep this instruction book with you for handy reference.

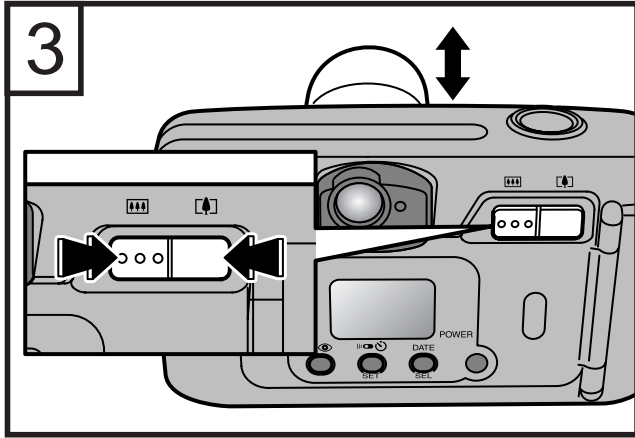

Make sure that nothing is in front of the lens, the flash, the AF (Auto-Focus) windows or the AE (Automatic exposure) light sensor.



To use the zoom lens, press the  mark until you see the composition you want in the finder. Pressing the  mark will set the lens at the shorter focal lengths to obtain wide-angle coverage.

* The focusing range for sharp pictures is from 0.9 m (3.0 ft.) to infinity.

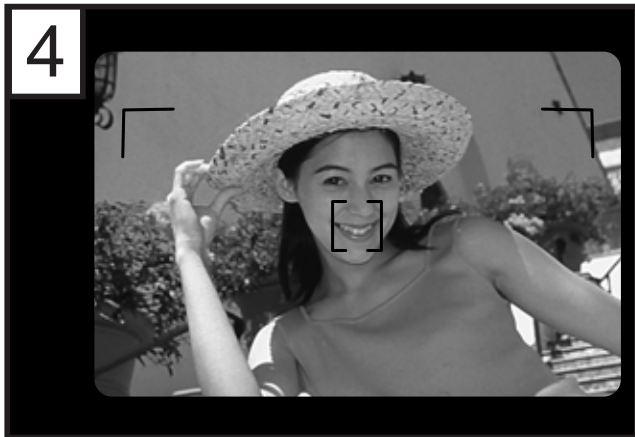

Aim at your subject so that it is covered by the whole AF frame.

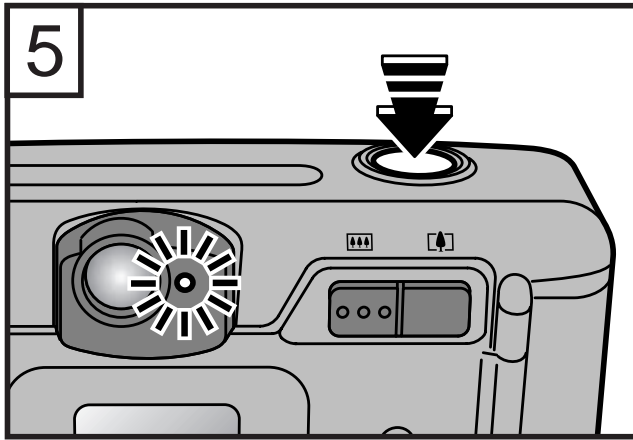

Press down the shutter release button halfway.

- ☞ Focusing is complete when the AF lamp (green) lights up.
- * If you are closer than 90 cm (35 in.) to the subject, the AF lamp will start blinking to warn you that the subject cannot be focused. If you are closer than the minimum focusing distance (60 cm / 24 in.), the AF lamp will turn on the camera will not focus on your subject.

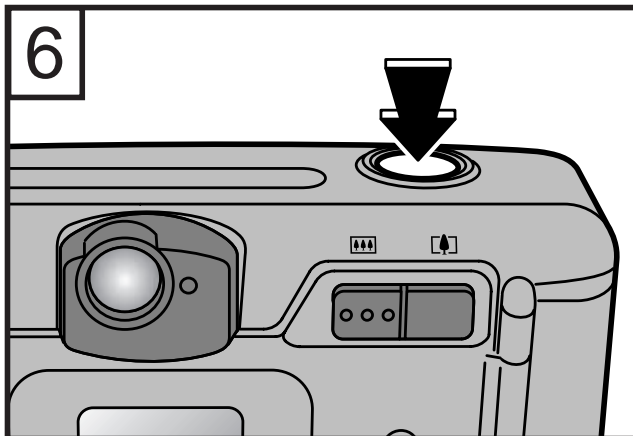

Press the shutter release button down completely.

- ☞ The film is advanced to the next frame.
- ☞ The number indicated by the exposure counter decreases by one each time a picture is taken.
- * The AF lamp and red-eye reduction/self-timer lamp will go off once and reappear immediately after the shutter is released.
- * During the charging time of the flash (when the alarm sign is blinking “⚡”) the shutter cannot be released.

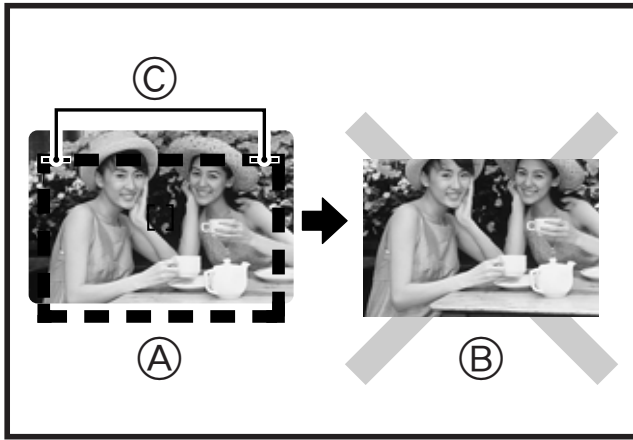

Close-up photography

- Ⓐ : Viewfinder
- Ⓑ : Print finishing
- Ⓒ : Parallax correction guides

When photographing a subject that is closer than approx. 1.5 m (4.9 ft.) from the camera, the area within the frame shown in the diagram on the left will be in the picture. Compose the picture so that the subject that you want to photograph is within the frame.

When taking close ups, an area seen through the viewfinder and the area seen by the lens and actually photographed will be different. This is because the viewfinder and lens are not in the same position, a difference known as "parallax". The parallax correction guides indicates the difference between what the viewfinder sees and what the lens sees when the picture is taken.

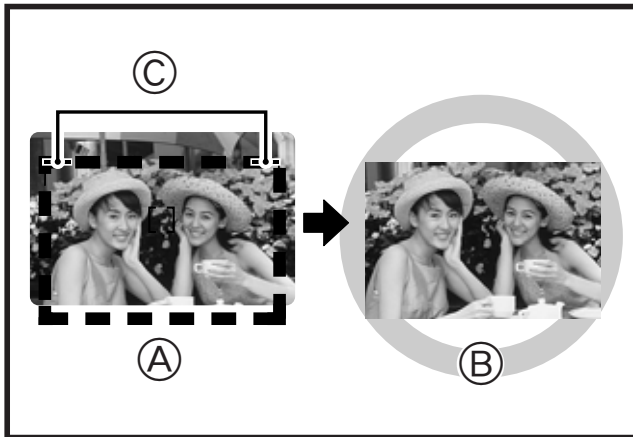

There are a few conditions when the camera's autofocus system may not function accurately. At these times, you should use the "Auto-Focus Lock" settings (→p.26) or the "Landscape Mode" setting (→p.37). Conditions requiring these settings include:

- A bright light source within the picture such as the sun near your subject, a strong light reflection such as from water or from the windshield of a car;
- A mirror or other strongly reflective surface near the center of the picture;
- Shooting black light-absorbing subjects such as hair;
- Presence of flames, smoke or gaseous substances;
- Photographing through glass.



USING THE AUTO-FOCUS LOCK

In the composition shown at left, the AF frame is off the subject (in this case, the people). In this case the lens will not focus on the subject.



Move the camera to position the AF frame over the subject.

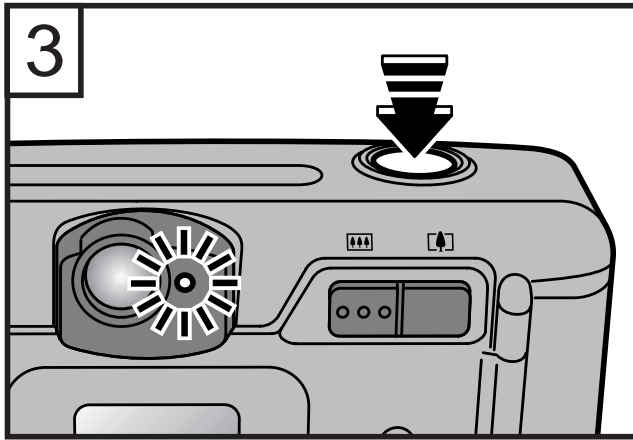

With the AF frame positioned over the subject, press down the shutter release button halfway to set the Auto-Focus lock.

☞ Check that the AF lamp (green) lights up.



While holding the shutter release button halfway down to keep the Auto-Focus lock on, move the camera back to the original position to recompose your picture, then press the shutter release button all the way down.

* The Auto-Focus lock operation can be repeated any number of times before the shutter trips.

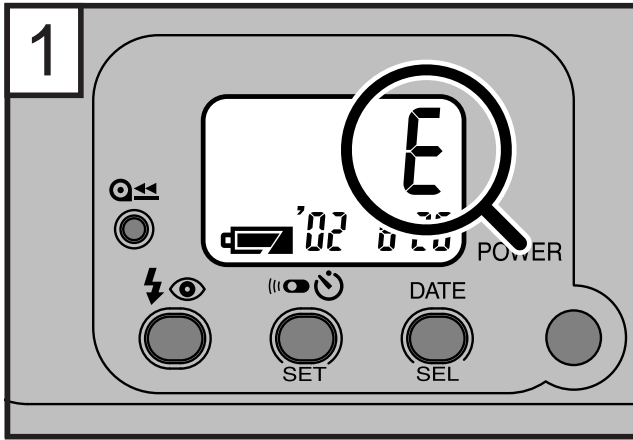

UNLOADING THE FILM OR REMOVING FILM IN MID-ROLL

To Unload the Film

When the last frame in the film has been exposed, the film automatically rewinds into the film cassette which can then be removed for processing.

☞ When rewinding is complete, the exposure counter will read “E”.

Before opening the camera back, check that the rewinding is completed and the motor stopped. At this point, “E” is displayed. If you don't take this precaution, the exposed film in the camera may be exposed to light. (→p.30)

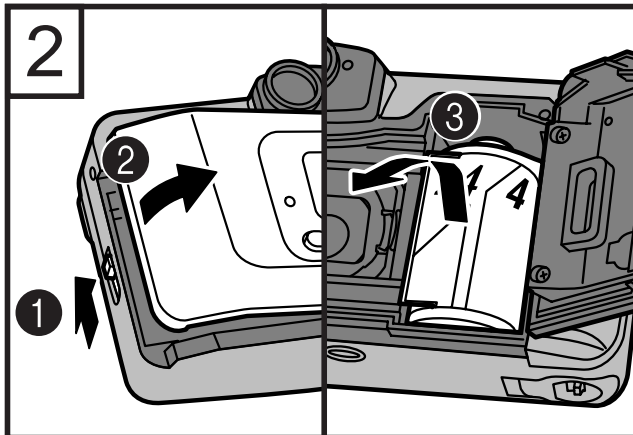

- ① Slide the camera back lock in the direction indicated by the arrow.
- ② Open the camera back in the direction indicated by the arrow.
- ③ Remove the film.

* Do not apply unnecessary force to the camera back.

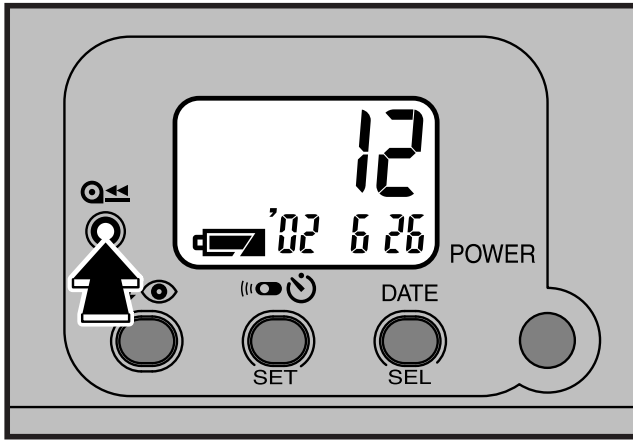

Removing film in mid-roll

Press the  button with the point of a pen or something similar.

☞ When rewinding is complete, the exposure counter will read “E”.

* Do not press the  button with any object that tapers to a sharp point.

Check that the motor has stopped and that “E” is displayed before removing the film.

Film cannot be reused once it has been rewound. Do not press the  button except when removing the film for developing.

◆ **Do not open the camera back while there is a film in the camera.**

☞ If you open the camera back while a film is loaded in the camera, close the camera back again.

* When the camera back is closed, the film is automatically rewound and “E” is displayed.

* Film cannot be reused once it has been rewound.

However, since this camera uses automatic pre-winding, only the last frame taken will be exposed to light should the camera back be opened accidentally.

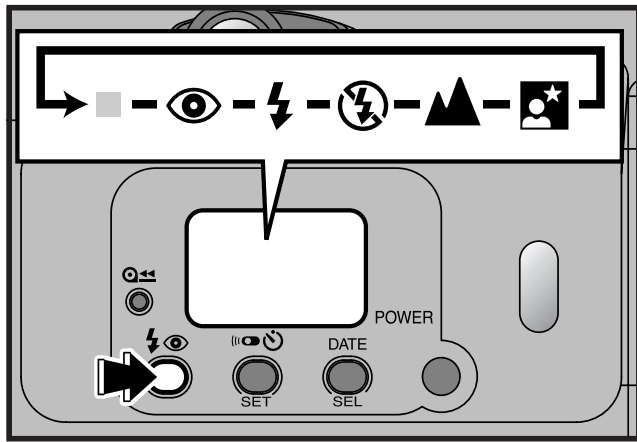



3. ADVANCED TECHNIQUES





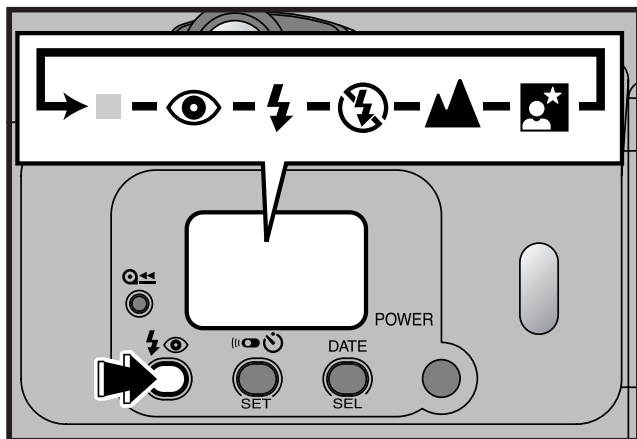

SELECTING THE EXPOSURE MODE

Your camera offers 6 exposure modes to give you successful pictures under a wide range of photographic situations with various subjects. These modes are:

- (■) Automatic flash for low light situations
- (👁) Red-eye reduction flash for more pleasing pictures of people
- (⚡) Back light compensation flash mode
- (⚡/) Flash-off mode for natural light pictures
- (⚙) Landscape mode for pictures of distant subjects
- (👤★) Night portrait (slow sync) mode for fill-flash pictures



Each press of the  button changes the exposure mode in the following order:

  →  →  →  →  → 

- The automatic flash mode and red-eye reduction flash mode are maintained even when the power is turned off.
- The back light compensation flash mode and flash-off mode are automatically cancelled when the power in the camera is turned off.
- The landscape mode and night portrait modes are automatically cancelled after a photo is taken or the camera is turned off.

The operating range of the film (flash distance) will vary depending upon the film's sensitivity (ISO speed). When using flash, keep your subject within the range of the effective flash illumination as indicated in the chart below.

Effective flash range

Film speed	Wide angle (38 mm)	Telephoto (125 mm)
ISO 100	0.9 – 3.7 m 3.0 – 12.1 ft.	0.9 – 2.4 m 3.0 – 7.9 ft.
ISO 400	0.9 – 7.3 m 3.0 – 24.0 ft.	0.9 – 4.8 m 3.0 – 15.7 ft.
ISO 800	0.9 – 10.3 m 3.0 – 33.8 ft.	0.9 – 6.8 m 3.0 – 22.3 ft.
ISO 1600	0.9 – 14.6 m 3.0 – 47.9 ft.	0.9 – 9.6 m 3.0 – 31.5 ft.

(Using color negative film)



(■ : no display) **Automatic flash at low brightness mode**

Used for general photography.

The flash lamp fires automatically when the brightness of the subject is lower than the predetermined level.



(👁) **Red-eye reduction flash mode**

Reduce red-eye.

The red-eye reduction lamp turns on for approx. 1 second, then the camera takes a picture when the flash fires.

The AF lamp continues to be lit while the red-eye reduction lamp is lit. Do not move the camera from the time the AF lamp lights to the time the flash fires.

Dealing with red-eye

When you photograph a person in dim light using flash, the pupil of the eye will sometimes appear red. Under low light, the pupils of the eye dilate for better vision. Red-eye is caused by light from the flash entering the dilated pupils and being reflected back to the lens. Red-eye reduction causes a preliminary flash to fire before the actual picture is taken. This causes the pupil to contract, reducing this reflection. When the actual flash exposure is made, the degree of reflection is minimized, thus reducing red-eye.

When using red-eye reduction mode

- Ask your subject to look directly into the camera.
- Approach as closely as possible to make your exposure.



(⚡) Back light compensation flash mode

Use this mode to avoid deep shadows when photographing against the light such as a person standing in front of a window or under a tree with a very bright background. This produces more natural looking flash photographs.

Flash pictures taken even in a bright place.



(⚡) Flash-off mode

Used when taking pictures under normal room lighting or taking pictures of subject beyond flash range such as in a theatre or a stadium.

The flash stops firing.

- * When taking pictures under low light, use a tripod whenever possible to avoid unsharp pictures resulting from camera shake.



(▲) Landscape mode

Used when taking landscape pictures or photographing remote (night) scenes through window glass.

The lens is focused for the distant subjects. The flash does not fire in this mode.

- * This mode is automatically cancelled per shot.
- * When taking pictures under low light, use a tripod whenever possible to avoid unsharp pictures resulting from camera shake.



() Night portrait (slow sync) mode

Used when taking portraits to record the background in a night scene.

The slow shutter speed/red-eye reduction flash mode can be used to make sure that both people and nighttime background scenery are photographed clearly. (After the red-eye reduction lamp has lit for approx. 1 seconds, the flash fires.)

* This mode is automatically cancelled per shot.



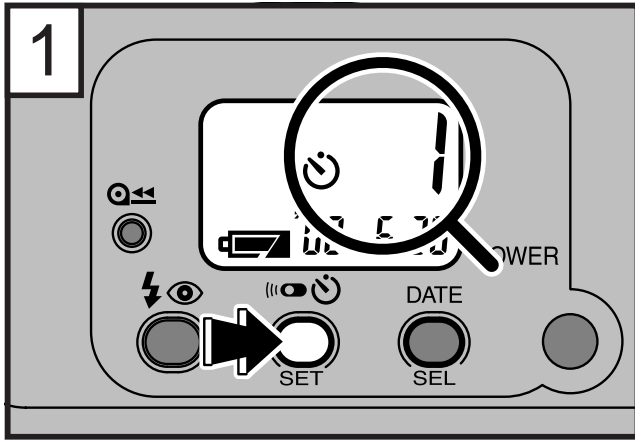

As a slow shutter speed is used with the night portrait mode, be sure to place your camera on a tripod to prevent camera shake. It is also important that your subject remain still during the complete exposure.



USING THE SELF-TIMER

Press the  button.

- ☞ The self-timer can be used to take up to 3 consecutive exposures.
- ☞ Each press of the  button changes the self-timer mode in the following order:

 1 →  2 →  3 → 

- * “” indicates the remote control mode. (on the Zoom Date 125SR only)(→p.41)
- * The exposure modes can also be selected in the self-timer mode.



Compose the picture and press the shutter release button.

- ☞ The camera focuses on the subject that the AF frame is positioned over, and then the self-timer starts.
- * You can select the Auto-Focus lock mode also. (→p.26)

When pressing the shutter release button, do not stand in front of the camera. This may cause a focusing error or underexposure.

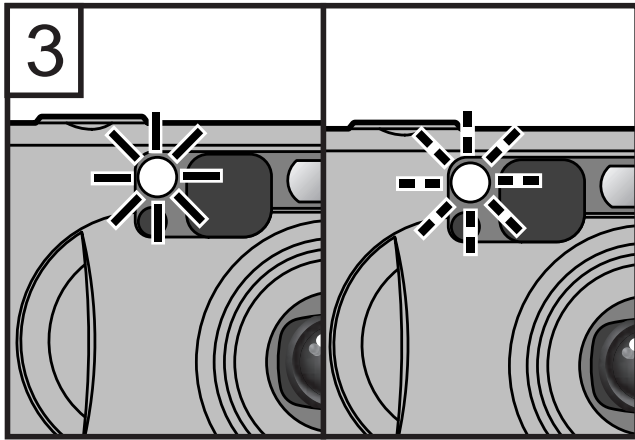

After the self-timer lamp remains lit for approx. 7 seconds, it blinks for approx. 3 seconds, and then the shutter is released. When taking consecutive exposures, the shutter is released the set number of times at an interval of between 3 and 6 seconds.

- To cancel the self-timer mode after the self-timer has started, press the  button.
- The self-timer mode is automatically cancelled after a photo is taken or the camera is turned off.

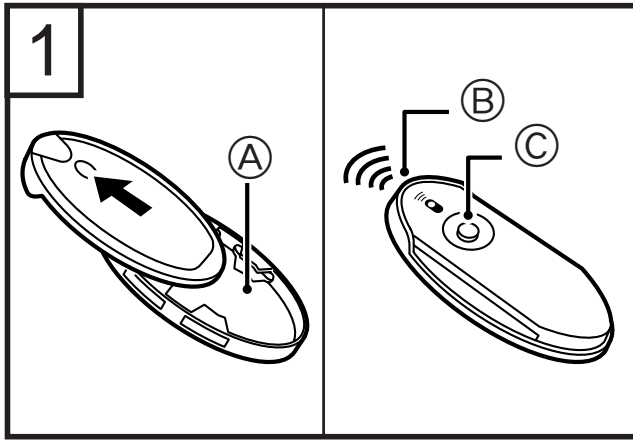

USING THE REMOTE CONTROLLER

(on the Zoom Date 125SR only)

A FUJIFILM remote controller is required.

Remove the remote controller from its holder by sliding it in the direction of the arrow.

- Ⓐ : Remote controller holder
- Ⓑ : Transmitter
- Ⓒ : Shutter release button

- * To replace the remote controller in the holder, slide the remote controller in the direction opposite to the arrow until it clicks into position.
- * Remote controller is optional. The specific remote controller may be different from the one shown in the illustration.

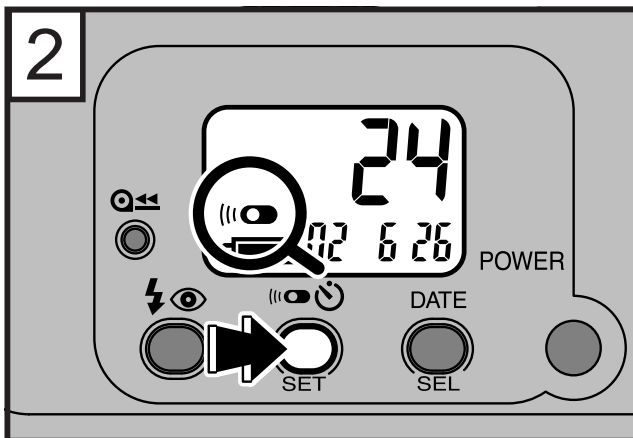

Press the button, until "" appears on the LCD.

- * The remote control mode is displayed after the self-timer mode.
- * The exposure modes can also be selected in the remote control mode.



Aim the AF Frame at your subject and compose the picture.

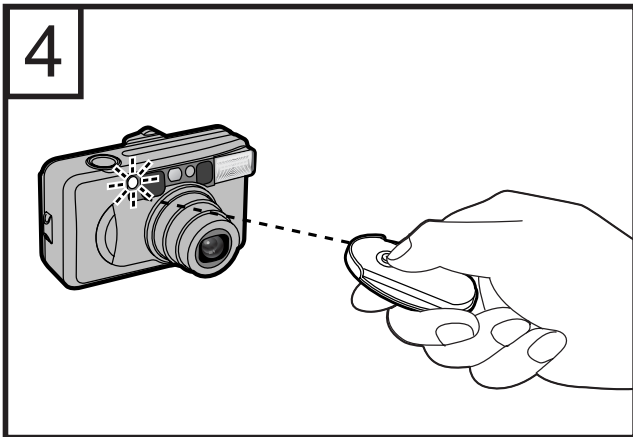

- 1 Point the remote controller toward the camera's remote controller sensor, and then press the remote controller's shutter release button.
- 2 After the self-timer/remote controller lamp blinks for approx. 2 seconds, the shutter is released.

The remote control mode is not cancelled after shooting. It is automatically cancelled when the power is turned off.

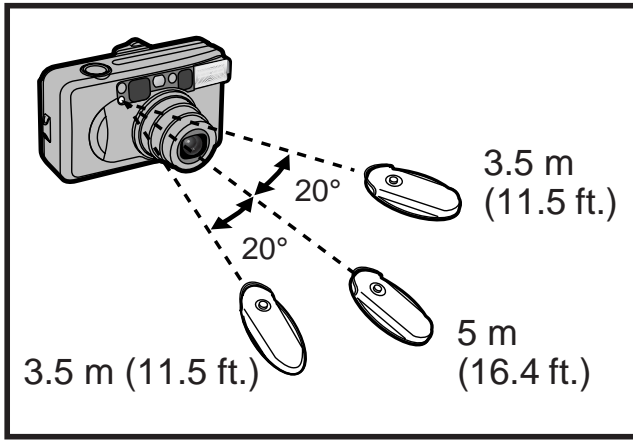

The coverage of the remote controller is up to approx. 5 m (16.4 ft.) when used directly in front of the camera, and up to approx. 3.5 m (11.5 ft.) when used at a vertical or horizontal angle of 20°.

- * A tripod is recommended when taking pictures by remote control.
- * The remote controller may not work properly when direct sunlight enters the camera's light sensor from behind your subject. Use the self-timer in such a case.

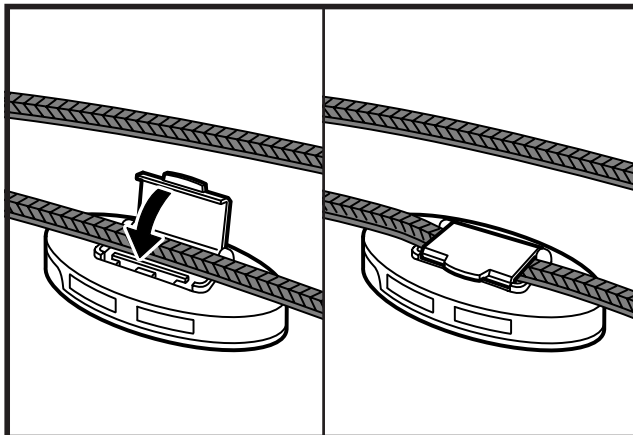







Fit the remote controller holder to the camera strap for more convenient handling.

- * The remote controller holder can be easily opened with a coin.
- * The battery life is about three years (based on our test conditions). If the remote controller no longer operates, contact your local retailer where you purchased your camera or our service center. A replacement battery will be available at nominal cost.

TROUBLE SHOOTING

During operation

Problems	Possible Causes	Solutions	Page
The shutter release won't trip.	<ul style="list-style-type: none"> ① “” symbol is blinking. ② Power switch is not on. ③ Is “” blinking on the LCD? ④ “” is lit on the exposure counter. 	<ul style="list-style-type: none"> ① Replace the battery with a new one. ② Press the POWER button. ③ The flash is charging. Wait until “” stops blinking and is displayed. (The flash takes approx. 6 seconds to charge.) ④ Remove the film, and load an unexposed film. 	<p>12</p> <p>11</p> <p>23</p> <p>17</p>
After loading the film and closing the camera back, the exposure counter is not displayed.	<ul style="list-style-type: none"> ● Did you pull the end of the film out to the FILM TIP mark when loading the film? 	<ul style="list-style-type: none"> ● Pull the end of the film out to the FILM TIP mark and correctly load the film. 	17
The film rewound during photographing.	<ul style="list-style-type: none"> ● Did you move the camera back lock while a film was loaded? 	<ul style="list-style-type: none"> ● Be sure not to move the camera back lock while film is loaded in the camera. When removing the film, check that the motor has stopped and that “” is displayed before opening the camera back. 	28,30
After loading a film and closing the camera back, the numerals on the exposure counter blink.	<ul style="list-style-type: none"> ● Did you remove film without rewinding it after you began photographing? 	<ul style="list-style-type: none"> ● After removing the film, remove the battery, press the POWER button, and check that the exposure counter is no longer displayed. Then insert the battery again. 	28
The self-timer cannot be set.	<ul style="list-style-type: none"> ● Is the date correction mode on? 	<ul style="list-style-type: none"> ● Cancel the date correction mode. 	13
“  ” is blinking and the shutter can not be released.	<ul style="list-style-type: none"> ● The camera is broken. 	<ul style="list-style-type: none"> ● Please contact a FUJIFILM authorized distributor. 	

Printed pictures

Problems	Possible Causes	Solutions	Page
Picture is not sharp.	<ul style="list-style-type: none"> ① Was your finger on the AF windows when shooting? ② Did you aim the subject properly? ③ Is the lens dirty? ④ Is the camera moving? ⑤ You selected ▲ mode when shooting at a close distance. 	<ul style="list-style-type: none"> ① When shooting a picture, hold your camera correctly so that your finger is not on the AF windows. ② Compose the picture in the AF frame and shoot, or shoot using AF Lock. ③ Clean the lens. ④ Hold the camera firmly and press the shutter release button gently. Use a tripod for slow shutter speeds. ⑤ Select a mode other than ▲ mode. 	<p>21</p> <p>26</p> <p>46</p> <p>21</p> <p>31</p>
Picture is too dark.	<ul style="list-style-type: none"> ① Subject was too far from the camera for flash photography in a dark place. ② Was your finger over the flash? ③ Was the subject backlit from being taken next to a window, etc.? 	<ul style="list-style-type: none"> ① Shoot within specified coverage distance of electronic flash. ② Do not cover the flash with your finger. ③ Turn on ⚡ mode and press the shutter release button. 	<p>33</p> <p>21</p> <p>36</p>
Printed date/time is incorrect.	<ul style="list-style-type: none"> ● You didn't set correct date and time after replacing battery. 	<ul style="list-style-type: none"> ● Set date and time after replacing battery. 	<p>13</p>
The date is not printed on the front./The date is not printed clearly.	<ul style="list-style-type: none"> ① Wasn't "- - - - -" selected before taking pictures? ② Is there something light-colored (white, yellow, orange) where the date appears? 	<ul style="list-style-type: none"> ① Select a date mode other than "- - - - -" before taking pictures. ② Try to arrange that there is nothing light-colored where the date appears. 	<p>16</p> <p>16</p>

COMMON SENSE CAMERA CARE

- 1 Although your camera is designed for many years of service, it is a precision instrument and requires thoughtful handling. In particular, avoid exposing it to shock, moisture or physical abuse such as dropping it on the floor.
 - ① If you use your camera at the beach or in a light rain, protect it from moisture. Do not let your camera get wet. Be particularly careful to avoid sand and salt spray at the beach.
 - ② Dropping your camera or letting it strike a hard surface could result in damage even though the camera was in a case. Never subject the camera to vibration such as in the trunk of a car. Never keep your camera in the trunk or the glove compartment of a car: the heat build-up can damage it.
- 2 Your camera is computer-controlled so it seldom, if ever, will operate erroneously. If you should experience erroneous operation, remove the battery and then reload it.
- 3 If you will not be using your camera for some time, store it where it will be safe from heat, moisture, dust and harmful gases such as naphthalene (moth balls and moth flakes).
- 4 Never store the camera in a closed automobile for an extended period.
- 5 It is recommended that undeveloped film and cameras containing film be carried as hand luggage when flying. If included in checked baggage, X-ray inspections may cause overprinting or other effects.
- 6 Remove soil and dust from the lens, the AF window and the finder with an air blower and by wiping lightly with a piece of soft cloth. If that is not enough, wipe off gently with Lens Cleaning Paper, moistened slightly with Lens Cleaning Liquid. Do not use organic solvents such as alcohol and benzene.
- 7 Dust and debris in the film compartment can scratch the film. Use a blower brush to clean it.
- 8 Load and remove film away from direct sunlight.
- 9 The operating temperature range of the camera is from -10°C to $+40^{\circ}\text{C}$.
- 10 Since the performance of the battery will drop in cold weather, warm the battery by placing it inside your garments, etc. before use. The performance of a battery whose performance has temporarily dropped can be restored by returning the battery to normal temperature.

With a few common sense precautions, your camera will give you years of faithful service, great pleasure and wonderful pictures.

SPECIFICATIONS

- **Film**

135 (35 mm) DX roll film

- **Picture Size**

24 mm × 36 mm

- **Lens**

Fujinon lens, 6 components, 6 elements, f=38 – 125 mm 1:5.3 – 1:10.5

- **Viewfinder**

Real image zoom finder, 0.41 – 1.10 × magnification, with AF frame, parallax correction guides, AF lamp

- **Focusing**

Active type auto focus, 0.9 m (3.0 ft.) – ∞, with AF lock, landscape mode (long distance lens position setting, flash off setting), AF lamp (on: range OK, blinking: over range alarm)

- **Shutter Release**

Programmed electronic shutter release, 1/2 – 1/500 sec. shutter speeds

- **Exposure Control**

Automatic

Interlocking range (ISO 100), EV (wide-angle): 10.6 (*6.1) – 16, EV (telephoto): 13.8 (*8.3) – 19.3 (* = values for the flash off mode)

- **Film Speed Setting**

Automatic (DX roll film) for speeds from ISO 50-3200

- **Film Loading**

Automatic

- **Film Advance**

Automatic (motorized), film prewind system, film wind and rewind system, provision for mid-roll rewinding (Use the mid-roll rewind button)

- **Flash**

Zoom flash, approx. 6 seconds recycle time, automatic flash at low brightness mode, red-eye reduction flash mode, back light compensation flash mode, flash-off mode, night portrait (slow sync) mode

Red-eye reduction flash mode system: LED pre-flash

- **Self-Timer**

Electronically controlled, up to 3 consecutive exposures approx. 10 second delay, can be stopped mid-run, self-timer on lamp

- **Liquid Crystal Display**

Exposure counter (shows exposures remaining), exposure mode index, self-timer mode sign, date sign, battery capacity sign, flash charging sign, remote control mode sign (on the Zoom Date 125SR only).

- **Power Supply**

- One CR123A/DL 123A lithium battery

- **Others**

- Date/Time Imprinting, Tripod socket, Remote controller (compatible) (on the Zoom Date 125SR only).



- **Dimensions & Weight**







- 116.0 × 64.0 × 43.0 mm/4.6 × 2.5 × 1.7 in. (main unit),
195 g/6.9 oz. (without battery)

* Specifications are subject to change without notice.





IMPORTANT SAFETY NOTICE

This product has been developed to be as safe as possible when used for its designed purposes. Under normal circumstances, this product will provide long, safe service when handled correctly. It is important, however, that this product is handled properly and used only for photographic purposes. For your convenience and safety, please follow the recommendations listed below. It is also a good idea to keep this manual in a safe, convenience place where you can refer to it easily if necessary.



 WARNING	 CAUTION
This symbol indicates a potentially dangerous situation which could result in serious injury or even death if these instructions are not followed.	This symbol indicates a potentially damaging situation which could result in injury to other people or damage to object, if these instructions are not followed and the product is handled improperly.

 WARNING
<ul style="list-style-type: none"><li data-bbox="152 820 2107 852"> Never attempt to take this part apart. There is a serious danger of a powerful electric shock.<li data-bbox="152 874 2107 938"> If this product is dropped or damaged so that the interior is exposed, do not touch anything. There is danger of a severe electric shock.<li data-bbox="152 960 2107 1066"> If the camera or the batteries within become hot, begin to smoke, produce a burning smell or display any sign of abnormal or unusual condition, remove the batteries immediately. Use gloves to prevent the possibility of burning your hands. Failure to remove batteries under these conditions could result in burns or even fire.<li data-bbox="152 1088 2107 1152"> Using a flash too close to a person's eyes may temporarily affect the eyesight. Take particular care when photographing infants and young children.<li data-bbox="152 1174 2107 1238"> If your camera gets wet or if foreign objects such as pieces of metal get inside, remove the batteries immediately to avoid any possible heat buildup or of fire starting inside the camera.

WARNING

-  Do not use this camera in locations with a high concentration of inflammable gas or near open gasoline, Benzine, paint thinner or other volatile substances which can give off dangerous vapors. Failure to observe this precaution could result in explosion or fire.
-  Store your camera out of the reach of infants and young children. Failure could follow this recommendation could result in serious injury. (For example, the strap could become entwined around their necks with potentially serious consequences.)
-  Never dismantle the batteries when they are removed from the camera. Do not subject them to heat, throw them into an open fire, attempt to recharge them or to short circuit them. Failure to follow this recommendation could result in the batteries exploding or splitting open.
-  Use only the type of batteries specified in your camera's instructions. Failure to do so may result in excessive heat buildup or even in a fire.
-  Make sure batteries are stored in a safe, secure place well out of the reach of any infants and young children or pets. Improper store could result in a child swallowing a battery. (If a child does swallow a battery, call a doctor or nearest hospital immediately.)

CAUTION

-  Never get this product wet or handle it with wet hands. Doing so may result in an electric shock.
-  Never take flash photographs of people riding bicycles, driving cars or riding a horse. The flash can distract the driver and frighten the animal, possibly causing a serious accident.
-  Observe correct polarity when inserting batteries. Never insert batteries with the \oplus and \ominus poles back to front. Failure to observe correct handling might result in the batteries splitting open and leaking, possibly resulting in fire, burns or damage to surrounding objects.



26-30, Nishiazabu 2-chome, Minato-ku, Tokyo 106-8620, Japan

<FUJIFILM ABROAD>

In North America

FUJI PHOTO FILM U.S.A., INC.

555 Taxter Road, Elmsford, N.Y. 10523, U.S.A.

FUJI PHOTO FILM CANADA INC.

275 Britannia Road East, Mississauga, Ontario , L4Z 2E7, Canada

FUJI PHOTO FILM HAWAII, INC.

1650 Kalakaua Avenue, Honolulu, Hawaii 96826, U.S.A.

In Europe

FUJI PHOTO FILM (EUROPE) G.m.b.H.

Heesenstrasse 31, 40549 Dusseldorf, Germany

FUJI PHOTO FILM (U.K.) LTD.

Fuji Film House, 125 Finchley Road, Swiss Cottage, London NW3 6JH, England

FUJI FILM ESPAÑA, S.A.

Aragon, 180, 08011-Barcelona, Spain

In South America

FUJI PHOTO FILM DO BRAZIL LTDA.

Avenida Vereador Jose Diniz No. 3.400, Campo Belo- CEP 04.604

Cx. Postal 9.959., Sao Paulo-SP, Brazil

In Asia

FUJI PHOTO FILM CO., LTD., HONG KONG OFFICE

Room 916, Sun Plaza, 28 Canton Road, Tsim Sha Tsui, Kowloon, Hong Kong

FUJI PHOTO FILM (SINGAPORE) PTE. LTD.

10 New Industrial Road, Singapore 536201

FUJI PHOTO FILM (THAILAND) LTD.

S.P. Building, 8th Floor, 388 Phaholyothin Road, Bangkok 10400, Thailand

FUJI PHOTO FILM (MALAYSIA) SDN. BHD.

Letter Box 3, 3rd Floor Office Block 1, Crystal Plaza Lot 4, Jalan 51A/223, 46100 Petaling Jaya Selangor Darul Ehsan Malaysia

FUJI PHOTO FILM CO., LTD., TAIPEI OFFICE

Rm. 601, Hung Chong Bldg., No.38, Sec. 6, Min Chuan E. Road, Taipei 11412, Taiwan, Republic of China

FUJI PHOTO FILM CO., LTD., SEOUL OFFICE

Samduck Bldg. 6F., 144-1, Samsung-Dong, Kang Nam-ku, Seoul 135-090, Korea

FUJI PHOTO FILM CO., LTD., BEIJING REPRESENTATIVE OFFICE

Beijing Fortune Bldg. No. 817, 5, Dong Sanhuan Bei-lu, Chaoyang District, Beijing, China 100004

FUJI PHOTO FILM CO., LTD., HO CHI MINH OFFICE

29-31 Ton That Thiep St., Q.I Ho Chi Minh City, Vietnam

FUJI PHOTO FILM CO., LTD., NEW DELHI OFFICE

Le Meridian Commercial Tower 8F Janpath, New Delhi 110001, India

In Oceania

FUJI PHOTO FILM CO., LTD., SYDNEY REPRESENTATIVE OFFICE

c/o Hanimex Pty. Limited, Old Pittwater Road, Brookvale, N.S.W. 2100, Australia

In Middle East

FUJI PHOTO FILM CO., LTD., DUBAI OFFICE

No. 4G-17, L.O.B. No. 4, P.O. BOX 17212, Jebel Ali, Dubai, U.A.E.

Printed in Indonesia

FGS-103112-Ci-01

Free Manuals Download Website

<http://myh66.com>

<http://usermanuals.us>

<http://www.somanuals.com>

<http://www.4manuals.cc>

<http://www.manual-lib.com>

<http://www.404manual.com>

<http://www.luxmanual.com>

<http://aubethermostatmanual.com>

Golf course search by state

<http://golfingnear.com>

Email search by domain

<http://emailbydomain.com>

Auto manuals search

<http://auto.somanuals.com>

TV manuals search

<http://tv.somanuals.com>