

# FUJIFILM

BL03001-101 **EN**

## DIGITAL CAMERA FINEPIX F850EXR

### Owner's Manual

Thank you for your purchase of this product. This manual describes how to use your FUJIFILM digital camera and the supplied software. Be sure that you have read and understood its contents and the warnings in "For Your Safety" (📖 ii) before using the camera.

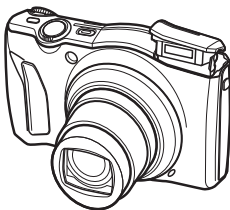

For information on related products, visit our website at [http://www.fujifilm.com/products/digital\\_cameras/index.html](http://www.fujifilm.com/products/digital_cameras/index.html)

Before You Begin

First Steps

Basic Photography and Playback

More on Photography

More on Playback

Movies

Connections

Menus

Technical Notes

Troubleshooting

Appendix



## IMPORTANT SAFETY INSTRUCTIONS

- **Read Instructions:** All the safety and operating instructions should be read before the appliance is operated.
- **Retain Instructions:** The safety and operating instructions should be retained for future reference.
- **Heed Warnings:** All warnings on the appliance and in the operating instructions should be adhered to.
- **Follow Instructions:** All operating and use instructions should be followed.

### Installation

**Power Sources:** This video product should be operated only from the type of power source indicated on the marking label. If you are not sure of the type of power supply to your home, consult your appliance dealer or local power company. For video products intended to operate from battery power, or other sources, refer to the operating instructions.

**Grounding or Polarization:** This video product is equipped with a polarized alternating-current line plug (a plug having one blade wider than the other). This plug will fit into the power outlet only one way. This is a safety feature. If you are unable to insert the plug fully into the outlet, try reversing the plug. If the plug should still fail to fit, contact your electrician to replace your obsolete outlet. Do not defeat the safety purpose of the polarized plug.

**Alternate Warnings:** This video product is equipped with a three-wire grounding-type plug, a plug having a third (grounding) pin. This plug will only fit into a grounding-type power outlet. This is a safety feature. If you are unable to insert the plug into the outlet, contact your electrician to replace your obsolete outlet. Do not defeat the safety purpose of the grounding type plug.

**Overloading:** Do not overload wall outlets and extension cords as this can result in a risk of fire or electric shock.

**Ventilation:** Slots and openings in the cabinet are provided for ventilation, to ensure reliable operation of the video product and to protect it from overheating, and these openings must not be blocked or covered. The openings should never be blocked by placing the video product on a bed, sofa, rug, or other similar surface.

This video product should not be placed in a built-in installation such as a bookcase or rack unless proper ventilation is provided or the manufacturer's instructions have been adhered to. This video product should never be placed near or over a radiator or heat register.

**Attachments:** Do not use attachments not recommended by the video product manufacturer as they may cause hazards.

**Water and Moisture:** Do not use this video product near water—for example, near a bath tub, wash bowl, kitchen sink, or laundry tub, in a wet basement, or near a swimming pool, and the like.

**Power-Cord Protection:** Power-supply cords should be routed so that they are not likely to be walked on or pinched by items placed upon or against them, paying particular attention to cords at plugs, convenience receptacles, and the point where they exit from the appliance.

**Accessories:** Do not place this video product on an unstable cart, stand, tripod, bracket, or table. The video product may fall, causing serious injury to a child or adult, and serious damage to the appliance. Use only with a cart, stand, tripod, bracket, or table recommended by the manufacturer, or sold with the video product. Any mounting of the appliance should follow the manufacturer's instructions, and should use a mounting accessory recommended by the manufacturer.

An appliance and cart combination should be moved with care. Quick stops, excessive force, and uneven surfaces may cause the appliance and cart combination to overturn.



**Antennas**

**Outdoor Antenna Grounding:** If an outside antenna or cable system is connected to the video product, be sure the antenna or cable system is grounded so as to provide some protection against voltage surges and built-up static charges. Section 810 of the National Electrical Code, ANSI/NFPA No. 70, provides information with respect to proper grounding of the mast and supporting structure, grounding of the lead-in wire to an antenna discharge unit, size of grounding conductors, location of antenna discharge unit, connection to grounding electrodes, and requirements for the grounding electrode.

*EXAMPLE OF ANTENNA GROUNDING AS PER NATIONAL ELECTRICAL CODE*

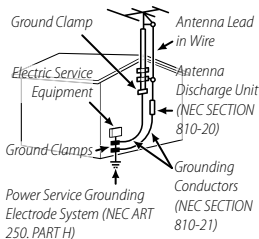

**Power Lines:** An outside antenna system should not be located in the vicinity of overhead power lines or other electric light or power circuits, or where it can fall into such power lines or circuits. When installing an outside antenna system, extreme care should be taken to keep from touching such power lines or circuits as contact with them might be fatal.

**Use**

**Cleaning:** Unplug this video product from the wall outlet before cleaning. Do not use liquid cleaners or aerosol cleaners. Use a damp cloth for cleaning.

**Object and Liquid Entry:** Never push objects of any kind into this video product through openings as they may touch dangerous voltage points or short out parts that could result in a fire or electric shock. Never spill liquid of any kind on the video product.

**Lightning:** For added protection for this video product receiver during a lightning storm, or when it is left unattended and unused for long periods of time, unplug it from the wall outlet and disconnect the antenna or cable system. This will prevent damage to the video product due to lightning and power-line surges.

**Service**

**Servicing:** Do not attempt to service this video product yourself as opening or removing covers may expose you to dangerous voltage or other hazards. Refer all servicing to qualified service personnel.

**Damage Requiring Service:** Unplug this video product from the wall outlet and refer servicing to qualified service personnel under the following conditions:

- When the power-supply cord or plug is damaged.
- If liquid has been spilled, or objects have fallen into the video product.
- If the video product has been exposed to rain or water.
- If the video product has been dropped or the cabinet has been damaged.

If the video product does not operate nor-

mally follow the operating instructions. Ad-just only those controls that are covered by the operating instructions as an improper adjustment of other controls may result in damage and will often require extensive work by a qualified technician to restore the video product to its normal operation.

When the video product exhibits a distinct change in performance—this indicates a need for service.

**Replacement Parts:** When replacement parts are required, be sure the service technician has used replacement parts specified by the manufacturer or have the same characteristics as the original part. Unauthorized substitutions may result in fire, electric shock or other hazards.

**Safety Check:** Upon completion of any service or repairs to this video product, ask the service technician to perform safety checks to determine that the video product is in proper operating condition.

**Be sure to read these notes before use**

**Safety Notes**

- Make sure that you use your camera correctly. Read these safety notes and your *Owner's Manual* carefully before use.
- After reading these safety notes, store them in a safe place.

**About the Icons**

The icons shown below are used in this document to indicate the severity of the injury or damage that can result if the information indicated by the icon is ignored and the product is used incorrectly as a result.



This icon indicates that death or serious injury can result if the information is ignored.



This icon indicates that personal injury or material damage can result if the information is ignored.

The icons shown below are used to indicate the nature of the instructions which are to be observed.



Triangular icons tell you that this information requires attention ("Important").



Circular icons with a diagonal bar tell you that the action indicated is prohibited ("Prohibited").



Filled circles with an exclamation mark indicate an action that must be performed ("Required").

**! WARNING**



***If a problem arises, turn the camera off, remove the battery, and disconnect and unplug the AC power adapter.*** Continued use of the camera when it is emitting smoke, is emitting any unusual odor, or is in any other abnormal state can cause a fire or electric shock. Contact your FUJIFILM dealer.



***Do not allow water or foreign objects to enter the camera.*** If water or foreign objects get inside the camera, turn the camera off, remove the battery, and disconnect and unplug the AC power adapter. Continued use of the camera can cause a fire or electric shock. Contact your FUJIFILM dealer.

**! WARNING**



***Do not use the camera in the bathroom or shower.*** This can cause a fire or electric shock.



***Never attempt to change or take apart the camera (never open the case).*** Failure to observe this precaution can cause fire or electric shock.



***Should the case break open as the result of a fall or other accident, do not touch the exposed parts.*** Failure to observe this precaution could result in electric shock or in injury from touching the damaged parts. Remove the battery immediately, taking care to avoid injury or electric shock, and take the product to the point of purchase for consultation.



***Do not change, heat or unduly twist or pull the connection cord and do not place heavy objects on the connection cord.*** These actions could damage the cord and cause a fire or electric shock. If the cord is damaged, contact your FUJIFILM dealer.



***Do not place the camera on an unstable surface.*** This can cause the camera to fall or tip over and cause injury.



***Never attempt to take pictures while in motion.*** Do not use the camera while you are walking or driving a vehicle. This can result in you falling down or being involved in a traffic accident.



***Do not touch any metal parts of the camera during a thunderstorm.*** This can cause an electric shock due to induced current from the lightning discharge.



***Do not use the battery except as specified.*** Load the battery as shown by the indicator.















***Do not heat, change or take apart the battery. Do not drop or subject the battery to impacts. Do not store the battery with metallic products.*** Any of these actions can cause the battery to burst or leak and cause fire or injury as a result.















***Use only the battery or AC power adapters specified for use with this camera. Do not use voltages other than the power supply voltage shown.*** The use of other power sources can cause a fire.



***If the battery leaks and fluid gets in contact with your eyes, skin or clothing, flush the affected area with clean water and seek medical attention or call an emergency number right away.***

 <b>WARNING</b>	
	<b>Do not use the charger to charge batteries other than those specified here.</b> The supplied battery charger is for use only with the type of battery supplied with the camera. Using the charger to charge conventional batteries or other types of rechargeable batteries can cause the battery to leak fluid, overheat or burst.
	<b>Danger of explosion if battery is incorrectly replaced. Replace only with the same or equivalent type.</b>
	<b>Do not use in the presence of flammable objects, explosive gases, or dust.</b>
	<b>When carrying the battery, install it in a digital camera or keep it in the hard case. When storing the battery, keep it in the hard case. When discarding, cover the battery terminals with insulation tape.</b> Contact with other metallic objects or batteries could cause the battery to ignite or burst.
	<b>Keep memory cards out of the reach of small children.</b> Because memory cards are small, they can be swallowed by children. Be sure to store memory cards out of the reach of small children. If a child swallows a memory card, seek medical attention or call an emergency number.
	<b>Turn the camera off in crowds.</b> The camera emits radio-frequency radiation that may interfere with pacemakers.
	<b>Turn the camera off in the vicinity of automatic doors, public address systems, and other automatically controlled devices.</b> The camera emits radio-frequency radiation that may cause these devices to malfunction.
	<b>Keep the camera at least 22 cm away from people wearing pacemakers.</b> The camera emits radio-frequency radiation that may interfere with pacemakers.
 <b>CAUTION</b>	
	<b>Do not use this camera in locations affected by oil fumes, steam, humidity or dust.</b> This can cause a fire or electric shock.
	<b>Do not leave this camera in places subject to extremely high temperatures.</b> Do not leave the camera in locations such as a sealed vehicle or in direct sunlight. This can cause a fire.
	<b>Keep out of the reach of small children.</b> This product could cause injury in the hands of a child.

 <b>CAUTION</b>	
	<b>Do not place heavy objects on the camera.</b> This can cause the heavy object to tip over or fall and cause injury.
	<b>Do not move the camera while the AC power adapter is still connected. Do not pull on the connection cord to disconnect the AC power adapter.</b> This can damage the power cord or cables and cause a fire or electric shock.
	<b>Do not use the AC power adapter when the plug is damaged or the plug socket connection is loose.</b> This could cause a fire or electric shock.
	<b>Do not cover or wrap the camera or the AC power adapter in a cloth or blanket.</b> This can cause heat to build up and distort the casing or cause a fire.
	<b>When you are cleaning the camera or you do not plan to use the camera for an extended period, remove the battery and disconnect and unplug the AC power adapter.</b> Failure to do so can cause a fire or electric shock.
	<b>When charging ends, unplug the charger from the power socket.</b> Leaving the charger plugged into the power socket can cause a fire.
	<b>Using a flash too close to a person's eyes may temporarily affect the eyesight.</b> Take particular care when photographing infants and young children.
	<b>When a memory card is removed, the card could come out of the slot too quickly. Use your finger to hold it and gently release the card.</b> Injury could result to those struck by the ejected card.
	<b>Request regular internal testing and cleaning for your camera.</b> Build-up of dust in your camera can cause a fire or electric shock. Contact your FUJIFILM dealer to request internal cleaning every two years. Please note that this service is not free of charge.
	<b>Remove your fingers from the flash window before the flash fires.</b> Failure to observe this precaution could result in burns.
	<b>Keep the flash window clean and do not use the flash if the window is obstructed.</b> Failure to observe these precautions could cause smoke or discoloration.

### The Battery and Power Supply

**Note:** Check the type of battery used in your camera and read the appropriate sections.

The following describes the proper use of batteries and how to prolong their life. Incorrect use can shorten battery life or cause leakage, overheating, fire, or explosion.

#### Li-ion Batteries

Read this section if your camera uses a rechargeable Li-ion battery.

The battery is not charged at shipment. Charge the battery before use. Keep the battery in its case when not in use.

#### Notes on the Battery

The battery gradually loses its charge when not in use. Charge the battery one or two days before use.

Battery life can be extended by turning the camera off when not in use.

Battery capacity decreases at low temperatures; a depleted battery may not function at when cold. Keep a fully charged spare battery in a warm place and exchange as necessary, or keep the battery in your pocket or other warm place and insert it in the camera only when shooting. Do not place the battery in direct contact with hand warmers or other heating devices.

#### Charging the Battery

Charge the battery in the supplied battery charger. Charging times will increase at ambient temperatures below +10°C (+50°F) or above +35°C (+95°F). Do not attempt to charge the battery at temperatures above 40°C (+104°F); at temperatures below 0°C (+32°F), the battery will not charge.

Do not attempt to recharge a fully charged battery. The battery does not however need to be fully discharged before charging.

The battery may be warm to the touch immediately after charging or use. This is normal.

#### Battery Life

At normal temperatures, the battery can be recharged about 300 times. A noticeable decrease in the length of time the battery will hold a charge indicates that it has reached the end of its service life and should be replaced.

#### Storage

Performance may be impaired if the battery is left unused for extended periods when fully charged. Run the battery flat before storing it.

If the camera will not be used for an extended period, remove the battery and store it in a dry place with an ambient temperature of from +15°C to +25°C (+59°F to +77°F). Do not store in locations exposed to extremes of temperature.

#### Cautions: Handling the Battery

- Do not transport or store with metal objects such as necklaces or hairpins.
- Do not expose to flame or heat.
- Do not disassemble or modify.
- Use with designated chargers only.
- Do not drop or subject to strong physical shocks.
- Do not expose to water.
- Keep the terminals clean.
- The battery and camera body may become warm to the touch after extended use. This is normal.

#### AA Alkaline/Rechargeable Ni-MH Batteries/ AA lithium batteries

Read this section if your camera uses AA alkaline or rechargeable AA Ni-MH batteries. Information on compatible battery types may be found elsewhere in the camera manual.

#### Cautions: Handling the Batteries

- Do not expose to water, flame, or heat, or store in warm or humid conditions.
- Do not transport or store with metal objects such as necklaces or hairpins.
- Do not disassemble or modify the batteries or battery casing.
- Do not subject to strong physical shocks.
- Do not use batteries that are leaking, deformed, or discolored.
- Keep out of reach of infants and small children.
- Insert in the correct orientation.

- Do not mix old and new batteries, batteries with different charge levels, or batteries of different types.
- If the camera will not be used for an extended period, remove the batteries. Note that the camera clock will be reset.
- The batteries may be warm to the touch immediately after use. Turn the camera off and allow the batteries to cool before handling.
- Battery capacity tends to decrease at low temperatures. Keep spare batteries in a pocket or other warm place and exchange as necessary. Cold batteries may recover some of their charge when warmed.
- Fingerprints and other stains on the battery terminals can impair battery performance. Thoroughly clean the terminals with a soft, dry cloth before inserting them in the camera.



If the batteries leak, clean the battery compartment thoroughly before inserting new batteries.



If fluid from the battery comes into contact with skin or clothing, flush the affected area with water. ***If fluid enters your eyes, immediately flush the affected area with water and seek medical attention. Do not rub your eyes. Failure to observe this precaution could result in permanent visual impairment.***

#### ■ Ni-MH Batteries

The capacity of Ni-MH batteries may be temporarily reduced when new, after long periods of disuse, or if they are repeatedly recharged before being fully discharged. This is normal and does not indicate a malfunction. Capacity can be increased by repeatedly discharging the batteries using the discharge option in the camera setup menu and recharging them using a battery charger.

ⓘ **CAUTION:** Do not use the discharge option with alkaline batteries.

The camera draws a small amount of current even when off. Ni-MH batteries that have been left in the camera for an extended period may be drawn down to the point that they no longer hold a charge. Battery performance may also drop if the batteries are run down in a device such as a flashlight. Use the discharge option in the camera setup menu to discharge Ni-MH batteries. Batteries that no longer hold a charge even after repeatedly being discharged and recharged have reached the end of their service life and must be replaced.

Ni-MH batteries can be recharged in a battery charger (sold separately). Batteries may become warm to the touch after charging. Refer to the instructions provided with the charger for more information. Use the charger with compatible batteries only.

Ni-MH batteries gradually lose their charge when not in use.

#### ■ Disposal

Dispose of used batteries in accord with local regulations.

#### AC Power Adapters (Available Separately)

***This section applies to all camera models.***

Use only FUJIFILM AC power adapters designated for use with this camera. Other adapters could damage the camera.

- The AC power adapter is for indoor use only.
- Be sure the DC plug is securely connected to the camera.
- Turn the camera off before disconnecting the adapter. Disconnect the adapter by the plug, not the cable.
- Do not use with other devices.
- Do not disassemble.
- Do not expose to high heat and humidity.
- Do not subject to strong physical shocks.
- The adapter may hum or become hot to the touch during use. This is normal.
- If the adapter causes radio interference, reorient or relocate the receiving antenna.

### Using the Camera

Do not aim the camera at extremely bright light sources, such as the sun in a cloudless sky. Failure to observe this precaution could damage the camera image sensor.

### Take Test Shots

Before taking photographs on important occasions (such as at weddings or before taking the camera on a trip), take a test shot and view the result in the LCD monitor to ensure that the camera is functioning normally. FUJIFILM Corporation can not accept liability for damages or lost profits incurred as a result of product malfunction.

### Notes on Copyright

Unless intended solely for personal use, images recorded using your digital camera system cannot be used in ways that infringe copyright laws without the consent of the owner. Note that some restrictions apply to the photographing of stage performances, entertainments, and exhibits, even when intended purely for personal use. Users are also asked to note that the transfer of memory cards containing images or data protected under copyright laws is only permissible within the restrictions imposed by those copyright laws.

### Handling

To ensure that images are recorded correctly, do not subject the camera to impact or physical shocks while images are being recorded.

### Liquid Crystal

In the event that the LCD monitor is damaged, care should be taken to avoid contact with liquid crystal. Take the urgent action indicated should any of the following situations arise:

- **If liquid crystal comes in contact with your skin**, clean the area with a cloth and then wash thoroughly with soap and running water.
- **If liquid crystal enters your eyes**, flush the affected eye with clean water for at least 15 minutes and then seek medical assistance.
- **If liquid crystal is swallowed**, rinse your mouth thoroughly with water. Drink large quantities of water and induce vomiting, then seek medical assistance.

Although the display is manufactured using extremely high-precision technology, it may contain pixels that are always lit or that do not light. This is not a malfunction, and images recorded with the product are unaffected.

### Trademark Information

*xD-Picture Card* and *xD* are trademarks of FUJIFILM Corporation. The typefaces included herein are solely developed by DynaComware Taiwan Inc. Macintosh, QuickTime, and Mac OS are trademarks of Apple Inc. in the U.S.A. and other countries. Windows 8, Windows 7, Windows Vista, and the Windows logo are trademarks of the Microsoft group of companies. Adobe and Adobe Reader are either trademarks or registered trademarks of Adobe Systems Incorporated in the U.S.A. and/or other countries. The SDHC and SDXC logos are trademarks of SD-3C, LLC. The HDMI logo is a trademark. YouTube is a trademark of Google Inc. All other trade names mentioned in this manual are the trademarks or registered trademarks of their respective owners.

### Electrical Interference

This camera may interfere with hospital or aviation equipment. Consult with hospital or airline staff before using the camera in a hospital or on an aircraft.

### Exif Print (Exif Version 2.3)

Exif Print is a newly revised digital camera file format in which information stored with photographs is used for optimal color reproduction during printing.

### IMPORTANT NOTICE: Read Before Using the Software

Direct or indirect export, in whole or in part, of licensed software without the permission of the applicable governing bodies is prohibited.



## About This Manual

Before using the camera, read this manual and the warnings in “For Your Safety” (📖 ii). For information on specific topics, consult the sources below.

### **Table of Contents** ..... 📖 xi

The “Table of Contents” gives an overview of the entire manual. The principal camera operations are listed here.

### **Troubleshooting** ..... 📖 105

Having a specific problem with the camera? Find the answer here.

### **Warning Messages and Displays** ... 📖 112

Find out what’s behind that flashing icon or error message in the display.

### ●● **Memory Cards**

Pictures can be stored in the camera’s internal memory or on optional SD, SDHC, and SDXC memory cards (📖 13), referred to in this manual as “memory cards.”

### ●● **Temperature Warning**

The camera will turn off automatically before its temperature or the temperature of the battery rise above safe limits. Pictures taken when a temperature warning is displayed may exhibit higher levels of “noise” (mottling). Turn the camera off and wait for it to cool before turning it on again.

## Frequently-Used Buttons

### ■ Turning the Camera on in Playback Mode

- ➔ When the camera is off, playback can be started by pressing the  button for about a second.



### ■ Taking Pictures During Playback

- ➔ To return instantly to shooting mode, press the shutter button halfway.

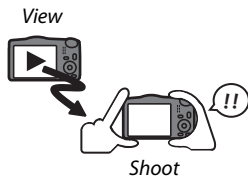

### ■ Deleting Pictures

- ➔ To delete a picture, display it full frame and press the selector up ().

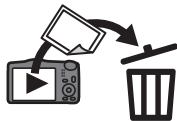

### ■ Silent Mode

- ➔ Press and hold the **DISP/BACK** button to disable camera lights and sounds.



# Table of Contents

For Your Safety .....	ii
IMPORTANT SAFETY INSTRUCTIONS .....	ii
Safety Notes .....	iv
About This Manual .....	ix
Frequently-Used Buttons .....	x

## Before You Begin

Symbols and Conventions .....	1
Supplied Accessories .....	1
Parts of the Camera .....	2
Camera Displays .....	4
Shooting .....	4
Playback .....	5











## First Steps











Charging the Battery .....	8
Inserting the Battery and a Memory Card .....	10
Compatible Memory Cards .....	13
Turning the Camera on and Off .....	15
Shooting Mode .....	15
Playback Mode .....	15
Basic Setup .....	17

## Basic Photography and Playback

Taking Pictures in  (EXR AUTO) Mode .....	18
Viewing Pictures .....	22

## More on Photography

Shooting Mode .....	23
<b>EXR</b> (EXR AUTO/EXR Priority) .....	24
 (EXR AUTO) .....	24
<b>EXR</b> Priority .....	25
<b>Adv.</b> ADVANCED .....	26
 ADVANCED FILTER .....	26
 MOTION PANORAMA 360 .....	27
 PRO FOCUS .....	29
 PRO LOW-LIGHT .....	30
 MULTIPLE EXPOSURE .....	31
<b>SP</b> SCENE POSITION .....	32
<b>P</b> PROGRAM AE .....	33
<b>S</b> SHUTTER PRIORITY AE .....	33
<b>A</b> APERTURE PRIORITY AE .....	34
<b>M</b> MANUAL .....	34
Focus Lock .....	35
 Exposure Compensation .....	37
 Macro Mode (Close-ups) .....	38
 Using the Flash (Super-Intelligent Flash) .....	39
 Using the Self-Timer .....	41

<b>The Fn Button</b> .....	42
<b>The E-Fn Button</b> .....	43
Using the E-Fn BUTTON CUSTOM SETTING Menu .....	43
 <b>Continuous Shooting</b> .....	45
 TOP n .....	46
 BEST FRAME CAPTURE .....	46
 AE BKT .....	48
 FILM SIMULATION BKT .....	48
 DYNAMIC RANGE BKT .....	48
 <b>Intelligent Face Detection</b> .....	49
<b>More on Playback</b>	
<b>Playback Options</b> .....	50
Continuous Shooting .....	51
★ Favorites: Rating Pictures .....	51
Playback Zoom .....	52
Multi-Frame Playback .....	53
 <b>Deleting Pictures</b> .....	54
 <b>Image Search</b> .....	55
 <b>PhotoBook Assist</b> .....	56
Creating a PhotoBook .....	56
Viewing Photobooks .....	57
Editing and Deleting Photobooks .....	57
<b>Viewing Panoramas</b> .....	58

















## Movies













<b>Recording Movies</b> .....	59
<b>Viewing Movies</b> .....	61















## Connections

<b>Viewing Pictures on High-Definition TVs</b> .....	62
<b>Printing Pictures via USB</b> .....	63
Printing the DPOF Print Order .....	65
<b>Viewing Pictures on a Computer</b> .....	67
Windows: Installing MyFinePix Studio .....	67
Connecting the Camera .....	70
Importing Pictures or Movies to Mac (Macintosh) .....	72

**Menus**

<b>Using the Menus: Shooting Mode</b> .....	73
Using the Shooting Menu.....	73
Shooting Menu Options .....	74
 <b>EXR</b> MODE .....	74
 Adv. MODE .....	74
 SCENE POSITION.....	74
 ISO.....	74
 IMAGE SIZE.....	75
 IMAGE QUALITY .....	76
 D-RNG DYNAMIC RANGE .....	76
 FILM SIMULATION .....	77
 <b>WB</b> WHITE BALANCE .....	78
 CONTINUOUS.....	79
 ADVANCED ANTI BLUR .....	79
 FACE DETECTION .....	79
 PHOTOMETRY .....	79
 FOCUS MODE.....	80
 <b>Fn</b> BUTTON .....	80
 <b>E-Fn</b> E-Fn BUTTON CUSTOM SETTING.....	80
 MOVIE SET-UP .....	81

<b>Using the Menus: Playback Mode</b> .....	83
Using the Playback Menu.....	83
Playback Menu Options.....	84
 PHOTOBOOK ASSIST.....	84
 IMAGE SEARCH .....	84
 ERASE .....	84
 MARK FOR UPLOAD TO .....	85
 SLIDE SHOW .....	86
 RED EYE REMOVAL .....	86
 PROTECT.....	87
 CROP.....	87
 RESIZE.....	88
 IMAGE ROTATE .....	88
 COPY .....	89
 PRINT ORDER (DPOF).....	90
 DISP ASPECT .....	90

<b>The Setup Menu</b> .....	91
Using the Setup Menu .....	91
Setup Menu Options .....	92
 DATE/TIME .....	92
 TIME DIFFERENCE .....	92
 言語/LANG .....	92
 RESET .....	92
 SILENT MODE .....	93
 SOUND SET-UP .....	93
 SCREEN SET-UP .....	94
 POWER MANAGEMENT .....	95
 IS MODE .....	96
 RED EYE REMOVAL .....	96
 INTELLIGENT DIGITAL ZOOM .....	97
 AF ILLUMINATOR .....	97
 SAVE DATA SET-UP .....	98
 Eye-Fi TRANSFER .....	100
 FORMAT .....	100

## Technical Notes

<b>Optional Accessories</b> .....	101
Accessories from FUJIFILM .....	102
<b>Caring for the Camera</b> .....	103
Storage and Use .....	103
Cleaning .....	104
Traveling .....	104

## Troubleshooting

<b>Problems and Solutions</b> .....	105
<b>Warning Messages and Displays</b> .....	112

## Appendix

<b>Memory Card Capacity</b> .....	116
<b>Specifications</b> .....	117

# Before You Begin

## Symbols and Conventions

The following symbols are used in this manual:

- ⓘ : This information should be read before use to ensure correct operation.
- 📌 : Additional information that may be helpful when using the camera.
- 📖 : Other pages in this manual on which related information may be found.

Menus and other text in the displays are shown in **bold**. In the illustrations in this manual, displays may be simplified for explanatory purposes.

## Supplied Accessories

The following items are included with the camera:



NP-50A Rechargeable battery

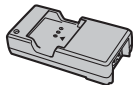

BC-50B battery charger



Plug adapter\*

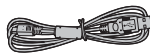

USB cable



CD-ROM  
(contains this manual)

- Strap
- Basic Manual

### Attaching the Strap

Attach the strap as shown.

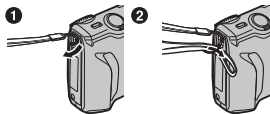

\* Shape of adapter varies with region of sale.

## Parts of the Camera

For more information, refer to the page listed to the right of each item.

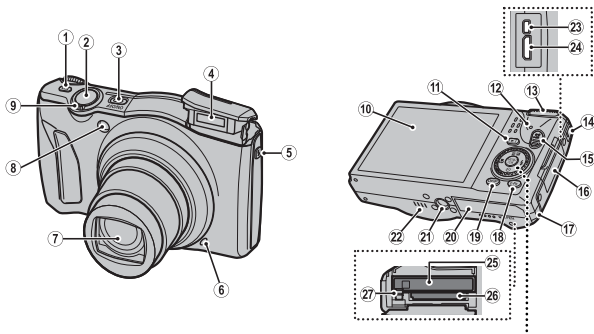

### Selector button

#### Move cursor up

☒ (exposure compensation) button (📖 37)

🗑️ (delete) button (📖 x)

MENU/OK button

#### Move cursor left

🌸 (macro) button (📖 38)

#### Move cursor right

⚡ (flash) button (📖 39)



#### Command dial

#### Move cursor down

🕒 (self-timer) button (📖 41)

\* The illustrations in this manual have been simplified for explanatory purposes.



<b>1</b> Fn (function) button .....	42	<b>15</b>  (movie recording) button .....	59
<b>2</b> Shutter button .....	20	<b>16</b> Terminal cover.....	62, 63, 70
<b>3</b> <b>ON/OFF</b> button .....	15	<b>17</b> DC coupler cable cover .....	102
<b>4</b> Flash .....	39	<b>18</b> <b>E-Fn</b> (extended function) button .....	43
<b>5</b> Flash pop-up button .....	39	Monitor sunlight mode <sup>1</sup> .....	7
<b>6</b> Microphone.....	59	<b>19</b> <b>DISP</b> (display)/ <b>BACK</b> button.....	6, 17
<b>7</b> Lens and lens cover		 (silent mode) button <sup>2</sup> .....	x
<b>8</b> AF-assist illuminator .....	97	<b>20</b> Battery-chamber cover .....	10
Self-timer lamp.....	41	<b>21</b> Tripod mount	
<b>9</b> Zoom control.....	19, 52	<b>22</b> Speaker.....	61
<b>10</b> LCD monitor .....	4	<b>23</b> USB multi-connector.....	63, 70
<b>11</b>  (playback) button.....	22, 50	<b>24</b> Connector for HDMI cable.....	62
<b>12</b> Indicator lamp (see below)		<b>25</b> Battery chamber .....	10
<b>13</b> Mode dial.....	23	<b>26</b> Memory card slot .....	11
<b>14</b> Strap eyelet.....	1	<b>27</b> Battery latch .....	10, 12

1 Press and hold the **E-Fn** button for monitor sunlight mode.

2 Press and hold the **DISP/BACK** button until  is displayed.

## The Indicator Lamp

The indicator lamp shows camera status as follows:

Indicator lamp	Camera status
Glows green	Focus locked.
Blinks green	Blur, focus, or exposure warning. Picture can be taken.
Blinks green and orange	Recording pictures. Additional pictures can be taken.
Glows orange	Recording pictures. No additional pictures can be taken at this time.
Blinks orange	Flash charging; flash will not fire when picture is taken.
Blinks red	Lens or memory error.

## Camera Displays

The following types of indicator may be displayed during shooting and playback. Indicators vary with camera settings.

### Shooting

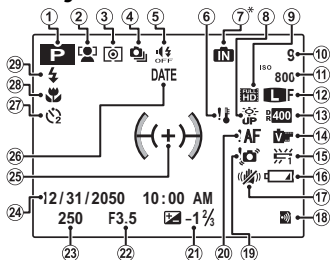

11	Sensitivity .....	74
12	Image size/quality .....	75, 76
13	Dynamic range .....	76
14	Film simulation .....	77
15	White balance .....	78
16	Battery level .....	7
17	IS Mode .....	96
18	Eye-Fi upload .....	100
19	Blur warning .....	40, 112
20	Focus warning .....	20, 112
21	Exposure compensation .....	37
22	Aperture .....	34
23	Shutter speed .....	33, 34
24	Date and time .....	17
25	Focus frame .....	35
26	Date stamp .....	99
27	Self-timer indicator .....	41
28	Macro (close-up) mode .....	38
29	Flash mode .....	39

1	Shooting mode .....	23
2	Intelligent Face Detection indicator .....	49
3	Metering .....	79
4	Continuous shooting mode .....	45
5	Silent mode indicator .....	x, 93
6	Temperature warning .....	ix, 113
7	Internal memory indicator*	
8	Monitor sunlight mode .....	7
9	Movie mode .....	81
10	Number of available frames .....	116

\* **IN**: indicates that no memory card is inserted and that pictures will be stored in the camera's internal memory (📄 11).

## ■ Playback

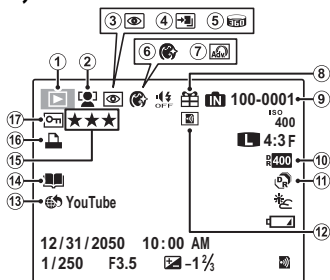

1	Playback mode indicator .....	22, 50
2	Intelligent Face Detection indicator .....	49, 79
3	Red-eye removal indicator .....	86
4	Pro focus mode, pro low-light mode .....	29, 30
5	Motion panorama .....	27, 58
6	Portrait enhancer .....	32
7	Advanced filter .....	26
8	Gift image .....	50
9	Frame number .....	98
10	Dynamic range .....	76
11	<b>EXR</b> mode .....	24
12	Eye-Fi upload complete .....	100
13	Mark for upload to .....	85
14	Photobook assist .....	56
15	Favorites .....	51
16	DPOF print indicator .....	65
17	Protected image .....	87

## Hiding and Viewing Indicators

Press **DISP/BACK** to cycle through shooting and playback indicators as follows:

- **Shooting:** Indicators displayed/indicators hidden/best framing/HD framing/histogram
- **Playback:** Indicators displayed/indicators hidden/★ favorites (🗨️ 51)/photo info

## Photo Info

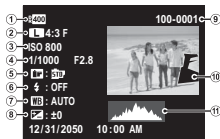

- ① Dynamic range
- ② Image size and quality
- ③ Sensitivity
- ④ Shutter speed/aperture
- ⑤ Film simulation
- ⑥ Flash mode
- ⑦ White balance
- ⑧ Exposure compensation
- ⑨ Frame number
- ⑩ Picture (overexposed areas blink on and off)
- ⑪ Histogram

Histograms show the distribution of tones in the image. Brightness is shown by the horizontal axis, the number of pixels by the vertical axis.

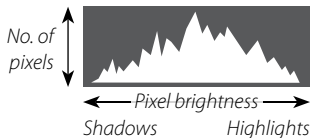

**Optimal exposure:** Pixels are distributed in an even curve throughout the tone range.





**Overexposed:** Pixels are clustered on the right side of the graph.

**Underexposed:** Pixels are clustered on the left side of the graph.





### **Battery Level**

Battery level is shown as follows:

Indicator	Description
 (white)	Battery partially discharged.
 (white)	Battery more than half discharged.
 (red)	Low battery. Charge as soon as possible.
 (blinks red)	Battery exhausted. Charge battery.

### **Bright Ambient Lighting**

Reflections and glare caused by bright ambient lighting may make it hard to see the display in the monitor, particularly when the camera is used outdoors. This can be addressed by holding the **E-Fn** button to trigger outdoor mode. Outdoor mode can also be enabled using the  **SCREEN SET-UP > MONITOR SUNLIGHT MODE** option ( 94).

# First Steps

## Charging the Battery

The battery is not charged at shipment. Charge the battery before use.

### 1 Attach the plug adapter.

Attach the plug adapter as shown, making sure that it is fully inserted and clicks into place on the charger terminals.

- ⓘ The plug adapter is exclusively for use with the supplied battery charger. Do not use it with other devices.

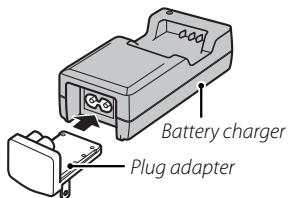

### 2 Place the battery in the supplied battery charger.

Insert the battery in the orientation indicated by the  $\ominus \downarrow \oplus$  labels.

The camera uses an NP-50A rechargeable battery.

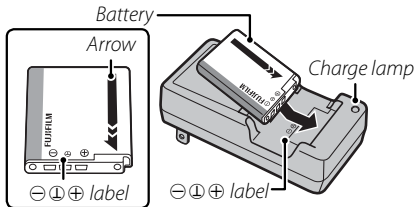

### 3 Plug the charger in.

Plug the charger into an indoor power outlet. The charging indicator will light.



#### The Charging Indicator

The charging indicator shows battery charge status as follows:

Charging indicator	Battery status	Action
Off	Battery not inserted.	Insert the battery.
	Battery fully charged.	Remove the battery.
On	Battery charging.	—
Blinks	Battery fault.	Unplug the charger and remove the battery.

### 4 Charge the battery.

Remove the battery when charging is complete. See the specifications (📖 121) for charging times (note that charging times increase both at high temperatures and at low temperatures).

- ⓘ Unplug the charger when it is not in use.

## Inserting the Battery and a Memory Card

Although the camera can store pictures in internal memory, optional SD, SDHC, and SDXC *memory cards* (sold separately) can be used to store additional pictures. After charging the battery, insert the battery and memory card as described below.

### 1 Open the battery-chamber cover.

- ◆ Be sure the camera is off before opening the battery-chamber cover.
- ⓘ Do not open the battery-chamber cover when the camera is on. Failure to observe this precaution could result in damage to image files or memory cards.
- ⓘ Do not use excessive force when handling the battery-chamber cover.

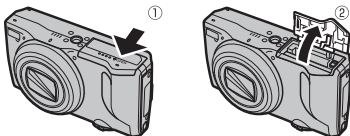

### 2 Insert the battery.

Align the orange stripe on the battery with the orange battery latch and slide the battery into the camera, keeping the battery latch pressed to one side. Confirm that the battery is securely latched.

- ⓘ Insert the battery in the correct orientation. **Do not use force or attempt to insert the battery upside down or backwards.** The battery will slide in easily in the correct orientation.

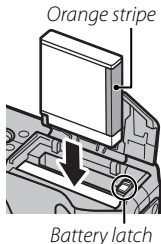



### 3 Insert the memory card.

Holding the memory card in the orientation shown at right, slide it in until it clicks into place at the back of the slot.

- ① Be sure card is in the correct orientation; do not insert at an angle or use force. If the memory card is not correctly inserted or no memory card is inserted, **IN** will appear in the LCD monitor and internal memory will be used for recording and playback.
- ① SD/SDHC/SDXC memory cards can be locked, making it impossible to format the card or to record or delete images. Before inserting an SD/SDHC/SDXC memory card, slide the write-protect switch to the unlocked position.

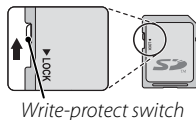
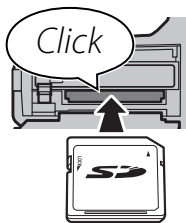

### 4 Close the battery-chamber cover.

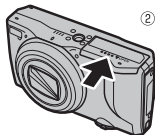
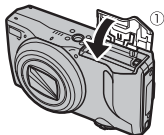

### ◆ Using an AC Power Adapter

- The camera can be powered by an optional AC power adapter and DC coupler (sold separately). See the manuals provided with the AC power adapter and DC coupler for details.
- Depending on the country or region of sale, a demo mode slide show may start if the camera is turned on while powered by an AC power adapter. Press the shutter button to end the show.

### ●● Removing the Battery and Memory Card

Before removing the battery or memory card, **turn the camera off** and open the battery-chamber cover.

To remove the battery, press the battery latch to the side, and slide the battery out of the camera as shown.

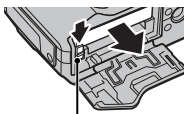

Battery latch

To remove the memory card, press it in and release it slowly. The card can then be removed by hand. When a memory card is removed, the card could come out of the slot too quickly. Use your finger to hold it and gently release the card.

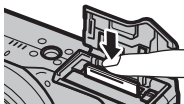

## ■ Compatible Memory Cards

FUJIFILM and SanDisk SD, SDHC, and SDXC memory cards have been approved for use in the camera. A complete list of approved memory cards is available at [http://www.fujifilm.com/support/digital\\_cameras/compatibility/](http://www.fujifilm.com/support/digital_cameras/compatibility/). Operation is not guaranteed with other cards. The camera can not be used with *xD-Picture Cards* or MultiMediaCard (MMC) devices.

### ⓘ Memory Cards

- *Do not turn the camera off or remove the memory card while the memory card is being formatted or data are being recorded to or deleted from the card.* Failure to observe this precaution could damage the card.
- Format SD/SDHC/SDXC memory cards before first use, and be sure to reformat all memory cards after using them in a computer or other device. For more information on formatting memory cards, see “ **FORMAT**” (📖 100).
- Memory cards are small and can be swallowed; keep out of reach of children. If a child swallows a memory card, seek medical assistance immediately.
- miniSD or microSD adapters that are larger or smaller than the standard dimensions of an SD/SDHC/SDXC card may not eject normally; if the card does not eject, take the camera to an authorized service representative. Do not forcibly remove the card.
- Do not affix labels to memory cards. Peeling labels can cause camera malfunction.
- Movie recording may be interrupted with some types of SD/SDHC/SDXC memory card. Use a **CLASS 10** card or better when shooting HD or high-speed movies.

- The data in internal memory may be erased or corrupted when the camera is repaired. Please note that the repairer will be able to view pictures in internal memory.
- Formatting a memory card or internal memory in the camera creates a folder in which pictures are stored. Do not rename or delete this folder or use a computer or other device to edit, delete, or rename image files. Always use the camera to delete pictures from memory cards and internal memory; before editing or renaming files, copy them to a computer and edit or rename the copies, not the originals.

### ⓘ **Batteries**

- Remove dirt from the battery terminals with a clean, dry cloth. Failure to observe this precaution could prevent the battery from charging.
- Do not affix stickers or other objects to the battery. Failure to observe this precaution could make it impossible to remove the battery from the camera.
- Do not short the battery terminals. The battery could overheat.
- Read the cautions in “The Battery and Power Supply” (📖 vi).
- Use only battery chargers designated for use with the battery. Failure to observe this precaution could result in product malfunction.
- Do not remove the labels from the battery or attempt to split or peel the outer casing.
- The battery gradually loses its charge when not in use. Charge the battery one or two days before use.

## Turning the Camera on and Off

### **Shooting Mode**

Press the **ON/OFF** button to turn the camera on. The lens will extend automatically.

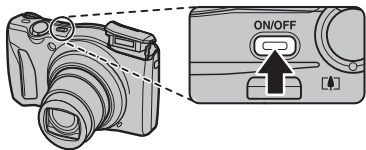

Press **ON/OFF** again to turn the camera off.

### ◆ **Switching to Playback Mode**

Press the  button to start playback. Press the shutter button halfway to return to shooting mode.

### **Playback Mode**

To turn the camera on and begin playback, press the  button for about a second.

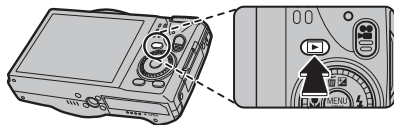

Press the  button again or press the **ON/OFF** button to turn the camera off.

### ◆ **Switching to Shooting Mode**



To exit to shooting mode, press the shutter button halfway. Press the  button to return to playback.

- ⓘ Forcibly obstructing the lens could cause damage or product malfunction.
- ⓘ Fingerprints and other marks on the lens can affect pictures. Keep the lens clean.
- ⓘ The **ON/OFF** button does not completely end the supply of power to the camera.

### 🔍 **Auto Power Off**

The camera will turn off automatically if no operations are performed for the length of time selected for  **POWER MANAGEMENT > AUTO POWER OFF** (📖 95).

## Basic Setup

A language-selection dialog is displayed the first time the camera is turned on. Set up the camera as described below (you can reset the clock or change languages at any time using the  **DATE/TIME** or  **言語/LANG.** options in the setup menu; for information on displaying the setup menu, see page 92).

### 1 Highlight a language and press **MENU/OK**.

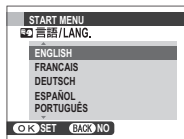

- ◆ Press **DISP/BACK** to skip the current step. Any steps you skip will be displayed the next time the camera is turned on.

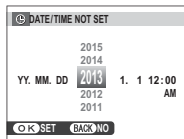

### 2 The date and time will be displayed. Press the selector left or right to highlight the year, month, day, hour, or minute and press up or down to change. To change the order in which the year, month, and day are displayed, highlight the date format and press the selector up or down. Press **MENU/OK** when settings are complete.



### 3 Power management options will be displayed. Press the selector up or down to highlight one of the following options and then press **MENU/OK**:

-  **POWER SAVE**: Save battery power.
-  **CLEAR DISPLAY**: Choose for a brighter, higher quality display.

#### ◆ The Camera Clock

If the battery is removed for an extended period, the camera clock will be reset and the language-selection dialog will be displayed when the camera is turned on.

# Basic Photography and Playback

## Taking Pictures in **EXR AUTO** (**EXR AUTO**) Mode

This section describes how to take pictures in **EXR AUTO** (**EXR AUTO**) mode.

### 1 Select **EXR** mode.

Turn the camera on and rotate the mode dial to **EXR**. The **EXR AUTO** display will appear in the LCD monitor.



#### The Icon

In **EXR AUTO** mode, the camera continuously adjusts focus and searches for faces, increasing the drain on the battery.  is displayed in the LCD monitor.



#### Scene Icon ( 24)

The camera automatically selects the appropriate scene.

- ◆ The camera analyses the scene and selects the preferred **EXR** mode when the shutter button is pressed halfway ( 25).
- ◆ To raise the flash when lighting is poor, press the flash pop-up button ( 39).



## 2 Frame the picture.

Use the zoom control to frame the picture in the display.

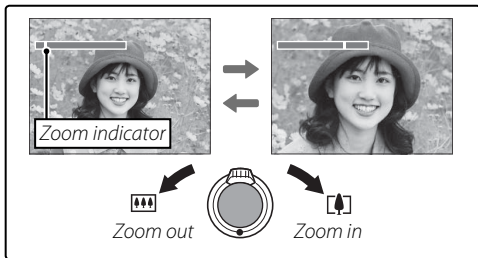

### Holding the Camera

Hold the camera steady with both hands and brace your elbows against your sides. Shaking or unsteady hands can blur your shots.

To prevent pictures that are out of focus or too dark (underexposed), keep your fingers and other objects away from the lens and flash.

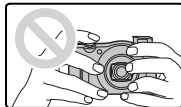
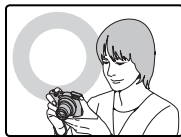

### 3 Focus.

Press the shutter button halfway to focus.

- ◆ The lens may make a noise when the camera focuses; this is normal. If the subject is poorly lit, the AF-assist illuminator may light; see “AF AF ILLUMINATOR” (📖 97) for information on disabling the illuminator.

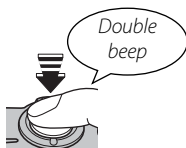

**If the camera is able to focus**, it will beep twice and the indicator lamp will glow green.

**If the camera is unable to focus**, the focus frame will turn red, **!AF** will be displayed, and the indicator lamp will blink green. Change the composition or use focus lock (📖 35).

## 4 Shoot.

Smoothly press the shutter button the rest of the way down to take the picture.



### **The Shutter Button**

The shutter button has two positions. Pressing the shutter button halfway sets focus and exposure; to shoot, press the shutter button the rest of the way down.

## Viewing Pictures

Pictures can be viewed in the LCD monitor. When taking important photographs, take a test shot and check the results.

### 1 Press the button.

The most recent picture will be displayed.

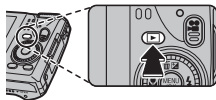

### 2 View additional pictures.

Press the selector right to view pictures in the order recorded, left to view pictures in reverse order.

Press the shutter button to exit to shooting mode.

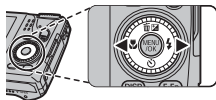

# More on Photography

## Shooting Mode

Choose a shooting mode according to the scene or type of subject. To select a shooting mode, align the mode icon with the mark next to the mode dial.

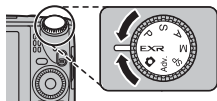

**P:** Automatic mode with programmed setting (📖 33).

**EXR:** Improve clarity, reduce noise, increase dynamic range, or let the camera automatically adjust settings to suit the scene (📖 24).

**📷 (AUTO):** A simple “point-and-shoot” mode recommended for first-time users of digital cameras.

**M, A, S:** Select for full control over camera settings (📖 34), including aperture (**M** and **A**) and/or shutter speed (**M** and **S**).

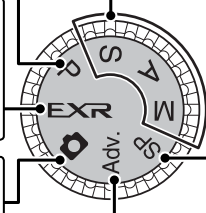

**SP (SCENE POSITION):** Choose a scene suited to the subject or shooting conditions and let the camera do the rest (📖 32).

**Adv. (ADVANCED):** Sophisticated techniques made easy (📖 26).

**EXR (EXR AUTO/EXR Priority)**

Optimize settings for your current subject or improve clarity, reduce noise, or enhance dynamic range. Rotate the mode dial to **EXR** and choose one of the following **EXR** modes in the shooting menu.

**EXR AUTO (EXR AUTO)**

The camera automatically selects the scene and **EXR** mode according to shooting conditions (📖 18).

- ❖ If **AUTO** is selected for **IMAGE SIZE** in **EXR AUTO** mode, the camera will automatically select the optimal image size.
- ❖ **INTELLIGENT DIGITAL ZOOM** is restricted to 2× (📖 97).



Scene icon

**The Scene Icon**

The camera selects from the following scenes:



Scene		AUTO	LAND-SCAPE	NIGHT	NIGHT (TRIPOD)	MACRO	BEACH	SUNSET	SNOW	SKY	GREENERY	SKY & GREENERY
<b>Main subject</b>		☉*	☀	☾*	☾	☺*	☺	☺	☺	☺	☺	☺
<b>Non-portrait</b>		☉*	☀	☾*	☾	☺*	☺	☺	☺	☺	☺	☺
<b>Portrait</b>	<b>Normal</b>	☉	☀☺	☾☺	☾☺	—	☺☺	☺☺	☺☺	☺☺	☺☺	☺☺
	<b>Backlit</b>	☉	☀☺	—	—	—	☺☺	☺☺	☺☺	☺☺	☺☺	☺☺
<b>Moving object</b>		☉*	☀☺	☾☺*	☾☺	☺☺*	☺☺	☺☺	☺☺	☺☺	☺☺	☺☺
<b>Portrait and motion</b>	<b>Normal</b>	☉	☀☺	☾☺	☾☺	—	☺☺	☺☺	☺☺	☺☺	☺☺	☺☺
	<b>Backlit</b>	☉	☀☺	—	—	—	☺☺	☺☺	☺☺	☺☺	☺☺	☺☺

\* If ☉ is displayed, the camera will take a series of shots (advanced anti-blur; 📖 25).

- ① The mode selected may vary with shooting conditions. If the mode and subject do not match, select **📷** mode (📖 23) or choose **SP** (📖 32) and select a scene manually.



### **Advanced Anti Blur**

When  is displayed, the camera will take a series of exposures and combine them to form a single image, reducing “noise” (mottling) and blur.

- ◆  is available when **ON** is selected for  **ADVANCED ANTI BLUR** (📖 79) and the flash (📖 39) is off or set to auto.
- ⓐ Some time may be required to combine the exposures into a single image. A single combined image may not be created if the subject or camera moves during shooting. Keep the camera steady during shooting and do not move the camera until shooting is complete.







### *The **EXR** Icon*

When the shutter button is pressed halfway, the camera chooses the preferred **EXR** mode:

-  (**RESOLUTION PRIORITY**): Produces crisp, clear shots.
-  (**HIGH ISO & LOW NOISE**): Reduces noise in pictures taken at high sensitivities.
-  (**D-RANGE PRIORITY**): Increases the amount of detail visible in highlights.

### ■ **EXR** Priority

Select this mode to manually choose from the following **EXR** modes:













-  (**RESOLUTION PRIORITY**): Choose for crisp, clear shots.
  -  (**HIGH ISO & LOW NOISE**): Reduce noise in pictures taken at high sensitivities.
  -  (**D-RANGE PRIORITY**): Increase the amount of detail visible in highlights.
-  **DYNAMIC RANGE** (📖 76) can be set to  **1600** (1600%) and  **800** (800%).

**Adv. *ADVANCED***

This mode combines “point-and-shoot” simplicity with sophisticated photographic techniques. The  **Adv. MODE** option can be used to choose from the following advanced modes:

** *ADVANCED FILTER***

Take photos with filter effects. Choose from the following filters.

Filter	Description
 <b>TOY CAMERA</b>	Choose for a retro toy camera effect.
 <b>MINIATURE</b>	The tops and bottoms of pictures are blurred for a diorama effect.
 <b>POP COLOR</b>	Create high-contrast images with saturated colors.
 <b>HIGH-KEY</b>	Create bright, low-contrast images.
 <b>LOW-KEY</b>	Create uniformly dark tones with few areas of emphasized highlights.
 <b>DYNAMIC TONE</b>	Dynamic tone expression is used for a fantasy effect.
 <b>SOFT FOCUS</b>	Create a look that is evenly soft throughout the whole image.
 <b>PARTIAL COLOR (RED)</b>	Areas of the image that are the selected color are recorded in that color. All others areas of the image are recorded in black-and-white.
 <b>PARTIAL COLOR (ORANGE)</b>	
 <b>PARTIAL COLOR (YELLOW)</b>	
 <b>PARTIAL COLOR (GREEN)</b>	
 <b>PARTIAL COLOR (BLUE)</b>	
 <b>PARTIAL COLOR (PURPLE)</b>	

-  Depending on the subject and camera settings, images may in some cases be grainy or vary in brightness and hue.



## ■ MOTION PANORAMA 360

Follow an on-screen guide to take photos that will automatically be joined to form a panorama. The camera zooms all the way out and remains fixed at the widest angle until shooting is complete.



- 1 To select the angle through which you will pan the camera while shooting, press the selector down. Press the selector left or right to highlight an angle and press **MENU/OK**.
- 2 Press the selector right to view a choice of pan directions. Press the selector left or right to highlight a pan direction and press **MENU/OK**.
- 3 Press the shutter button all the way down to start recording. There is no need to keep the shutter button pressed during recording.
- 4 Pan the camera in the direction shown by the arrow. Shooting ends automatically when the progress bar is full and the panorama is complete.

- ◆ Shooting ends if the shutter button is pressed all the way down during shooting. No panorama will be recorded if the shutter button is pressed before the camera has been panned through 120°.

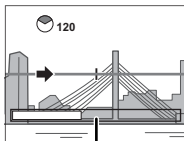

*Progress bar*

- ① Panoramas are created from multiple frames. The camera may in some cases record an greater or lesser angle than selected or be unable to stitch the frames together perfectly. The last part of the panorama may not be recorded if shooting ends before the panorama is complete.
- ① Shooting may be interrupted if the camera is panned too quickly or too slowly. Panning the camera in a direction other than that shown cancels shooting.
- ① The desired results may not be achieved with moving subjects, subjects close to the camera, unvarying subjects such as the sky or a field of grass, subjects that are in constant motion, such as waves and waterfalls, or subjects that undergo marked changes in brightness. Panoramas may be blurred if the subject is poorly lit.



Choose  for seamless 360° panoramas that can be played back in a loop (📖 58).

◆ The  **SAVE DATA SET-UP > SAVE ORG IMAGE** option can be used to record a  panorama in addition to a seamless  panorama (📖 98).

- ① Depending on the subject and shooting conditions, the camera may produce distorted results or a  panorama. The top and bottom of the area visible in the shooting display are cropped out and white strips may appear at the top and bottom of the display.

### **For Best Results**

For best results, move the camera in a small circle at a steady speed, keeping the camera horizontal and being careful only to pan in the direction shown by the guides. If the desired results are not achieved, try panning at a different speed.

## ■ PRO FOCUS

The camera takes up to three shots each time the shutter button is pressed, softening the background to emphasize the main subject. The amount of softening can be adjusted before shooting by pressing the selector left or right. Use for portraits or photos of flowers similar to those produced by SLR cameras.



- ◆ Softening can not be applied to background objects that are too close to the main subject. If a message stating that the camera can not create the effect is displayed when the camera focuses, try backing away from your subject and zooming in. The camera may also be unable to soften the background if the subject is moving; if prompted, check the results and try again.
- ⓘ Frame coverage is reduced.

## ■ PRO LOW-LIGHT

Each time the shutter button is pressed, the camera makes four exposures and combines them into a single photograph. Use to reduce noise and blur when photographing poorly lit subjects or static subjects at high zoom ratios.



- ◆ A single combined photograph may not be created with some scenes or if the subject or camera moves during shooting. Do not move the camera until shooting is complete.

### PRO FOCUS/PRO LOW-LIGHT

To save unprocessed copies of pictures taken in these modes, select **ON** for  **SAVE DATA SET-UP > SAVE ORG IMAGE** (📖 98).

- ① Keep the camera steady during shooting.

## ■ MULTIPLE EXPOSURE

Create a photograph that combines two exposures.

















- 1 Take the first shot.
- 2 Press **MENU/OK**. The first shot will be shown superimposed on the view through the lens as a guide to taking the second shot.
  - ◆ To return to Step 1 and retake the first shot, press the selector left. To save the first shot and exit without creating a multiple exposure, press **DISP/BACK**.
- 3 Take the second shot.
- 4 Press **MENU/OK** to create the multiple exposure, or press the selector left to return to Step 3 and retake the second shot.

**SP SCENE POSITION**

The camera offers a choice of “scenes,” each adapted to particular shooting conditions or a specific type of subject. Use the  **SCENE POSITION** option to choose the scene assigned to the **SP** position on the mode dial.



Scene	Description
 <b>PORTRAIT</b>	Choose for portraits.
 <b>PORTRAIT ENHANCER</b>	Choose for a smooth skin effect when shooting portraits.
 <b>LANDSCAPE</b>	Choose for daylight shots of buildings and landscapes.
 <b>SPORT</b>	Choose when photographing moving subjects.
 <b>NIGHT</b>	Choose this mode for poorly lit twilight or night scenes.
 <b>NIGHT (TRIPOD)</b>	Choose this mode for slow shutter speeds when shooting at night.
 <b>FIREWORKS</b>	Slow shutter speeds are used to capture the expanding burst of light from a firework.
 <b>SUNSET</b>	Choose this mode to record the vivid colors in sunrises and sunsets.
 <b>SNOW</b>	Choose for crisp, clear shots that capture the brightness of scenes dominated by shining white snow.
 <b>BEACH</b>	Choose for crisp, clear shots that capture the brightness of sunlit beaches.
 <b>UNDERWATER</b>	Reduces the blue cast typically associated with underwater lighting.
 <b>PARTY</b>	Capture indoor background lighting under low-light conditions.
 <b>FLOWER</b>	Choose for vivid close-ups of flowers.
 <b>TEXT</b>	Take clear pictures of text or drawings in print.

**P PROGRAM AE**

The camera sets exposure automatically.



- ⓘ If the subject is outside the metering range of the camera, the shutter speed and aperture displays will show "----". Press the shutter button halfway to measure exposure again.

**S SHUTTER PRIORITY AE**

You choose the shutter speed using the command dial, while the camera adjusts aperture for optimal exposure.



- ⓘ If the correct exposure can not be achieved at the selected shutter speed, aperture will be displayed in red. Adjust shutter speed until the correct exposure is achieved. If the subject is outside the metering range of the camera, the aperture display will show "F---". Press the shutter button halfway to measure exposure again.

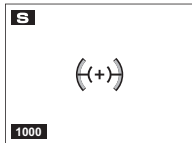

**A APERTURE PRIORITY AE**

You choose the aperture using the command dial, while the camera adjusts shutter speed for optimal exposure.

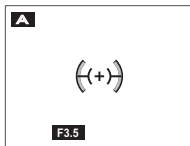

- ① If the correct exposure can not be achieved at the selected aperture, shutter speed will be displayed in red. Adjust aperture until the correct exposure is achieved. If the subject is outside the metering range of the camera, the shutter speed display will show “---”. Press the shutter button halfway to measure exposure again.

**M MANUAL**

In this mode, you control both shutter speed and aperture.



Press the selector up (☒) to highlight shutter speed or aperture and use the command dial to adjust the highlighted item. If desired, exposure can be altered from the value selected by the camera.

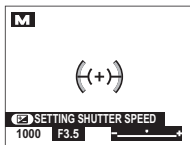

### **The Exposure Indicator**

The amount the picture will be under- or over-exposed at current settings is shown by the exposure indicator.





## Focus Lock

To compose photographs with off-center subjects:

**1 Focus:** Position the subject in the focus frame (⊕) and press the shutter button halfway to lock focus and exposure. Focus and exposure will remain locked while the shutter button is pressed halfway (AF/AE lock).



**2 Recompose:** Keep the button pressed halfway.



**3 Shoot:** Press the button all the way down.



### Autofocus

Although the camera boasts a high-precision autofocus system, it may be unable to focus on the subjects listed below. If the camera is unable to focus, focus on another subject at the same distance and use focus lock to recompose the photograph.

- Very shiny subjects such as mirrors or car bodies.
- Fast-moving subjects.
- Subjects photographed through a window or other reflective object.
- Dark subjects and subjects that absorb rather than reflect light, such as hair or fur.
- Insubstantial subjects, such as smoke or flame.
- Subjects that show little contrast with the background (for example, subjects in clothing that is the same color as the background).
- Subjects positioned in front of or behind a high-contrast object that is also in the focus frame (for example, a subject photographed against a backdrop of highly contrasting elements).

## Exposure Compensation

To adjust exposure compensation when photographing very bright, very dark, or high-contrast subjects, press the selector up () . Press the selector up or down or use the command dial to choose an exposure compensation value and then press **MENU/OK**.

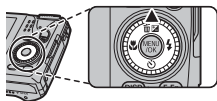



*Choose positive (+) values  
to increase exposure*





*Choose negative (-) values  
to reduce exposure*

- ❖ A  icon and exposure indicator are displayed at settings other than  $\pm 0$ . Exposure compensation is not reset when the camera is turned off; to restore normal exposure control, choose a value of  $\pm 0$ .
- ❖ Turn the flash off when using exposure compensation.

## Macro Mode (Close-ups)

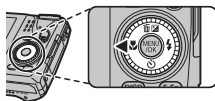
For close-ups, press the selector left () and select . Use the zoom control to compose pictures ( 19).



To exit macro mode, press the selector left () and select **OFF**.

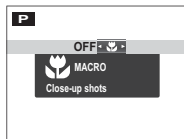

- ◆ Use of a tripod is recommended to prevent blur caused by camera shake.
- ◆ The shadow cast by the lens may appear in photographs taken with the flash at very short ranges. Zoom out or increase the distance to the subject.

## ⚡ Using the Flash (Super-Intelligent Flash)

When the flash is used, the camera's *Super-Intelligent Flash* system instantly analyzes the scene based on such factors as the brightness of the subject, its position in the frame, and its distance from the camera. Flash output and sensitivity are adjusted to ensure that the main subject is correctly exposed while preserving the effects of ambient background lighting, even in dimly-lit indoor scenes. Use the flash when lighting is poor, for example when shooting at night or indoors under low light.

1 Press the flash pop-up button to raise the flash.



2 Press the selector right (⚡) and choose from the following flash modes:

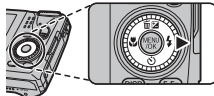



Option	Description
AUTO/AUTO*	The flash fires when required. Recommended in most situations.
⚡/EY*	The flash fires whenever a picture is taken. Use for backlit subjects or for natural coloration when shooting in bright light.
S⚡/SLOW*	Capture both the main subject and the background under low light (note that brightly lit scenes may be overexposed).

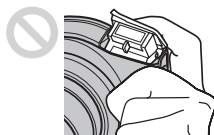

\* EY icon indicates that Intelligent Face Detection and red-eye removal are on and will be used to minimize "red-eye" caused by the flash reflecting from the retinas of portrait subjects.

- ❖ Changing the angle of the flash turns the flash off.



- ❖ Lower the flash where flash photography is prohibited or to capture natural lighting under dim light. We also recommend that you lower the flash when the camera is off.
- ❖ If the flash will fire,  will be displayed when the shutter button is pressed halfway. At slow shutter speeds,  will appear in the display to warn that pictures may be blurred; use of a tripod is recommended.
- ❖ The flash may fire several times with each shot. Do not move the camera until shooting is complete.
- ❖ The flash may cause vignetting.

## ⏸ Using the Self-Timer

To use the self-timer, press the selector down (⏸) and choose from the following options:

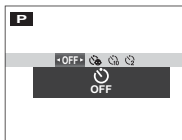
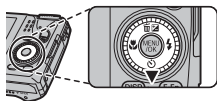

Option	Description
⏸ (OFF)	Self-timer off.
👤 (AUTO RELEASE)	The shutter is released automatically when the camera detects a human portrait subject facing the camera. Use for portraits of babies.
⏸ (10 SEC)	The shutter is released ten seconds after the shutter button is pressed. Use for self-portraits. The self-timer lamp on the front of the camera lights when the timer starts and begins to blink shortly before the photo is taken.
⏸ (2 SEC)	The shutter is released two seconds after the shutter button is pressed. Use to reduce blur caused by the camera moving when the shutter button is pressed. The self-timer lamp will blink as the timer counts down.

## The Fn Button

The role played by the **Fn** button can be selected using the **Fn Fn BUTTON** option (📖 80).

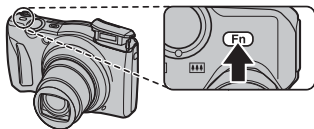

The following options are available:

**ISO** (📖 74)/**IMAGE SIZE** (📖 75)/**IMAGE QUALITY** (📖 76)/

**DYNAMIC RANGE** (📖 76)/**FILM SIMULATION** (📖 77)/

**PHOTOMETRY** (📖 79)/**FOCUS MODE** (📖 80)/**FACE DETECTION** (📖 49)

- ◆ The **Fn Fn BUTTON** menu can also be displayed by pressing and holding the **Fn** button.



## The E-Fn Button

Press the **E-Fn** button to use the **E-Fn** (extended function) menu.

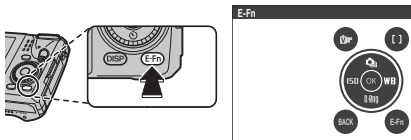

The each role played by the  button, the  button and the selector up, down, left and right can be used in the **E-Fn** menu.

◆ Press the **E-Fn** button again to return to shooting mode.

### ■ Using the E-Fn BUTTON CUSTOM SETTING Menu

The following options are available:

**ISO** (📖 74)/**IMAGE SIZE** (📖 75)/**IMAGE QUALITY** (📖 76)/

**DYNAMIC RANGE** (📖 76)/**FILM SIMULATION** (📖 77)/

**WHITE BALANCE** (📖 78)/**CONTINUOUS** (📖 45)/**PHOTOMETRY** (📖 79)/

**FOCUS MODE** (📖 80)/**FACE DETECTION** (📖 49)/

**INTELLIGENT DIGITAL ZOOM** (📖 97)

- 1 Select **E-Fn** **E-Fn** **BUTTON CUSTOM SETTING** in the shooting menu. The **E-Fn** **E-Fn** **BUTTON CUSTOM SETTING** menu is displayed.

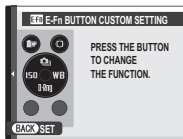

2 Press the button to adjust.

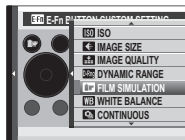







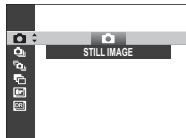
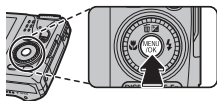

3 Highlight items and press the selector up or down to view options, then highlight an option and press **MENU/OK**.

## Continuous Shooting

To capture motion in a series of pictures, press **MENU/OK**, select  **CONTINUOUS** in the shooting menu (📖 79), and choose from the options listed in this section.



Option	
 <b>STILL IMAGE</b>	—
 <b>TOP <i>n</i></b>	46
 <b>BEST FRAME CAPTURE</b>	46
 <b>AE BKT</b>	48
 <b>FILM SIMULATION BKT</b>	48
 <b>DYNAMIC RANGE BKT</b>	48

- ❖ The flash turns off automatically. The previously selected flash mode is restored when  is selected for  **CONTINUOUS**.
- ❖ Frame rate varies with shutter speed.
- ❖ Focus and exposure are determined by the first frame in each series.
- ❖ The number of pictures that can be taken in a single burst varies with the scene and camera settings. The number of pictures that can be recorded depends on the memory available.

## ■ TOP *n*

The camera takes photographs while the shutter button is pressed. To choose the frame rate:

Press the selector left or right to choose a frame rate and press **MENU/OK** to select and return to shooting mode.

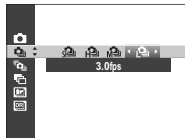

## ■ BEST FRAME CAPTURE

The camera takes a series of pictures, starting before and ending after the shutter button is pressed.

- 1 Press the selector right when the camera is in shooting mode.
- 2 Highlight the current frame rate and press the selector right, then press selector up or down to choose a new value and press **MENU/OK** to select.
  - ⓘ Some frame rates may reduce the number of shots available.

3 Highlight the number of shots and press the selector right. Press the selector up or down to choose the number of shots in each burst and left or right to choose their distribution (the number on the left is taken *before* and the number on the right *after* the shutter button is pressed). Press **MENU/OK** when settings are complete and press **DISP/BACK** to return to shooting mode.

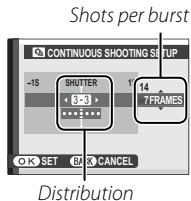

4 Take photographs. The camera begins recording while the shutter button is pressed halfway, and completes the burst when the shutter button is pressed all the way down. The illustration shows a burst of seven shots, three before the shutter button is pressed and three after.

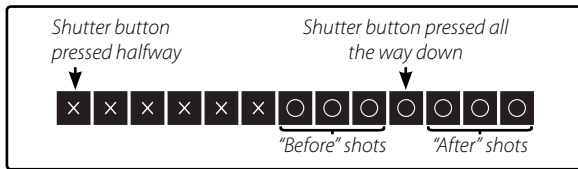





- ① If the shutter button is pressed all the way down before the number of frames selected for the "before" portion is recorded, the remaining frames will be taken after the shutter button is pressed all the way down.
- ① If the shutter button is pressed halfway for an extended period, the camera may record the burst before the shutter button is pressed all the way down.







## AE BKT

Each time the shutter button is pressed, the camera takes three shots: one using the metered value for exposure, the second overexposed by the amount selected for the selector left or right, and the third underexposed by the same amount (the camera may not be able to use the selected bracketing increment if the amount of over- or under- exposure exceeds the limits of the exposure metering system).

## FILM SIMULATION BKT

Each time the shutter button is pressed, the camera takes one shot and processes it to create three copies with different  **FILM SIMULATION** settings ( 77):  **PROVIA/STANDARD** for the first,  **Velvia/VIVID** for the second, and  **ASTIA/SOFT** for the third.

## DYNAMIC RANGE BKT

Each time the shutter button is pressed, the camera takes three shots at different  **DYNAMIC RANGE** settings ( 76):  **100%** for the first,  **200%** for the second, and  **400%** for the third ( **ISO** is restricted to values between 400 and 3200).

## Intelligent Face Detection

Intelligent Face Detection sets focus and exposure for human faces anywhere in the frame, preventing the camera from focusing on the background in group portraits. Choose for shots that emphasize portrait subjects.

To use Intelligent Face Detection, press **MENU/OK** to display the shooting menu and select **ON** for  **FACE DETECTION** (📖 79). Faces can be detected with the camera in vertical or horizontal orientation; if a face is detected, it will be indicated by a green border. If there is more than one face in the frame, the camera will select the face closest to the center; other faces are indicated by white borders.

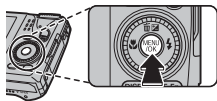

- ① In some modes, the camera may set exposure for the frame as a whole rather than the portrait subject.
- ① If the subject moves as the shutter button is pressed, their face may not be in the area indicated by the green border when the picture is taken.

## More on Playback

### Playback Options

To view the most recent picture in the LCD monitor, press the  button.

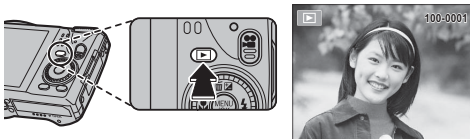

Press the selector right to view pictures in the order recorded, left to view pictures in reverse order. Keep the selector pressed to scroll rapidly to the desired frame.

◆ Pictures taken using other cameras are indicated by a  ("gift image") icon during playback.

#### **Zooming in on the Focus Point**

Press the selector down to zoom in on the focus point. Press **DISP/BACK** or **MENU/OK** to return to full-frame playback.





### **Continuous Shooting**

In the case of pictures taken in continuous shooting mode, only the first frame of each series will be displayed. Press the selector down to view the other pictures in the series.

### **★ Favorites: Rating Pictures**

To rate the picture currently displayed in full-frame playback, press **DISP/BACK** and press the selector up and down to select from zero to five stars.

**Playback Zoom**

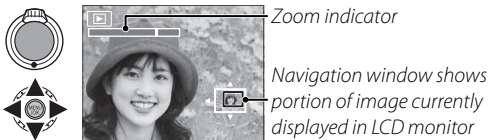

Select **[Z]** to zoom in on pictures displayed in single-frame playback; select **[Z]** to zoom out. When the picture is zoomed in, the selector can be used to view areas of the image not currently visible in the display.



Press **DISP/BACK** to exit zoom.

- ◆ If the pictures before or after the current picture are the same size as the current picture, you can rotate the command dial to view the other pictures without changing the zoom ratio. This option is not available if the pictures are not the same size as the current picture.
- ◆ The maximum zoom ratio varies with image size. Playback zoom is not available with cropped or resized copies saved at a size of **640** or smaller.

## **Multi-Frame Playback**

To display multiple images, select  when a picture is shown full-frame in the LCD monitor. Select  to increase the number of images displayed from two to nine or one hundred,  to view fewer images.

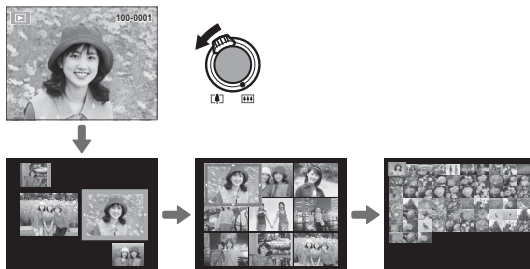



When two or more images are displayed, use the selector to highlight images and press **MENU/OK** to view the highlighted image full frame. In the nine- and hundred-frame displays, use the selector to view more pictures.

## Deleting Pictures

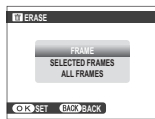
To delete individual pictures, multiple selected pictures, or all pictures, press the selector up () and choose from the options below. *Note that deleted pictures can not be recovered. Copy important pictures to a computer or other storage device before proceeding.*











Option	Description
<b>FRAME</b>	Press the selector left or right to scroll through pictures and press <b>MENU/OK</b> to delete the current picture (a confirmation dialog is not displayed).
<b>SELECTED FRAMES</b>	Highlight pictures and press <b>MENU/OK</b> to select or deselect (pictures in photobooks or print orders are shown by  ). When the operation is complete, press <b>DISP/BACK</b> to display a confirmation dialog, then highlight <b>OK</b> and press <b>MENU/OK</b> to delete the selected pictures.
<b>ALL FRAMES</b>	A confirmation dialog will be displayed; highlight <b>OK</b> and press <b>MENU/OK</b> to delete all unprotected pictures (if a memory card is inserted, only the pictures on the memory card will be affected; the pictures in internal memory are only deleted if no memory card is inserted). Pressing <b>DISP/BACK</b> cancels deletion; note that any pictures deleted before the button was pressed can not be recovered.

- ◆ Protected pictures can not be deleted. Remove protection from any pictures you wish to delete ( 87).
- ◆ Pictures can also be deleted by  **ERASE** from playback menu.
- ◆ If a message appears stating that the selected images are part of a DPOF print order, press **MENU/OK** to delete the pictures.

## Image Search

---

Search for pictures.

- 1 Select  **IMAGE SEARCH** in the playback menu ( 84), highlight one of the following search criteria, and press **MENU/OK**:
  - **BY DATE**: Search by date.
  - **BY FACE**: Search for faces from the face recognition database.
  - **BY ★ FAVORITES**: Search by rating.
  - **BY SCENE**: Search by scene.
  - **BY TYPE OF DATA**: Find all still pictures or all movies.
  - **BY UPLOAD MARK**: Find all pictures selected for upload to a specified destination.
- 2 Select a search condition. Only pictures that match the search condition will be displayed. To delete or protect selected pictures or to view the search results in a slide show, press **MENU/OK** and choose  **ERASE** ( 54),  **PROTECT** ( 87), or  **SLIDE SHOW** ( 86).

## PhotoBook Assist

---

Create books from your favorite photos.

### ***Creating a PhotoBook***

**1** Select **NEW BOOK** for  **PHOTOBOOK ASSIST** in the playback menu ( 84) and choose from the following options:

- **SELECT FROM ALL:** Choose from all available pictures.
- **SELECT BY IMAGE SEARCH:** Choose from pictures matching selected search conditions ( 55).

◆ Neither photographs  or smaller nor movies can be selected for photobooks.

**2** Scroll through the images and press the selector up to select or deselect. To display the current image on the cover, press the selector down. Press **MENU/OK** to exit when the book is complete.

◆ The first picture selected becomes the cover image. Press the selector down to select a different image for the cover.

**3** Select **COMPLETE PHOTOBOOK** (to select all photos or all photos matching the specified search conditions for the book, choose **SELECT ALL**). The new book will be added to the list in the photobook assist menu.

ⓘ Books can contain up to 300 pictures.

ⓘ Books that contain no photos are automatically deleted.

### **Viewing Photobooks**

Highlight a book in the photobook assist menu and press **MENU/OK** to display the book, then press the selector left or right to scroll through the pictures.

### **Editing and Deleting Photobooks**

Display the photobook and press **MENU/OK**. The following options will be displayed; select the desired option and follow the on-screen instructions.

- **EDIT:** Edit the book as described in “Creating a PhotoBook” (📖 56).
- **ERASE:** Delete the book.

#### **Photobooks**

Photobooks can be copied to a computer using the supplied MyFinePix Studio software.

## Viewing Panoramas

If you press the selector down when a panorama is displayed full frame, the camera will play back the picture from left to right or from bottom to top. To pause playback, press the selector down; press the selector down again to resume. To exit to full-frame playback, press the selector up while panorama playback is in progress. Once displayed in full-frame playback, panoramas can be zoomed in or out using the zoom control or deleted by pressing the selector up (🗑).

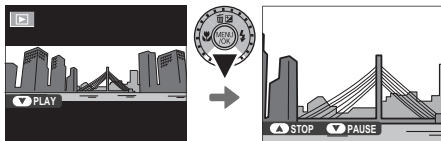

- ❖ 📺 panoramas play back in an endless loop (📖 28); the playback direction can be controlled by pressing the selector left or right. The camera will not turn off automatically while playback is in progress (📖 95).



# Movies





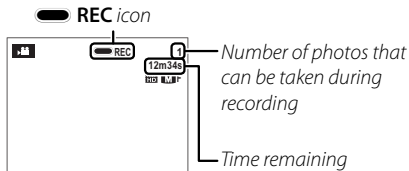

## Recording Movies

Press  to shoot a movie. During recording, the following indicators will be displayed and sound will be recorded via the built-in microphone (be careful not to cover the microphone during recording).



To end recording, press the  button again. Recording ends automatically when the movie reaches maximum length or memory is full. For information on the maximum footage that can be recorded, see page 116.

### Automatic Scene Selection



In **EXR AUTO** mode, the camera selects the scene according to shooting conditions and the type of subject:  (portraits),  (poorly-lit landscapes),  (poorly-lit portraits),  (landscapes),  (close-ups),  (backlit portraits), or  (other subjects).



Scene icon

### Taking Photographs During Recording

Press the shutter button to take a photograph during recording.

- ◆ The method used to record photographs can be selected using the  **MOVIE SET-UP > STILL SHOOTING IN MOVIE** option (📖 81).
  - ◆ The photo is saved separately from the movie and does not appear as part of the movie.
  - ⓘ Photos can not be taken while a high-speed movie is being recorded.
  - ⓘ The number of photos that can be taken is limited.
- 
- ◆ Zoom can be adjusted while recording is in progress.
  - ◆ If the subject is poorly lit, the AF-assist lamp may light to assist the focus operation. To turn the AF-assist lamp off, select **OFF** for  **AF ILLUMINATOR** (📖 97).
  - ◆ Focus, exposure, and white balance are adjusted automatically throughout recording. The color and brightness of the image may vary from that displayed before recording begins.
  - ◆ Sounds made by the camera may be recorded.
- 
- ⓘ The indicator lamp lights while movies are being recorded. Do not open the battery chamber during shooting or while the indicator lamp is lit. Failure to observe this precaution could prevent the movie from being played back.
  - ⓘ Vertical or horizontal streaks may appear in movies containing very bright subjects. This is normal and does not indicate a malfunction.
  - ⓘ The temperature of the camera may rise if it is used to record movies for an extended period or if the ambient temperature is high. This is normal and does not indicate a malfunction.
  - ⓘ The mode selected may vary with shooting conditions.

## Viewing Movies

During playback, movies are displayed in the LCD monitor as shown at right. The following operations can be performed while a movie is displayed:

Option	Description
Start/pause playback	<b>Press the selector down</b> to start playback. Press again to pause. While playback is paused, you can press the selector left or right to rewind or advance one frame at a time.
End playback/delete	<b>Press the selector up</b> to end playback.
Adjust speed	<b>Press the selector left or right</b> to adjust playback speed during playback.
Adjust volume	<b>Press MENU/OK</b> to pause playback and display volume controls. Press the selector up or down to adjust the volume and press <b>MENU/OK</b> to exit. Volume can also be adjusted using the <b>▶ SOUND SET-UP &gt; PLAYBACK VOLUME</b> option (📖 93).

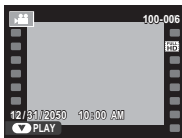

### ▶ Playback Speed

**Press the selector left or right** to adjust playback speed. Speed is shown by the number of arrows (▶ or ◀).

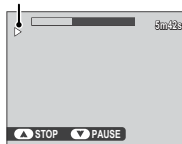

ⓘ Do not cover the speaker during playback.

## Connections

### Viewing Pictures on High-Definition TVs

The camera can be connected to High-Definition (HD) devices using an HDMI cable (available separately from third-party sources).

- 1 Turn the camera off and connect the HDMI cable as shown below.

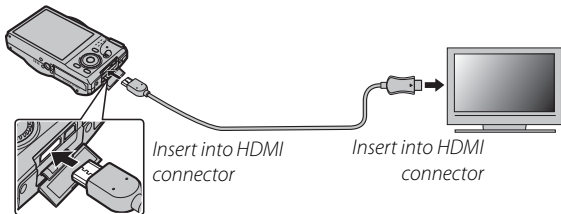

- ⓘ When connecting cables, be sure the connectors are fully inserted.
  - ⚡ When an HDMI cable is connected, pictures and sound are played back on the TV.
- 2 Tune the television to the HDMI input channel. See the documentation supplied with the television for details.
- 3 Press the  button for about a second to turn the camera on. The camera monitor turns off and pictures and movies are played back on the TV. Note that the camera volume controls have no effect on sounds played on the TV; use the television volume controls to adjust the volume.
  - ⚡ The USB cable can not be used while an HDMI cable is connected.
  - ⚡ Some televisions may briefly display a black screen when movie playback begins.

## Printing Pictures via USB

If the printer supports PictBridge, the camera can be connected directly to the printer as shown below and pictures can be printed without first being copied to a computer. Note that depending on the printer, not all the functions described below may be supported.



- 1 Connect the supplied USB cable as shown and turn the printer on.

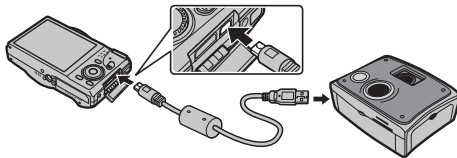

- 2 Turn the camera on.
- 3 Press the selector left or right to display a picture you wish to print.
- 4 Press the selector up or down to choose the number of copies (up to 99).
- 5 Repeat steps 3–4 to select additional pictures. Press **MENU/OK** to display a confirmation dialog when settings are complete.

**6** Press **MENU/OK** to start printing. Printing can be interrupted by pressing **DISP/BACK**, but note that some printers may not respond immediately. If the printer stops before printing is complete, turn the camera off and then on again.



**7** After confirming that **PRINTING** has cleared from the camera display, turn the camera off and disconnect the USB cable.

- ◆ Pictures can be printed from internal memory or a memory card that has been formatted in the camera.
- ◆ If no pictures are selected, the camera will print one copy of the current picture.
- ◆ Page size, print quality, and border selections are made using the printer.

#### **Printing the Date of Recording**

To print the date of recording on pictures, press **DISP/BACK** in the PictBridge display and select **PRINT WITH DATE**  in the PictBridge menu (to print pictures without the date of recording, select **PRINT WITHOUT DATE**). Some printers do not support date printing. See the printer manual for details.

### ***Printing the DPOF Print Order***

The  **PRINT ORDER (DPOF)** option can be used to create a digital “print order” for PictBridge-compatible printers ( 63) or devices that support DPOF.

#### **DPOF**

DPOF (Digital Print Order Format) is a standard that allows pictures to be printed from “print orders” stored in internal memory or on a memory card. The information in the order includes the pictures to be printed and the number of copies of each picture.



- 1 Select playback mode and press **MENU/OK** to display the playback menu.
- 2 Highlight  **PRINT ORDER (DPOF)** and press **MENU/OK**.
- 3 Highlight one of the following options and press **MENU/OK**:
  - **WITH DATE** : Print the date of recording on pictures.
  - **WITHOUT DATE**: Do not print the date of recording on pictures.

 Some printers do not support date printing. See the printer manual for details.
- 4 Press the selector left or right to display a picture you wish to add to or remove from the print order.

- 5** Press the selector up or down to choose the number of copies (up to 99). To remove a picture from the print order, press the selector down until the number of copies is zero.
- 6** Repeat Steps 4–5 to complete the print order and press **MENU/OK** when settings are complete.
- 7** A confirmation dialog will be displayed. Press **MENU/OK** to save the print order.
  - ◆ Remove the memory card to create or modify a print order for the pictures in internal memory.
  - ◆ Print orders can contain a maximum of 999 pictures.
  - ◆ If a memory card is inserted containing a print order created by another camera, a message will be displayed. Create a new print order as described above.



## Viewing Pictures on a Computer

The supplied software can be used to copy pictures to a computer, where they can be stored, viewed, organized, and printed. Before proceeding, install the software as described below. *Do not connect the camera to the computer until installation is complete.*

### ***Windows: Installing MyFinePix Studio***

1 Confirm that the computer meets the following system requirements:

	<b>Windows 8/Windows 7 (SP 1)/ Windows Vista (SP 2)<sup>1</sup></b>	<b>Windows XP (SP 3)<sup>1</sup></b>
<b>CPU</b>	3 GHz Pentium 4 or better (2.4GHz Core 2 Duo or better) <sup>2</sup>	2GHz Pentium 4 or better (2.4GHz Core 2 Duo or better) <sup>2</sup>
<b>RAM</b>	1 GB or more	512 MB or more (1 GB or more) <sup>2</sup>
<b>Free disk space</b>	2 GB or more	
<b>GPU</b>	Supports DirectX 9 or later (recommended)	Supports DirectX 7 or later (required; performance not guaranteed with other GPUs)
<b>Video</b>	1,024×768 pixels or more with 24-bit color or better	
<b>Other</b>	<ul style="list-style-type: none"><li>• Built-in USB port recommended. Operation is not guaranteed with other USB ports.</li><li>• .NET Framework 3.5 Service Pack 1 required when uploading images or using Map Viewer.</li><li>• Internet connection (broadband recommended) required to install .NET Framework (if necessary), to use auto update feature, and when performing such tasks as sharing pictures on-line or via e-mail.</li></ul>	

1 Other versions of Windows are not supported. Only pre-installed operating systems are supported; operation is not guaranteed on home-built computers or computers that have been upgraded from earlier versions of Windows.

2 Recommended when displaying HD movies.

- 2 Start the computer. Log in to an account with administrator privileges before proceeding.
- 3 Exit any applications that may be running and insert the installer CD in a CD-ROM drive.

#### **Windows 8/Windows 7/Windows Vista**

If an AutoPlay dialog is displayed, click **SETUP.EXE**. A “User Account Control” dialog will then be displayed; click **Yes** (Windows 8/Windows 7) or **Allow** (Windows Vista).

The installer will start automatically; click **Install MyFinePix Studio** and follow the on-screen instructions to install MyFinePix Studio.

#### **If the Installer Does Not Start Automatically**

If the installer does not start automatically, select **Computer** or **My Computer** from the Start menu, then double-click the **FINEPIX** CD icon to open the FINEPIX CD window and double-click **setup** or **SETUP.EXE**.

#### **If the Installer Does Not Start Automatically (Windows 8)**

- 1 Select **Desktop** on the Start screen.
- 2 Select **File Explorer** on the taskbar.
- 3 Select **Computer** in the navigation pane.
- 4 Double-click the drive icon inserting the **FINEPIX** CD and follow the on-screen instructions to install.

- 4** If prompted to install Windows Media Player or DirectX, follow the on-screen instructions to complete installation.
- 5** Remove the installer CD from the CD-ROM drive when installation is complete. Store the installer CD in a dry location out of direct sunlight in case you need to re-install the software.

Installation is now complete. Proceed to “Connecting the Camera” (📖 70).

## **Connecting the Camera**

- 1** If the pictures you wish to copy are stored on a memory card, insert the card into the camera.
  - ◆ Windows users may require the Windows CD when starting the software for the first time.
  - ⓘ Loss of power during transfer could result in loss of data or damage to internal memory or the memory card. Charge the battery before connecting the camera.
- 2** Turn the camera off and connect the supplied USB cable as shown, making sure the connectors are fully inserted. Connect the camera directly to the computer; do not use a USB hub or keyboard.

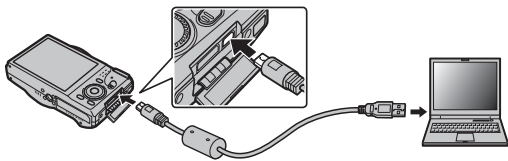

- 3** Press the  button for about a second to turn the camera on and follow the on-screen instructions to copy pictures to the computer. To exit without copying pictures, click **Cancel**.

For more information on using the supplied software, start the application and select the appropriate option from the **Help** menu.

- ① If a memory card containing a large number of images is inserted, there may be a delay before the software starts and you may be unable to import or save images. Use a memory card reader to transfer pictures.
- ① Make sure that the computer does not display a message stating that copying is in progress and that the indicator lamp is out before turning the camera off or disconnecting the USB cable (if the number of images copied is very large, the indicator lamp may remain lit after the message has cleared from the computer display). Failure to observe this precaution could result in loss of data or damage to internal memory or the memory card.
- ① Disconnect the camera before inserting or removing memory cards.
- ① In some cases, it may not be possible to access pictures saved to a network server using the supplied software in the same way as on a standalone computer.
- ① The user bears all applicable fees charged by the phone company or Internet service provider when using services that require an Internet connection.

### **Disconnecting the Camera**

After confirming that the indicator lamp is out, turn the camera off and disconnect the USB cable.

### **Uninstalling the Supplied Software**

Only uninstall the supplied software when it is no longer required or before beginning reinstallation. After quitting the software and disconnecting the camera, open the control panel and use “Programs and Features” (Windows 8/Windows 7/Windows Vista) or “Add or Remove Programs” (Windows XP) to uninstall MyFinePix Studio. Under Windows, one or more confirmation dialogs may be displayed; read the contents carefully before clicking **OK**.

### **Importing Pictures or Movies to Mac (Macintosh)**

Use a standard application in Mac OS such as Image Capture to import pictures or movies to Mac.

# Menus

## Using the Menus: Shooting Mode

### Using the Shooting Menu

#### 1 Display the shooting menu.

- 1.1 Press **MENU/OK** during shooting to display the shooting menu.

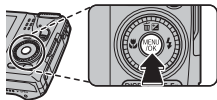

- 1.2 Press the selector left to highlight the current tab.

- 1.3 Press the selector up or down to highlight the tab containing the desired option.



- 1.4 Press the selector right to place the cursor in the menu.

#### 2 Adjust settings.

Highlight items and press the selector right to view options, then highlight an option and press **MENU/OK**. Press **DISP/BACK** to exit when settings are complete.

**Shooting Menu Options****EXR MODE**(default: **EXR AUTO**)Choose an option for **EXR** mode (📖 24).**Adv. MODE**(default: **ADVANCED FILTER**)

Choose an advanced shooting mode (📖 26).

**SCENE POSITION**(default: **S**)Choose a scene for **SP** mode (📖 32).**ISO ISO**(default: **AUTO**)

Control the camera's sensitivity to light. Higher values can reduce blur; note, however, that mottling may appear in pictures taken at high sensitivities.



Option	Description
<b>AUTO</b>	Sensitivity is adjusted automatically in response to shooting conditions.
<b>AUTO (3200) / AUTO (1600) / AUTO (800) / AUTO (400)</b>	As above, except that sensitivity will not be raised above the value in parentheses.
<b>12800 / 6400 / 3200 / 1600 / 800 / 400 / 200 / 100</b>	Sensitivity is set to the specified value, which is shown in the display.



## IMAGE SIZE

 (default: **L** 4:3)

Choose the image size and aspect ratio at which pictures are recorded. Large pictures can be printed at large sizes with no drop in quality, while small pictures require less memory, allowing more pictures to be recorded.



### Size Versus Aspect Ratio

#### Size

Option	Prints at sizes up to
<b>L</b>	34×25 cm (13.5×10 in.)
<b>M</b>	24×18 cm (9.5×7 in.)
<b>S</b>	17×13 cm (7×5 in.)

#### Aspect ratio

**4:3:** Pictures have the same proportions as the camera display.

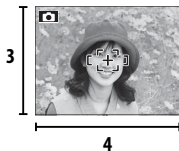

**3:2:** Pictures have the same proportions as a frame of 35 mm film.

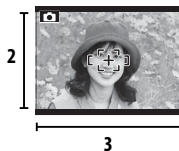

**16:9:** Suited for display on High Definition (HD) devices.

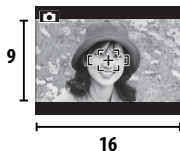

**IMAGE QUALITY**(default: **FINE**)

Choose how much image files are compressed.

Option	Description
<b>FINE</b>	Low compression. Select for higher image quality.
<b>NORMAL</b>	High compression. Select this option to store more pictures.

**DYNAMIC RANGE**(default: **AUTO**)

Control contrast. Higher values are recommended for scenes that include both sunlight and deep shade or for increased contrast with such subjects as sunlight on water, brightly-lit autumn leaves, portraits taken against a blue sky, and white objects or people wearing white; note, however, that mottling may appear in pictures taken at higher values. If **AUTO** is selected, the camera will automatically select values between 100% and 400% in response to shooting conditions.

Option	Description
<b>AUTO</b>	Increase contrast when shooting indoors or under overcast skies. 
<b>100%</b>	
<b>200%</b>	
<b>400%</b>	Reduce loss of detail in highlights and shadows when photographing high-contrast scenes.
<b>800%</b>	
<b>1600%</b>	

- ◆ **1600%** and **800%** are available only when **D-RANGE PRIORITY** is selected in **EXR** mode and an option other than **Velvia/VIVID** or **ASTIA/SOFT** is selected for **FILM SIMULATION**.









**FILM SIMULATION**(default: **STD**)

Simulate the effects of different types of film, including sepia and black-and-white.

Option	Description
<b>STD</b> <b>PROVIA/ STANDARD</b>	Standard color reproduction. Suited to a wide range of subjects, from portraits to landscapes.
<b>V</b> <b>Velvia/VIVID</b>	A high-contrast palette of saturated colors, suited to nature photographs.
<b>S</b> <b>ASTIA/SOFT</b>	A soft-toned palette of less saturated colors.
<b>B</b> <b>B&amp;W</b>	Take pictures in black and white.
<b>SEPIA</b> <b>SEPIA</b>	Take pictures in sepia.

**WB WHITE BALANCE**(default: **AUTO**)



If **AUTO** does not produce natural colors (for example, when taking close-ups), select  and measure a value for white balance or choose the option that matches the light source.

Option	Description
<b>AUTO</b>	White balance adjusted automatically.
	Measure a value for white balance.
	For subjects in direct sunlight.
	For subjects in the shade.
	Use under "daylight" fluorescent lights.
	Use under "warm white" fluorescent lights.
	Use under "cool white" fluorescent lights.
	Use under incandescent lighting.
	For underwater photography

 **Custom White Balance**

Choose  to adjust white balance for unusual lighting conditions. White balance measurement options will be displayed; frame a white object so that it fills the display and press the shutter button all the way down to measure white balance.

- If **"COMPLETED!" is displayed**, press **MENU/OK** to set white balance to the measured value.
- If **"UNDER" is displayed**, raise exposure compensation ( 37) and try again.
- If **"OVER" is displayed**, lower exposure compensation and try again.

◆ For greater precision, adjust  **FILM SIMULATION**,  **ISO**, and  **DYNAMIC RANGE** before measuring white balance.

- ◆ At settings other than , auto white balance is used with the flash.
- ◆ Results vary with shooting conditions. Play pictures back after shooting to check colors in the display.

** CONTINUOUS**(default: )

Capture motion in a series of pictures ( 45).

** ADVANCED ANTI BLUR**(default: **ON**)



Select **ON** to enable advanced anti blur in  mode ( 25).

** FACE DETECTION**(default: **ON**)

Choose whether the camera automatically detects and sets focus and exposure for human portrait subjects ( 49).





** PHOTOMETRY**(default: )





Choose how the camera meters exposure when Intelligent Face Detection is off.

Option	Description
 <b>MULTI</b>	Automatic scene recognition is used to adjust exposure for a wide range of shooting conditions.
 <b>SPOT</b>	The camera meters lighting conditions at the center of the frame. Recommended when the background is much brighter or darker than the main subject.
<input type="checkbox"/> <b>AVERAGE</b>	Exposure is set to the average for the entire frame. Provides consistent exposure across multiple shots with the same lighting, and is particularly effective for landscapes and portraits of subjects dressed in black or white.

** FOCUS MODE**

This option controls how the camera selects the focus area for photographs. Regardless of the option selected, the camera will focus on the subject in the center of the frame when macro mode is on.

Option	Description
 <b>CENTER</b>	The camera focuses on the subject in the center of the frame.
 <b>MULTI</b>	When the shutter button is pressed halfway, the camera detects high-contrast subjects near the center of the frame and selects the focus area automatically.
 <b>CONTINUOUS</b>	The camera continuously adjusts focus to reflect changes in the distance to the subject in the focus frame.
 <b>TRACKING</b>	Position the subject in the center focus area and press the selector left. Focus will track the subject as it moves through the frame.

- ◆ Note that in  and  modes, the camera focuses continuously, increasing the drain on the battery, and that the sound of the camera focusing may be audible.
- ◆ If a face is detected when  is selected, a  icon will be displayed and the camera will continuously adjust focus to maintain focus on the face.

** Fn BUTTON****(default: ISO)**



























Choose the role played by the **Fn** button ( 42).

** E-Fn BUTTON CUSTOM SETTING**



Choose the role played by the  button, the  button and the selector up, down, left and right ( 43).

 **MOVIE SET-UP**

Adjust movie settings.

Option	Description												
<b>MOVIE MODE</b>	Choose a frame size for movies.												
	<table border="1"> <thead> <tr> <th data-bbox="243 222 446 249">Option</th> <th data-bbox="449 222 979 249">Description</th> </tr> </thead> <tbody> <tr> <td data-bbox="243 252 446 283"> <b>1920 × 1080</b> (60 fps)</td> <td data-bbox="449 252 979 283">Full HD (High Definition).</td> </tr> <tr> <td data-bbox="243 286 446 318"> <b>1280 × 720</b> (60 fps)</td> <td data-bbox="449 286 979 318">High Definition.</td> </tr> <tr> <td data-bbox="243 321 446 352"> <b>640 × 480</b> (30 fps)</td> <td data-bbox="449 321 979 352">Standard definition.</td> </tr> <tr> <td data-bbox="243 355 446 386"> <b>640 × 480</b> (80 fps)</td> <td data-bbox="449 355 979 427" rowspan="3">High speed movie. Sound is not recorded, and focus, exposure, and white balance are not adjusted automatically. Black bands appear at the top and bottom of movies recorded at  <b>320 × 112</b>.</td> </tr> <tr> <td data-bbox="243 389 446 420"> <b>320 × 240</b> (160 fps)</td> </tr> <tr> <td data-bbox="243 423 446 454"> <b>320 × 112</b> (320 fps)</td> </tr> </tbody> </table>	Option	Description	 <b>1920 × 1080</b> (60 fps)	Full HD (High Definition).	 <b>1280 × 720</b> (60 fps)	High Definition.	 <b>640 × 480</b> (30 fps)	Standard definition.	 <b>640 × 480</b> (80 fps)	High speed movie. Sound is not recorded, and focus, exposure, and white balance are not adjusted automatically. Black bands appear at the top and bottom of movies recorded at  <b>320 × 112</b> .	 <b>320 × 240</b> (160 fps)	 <b>320 × 112</b> (320 fps)
	Option	Description											
	 <b>1920 × 1080</b> (60 fps)	Full HD (High Definition).											
	 <b>1280 × 720</b> (60 fps)	High Definition.											
	 <b>640 × 480</b> (30 fps)	Standard definition.											
	 <b>640 × 480</b> (80 fps)	High speed movie. Sound is not recorded, and focus, exposure, and white balance are not adjusted automatically. Black bands appear at the top and bottom of movies recorded at  <b>320 × 112</b> .											
 <b>320 × 240</b> (160 fps)													
 <b>320 × 112</b> (320 fps)													
<b>MOVIE AF MODE</b>	This option controls how the camera selects the focus area for movies.												
	<ul style="list-style-type: none"> <li>•  <b>CENTER</b>: When shooting starts, the camera focuses on the subject in the center of the frame.</li> <li>•  <b>CONTINUOUS</b>: The camera continuously adjusts focus to reflect changes in the distance to subjects near the center of the frame.</li> </ul>												
	<ul style="list-style-type: none"> <li>◆ Note that in  mode, the camera focuses continuously, increasing the drain on the battery, and that the sound of the camera focusing may be audible.</li> </ul>												
	<ul style="list-style-type: none"> <li>◆ If a face is detected when  is selected, a  icon will be displayed and the camera will continuously adjust focus to maintain focus on the face.</li> </ul>												

 **MOVIE SET-UP (Continued)**

Option	Description
<b>STILL SHOOTING IN MOVIE</b>	<p>Choose how the camera records photographs taken during movie recording (p. 60).</p> <ul style="list-style-type: none"> <li>• <b>MOVIE PRIORITY:</b> The camera takes a photograph without interrupting movie recording. Image size is determined by the option selected for <b>MOVIE MODE</b>.</li> <li>• <b>STILL IMAGE PRIORITY:</b> The camera interrupts filming to take the photograph and resumes filming automatically when recording is complete. Image size is determined by the option selected for  <b>IMAGE SIZE</b>, but note that the photograph will be recorded at size  if  is selected.</li> </ul>



## Using the Menus: Playback Mode

### Using the Playback Menu

#### 1 Display the playback menu.

- 1.1 Press **MENU/OK** during playback to display the playback menu.

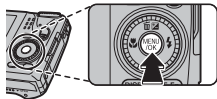

- 1.2 Press the selector left to highlight the current tab.

*Tab*

- 1.3 Press the selector up or down to highlight the tab containing the desired option.

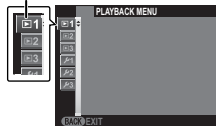

- 1.4 Press the selector right to place the cursor in the menu.

#### 2 Adjust settings.

Highlight items and press the selector right to view options, then highlight an option and press **MENU/OK**. Press **DISP/BACK** to exit when settings are complete.

### ***Playback Menu Options***

#### **PHOTOBOOK ASSIST**

Create books from your favorite photos ( 56).

#### **IMAGE SEARCH**

Search for pictures ( 55).

#### **ERASE**



Delete all or selected pictures ( 54).

---

## MARK FOR UPLOAD TO

Select pictures for upload to YouTube, Facebook or MyFinePix.com using MyFinePix Studio (Windows only).

### ■ Selecting Pictures for Upload

- 1 Select **YouTube** to choose movies for upload to YouTube, **FACEBOOK** to choose photos and movies for upload to Facebook, or **MyFinePix.com** to choose photos for upload to MyFinePix.com.
  - 2 Press the selector left or right to display pictures and press **MENU/OK** to select or deselect. Press **DISP/BACK** to exit when all the desired pictures are selected.
- ❖ Only movies can be selected for upload to YouTube.
  - ❖ Only photos can be selected for upload to MyFinePix.com.
  - ❖ During playback, selected pictures are indicated by  **YouTube**,  **FACEBOOK** or  **MyFinePix.com** icons.

### ■ RESET ALL: Deselecting All Pictures

Choose **RESET ALL** to deselect all pictures. If the number of pictures affected is very large, a message will be displayed while the operation is in progress. Press **DISP/BACK** to exit before the operation is complete.

### ■ Uploading Pictures (Windows Only)

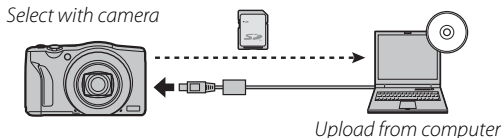

Selected pictures can be uploaded using the **YouTube/Facebook/MyFinePix.com Upload** option in MyFinePix Studio.



For information on installing MyFinePix Studio and connecting the camera to a computer, see "Viewing Pictures on a Computer" (📖 67).

**SLIDE SHOW**(default: **MULTIPLE**)

View pictures in an automated slide show. Choose the type of show and press **MENU/OK** to start. Press **DISP/BACK** at any time during the show to view on-screen help. The show can be ended at any time by pressing **MENU/OK**.



Option	Description
<b>NORMAL</b>	Press selector left or right to go back or skip ahead one frame. Select <b>FADE-IN</b>
<b>FADE-IN</b>	for fade transitions between frames.
<b>NORMAL</b> 	As above, except that camera automatically zooms in on faces selected with
<b>FADE-IN</b> 	Intelligent Face detection.
<b>MULTIPLE</b>	Display several pictures at once.

◆ The camera will not turn off automatically while a slide show is in progress.

**RED EYE REMOVAL**

If the current picture is marked with a  icon to indicate that it was taken with Intelligent Face Detection, this option can be used to remove red-eye. The camera will analyze the image; if red-eye is detected, the image will be processed to create a copy with reduced red-eye.

- 1 Display the desired picture.
- 2 Select  **RED EYE REMOVAL** in the playback menu.
- 3 Press **MENU/OK**.

- ◆ Red eye may not be removed if the camera is unable to detect a face or the face is in profile. Results may differ depending on the scene. Red eye can not be removed from pictures that have already been processed using red-eye removal or pictures created with other devices.
- ◆ The amount of time needed to process the image varies with the number of faces detected.
- ◆ Copies created with  **RED EYE REMOVAL** are indicated by a  icon during playback.

 **PROTECT**

Protect pictures from accidental deletion.

- 1 Select  **PROTECT** in the playback menu.
  - 2 Highlight one of the following options and press **MENU/OK**:
    - **FRAME**: Protect selected pictures. Press the selector left or right to view pictures and press **MENU/OK** to select or deselect. Press **DISP/BACK** when the operation is complete.
    - **SET ALL**: Protect all pictures.
    - **RESET ALL**: Remove protection from all pictures.
- ⓘ Protected pictures will be deleted when the memory card or internal memory is formatted (📖 100).

 **CROP**

Create a cropped copy of the current picture.

- 1 Display the desired picture.
  - 2 Select  **CROP** in the playback menu.
  - 3 Use the zoom control to zoom in and out and use the selector to scroll the picture until the desired portion is displayed.
  - 4 Press **MENU/OK** to display a confirmation dialog.
  - 5 Press **MENU/OK** again to save the cropped copy to a separate file.
- 🔍 Larger crops produce larger copies; all copies have an aspect ratio of 4:3. If the size of the final copy will be **640**, **OK** will be displayed in yellow.

### **RESIZE**

Create a small copy of the current picture.

- 1 Display the desired picture.
  - 2 Select  **RESIZE** in the playback menu.
  - 3 Highlight a size and press **MENU/OK** to display a confirmation dialog.
  - 4 Press **MENU/OK** to save the resized copy to a separate file.
- ◆ The sizes available vary with the size of the original image.

### **IMAGE ROTATE**

Rotate pictures taken in tall orientation so that they are displayed in tall orientation in the LCD monitor.

- 1 Display the desired picture.
  - 2 Select  **IMAGE ROTATE** in the playback menu.
  - 3 Press the selector down to rotate the picture 90° clockwise, up to rotate it 90° counterclockwise.
  - 4 Press **MENU/OK**. The picture automatically be displayed in the selected orientation whenever it is played back on the camera.
- ◆ Protected pictures can not be rotated. Remove protection before rotating pictures (📖 87).
  - ◆ The camera may not be able to rotate pictures created with other devices.
-

**COPY COPY**

Copy pictures from internal memory to a memory card.

- 1 Select **COPY COPY** in the playback menu.
  - 2 Highlight one of the following options and press the selector right:
    - **IN INTERNAL MEMORY → SD CARD**: Copy pictures from internal memory to a memory card.
    - **SD CARD → IN INTERNAL MEMORY**: Copy pictures from a memory card to internal memory.
  - 3 Highlight one of the following options and press **MENU/OK**:
    - **FRAME**: Copy selected pictures. Press the selector left or right to view pictures and press **MENU/OK** to copy the current picture.
    - **ALL FRAMES**: Copy all pictures.
- 👉 Copying ends when the destination is full.
- 👉 DPOF print information is not copied (📖 65).

### PRINT ORDER (DPOF)

Select pictures for printing on DPOF- and PictBridge-compatible devices ( 65).

### DISP ASPECT

Choose how High Definition (HD) devices display pictures with an aspect ratio of 4:3 (this option is available only when an HDMI cable is connected). Select **16:9** to display the image so that it fills the screen with its top and bottom cropped out, **4:3** to display the entire image with black bands at either side.

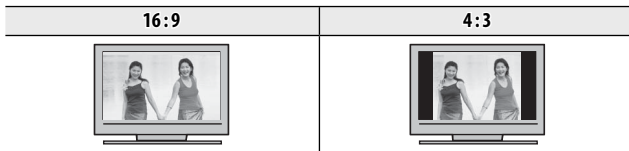
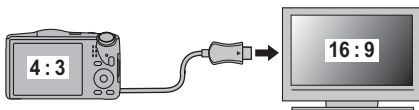

- ◆ Photographs with an aspect ratio of 16:9 are displayed full screen, those with an aspect ratio of 3:2 in a black frame.



# The Setup Menu

## Using the Setup Menu

### 1 Display the setup menu.

- 1.1 Press **MENU/OK** to display the menu for the current mode.

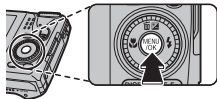

- 1.2 Press the selector left to highlight the tab for the current menu.

- 1.3 Press the selector down to highlight the tab containing the desired option.

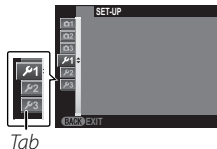

- 1.4 Press the selector right to place the cursor in the menu.

### 2 Adjust settings.

Highlight items and press the selector right to view options, then highlight an option and press **MENU/OK**. Press **DISP/BACK** to exit when settings are complete.

### ***Setup Menu Options***

#### **DATE/TIME**



Set the camera clock ( 17).





#### **TIME DIFFERENCE**

(default: )

Switch the camera clock instantly from your home time zone to the local time at your destination when traveling. To specify the difference between local time and your home time zone:

- 1 Highlight  **LOCAL** and press the selector right.
- 2 Use the selector to choose the time difference between local time and your home time zone.
- 3 Press **MENU/OK**.

To switch between local time and your home time zone, highlight  **LOCAL** or  **HOME** and press **MENU/OK**.

Option	Description
 <b>HOME</b>	Switch to the time currently selected for  <b>DATE/TIME</b> (see above).
 <b>LOCAL</b>	Switch to local time. If this option is selected,  and the time and date will be displayed in yellow for three seconds each time the camera is turned on.

#### **言語/LANG.**

Choose a language.

#### **RESET**

Reset all settings except  **DATE/TIME**,  **TIME DIFFERENCE**, and  **SCREEN SET-UP** > **BACKGROUND COLOR** to default values.

- 1 Highlight  **RESET** and press the selector right to display a confirmation dialog.
- 2 Highlight **OK** and press **MENU/OK**.

**SILENT MODE**(default: **OFF**)

Select **ON** to disable the speaker, flash, and AF-assist illuminator in situations in which camera sounds or lights may be unwelcome.

**SOUND SET-UP**

Adjust sound settings.

Option	Description
<b>OPERATION VOL.</b>	Adjust the volume of the sounds produced when camera controls are operated. Choose <b>OFF</b> (mute) to disable control sounds.
<b>SHUTTER VOLUME</b>	Adjust the volume of the sounds produced when the shutter is released. Choose <b>OFF</b> (mute) to disable the shutter sound.
<b>SHUTTER SOUND</b>	Choose the sound made by the shutter.
<b>PLAYBACK VOLUME</b>	Adjust the volume for movie playback.



 **SCREEN SET-UP**

Adjust display settings.

Option	Description
<b>IMAGE DISP.</b>	Choose how long pictures are displayed in the LCD monitor after shooting. • <b>1.5 SEC, 0.5 SEC:</b> Pictures are displayed for 1.5 seconds ( <b>1.5 SEC</b> ) or 0.5 seconds ( <b>0.5 SEC</b> ). Colors may differ slightly from those in the final image. • <b>ZOOM (CONTINUOUS):</b> Pictures are displayed until the <b>MENU/OK</b> button is pressed. • <b>OFF:</b> Pictures are not displayed after shooting.
<b>LCD BRIGHTNESS</b>	Control the brightness of the display.
<b>MONITOR SUNLIGHT MODE</b>	Select <b>ON</b> to make the display in the monitor easier to read in bright light (  7).
<b>AUTOROTATE PB</b>	Choose <b>ON</b> to automatically rotate "tall" (portrait-orientation) pictures during playback.
<b>BACKGROUND COLOR</b>	Choose a color scheme.
<b>START-UP SCREEN</b>	Choose whether the camera displays a splash screen at startup.

## POWER MANAGEMENT





Adjust power management settings.

Option	Description
<b>AUTO POWER OFF</b>	Choose the length of time before the camera turns off automatically when no operations are performed. Shorter times increase battery life; if <b>OFF</b> is selected, the camera must be turned off manually. Note that in some situations the camera turns off automatically even when <b>OFF</b> is selected.
<b>POWER MANAGEMENT</b>	<p>Optimize camera performance for increased battery life or display quality.</p> <ul style="list-style-type: none"> <li>•  <b>POWER SAVE:</b> The display dims to save power if no operations are performed for a short period, but can be restored by operating camera controls. Select this option to save power.</li> <li>•  <b>CLEAR DISPLAY:</b> Choose this option for a brighter, higher quality display and for a longer delay before the monitor dims to save power.</li> </ul> <p> <b>POWER SAVE</b> does not take effect when Intelligent Face Detection is on.</p>

### IS MODE

(default: )

Choose from the following image stabilization options:

Option	Description
 <b>CONTINUOUS + MOTION</b>	Image stabilization on. If <b>+ MOTION</b> is selected, the camera will adjust shutter speed to reduce motion blur when a moving objects are detected.
 <b>CONTINUOUS</b>	
 <b>SHOOTING + MOTION</b>	As above, except that image stabilization is performed only when the shutter button is pressed halfway or the shutter is released.
 <b>SHOOTING ONLY</b>	
<b>OFF</b>	Image stabilization off. Choose this option when using a tripod.

◆ **+ MOTION** has no effect when sensitivity is set to a fixed value, and may also be unavailable at some other combinations of settings. The effect may vary with lighting conditions and the speed at which the object is moving.

### RED EYE REMOVAL

(default: **ON**)

Choose **ON** to remove red-eye effects caused by the flash when shooting with Intelligent Face Detection.

◆ Red-eye reduction is performed only when a face is detected.

**INTELLIGENT DIGITAL ZOOM**(default: **OFF**)

If **ON** is selected, selecting [Z] at the maximum optical zoom position triggers intelligent digital zoom, further magnifying the image while processing it for sharp, high-resolution results.

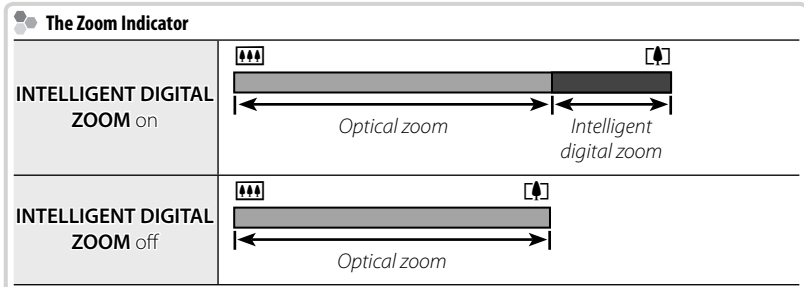

- ❖ Selecting another mode may end intelligent digital zoom and restore maximum optical zoom.
- ❖ In **EXR** mode, the camera will match the **EXR** mode to the scene for zoom ratios of up to 40x when combined with optical zoom.
- ❖ Intelligent digital zoom may sometimes produce lower quality images than optical zoom.
- ❖ Intelligent digital zoom is not available in continuous mode or during movie recording.

**AF ILLUMINATOR**(default: **ON**)

If **ON** is selected, the AF-assist illuminator will light to assist autofocus.

- ⓘ The camera may be unable to focus using the AF-assist illuminator in some cases. If the camera is unable to focus in macro mode, try increasing the distance to the subject.
- ⓘ Avoid shining the AF-assist illuminator directly into your subject's eyes.

## SAVE DATA SET-UP

Adjust file-management settings.

Option	Description
<b>FRAME NO.</b>	<p>New pictures are stored in image files named using a four-digit file number assigned by adding one to the last file number used. The file number is displayed during playback as shown at right. <b>FRAME NO.</b> controls whether file numbering is reset to 0001 when a new memory card is inserted or the current memory card or internal memory is formatted.</p> <div data-bbox="751 184 965 326" style="text-align: right;"> </div> <ul style="list-style-type: none"> <li>• <b>CONTINUOUS:</b> Numbering continues from the last file number used or the first available file number, whichever is higher. Choose this option to reduce the number of pictures with duplicate file names.</li> <li>• <b>RENEW:</b> Numbering is reset to 0001 after formatting or when a new memory card is inserted.</li> </ul> <ul style="list-style-type: none"> <li>◆ If the frame number reaches 999-9999, the shutter release will be disabled (🗨 114).</li> <li>◆ Selecting <b>RESET</b> (🗨 92) sets <b>FRAME NO.</b> to <b>CONTINUOUS</b> but does not reset the file number.</li> <li>◆ Frame numbers for pictures taken with other cameras may differ.</li> </ul>
<b>SAVE ORG IMAGE</b>	<p>Choose <b>ON</b> to save unprocessed copies of seamless 📷 panoramas or pictures taken using <b>RED EYE REMOVAL</b>, <b>PRO LOW-LIGHT MODE</b>, or <b>PRO FOCUS MODE</b>.</p>



## SAVE DATA SET-UP (Continued)

Option	Description
<b>DATE STAMP</b>	<p>Stamp the time and/or date of recording on photographs as they are taken.</p> <ul style="list-style-type: none"> <li>•  + : Stamp new photographs with the date and time of recording.</li> <li>• : Stamp new photographs with the date of recording.</li> <li>• <b>OFF</b>: Do not stamp the time and date on new photographs.</li> </ul> <p>① Time and date stamps can not be deleted. Turn <b>DATE STAMP</b> off to prevent time and date stamps appearing on new photographs.</p> <p>① If the camera clock is not set, you will be prompted to set the clock to the current date and time ( 17).</p> <p>① We recommend that you turn the DPOF “print date” option off when printing images with a time and date stamp ( 65).</p> <p>① Time and date stamps do not appear on movies, panoramas, or pictures taken with best frame capture.</p>





**Eye-Fi TRANSFER**(default: **ON**)

The camera can be used with third-party Eye-Fi cards; for more information see the manual provided with the card or contact the manufacturer.

Option	Description
<b>ON</b>	Pictures taken with the camera are uploaded to a pre-selected destination.
<b>OFF</b>	Pictures are not uploaded automatically.

- ⓘ Observe local regulations regarding the use of wireless devices when using Eye-Fi cards. Select **OFF** in aircraft, hospitals, and other locations where the use of wireless devices is prohibited; note that even when the camera is turned off, wireless transmission will continue until upload is complete.

 **The Eye-Fi Icon**

Icon	Status
	Standby/no connection
 (blinks)	Connecting
 (animated)	Upload in progress
 (red)	Error

**FORMAT**

If a memory card is inserted in the camera, this option will format the memory card. If no memory card is inserted, this option will format internal memory.

- ⓘ All data—including protected pictures—will be deleted from the memory card or internal memory. Be sure important files have been copied to a computer or other storage device.
- ⓘ Do not open the battery-chamber cover during formatting.

# Technical Notes

## Optional Accessories

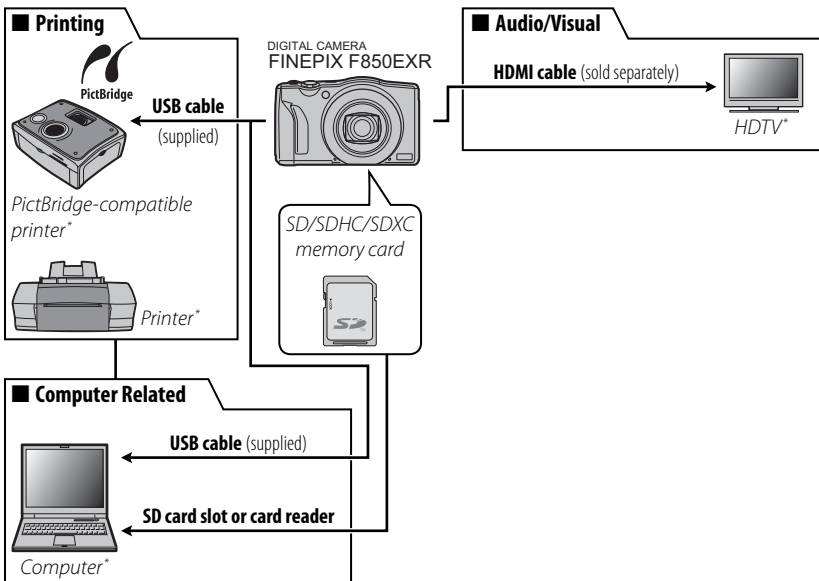

The camera supports a wide range of accessories from FUJIFILM and other manufacturers.



\* Available separately.

**Accessories from FUJIFILM**

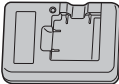
The following optional accessories are available from FUJIFILM. For the latest information on the accessories available in your region, check with your local FUJIFILM representative or visit [http://www.fujifilm.com/products/digital\\_cameras/index.html](http://www.fujifilm.com/products/digital_cameras/index.html).

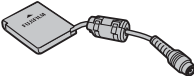
<b>Rechargeable Li-ion batteries</b>	<b>NP-50:</b> Additional large-capacity NP-50 rechargeable batteries can be purchased as required. Note that the NP-50 may record fewer photos per charge than the NP-50A.	
<b>Battery chargers</b>	<b>BC-45W:</b> Replacement battery chargers can be purchased as required. The BC-45W charges an NP-50A/NP-50 battery in about 150 minutes at +20 °C (+68 °F).	
<b>AC power adapters</b>	<b>AC-5VX</b> (requires CP-50 DC coupler): Use for extended playback or when copying pictures to a computer (shape of adapter and plug vary with region of sale).	
<b>DC couplers</b>	<b>CP-50:</b> Connect the AC-5VX to the camera.	

## Caring for the Camera

---

To ensure continued enjoyment of the product, observe the following precautions.

### ***Storage and Use***

If the camera will not be used for an extended period, remove the battery and memory card. Do not store or use the camera in locations that are:

- exposed to rain, steam, or smoke
- very humid or extremely dusty
- exposed to direct sunlight or very high temperatures, such as in a closed vehicle on a sunny day
- extremely cold
- subject to strong vibration
- exposed to strong magnetic fields, such as near a broadcasting antenna, power line, radar emitter, motor, transformer, or magnet
- in contact with volatile chemicals such as pesticides
- next to rubber or vinyl products

### ■ **Water and Sand**

Exposure to water and sand can also damage the camera and its internal circuitry and mechanisms. When using the camera at the beach or seaside, avoid exposing the camera to water or sand. Do not place the camera on a wet surface.

### ■ **Condensation**

Sudden increases in temperature, such as occur when entering a heated building on a cold day, can cause condensation inside the camera. If this occurs, turn the camera off and wait an hour before turning it on again. If condensation forms on the memory card, remove the card and wait for the condensation to dissipate.

### **Cleaning**

Use a blower to remove dust from the lens and LCD monitor, then gently wipe with a soft, dry cloth. Any remaining stains can be removed by wiping gently with a piece of FUJIFILM lens-cleaning paper to which a small amount of lens-cleaning fluid has been applied. Care should be taken to avoid scratching the lens or LCD monitor. The camera body can be cleaned with a soft, dry cloth. Do not use alcohol, thinner, or other volatile chemicals.

### **Traveling**

Keep the camera in your carry-on baggage. Checked baggage may suffer violent shocks that could damage the camera.

# Troubleshooting

## Problems and Solutions

### Power and Battery

Problem	Solution
The camera does not turn on.	<ul style="list-style-type: none"><li>• <b>The battery is exhausted:</b> Charge the battery or insert a fully-charged spare battery (📖 8).</li><li>• <b>The battery is inserted incorrectly:</b> Reinsert in the correct orientation (📖 10).</li><li>• <b>The battery-chamber cover is not latched:</b> Latch the battery-chamber cover (📖 10).</li><li>• <b>The AC power adapter and DC coupler are connected incorrectly:</b> Reconnect the AC power adapter and DC coupler.</li></ul>
The battery runs down quickly.	<ul style="list-style-type: none"><li>• <b>The battery is cold:</b> Warm the battery by placing it in a pocket or other warm place and reinsert it in the camera immediately before taking a picture.</li><li>• <b>There is dirt on the battery terminals:</b> Clean the terminals with a soft, dry cloth.</li><li>• <b>📷 CLEAR DISPLAY is selected for 📷 POWER MANAGEMENT &gt; POWER MANAGEMENT:</b> Select 📷 POWER SAVE to reduce the drain on the battery (📖 95).</li><li>• <b>ON is selected for 📷 SCREEN SET-UP &gt; MONITOR SUNLIGHT MODE:</b> Select OFF to reduce the drain on the battery (📖 7).</li><li>• <b>EXTRA is selected for shooting mode:</b> Select 📷 mode to reduce the drain on the battery (📖 23).</li><li>• <b>📷 CONTINUOUS or 📷 TRACKING is selected for 📷 FOCUS MODE:</b> Select a different AF mode (📖 80).</li><li>• <b>The battery has been charged many times:</b> The battery has reached the end of its charging life. Purchase a new battery.</li></ul>
The camera turns off suddenly.	<ul style="list-style-type: none"><li>• <b>The battery is exhausted:</b> Charge the battery or insert a fully-charged spare battery (📖 8).</li><li>• <b>The AC power adapter or DC coupler has been disconnected:</b> Reconnect the AC power adapter and DC coupler.</li></ul>
Charging does not start.	Reinsert the battery in the correct orientation and make sure that the charger is plugged in (📖 8).

Problem	Solution
Charging is slow.	Charge the battery at room temperature (📖 vi).
The charging lamp lights, but the battery does not charge.	<ul style="list-style-type: none"> <li>• <b>There is dirt on the battery terminals:</b> Clean the terminals with a soft, dry cloth.</li> <li>• <b>The battery has been charged many times:</b> The battery has reached the end of its charging life. Purchase a new battery. If the battery still fails to charge, contact your FUJIFILM dealer.</li> <li>• <b>The battery is too hot or too cold:</b> Wait for the battery temperature to stabilize (📖 8).</li> </ul>

## ■ Menus and Displays



Problem	Solution
Menus and displays are not in English.	Select <b>ENGLISH</b> for 🗨️ 言語/LANG. (📖 17, 92).



## ■ Shooting

Problem	Solution
No picture is taken when the shutter button is pressed.	<ul style="list-style-type: none"> <li>• <b>Memory is full:</b> Insert a new memory card or delete pictures (📖 11, 54).</li> <li>• <b>Memory is not formatted:</b> Format the memory card or internal memory (📖 100).</li> <li>• <b>There is dirt on the memory card contacts:</b> Clean the contacts with a soft, dry cloth.</li> <li>• <b>The memory card is damaged:</b> Insert a new memory card (📖 11).</li> <li>• <b>The battery is exhausted:</b> Charge the battery or insert a fully-charged spare battery (📖 8).</li> <li>• <b>The camera has turned off automatically:</b> Turn the camera on (📖 15).</li> <li>• <b>The indicator lamp was orange when you attempted to record a panorama:</b> Wait until the indicator lamps turns off (📖 3).</li> </ul>
The LCD monitor goes dark after shooting.	The LCD monitor may darken while the flash charges. Wait for the flash to charge (📖 39).



Problem	Solution
The camera does not focus.	<ul style="list-style-type: none"> <li>• <b>The subject is close to the camera:</b> Select macro mode (📖 38).</li> <li>• <b>The subject is far away from the camera:</b> Cancel macro mode (📖 38).</li> <li>• <b>The subject is not suited to autofocus:</b> Use focus lock (📖 35).</li> </ul>
Pictures are not the same size.	If <b>AUTO</b> is selected for <b>IMAGE SIZE</b> in <b>EXTRA</b> mode, the camera will optimize not only sensitivity and other settings, but also image size. To record all pictures at the same size, choose another shooting mode or select another option for <b>IMAGE SIZE</b> (📖 75).
Macro mode is not available.	Choose a different shooting mode (📖 23).
Intelligent Face Detection is not available.	<b>Intelligent Face Detection is not available in the current shooting mode:</b> Choose a different shooting mode (📖 23).
No face is detected.	<ul style="list-style-type: none"> <li>• <b>The subject's face is obscured by sunglasses, a hat, long hair, or other objects:</b> Remove the obstructions.</li> <li>• <b>The subject's face occupies only a small area of the frame:</b> Change the composition so that the subject's face occupies a larger area of the frame (📖 35).</li> <li>• <b>The subject's head is tilted or horizontal:</b> Ask the subject to hold their head straight.</li> <li>• <b>The camera is tilted:</b> Keep the camera level (📖 19).</li> <li>• <b>The subject's face is poorly lit:</b> Shoot in bright light.</li> </ul>
Wrong subject is selected.	The selected subject is closer to the center of the frame than the main subject. Recompose the picture or turn face detection off and frame the picture using focus lock (📖 35).

Problem	Solution
The flash does not fire.	<ul style="list-style-type: none"> <li>• <b>The flash is not available in the current shooting mode:</b> Choose a different shooting mode (📖 23).</li> <li>• <b>The battery is exhausted:</b> Charge the battery or insert a fully-charged spare battery (📖 8).</li> <li>• <b>The camera is in continuous mode:</b> Select  for  <b>CONTINUOUS</b> (📖 45).</li> <li>• <b>The camera is in silent mode:</b> Turn silent mode off (📖 93).</li> <li>• <b>The flash is not raised:</b> Raise the flash (📖 39).</li> </ul>
Some flash modes are not available.	<ul style="list-style-type: none"> <li>• <b>The desired flash mode is not available in the current shooting mode:</b> Choose a different shooting mode (📖 23).</li> <li>• <b>The camera is in silent mode:</b> Turn silent mode off (📖 93).</li> </ul>
The flash does not fully light the subject.	<ul style="list-style-type: none"> <li>• <b>The subject is not in range of the flash:</b> Position the subject in range of the flash (📖 119).</li> <li>• <b>The flash window is obstructed:</b> Hold the camera correctly (📖 19).</li> <li>• <b>Fast shutter speed selected:</b> Choose a slower shutter speed (📖 33, 34).</li> </ul>
Pictures are blurred.	<ul style="list-style-type: none"> <li>• <b>The lens is dirty:</b> Clean the lens (📖 104).</li> <li>• <b>The lens is blocked:</b> Keep objects away from the lens (📖 19).</li> <li>• <b>!AF is displayed during shooting and the focus frame is displayed in red:</b> Check focus before shooting (📖 112).</li> <li>• <b>!C is displayed during shooting:</b> Use the flash or a tripod (📖 40).</li> </ul>
Pictures are mottled.	<ul style="list-style-type: none"> <li>• <b>A slow shutter speed is selected at high temperatures:</b> This is normal and does not indicate a malfunction.</li> <li>• <b>The camera has been used continuously at high temperatures or a temperature warning is displayed:</b> Turn the camera off and wait for it to cool down.</li> </ul>



Problem	Solution
Pictures are not recorded.	Power was interrupted during shooting. Before connecting the AC power adapter or DC coupler, turn the camera off. Leaving the camera on can result in corrupted files or damage to the memory card or internal memory.
Sounds made by the camera are recorded with movies.	<ul style="list-style-type: none"> <li>•  <b>CONTINUOUS is selected for  MOVIE SET-UP &gt; MOVIE AF MODE:</b> Select a different AF mode (📖 81).</li> <li>• <b>Zoom was adjusted during shooting:</b> Do not adjust zoom during shooting.</li> <li>• <b>Intelligent Face Detection is on:</b> Turn Intelligent Face Detection off (📖 49).</li> </ul>

## ■ Playback

Problem	Solution
Pictures are grainy.	The pictures were taken with a different make or model of camera.
Playback zoom unavailable.	The picture has been saved at <b>6.40</b> , or is from another make or model of camera (📖 52).
No sound in movie playback.	<ul style="list-style-type: none"> <li>• <b>Playback volume is too low:</b> Adjust playback volume (📖 93).</li> <li>• <b>The microphone was obstructed:</b> Hold the camera correctly during recording (📖 2, 19).</li> <li>• <b>The speaker is obstructed:</b> Hold the camera correctly during playback (📖 2, 19).</li> </ul>
Selected pictures are not deleted.	Some of the pictures selected for deletion are protected. Remove protection using the device with which it was originally applied (📖 87).
File numbering is unexpectedly reset.	The battery-chamber cover was opened while the camera was on. Turn the camera off before opening the battery-chamber cover.





## ■ Connections/Miscellaneous

Problem	Solution
No picture or sound.	<ul style="list-style-type: none"> <li>• <b>The camera is not properly connected:</b> Connect the camera properly (📖 62).</li> <li>• <b>Input on the television is set to “TV”:</b> Set input to “HDMI”.</li> <li>• <b>The volume on the TV is too low:</b> Adjust the volume.</li> </ul>
The computer does not recognize the camera.	Be sure the camera and computer are correctly connected (📖 70).
Can not transfer RAW or JPEG files to computer.	Use the bundled software to transfer pictures (📖 67).
Pictures can not be printed.	<ul style="list-style-type: none"> <li>• <b>The camera is not properly connected:</b> Connect the camera correctly (📖 63).</li> <li>• <b>The printer is off:</b> Turn the printer on.</li> </ul>
Only one copy is printed/ the date is not printed.	The printer is not PictBridge compatible.
The camera is unresponsive.	<ul style="list-style-type: none"> <li>• <b>Temporary camera malfunction:</b> Remove and reinsert the battery (📖 10) or disconnect and reconnect the AC power adapter/DC coupler.</li> <li>• <b>The battery is exhausted:</b> Charge the battery (📖 8) or insert a fully-charged spare battery (📖 10).</li> </ul>













Problem	Solution
The camera does not function as expected.	Remove and reinsert the battery (📖 10) or disconnect and reconnect the AC power adapter/DC coupler. If the problem persists, contact your FUJIFILM dealer.
I want to use an AC power adapter and DC coupler overseas.	Check the label on the AC power adapter. The AC power adapter can be used with voltages of 100 – 240V. Consult your travel agent for information on plug adapters.
No sound.	Turn silent mode off (📖 93).
Hue or content of display changes unexpectedly.	Choose <b>OFF</b> for  <b>SCREEN SET-UP &gt; MONITOR SUNLIGHT MODE</b> (📖 7).
Time and date stamps	<ul style="list-style-type: none"> <li>• <b>Time and date stamps are not correct:</b> Set the camera clock (📖 17).</li> <li>• <b>Time and date stamps appear on photographs:</b> Time and date stamps can not be deleted. To prevent stamps appearing on new photographs, select <b>OFF</b> for  <b>SAVE DATA SET-UP &gt; DATE STAMP</b> (📖 99).</li> </ul>

## Warning Messages and Displays



The following warnings are displayed in the LCD monitor:

Warning	Description
 (red)	Low battery. Charge the battery (📖 8) or insert a fully-charged spare battery (📖 10).
 (blinks red)	Battery exhausted. Charge the battery (📖 8) or insert a fully-charged spare battery (📖 10).
	Slow shutter speed. Pictures may be blurred; use the flash or a tripod.
<b>!AF</b> (displayed in red with red focus frame)	The camera can not focus. Try one of the following solutions: <ul style="list-style-type: none"><li>• Use focus lock to focus on another subject at the same distance, then recompose the picture (📖 35).</li><li>• Use macro mode to focus when taking close-ups (📖 38).</li></ul>
Aperture or shutter speed displayed in red	The subject is too bright or too dark and the picture will be over- or under-exposed. If the subject is dark, use the flash (📖 39).
FOCUS ERROR	
TURN OFF THE CAMERA AND TURN ON AGAIN	Camera malfunction or moving parts of lens obstructed. Turn the camera off and then on again, taking care not to touch the lens. If the message persists, contact a FUJIFILM dealer.
LENS CONTROL ERROR	
CARD NOT INITIALIZED	<ul style="list-style-type: none"><li>• <b>The memory card or internal memory is not formatted or the memory card was formatted in a computer or other device:</b> Format the memory card or internal memory using the  <b>FORMAT</b> option in the camera setup menu (📖 100).</li><li>• <b>The memory card contacts require cleaning:</b> Clean the contacts with a soft, dry cloth. If the message is repeated, format the card (📖 100). If the message persists, replace the card.</li><li>• <b>Camera malfunction:</b> Contact a FUJIFILM dealer.</li></ul>
PROTECTED CARD	The memory card is locked. Unlock the card (📖 11).
BUSY	The memory card is incorrectly formatted. Use the camera to format the card (📖 100).

Warning	Description
	Turn the camera off and wait for it to cool. If no action is taken, the camera will turn off automatically.
CARD ERROR	The memory card is not formatted for use in the camera. Format the card (📖 100).
	The memory card contacts require cleaning or the memory card is damaged. Clean the contacts with a soft, dry cloth. If the message is repeated, format the card (📖 100). If the message persists, replace the card.
	Incompatible memory card. Use a compatible card (📖 13).
	Camera malfunction. Contact a FUJIFILM dealer.
MEMORY FULL	
INTERNAL MEMORY IS FULL INSERT A NEW CARD	The memory card or internal memory is full and pictures can not be recorded or copied. Delete pictures or insert a memory card with more free space.
WRITE ERROR	<ul style="list-style-type: none"> <li>• <b>Memory card error or connection error:</b> Reinsert the card or turn the camera off and then on again. If the message persists, contact a FUJIFILM dealer.</li> <li>• <b>Not enough memory remaining to record additional pictures:</b> Delete pictures or insert a memory card with more free space.</li> <li>• <b>The memory card or internal memory is not formatted:</b> Format the memory card or internal memory (📖 100).</li> </ul>
READ ERROR	<ul style="list-style-type: none"> <li>• <b>The file is corrupt or was not created with the camera:</b> The file can not be viewed.</li> <li>• <b>The memory card contacts require cleaning:</b> Clean the contacts with a soft, dry cloth. If the message is repeated, format the card (📖 100). If the message persists, replace the card.</li> <li>• <b>Camera malfunction:</b> Contact a FUJIFILM dealer.</li> </ul>

Warning	Description
FRAME NO. FULL	The camera has run out of frame numbers (current frame number is 999-9999). Format the memory card and select <b>RENEW</b> for  <b>SAVE DATA SET-UP &gt; FRAME NO.</b> Take a picture to reset frame numbering to 100-0001, then select <b>CONTINUOUS</b> for <b>FRAME NO.</b> (  98).
PRESS AND HOLD THE DISP BUTTON TO DEACTIVATE SILENT MODE	An attempt was made to choose a flash mode or adjust the volume with the camera in silent mode. Exit silent mode before choosing a flash mode or adjusting the volume (  93).
TOO MANY FRAMES	<ul style="list-style-type: none"> <li>• <b>A search has returned more than 30,000 results:</b> Choose a search that returns fewer results.</li> <li>• <b>More than 999 images are selected for deletion:</b> Choose fewer images.</li> </ul>
PROTECTED FRAME	An attempt was made to delete or rotate a protected picture. Remove protection and try again (  87).
 CAN NOT CROP	 pictures can not be cropped.
CAN NOT CROP	The picture is damaged or was not created with the camera.
 CANNOT EXECUTE	An attempt was made to create a resized copy at a size equal to or larger than the original. Choose a smaller size.
 CANNOT EXECUTE	
 CANNOT EXECUTE	
CAN NOT ROTATE	An attempt was made to rotate a picture that can not be rotated.
 CAN NOT ROTATE	Movies can not be rotated.
 CANNOT EXECUTE	Red-eye removal can not be applied to the selected picture.
 CANNOT EXECUTE	Red-eye removal can not be applied to movies.



Warning	Description
NO CARD	No memory card inserted when  COPY is selected. Insert a memory card.
NO IMAGE	The source selected for  COPY contains no images. Select a different source.
DPOF FILE ERROR	The DPOF print order on the current memory card contains more than 999 images. Copy the pictures to internal memory and create a new print order.
CAN NOT SET DPOF	The picture can not be printed using DPOF.
 CAN NOT SET DPOF	Movies can not be printed using DPOF.
COMMUNICATION ERROR	A connection error occurred while pictures were being printed or copied to a computer or other device. Confirm that the device is turned on and that the USB cable is connected.
PRINTER ERROR	Printer out of paper or ink, or other printer error. Check printer (see printer manual for details). To resume printing, turn the printer off and then turn it back on.
PRINTER ERROR RESUME?	Printer out of paper or ink, or other printer error. Check printer (see printer manual for details). If printing does not resume automatically, press <b>MENU/OK</b> to resume.
CANNOT BE PRINTED	An attempt was made to print a movie, a picture not created with the camera, or a picture in a format not supported by the printer. Movies and some pictures created with other devices can not be printed; if the picture is a still picture created with the camera, check the printer manual to confirm that the printer supports the JFIF-JPEG or Exif-JPEG format. If it does not, the pictures can not be printed.

# Appendix

## Memory Card Capacity

The following table shows the recording time or number of pictures available at different image sizes. All figures are approximate; file size varies with the scene recorded, producing wide variations in the number of files that can be stored, and the number of exposures or length remaining may not diminish at an even rate. A limited number of test pictures can be taken when no memory card is inserted.

### Photographs

		L				M				S			
		4:3	3:2	16:9	1:1	4:3	3:2	16:9	1:1	4:3	3:2	16:9	1:1
4 GB	FINE	600	680	800	800	960	1070	1260	1290	1880	2110	3440	2460
	NORMAL	960	1080	1280	1280	1880	2130	2460	2510	3540	4020	6340	4630
8 GB	FINE	1210	1360	1600	1600	1910	2110	2520	2570	3740	4200	6840	4890
	NORMAL	1910	2150	2540	2540	3740	4200	4890	4990	7050	7990	12610	9220

### Movies

	<b>FHD</b> 1920 × 1080 (60 fps) <sup>1</sup>	<b>HD</b> 1280 × 720 (60 fps) <sup>2</sup>	<b>640</b> 640 × 480 (30 fps) <sup>3</sup>	<b>HS</b> 640 × 480 (80 fps) <sup>4</sup>	<b>HS</b> 320 × 240 (160 fps) <sup>4</sup>	<b>HS</b> 320 × 112 (320 fps) <sup>4</sup>
4 GB	13 min.	25 min.	112 min.	83 min.	167 min.	83 min.
8 GB	26 min.	51 min.	223 min.	166 min.	332 min.	166 min.





1 Use a CLASSIC card or better. Individual movies can not exceed 14 minutes in length.

2 Use a CLASSIC card or better. Individual movies can not exceed 27 minutes in length.

3 Individual movies can not exceed 115 minutes in length.

4 Use a CLASSIC card or better. Individual movies can not exceed 30 seconds in length.

# Specifications

System	
<b>Model</b>	Digital Camera FinePix F850EXR
<b>Effective pixels</b>	16 million
<b>Image sensor</b>	½-in., EXR CMOS sensor with primary color filter
<b>Storage media</b>	• Internal memory (approx. 21 MB) • SD/SDHC/SDXC memory cards
<b>File system</b>	Compliant with Design Rule for Camera File System (DCF), Exif 2.3, and Digital Print Order Format (DPOF)
<b>File format</b>	• <b>Still pictures:</b> Exif 2.3 JPEG (compressed) • <b>Movies:</b> H.264 standard with linear PCM stereo sound (MOV)
<b>Image size (pixels)</b>	• <b>L 4:3:</b> 4,608 × 3,456 • <b>M 4:3:</b> 3,264 × 2,448 • <b>S 4:3:</b> 2,304 × 1,728 • <b>L 3:2:</b> 4,608 × 3,072 • <b>M 3:2:</b> 3,264 × 2,176 • <b>S 3:2:</b> 2,304 × 1,536 • <b>L 16:9:</b> 4,608 × 2,592 • <b>M 16:9:</b> 3,264 × 1,840 • <b>S 16:9:</b> 1,920 × 1,080 • <b>L 1:1:</b> 3,456 × 3,456 • <b>M 1:1:</b> 2,432 × 2,432 • <b>S 1:1:</b> 1,728 × 1,728 •  <b>MOTION PANORAMA 16:9:</b> 1,624 × 11,520 (tall)/11,520 × 1,080 (wide) •  <b>MOTION PANORAMA 10:3:</b> 1,624 × 5,760 (tall)/5,760 × 1,080 (wide) •  <b>MOTION PANORAMA 12:5:</b> 1,624 × 3,840 (tall)/3,840 × 1,080 (wide) •  <b>MOTION PANORAMA 16:9:</b> 1,624 × 11,520 (tall)/11,520 × 1,080 (wide)
<b>Lens</b>	Fujinon 20× optical zoom lens, F3.5 (wide angle) – F5.3 (telephoto)
<b>Focal length</b>	f=4.6 mm–92.0 mm (35-mm format equivalent: 25 mm–500 mm)
<b>Digital zoom</b>	Up to about 3.4× with intelligent digital zoom (up to 68× when combined with optical zoom)
<b>Aperture</b>	F3.5/F7.1/F10.0 (wide angle), F5.3/F11.0/F16.0 (telephoto); uses Neutral Density (ND) filter

## System

<b>Focus range</b> (distance from front of lens)	Approx. 45 cm (1.4 ft.)–infinity (wide angle); 2.5 m (8.2 ft.)–infinity (telephoto) • <b>Macro:</b> approx. 5 cm–3.0 m/1.9 in.–9.8 ft. (wide angle); 1.3 m–3.0 m/4.2 ft.–9.8 ft. (telephoto)		
<b>Sensitivity</b>	Standard output sensitivity equivalent to ISO 100, 200, 400, 800, 1600, 3200, 6400 (image size <b>M</b> or <b>S</b> ), 12800 (image size <b>S</b> ); AUTO, AUTO (400), AUTO (800), AUTO (1600), AUTO (3200)		
<b>Metering</b>	256-segment through-the-lens (TTL) metering; MULTI, SPOT, AVERAGE		
<b>Exposure control</b>	Programmed AE; aperture-priority AE; shutter-priority AE; manual exposure		
<b>Exposure compensation</b>	–2 EV – +2 EV in increments of 1/3 EV		
<b>Picture stabilization</b>	Optical stabilization (image-sensor shift)		
<b>Shutter speed</b> (combined mechanical and electronic shutter)	8 s–1/2,000 s • : 1/4 s–1/1,000 s • : 3 s–1/1,000 s • : 4 s–1/2 s • <b>S</b> : 2 s–1/2,000 s • <b>Other modes:</b> 1/4 s–1/2,000 s		

## Continuous

	Approx. frame rate (fps)	Continuous frames (Image size)
	3.0	5 ( <b>L M S</b> )
	6.0	
	9.0	
	13	14 ( <b>M S</b> )
	3.0	7 ( <b>L M S</b> )
	6.0	
	9.0	14 ( <b>M S</b> )
	13	7 ( <b>M S</b> ), 14 ( <b>M S</b> )

The frame rate varies with shooting conditions and the number of images recorded.

## System

<b>Focus</b>	<ul style="list-style-type: none"> <li>• <b>Mode:</b> Center AF, multi AF, continuous AF, tracking AF</li> <li>• <b>Autofocus system:</b> Contrast-detect TTL AF</li> </ul>
<b>White balance</b>	Custom, auto, direct sunlight, shade, daylight fluorescent, warm white fluorescent, cool white fluorescent, incandescent, underwater
<b>Self-timer</b>	Off, 2 sec., 10 sec.; auto shutter release
<b>Flash</b>	Auto flash; effective range when sensitivity is set to <b>AUTO</b> is approx. 15 cm–3.7 m/0.4 ft.–12.1 ft. (wide angle; note that lens may block flash at short ranges), 90 cm–2.4 m/2.9 ft.–7.8 ft. (telephoto)
<b>Flash mode</b>	Auto, fill flash, off, slow sync (red-eye removal off); auto with red-eye removal, fill flash with red-eye removal, off, slow sync with red-eye removal (red-eye removal on)
<b>LCD monitor</b>	3.0-in., 920k-dot color LCD monitor; frame coverage approx. 100%
<b>Movies</b>	<ul style="list-style-type: none"> <li>• <b>FHD</b> 1920 × 1080 (60 fps), 1080p</li> <li>• <b>HD</b> 1280 × 720 (60 fps), 720p</li> <li>• <b>640</b> 640 × 480 (30 fps), VGA</li> <li>• <b>HS</b> 640 × 480 (80 fps)</li> <li>• <b>HS</b> 320 × 240 (160 fps)</li> <li>• <b>HS</b> 320 × 112 (320 fps)</li> </ul> <p><b>Note:</b> <b>FHD</b>, <b>HD</b>, and <b>640</b> movies are recorded with stereo sound.</p>

## Specifications

### Input/output terminals

<b>HDMI output</b>	HDMI mini connector
<b>Digital input/output</b>	USB 2.0 High-Speed; MTP/PTP

### Power supply/other

<b>Power supply</b>	<ul style="list-style-type: none"><li>NP-50A rechargeable battery</li><li>AC-5VX AC power adapter and CP-50 DC coupler (sold separately)</li></ul>
---------------------	--

**Battery life** (approximate number of frames that can be taken with a fully-charged battery)

Battery type	Approximate number of frames
NP-50A (type supplied with camera)	250

CIPA standard, measured in  (auto) mode using battery supplied with camera and SD memory card.

**Note:** Number of shots that can be taken with battery varies with battery charge level and will decline at low temperatures.

<b>Dimensions</b> (W × H × D)	105.1 mm × 63.3 mm × 36.0 mm/4.1 in. × 2.4 in. × 1.4 in., excluding projections (minimum depth 24.9 mm/0.9 in.)
-------------------------------	---

<b>Shooting weight</b>	Approx. 230 g/8.1 oz., including battery and memory card
------------------------	--

<b>Camera weight</b>	Approx. 210 g/7.4 oz., excluding battery, accessories, and memory card
----------------------	--

<b>Operating conditions</b>	<ul style="list-style-type: none"><li><b>Temperature:</b> 0 °C – +40 °C/+32 °F – +104 °F</li><li><b>Humidity:</b> 10–80% (no condensation)</li></ul>
-----------------------------	--



### ■ Notices

- Specifications subject to change without notice; for the latest information, visit [http://www.fujifilm.com/products/digital\\_cameras/index.html](http://www.fujifilm.com/products/digital_cameras/index.html). FUJIFILM shall not be held liable for damages resulting from errors in this manual.
- Although the LCD monitor is manufactured using advanced high-precision technology, small bright points and anomalous colors may appear, particularly in the vicinity of text. This is normal for this type of LCD monitor and does not indicate a malfunction; images recorded with the camera are unaffected.
- Digital cameras may malfunction when exposed to strong radio interference (e.g., electric fields, static electricity, or line noise).
- Due to the type of lens used, some distortion may occur at the periphery of images. This is normal.





# FUJIFILM

---

**FUJIFILM Corporation**

7-3, AKASAKA 9-CHOME, MINATO-KU, TOKYO 107-0052, JAPAN

[http://www.fujifilm.com/products/digital\\_cameras/index.html](http://www.fujifilm.com/products/digital_cameras/index.html)

Download from [Www.Somanuals.com](http://www.Somanuals.com). All Manuals Search And Download.

# Restrictions on Camera Settings

The options available in each shooting mode are listed below.

Option		Shooting Mode																									
		EXR				Adv.						M A S P			SP												
		1	2	3	4	5	6	7	8	9	M	A	S	P	10	11	12	13	14	15	16	17	18	19	20	21	22
☰	OFF	✓	✓	✓	✓	✓					✓			✓	✓	✓	✓	✓	✓	✓	✓						
	☰	✓	✓	✓	✓	✓					✓			✓	✓	✓	✓	✓	✓	✓	✓						
	☰	✓	✓	✓	✓	✓					✓			✓	✓	✓	✓	✓	✓	✓	✓						
	☰	✓	✓	✓	✓	✓					✓			✓	✓	✓	✓	✓	✓	✓	✓						
	☰	✓	✓	✓	✓	✓	✓	✓	✓	✓	✓	✓	✓	✓	✓	✓	✓	✓	✓	✓	✓	✓	✓	✓	✓	✓	✓
☰	☰	✓	✓	✓	✓	✓					✓			✓	✓	✓	✓	✓	✓	✓							
	☰	✓	✓	✓	✓	✓					✓			✓	✓	✓	✓	✓	✓	✓							
☰	☰	✓	✓	✓	✓	✓					✓			✓	✓	✓	✓	✓	✓	✓							
	OFF	✓	✓	✓	✓	✓					✓			✓	✓	✓	✓	✓	✓	✓					✓	✓	
ISO	AUTO	✓				✓	✓	✓	✓					✓	✓	✓	✓	✓	✓	✓	✓	✓	✓	✓	✓	✓	
	AUTO (3200)			✓	✓					✓			✓														
	AUTO (1600)			✓	✓					✓			✓														
	AUTO (800)		✓	✓	✓					✓			✓														
	AUTO (400)		✓	✓	✓					✓			✓														
	12800 <sup>2</sup>									✓	✓	✓	✓														
	6400 <sup>1</sup>									✓	✓	✓	✓														
	3200			✓	✓					✓			✓														
	1600			✓	✓					✓			✓														
	800		✓	✓	✓					✓			✓														
	400		✓	✓	✓					✓			✓														
	200		✓	✓	✓					✓			✓														
100		✓	✓	✓					✓			✓															
☰	☰	✓																									
	☰	✓			✓	✓				✓			✓	✓	✓	✓	✓	✓	✓	✓	✓	✓	✓	✓	✓		
	☰	✓	✓	✓	✓	✓				✓			✓	✓	✓	✓	✓	✓	✓	✓	✓	✓	✓	✓	✓		
	☰	✓	✓	✓	✓	✓	✓			✓			✓	✓	✓	✓	✓	✓	✓	✓	✓	✓	✓	✓	✓		
☰	FINE	✓	✓	✓	✓	✓	✓	✓	✓	✓	✓	✓	✓	✓	✓	✓	✓	✓	✓	✓	✓	✓	✓	✓	✓		
	NORMAL	✓	✓	✓	✓	✓	✓	✓	✓	✓	✓	✓	✓	✓	✓	✓	✓	✓	✓	✓	✓	✓	✓	✓	✓		

# Restrictions on Camera Settings

Option		Shooting Mode																			
		EXR				Adv.						M A S			SP						
		SR	SR+	SR+	SR+	SR+	SR+	SR+	SR+	SR+	SR+	SR+	SR+	SR+	SR+	SR+	SR+	SR+	SR+	SR+	SR+
3	AUTO	✓																			
	100		✓	✓	✓					✓	✓	✓	✓								
	200				✓					✓	✓	✓	✓								
	400				✓					✓	✓	✓	✓								
	800				✓					✓	✓	✓	✓								
	1600				✓					✓	✓	✓	✓								
4	1	✓	✓	✓	✓	✓	✓	✓	✓	✓	✓	✓	✓	✓	✓	✓	✓	✓	✓	✓	✓
	2	✓	✓	✓	✓	✓	✓	✓	✓	✓	✓	✓	✓	✓	✓	✓	✓	✓	✓	✓	✓
	3	✓	✓	✓	✓	✓	✓	✓	✓	✓	✓	✓	✓	✓	✓	✓	✓	✓	✓	✓	✓
	4	✓	✓	✓	✓	✓	✓	✓	✓	✓	✓	✓	✓	✓	✓	✓	✓	✓	✓	✓	✓
	5	✓	✓	✓	✓	✓	✓	✓	✓	✓	✓	✓	✓	✓	✓	✓	✓	✓	✓	✓	✓
5	1	✓	✓	✓						✓	✓	✓	✓								✓
	2	✓	✓	✓						✓	✓	✓	✓								✓
	3	✓	✓	✓						✓	✓	✓	✓								✓
	4	✓	✓	✓						✓	✓	✓	✓								✓
6	OFF	✓	✓	✓	✓	✓	✓	✓	✓	✓	✓	✓	✓	✓	✓	✓	✓	✓	✓	✓	✓
	ON	✓	✓	✓	✓	✓	✓	✓	✓	✓	✓	✓	✓	✓	✓	✓	✓	✓	✓	✓	✓
7	1	✓	✓	✓	✓	✓	✓	✓	✓	✓	✓	✓	✓	✓	✓	✓	✓	✓	✓	✓	✓
	2	✓	✓	✓						✓	✓	✓	✓								✓
8	1	✓	✓	✓	✓	✓	✓	✓	✓	✓	✓	✓	✓	✓	✓	✓	✓	✓	✓	✓	✓
	2	✓	✓	✓						✓	✓	✓	✓								✓
	3	✓	✓	✓						✓	✓	✓	✓								✓
	4	✓	✓	✓	✓					✓	✓	✓	✓								✓
9	1920 × 1080 (60 fps)																				✓
	1280 × 720 (60 fps)																				✓
	640 × 480 (30 fps)																				✓
	640 × 480 (80 fps)																				✓
	320 × 240 (160 fps)																				✓
	320 × 112 (320 fps)																				✓
	1	1																			✓
1	2																			✓	

Option		Shooting Mode																																					
		EXR				Adv.				M	A	S	P	SP																									
		16:9	4:3	1:1	16:9	4:3	1:1	16:9	4:3	1:1	M	A	S	P	16:9	4:3	1:1	16:9	4:3	1:1	16:9	4:3	1:1	16:9	4:3	1:1	16:9	4:3	1:1	16:9	4:3	1:1	16:9	4:3	1:1				
		✓ <sup>1</sup>	✓	✓	✓	✓	✓	✓	✓	✓	✓	✓	✓	✓	✓	✓	✓	✓	✓	✓	✓	✓	✓	✓	✓	✓	✓	✓	✓	✓	✓	✓	✓	✓	✓	✓			
		✓	✓	✓	✓	✓	✓	✓	✓	✓	✓	✓	✓	✓	✓	✓	✓	✓	✓	✓	✓	✓	✓	✓	✓	✓	✓	✓	✓	✓	✓	✓	✓	✓	✓	✓	✓		
		✓	✓	✓	✓	✓	✓	✓	✓	✓	✓	✓	✓	✓	✓	✓	✓	✓	✓	✓	✓	✓	✓	✓	✓	✓	✓	✓	✓	✓	✓	✓	✓	✓	✓	✓	✓	✓	
	OFF	✓	✓	✓	✓	✓	✓	✓	✓	✓	✓	✓	✓	✓	✓	✓	✓	✓	✓	✓	✓	✓	✓	✓	✓	✓	✓	✓	✓	✓	✓	✓	✓	✓	✓	✓	✓	✓	
	ON	✓	✓	✓	✓	✓	✓	✓	✓	✓	✓	✓	✓	✓	✓	✓	✓	✓	✓	✓	✓	✓	✓	✓	✓	✓	✓	✓	✓	✓	✓	✓	✓	✓	✓	✓	✓	✓	
	OFF	✓	✓	✓	✓	✓	✓	✓	✓	✓	✓	✓	✓	✓	✓	✓	✓	✓	✓	✓	✓	✓	✓	✓	✓	✓	✓	✓	✓	✓	✓	✓	✓	✓	✓	✓	✓	✓	
	ON	✓	✓	✓	✓	✓	✓	✓	✓	✓	✓	✓	✓	✓	✓	✓	✓	✓	✓	✓	✓	✓	✓	✓	✓	✓	✓	✓	✓	✓	✓	✓	✓	✓	✓	✓	✓	✓	✓
	OFF	✓	✓	✓	✓	✓	✓	✓	✓	✓	✓	✓	✓	✓	✓	✓	✓	✓	✓	✓	✓	✓	✓	✓	✓	✓	✓	✓	✓	✓	✓	✓	✓	✓	✓	✓	✓	✓	✓
		✓	✓	✓	✓	✓	✓	✓	✓	✓	✓	✓	✓	✓	✓	✓	✓	✓	✓	✓	✓	✓	✓	✓	✓	✓	✓	✓	✓	✓	✓	✓	✓	✓	✓	✓	✓	✓	✓
		✓	✓	✓	✓	✓	✓	✓	✓	✓	✓	✓	✓	✓	✓	✓	✓	✓	✓	✓	✓	✓	✓	✓	✓	✓	✓	✓	✓	✓	✓	✓	✓	✓	✓	✓	✓	✓	✓

1 Automatically optimized for selected shooting mode.

2 Image sizes over **S** are set to **S**.

3 Image sizes over **M** are set to **M**.

4 Aspect ratio fixed at 4:3.

5 Fixed at settings before recording a movie.

## Free Manuals Download Website

<http://myh66.com>

<http://usermanuals.us>

<http://www.somanuals.com>

<http://www.4manuals.cc>

<http://www.manual-lib.com>

<http://www.404manual.com>

<http://www.luxmanual.com>

<http://aubethermostatmanual.com>

Golf course search by state

<http://golfingnear.com>

Email search by domain

<http://emailbydomain.com>

Auto manuals search

<http://auto.somanuals.com>

TV manuals search

<http://tv.somanuals.com>