



nexia

3100 *ix* Z **MRC**

23-70mm AUTOFOCUS ZOOM CAMERA

Owner's Manual



CERTIFIED PHOTOFINISHING SERVICE

- Have your film processed by a Photo Finisher which displays the above sign.
- Different Photo Finishers may provide different services.
Consult them for details of their services.



The "CE" mark certifies that this product satisfies the requirements of the EU (European Union) regarding safety, public health, environment and consumer protection. ("CE" is the abbreviation of Conformité Européenne.)
This product conforms with Directive 89/336/EEC.



CONTENTS

FEATURES	2
PART NAMES	3

1. PRELIMINARY STEPS

ATTACHING THE STRAP	5
LOADING THE BATTERY	6
POWER ON/OFF	7
SETTING AND CORRECTING THE DATE (YEAR : MONTH : DAY/HOUR : MINUTE)	8
SELECTING THE DATE MODE	10

2. BASIC PROCEDURES

LOADING THE FILM CARTRIDGE	11
SELECTING THE PRINT FORMAT	14
TAKING PICTURES	17
USING THE AUTO-FOCUS LOCK	21
UNLOADING THE FILM CARTRIDGE	23
CARTRIDGE MID-ROLL CHANGE FUNCTION	25

3. ADVANCED TECHNIQUES

SELECTING THE EXPOSURE MODE	30
-----------------------------------	----

USING THE SELF-TIMER	35
USING THE REMOTE CONTROLLER	37
MULTI PROGRAM FLASH	40
CAMERA CARE AND CAUTIONS	42
ERRORS, POSSIBLE CAUSES, AND REMEDIES ..	43
SPECIFICATIONS	45

FEATURES

- Autofocus 23-70mm Zoom
- Mid-Roll Change
- Super EBC Fujinon Lens
- Multi-Programmed Retractable Flash
- Error-Free Drop-in Loading
- 3 Selectable Prints Formats
- Print Quality Enhancement Through Information Exchange System
- Date or Time Printing Capability
- Red Eye Reductoin

PART NAMES

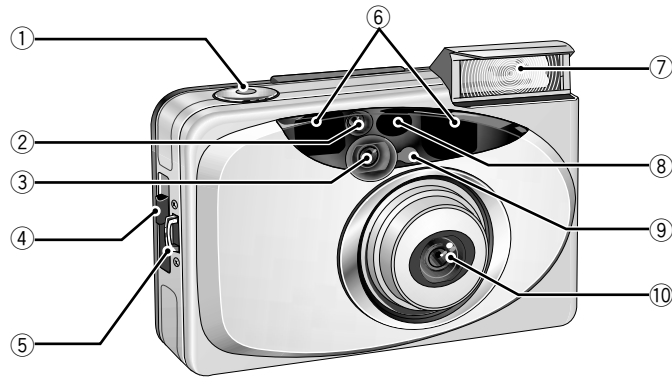

- ① Shutter Release Button
- ② AE Light Sensor
- ③ Viewfinder Window
- ④ Film Cartridge Compartment Cover Release Knob
- ⑤ Strap Lug
- ⑥ AF (Autofocus) Window
- ⑦ Flash
- ⑧ Remote Control Sensor
- ⑨ Self-Timer/Remote Controller Lamp
- ⑩ Super EBC Fujinon Lens

(See the illustrations while you read this manual.)

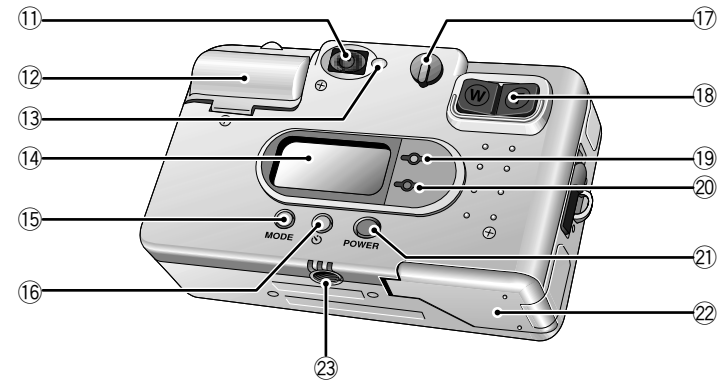

- ⑪ Viewfinder Eye-piece
- ⑫ Battery Compartment Cover
- ⑬ AF Lamp
- ⑭ Liquid Crystal Display
- ⑮ Exposure Mode Button
- ⑯ Self-timer/Remote Control/Date Set Button
- ⑰ Format Selector
- ⑱ Zoom Lever
- ⑲ DATE Button
- ⑳ Mid-Roll Change Button
- ㉑ Power Button
- ㉒ Film Cartridge Compartment Cover
- ㉓ Tripod Socket

Liquid crystal display

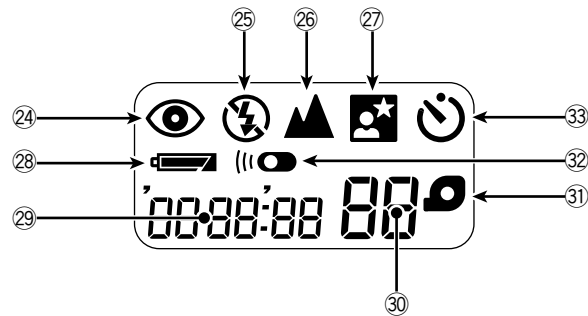

Liquid Crystal Display

The diagram shows all crystal displays in the “on” state.

- ②④ Red-eye Reduction Flash Mode
- ②⑤ Fill-in Flash Mode/Flash off Mode
- ②⑥ Landscape Mode
- ②⑦ Night Portrait Mode
- ②⑧ Battery Capacity
- ②⑨ Date Display (Type of Film Cartridge/Camera ISO Display)
- ③⑩ Exposure Counter/Self-timer Count
- ③① Film Cartridge Mark
- ③② Remote-Control Mode Sign
- ③③ Self-Timer Mode

1. PRELIMINARY STEPS

ATTACHING THE STRAP

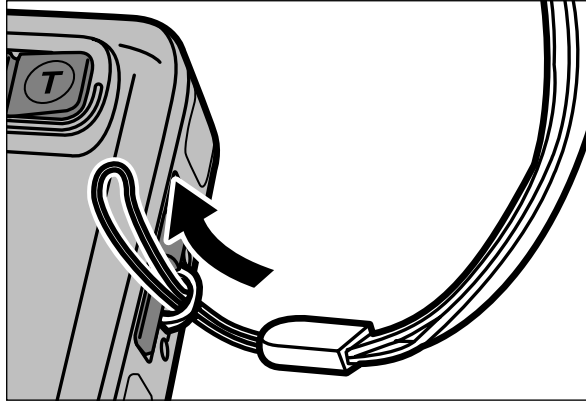

Fig. 1

Pass the smaller loop end of the strap through the camera's strap lug.

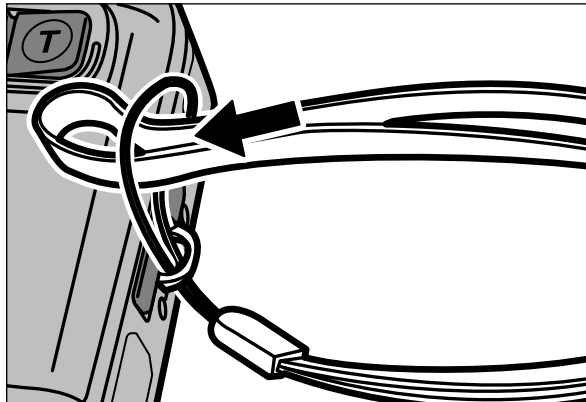

Fig. 2

Next, pass the longer loop end of the strap through the smaller loop, and pull the longer loop end.

LOADING THE BATTERY

Use the following lithium battery.

★ (One) 3V lithium battery. CR2/DL CR2 or equivalent.

* One lithium battery has enough power for taking approximately 300 shots (Based on our test conditions).

* If many rolls of Film are used, when travelling, for example, it is desirable to take spare batteries (particular in areas where it may be difficult to obtain batteries).

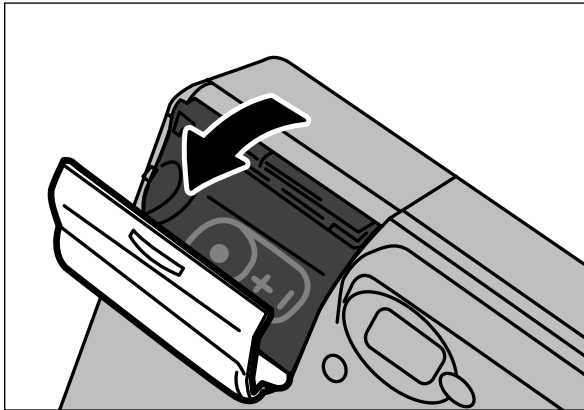

Fig. 3

Open the battery cover in the arrow direction as shown in the figure.

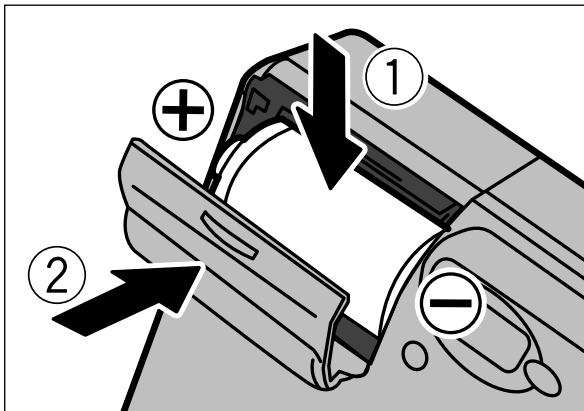

Fig. 4

Insert the batteries straight as shown in the indications so that they are not at a slant, then close the battery cover.

* After changing the battery, be sure to set the date again. (The method for setting the date is shown on Fig.8)

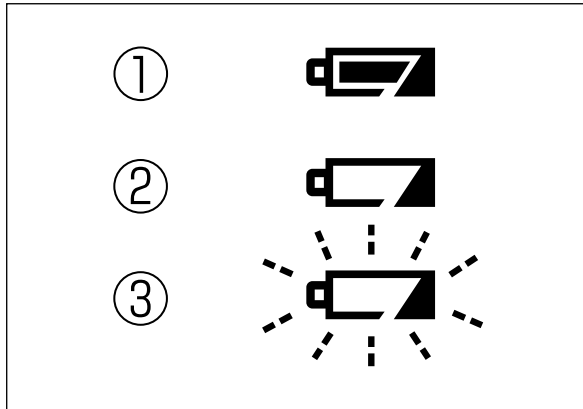

Fig. 5

Check the battery capacity sign on the Liquid Crystal Display.

- ① on: Battery capacity is OK.
- ② on: Battery capacity is insufficient; provide a new battery.
- ③ blink: Shutter release will not trip because the battery has no charge; change the battery.

* Check the battery capacity sign before using the camera.

* The battery can be replaced even when there is a film cartridge in the camera.

POWER ON/OFF

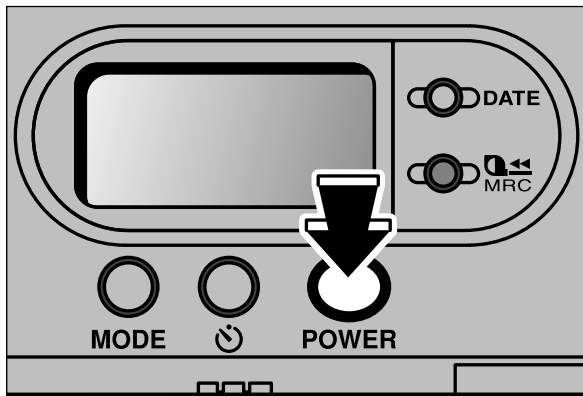

Fig. 6

Press the power supply button to turn on the power, Pressing the button once again turns the power supply off.

* When the power supply is left on for more than 5 minutes without use, the power turns off automatically.

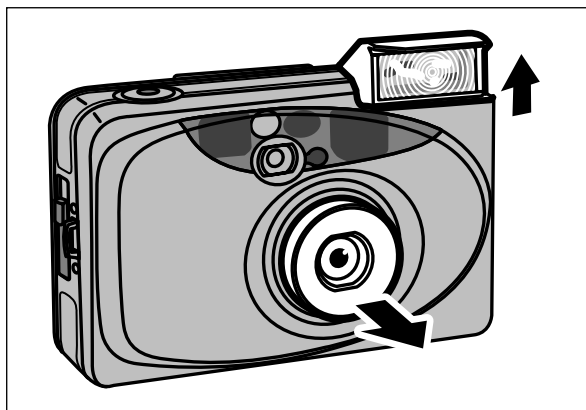

Fig. 7

When the power is turned on, the lens cover opens, the lens unit extends toward the front and the flash unit pops up, setting the camera in a condition where it is ready to take pictures.

* Do not restrict the motion of the lens cover with your fingers when you turn the power on. Doing so could cause the camera to malfunction.

SETTING AND CORRECTING THE DATE (YEAR:MONTH:DAY/HOUR:MINUTE)

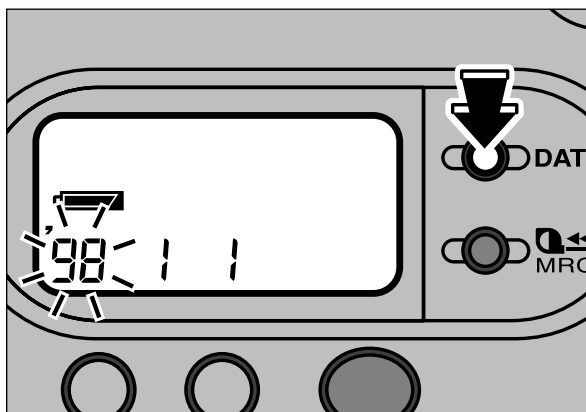

Fig. 8

Turn on the power, then press the DATE button continuously for 2 seconds or longer. This will cause the Year display to blink and the camera will enter the date setting mode.

Adjustable items are as follows.

Year	:	'98 – '29	(1998 – 2029)
Month	:	1 – 12	Day : 1 – 31
Hour	:	0 – 23	Minute : 00 – 59

SELECTING THE DATE MODE

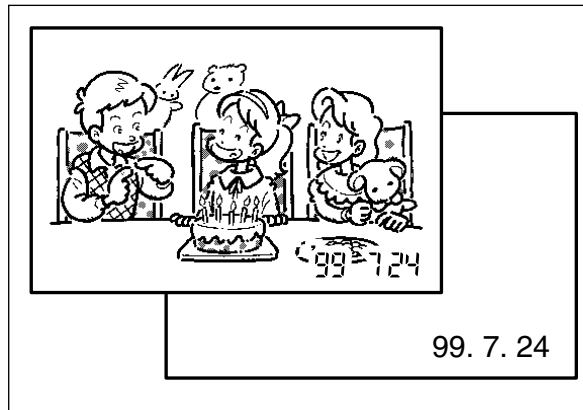

Fig. 11

With the Advanced Photo System

The date (year/month/day, hour/minute) can be printed on the front and back of the print. Frontprinting, which can be seen when inserted in an album, and backprinting, which is convenient for cataloging. Either can be used depending on the purpose.

- * Some photo finishers may not support the feature for printing on the surface.
- * Changes, such as eliminating the date, are possible when re-printing. (Some photo finisher's may not support this feature.)

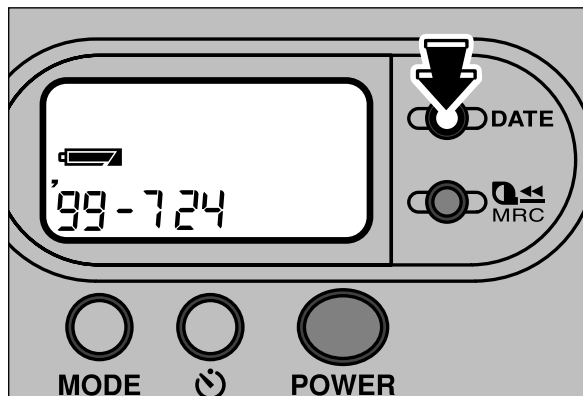

Fig. 12

Switch on the power and press the DATE Button to enable selection of the date mode. The mode display will be recorded during exposure and printed during processing.

- * With some backgrounds, the date display on the front may be difficult to see.
- * The front print surface will not be printed when "-- -- --" is displayed. The date (Year, Month, Day) will be printed on the rear surface.

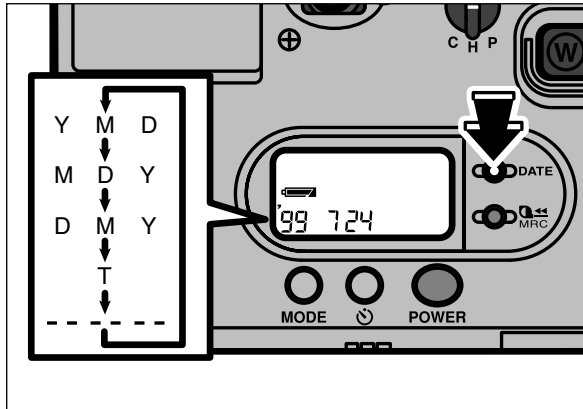

Fig. 13

The date mode will alternate as shown in the diagram whenever the DATE Button is pressed.

- * The date mode will be displayed in the [Year, Month, Day] sequence when the date is realigned even when a date mode other than [Year, Month, Day] has been selected. Select the date mode every time the date has been realigned if a setting other than [Year, Month, Day] is required.
(Y : Year M : Month D : Day T : Time)

2. BASIC PROCEDURES

LOADING THE FILM CARTRIDGE

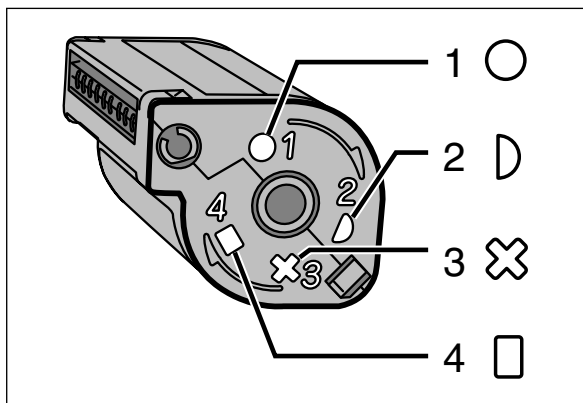

Fig. 14

With the Advanced Photo System

IX240 cartridge film is used.

- * Confirm that the ○ sign or D sign on the film cartridge is white. Cartridges in which the X and □ signs are white cannot be used. (Optical Double Exposure Prevention.)
(1 unexposed 2 partial 3 exposed 4 processed)

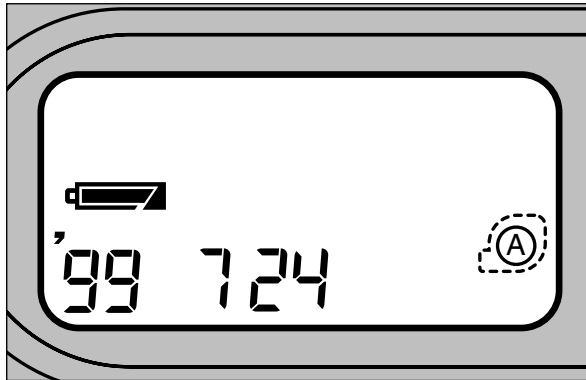



Fig. 15

Make sure that the film cartridge mark  is not displayed in area ① of the Liquid Crystal Display.

* If  and “E” are lit on the Liquid Crystal Display, your camera contains a film cartridge already exposed. Remove the film cartridge, following the instructions on page 23.

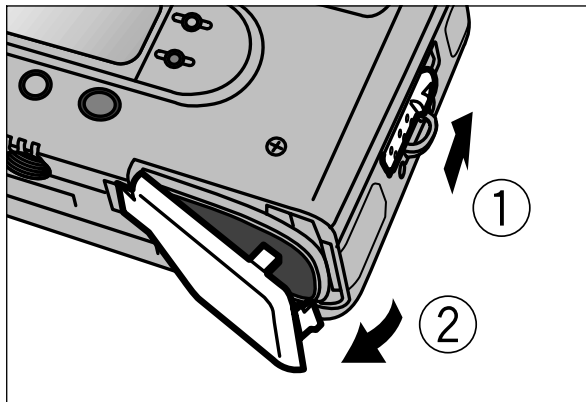

Fig. 16

Move the cartridge cover released knob in the direction of ① and open the cartridge cover slightly. Open the cartridge cover in the direction of ②.

* Do not apply unnecessary force to the film cartridge compartment cover.

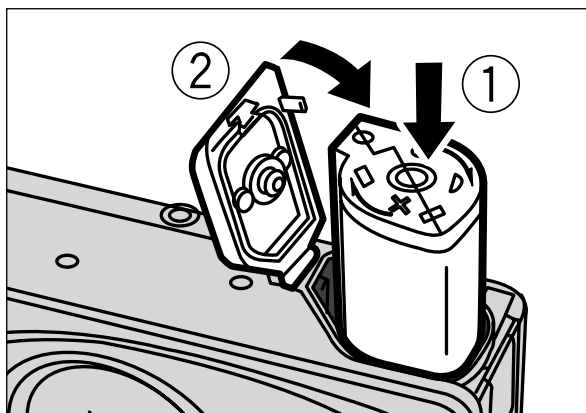

Fig. 17

Drop the cartridge ① into place and then close the cartridge cover ②.

* Insert the battery before inserting the film cartridge.

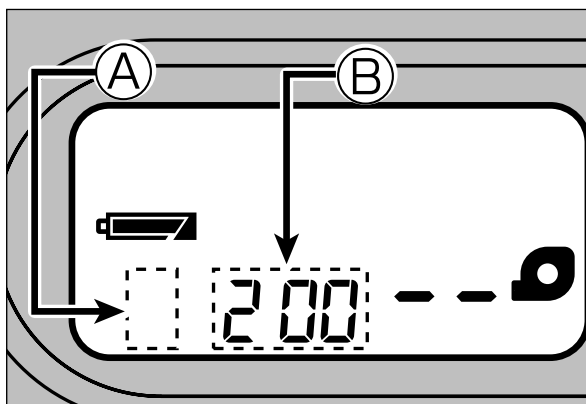

Fig. 18

When the film cartridge compartment cover is closed, the film advances automatically to the first frame.

* The camera ISO ② and the type of film cartridge ① will appear in the Liquid Crystal Display until the first frame is set.

Type of film cartridge

Color Negative	Positive	Black and White	Other
No display	P	b	o

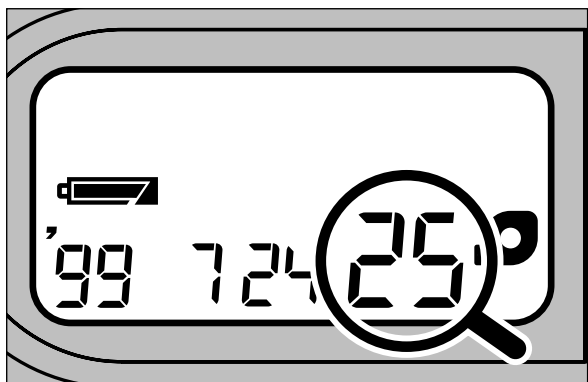

Fig. 19

When the first frame of the film is set, the usable number of frames (specified number of exposures in the film) is displayed in the exposure counter.

* The number indicated in the exposure counter decreases by one each time a picture is taken.

SELECTING THE PRINT FORMAT

With the Advanced Photo System

Three print formats - C, H and P can be chosen. Press in the Print Format Button to select the format you want.

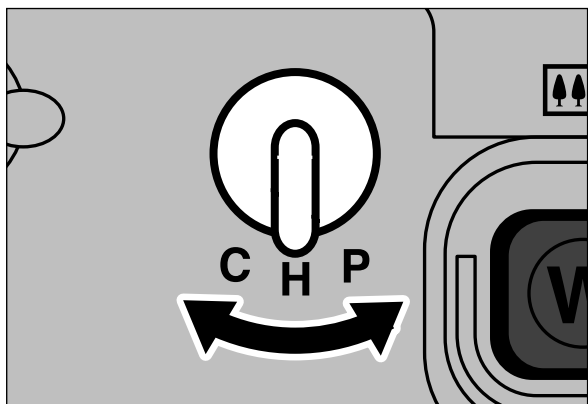

Fig. 20

Select the print format with the print format switch located on the rear of the camera.

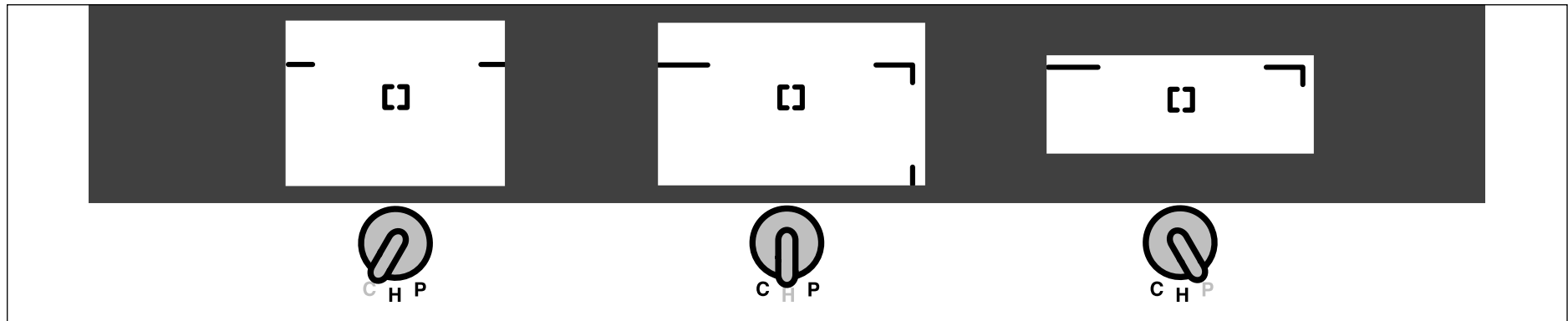

Fig. 21

The view through the finder will change to the style of photographs shown when the print format switch is operated. The angle of the exposure will not change.

- Ⓐ : C Print (2 : 3)
- Ⓑ : H Print (9 : 16)
- Ⓒ : P Print (1 : 3)

* Figures in () represent the aspect ratio.

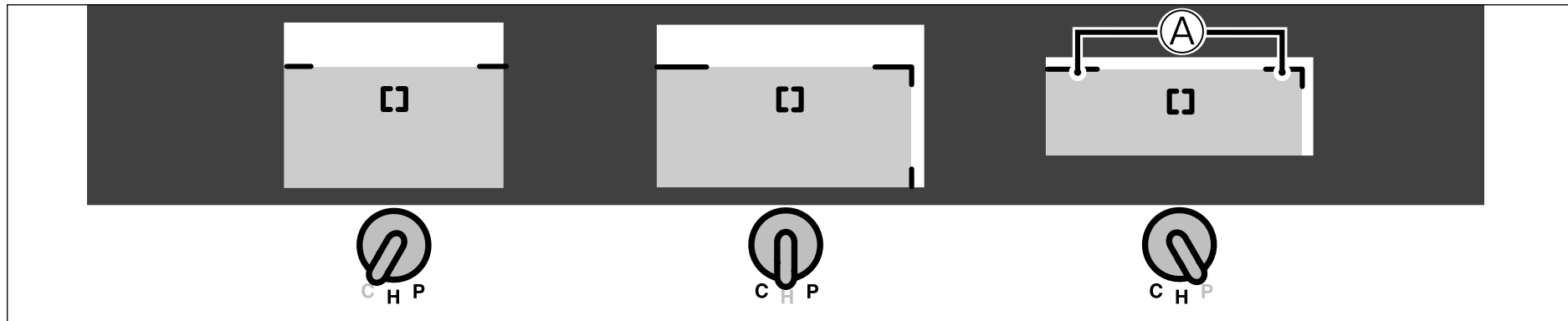



Fig. 22

● **Near-distance exposure**

The area visible in the  part shown will be printed when an exposure closer than approximately 1.5m is taken.

As the area visible through the finder and the area actually exposed will differ with near-distance exposures (owing to the positions of the finder and the exposure lens being different), correcting the visible range through the finder with the near-distance correction mark provides a useful yardstick for the area actually exposed.

( : Parallax correction mark)

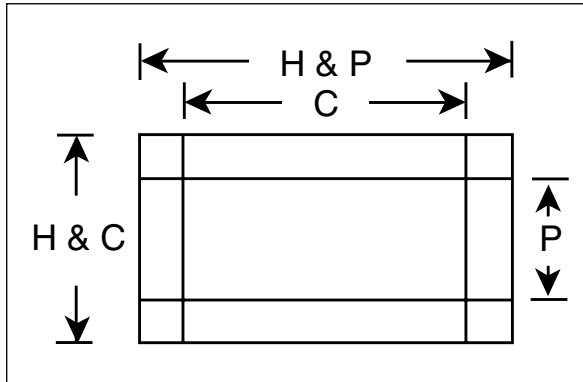

Fig. 23

Even when anyone of the C/H/P print format has been selected, the size of the photograph on the film remains the same (approx. 17 x 30mm). Print format selection will record the print format for each frame and the exposure will be printed within the ranges shown in the above illustrations.

* The print format can be changed when reprinting.

C	H	P
16 x 23 mm	16 x 28 mm	10 x 28 mm

TAKING PICTURES

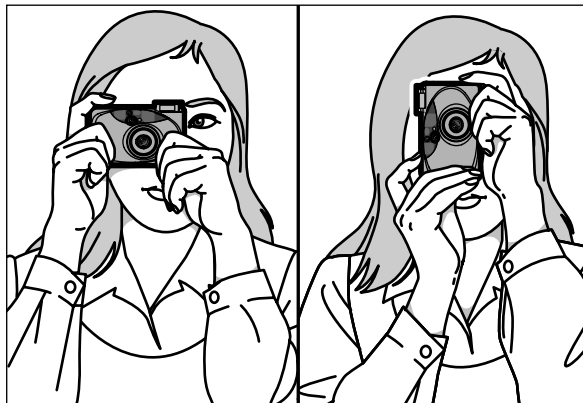

Fig. 24

Hold the camera firmly with both hands. When holding vertically, keep the flash lamp upward.

Take a test exposure prior to taking important photographs (weddings, overseas travel, business-related, etc.,) to ensure that the camera is functioning correctly.

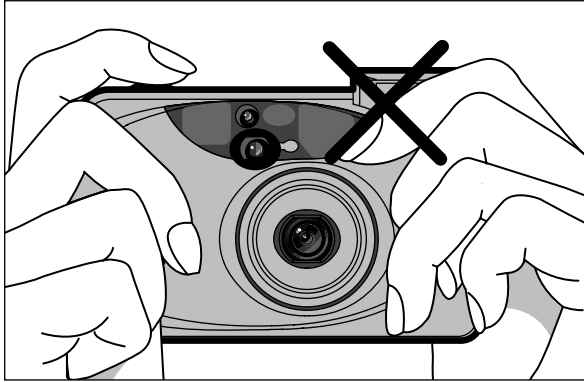

Fig. 25

Ensure that fingers or the camera strap are not obscuring the lens or flash assembly.

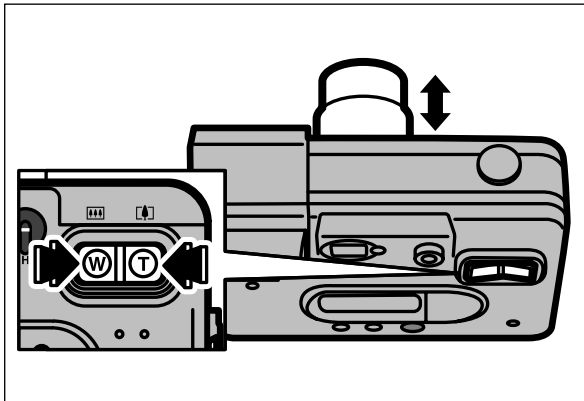

Fig. 26

Press the zoom lever T mark until the required level of zoom has been acquired when the subject is to be magnified. Press the W mark to obtain the wide-angle zoom.

* The minimum distance for exposure is 0.6 m.

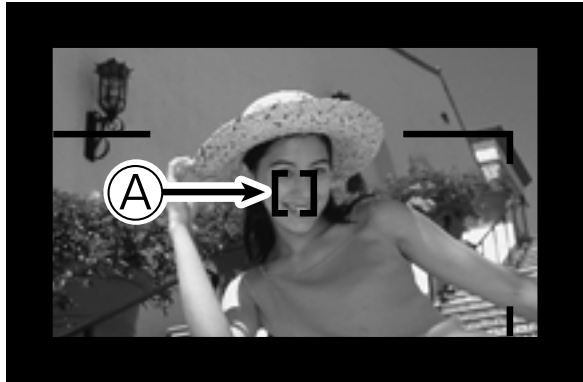

Fig. 27

Aim at the subject so that it fills the whole AF frame.

(A) : AF (Autofocus) frame)

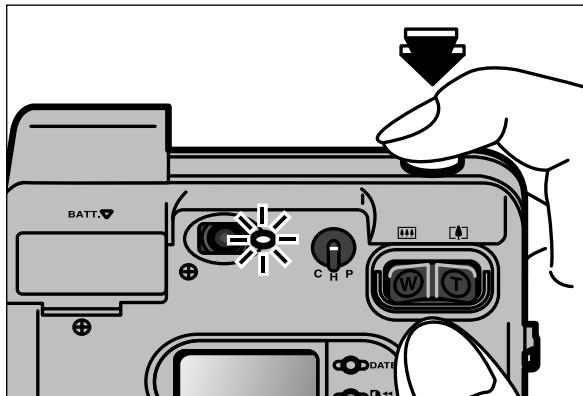

Fig. 28

When the shutter release button is pressed halfway and the AF lamp (green) turns on, focusing is complete.

- * While the shutter release button is pressed halfway, the film speed and Type of film is indicated in the Liquid Crystal Display.
- * When you are too close to the subject, the AF lamp (green) will start blinking.
- * Note that when you are closer than about 30 cm, the AF lamp turns on but focusing will not be sharp.

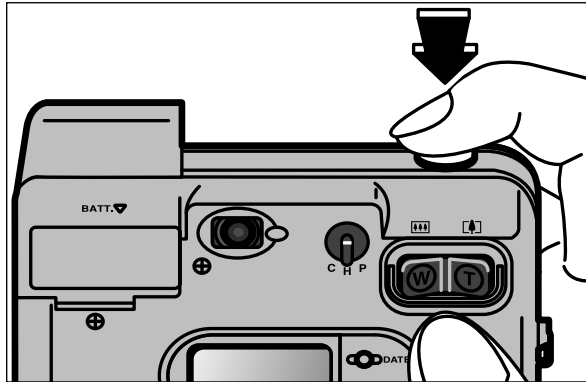

Fig. 29

When the shutter trips, the flash fires and the film advances to the next frame.

- * For bright remote scenes, the flash does not fire.
- * The AF lamp will go off once and reappear immediately after the shutter is released.
- * During the charging time of the flash (when the alarm sign is blinking ⚡) the shutter cannot be released.

- In dark places, photos should be taken within the following flash lamp ranges.

Effective flash lamp range

Film speed	Wide angle (23mm)	Telephoto (70mm)
ISO 100	0.6 ~ 3.2	0.6 ~ 1.9
ISO 200	0.6 ~ 4.5	0.6 ~ 2.7
ISO 400	0.6 ~ 6.3	0.6 ~ 3.8

(Using color negative film; units; m)

- In the following cases, the camera may not be able to focus on the subject. Such subjects must be shot using the “AF-lock” or “Landscape Mode”. (refer to pages 21 and 33)
- ① A bright light source such as the sun is near the subject or there is reflected light (from the windscreen of a vehicle, waves, etc.) near the subject.
- ② When shooting black light-absorbing subjects such as hair.
- ③ A mirror or light-reflecting surfaces such as metals are near the center of the picture.
- ④ There are gaseous substances such as flame or smoke.
- ⑤ Taking pictures through glass.

USING THE AUTO-FOCUS LOCK



Fig. 30

In the composition shown above, the AF frame is off the subject (in this case, the people). In this state the lens will not focus on the subject.

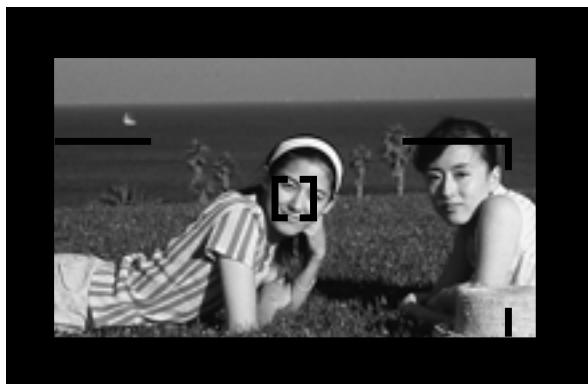

Fig. 31

Move the camera slightly so that the subject is inside the AF frame.

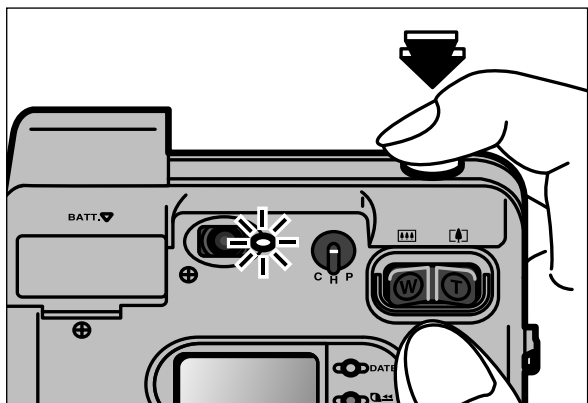

Fig. 32

Press the shutter release button halfway down and confirm that the AF lamp lights without moving the camera. (Focus is locked on your subject in this condition.)



Fig. 33

While holding the shutter release button halfway down to keep the Auto-Focus lock on, move the camera back to the original position to recompose your picture, then press the shutter release button all the way down.

* The Auto-Focus lock operation can be repeated any number of times before the shutter trips.

UNLOADING THE FILM CARTRIDGE

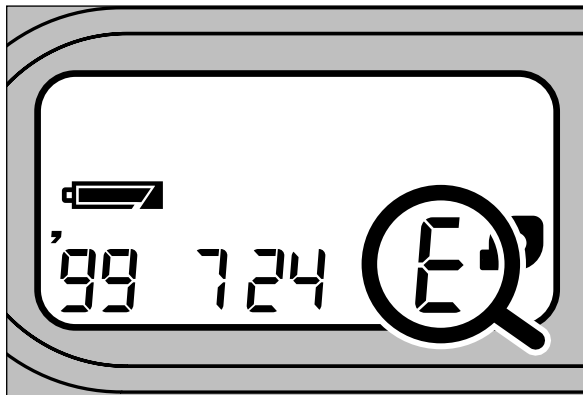

Fig. 34

When the last frame has been exposed, the film is rewound. The exposure counter shows the number of frames remaining after subtracting the exposed frames from the specified number of frames.

* When rewinding of the film is finished, an “ E ” sign will appear in the exposure counter.

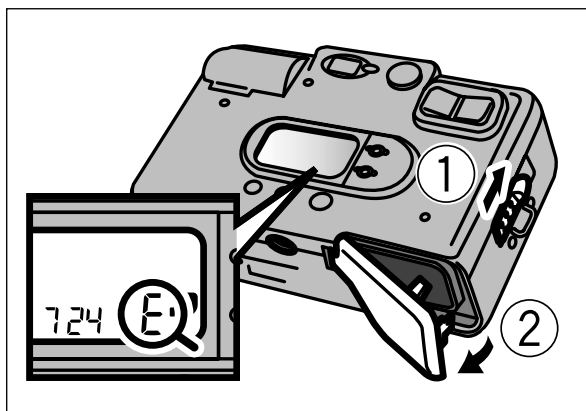

Fig. 35

When the exposure counter shows “ Ξ ” and the motor stops, move the film cartridge compartment cover release knob as indicated in ①, in the direction indicated in ②, and open the film cartridge compartment cover.

* Always make sure that the motor is stopped and “ Ξ ” is displayed before moving the film cartridge opening knob. Otherwise, camera trouble or accidental exposure of the film may occur.

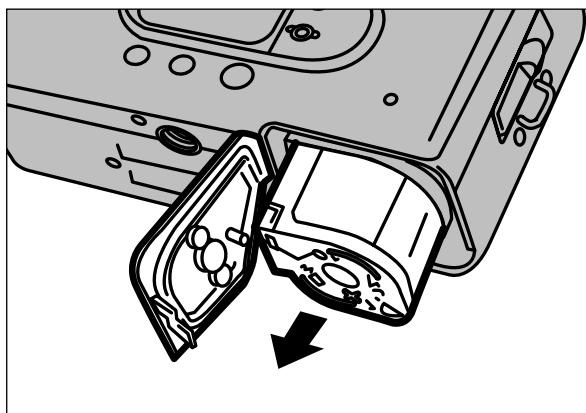

Fig. 36

Take out the film cartridge after opening the cartridge compartment cover.

* “ ✕ ” is displayed on the cartridge.
 * Do not apply unnecessary force to the cartridge compartment cover.

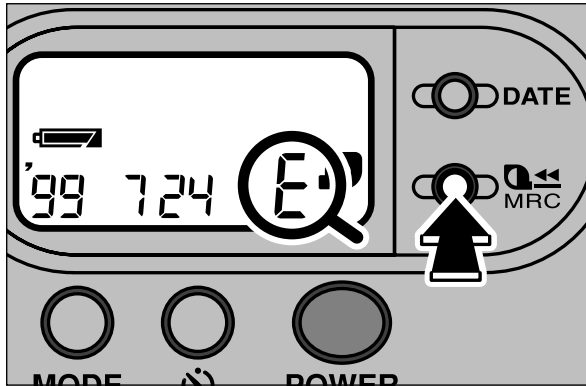

Fig. 37

Press the Mid-Roll Change Button to rewind the film when the cartridge is to be ejected in the middle of the roll. Do not remove the cartridge until “ E ” is displayed in the exposure counter and the rewind motor has ceased to operate.

* When rewinding a roll of film which is only partially exposed. Refer to CARTRIDGE MID-ROLL CHANGE FUNCTION.

CARTRIDGE MID-ROLL CHANGE FUNCTION



Fig. 38

With the Advanced Photo System

The cartridge can be replaced even in mid-roll. This convenient feature makes it possible for family members to alternate using one camera, to keep hobby pictures separate from photographs for work, and to interchange cartridges with different film speeds.

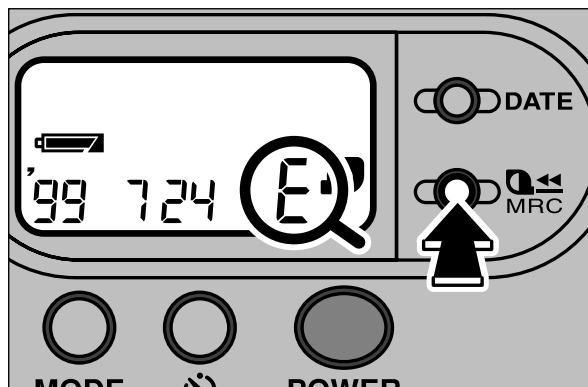

Fig. 39

Press in the Mid-Roll Change Button. The film counter will display as it subtracts from the number of frames. When rewinding is completed, “ E ” will be displayed by the film counter.

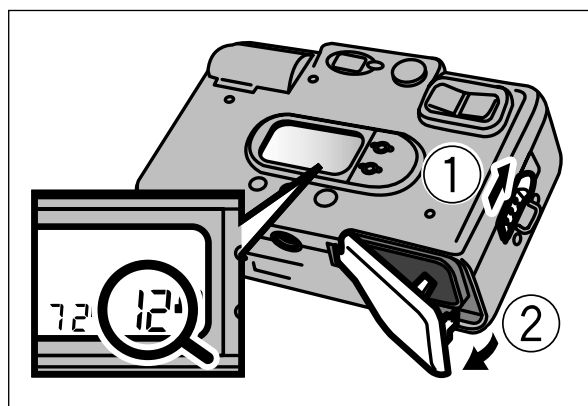

Fig. 40

When “ E ” appears in the film counter and the motor has stopped, raise the cartridge compartment cover release knob as shown in illustration ①, move it in the direction shown in illustration ② and open the cartridge compartment cover. The number of unexposed frames will be displayed by the film counter at this time.

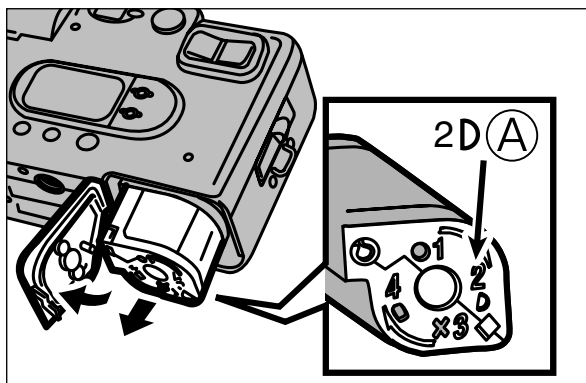

Fig. 41

Remove the cartridge and sign sure the sign D appears white.

(A): Film cartridge with unexposed frames)

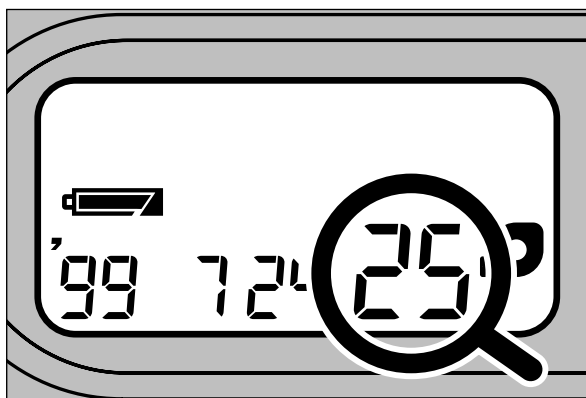

Fig. 42

Load a new film cartridge (with a white O cartridge status mark). The film will be advanced to the first frame, and number of exposures specified on the film cartridge will appear in the LCD.

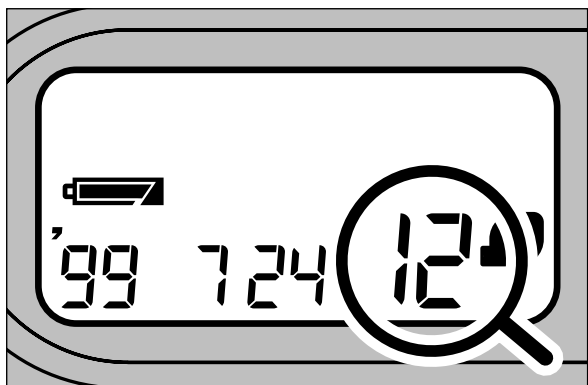



Fig. 43

When a cartridge that was removed in mid-roll (D) is re-loaded, the film will automatically be advanced to the first unexposed frame. After that, operation is as before.

- * Even if you forget how many frames were exposed on a cartridge that was removed in mid-roll, just re-load the cartridge. The camera will automatically set the remaining number of unexposed frames and display that number on the Liquid Crystal Display.

◆ Cautions Concerning the Mid-roll Change Function

- * When a cartridge that has been removed in mid-roll (D is displayed) is re-loaded into the camera, if “E” blinks in the film counter, re-load the cartridge once more, avoiding the following locations.
 - Anywhere near a drier, fan, vacuum cleaner, etc., which has a rotating motor.
 - Near an active TV or personal computer display.
- * If a cartridge is removed in mid-roll (D) and then loaded into a camera which does not have the mid-roll change function, the cartridge will be set to exposed (X) and can no longer be used.

- * A cartridge removed in mid-roll  from a camera which does not have the Mid-Roll Change function cannot be used even if loaded into this camera.
- * If a cartridge is removed in mid-roll  and sent to the processor, all frames on the entire roll will be developed. Expose all frames on the roll before sending the cartridge to the processor for development.
- * The mid-way replacement of cartridges is only guaranteed with [ENDEAVOR/FOTONEX] cameras equipped with the MRC function manufactured by Fuji Film. There are cases where normal operations are not possible when cartridges containing frames exposed by MRC cameras manufactured by other companies are used.

3. ADVANCED TECHNIQUES

SELECTING THE EXPOSURE MODE

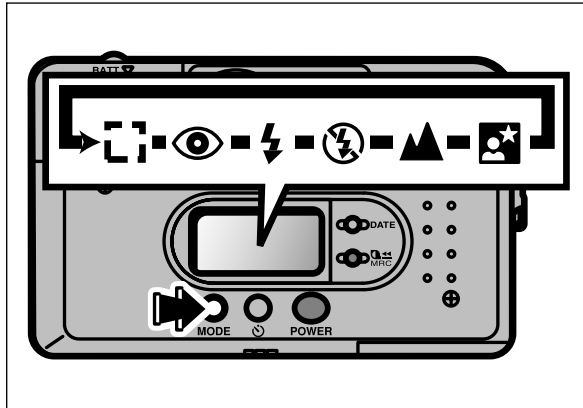

Fig. 44

Your camera has six exposure modes so that you can enjoy photography in response to various subjects. These modes are:

- (□) Multi program flash mode
- (👁) Red-eye reduction flash mode
- (⚡) Back light compensation flash mode
- (⚡/) Flash off mode
- (🏔) Landscape mode
- (🌃) Night portrait (slow sync) mode

Each time you press in the Mode button, mode signs will appear in the LCD in the order of (□), (👁), (⚡), (⚡/), (🏔), (🌃). The finally displayed mode will be selected.



Fig. 45

□ No display : **Multi program flash mode**

Used during normal exposures

The amount of flash released will be automatically adjusted in accordance with the brightness, distance and magnification of the subject.

- * The flash lamp does not fire for bright long-distance scenes.
- * Refer to page 40 for further details on the Multi Program flash.



Fig. 46

: Red-eye reduction flash mode

Reduces red-eye

The flash lamp will fire briefly five times (pre-flash), then fire the sixth time for taking your picture.

* The AF lamp sign in the viewfinder eyepiece stays on from pre-flash to exposure. Do not move the camera while the AF lamp is on.

● **About red-eye**

When a person is photographed with flash in dim light, the eyes will sometimes turn out red. This is because the light from the flash lamp is reflected back into the lens from the back (retina) of the person's eyes.

In addition to using the red-eye reduction mode, observance of the following is effective in reducing red-eye.

- ① Have the person being photographed look directly at the camera lens.
- ② Take pictures by approaching as close as possible to the subject.



Fig. 47

⚡ : Fill-in flash mode

Used when photographing from windows, in the shade of trees and for other backlit exposures.

Takes flash exposures even in bright locations.



Fig. 48

⊘ : Flash Off mode

Use when taking pictures using interior light or for taking distant subjects which the flash lamp light cannot reach, such as in a theater or stadium.

The flash lamp will not flash.

* When taking a picture in dim light in the Fill-in flash mode, a tripod should be used to avoid camera shake.



Fig. 49

▲ : Landscape mode

This is used for taking clear landscape pictures or photographing remote (night) scenes through glass.

Set the focus in the distance. The flash will not operate.

- * This feature will be canceled after every exposure.
- * When taking pictures in dim light in the landscape mode, a tripod should be used to avoid camera shake.



Fig. 50

👤★ : Night portrait (slow sync) mode

This is used for taking photographs of people at night

The camera will enter the slow-shutter red-eye reduction mode (flash emitted after five pre-flashes) to enable the clear exposure of both night scenes and human subjects.

- * This feature will be canceled after every exposure.
- * As a slow shutter speed is used with the night portrait mode, ensure that a tripod is used to prevent camera-shake. It is also important that the subject remains motionless during the exposure.
- * The daylight flash mode, the Fill-in flash mode, and landscape mode and the night portrait (slow shutter) mode will be canceled when the power is switched off.
- To enable the continual use of the landscape mode and night scene portrait mode, press the Exposure mode button for two or more consecutive seconds when selecting the mode until the mark changes from being illuminated to blinking. The mode will then remain in place after exposure to enable continual use. This feature will be canceled automatically when the power is switched off.

USING THE SELF-TIMER

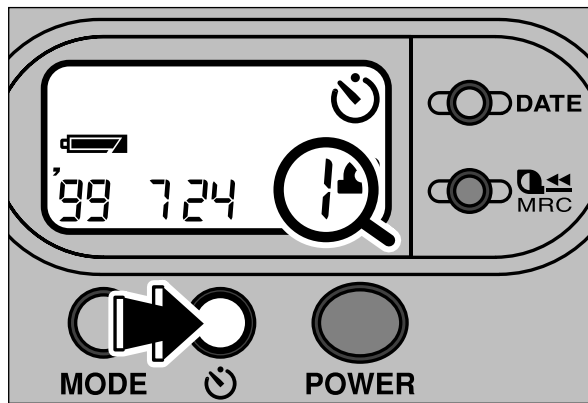





Fig. 51

Press the  button to show on the Liquid Crystal Display the self-timer symbol  and the number of shots you selected. Press it as many times as you want to shoot with the self-timer (up to three shots).

*  is the remote control mode. Refer to Fig.54 to Fig.59 further details.

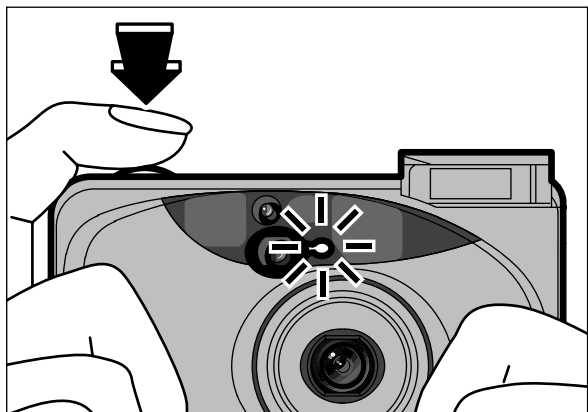

Fig. 52

When the shutter release is depressed, the camera focuses on the subject in the AF frame and the self-timer starts.

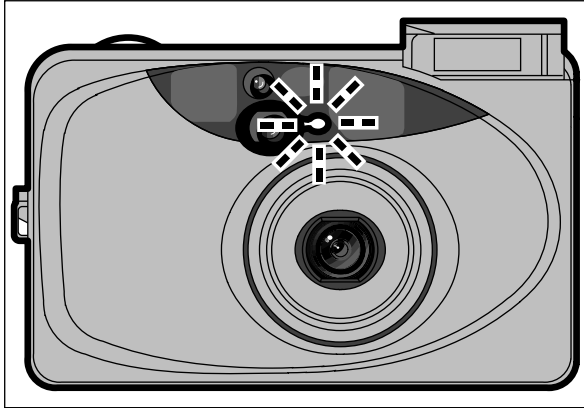



Fig. 53

The self-timer lamp will begin to blink approximately seven seconds after being illuminated, and the shutter will be released approximately three seconds after that.

Subsequent self-timer exposures will be taken at intervals of between three to six seconds when two or three consecutive self-timer exposures have been set.

- * Do not press the shutter release button while standing in front of the camera. This may cause a focusing error or underexposure.
- * If you want to cancel the self-timer mode, press the  button again to extinguish the sign  in Liquid Crystal Display.
- * The self-timer mode will be automatically canceled after the exposure has been taken and when the power is switched off.

USING THE REMOTE CONTROLLER

The remote controller is an optional accessory

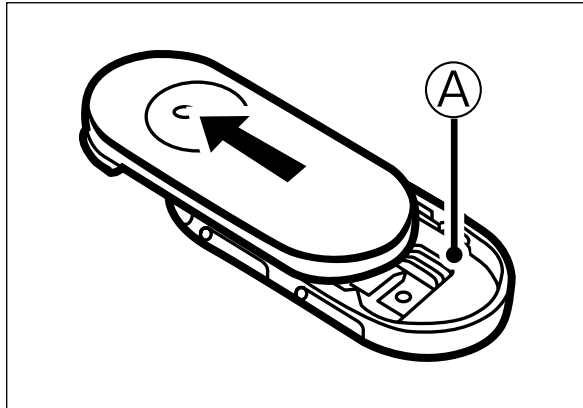

Fig. 54

Remove the remote controller from its holder by sliding it in the direction of the arrow.

- * To replace the remote controller in the holder, slide the remote controller in the direction opposite to the arrow until it clicks into position.
- * The type of the exclusive remote control, sold separately, may differ somewhat from the type shown in the illustration.

(A) : Remote controller holder

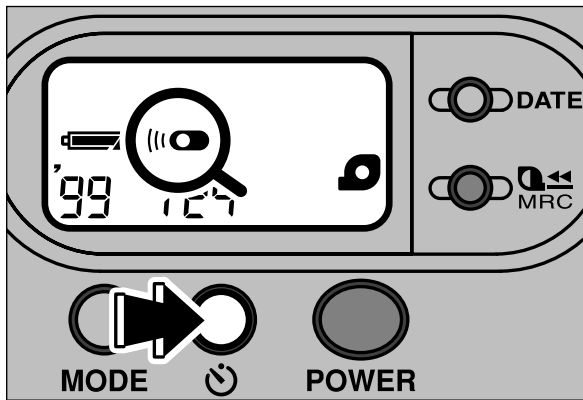



Fig. 55

Press the  button four times to show the  symbol on the Liquid Crystal Display.

- * The remote control mode is displayed after the self-timer mode.



Fig. 56

Aim the AF Frame at your subject and compose your picture.

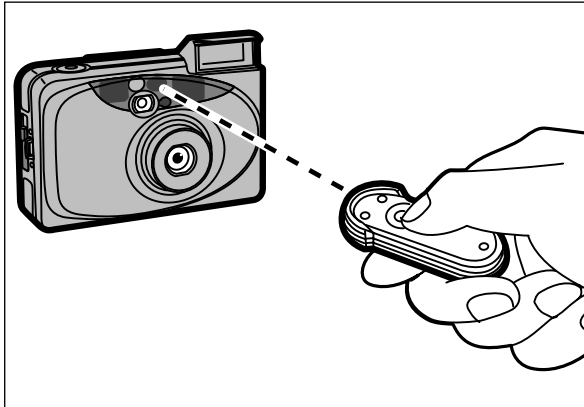

Fig. 57

Direct the transmit end of the remote controller toward the camera and press the Shutter Release Button. The self-timer (remote controller) lamp blinks and the shutter trips in about two seconds.

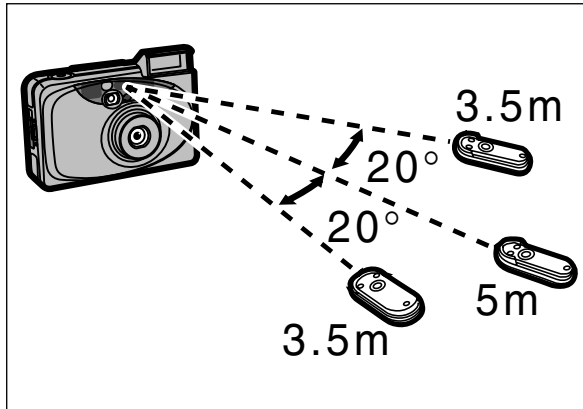

Fig. 58

The coverage of the remote controller is up to about 5 m when used directly in front of the camera, and up to about 3.5 m when used at a vertical or horizontal angle of 20°.

- * The remote controller mode is not cancelled after shooting. It is automatically cancelled when the power is turned off.
- * It is recommended to use a tripod when taking pictures by remote control.
- * The remote controller may not work properly when direct sunlight enters the camera's light sensor from behind your subject. Use the self-timer in such a case.

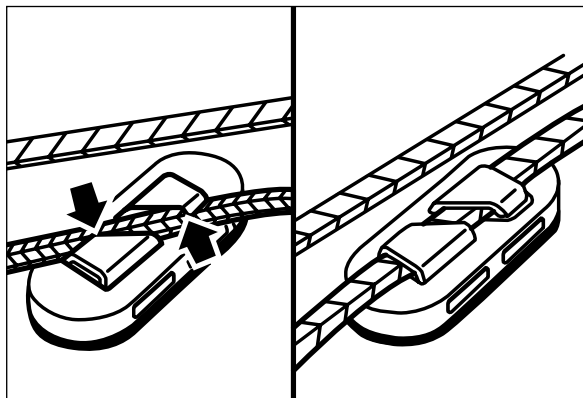

Fig. 59

Fit the remote controller holder to the camera strap for your easy handling.

- * The battery life is about three years (tested according to standard test conditions). If the remote controller no longer operates, contact your local retailer where you purchased your camera or our service center. A replacement battery will be available at cost.

MULTI PROGRAM FLASH

A word on multi program flash

A new function which allows the camera judging the photographing conditions and automatically adjusting the quantity of light emitted by the flash according to three different data (the brightness of the subject, the distance, and the focal length of the lens). The flash always fires automatically unless otherwise the subject is bright or too far. This programmed flash allows anyone to take clean pictures simply.

Some practical examples are introduced to explain the effects.



Fig. 60

- **Cautions Concerning the Mid-roll Change Function**

When close-up pictures are taken in a dim place with an ordinary flash, it fires in 100% light quantity. As the result, the subject is blurred in white. The multi program flash reduces the light quantity down to 12.5% of the ordinary quantity (maximum), preventing pictures blurred in white.



Fig. 61

- **Portrait photography at high brightness**

When a person is photographed in bright daylight, his (her) face is likely to be spotted with the shades of hair and nose. Even in such a case, the multi program flash automatically fires to reduce the shades. It seems unnecessary to use the flash in bright place. However, you will understand the effect by comparing a picture taken with the flash used and a picture taken without using the flash.



Fig. 62

- **Photography against the sun**







When a person standing by a window or subject with backlight is photographed, the subject becomes a shade and an under-exposure may result. In this case also, the multi program flash automatically provides the optimum light quantity so that you can take beautiful pictures.

CAMERA CARE AND CAUTIONS



- 1 Your camera is a precision instrument which requires careful handling. Do not expose it to shock, liquid, or drop it on the floor.
 - ① If you use the camera at the seaside or in light rain, be careful not to get it wet. Also be careful not to put the camera in places where it will be easily exposed to sand.
 - ② Dropping the camera on the floor or striking it against hard objects sometimes causes trouble even though it may be in the camera case. Also do not put the camera in places where it is exposed to vibrations (such as the trunk of a car).
- 2 If you are not using your camera for a long time, keep it where it will be safe from heat, moisture, dust, and harmful gases (such as naphthalene which is used in drawers).
- 3 This advanced photo system magnetically records the information on the film. Therefore, do not expose film cartridges or a film cartridge loaded camera to strong magnetic fields.
- 4 Do not put the camera in a closed car for a long time.
- 5 It is recommended that undeveloped film and cameras containing film are carried as hand luggage when using aircraft. If included in checked-in baggage, X-ray inspections may cause overprinting or other effects.
- 6 Remove soil and dust from the lens, the AF window and the finder with an air blower and by wiping lightly with a piece of soft cloth. If that is not enough, wipe off gently with Lens Cleaning Paper, moistened slightly with Lens Cleaning Liquid. Do not use organic solvents such as alcohol and benzene.
- 7 The operating temperature range of the camera is from -10°C to $+40^{\circ}\text{C}$.

ERRORS, POSSIBLE CAUSES, AND REMEDIES

During operation

Error	Possible Causes	Remedies	Page
<p>Exposure counter shows “ E ”, “  ” though film cartridge has been loaded and film cartridge compartment cover has been closed.</p>	<ul style="list-style-type: none"> ● Open the film cartridge compartment cover and check the film cartridge status mark. Are you using a film cartridge with a white  mark or . 	<ul style="list-style-type: none"> ● Use a film cartridge with a white  mark or . 	11
<p>The shutter release won't trip.</p>	<ul style="list-style-type: none"> ① “  ” symbol blinks ② Power switch is not on. ③ “ E ” lights on the exposure counter. 	<ul style="list-style-type: none"> ① Replace the battery. ② Turn on power switch to have lens come out and set camera ready for shooting. ③ Remove the film cartridge and load an unused film cartridge or a film cartridge with unexposed frames remaining. 	7 7 12
<p>The film cartridge cover cannot be opened.</p>	<ul style="list-style-type: none"> ● Are you attempting to open the film cartridge cover in the middle of a roll? 	<ul style="list-style-type: none"> ● Rewind the film with the Mid-Roll Change Button. When “ E ” appears in the exposure counter, unload the film cartridge. 	23

Printed pictures

Error	Possible Causes	Remedies	Page
Picture is not sharp.	<ul style="list-style-type: none"> ① Did you aim the subject properly? ② Is the lens dirty? ③ Is the camera shaking? ④ You selected  mode when shooting at a close distance. 	<ul style="list-style-type: none"> ① Compose the picture in the AF Frame and shoot, or shoot using AF Lock. ② Clean the lens. ③ Hold the camera firmly and press the Shutter Release Button gently. Use a tripod for slow shutter speeds. ④ Select a mode other than  mode. 	<p>21</p> <p>42</p> <p>17</p> <p>30</p>
Picture is dark.	<ul style="list-style-type: none"> ① Subject was too far from the camera for flash photography in a dark place. ② Was your finger over the flash? 	<ul style="list-style-type: none"> ① Shoot within specified coverage distance of electronic flash. ② Do not cover the flash with your finger. 	<p>17</p> <p>20</p>
Printed date/time is incorrect.	<ul style="list-style-type: none"> ● You didn't set correct date and time after replacing battery. 	<ul style="list-style-type: none"> ● Set date and time after replacing battery. 	<p>8</p>
The date is not printed on the front.	<ul style="list-style-type: none"> ● Some Print Service shops do not support Front printing. 	<ul style="list-style-type: none"> ● Please consult you local dealer. 	



SPECIFICATIONS

- **Film**
IX240 Cartridge film
- **Picture Size**
16.7 mm x 30.2 mm
- **Print Format**
C/H/P switchable
- **Lens**
Super EBC Fujinon Zoom Lens, 7 components, 7 elements, f=23 mm ~ 70 mm 1:4.8 ~ 9.5
- **Viewfinder**
Super EBC zoom finder, 0.38 ~ 1.00 magnification, C, H and P formats switchable with AF Frame, parallax correction mark, AF Lamp
- **Focusing**
Active type auto focus: 0.6m ~ ∞, with AF lock, landscape mode (long distance lens position setting, flash off setting), AF Lamp (on: range OK, blinking: over range alarm)
- **Shutter Release**
Programmed electronic shutter release, 1 ~ 1/300sec. shutter release speeds
- **Exposure Control**
Automatic interlocking range (ISO 200), EV (wide angle): 9.9 (*7) ~ 17, EV (telephoto): 12.9 (*7) ~ 20
(* = values for the flash off mode)
- **Film Speed Setting**
Automatic (Data Disk System) for ISO 25 ~ 3200
- **Film Loading**
One touch drop-in loading system, with optical double exposure prevention.
- **Film Advance**
Automatic (motorized) wind and rewind system, provision for mid-roll rewinding Cartridge Mid-Roll Change function.

- **Flash**

Multi program flash lamp, 1 ~ 5.5 seconds recycle time, Multi program flash lamp, red-eye reduction flash mode, Daylight flash mode, Fill-in flash mode, night portrait (Slow Sync) mode

- **Self-Timer**

Electronically controlled, approximately 10 second delay, can be stopped mid-run, self-timer on lamp

- **Liquid Crystal Display**

Exposure counter, exposure mode index, cartridge loaded/unloaded sign, self-timer mode sign, battery capacity sign, frontprinting, flash charging sign, date sign, type of film cartridge sign, film speed sign

- **Data Recording**

Magnetic recording system, recordable on each frame, print format, BASIC PQI (print quality improvement) information

- **Power Supply**

One CR2/DL CR2 lithium battery or comparable battery

- **Others**

Tripod socket

- **Dimensions & Weight**

99.5 x 61.5 x 35 mm, 180 g (without battery)

* Specifications are subject to change without notice.



26-30, Nishiazabu 2-chome, Minato-ku, Tokyo 106-8620, Japan.

<FUJIFILM ABROAD>

In North America

FUJI PHOTO FILM U.S.A., INC.

555 Taxter Road, Elmsford, N.Y. 10523, U.S.A.

FUJI PHOTO FILM CANADA INC.

275 Britannia Road East, Mississauga, Ontario, L4Z 2E7, Canada

FUJI PHOTO FILM HAWAII, INC.

1650 Kalakaua Avenue, Honolulu, Hawaii 96826, U.S.A.

In Europe

FUJI PHOTO FILM (EUROPE) G.m.b.H.

Heesenstrasse 31, 40549 Dusseldorf, Germany

FUJI PHOTO FILM (U.K.) LTD.

Fuji Film House, 125 Finchley Road, Swiss Cottage, London NW3 6JH, England

FUJI FILM ESPAÑA, S.A.

Aragon, 180, 08011-Barcelona, Spain

In South America

FUJI PHOTO FILM DO BRAZIL LTDA.

Avenida Vereador Jose Diniz No. 3.400, Campo Belo- CEP 04.604

Cx. Postal 9.959., Sao Paulo-SP, Brazil

In Asia

FUJI PHOTO FILM CO., LTD., HONG KONG OFFICE

Room 916, Sun Plaza, 28 Canton Road, Tsim Sha Tsui, Kowloon, Hong Kong

FUJI PHOTO FILM (SINGAPORE) PTE. LTD.

10 New Industrial Road, Singapore 536201

FUJI PHOTO FILM (THAILAND) LTD.

S.P. Building, 8th Floor, 388 Phaholyothin Road, Bangkok 10400, Thailand

FUJI PHOTO FILM (MALAYSIA) SDN. BHD.

Letter Box 3, 3rd Floor Office Block 1, Crystal Plaza Lot 4, Jalan 51A/223, 46100 Petaling Jaya Selangor Darul Ehsan Malaysia

FUJI PHOTO FILM CO., LTD., TAIPEI OFFICE

Rm. 601, Hung Chong Bldg., No.38, Sec. 6, Min Chuan E. Road, Taipei 11412, Taiwan, Republic of China

FUJI PHOTO FILM CO., LTD., SEOUL OFFICE

Samduck Bldg. 6F., 144-1, Samsung-Dong, Kang Nam-ku, Seoul 135-090, Korea

FUJI PHOTO FILM CO., LTD., BEIJING REPRESENTATIVE OFFICE

Beijing Fortune Bldg. No. 817, 5, Dong Sanhuan Bei-lu, Chaoyang District, Beijing, China 100004

FUJI PHOTO FILM CO., LTD., HO CHI MINH OFFICE

29-31 Ton That Thiep St., Q.I Ho Chi Minh City, Vietnam

FUJI PHOTO FILM CO., LTD., NEW DELHI OFFICE

Le Meridian Commercial Tower 8F Janpath, New Delhi 110001, India

In Oceania

FUJI PHOTO FILM CO., LTD., SYDNEY REPRESENTATIVE OFFICE

c/o Hanimex Pty. Limited, Old Pittwater Road, Brookvale, N.S.W. 2100, Australia

In Middle East

FUJI PHOTO FILM CO., LTD., DUBAI OFFICE

No. 4G-17, L.O.B. No. 4, P.O. BOX 17212, Jebel Ali, Dubai, U.A.E.

Free Manuals Download Website

<http://myh66.com>

<http://usermanuals.us>

<http://www.somanuals.com>

<http://www.4manuals.cc>

<http://www.manual-lib.com>

<http://www.404manual.com>

<http://www.luxmanual.com>

<http://aubethermostatmanual.com>

Golf course search by state

<http://golfingnear.com>

Email search by domain

<http://emailbydomain.com>

Auto manuals search

<http://auto.somanuals.com>

TV manuals search

<http://tv.somanuals.com>