



USER'S MANUAL

PDS4201U-H/PDS4201E-H/PDS4201A-H

42" WIDE PLASMA DISPLAY MONITOR

Plasmavision™

Contents

	Page		Page
Before Use		RGB Mode	
• Safety Precautions	3-4	• Video Adjustments	22-23
• Preparation	5	• Macintosh Mode	24
• What You Should Know	6-7	• Screen Adjustments	25
• Preventing Equipment from Falling	8	• Other Adjustments	26-27
Usage		Handy Functions	
• Names of Parts and Their Functions	9-10	• On-Screen Display Setting	28
• Basic Operations	11	• Internal Speaker Setting	29
• Viewing Wide Screen	12	• DPMS Setting	30
• Setting the Desired Wide Screen Size	13	• Display Language Setting	31
• Wide Screen Viewing (RGB Mode)	14-15	Others	
Adjustments		• Adjustment Level Memory	32
Video Mode		• Care and Maintenance	33
• Video Adjustments	16-17	• Before Requesting Repair	33
• Screen Adjustments	18-19	• Specifications	34-35
• Other Adjustments	20-21	• Options	35

Before using the monitor, read this manual carefully so that you know how to use the monitor correctly.

Refer to this manual whenever questions or problems about operation arise. Be sure to read and observe the safety precautions.

Keep this manual where the user can see it easily.

* Installation and removal require special expertise. Consult your product dealer for details



DECLARATION OF CONFORMITY

according to EN45014

We

Fujitsu General (Euro) GmbH

of

Werftstraße 20, D-40549 Düsseldorf, F. R. Germany

Manufacturer: Shinjyo Fujitsu General Limited
702-3 Kanezawa Shinjyo-shi
Yamagata Japan

declares under our sole responsibility that the product,

Type: COLOUR PLASMA DISPLAY

Model Name: PDS4201E-H

to which this declaration relates are in conformity with the following standards;

European Standards:

- EMC: a. EN55022 1994, Class A
b. EN61000-3-2 1995
c. EN61000-3-3 1995
d. EN50082-2 1995
(EN61000-4-2 1995 / EN 61000-4-4 1995 / EN61000-4-8 1993)
(ENV50140 1993 / ENV50141 1993 / ENV50204 1995)
- Safety: e. EN60950 1992/A1:1993/A2:1993)

*By conformance with the standard referenced, the product follows
the provisions of the directives listed below.*

- a. EC Council Directive 89/336/EEC of 3rd, May 1989
b. EC Council Directive 92/31/EEC of 28th, April 1992
c. EC Council Directive 93/68/EEC of 22nd, July 1993
d. EC Council Directive 73/23/EEC of 19th, February 1973

Place of Issue: Germany
Date of Issue: 1996

Signature: _____

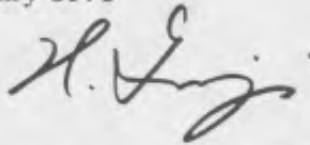
H. Fuji, Managing Director
Fujitsu General (Euro) GmbH

Declaration reference: Fujitsu General (Euro) GmbH
Werftstraße 20, D-40549 Düsseldorf, F. R. Germany
Tel: 0211-50098-0 Fax: 0211-50098-50

FCC NOTICE

The equipment has been tested and found to comply with the limits for a Class A digital device, pursuant to Part 15 of the FCC Rules. These limits are designed to provide reasonable protection against harmful interference when the equipment is operated in a commercial radiate radio frequency energy and if not installed and used in accordance with the instruction manual, may cause harmful interference to radio communications. Operation of the equipment in a residential area is likely to cause harmful interference in which case the user will be required to correct the interference at his own expense.

IMPORTANT INFORMATION

WARNING: This is Class A product. In a domestic environment this product may cause radio interference in which case the user may be required to take adequate measures.

WARNING: TO REDUCE THE RISK OF FIRE AND ELECTRIC SHOCK, DO NOT EXPOSE THIS PRODUCT TO RAIN OR MOISTURE.

IMPORTANT SAFEGUARDS

Electrical energy can perform many useful functions. This unit has been engineered and manufactured to assure your personal safety. But **IMPROPER USE CAN RESULT IN POTENTIAL ELECTRICAL SHOCK OR FIRE HAZARD**. In order not to defeat the safeguards incorporated into this product, observe the following basic rules for its installation, use and service. Please read these "Important Safeguards" carefully before use.

- All the safety and operating instructions should be read before the product is operated.
- The safety and operating instructions should be retained for future reference.
- All warnings on the product and in the operating instructions should be adhered to.
- All operating instructions should be followed.
- Unplug this product from the wall outlet before cleaning. Do not use liquid cleaners or aerosol cleaners. Use a damp cloth for cleaning.
- Do not use attachments not recommended by the product manufacturer as they may be hazardous.
- Do not use this product near water. Do not use immediately after moving from a low temperature to high temperature, as this causes condensation, which may result in fire, electric shock, or other hazards.
- Do not place this product on an unstable cart, stand, or table. The product may fall, causing serious injury to a child or adult, and serious damage to the product. The product should be mounted according to the manufacturer's instructions, and should use a mount recommended by the manufacturer.
- When the product is used on a cart, care should be taken to avoid quick stops, excessive force, and uneven surfaces which may cause the product and cart to overturn, damaging equipment or causing possible injury to the operator.



- Slots and openings in the cabinet are provided for ventilation. These ensure reliable operation of the product and protect it from overheating. These openings must not be blocked or covered. (The openings should never be blocked by placing the product on bed, sofa, rug, or similar surface. It should not be placed in a built-in installation such as a bookcase or rack unless proper ventilation is provided and the manufacturer's instructions have been adhered to.)

For proper ventilation, separate the product from other equipment, which may prevent ventilation and keep distance more than 10cm.

- This product should be operated only with the type of power source indicated on the label. If you are not sure of the type of power supply to your home, consult your product dealer or local power company.
- This product is equipped with a three-wire plug. This plug will fit only into a grounded power outlet. If you are unable to insert the plug into the outlet, contact your electrician to install the proper outlet. Do not defeat the safety purpose of the grounded plug.
- Power-supply cords should be routed so that they are not likely to be walked on or pinched by items placed upon or against them. Pay particular attention to cords at doors, plugs, receptacles, and the point where they exit from the product.
- For added protection of this product during a lightning storm, or when it is left unattended and unused for long periods of time, unplug it from the wall outlet and disconnect the cable system. This will prevent damage to the product due to lightning and power line surges.
- Do not overload wall outlets, extension cords, or convenience receptacles on other equipment as this can result in a risk of fire or electric shock.
- Never push objects of any kind into this product through openings as they may touch dangerous voltage points or short out parts that could result in a fire or electric shock. Never spill liquid of any kind on the product.
- Do not attempt to service this product yourself as opening or removing covers may expose you to dangerous voltages and other hazards. Refer all service to qualified service personnel.
- Unplug this product from the wall outlet and refer service to qualified service personnel under the following conditions:
 - a) When the power supply cord or plug is damaged.
 - b) If liquid has been spilled, or objects have fallen on the product.
 - c) If the product has been exposed to rain or water.
 - d) If the product operated normally by following the operating instructions. Adjust only those controls that are covered by the Operation Manual, as an improper adjustment of controls may result in damage and will often require extensive work by a qualified technician to restore the product to normal operation.
 - e) If the product has been dropped or damaged in any way.
 - f) When the product exhibits a distinct change in performance – this indicates a need for service.
- When replacement parts are required, be sure the service technician has used replacement parts specified by the manufacturer or with same characteristics as the original part. Unauthorized substitutions may result in fire, electric shock, or other hazards.
- Upon completion of any service or repairs to this product, ask the service technician to perform safety checks to determine that the product is in proper operating condition.
- The product should be placed more than one foot away from heat sources such as radiators, heat registers, stoves, and other products (including amplifiers) that produce heat.
- When connecting other products such as VCR's, and personal computers, you should turn off the power of this product for protection against electric shock.
- Do not place combustibles behind the cooling fan. For example, cloth, paper, matches, aerosol cans or gas lighters that present special hazards when over heated.
- Use only the accessory cord designed for this product to prevent shock.

The power supply voltage rating of this product is AC100-240 V, the power cord attached conforms to the following power supply voltage. Use only the power cord designated by our dealer to ensure Safety and EMC.

When it is used by other power supply voltage, power cable must be changed

Consult your product dealer.

Power cord



Power supply voltage: AC-100-125V



AC 200-240 V



AC 240 V(SAA TYPE)

PREPARATION

1 Checking Accessories



Cable clampers

- The accessory cable clampers are for fastening the connected signal cables and a power cable. When installing this monitor on a wall or ceiling, insert the cable clampers into the holes on the rear of the monitor.

2 Connecting to External Equipment

Cables for connecting external equipment must be purchased separately.

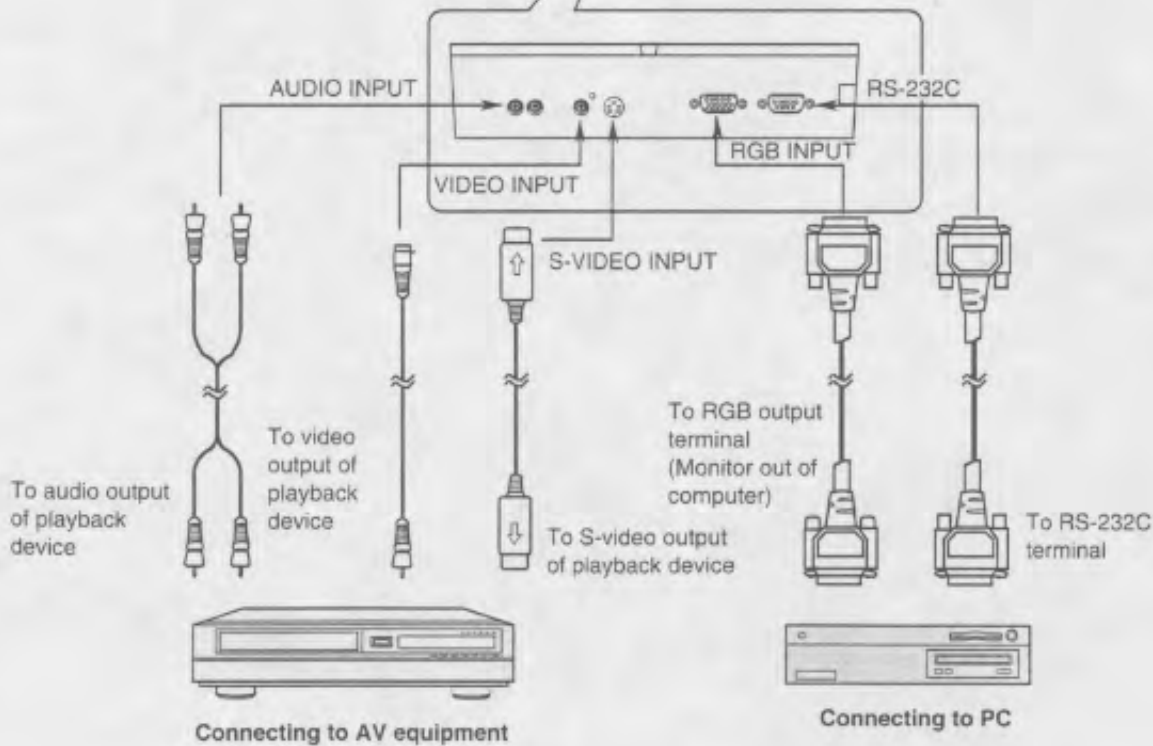
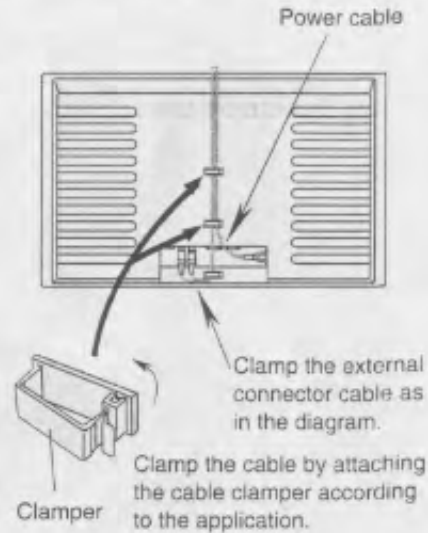
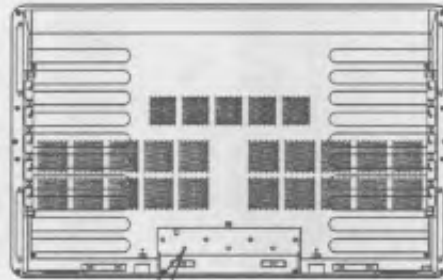

- Connection to a Macintosh requires a signal cable adaptor. Consult your product dealer.
- * Switch off the monitor and computer power when you are connecting to the system.

WHAT YOU SHOULD KNOW

POINTS ABOUT USAGE

- When installing this machine, use the optional desktop stand, wall-mounting unit, or ceiling mounting unit. Have the installation done by your product dealer.
 - For good heat dissipation, this monitor requires the space shown in the figure below.
 - The installation location must have an ambient temperature range of 0 °C – 40 °C.
- Refer to page 35 for optional parts .

When desktop stand used

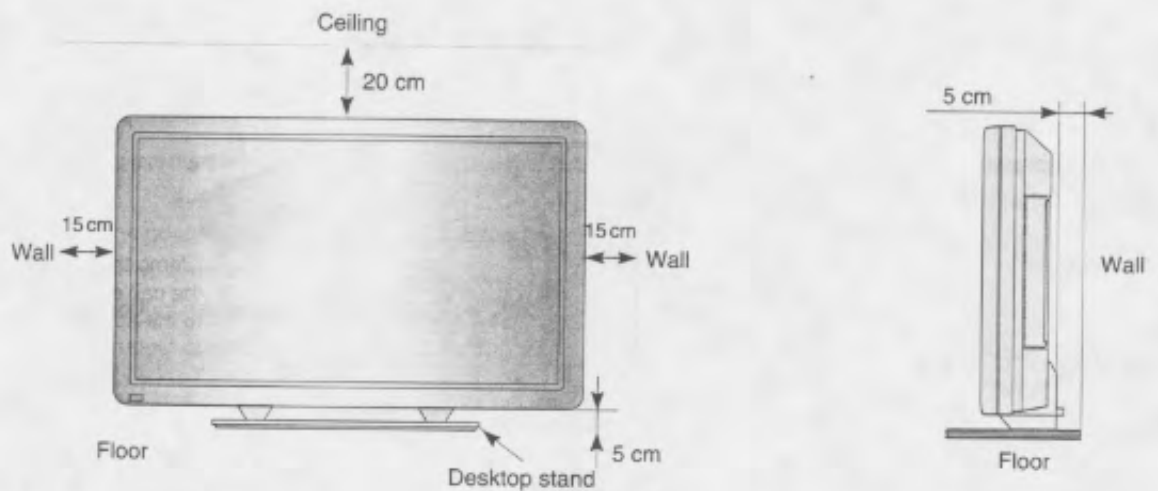

When wall-mounting unit used (horizontally)

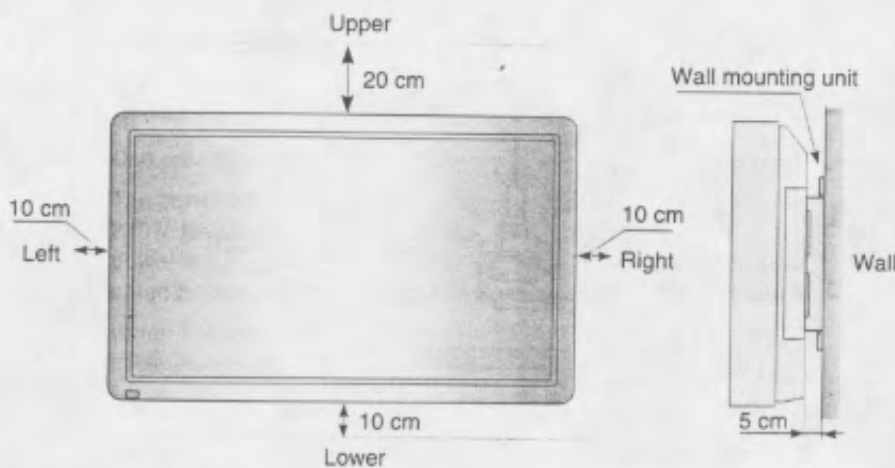

When ceiling-mounting unit used

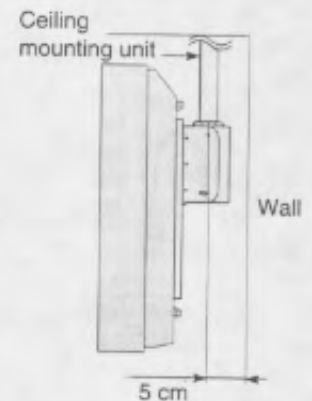

When wall-mounting unit used (vertically)

- When installing the monitor vertically, install it with the power lamp downward.

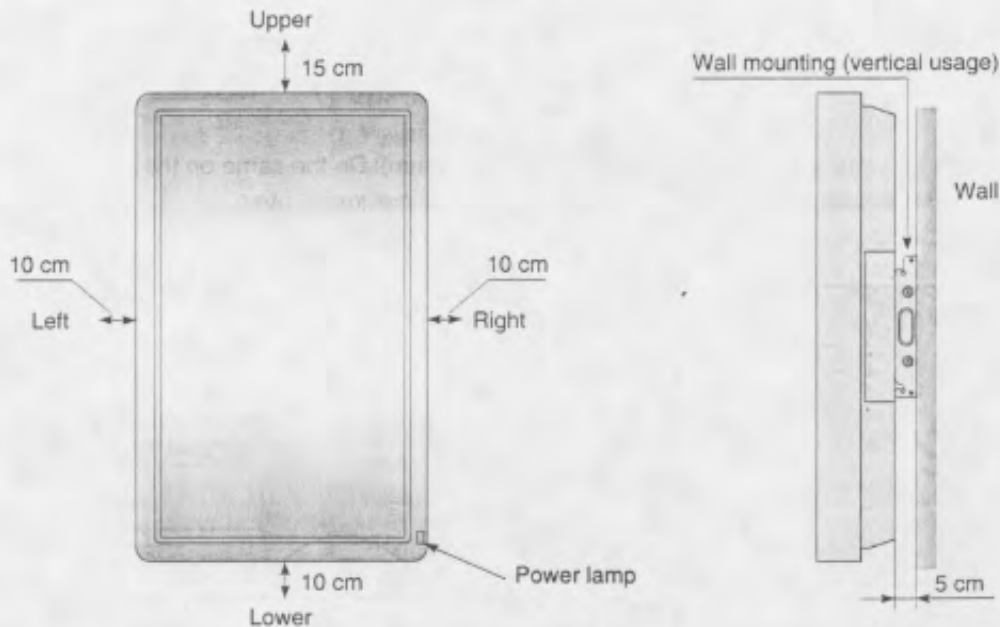

- Do not display the static picture continuously for a long time. Doing so raises the brightness of the picture and may cause after-images.

Do not install the monitor where it may be exposed to direct sunlight. Note that exposing the screen filter to direct sunlight for lengthy periods can cause discoloration.

- Avoid displaying the static picture for prolonged lengths of time.
Regularly use a display (such as a screen saver) that balances the entire screen.
- If the power lamp is blinking red, there is a danger of fire or electrical shock, so unplug the power cord and contact your product dealer.
- With the plasma display panel, dots with fine color unevenness may appear.
- Do not install this monitor where there will be interference between it and other AV equipment.
(Interference from electromagnetic waves can cause jumbled images, noise and malfunctioning of the infrared remote control.)

PREVENTING EQUIPMENT FROM FALLING

- This machine could topple over if children climb up on it or push it.

To prevent accidents and to ensure safety during disasters such as earthquakes, take precautions to ensure that the equipment cannot topple over.

ATTACHING TO WALL OR COLUMN

- Remove the cover on one side. Then attach bracket A at its top hole using screw A (10 mm). Do the same on other side.
- Attach bracket B on to the wall at one side using screw B (20 mm). Do the same on the other side. Then tie brackets A and B with a strong rope so that display panel does not topple over.
- This arrangement is stable when the rope is horizontal or pulled downward

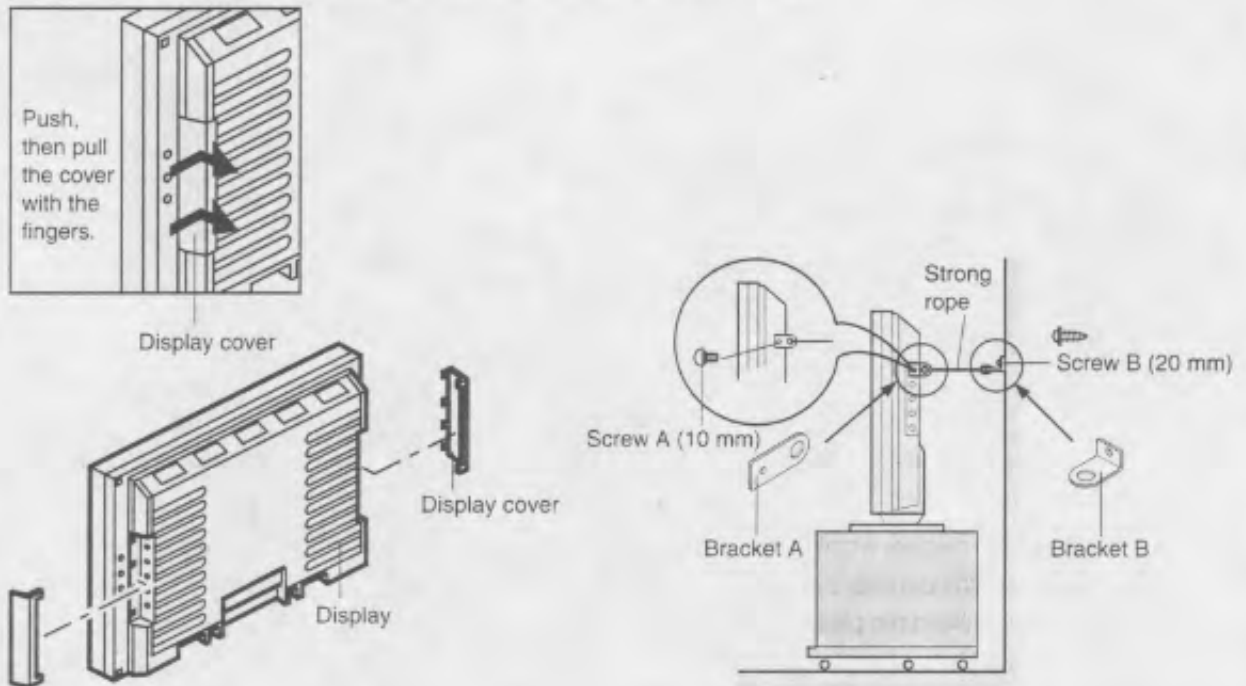

ATTACHING TO DESKTOP STAND

- Fasten the screws supplied with the desktop stand into their holes at the rear of the desktop stand.

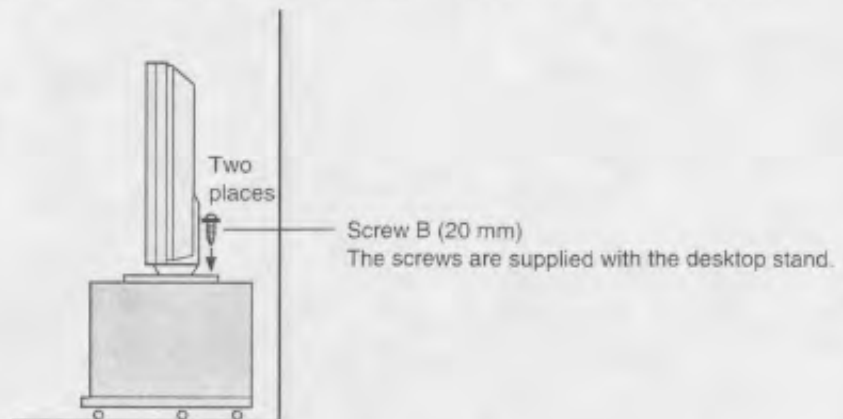

- For details, refer to Table P-42TT01 in the user's manual for the desktop stand.

NAMES OF PARTS AND THEIR FUNCTIONS

Main unit (front view)

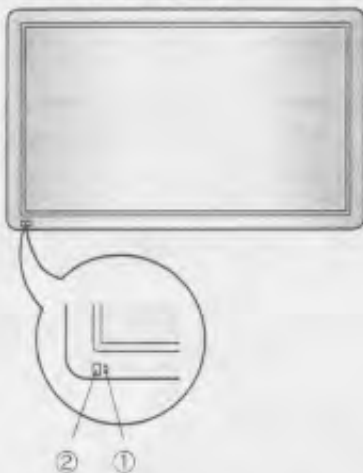

① Power lamp

- Shows the conditions of the main unit power.
- Lit (red)...Standby
- Lit (green)...Power on
- Blinking (red)...Abnormality in main unit. *Make sure to unplug the power cord.

② Remote control receiver

- Receives the signals from the remote controller.

③ Main unit operation

- Power button: Switches the power on or off.
- Mode select button: Selects the input mode.
- Menu button: Used to adjust the video and audio to your taste.
- Adjustment button: Used when making adjustments from the menu screen.
- Setting button: Used when deciding menu items and adjustment items.

④ Internal speakers

- Output the audio connected to the audio input terminals.

⑤ Power switch

- Switches the main power on or off.
- When this switch is on, the power lamp lights red.
- When this switch is off, the power lamp is off.

⑥ Power input terminal

- The accessory power cord is plugged in here.

⑦ Video input terminal (VIDEO INPUT)

- Connects to video output terminal of devices such as the video deck and video disc player.

⑧ S video input terminal (S-VIDEO INPUT)

- Connects to S video output terminal of video deck, video disc player, etc.
- * If cables are connected to both the S video input terminal and the video input terminal, the S video input terminal takes precedence over the latter.

⑨ RGB input terminal (RGB INPUT)

- Connects to computer RGB output terminal.
- Connection to a Macintosh model requires a signal cable adaptor, so consult your product dealer.

⑩ RS-232C terminal (RS-232C)

- Connects to computer RS-232C output terminal.

⑪ Audio input terminals (AUDIO INPUT)

- Connects to audio output terminals of VCR, etc.

Signal cable

- Connects to video output terminal of video equipment. This cable can be connected to a PS/2, PS/V, or IBM compatible machine.

Main unit (bottom view)

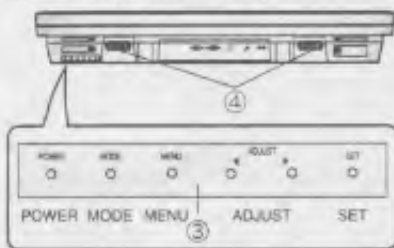

Main unit (rear view)

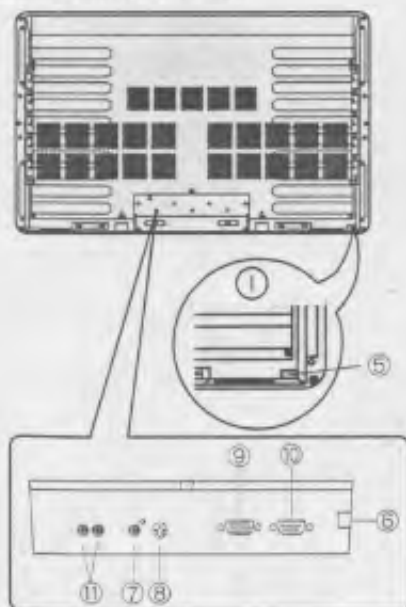

⚠ PRECAUTION

- Switch off the monitor and computer power before connecting to the system.

⚠ WARNING





- Never touch the power cord with wet hands. Doing so is very dangerous because of the possibility of electrical shock.

NAMES OF PARTS AND THEIR FUNCTIONS

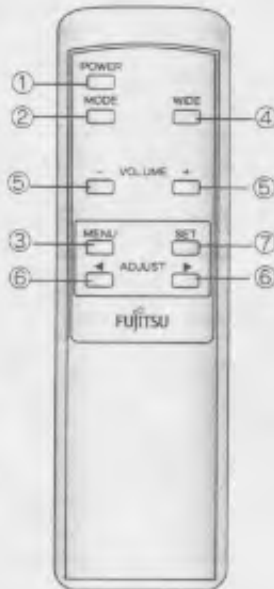
For details, see the page in markes ().

A Remote controller



- ① **Power button** 
 - Switches the power on or off.
- ② **Mode select button** 
 - Selects the input mode.
- ③ **Menu button**
 - Used to adjust the video and audio to your taste.
- ④ **Wide select button** 
 - Used to switch to the desired wide screen.
- ⑤ **Volume buttons** 
 - Used to adjust the volume.
- ⑥ **Adjustment button**
 - Used when making adjustments from the menu screen.
- ⑦ **Setting button**
 - Used when deciding menu items and adjustment items.

Handling the remote controller

Loading the batteries

- 1** Press on the cover and slide in the direction of the arrow.



- 2** Load two AA batteries, taking care that the + and - ends face the correct direction.



- 3** Close the cover until it clicks.



Reception range of remote controller

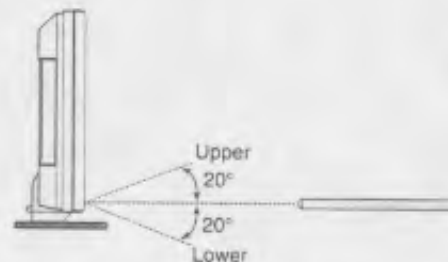
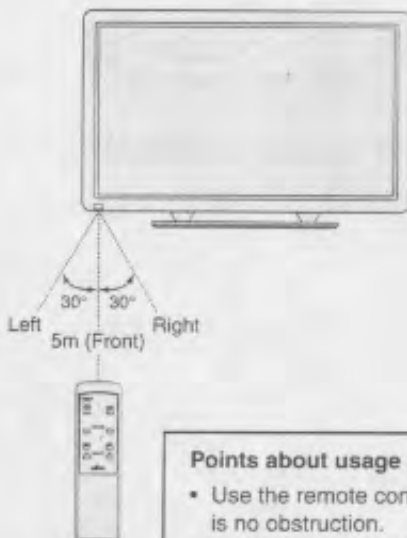

Points about usage

- Use the remote controller pointed in the direction of the remote control reception section, making sure there is no obstruction.
- The remote controller may not operate correctly in a room using high-frequency fluorescent lights. If this happens, move away from those lights.
- After it has been used for a long time, the remote controller batteries go flat. When this happens, replace them with new ones. When replacing the batteries, make sure they are the same type as the originals.
- Do not get the remote controller wet or leave it in a hot location or near any heat source such as a heater. Doing so can cause malfunction or deformation.
- Do not subject the remote controller to strong mechanical shocks. Doing so can cause malfunction.

BASIC OPERATIONS

PREPARATION

Switch on the main unit power switch.

Press the POWER SWITCH on the rear of the main unit. Pressing this switch again switches off the power. The power lamp lights (red).

1 Press the POWER button.

The power lamp changes from red to green.

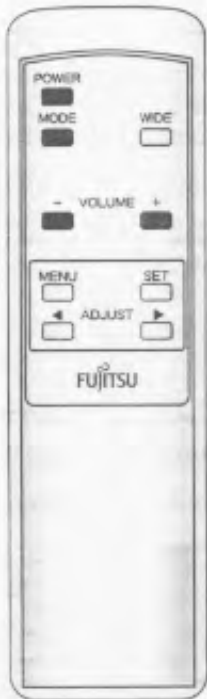

Example: Video mode

2 Select the video mode.

Select the video mode with the MODE button.

Each time the MODE button is pressed, the video mode toggles between the modes as shown below.

VIDEO ↔ RGB



Example: RGB mode

Mode number

* Adjusting the volume

Use the VOLUME buttons to adjust the volume .

- + button...Raises the volume.
- button...Lowers the volume.

* The current volume setting is memorized even when the power is switched off.



Mode display

- In video mode, if the signal cable is connected to the S video input terminal, S-VIDEO is displayed.
- The number in the RGB mode display is the mode number, a number from 1 to 16 according to the input signal.

VIEWING WIDE SCREEN (VIDEO MODE)

SWITCHING THE WIDE SCREEN AUTOMATICALLY

1 Press the WIDE button.

The current viewing mode is displayed.

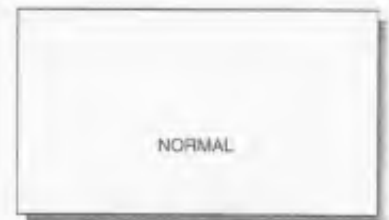
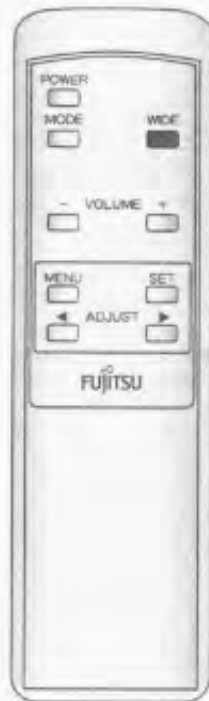

Example: NORMAL

2 With the WIDE button, select AUTO mode.

Pressing the WIDE button moves the mode to the next step in the sequence below.

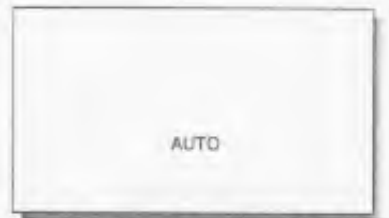
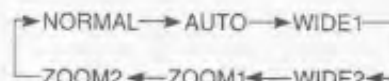

Example: When AUTO is selected,

When AUTO is selected, the wide screen is automatically selected according to the contents of the video.

In AUTO mode, the contents of the video software are detected and the display switches to the optimum wide screen as follows:

- For ordinary video software, the most appropriate wide screen appears.
- For vistavision video software, a normal picture appears with the top, bottom, left, and right -enlarged.
- For wide video software with subtitles, the display is automatically adjusted to compress the subtitle section so that it is not cut out.

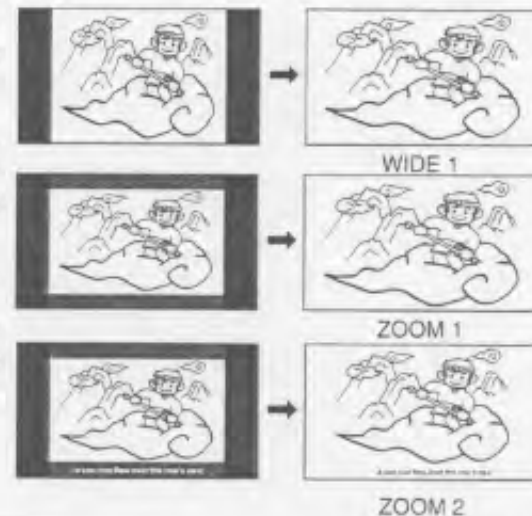

Notes

- In AUTO mode, some contents of the video software are not correctly displayed. Press the WIDE button to switch to the optimum screen size.
- Some game software will invoke the zoom screen. In this case, switch to the desired screen with WIDE button.
- For some 4:3 video software, in scenes where the top and bottom are extremely dark, the display may switch to the zoom screen.
- For video software that switches to the zoom screen automatically, the display may take a few moments to switch to the zoom screen for the first dark scene.

SETTING THE DESIRED WIDE SCREEN SIZE

1 Press the WIDE button.

The current viewing mode is displayed.

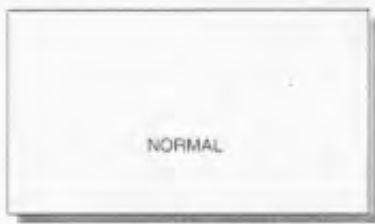

2 Press the WIDE button as many times as necessary to select the desired screen size.

Pressing the WIDE button moves the mode to the next step in the sequence below.

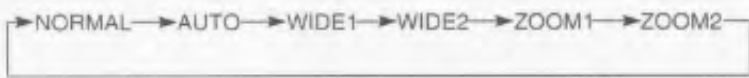

Example: When WIDE 1 is selected

SCREENS ASPECT RATIO

The aspect ratios (horizontal to vertical size ratios) for broadcasts and videos are as follows:

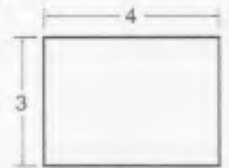

• VHF/UHF broadcasts

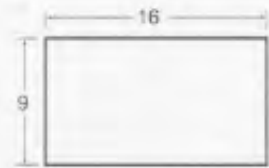

• Vistavision size software

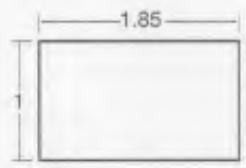

• Vistavision size software

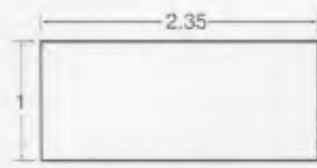

• Cinemavision size software

Points to note

- This monitor can be switched to a variety of screen modes. When the selected mode has a different picture aspect ratio from the media to be viewed, the picture will appear different from the original. Keep this in mind when selecting the screen mode.
- Note that use of a wide select function (e.g. WIDE1) to change the screen size or aspect ratio during commercial use or for public viewing in a coffee shop, hotel, or the like, may infringe on copyrights protected by the copyright law.
- If the wide select function is used to display non-wide screen conventional (normal) 4:3 video software over the entire screen, the picture will be deformed with part of the edge not visible. Users are requested to respect the intent of the creator of the original video and watch such software in normal mode.

WIDE SCREEN VIEWING (RGB MODE)

SETTING THE DESIRED WIDE SCREEN SIZE

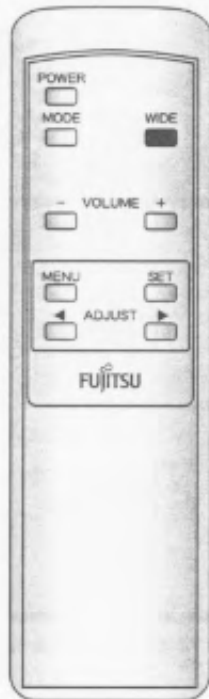

1 Press the WIDE button.

The current viewing mode is displayed.

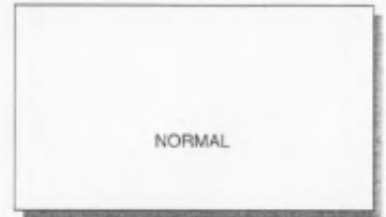

Example: Normal

2 Press the WIDE button to select the desired screen size.

Pressing the WIDE button moves the mode to the next step in the sequence below.



Example: When WIDE is selected

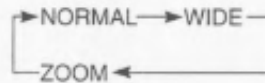

WIDE SCREEN MODES (RGB MODE)

- When the screen is vertically wide



- When the screen is horizontally wide

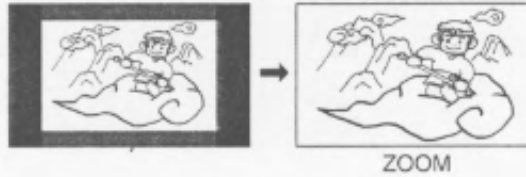

Notes

- With the wide display Graphics Board (optional), the wide mode does not change even when the WIDE button is pressed.
 - Some game software will invoke the zoom. In this case, switch to the desired screen with the WIDE button.
-

VIDEO ADJUSTMENTS (VIDEO MODE)

EXAMPLE: ADJUSTING THE BRIGHTNESS



1 Select PICTURE from the menu screen.

- 1) Press the MENU button.
- 2) Select PICTURE with the ADJUST button.

Press the SET button to fix the PICTURE settings.

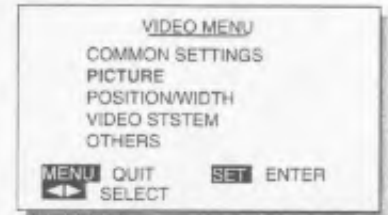

Example: When PICTURE is selected

2 Select the adjustment item.

Select BRIGHTNESS with the SET button.

Pressing the SET button moves the selection to the next item in the sequence below.

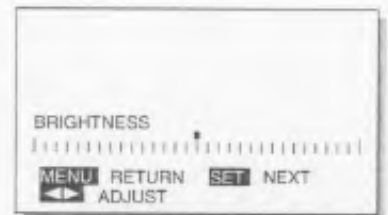
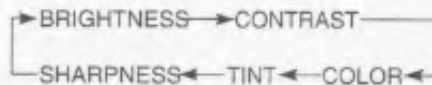

Example: When BRIGHTNESS is selected

3 Adjust to the desired picture.

▶ button...Makes the picture brighter.

◀ button...Makes the picture darker.

* To adjust multiple items, repeat Steps 2 and 3.

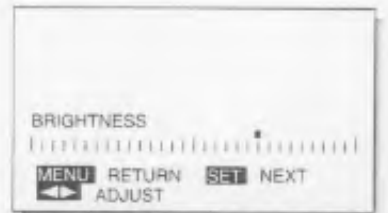

Example: When the ▶ button is pressed

* To complete adjustments

Press the MENU button to return to the VIDEO MENU.

Pressing the MENU button returns the display to the previous screen and closes the adjustment screen.

VIDEO ADJUSTMENT ITEMS

BRIGHTNESS

Screen brightness can be adjusted.

▶ button: Lightens brightness.

◀ button: Darkens brightness.

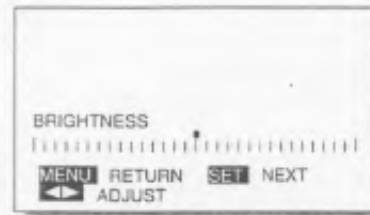

CONTRAST

Screen contrast (difference between dark and light) can be adjusted.

▶ button: Strengthens contrast.

◀ button: Weakens contrast.

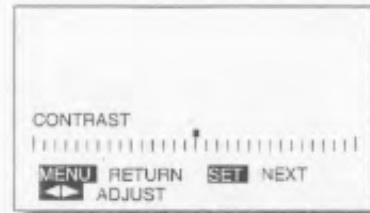

COLOR (color density)

Color density can be adjusted.

▶ button: Makes color more saturated.

◀ button: Makes color less saturated

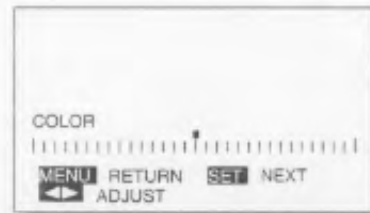

TINT

Color tint can be adjusted.

(TINT functions only in NTSC/4.43NTSC mode.)

▶ button: Makes the tint greener.

◀ button: Makes the tint more purple.

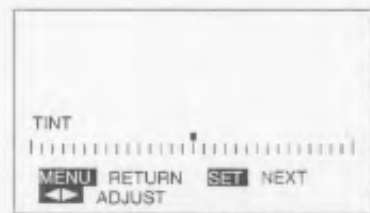

SHARPNESS

Picture sharpness can be adjusted.

▶ button: Produces a sharper image.

◀ button: Produces a softer image

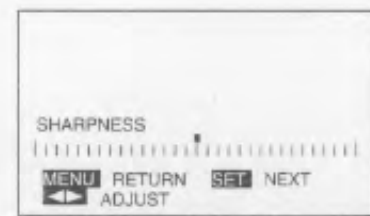

Adjustment items

- Pressing the SET button moves selection to the next item.

SCREEN ADJUSTMENT (VIDEO MODE)

EXAMPLE: ADJUSTING THE SCREEN VERTICAL POSITION



1 Select POSITION/WIDTH from the MENU screen.

- 1) Press the MENU button.
- 2) With the ADJUST button, select POSITION/WIDTH.

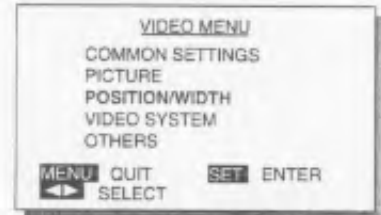

Example: When POSITION/WIDTH is selected

2 Select the adjustment item.

Select VERTICAL POSITION with the SET button.

Pressing the SET button moves the selection to the next item in the sequence below.

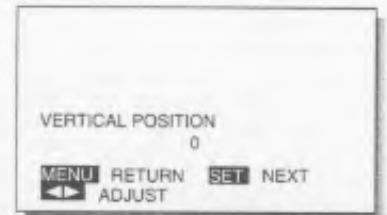
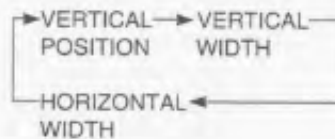

Example: When VERTICAL POSITION is selected

3 Adjust with the ADJUST button.

- ▶ button...Moves the screen up.
- ◀ button...Moves the screen down.
- * To adjust another item, repeat Steps 2 and 3.

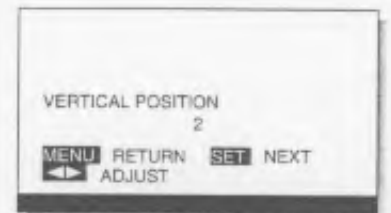

Example: When the ▶ button is pressed

* To complete adjustments

Press the MENU button to return to the VIDEO MENU.

Pressing the MENU button returns the display to the previous screen and closes the adjustment screen.

ADJUSTMENT ITEM LIST (ADJUSTMENT CRITERIA)

VERTICAL POSITION

- Moves the screen up and down.



When too low...Adjust with the **▶** button.

When too high...Adjust with the **◀** button.

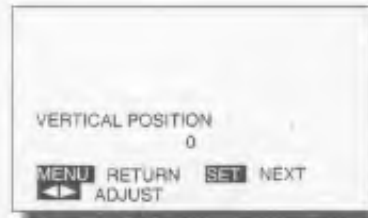

VERTICAL WIDTH

- Adjusts the vertical size of the screen.



When too small...Adjust with the **▶** button.

When too large...Adjust with the **◀** button.

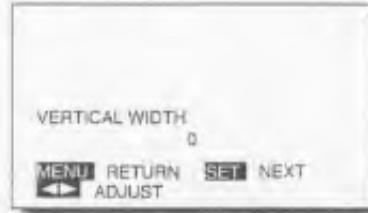

HORIZONTAL WIDTH

- Adjusts the horizontal size of the screen.

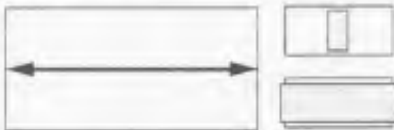

When too small...Adjust with the **▶** button.

When too large...Adjust with the **◀** button.

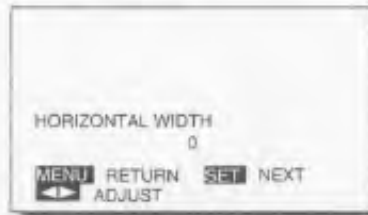

SETTING THE VCR BROADCAST TYPE

1 Select VIDEO SYSTEM from the MENU screen.

- Press the MENU button.
- With the ADJUST button, select VIDEO SYSTEM.

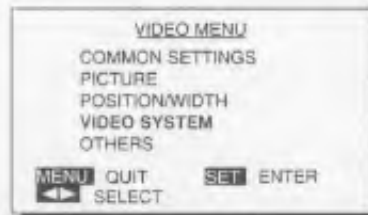

Example: When VIDEO SYSTEM is selected

2 Select the adjustment item.

Select the broadcast type with the ADJUST button.

Pressing the ADJUST button moves the selection to the next item in the sequence below.

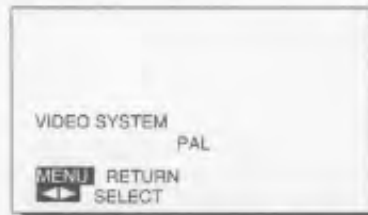
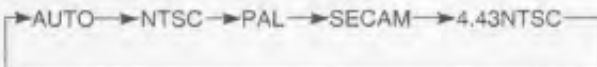

* To complete adjustments

Press the MENU button to return to the VIDEO MENU.

Pressing the MENU button returns the display to the previous screen and closes the adjustment screen.

Adjustment items

- Pressing the SET button moves selection to the next item.

VCR broadcast type

- The VCR broadcast type can be set to use with the VIDEO MENU.
- Sometimes when a tape has been recorded poorly or the reception is poor, the broadcast type cannot be correctly discriminated automatically. In this case, set the VIDEO SYSTEM setting by the procedure above.
- When playing imported video tapes, carefully read the video deck user's manual and check the output broadcast method.

OTHER ADJUSTMENTS (VIDEO MODE)

EXAMPLE: MAKING THE GAMMA SETTING



1 Select OTHERS from the menu screen.

- 1) Press the MENU button.
- 2) With the ADJUST button, select OTHERS.
- 3) Press the SET button to fix the OTHER setting.

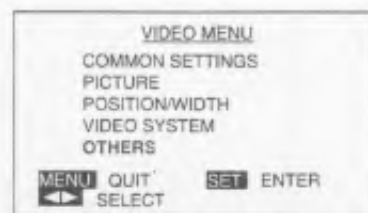

Example: When OTHERS is selected

2 Select the adjustment item.

With the SET button, select GAMMA.

Pressing the SET button moves the selection to the next item in the sequence below.

GAMMA ↔ GRADATION

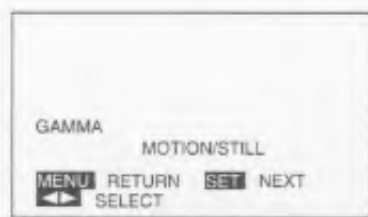

3 Adjust to the desired picture with the adjustment buttons.

Select with the ◀▶ buttons.

MOTION

Carries out automatic correction so that the video is optimum for viewing moving images.

STILL

Carries out automatic correction so that the video is optimum for viewing still images.

* To adjust another item, repeat Steps 2 and 3.

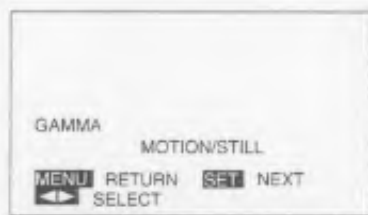

Example: When MOTION is selected

* To complete adjustments

Press the MENU button to return to VIDEO MENU.

Pressing the MENU button returns the display to the previous screen and closes the adjustment screen.

OTHER ADJUSTMENT ITEMS

GRADATION

- The gradations below can be set according to taste.

MODE1... Carries out automatic correction so that the video is optimum for viewing moving images.

MODE2... Carries out automatic correction so that the video is optimum for viewing still images.

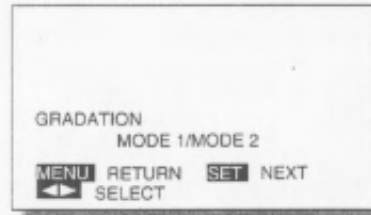

Adjustment items

- Pressing the SET button switches the adjustment item.
-

VIDEO ADJUSTMENTS (RGB MODE)

EXAMPLE: ADJUSTING THE CONTRAST

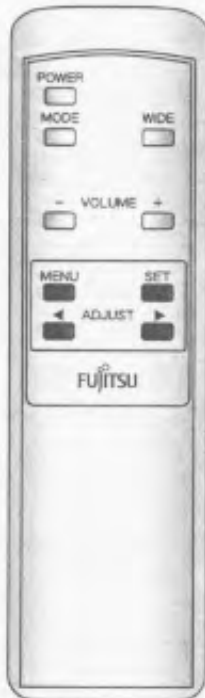

1 Select PICTURE from the MENU screen.

- 1) Press the MENU button.
- 2) With the ADJUST button, select PICTURE.
- 3) Press the SET button to fix the contrast.

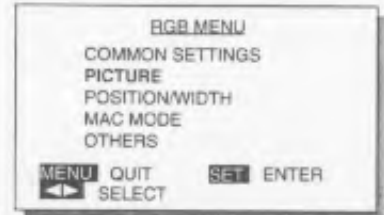

Example: When PICTURE is selected

2 Select the adjustment item.

With the SET button, select CONTRAST.

Pressing the SET button moves the selection to the next item in the sequence below.

BRIGHTNESS ↔ CONTRAST

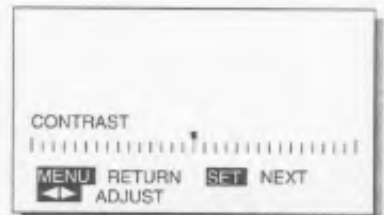

Example: When CONTRAST is selected

3 Adjust to the desired picture.

▶ button...Makes the picture brighter.

◀ button...Makes the picture darker.

* To adjust another item, repeat Steps 2 and 3.

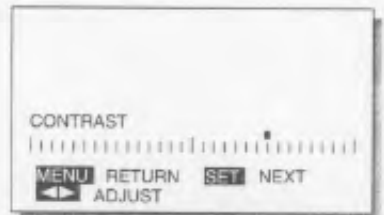

Example: When the ▶ button is pressed

* To complete adjustments

Press the MENU button to return to the RGB MENU.

Pressing the MENU button returns the display to the previous screen and closes the adjustment screen.

VIDEO ADJUSTMENT ITEMS (ADJUSTMENT CRITERIA)

BRIGHTNESS

Screen brightness can be adjusted.

- ▶ button: Lightens brightness.
- ◀ button: Darkens brightness.

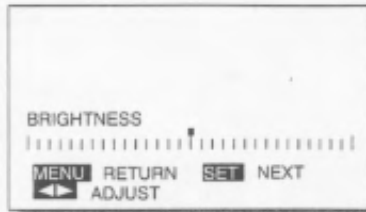

CONTRAST

Screen contrast can be adjusted.

- ▶ button: Strengthens contrast.
- ◀ button: Weakens contrast.

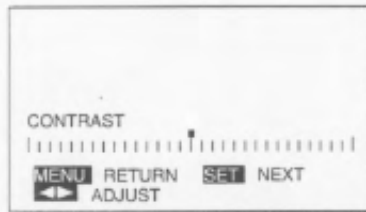

Adjustment items

- Pressing the SET button moves the selection to the next item.

MACINTOSH MODE (RGB MODE)

The Apple Macintosh has two dot clocks. If the display is partly cut or the video and the dot clock do not match, set the dot clock as follows:

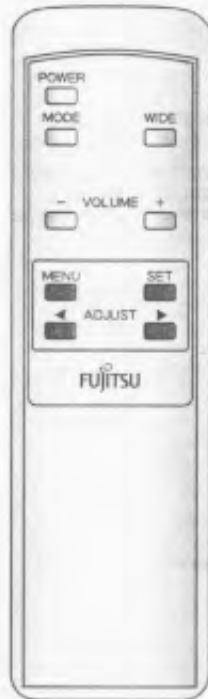

1 Select MAC MODE from the RGB menu screen.

- 1) Press the MENU button.
- 2) With the ADJUST button, select MAC MODE.

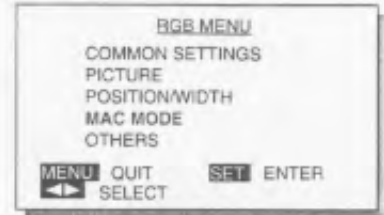

Example: When MAC MODE is selected

2 Select the adjustment item.

Press the SET button.

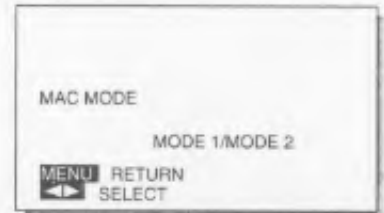

Example: When MAC MODE is selected

3 Select the appropriate mode for the dot clock.

Select with the ADJUST button.

Pressing the ADJUST button switches modes as below.

MODE 1 ←→ MODE 2

f_H f_V

MODE 1...35 kHz 66.67 Hz

MODE 2...34.975 kHz 66.62 Hz

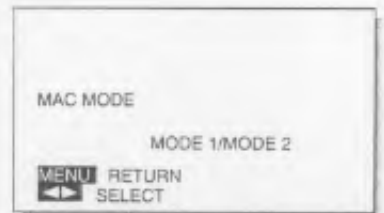

Example: When MODE1 is selected

* To complete adjustments

Press the MENU button to return to the RGB MENU.

Pressing the MENU button returns the display to the previous screen and closes the adjustment screen.

WIDE SCREEN ADJUSTMENTS (RGB MODE)

EXAMPLE: ADJUSTING THE VERTICAL WIDTH OF THE SCREEN.

1 Select POSITION WIDTH from the MENU screen.

- 1) Press the MENU button.
- 2) With the ADJUST button, select POSITION/WIDTH.
- 3) Press the SET button to fix the vertical width.

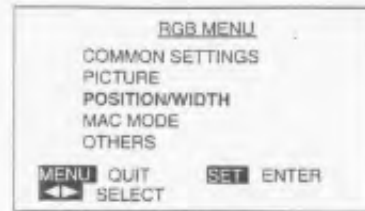

Example: When POSITION WIDTH is selected

2 Select the adjustment item.

With the SET button, select VERTICAL WIDTH.

Pressing the SET button moves the selection to the next item as below.

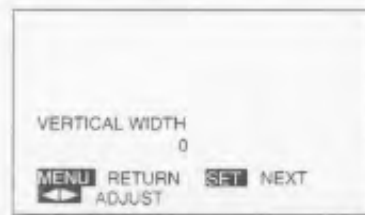
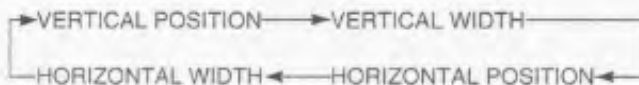

Example: When VERTICAL WIDTH is selected

3 Adjust to the desired vertical width.

- ▶ button: Increases the vertical width of the screen.
- ◀ button: Decreases the vertical width of the screen.

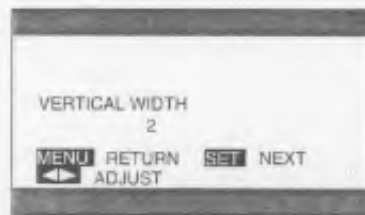

Example: When the ▶ button is pressed

* To complete adjustments

Press the MENU button to return to the RGB MENU.

Pressing the MENU button returns the display to the previous screen and closes the adjustment screen.

VERTICAL POSITION

Adjusts the position of the screen up and down.

VERTICAL WIDTH

Adjusts the vertical size of the screen.

HORIZONTAL POSITION

Adjusts the position of the screen left and right.

HORIZONTAL WIDTH

Adjusts the horizontal size of the screen.

OTHER ADJUSTMENTS (RGB MODE)

EXAMPLE: GRADATION SETTING



1 Select OTHERS from the MENU screen.

- 1) Press the MENU button.
- 2) With the ADJUST button, select OTHERS.
- 3) Press the SET button to fix the gradation setting.

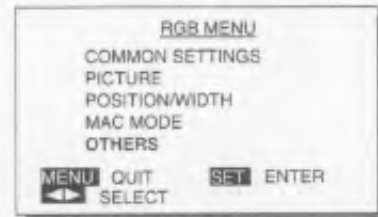

Example: When OTHERS is selected

2 Select the adjustment item.

With the SET button, select GRADATION.

Pressing the SET button moves the selection to the next item as below.

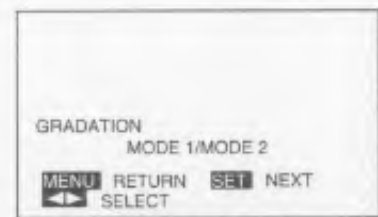

Example: When GRADATION is selected

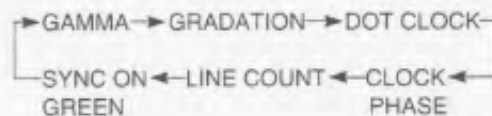

3 Adjust to the desired picture.

Adjust with the ADJUST button.

MODE1: Carries out automatic correction so that the video is optimum for viewing moving images.

MODE2: Carries out automatic correction so that the video is optimum for viewing still images.

* To adjust another item, repeat Steps 2 and 3.

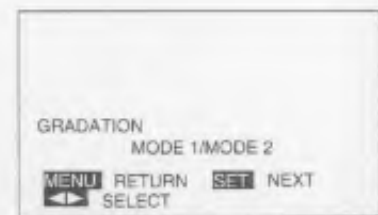

Example: When the right arrow button is pressed

* To complete adjustments

Press the MENU button to return to the RGB MENU.

Pressing the MENU button returns the display to the previous screen and closes the adjustment screen.

OTHER ADJUSTMENT ITEMS (ADJUSTMENT CRITERIA)

GAMMA

Dynamic gamma correction can be set.

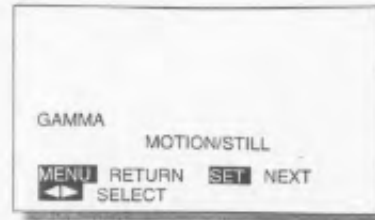

GRADATION

Gradation can be set.

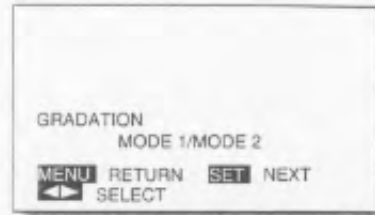

DOT CLOCK

Adjust if the picture is out of focus.

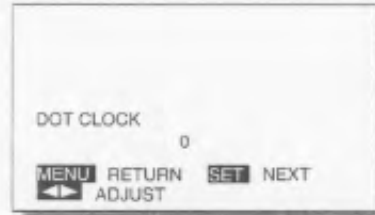

CLOCK PHASE

Adjust if the picture is out of focus.

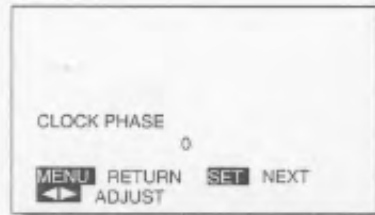

LINE COUNT

When the screen wavers vertically, select MODE1 or MODE2.

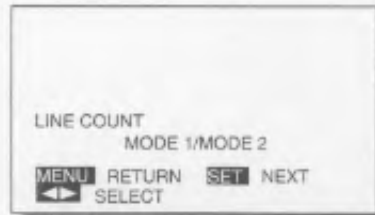

SYNC ON GREEN

Clamp pulse phase and pulse width can be set.

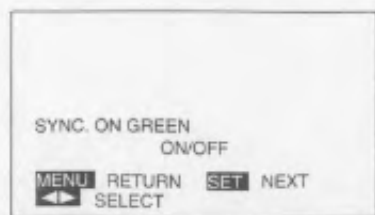

- Depending on the type of input signal, if you input SYNC ON GREEN and other sync signals simultaneously, the screen background may become too bright and greenish. If this happens, select ON.

ON-SCREEN DISPLAY SETTING



1 Select COMMON SETTINGS from the MENU screen.

- 1) Press the MENU button.
- 2) With the ADJUST button, select COMMON SETTINGS.
- 3) Press the SET button to fix the COMMON SETTINGS display setting.



Example: When COMMON SETTINGS is selected

2 Select the adjustment item.

With the SET button, select DISPLAY.

Pressing the SET button moves the selection to the next item as below.

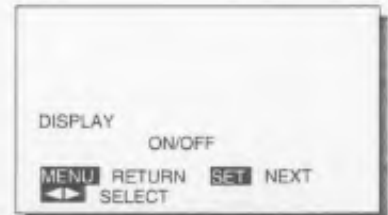
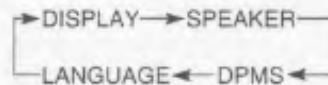

Example: When DISPLAY is selected

3 Set the desired setting.

The setting changes each time the ADJUST button is pressed.

ON ... The mode is displayed for a few seconds when the power is first switched on and when the mode is switched.

OFF ... The mode is not displayed.

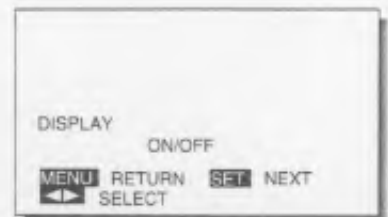

Example: When ON is selected

* To complete adjustments

Press the MENU button to return to the VIDEO MENU or RGB MENU.

Pressing the MENU button returns the display to the previous screen and closes the adjustment screen.

INTERNAL SPEAKER SETTING

1 Select COMMON SETTINGS from the MENU screen.

- 1) Press the MENU button.
- 2) With the ADJUST button, select COMMON SETTINGS.
- 3) Press the SET button to fix COMMON SETTINGS.

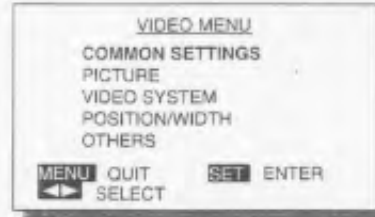

Example: When COMMON SETTINGS is selected

2 Select the adjustment item.

With the SET button, select SPEAKER.

Pressing the SET button moves the selection to the next item as below.

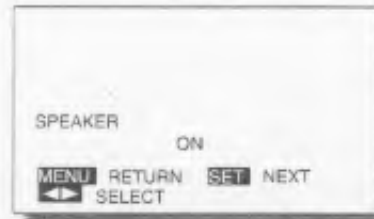
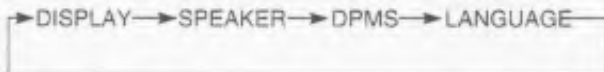

Example: When SPEAKER is selected

3 Set the internal speakers.

Select with the ADJUST button. Pressing the ADJUST button moves the selection to the next item as below.

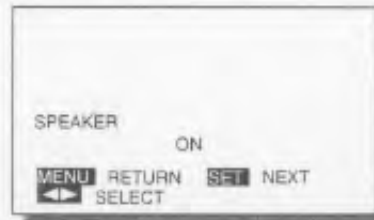
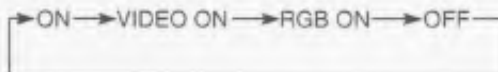

Example: When ON is selected

* To complete adjustments

Press the MENU button to return to VIDEO MENU or RGB MENU.

Pressing the MENU button returns the display to the previous screen and closes the adjustment screen.

Adjustment items

- Pressing the ADJUST button moves the selection to the next item.
- ON: When using the internal speakers even under the VIDEO or RGB mode
- VIDEO ON: When using the internal speakers only in the VIDEO mode
- RGB ON: When using the internal speakers only in the RGB mode
- OFF: When not using the internal speakers

DPMS SETTING



1 Select COMMON SETTINGS from the MENU screen.

- 1) Press the MENU button.
- 2) With the ADJUST button, select COMMON SETTINGS.



Example: When COMMON SETTINGS is selected

2 Select the adjustment item.

With the SET button, select DPMS.

Pressing the SET button moves the selection to the next item as below.

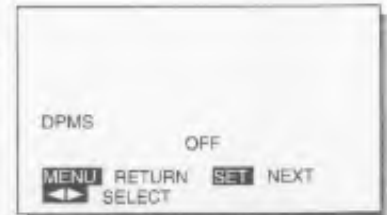
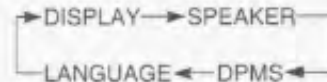

Example: When DPMS is selected

3 Set the time until the power conservation function operates.

Select with the ADJUST button.

Pressing the ADJUST button moves the selection to the next item as below.

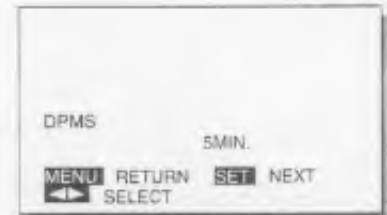
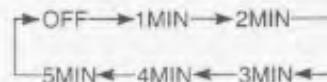

Example: When 5 minutes are set

* To complete adjustments

Press the MENU button to return to VIDEO MENU or RGB MENU.

Pressing the MENU button returns the display to the previous screen and closes the adjustment screen.

Points on Usage

- If the picture is not displayed even when the signal is input again, press the POWER button.

DPMS

- DPMS is a function that automatically reduces the amount of power consumed by this monitor.

When the power is on, if no signal is input within the set time, the power management function is triggered, the monitor screen is automatically switched off, and the monitor goes on standby.

This signal wait time can be set from 1 to 5 minutes in units of one minute. Also, the power management function can be switched off. (The factory setting is Off.)

DISPLAY LANGUAGE SETTING (VIDEO INPUT/RGB INPUT)

1 Select COMMON SETTINGS from the MENU screen.

- 1) Press the MENU button.
- 2) With the ADJUST button, select COMMON SETTINGS.

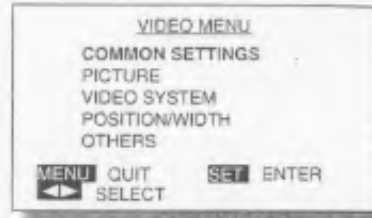

Example: VIDEO mode

2 Select the adjustment item.

With the SET button, select LANGUAGE.
Pressing the SET button moves the selection to the next item as below.

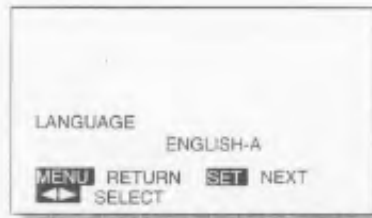
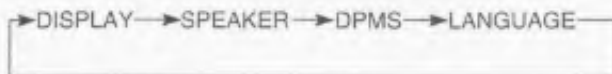

Example: When LANGUAGE is selected

3 Select the display language.

Select with the ADJUST button.
Pressing the ADJUST button moves the selection to the next item as below.

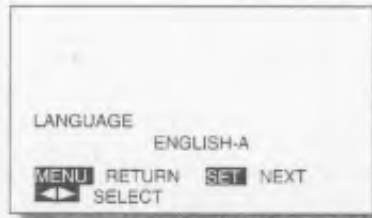
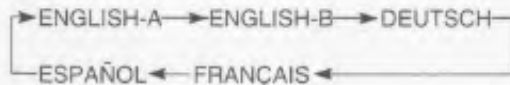

Example: When ENGLISH-A is selected

* To complete adjustments

Press the MENU button to return to VIDEO MENU or RGB MENU.
Pressing the MENU button returns the display to the previous screen and closes the adjustment screen.

This monitor has a five-language on screen menu.

- ENGLISH-A ----- American English
- ENGLISH-B ----- British English
- DEUTSCH ----- German
- FRANÇAIS ----- French
- ESPAÑOL ----- Spanish

ADJUSTMENT LEVEL MEMORY

This monitor is set at the factory with adjustment values for 9 types of signals. (See the table below.) When any of these signals is input, it is automatically discriminated. For these signals, the desired screen can be adjusted according to the instructions in Adjusting the Screen Position and Amplitude.

This monitor can also store settings for 7 types of signals in addition to those set at the factory, as shown in the table below. Input the signals whose settings are to be stored into memory and adjust for the desired screen following the instructions in Adjusting the Screen Position and Amplitude. Release the adjustment button to automatically store the level into memory. After adjustment, when the same signals are input, they are displayed with the setting levels last stored into memory.

Factory set signals

Mode number	Display (dots × lines)	Horizontal frequency (kHz)	Vertical frequency (Hz)	Supported signal
1	852 × 480	31.722	59.966	* When dedicated graphics board used
2	640 × 480	31.469	59.940	VGA
3	640 × 480	37.861	72.809	VGA 72 Hz
4	640 × 480	37.500	75.000	VGA 75 Hz
5	720 × 400	31.468	70.09	VGA 400 lines
6	640 × 480	35.00	66.67	MAC 13RGB (1)
	640 × 480	34.975	66.62	MAC 13RGB (2)
7	640 × 240	15.73	60.06	15kHz
8	640 × 400	24.83	56.40	24kHz
9	640 × 400	31.5	70.15	31kHz
10				
11				
12				
13		15.7 to 37.90	50.00 to 75.00	User settings
14				
15				
16				

Notes

The company names and product names in this document are trademarks or registered trademarks of their respective companies.

CARE AND MAINTENANCE

BEFORE CLEANING

Always unplug the power cord from the socket.

Do not use benzene, paint thinner, or other solvents. They can cause deterioration or paint peeling on the cabinet, the screen front filter, or the remote controller.

Cleaning the cabinet/remote controller

Wipe gently with a soft cloth. If very grimey, soak the soft cloth in neutral cleaning agent diluted with water, wring it out well, and wipe clean. Then, finish with a dry, soft cloth.

Screen (filter) cleaning

Wipe gently with a soft cloth. The surface of the screen is easily scratched, so do not strike it or rub it with anything hard.

Beware of interference between equipment.

Do not install this monitor where there will be interference between it and other AV equipment.

BEFORE REQUESTING REPAIR

If you think a malfunction may have occurred

Inspect the following items.

When this happens	Check
<ul style="list-style-type: none"> The power does not come on. 	<ul style="list-style-type: none"> Is the power cord disconnected?
<ul style="list-style-type: none"> The picture does not appear. 	<ul style="list-style-type: none"> Is a cable to other equipment disconnected?
<ul style="list-style-type: none"> The remote controller does not work. 	<ul style="list-style-type: none"> Are the batteries installed with their poles reversed? Are the batteries flat? Are you operating from far away? Are you trying to operate with the transmitting section of the remote controller not facing the reception section of the monitor? Is there any obstruction between the monitor and the remote controller?
<ul style="list-style-type: none"> There is a creaking sound. 	<ul style="list-style-type: none"> This sound is generated by the expansion and contraction of the cabinet due to change in the temperature in the room.
<ul style="list-style-type: none"> There is a humming sound. 	<ul style="list-style-type: none"> This monitor has heat radiation fins to prevent its internal temperature from rising too high during operation. The sound you hear is the fan rotating.
<ul style="list-style-type: none"> There are dots on the screen. 	<ul style="list-style-type: none"> Is the monitor being affected by interference from a car, train, high-voltage line, neon light, or the like?
<ul style="list-style-type: none"> The colors and tints are poor. 	<ul style="list-style-type: none"> Are any of the video adjustments out of adjustment?
<ul style="list-style-type: none"> There is no sound. 	<ul style="list-style-type: none"> Are the internal speakers switched off?
<ul style="list-style-type: none"> ERROR MESSAGE CONDITION 1 	<ul style="list-style-type: none"> The fan is malfunctioning. Switch off the power.
<ul style="list-style-type: none"> ERROR MESSAGE CONDITION 2 	<ul style="list-style-type: none"> The temperature inside the set has risen far too high. Switch off the power. (The power can be turned on once the temperature lowers.)

SPECIFICATIONS

The specifications and appearance are subject to change for the sake of improvement.

Model name	PDS4201U-H/PDS4201E-H/PDS4201A-H
Screen size	42 inches
Aspect ratio	16:9
Weight	39.5 kg
External dimensions	103.5 x 64 x 15 cm
Power supply	AC100-240V, 50/60 Hz
Input current	3.2 A
Screen dimensions	92 x 51.8 cm
Display pixel count	852 x 480
Display modes	<ul style="list-style-type: none"> • Video input NORMAL, AUTO, WIDE1, WIDE2, ZOOM1, ZOOM2 • RGB input NORMAL, WIDE, ZOOM
Display colors	16.7 million (256 each for red, green and blue)
Maximum viewing angle	160 degree
Audio output	4 W (2W + 2W)
Speakers	Two internal
External connection terminals	<ul style="list-style-type: none"> • Video input One BNC terminal 1Vp-p/75 Ω • S video input One S terminal Y: 1Vp-p/75 Ω C: 0.286 Vp-p/75 Ω • Analog RGB Input One m-sub 15 pin terminal Video signal: 0.7 Vp-p/75 Ω SYNC signal: TTL level • RS-232C One D-sub 9-pin terminal
Operating conditions	Temperature 0 to 40°C, humidity 20 to 80 %
Audio input	One system with two pin plug terminals (L/R) 500 mVrms/22 kΩ min.
Color System	NTSC/PAL/SECAM/4.43NTSC
Accessories	One remote controller (P-42RM01-B), two AA batteries, one power cord, two cable clampers, user's manual

● Regulation

- PDS4201U-H...ULI950/CSA C22.2 No.950/FCC Class A subpart of part 15
- PDS4201E-H
 - Safety : EN60950 1992A1 : 1993/A2: 1993
 - EMC : EN55022 1994, Class A
 - EN61000-3-2 1995
 - EN61000-3-3 1995
 - EN50082-2 1995
 - EN61000-4-2 1995
 - EN61000-4-4 1995
 - EN61000-4-8 1993
 - ENV50140 1993
 - ENV50141 1993
 - ENV50204 1995
- PDS4201A-H
 - Safety : IEC 950 A1/A2/A3/A4
 - EMC : AS/NZS 3548

● Model Name

The model names are classified according to their destinations. The specifications of the power cord differ by the destinations(model names).

The specifications other than those of the power cord are the same for all the models.

SPECIFICATIONS

RGB input terminal (Display is RGB INPUT.)

Connects to a personal computer RGB output terminal.



Pin connection	Input signal	Pin connection	Input signal
1	Red	9	
2	Green	10	Ground
3	Blue	11	
4		12	
5	Ground	13	Hor. sync
6	Ground	14	Vert. sync
7	Ground	15	
8	Ground	Outer side	Ground

RS-232C input terminal (Display is RS-232C.)

Connects to a personal computer RS-232C terminal.

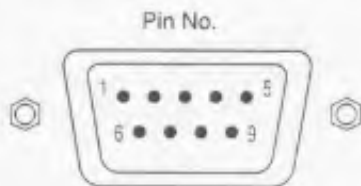

Pin No.	No. Signal	Pin No.	No. Signal
1	DCD (Data Carrier Detect)	6	DSR (Data Set Ready)
2	RD (Receive Data)	7	RTS (Request To Send)
3	TD (Transmit Data)	8	CTS (Clear To Send)
4	DTR (Data Terminal Ready)	9	RI (Ring Indication)
5	GND (Ground)		

OPTIONS

The following options are available. For details, consult your product dealer.

<ul style="list-style-type: none"> Wall-mounting unit (horizontal) 	For 0° installation angle...P-42WB01-B For 5° installation angle...P-42WB02-B For 10° installation angle...P-42WB03-B For 15° installation angle...P-42WB04-B
<ul style="list-style-type: none"> Wall-mounting unit (vertical) 	For 0° installation angle...P-42WB50-B
<ul style="list-style-type: none"> Ceiling-mounting unit 	Installation angle variable 0-15° P-42CT01-B
<ul style="list-style-type: none"> Desktop stand 	P-42TT01-H
<ul style="list-style-type: none"> Graphics board 	P-42GA02 With the Graphics board mounted in the computer, the computer can be displayed as an 852-dot by 480-line wide RGB screen.

Follow the installation and usage instructions in the optional product user's or installation manual when installing an option.

WARNING

- To install or move this monitor, contact your product dealer.
- Users must not attempt to install or move the monitor as this could result in electrical shock, or injury from the monitor dropping or toppling over.

Free Manuals Download Website

<http://myh66.com>

<http://usermanuals.us>

<http://www.somanuals.com>

<http://www.4manuals.cc>

<http://www.manual-lib.com>

<http://www.404manual.com>

<http://www.luxmanual.com>

<http://aubethermostatmanual.com>

Golf course search by state

<http://golfingnear.com>

Email search by domain

<http://emailbydomain.com>

Auto manuals search

<http://auto.somanuals.com>

TV manuals search

<http://tv.somanuals.com>