

USER'S MANUAL (1/2)

(Functions and connections)

WIDE PLASMA DISPLAY

P42VCA30W/P42VCA30E

WITH OPTIONAL VIDEOBOARD

(P-TE1100/P-TE1110/P-TE1120/P-TE1130)

HE4VS01W/HE4VS01E

WITH OPTIONAL VIDEOBOARD (HETES01/HETES02)

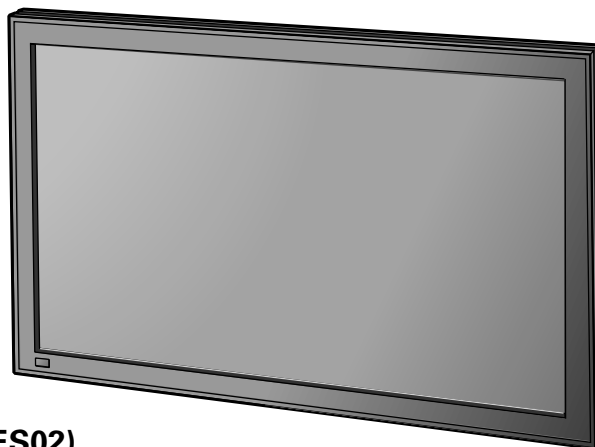

Plasmavision™

Contents

	Page
• Accessories	E-2
• Part Names and Functions	E-3–E-6
• Installation	E-7
• Options	E-8–E-9
• Factory Settings	E-10
• Specification	E-11

Before Use

- Safety Precautions User's manual (2/2)

Usage

- Using the Remote Control ... User's manual (2/2)
- Connecting the Display to External Equipment User's manual (2/2)
- Basic Operations User's manual (2/2)
- Selecting Input Mode User's manual (2/2)
- Watching Pictures on the Wide Screen User's manual (2/2)

Adjustments

- Adjusting Pictures (PICTURE Menu) User's manual (2/2)
- Adjusting Screen Position and Size (POSITION/SIZE Menu) User's manual (2/2)
- Adjusting Audio (AUDIO Menu) User's manual (2/2)
- Other Adjustments (FEATURES Menu) User's manual (2/2)
- Initialization of User Adjustment Value (FACTORY DEFAULT) User's manual (2/2)
- Cleaning and Maintenance ... User's manual (2/2)

Before using the display, read the User's manual (1/2) and the User's manual (2/2) carefully so that you know how to use the display correctly.

Refer to these manuals whenever questions or problems about operation arise. Be sure to read and observe the safety precautions.

Keep these manuals where the user can access them readily.

** Installation and removal require special expertise. Consult your product dealer for details.*

ACCESSORIES

CHECKING ACCESSORIES

• Display

One remote control Two AA batteries Two user's manuals One power cable Two big ferrite cores

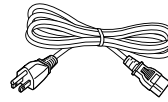

(W Type)

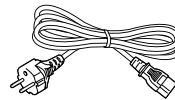

(E Type)



• Video board

Two small ferrite cores Two user's manuals Five M3 screws



(supplied on models with external speaker output terminals)

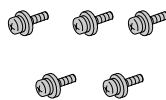

CONNECTING THE DISPLAY TO EXTERNAL EQUIPMENT

Carefully check the terminals for position and type before making any connections.

Loose connectors can result in picture or color problems. Make sure that all connectors are securely inserted into their terminals.

Ferrite cores

These ferrite cores are used to attenuate undesired signals.

Two big ferrite cores

When connecting a cable to the power input terminal, RS-232C terminal, attach one of these ferrite cores to the cable near the terminal.

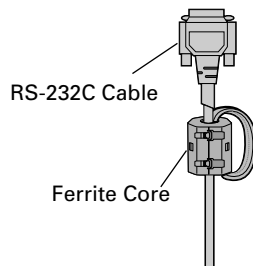
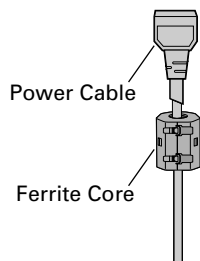

Two small ferrite cores

When connecting a cable to the external speaker output terminal attach one of these ferrite cores to the cable near the terminal.

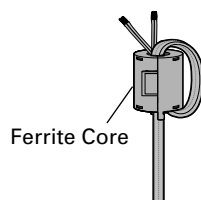
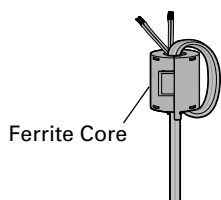

PART NAMES AND FUNCTIONS

Front

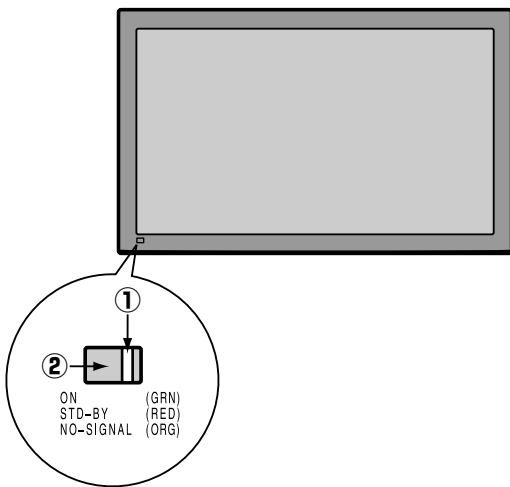

① Power indicator lamp

This lamp shows the state of the power supply.

Lit (red): Power OFF (stand-by)

Lit (green): Power ON

Lit (orange): Power saving (DPMS: Power saving function) mode ON

Flashing (red or green): Malfunction (Flashes differently depending on the type of malfunction.)

② Remote control signal receiver

Receives signals from the remote control.

Warning

If the power indicator lamp flashes red or green, this signifies that the display has developed a problem. When this happens, be sure to remove the power plug from the receptacle and contact your dealer. Leaving the display power ON can result in fire or electric shock.

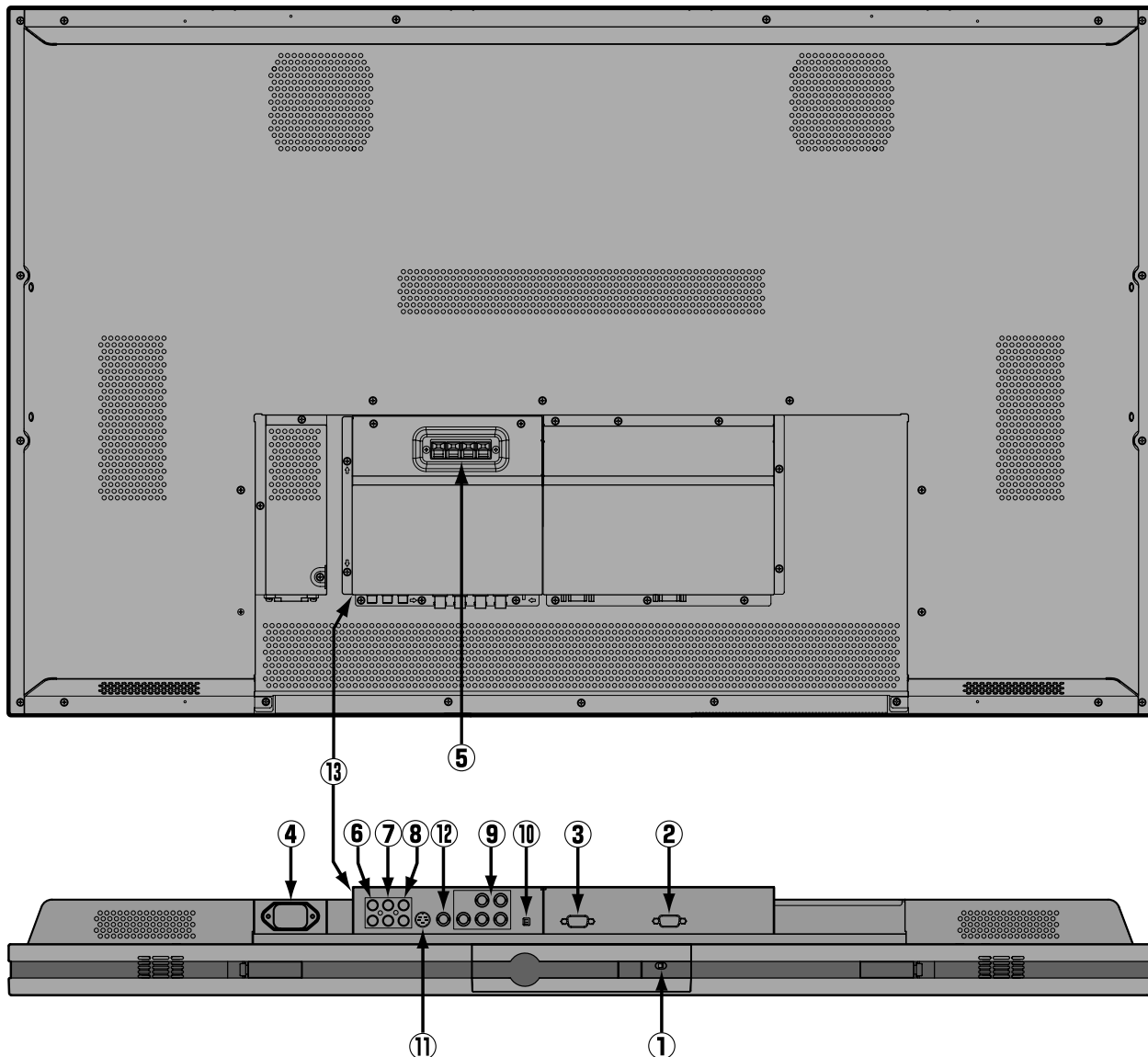

PART NAMES AND FUNCTIONS (Continued)

Back and bottom (With the video board)



① **OFF/STD-BY**  **switch**

 OFF :The power indicator lamp goes off, and the power can't be turned on by the power button. The power is partly supplied.

 STD-BY  :The power indicator lamp lights red, and the power can be turned on or off by the power button.

② **RS-232C terminal (RS-232C)**

This terminal is provided for you to control the display from the PC. Connect it to the RS-232C terminal on the PC.

When connecting a cable, attach a ferrite core to the cable. (See P. E-2.)

③ **RGB1 input terminal (RGB1 INPUT/mD-sub)**

Connect this terminal to the PC's display (analog RGB) output terminal or decoder (digital broadcast tuner, etc.) output terminal.

④ **Power input terminal**

Connect this terminal to the power cable supplied with the display.

When connecting a cable, attach a ferrite core to the cable. (See P. E-2)

⑤ **External speaker output terminal (EXT SP)**

Connect this terminal to the optionally available speaker.

(When using other speaker than the optional one, use 4–16 Ω speaker.)

When connecting a cable, attach a ferrite core to the cable. (See P. E-2.)

⑥ **Sound 1 input terminal (AUDIO1 INPUT)**

⑦ **Sound 2 input terminal (AUDIO2 INPUT)**

⑧ **Sound 3 input terminal (AUDIO3 INPUT)**

Connect this terminal to the sound output terminal of your VCR, etc.

* The Sound 3 input terminal (AUDIO3 INPUT) is not available for the video board P-TE1110/HETES02.

⑨ **RGB2 input terminal (RGB2 INPUT/BNC)**

Connect this terminal to the PC's display (analog RGB) output terminal.

⑩ **RGB2 synchronization switch (SYNC SW TTL/ANALOG (75 Ω))**

This switch is used to terminate horizontal (H) terminal and vertical (V) terminal, out of RGB2 input terminals, with 75 Ω .

TTL : Does not terminate.

ANALOG (75 Ω) : Terminates.

⑪ **S-Video input terminal (S VIDEO INPUT)**

Connect this terminal to the S-video output terminal of your VCR.

⑫ **Video input terminal (VIDEO INPUT)**

Connect this terminal to the video output terminal of your VCR.

⑬ **Video board (Optional)**

* Terminal layout may differ and functions may not be available with some models and some device options.

PART NAMES AND FUNCTIONS (Continued)

Description of Input Terminals

RGB1 terminal (RGB1 INPUT/mD-sub)

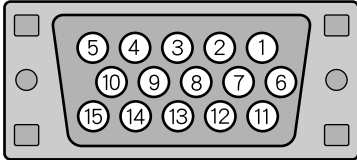

Pin No.	Input signal	Pin No.	Input signal
1	Red	9	—
2	Green	10	Ground
3	Blue	11	—
4	—	12	—
5	Ground	13	Horizontal synchronization
6	Ground	14	Vertical synchronization
7	Ground	15	—
8	Ground	Frame	Ground

RS-232C terminal (RS-232C)

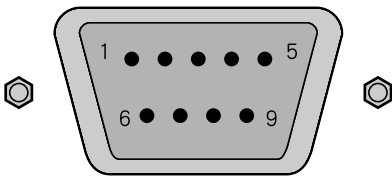

Pin No.	Signal
1	DCD (Data Carrier Detect)
2	RD (Received Data)
3	TD (Transmit Data)
4	DTR (Data Terminal ready)
5	GND (Ground)
6	DSR (Data Set Ready)
7	RTS (Request To send)
8	CTS (Clear To Send)
9	RI (Ring Indication)

To prevent the display's internal components from overheating, make sure that the display is installed in a well-ventilated location.

Be sure to use the optional desktop stand, ceiling-mounting unit, wall-mounting unit and other unit when installing this display. Also, be sure that your dealer performs the installation.

See the appropriate instruction manual for more information on the installation hardware you select.

To ensure proper heat radiation, provide at least as much space around the display as shown below.

- * Make sure that the display is installed in a location where the temperature can be maintained between 0°C and 40°C.
- * Install this device in a well-ventilated area. Keep the air vents of the device free from obstruction.
- * Never attempt to tilt the display sideways or backward.
- * To prevent the power and other cables from being accidentally pulled, be sure to make the wiring work along the wall or through the corners of floor.
- * To prevent an accident and ensure safety in the event of an earthquake, fix the display securely into position as described below.

Horizontal type

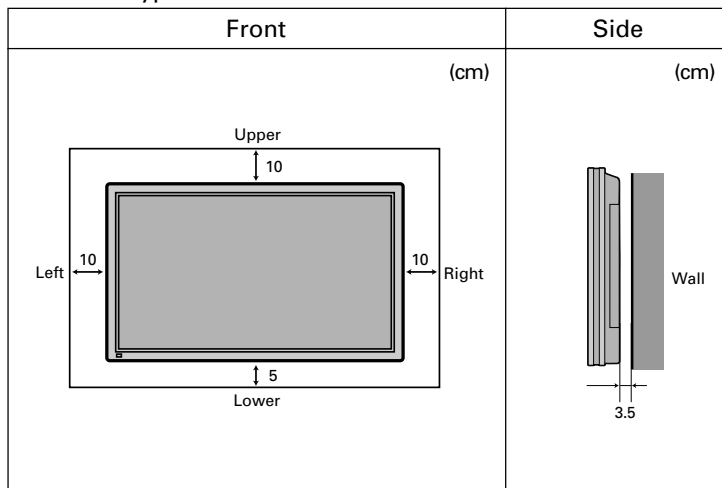



Note

The display is a highly precise piece of equipment and therefore must be packed properly before transportation. Be sure to use only those packing materials originally supplied with the display when repacking it.

Reference

See P.E-8 for more information on options.

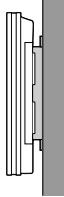
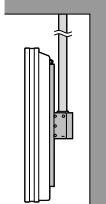
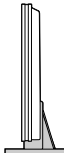
OPTIONS

Wall-mounting Bracket	0° to 15° mounting angle	P-WB4201	
Ceiling unit	0° to 15° mounting angle	P-CT4200	
Desktop Stand unit		P-TT4200	
Speaker system		P-42SP11 (1 set of 2 speakers)	
Desktop Speaker Stand		P-42ST11 (1 set of 2 speakers stands)	

Videoboard

• P42VCA30

Designation \ Terminal	RGB2 terminal	Speaker terminal	Video, S-video
P-TE1100	○	—	—
P-TE1110	○	○	—
P-TE1120	○	—	○
P-TE1130	○	○	○

• HE4VS01

Designation \ Terminal	RGB2 terminal	Speaker	Video, S-video
HETES01	○	○ (internal)	○
HETES02	○	○ (internal)	—

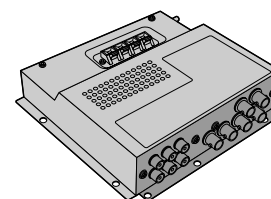

- * When installing an option, make sure that all installation requirements for that option (as given in the relevant instruction manual) are met.
- * The colors of options do not match the display colors perfectly.
- * To improve the function and performance of optional accessories, specifications and part names may change. Consult your local dealer before purchasing.

Warning

To prevent injury, fire, and electric shock, arrange for options to be initially installed (or installed at a different location) by your dealer.

CAUTION: This display (P42VCA30, HE4VS01) is for use only with Fujitsu General Limited's option (P-WB4201, P-CT4200, P-TT4200).
Using this display with other option can cause instability resulting in possible injury.

INSTALLING THE VIDEO BOARD

1. Turn the power supply switch to OFF.
2. Remove the power plug from outlet.
3. Remove the metal fittings on the installation position at the rear of this device (M3 screw x 2).
4. Slide the video board into the installation opening along the left and right guide pins and insert the connectors.
5. Use the accompanying screws to secure (M3 screw x 5, accompany video board).

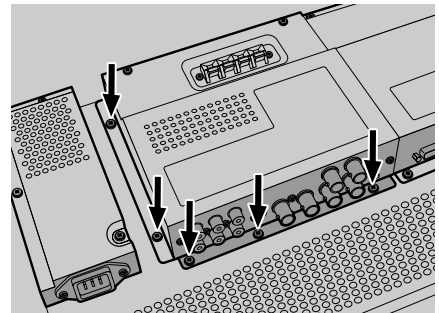
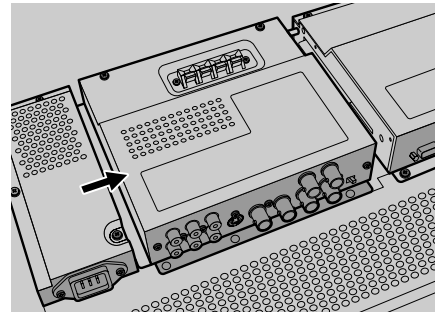
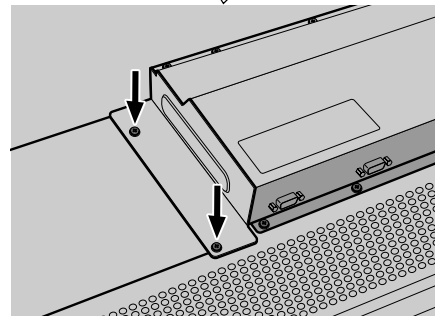
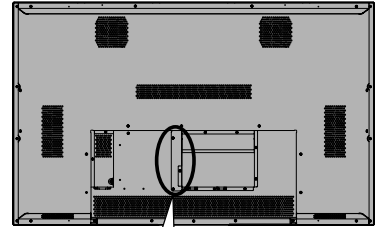

CAUTION: Follow the items given below, to prevent accidental injuries and possible electrical shock.

Turn off the power supply and disconnect the power plug from outlet before installing the Video board unit.
 Do not remove the cabinet when installing the Video board unit.
 Do not remove screws except for the specified user service screw marked “↑”.
 Do not use screws other than that specified in this manual for the installation of this Video board unit.

FACTORY SETTINGS

This display can store the latest four types of signals for RGB adjustment value. The fifth input signal will delete the adjustment value of the first input signal.

To do this, select a desired signal and follow the instructions in “Adjusting Screen Position and Size” on the User’s Manual (2/2) to adjust the parameters. When you finish, the settings will be automatically stored. Thus, when the display receives that signal, pictures will be displayed in accordance with the settings you most recently selected.

Main corresponding signals (RGB mode)

Display (dots x lines)	Horizontal frequency (kHz)	Vertical frequency (Hz)	Signal
640 x 480	31.47	59.94	VGA
640 x 480	37.50	75.00	VGA 75 Hz
640 x 480	43.27	85.01	VGA 85 Hz
720 x 400	31.47	70.09	400 lines
800 x 600	37.88	60.32	SVGA 60 Hz
800 x 600	46.88	75.00	SVGA 75 Hz
800 x 600	53.67	85.06	SVGA 85 Hz
1024 x 768	48.36	60.00	XGA 60 Hz
1024 x 768	60.02	75.03	XGA 75 Hz
1024 x 768	68.68	84.99	XGA 85 Hz
1280 x 1024	63.98	60.02	SXGA 60 Hz
1280 x 1024	79.98	75.03	SXGA 75 Hz
1600 x 1200	75.00	60.00	UXGA 60 Hz
1600 x 1200	106.25	85.00	UXGA 85 Hz
848 x 480	31.02	60.00	
852 x 480	31.72	59.97	
1360 x 768	47.71	60.01	
720 x 485	15.73	59.94	60 fields
720 x 575	15.63	50.00	50 fields

* With some input signals, “Out of range” may appear even when the horizontal and vertical frequencies are within their permissible ranges. Make sure that the vertical frequency of the input signal matches the above frequency.

In the Video/S-video modes, the display has been factory-set as follows for different input signals:

Main corresponding signals (Video, S-video mode)

Horizontal frequency (kHz)	Vertical frequency (Hz)	Signal
15.73	59.94	NTSC
15.63	50.00	PAL
15.63	50.00	SECAM
15.63	59.52	PAL60
15.73	59.94	4.43NTSC

- Depending on the input signal, the display may show pictures of reduced size due to size reduction and interpolation.
- “Out of range” appears if the display receives a signal whose characteristic does not fall within the display’s permissible range.
- You can check input signals through “Information” on the FEATURES Menu screen. (See User’s Manual (2/2))
- In order to facilitate the explanations, pictures and diagrams in this manual may differ slightly from the actual items.
- All terms (i.e., company and product names) used in this document are trademarks or registered trademarks.
- Functions may be different or unavailable with some models and some device options.

SPECIFICATION

Model	P42VCA30W/P42VCA30E	HE4VS01W/HE4VS01E
Screen size	42" wide screen: 92.0 cm (W) x 51.8 cm (H) (106.0 cm diagonal) 36.3 inch (W) x 20.4 inch (H) (41.6 inch diagonal)	
Aspect ratio	16:9 (wide)	
Weight	31 kg / 68 lbs	31.5 kg / 69.4 lbs
Outer dimensions	103.5 (W) x 64.0 (H) x 8.5 (D) cm 40.7 (W) x 25.2 (H) x 3.3 (D) inch (does not include outer projections)	
Power supply	110-240 VAC 50/60Hz	
Current rating	4.1-1.9 A	
Number of pixels	852 (H) x 480 (V)	
Colors	16.77 million	
Sound output	—	2 W + 2 W (EIAJ), 8 Ω (only with video board installed)
Speaker	—	2-internal (only with video board installed)
Operating conditions	Temperature: 0 to 40 °C / 32 to 104 °F Humidity: 20 to 80 %	
External equipment terminals		
RGB1 input	mD-sub, 3 rows, 15-pin Picture signal: 0.7 Vp-p/75 Ω Synchronization signal:TTL level	
Control terminal	1 RS-232C connector (D-sub 9-pin)	

* The video board input specifications conform with those provided below.

* Terminals may not be available with some video board models.

* Consult your local dealer before purchase.

External equipment terminals		
RGB2 input	BNC terminal x 5 R: 0.7 Vp-p/75 Ω G: 0.7 Vp-p/75 Ω B: 0.7 Vp-p/75 Ω H: TTL Level or ANALOG (75 Ω) V: TTL Level or ANALOG (75 Ω)	
Video input	1 BNC terminal	1 Vp-p/75 Ω
S-video input	1 S terminal	Y: 1 Vp-p/75 Ω C: 0.286 Vp-p/75 Ω
Sound terminals	2 sound input pin jacks (L/R) (3 lines), 500 mVrms/ at least 22 kΩ (The Sound 3 input terminal (AUDIO3 INPUT) is not available for the video board P-TE1110/HETES02.)	
External speaker output terminal	Effective max. output:10 W + 10 W (EIAJ), 8 Ω	—

Regulation

- UL, CSA Safety: UL6500, C-UL
EMC: FCC Part 15 Class A, ICES-003 Class A
- CE Safety: EN60065
EMC: EN55022 1998, Class A
EN61000-3-2 1995
EN61000-3-3 1995
EN55024 1998
EN61000-4-2 1995
EN61000-4-3 1996
EN61000-4-4 1995
EN61000-4-5 1995
EN61000-4-6 1996
EN61000-4-8 1993
EN61000-4-11 1994
- AS Safety: IEC60065
EMC: AS/NZS 3548

- Specifications and external appearance may be change for the sake of improvement.
- **Plasmavision**™ is a worldwide trademark of Fujitsu General Limited and is a registered trademark in Japan, the U.S.A. and other countries or areas.

Free Manuals Download Website

<http://myh66.com>

<http://usermanuals.us>

<http://www.somanuals.com>

<http://www.4manuals.cc>

<http://www.manual-lib.com>

<http://www.404manual.com>

<http://www.luxmanual.com>

<http://aubethermostatmanual.com>

Golf course search by state

<http://golfingnear.com>

Email search by domain

<http://emailbydomain.com>

Auto manuals search

<http://auto.somanuals.com>

TV manuals search

<http://tv.somanuals.com>