

WIDE PLASMA DISPLAY
P42HTA51E SERIES
P50XTA51E SERIES

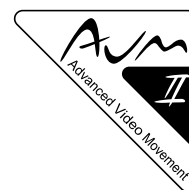

PlasmaVision™



Before using the display, read this manual carefully so that you know how to use the display correctly. Refer to this manual whenever questions or problems about operation arise. Be sure to read and observe the safety precautions (see the separate "Safety Precautions" manual). Keep this manual where the user can see it easily.

Keep this manual where the user can see it easily.

** Installation and removal require special expertise. Consult your product dealer for details.*

** When "English" is selected at "Language" of the on-screen display, "colour" will be displayed in the case of the E model and "color" will be displayed for all other models.*

The notation used in this user's manual is "color".

** The last digit of MODEL NO. (10 digit alphanumeric characters) indicated on the product means the body color indication alphabet or the management number.*

CONTENTS

INFORMATION	E-3	Ambient Sensor	E-20
ACCESSORIES	E-4	Picture Mode	E-20
ATTACHING THE FERRITE CORES	E-4	Color Temp.	E-21
INSTALLATION	E-5	Picture Memory	E-21
PART NAMES AND FUNCTIONS	E-6	ADJUSTING SCREEN POSITION AND SIZE	E-22
DISPLAY SECTION – FRONT	E-6	Screen Position	E-22
DISPLAY SECTION – BACK	E-6	Screen Size	E-22
DISPLAY SECTION – BOTTOM	E-7	ADJUSTING AUDIO	E-23
REMOTE CONTROL	E-8	Treble	E-23
USING THE REMOTE CONTROL	E-10	Bass	E-23
PUTTING BATTERIES IN THE REMOTE CONTROL	E-10	Balance	E-23
PRECAUTIONS	E-10	Loudness	E-23
EFFECTIVE RANGE FOR THE REMOTE CONTROL	E-10	OTHER ADJUSTMENTS	E-24
CONNECTING THE DISPLAY TO EXTERNAL		ADJUSTMENT	E-24
EQUIPMENT	E-11	Dot Clock	E-24
DVD RECORDER/PLAYER, SATELLITE TUNER	E-11	Clock Phase	E-24
VCR/PC	E-11	Clamp Position	E-24
BASIC OPERATIONS	E-12	Auto Calibration	E-24
TURNING THE POWER ON AND STAND-BY	E-12	ON SCREEN MENU	E-24
ADJUSTING THE VOLUME	E-12	On-screen display Information (OSD)	E-24
WATCHING A TV BROADCASTING	E-13	Language (Language)	E-24
WATCHING A TELETEXT BROADCASTINGS	E-14	Name Selection (Name Select)	E-25
VIDEO INPUT MODE	E-14	SETTING THE INPUT TERMINALS	E-25
RGB INPUT MODE	E-15	Video1 or Video2 Input terminal	E-25
CONVENIENT FUNCTIONS	E-15	D-SUB Input terminal	E-25
DISPLAY	E-15	CHANNEL SETTING	E-26
PICTURE MODE	E-15	Auto Store	E-26
PICTURE MEMORY	E-15	Manual Store	E-26
DUAL CHANNEL	E-15	Sort	E-26
OFF-TIMER	E-15	OTHER SETTINGS	E-27
WATCHING PICTURES ON THE WIDE SCREEN	E-16	Auto Off-NO SIG.	E-27
SWITCHING BETWEEN SCREEN SIZES	E-16	Audio Input	E-27
SCREEN SIZE	E-17	Screen Orbiter	E-27
ASPECT RATIO	E-17	Direct Setting	E-28
ADJUSTMENT MENU	E-18	Code Setting	E-28
BASIC PROCEDURE OF ADJUSTMENT MENU		White Screen	E-28
OPERATIONS	E-19	Background	E-28
ADJUSTING THE PICTURE	E-20	Information	E-28
Signal Contrast	E-20	INITIALIZATION OF USER ADJUSTMENT VALUE	E-29
Drive Contrast	E-20	OPTIONS	E-30
Brightness	E-20	MAIN SUPPORTED SIGNALS	E-31
Color	E-20	TABLE OF TV FREQUENCIES	E-32
Tint	E-20	SPECIFICATIONS	E-33
Sharpness	E-20	CLEANING AND MAINTENANCE	E-34

TRADEMARK INFORMATION



HDMI (High-Definition Multimedia Interface)

HDMI, the HDMI logo and High-Definition Multimedia Interface are trademarks or registered trademarks of HDMI licensing LLC.

- Receptacle

Make sure that the power cord's grounding wire is grounded.

The plasma display comes with a 3-prong power plug; one prong is connected to the grounding wire. If you have only a 2-hole receptacle, you will need to have it replaced. Contact your dealer for more information.

- Have the plasma display inspected and cleaned by your dealer at regular intervals.
- Do not display the same picture for a long time, because part of the screen may "burn-in" and create a residual image if the same picture is displayed for an extended period of time. To prolong the life of the plasma display, we recommend the use of the "Screen Orbiter" settings. (See P. E-27) When a residual image was created, reduce the residual image by using the "White Screen" settings. Note that there may also be cases when it can not be recovered completely. (See P. E-28)
- When the screen size is set to "Normal" and a picture was displayed for a long time, a residual image may be created at the boundary with the part at which an image is not displayed. We recommend that you use a screen size other than "Normal". (See P. E-16)
- High-precision technology has been used in the manufacture of the plasma display panel, in which the effective pixels exceeds 99.99%. However, please be aware, that fewer than 0.01% of the pixels may be missing or remain constantly lit.
- Some models are fitted with a radiator fan to prevent the plasma display's internal temperature from rising during operation. Be careful of the air emitted by the radiator fan, as it may be hot.
- Contact your dealer when causing a bad influence to the plasma display and other audio-visual equipment mutually.
You may need to move your plasma display if it produces degraded pictures or noise due to electromagnetic radiation, or if the infrared remote control does not function properly.
- Pictures may not be displayed properly if you connect a non-standard PC to the RGB input terminal. In this case, contact your dealer for more information.
- The protective circuit, built into the display, automatically turns off the power if the display has a problem. In this case, you will see that the power indicator lamp flashes red or green.

Warning

If the power indicator lamp flashes red or green, this signifies that the display has developed a problem. When this happens, be sure to unplug from the receptacle to prevent fire or electric shock. Then contact your dealer.

- It is important to install the plasma display in a location close to a receptacle, and where the emergency stop button can be easily reached.

Note

- Cables for connecting the display to external equipment are not supplied. Contact your dealer for more information on these supporting products.
- The pictures and diagrams in this manual are meant to complement the explanations and may differ slightly from the actual items.

INFORMATION (Continued)

ACCESSORIES

Safety
Precautions



This manual



Remote control



AA battery (2)

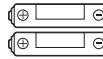

Power cable

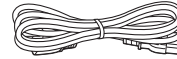

Spacer (4)

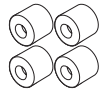

Small ferrite
core (2)

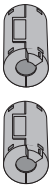

Large ferrite
core



ATTACHING THE FERRITE CORES

Be sure to turn OFF the power to the display and external equipment before making any connections.

No cables are supplied with the display for connection to external equipment. The type of cable to be used varies depending on the PC model. Contact your dealer for more information.

Carefully check the terminals for position and type before making any connections.

Loose connectors can result in picture or color problems. Make sure that all connectors are securely inserted into their terminals.

These ferrite cores are used to attenuate undesired signals. Attach them correctly as shown in the following illustrations.

1 big ferrite core

When connecting the cord to the power input terminal, attach one of these ferrite cores to the cord and the cable near the terminal.

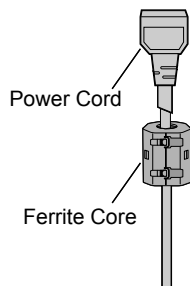

2 small ferrite cores

When connecting a cable to the external speaker output terminal, attach a ferrite core to the cable near the terminal.

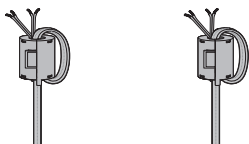

- To prevent the plasma display's internal components from overheating, make sure that the plasma display is installed in a well-ventilated location.
 - Be sure to use the optional stand, wall-mounting unit or the other mounting unit when installing the plasma display. Also, be sure that your dealer performs the installation.
 - See the appropriate instruction manual for additional information on the mounting hardware you select.
 - To prevent an accident and ensure safety in the event of an earthquake, fix the plasma display securely into the position as described below.
 - Use the diagram below to determine how much space is needed to ensure proper heat radiation. This is a minimum space requirement; therefore, provide at least as much space as indicated below.
- * Make sure that the plasma display is installed in a location where the temperature can be maintained between 0°C and 40°C (between 32°F and 104°F).
- * Never attempt to tilt the plasma display sideways or backward.
- * To prevent the power cord and other cables from being accidentally pulled, make sure that they run along the wall or through corners.
- * To prevent accidents and ensure safety in the event of an earthquake, secure the plasma display to prevent it from tipping over.

Display Section

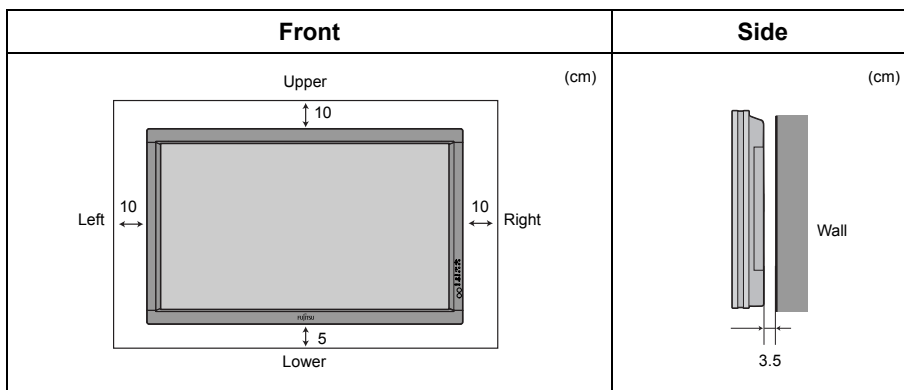

Note

- See P. E-30 for details on the options.
- The external view is meant to be a representation of the actual unit and is not to scale; therefore, it may differ from the actual shape and size of the product.
- Due to the fragile and highly precise equipment, it is very important to pack properly before transportation using only the packing materials provided.

PART NAMES AND FUNCTIONS

DISPLAY SECTION – FRONT

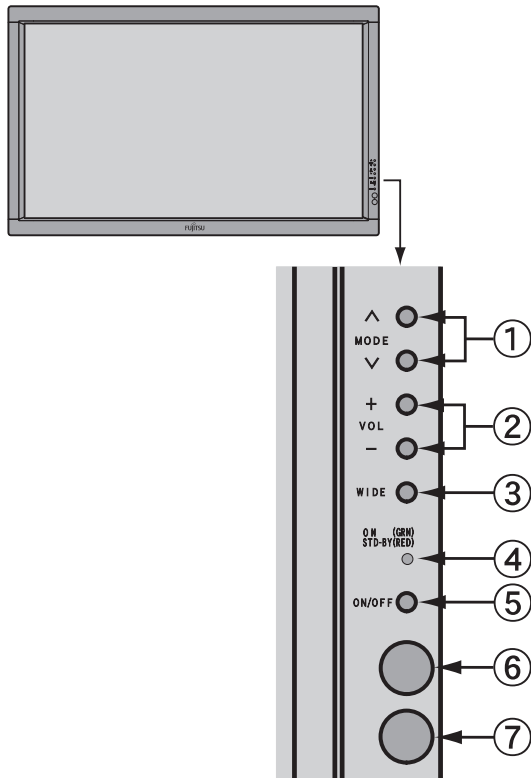

- ① **Input mode selection button**
Switches the input modes (Video mode, RGB mode and TV mode).
- ② **Volume button**
Adjusts the sound volume.
- ③ **Wide screen selection button**
Switches the screen over to a desired wide screen.
- ④ **Power indicator lamp**
This lamp shows the state of the power supply.
Lit (red): Stand-by state
Lit (green): Power ON state
Flashing (red or green): Malfunction (Flashes differently depending on the type of malfunction.)
- ⑤ **ON/OFF button**
Turns the power "ON" and "OFF (standby state)".
- ⑥ **Remote control signal receiver**
Receives the signals from the remote control.
- ⑦ **Ambient Sensor**
Detects the brightness of ambient light.
It is important not to obstruct it for full functionality of the feature.

DISPLAY SECTION – BACK

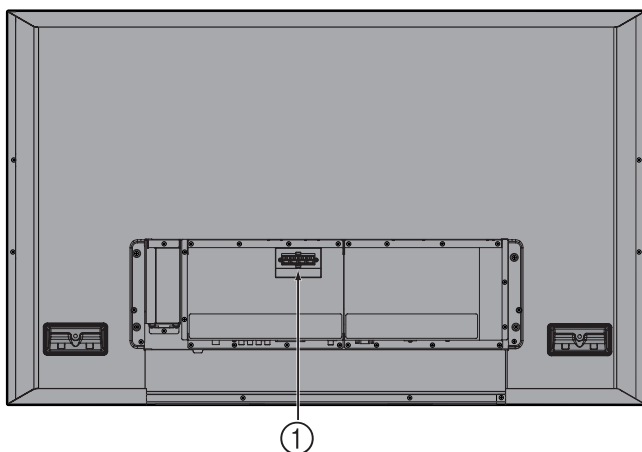

- ① **External speaker output terminal (EXT SP)**
Connect this terminal to the optionally available speaker.
When connecting a cable, attach a ferrite core to the cable.
(See P. E-4.)
*See the speaker instruction manual for more information.

Warning

If the power indicator lamp flashes red or green, this signifies that the display has developed a problem. When this happens, be sure to remove the power plug from the receptacle and contact your dealer. Leaving the display power ON can result in fire or electric shock.

DISPLAY SECTION – BOTTOM

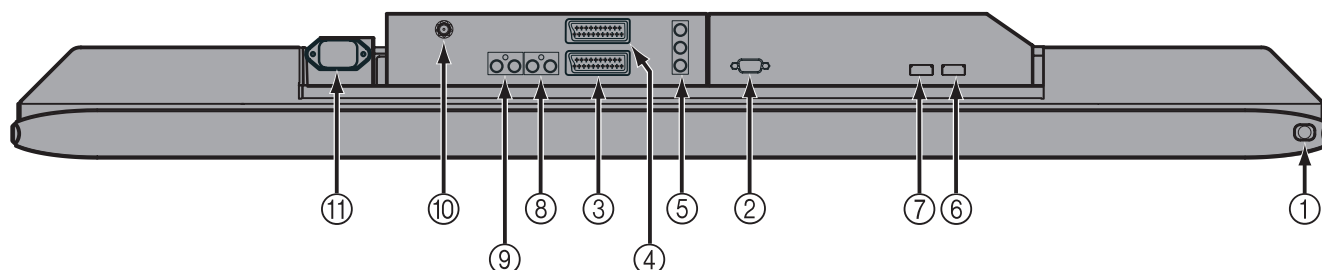

① power switch

If this button is pressed when the power indicator lamp is off, the indicator lamp will light.

The power can be turned on and the standby mode selected by using the remote control or the control panel of the display.

If this button is pressed when the power indicator lamp is lit, the indicator lamp will go out.

*Power is still supplied to parts of the display even if the indicator lamp is off.

② RGB1 input terminal (RGB1 INPUTmD-sub)

Connect this terminal to the output terminal of a PC, set-top box, game, etc.

③ SCART input terminal (VIDEO1 INPUT)

④ SCART input terminal (VIDEO2 INPUT)

Connect this terminal to the SCART terminal of your VCR or DVD, etc. (See “SETTING THE INPUT TERMINALS” on P. E-25)

⑤ Component Video input terminal (VIDEO3 INPUT)

Connect this terminal to the Component Video Output terminal of DVD recorder/player or satellite receiver.

⑥ VIDEO4 input terminal (VIDEO4 INPUT/HDMI)

⑦ VIDEO5 input terminal (VIDEO5 INPUT/HDMI)

Connect this terminal to the HDMI output terminal of DVD recorder/player or other video source.

⑧ Audio4 input terminal (AUDIO4 INPUT)

⑨ Audio3 input terminal (AUDIO3 INPUT)

Connect this terminal to the audio output terminal of your VCR, etc. (See “Audio Input” on P. E-27)

⑩ Antenna input terminal

Please connect it to the antenna signal.

⑪ Power input terminal

Connect this terminal to the power cord supplied with the plasma display.

When connecting a cable, attach a ferrite core to the cable. (See P. E-4.)

•The table below shows the settings of Audio inputs. (Factory setting)

* For changing of Audio input settings, see “Audio Input” on P. E-27.

Video input	Audio Input
RGB1 (mD-sub)	Audio3
Video1 (Scart)	Audio1 (Scart)
Video2 (Scart)	Audio2 (Scart)
Video3 (Component Video)	Audio4
Video4 (HDMI)	Audio5 (HDMI)
Video5 (HDMI)	Audio6 (HDMI)







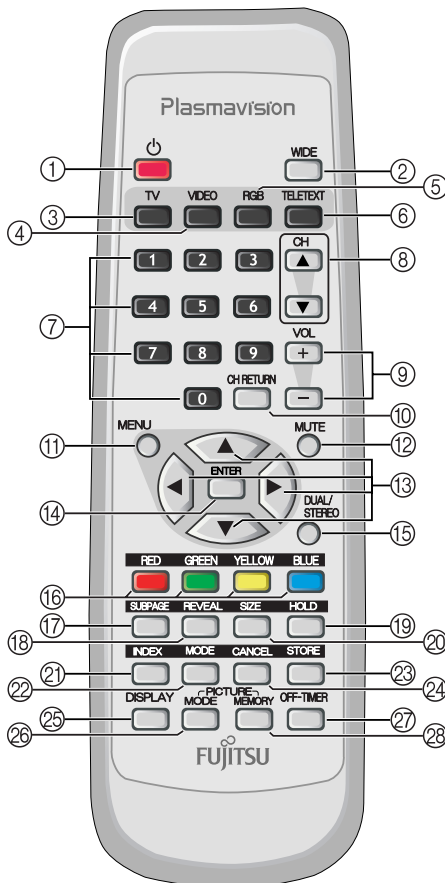





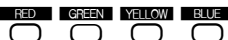



PART NAMES AND FUNCTIONS (Continued)

REMOTE CONTROL

For details, see page →.



- ① (POWER button) → E-12
Switches between Power On and Standby.
- ② (WIDE button) → E-16
Press to switch the screen size.
- ③ (TV input mode selector button) → E-13
Press to watch terrestrial broadcastings.
- ④ (Video input mode selector button) → E-14
Press to switch through VIDEO1 to VIDEO5.
- ⑤ (RGB input mode selector button) → E-15
Press to switch through RGB1.
- ⑥ (TELETEXT input mode selector button) → E-14
Press to switch to the teletext broadcastings (selectable only when watching the TV).
- ⑦ (Number buttons) → E-13
Use these buttons for the Program No. selection directly.
In the teletext broadcastings, input the 3 digits for the required teletext page to change the page.
- ⑧ (Channel Up/Down buttons) → E-13
Press to select the preset programs.
Use these buttons to scroll through a page in the teletext broadcasting.
- ⑨ (Volume adjustment buttons) → E-12
Press to adjust the volume.
- ⑩ (Channel Return button) → E-13
Returns to the previous Program No. and input mode immediately.
- ⑪ (MENU button) → E-18–E-29
Press to display or hide the menu screen.
Use for picture or audio adjustment.
- ⑫ (MUTE button) → E-12
Press to temporarily mute the audio.
To return the audio to normal, press this button once again, or press the does the work also.
- ⑬ (Adjustment buttons) → E-18–E-29
Press to select the item or adjust the value in the Menu screen.
Press to scroll through the pages and switch among the LIST pages in the teletext broadcasting. (Only are used when switching LIST pages.)

- 14  **(ENTER button) → E-18–E-29**
Press to fix the entry in the ADJUSTMENT MENU.
- 15  **(DUAL/STEREO button) → E-15**
Press to select the audio mode for stereo/dual-channel audio broadcasting.
- 16  **(COLOR button) → E-14**
In the teletext broadcasting, press these buttons to switch through the pages stored to each of the four colors in the LIST mode. Other than the LIST mode, these buttons can also be used for the colored option selected from the four teletext new options displayed at the bottom of the screen.
- 17  **(SUBPAGE button)**
Press to display the SUBPAGE.
- 18  **(REVEAL button)**
Press to display hidden text (such as the answers to quizzes, etc).
- 19  **(HOLD button)**
Press to hold the transmission of the teletext program you are currently watching.
- 20  **(SIZE button)**
Press to change the size of the current watching page.
- 21  **(INDEX button)**
Press to return to the INDEX page.
- 22  **(MODE button) → E-14**
Switches to the LIST mode. Press this button once again to return to the current mode.
- 23  **(STORE button) → E-14**
In LIST mode, saves the current display to the Favorites page.
- 24  **(CANCEL button)**
Press to watch the CANCEL page.
Press it once again to return to the teletext broadcasting you were watching before you pressed .
- 25  **(DISPLAY button) → E-15**
Press to display the Program No., input mode, and screen size status. The status is displayed for about five seconds.
- 26  **(PICTURE MODE button) → E-15**
Press to switch the Picture Mode.
- 27  **(OFF-TIMER button) → E-15**
Press to specify the length of time until the power turns off(stand-by state) after the button is pressed.
- 28  **(PICTURE MEMORY button) → E-15**
Press to access the Picture Memory.

Note

- Functions may not be available with some models and some device options.

USING THE REMOTE CONTROL

PUTTING BATTERIES IN THE REMOTE CONTROL



(1) To remove the cover, slide it outwards while pressing it down.

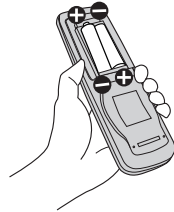

(2) Place two AA batteries in the remote control. Make sure that the batteries are properly oriented.



(3) Close the cover until it snaps into place.

PRECAUTIONS

To prevent malfunction, do not apply any form of severe shock to the remote control. To prevent malfunction or deformation, do not allow the remote control to become wet and keep it away from hot surfaces or heating equipment. Do not clean the remote control using a cloth dampened in a volatile solvent, such as benzene or thinner.

EFFECTIVE RANGE FOR THE REMOTE CONTROL

When using the remote control, be sure to point it directly at the plasma display's signal receiver. Make sure that there are no obstacles between the remote control and the plasma display's signal receiver.

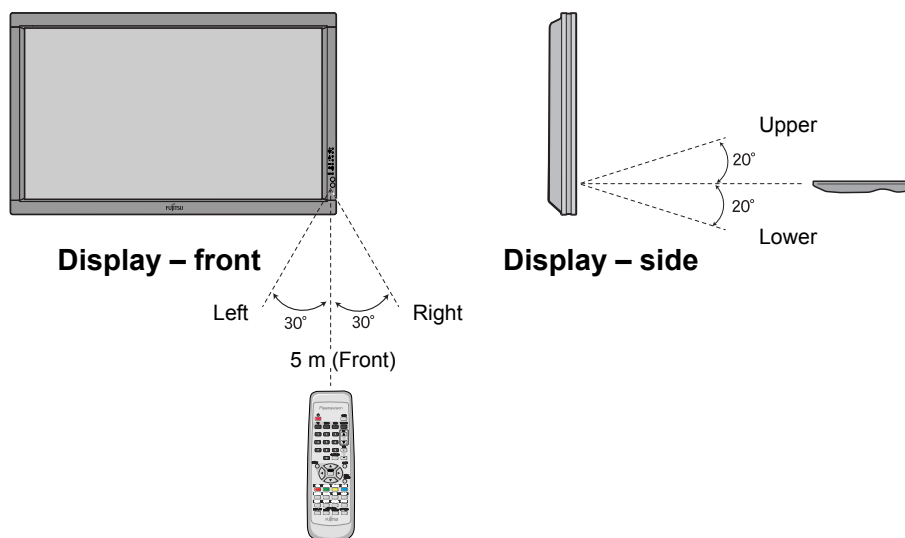

CAUTION

It is very important to use replacement batteries of the same type as the originally used. Do not use rechargeable batteries (Ni-Cd, etc.). When disposing of used batteries, please comply with governmental regulations or environmental public institution's rules that apply in your country/area.

Note

- The remote control will not function properly if the batteries are dead. Be sure to replace them as needed.
- The remote control may not function properly if a high-frequency fluorescent lamp or the like is used. In this case, move the lamp or use the remote control from a different position.

DVD RECORDER/PLAYER, SATELLITE TUNER

- Connects to the antenna input terminal on the display bottom.
- Connect the video signal cable to the component video input terminal, HDMI input terminal, S-video input terminal, or the video input terminal.
- If the component to be connected is equipped with HDMI output terminal or the component video output terminal, connection to either of these terminals is recommended. (If the HDMI output is connected, an Audio signal cable does not need to be connected.)

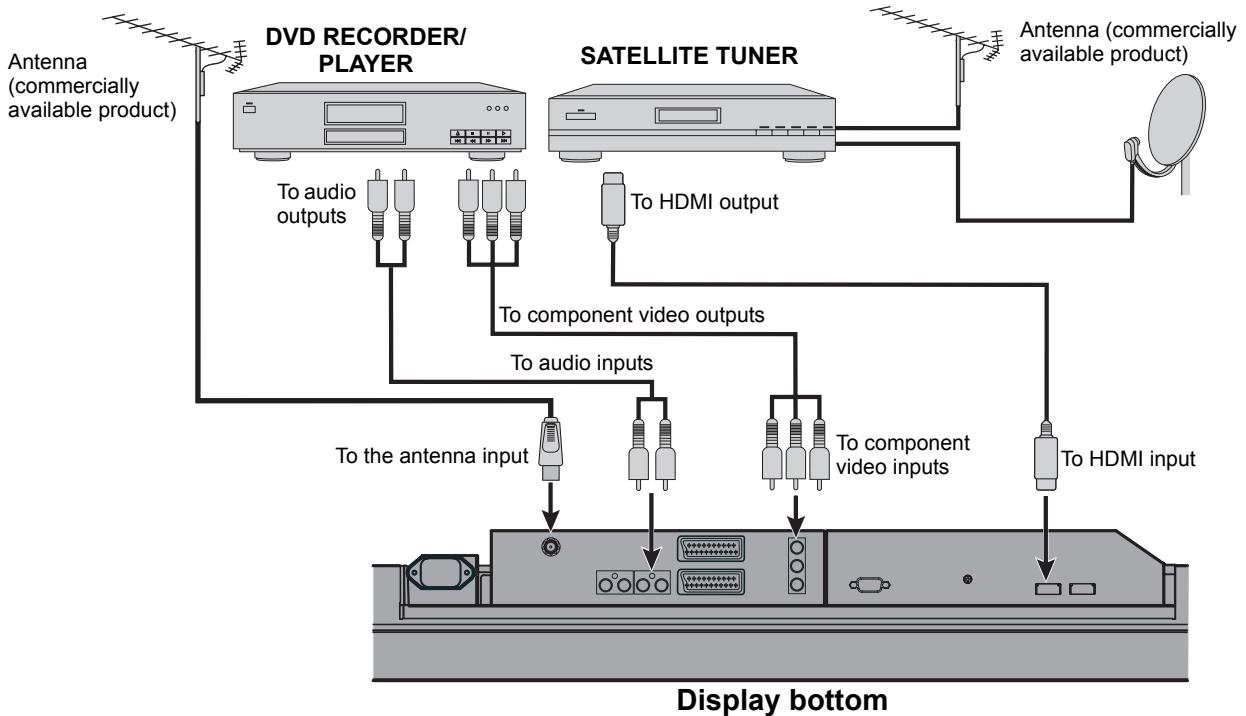

VCR/PC

- Connect the video signal cable to the SCART input terminal.
- As the cable for connecting a PC differs with the PC model, please consult your dealer for information on the right cable to purchase.

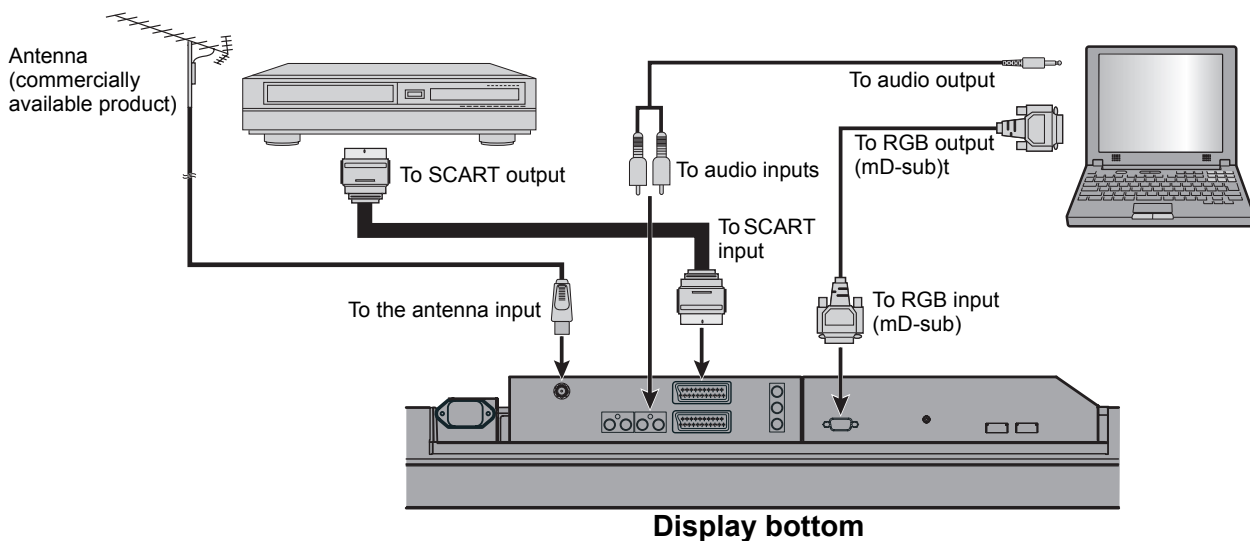

Note

- Please enquire with your local teletext broadcasting company if you want to receive teletext broadcasts.
- Unplug the power cord from the AC outlet before you connect external components.
- Also refer to the instructions for the component to be connected.
- When inputting audio, connect to the terminals corresponding to the used video input or RGB input.



BASIC OPERATIONS

TURNING THE POWER ON AND STAND-BY



- 1 Press OFF/ON  to the left at the bottom of the display to the STD-BY state.**

The power lamp lights up.
- 2 Press  on the remote control.**

The color of the power lamp changes from “Red” to “Green”.
- 3 Press , the button of the channel you want to watch, and then press  or .**

Select TV or the picture mode to input.
- 4 Press  when the power is ON.**

The color of the power lamp changes from “Green” to “Red” and the display goes into standby state.

* You can also use the buttons on the display's control panel to perform these steps.

ADJUSTING THE VOLUME



Adjusting the volume

Press  to increase the volume.

Press  to reduce the volume.

* Note that the volume level remains stored even when you turn OFF the power.

Muting the audio

Press .

The audio is removed.

Press again to restore the audio to the original level.

The mute mode can also be released by pressing the volume buttons.

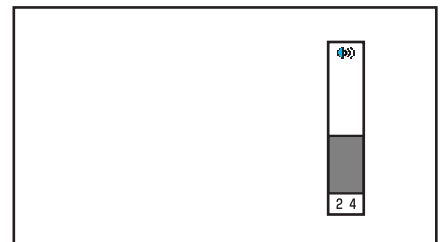

When the volume adjustment button is pressed

* You can also use the buttons on the display's control panel to perform these steps.

Note

- Functions may not be available with some models and some device options.

WATCHING A TV BROADCASTING



* You can also use the buttons on the display's control panel to perform these steps.

1 Select the country.
Select the country using the Auto Store function in the CHANNEL SETTING menu (see page E-26).

This enable the terrestrial broadcastings to be watched for selected country.

2 Press .

Available to watch the terrestrial broadcastings.

The last Program No. that you watched is received.

3 Select the Program No.

Press  - .

The program changes to the selected Program No.

Select your desired Program No. (0 to 99).

• Even if you press  - , the Program No. can be changed as shown below. (Available in TV mode)

 : → 0 → 1 → 2 → 3 • • • 97 → 98 → 99 →

 : → 99 → 98 → 97 • • • 3 → 2 → 1 → 0 →

* The program numbers set to skip over are not shown on the display. See page E-26 for details.

CH. Return

Press .

The program returns to the previous program, or Video mode or RGB mode that you watched.

* See pages E-26 for details on the channel setting.

BASIC OPERATIONS (Continued)

WATCHING A TELETEXT BROADCASTINGS



1 Display the TV program.

Press **TV** to set to TV mode.

2 Press **TELETEXT**.

This enables teletext broadcasts to be viewed. (superimposed over the TV program)

The teletext broadcasting INDEX screen is received.

* Whenever **TELETEXT** is pressed, the screen switches between teletext screen superimposed over the TV program and teletext-only screen.

• Displays the teletext page program.

The teletext page program is displayed when 3 digit number by **0** – **9** and

RED **GREEN** **YELLOW** **BLUE** **◀** **▶** **◀▶** **▶◀** is pressed.

• Storing and displaying favorite teletext programs.

1) Press **MODE** to select the LIST mode.

2) Press **RED** **GREEN** **YELLOW** or **BLUE** to select the color button for storing the teletext page program.

3) Press **STORE** for three seconds at least to store the displaying teletext program to the color button. (During the storing operation, the color button momentarily turns white.)

4) In the LIST mode, press **RED** **GREEN** **YELLOW** or **BLUE** to display the stored teletext page program.

* Press **TV**, **VIDEO**, or **RGB** to return to the other modes.

* See pages E-8 to E-9 for information on the other keys.

* There is no **MENU** **WIDE** **DISPLAY** **CH RETURN** **PICTURE MODE** **PICTURE MEMORY** **DUAL/STEREO** **OFF-TIMER** function in the teletext broadcasting screen.

* If you have trouble at the receiving of the teletext broadcastings, consult with your local dealer or the teletext broadcasting.

VIDEO INPUT MODE



1 Press the **VIDEO** to select the input mode.

You can select from VIDEO1 mode to VIDEO5 mode.

The video modes corresponding to each input terminal are as follows.

- VIDEO1: SCART
- VIDEO2: SCART
- VIDEO3: Component video
- VIDEO4: HDMI
- VIDEO5: HDMI

* For selection of the input terminal, see “SETTING THE INPUT TERMINALS” on P. E-25.

* You can also change VIDEO mode by pressing **1** – **5** during “Video” indication on the screen by pressing **VIDEO**.



Video1 mode

RGB INPUT MODE



1 Press to select the input mode.

The input terminal of RGB mode is as follows.

- RGB1: mD-sub

* For selection of the input terminal, see “SETTING THE INPUT TERMINALS” on P. E-25.



RGB1 mode

CONVENIENT FUNCTIONS



DISPLAY

Displaying on-screen information.

Press  .

The channel or mode is indicated on the screen for 5 seconds.

PICTURE MODE

Press  .

This button can be used to switch the picture mode.

In the picture mode, you can switch between the set status and the fine mode.

* For the picture mode settings, see “Picture Mode (P. E-20)”.

PICTURE MEMORY

Press  .

This button can be used to recall the settings of the picture memories 1 – 8. Each time this button is pressed, the setting changes as follows.

→ Memory1 → Memory2 → Memory3 → Memory4 → Memory5 → Memory6 → Memory7 → Memory8 →

* For the picture memory settings, see “Picture Memory (P. E-21)”.

DUAL CHANNEL

Press  .

This function enables selection of the audio mode when there is a dual-channel broadcast. Each time this button is pressed, the mode is switched as shown in the figure below.

→ Dual-I → Dual-II → Stereo → Mono →

Depending on the broadcast, this function may not be available.

OFF-TIMER

Press  .

This can be used to set the time before the power is turned off (Stand-by state). Each time this button is pressed, the setting changes as follows.

→ Off → 30 min. → 60 min. → 90 min. → 120 min. →

Note

- Functions may not be available with some models and some device options.

WATCHING PICTURES ON THE WIDE SCREEN

SWITCHING BETWEEN SCREEN SIZES



* You can also use the buttons on the display's control panel to perform these steps.

1 Press **WIDE**.
The currently selected mode will appear.

2 Press **WIDE** to select a desired Screen Size.

Each time you press **WIDE**, a different Screen Size appears. The sequences used are as follows:

When you are in a Video input mode

→ **Normal** → **Wide1** → **Wide2** → **Zoom1** → **Zoom2** →

When you are in an RGB input mode

→ **Normal** → **Wide** → **Zoom** →

* Depending on the type of signal, some aspects may not be selected.

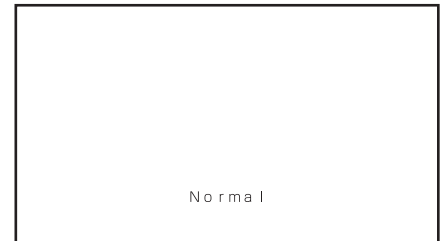

Normal mode



Wide1 mode

Note

- When the WIDE mode is set to "Normal", and pictures are shown for an extended time, a residual image or "burn-in" may be created. The burn-in may occur at the boundary where the left and right borders of the picture meet the vertical bars. To reduce the chance of "burn-in" when watching in the "Normal", we recommend you set the "Background" to "Light Gray". (See P. E-28)
- When a residual image was created, it is reduced by using the "White Screen" settings. Note that there may also be cases when it can not be recovered completely. (See P. E-28)
- A variety of Screen Sizes are available with this display. Remember that if you select a mode with an aspect ratio (ratio of frame width to frame height) different from that of the TV program or video media, the pictures will appear differently than if you had selected a mode having the same aspect ratio.
- Showing a movie or similar premium event at a different aspect ratio from its original one at any event site, restaurant, or bar for profit-making purposes or for a public audience may constitute a copyright infringement.
For films, try to select a mode having the same aspect ratio as the original picture; this enables the director's original intentions to be preserved.
- See P. E-22 for how to adjust the picture size and position.

SCREEN SIZE

Normal (Video/RGB)

Displays pictures of normal size (i.e., a 4:3 aspect ratio).

Wide1 (Video)

Displays natural-looking pictures of standard size on the wide screen.

Wide2 (Video)/Wide (RGB)

Ideal for displaying vertically extended pictures such as squeezed pictures.

Zoom1 (Video)/Zoom (RGB)

Enlarges horizontally extended pictures equally in all directions to maintain the aspect ratio constant.

Zoom2 (Video)

Reduces the height of horizontally extended pictures with captions, without eliminating the caption. Only the height of pictures is reduced, not the height of the caption.

(Captions may not be easy to read, however, depending on the picture.)

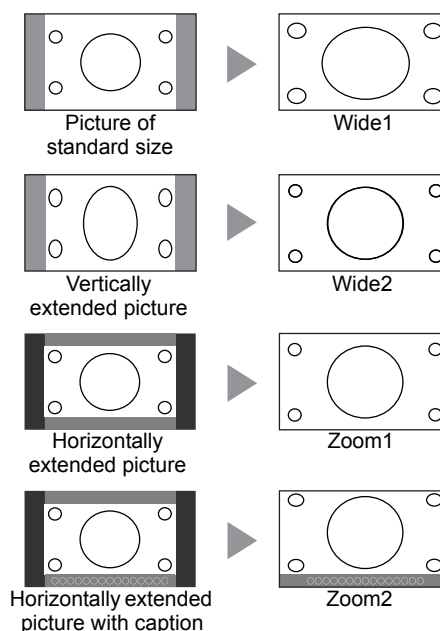

ASPECT RATIO

The following aspect ratios are available.

4:3 aspect ratio
(VHF/UHF broadcasting, BS broadcasting)

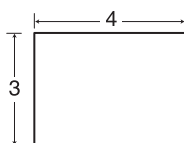

16:9 aspect ratio
(HDTV broadcasting)

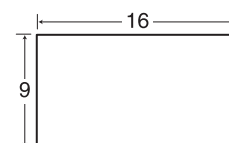

1.85:1 aspect ratio
(Vista Vision size)

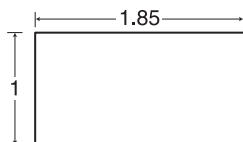

2.35:1 aspect ratio
(Cinema Scope size)

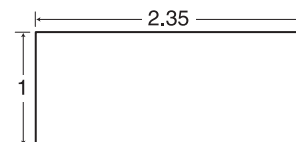

Note

You may find dark areas on top and at the bottom of the screen if you select one of the Zoom modes for media while using the Vista Vision or Cinema Scope size i.e., the sizes used frequently for picture software.

- Functions may not be available with some models and some device options.

ADJUSTMENT MENU

The numbers in parentheses () indicate the reference page numbers.

MENU	PICTURE (E-19)	Signal Contrast (E-20)	
		Drive Contrast (E-20)	
		Brightness (E-20)	
		Color (E-20)	
		Tint (E-20)	
		Sharpness (E-20)	
		Ambient Sensor (E-20)	
		Picture Mode (E-20)	
		Color Temp. (E-21)	
		Picture Memory (E-21)	
	Default		
POSITION/SIZE (E-22)	Position (E-22)		
	Size (E-22)		
	Default		
AUDIO (E-23)	Treble (E-23)		
	Bass (E-23)		
	Balance (E-23)		
	Loudness (E-23)		
FEATURES (E-24))	Adjustment (E-24)	Dot Clock (E-24)	
		Clock Phase (E-24)	
		Clamp Position (E-24)	
		Auto Calibration (E-24)	
	On Screen Menu (E-24)	OSD (E-24)	
		Language (E-24)	
		Name Select (E-25)	
	Input Terminal (E-25)	Video1 (E-25)	
		Video2 (E-25)	
		D-SUB Input (E-25)	
	Channel Setting (E-26)	Auto Store (E-26)	
		Manual Store (E-26)	Setting (E-26)
			Name (E-26)
		Sort (E-26)	
	Others (E-27)	Auto Off-NO SIG. (E-27)	
		Audio Input (E-27)	
		Screen Orbiter (E-27)	
		Direct Setting (E-28)	
		Code Setting (E-28)	
		White Screen (E-28)	
		Background (E-28)	
		Information (E-28)	
	FACTORY DEFAULT (E-29)		

Note

- Some type of signal can not be selected.

BASIC PROCEDURE OF ADJUSTMENT MENU OPERATIONS

- Below is shown the basic procedure to make changes to the options in the ADJUSTMENT MENU. (Ex.: adjusting tint setting (Tint))



1 Press .
The main menu screen will appear.

2 Press or to select "PICTURE".
Each time you press or , one of the available menus appears in the following sequence:

**PICTURE ↔ POSITION/SIZE ↔ AUDIO ↔ FEATURES
↔ FACTORY DEFAULT**

The PICTURE Menu screen will appear.

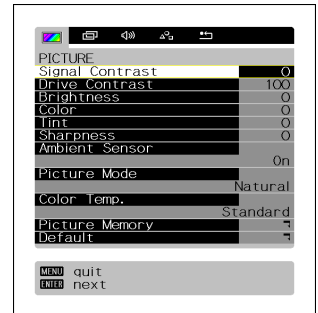

"PICTURE" selected in the main menu screen

3 Press or to select "Tint".

4 Press .
The "Tint" adjustment screen will appear.

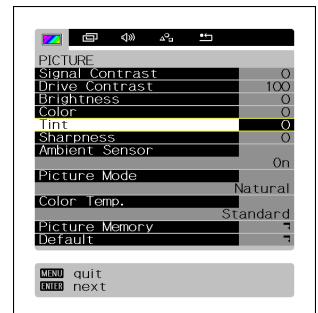

"Tint" selected in the PICTURE Menu screen

5 Press or to change tint values.

: More greenish colors

: More purplish colors

6 Press to store.

7 Press when you finish.

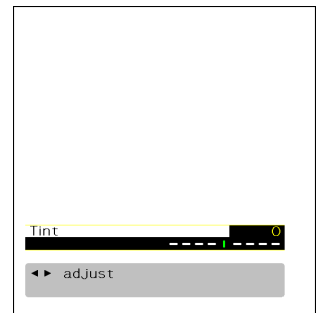

"Tint" adjustment screen

* Repeat steps 3, 4, 5 and 6 when you wish to make changes to other options.

* When is pressed after you have selected "Default", the settings are returned to those that were valid when you purchased the set.

* Press to halt the operation in progress.

Note

- On-screen information disappears if you do not take any action for about 60 seconds.
- Functions may not be available with some models and some device options.
- The adjustment range varies with the display signal. You can adjust the display quality to the value you want within the adjustable range.

ADJUSTING THE PICTURE

- Picture-related items can be set and adjusted in the Picture Adjustment Screen. See BASIC PROCEDURE OF ADJUSTMENT MENU OPERATIONS on page E-19 for the basic operation procedures.

Signal Contrast

Press  to increase the input signal contrast.

Press  to reduce the input signal contrast.

Press  to store.

Drive Contrast

Press  to raise the display's luminance level, and increase the contrast.

Press  to lower the display's luminance level, and reduce the contrast.

Press  to store.

*If Ambient Sensor is ON, the change made by this adjustment may be difficult to be recognized in too bright or dark a place.

Brightness

Press  to increase the brightness.

Press  to reduce the brightness.

Press  to store.

Color

Press  to darken the color.

Press  to lighten the color.

Press  to store.

Tint

Press  to change the tint to a more greenish color.

Press  to change the tint to a more purplish color.

Press  to store.

Sharpness



Press  to sharpen the Sharpness.

Press  to soften the Sharpness.

Press  to store.

Ambient Sensor



Automatically adjusts the Sharpness to an optimized level that matches the brightness of the surrounding area.

Each time  or  is pressed, the setting is switched.

↔ On ↔ Off ↔

Press  to store.

Picture Mode

Each time you press  or , the available choices appear in the following sequence.



↔ Natural ↔ Fine ↔ Effective ↔ Conventional ↔ Still ↔

Natural	Enables you to watch pictures with natural color tones and high picture clarity. This mode is suitable for watching movies or TV.
Fine	Best for watching movies in darkened rooms.
Effective	Best for watching TV in bright environments.
Conventional	Displays a screen approximating that of a conventional TV screen.
Still	Suitable for watching static images such as computer or still camera images.

Press  to store.

Color Temp.

“Color Temperature” can be set.

Each time  or  is pressed, the color temperature mode is switched as shown below.

↔ **Warm** ↔ **Standard** ↔ **Cool** ↔

[Warm]: More reddish colors

[Cool]: More bluish colors



Press  to store.

Picture Memory

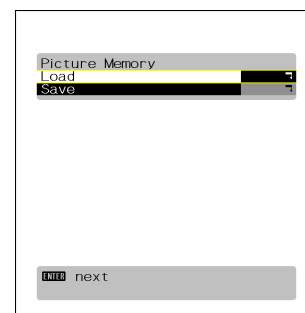
The adjustment status of eight groups of picture adjustment settings can be stored, enabling you to quickly switch to your desired group of settings for the picture you are planning to watch.



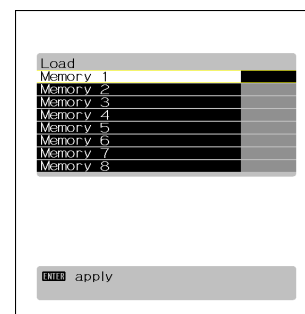

Picture Memory Selection Screen

[Load]: Use  or  to select Memory 1 - 8. When  is pressed, the values becomes the picture adjustment values stored in the selected Memory.



“Load” Selection Screen

[Save]: Use  or  to select Memory 1 - 8. If  is pressed, the current picture adjustment values are stored to the selected Memory.

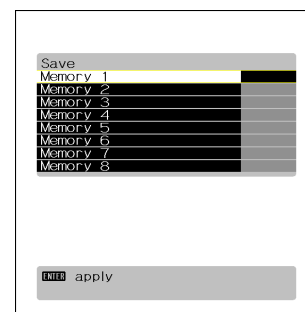

“Save” Selection Screen

Note

- The screen display disappears if there is no operation within approximately 60 seconds.
- Depending on the model or the optional devices, some of the functions may not be available.
- The adjustment range varies according to the display signals. Make adjustments to your preferred picture quality within the adjustment range.
- Depending on the type of signal, it may not be possible to make some of the settings or adjustments.

ADJUSTING SCREEN POSITION AND SIZE

- You can make changes to all screen adjustment options in the POSITION/SIZE Menu. See Page E-19 for the basic operation procedures.
- The changes you make will be stored for the selected input mode. Therefore, you need to select a desired input mode before making any changes.

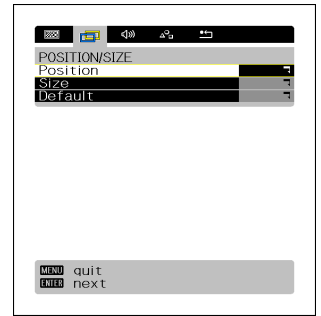

POSITION/SIZE Menu screen

Screen Position

Horizontal position (Horizontal)

⬆️: Moves screen to the right.



⬆️: Moves screen to the left.

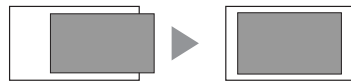

Vertical position (Vertical)

⬆️: Moves screen up.



⬆️: Moves screen down.



Press **ENTER** to store.

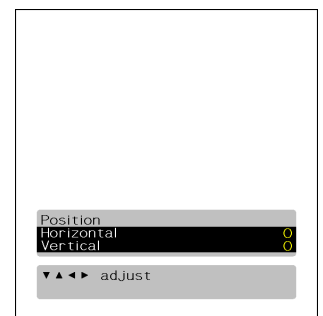

"Position" adjustment screen

Screen Size

Screen width (Width)

⬆️: Increases width.



⬆️: Reduces width.



Screen height (Height)

⬆️: Increases height.



⬆️: Reduces height.



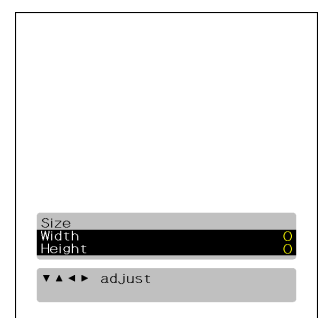

Press **ENTER** to store.





"Size" adjustment screen

- You can make changes to all audio adjustment options in the AUDIO Menu. See Page E-19 for the basic operation procedures.
- The changes you make will be stored for the selected input mode. Therefore, you need to select a desired input mode before making any changes.
- When the optional speaker is not installed, sound is not output.

Treble



Press   to make adjustments.

: Stronger treble

: Weaker treble

Press  to store.

Bass



Press   to make adjustments.

: Stronger bass

: Weaker bass

Press  to store.

Balance

Press   to make adjustments.



: Shifts the volume balance towards the right.

: Shifts the volume balance towards the left.

Press  to store.

Loudness

Corrects the balance between bass and treble for easy listening even with weak volume.

Each time you press  or , one of the available choices appears in the following sequence:

↔ **On** ↔ **Off** ↔

Press  to store.

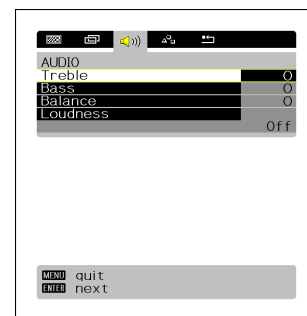

AUDIO Menu screen

Note

- The screen display disappears if there is no operation within approximately 60 seconds.
- Depending on the model or the optional devices, some of the functions may not be available.
- The adjustment range varies according to the display signals. Make adjustments to your preferred picture quality within the adjustment range.
- Depending on the type of signal, it may not be possible to make some of the settings or adjustments.
- AUDIO menu will not be displayed when “No Audio” is selected. (See P. E-27.)

OTHER ADJUSTMENTS

FEATURES setup screen has the following 5 options.

See Page E-19 for the basic operation procedures.

[Adjustment]: Can make a fine adjustment of pictures such as Dot Clock, Clamp Position.

[On Screen Menu]: Can make a display setting such as OSD, Language. (See P. E-24.)

[Input Terminal]: Can make an input terminal setting such as Video Input. (See P. E-25.)











[Channel Setting]: Can make channel settings. (See P. E-26.)

[Others]: Used to make Screen Orbiter and other settings. (See P. E-27–E-28.)

ADJUSTMENT

Dot Clock, Clock Phase, Clamp Position, and Auto Calibration are adjusted as shown in the following chart.



Select the item with  , and then adjust with  . Finally, press  to implement the adjustments.

Adjustment Item	Contents of Adjustments	Operation
Dot Clock (mD-Sub)	You may find the vertically-striped pattern in pictures, depending on the clock frequency of your PC's processor. If you experience blurring, you can obtain a clearer picture by adjusting the "Dot Clock".	Use   to adjust to minimize vertically-striped pattern in pictures.
Clock Phase (mD-Sub)	Pictures and the outline of letters may blur or flicker as the clock phase of your PC may be different. In this case, adjust the clock phase manually. Normally, the automatic setting ensures the optimal value.	When "Manual" is selected, use   to adjust to minimize pictures blur.
Clamp Position (mD-Sub, Comp. video)	Adjusts the extremely dark or bright pictures. Normally, the automatic setting ensures the optimal value.	Use   to adjust pictures optimally.
Auto Calibration (mD-Sub)	Adjusts the dynamic range of images to the optimum. Performed while a white screen signal is received.	Display the Auto Calibration screen. Select "Execute" and press  . Press  or  to select "Yes", and press  .

ON SCREEN MENU

On-screen display Information (OSD)

You can use this option to select whether to display information.

Each time you press  or , one of the available choices appears in the following sequence:

↔ On (OSD:bright) ↔ On (OSD:dark) ↔

[On (OSD:bright)]: On-screen information shown in light color.

[On (OSD:dark)]: On-screen information shown in dark color.

Press  to store.

* If the screen picture is too bright, some characters may be difficult to watch when [On (OSD:dark)] is selected.

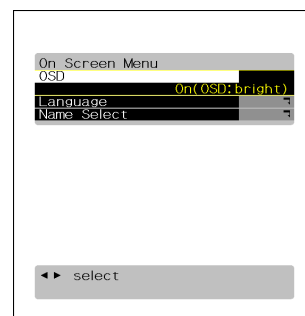



OSD selection screen

Language (Language)

You can use this option to select the language displayed on the screen.

(1) Select "Language" and press .

The "Language" selection screen will appear.

(2) Press  or  to select your desired language.

English
 Deutsch (German)
 Español (Spanish)
 Français (French)
 Italiano (Italian)
 Nederlands (Dutch)
 Русский (Russian)

(3) Press .

The menu is displayed in the selected language.

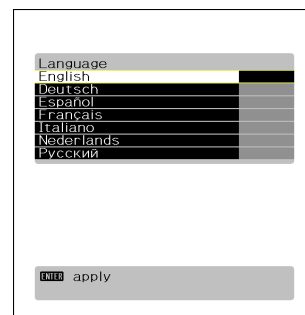

"Language" selection screen

Name Selection (Name Select)

You can change the settings for indications for video inputs and RGB inputs.

Video input

You can change the settings for indications for the VIDEO inputs.

Select the desired indication in accordance with the connected equipment.

Each time \leftarrow \rightarrow is pressed, the setting is switched. (In the case of VIDEO1)

\leftrightarrow **Video1** \leftrightarrow **DVD1** \leftrightarrow **DVD2** \leftrightarrow **VCR1** \leftrightarrow **VCR2** \leftrightarrow **GAME** \leftrightarrow **Camcorder** \leftrightarrow **STB** \leftrightarrow **Satellite** \leftrightarrow **Cable TV** \leftrightarrow

Press ENTER to store.

RGB input

You can change the settings for indications for the RGB inputs.

Select the desired indication in accordance with the connected equipment.

Each time \leftarrow \rightarrow is pressed, the setting is switched. (In the case of RGB 1)

\leftrightarrow **RGB1** \leftrightarrow **PC1** \leftrightarrow **PC2** \leftrightarrow **DVD1** \leftrightarrow **DVD2** \leftrightarrow **STB** \leftrightarrow **Satellite** \leftrightarrow **Cable TV** \leftrightarrow

Press ENTER to store.

SETTING THE INPUT TERMINALS

Video1 or Video2 Input terminal

Function

Select the video input format.

Each time \leftarrow \rightarrow is pressed, the setting is switched.

\leftrightarrow **Auto** \leftrightarrow **Video** \leftrightarrow **S-video** \leftrightarrow **RGB** \leftrightarrow

Select the desired input.

[Auto]: Automatically selects Video and RGB.

Press ENTER to store.

Video Format

You can use this option to select the video format appropriate for the input signal.

Each time you press \leftarrow or \rightarrow , one of the available modes appears in the following sequence:

\leftrightarrow **Auto1** \leftrightarrow **Auto2** \leftrightarrow **NTSC** \leftrightarrow **PAL** \leftrightarrow **SECAM** \leftrightarrow **PAL60** \leftrightarrow **N-PAL** \leftrightarrow **M-PAL** \leftrightarrow **4.43NTSC** \leftrightarrow

[Auto1]: Automatically selects NTSC, PAL and SECAM.

[Auto2]: Automatically selects NTSC and M-PAL.

[Other than Auto]: You need to select a system appropriate to the input signal.

Press ENTER to store.

D-SUB Input terminal

You can use this option to select the signal system it will receive to D-SUB Input terminal.

(1) Select D-SUB Input and press ENTER .

D-SUB Input screen appears.

(2) Select the signal system to receive.

Each time you press \leftarrow or \rightarrow , one of the available choices appears in the following sequence:

\leftrightarrow **RGB-PC** \leftrightarrow **Decoder** \leftrightarrow

[RGB-PC]: For using RGB for PC

[Decoder]: For using digital broadcast tuner

(3) Press ENTER to store.

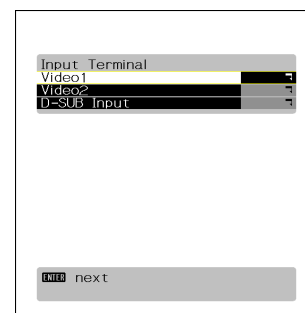

Input Terminal Settings Screen

OTHER ADJUSTMENTS (Continued)

CHANNEL SETTING

Press \leftarrow or \rightarrow to select the items for setting. It is switched as shown as below.

Auto Store ↔ Manual Store ↔ Sort

Press ENTER to proceed to the next step.

Auto Store

Press \leftarrow or \rightarrow to select the country or region, and then press ENTER .

All the channels are scanned, and only the channels that can be received are assigned to the Program Nos.

* Several minutes are required to scan all the channels. To cancel the operation in progress, press MENU .

* See page E-32 for the selectable TV frequencies.

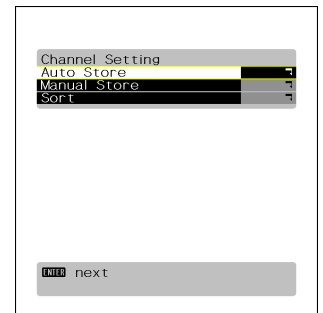

Channel Settings Screen

Manual Store

Press \leftarrow or \rightarrow to select the Program No. to be stored.

Press \leftarrow or \rightarrow to select the Manual Store items to be set (Setting or Name).

Press ENTER to proceed.

Setting

Press \leftarrow or \rightarrow to select the setting item.

Freq. ↔ System ↔ Adjust ↔ Skip

•Freq.

Each time \leftarrow or \rightarrow is pressed, the TV frequency is switched.

•System

Each time \leftarrow or \rightarrow is pressed, the TV SYSTEM is switched.

↔ West Euro (standard BG reception) ↔ East Euro (standard DK reception) ↔ UK (standard I reception) ↔ France (standard LL' reception) ↔

•Adjust

Each time \leftarrow or \rightarrow is pressed, the fine-tune adjustment for Tuning is switched.

•Skip

This function specifies whether or not to use the Skip function for the displayed Program No.

Each time \leftarrow or \rightarrow is pressed, the setting is switched.

↔ Off ↔ On ↔

[Off]: The Skip function is not available when Channel Up/Down has been selected.

[On]: The Skip function is available when Channel Up/Down has been selected.

Press ENTER to store.

* Select [On] when you want to skip the channels that they are not broadcasting programs.

Name

An eight-character name can be specified for each Program No.

Press \leftarrow or \rightarrow to select the character input position, and \leftarrow or \rightarrow to switch through the characters.

When the input is completed, press ENTER to store.

* When switching the programs, etc., the OSD becomes the indication by the stored name.

Sort

This function sorts the name, the data and the contents of stored programs.

Press \leftarrow or \rightarrow to select To (edit destination)/From (edit source), and \leftarrow or \rightarrow to switch the Program No.

Press ENTER to store.

Note

- The screen display disappears if there is no operation within approximately 60 seconds.
- Depending on the model or the optional devices, some of the functions may not be available.
- The adjustment range varies according to the display signals. Make adjustments to your preferred picture quality within the adjustment range.
- Depending on the type of signal, it may not be possible to make some of the settings or adjustments.

OTHER SETTINGS

Auto Off-NO SIG.

You can make to the standby state automatically when the no signal state continued during set up time.

Press to select the "Time".

Press to select the amount of time before the standby state starts.

↔ **Off** ↔ **1 min.** ↔ **15 min.** ↔ **45 min.** ↔ **60 min.** ↔

Press to store.

* The numerical value is the approximate amount of time before the standby state starts.

You can assign the black or white color for the background color at the no signal state.

Press to select the "Background".

Press to select the displayed background displayed.

↔ **Black** ↔ **White** ↔

Press to store.

* The background color changes to assigned color state after approximate 20 seconds at the no signal state.

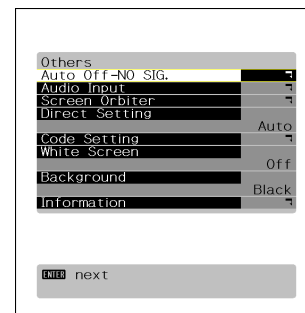

"Auto Off-NO SIG." selection screen

Audio Input

You can use this option to select the available terminals to receive the audio from input equipment.

(1) Select "Audio Input" and press .

The "Audio Input" setting screen will appear.

(2) Press or to select video input terminal.

(3) Select a related audio input terminal.

Each time you press or , one of the available choices appears in the following sequence:

↔ **No Audio** ↔ **Audio1** ↔ **Audio2** ↔ ↔

[No Audio]: No audio in the corresponding mode.

[Audio 1-4]: Selects Audio 1 through 4 for receiving audio in the corresponding mode.

[Audio 5-6]: HDMI

* There is also "Audio Input" that cannot be selected.

* Repeat steps (2) and (3) for each piece of input equipment.

(4) Press to store.

* AUDIO menu will not be displayed when "No Audio" is selected.

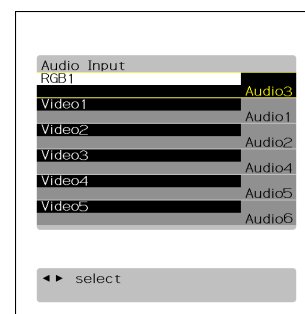

"Audio Input" setting screen

Screen Orbiter

for RGB

You can use this option to move the screen position to minimize phosphor-induced "burn-in".

Follow the steps below.

(1) Select "Screen Orbiter" and press .

The "Screen Orbiter" setting screen will appear.

(2) Press or to select "Mode/Time".

(3) Select a desired pattern.

Each time you press or , one of the available choices appears in the following sequence:

↔ **Off** ↔ **Time** ↔ **Mode** ↔

[Off]: Disables Screen Orbiter.

[Time]: Moves the pattern approximately every one hour.

[Mode]: Moves the pattern when the power is turned ON or when you switch between modes.

(4) Press or to select "Moving Area".

(5) Press or to select the range for moving the pattern.

Each time you press or , one of the available choices appears in the following sequence:

↔ **Min.** ↔ **Std.** ↔ **Max.** ↔

[Min.]: Pattern moves in small range. (About 5 pixels)

[Std.]: Pattern moves in moderate range. (About 10 pixels)

[Max.]: Pattern moves in wide range. (About 15 pixels)

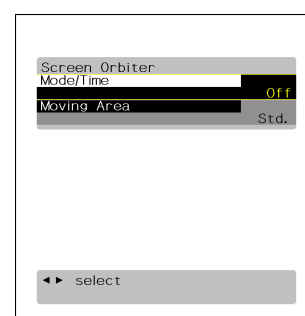

"Screen Orbiter" setting screen

OTHER ADJUSTMENTS (Continued)

(6) Press **ENTER** to store.

* When the Screen Orbiter function is operated, some letters at the top, bottom, right or left of the screen may be missed.

Direct Setting

for RGB

You can use this option to switch the setting for RGB input signal.

Each time you press **↶** or **↷**, one of the available choices appears in the following sequence:

↔ Auto ↔ VGA ↔ WVGA ↔ 480P ↔ XGA ↔ WXGA ↔ SXGA ↔ SXGA⁺ ↔

[Auto]: The optimum display is obtained automatically for input signals.

[Others]: The optimum resolution setting is fixed for each signal.

Press **ENTER** to store.

* In Auto mode, the resolution of VGA, WVGA, 480P, XGA, WXGA, SXGA and SXGA⁺ may not be automatically distinguished. Switch to the fixed display when the image is not displayed properly.

* Signals that are not applicable depending on the model or input terminals may not be displayed.

Code Setting

for RGB

Normally, use this option in Auto mode.

White Screen

You can use this option to display white over the entire screen to minimize phosphor burn-in.

Each time you press **↶** or **↷**, one of the available choices appears in the following sequence:

↔ Off ↔ On ↔

Press **ENTER** to store.

Background

When the screen size was set to "Normal", to reduce "burn-in", the brightness of the part at which left and right images are not displayed can be set. Normally, we recommend that "Light Gray" be used.

Each time you press **↶** or **↷**, the settings is switched.

↔ Black ↔ Dark Gray ↔ Light Gray ↔

Press **ENTER** to store.

* Burn-in can still occur if the Normal mode is shown for extended periods.

Information

Displays system operation status.

Select "Information" and press **ENTER**.

The "Information" screen will appear.

[Mode]: Input mode appears at the upper right corner of the screen

[Freq. Scan Mode]: Frequency scanning

[Input Signal]: Video mode

[Input Sync]: Signal type

[Freq.]: Synchronized signal frequency, polarity

[Preset No.]: RGB code number

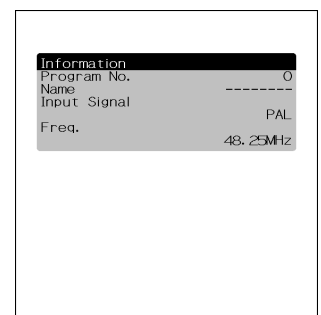

Status Display Screen
(TV Mode)

Note

- The screen display disappears if there is no operation within approximately 60 seconds.
- Depending on the model or the optional devices, some of the functions may not be available.
- The adjustment range varies according to the display signals. Make adjustments to your preferred picture quality within the adjustment range.
- Depending on the type of signal, it may not be possible to make some of the settings or adjustments.

INITIALIZATION OF USER ADJUSTMENT VALUE

You can restore the values of the adjustment/setting made in the MENU to factory settings.



1 Press .

The main menu screen will appear.



"FACTORY DEFAULT" selected in the main menu screen

2 Press or to select "FACTORY DEFAULT".

Each time you press or , one of the available menus appears in the following sequence:

**PICTURE ↔ POSITION/SIZE ↔ AUDIO ↔ FEATURES
↔ FACTORY DEFAULT**

The FACTORY DEFAULT Menu screen will appear.

3 Press .

- Displays the message of whether to proceed with the initialization.

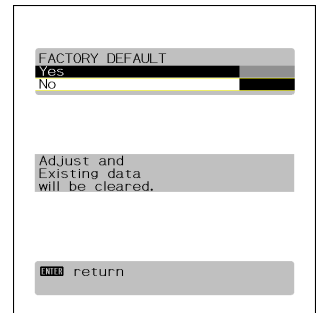

Displays the message of whether to proceed the initialization

4 Press or to select the Yes.

5 Press .

- The message of having completed the initialization will be displayed after initializing.

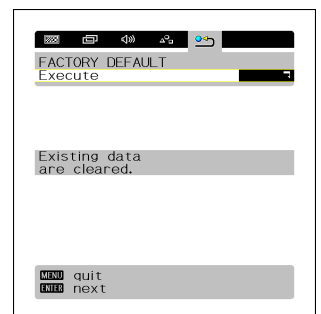

Displays the message of having completed the initialization

6 Press when you finish.

OPTIONS

Wall-mounting Bracket 0° to 15° mounting angle P-WB4201 (for 42" model/50" model)

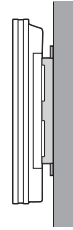

Ceiling unit 5° to 25° mounting angle P-CT4200 (for 42" model/50" model)

To install this plasma display with the wall-mounting bracket or the ceiling unit, install the accessory spacers between the plasma display and frame as shown in the figure at right.

For details, see the wall-mounting bracket installation manual or the ceiling unit installation manual.

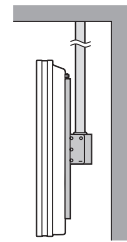
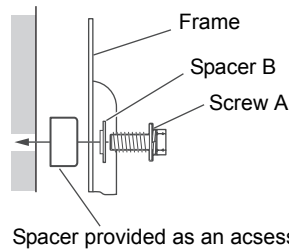

Desktop Stand unit P-TT4202 (for 42" model/50" model)

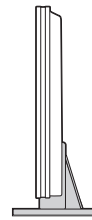

Speaker
(1 set of 2 speakers)

P-SP1000 (for attaching to the display) for 42" model/50" model

P-SP4200 (for mounting on the speaker stands) for 42" model

P-SP5010 (for mounting on the speaker stands) for 50" model



Desktop Speaker Stand
(1 set of 2 speaker stands)

P-ST4200 (for P-SP4200)

P-ST5000 (for P-SP5010)



- * When installing an option, make sure that all installation requirements for that option (as given in the relevant instruction manual) are met.
- * The colors of options do not match the display colors perfectly.
- * To improve the function and performance of optional accessories, specifications and part names may change. Consult your local dealer before purchasing.

Warning

To prevent injury, fire, and electric shock, arrange for options to be initially installed (or installed at a different location) by your dealer.

CAUTION

This display (P42HTA51/P50XTA51) is for use only with Fujitsu General Limited's option (P-WB4201, P-CT4200, P-TT4202). Using this display with other option can cause instability resulting in possible injury.

MAIN SUPPORTED SIGNALS

This display can store the latest four types of signals for RGB adjustment value. The fifth input signal will replace the adjustment value of the first input signal.

To do this, select a desired signal and follow the instructions in “Adjusting Screen Position and Size” on P. E-22 to adjust the parameters. When you finish, the settings will be automatically stored. Thus, when the display receives that signal, pictures will be displayed in accordance with the settings you most recently selected.

Main corresponding signals (RGB mode)

Display (dots x lines)	Horizontal frequency (kHz)	Vertical frequency (Hz)	Signal
640 x 480	31.47	59.94	VGA
640 x 480	37.50	75.00	VGA 75 Hz
640 x 480	43.27	85.01	VGA 85 Hz
720 x 400	31.47	70.09	400 lines
800 x 600	37.88	60.32	SVGA 60 Hz
800 x 600	46.88	75.00	SVGA 75 Hz
800 x 600	53.67	85.06	SVGA 85 Hz
1024 x 768	48.36	60.00	XGA 60 Hz
1024 x 768	60.02	75.03	XGA 75 Hz
1024 x 768	68.68	84.99	XGA 85 Hz
1280 x 1024	63.98	60.02	SXGA 60 Hz
1280 x 1024	79.98	75.03	SXGA 75 Hz
848 x 480	31.02	60.00	
852 x 480	31.72	59.97	
1360 x 768	47.71	60.01	
720 x 485	15.73	59.94	60 fields
720 x 575	15.63	50.00	50 fields

* With some input signals, “Out of range” may appear even when the horizontal and vertical frequencies are within their permissible ranges. In this event, match the input signals to another frequency rather than those listed above.

The display has been factory-set as follows for different input signals:

Main corresponding signals (Comp.video, HDMI input)

Horizontal frequency (kHz)	Vertical frequency (Hz)	Signal	HDMI
15.73	59.94	SDTV 480i	○
15.63	50.00	SDTV 576i	○
31.47	59.94	SDTV 480p	○
31.25	50.00	SDTV 576p	○
45.00	60.00	HDTV 720p	○
37.50	50.00	HDTV 720p	○
33.75	60.00	HDTV 1080i	○
28.13	50.00	HDTV 1080i	○

Main corresponding signals (SCART input)

Horizontal frequency (kHz)	Vertical frequency (Hz)	Signal
15.73	59.94	NTSC
15.63	50.00	PAL
15.63	50.00	SECAM
15.63	59.52	PAL60
15.63	50.00	N-PAL
15.73	59.95	M-PAL
15.73	59.94	4.43NTSC

Main supported signals (TV mode): PAL/SECAM

Note

- Depending on the input signal, the display may show pictures of reduced size due to size reduction and interpolation.
- “Out of range” appears if the display receives a signal whose characteristic does not fall within the display's permissible range.
- You can check input signals through “Information” on the FEATURES Menu screen. (See P. E-28.)
- All terms (i.e., company and product names) used in this document are trademarks or registered trademarks.

TABLE OF TV FREQUENCIES

TABLE OF TV FREQUENCIES

[Applicable Countries]
Austria, Belgium, Denmark,
Finland, Germany, Greece,
Netherlands, Norway,
Portugal, Spain, Sweden,
Switzerland, Luxemburg,
Israel, Cyprus

Frequency (MHz)	Frequency (MHz)
48.25	495.25
55.25	503.25
62.25	511.25
69.25	519.25
76.25	527.25
83.25	535.25
90.25	543.25
97.25	551.25
105.25	559.25
112.25	567.25
119.25	575.25
126.25	583.25
133.25	591.25
140.25	599.25
147.25	607.25
154.25	615.25
161.25	623.25
168.25	631.25
175.25	639.25
182.25	647.25
189.25	655.25
196.25	663.25
203.25	671.25
210.25	679.25
217.25	687.25
224.25	695.25
231.25	703.25
238.25	711.25
245.25	719.25
252.25	727.25
259.25	735.25
266.25	743.25
273.25	751.25
280.25	759.25
287.25	767.25
294.25	775.25
303.25	783.25
311.25	791.25
319.25	799.25
327.25	807.25
335.25	815.25
343.25	823.25
351.25	831.25
359.25	839.25
367.25	847.25
375.25	855.25
383.25	
391.25	
399.25	
407.25	
415.25	
423.25	
431.25	
439.25	
447.25	
455.25	
463.25	
471.25	
479.25	
487.25	
495.25	
503.25	
511.25	
519.25	
527.25	
535.25	
543.25	

[Applicable Countries]
Poland

Frequency (MHz)	Frequency (MHz)
49.75	551.25
59.25	559.25
77.25	567.25
85.25	575.25
93.25	583.25
111.25	591.25
119.25	599.25
127.25	607.25
135.25	615.25
143.25	623.25
151.25	631.25
159.25	639.25
167.25	647.25
175.25	655.25
183.25	663.25
191.25	671.25
199.25	679.25
207.25	687.25
215.25	695.25
223.25	703.25
231.25	711.25
239.25	719.25
247.25	727.25
255.25	735.25
263.25	743.25
271.25	751.25
279.25	759.25
287.25	767.25
295.25	775.25
303.25	783.25
311.25	791.25
319.25	799.25
327.25	807.25
335.25	815.25
343.25	823.25
351.25	831.25
359.25	839.25
367.25	847.25
375.25	855.25
383.25	
391.25	
399.25	
407.25	
415.25	
423.25	
431.25	
439.25	
447.25	
455.25	
463.25	
471.25	
479.25	
487.25	
495.25	
503.25	
511.25	
519.25	
527.25	
535.25	
543.25	

[Applicable Countries]
Italy

Frequency (MHz)	Frequency (MHz)
53.75	543.25
62.25	551.25
82.25	559.25
105.25	567.25
112.25	575.25
119.25	583.25
126.25	591.25
133.25	599.25
140.25	607.25
147.25	615.25
154.25	623.25
161.25	631.25
168.25	639.25
175.25	647.25
183.75	655.25
192.25	663.25
201.25	671.25
210.25	679.25
217.25	687.25
224.25	695.25
231.25	703.25
238.25	711.25
245.25	719.25
252.25	727.25
259.25	735.25
266.25	743.25
273.25	751.25
280.25	759.25
287.25	767.25
294.25	775.25
303.25	783.25
311.25	791.25
319.25	799.25
327.25	807.25
335.25	815.25
343.25	823.25
351.25	831.25
359.25	839.25
367.25	847.25
375.25	855.25
383.25	
391.25	
399.25	
407.25	
415.25	
423.25	
431.25	
439.25	
447.25	
455.25	
463.25	
471.25	
479.25	
487.25	
495.25	
503.25	
511.25	
519.25	
527.25	
535.25	

[Applicable Countries]
France

Frequency (MHz)	Frequency (MHz)
47.75	575.25
55.75	583.25
60.50	591.25
63.75	599.25
116.75	607.25
128.75	615.25
140.75	623.25
152.75	631.25
164.75	639.25
176.00	647.25
176.75	655.25
184.00	663.25
188.75	671.25
192.00	679.25
200.00	687.25
200.75	695.25
208.00	703.25
212.75	711.25
216.00	719.25
224.75	727.25
236.75	735.25
248.75	743.25
260.75	751.25
272.75	759.25
284.75	767.25
296.75	775.25
303.25	783.25
311.25	791.25
319.25	799.25
327.25	807.25
335.25	815.25
343.25	823.25
351.25	831.25
359.25	839.25
367.25	847.25
375.25	855.25
383.25	
391.25	
407.25	
415.25	
423.25	
431.25	
439.25	
447.25	
455.25	
463.25	
471.25	
479.25	
487.25	
495.25	
503.25	
511.25	
519.25	
527.25	
535.25	
543.25	
551.25	
559.25	
567.25	

[Applicable Countries]
Great Britain, Ireland

Frequency (MHz)	Frequency (MHz)
45.75	551.25
53.75	559.25
61.75	567.25
105.25	575.25
112.25	583.25
119.25	591.25
126.25	599.25
133.25	607.25
140.25	615.25
147.25	623.25
154.25	631.25
161.25	639.25
168.25	647.25
175.25	655.25
183.25	663.25
191.25	671.25
199.25	679.25
207.25	687.25
215.25	695.25
231.25	703.25
238.25	711.25
245.25	719.25
252.25	727.25
259.25	735.25
266.25	743.25
273.25	751.25
280.25	759.25
287.25	767.25
294.25	775.25
303.25	783.25
311.25	791.25
319.25	799.25
327.25	807.25
335.25	815.25
343.25	823.25
351.25	831.25
359.25	839.25
367.25	847.25
375.25	855.25
383.25	
391.25	
399.25	
407.25	
415.25	
423.25	
431.25	
439.25	
447.25	
455.25	
463.25	
471.25	
479.25	
487.25	
495.25	
503.25	
511.25	
519.25	
527.25	
535.25	
543.25	

Note

If you execute Auto Store function after selecting "Country", Program Nos. 0-99 are automatically stored in order, starting from the lowest frequency.
If Program Nos. 0-99 are not stored automatically, please use Manual Store function to store them. See page E-26 for detailed operations.

SPECIFICATIONS

WIDE PLASMA DISPLAY

Model	Series Name	P42HTA51E	P50XTA51E
	Product Name	P42HTA51ESb	P50XTA51ESb
Screen size		42" wide screen: 92.2 cm (W) x 52.2 cm (H) (106 cm diagonal) 36.3 inch (W) x 20.6 inch (H) (41.7 inch diagonal)	50" wide screen: 110.6 cm (W) x 62.2 cm (H) (126.9 cm diagonal) 43.5 inch (W) x 24.5 inch (H) (50 inch diagonal)
Aspect ratio		16:9 (wide)	
Number of pixels		1024 (H) x 1080 (V)	1366 (H) x 768 (V)
Weight		31.5 kg / 69.4 lbs	41 kg / 90.4 lbs
Outer dimensions		103.9 (W) x 64.0 (H) x 8.7 (D) cm 40.9 (W) x 25.2 (H) x 3.4 (D) inch (does not include outer projections)	121.6 (W) x 72.6 (H) x 10.0 (D) cm 47.9 (W) x 28.6 (H) x 3.9 (D) inch (does not include outer projections)
Power supply		110-240 VAC 50/60 Hz	
Current rating		4.05-1.5 A	5.1-2.0 A
External equipment terminals			
Antenna input terminal		TV 75 Ω	
Video input terminals	VIDEO1 INPUT	SCART terminal (Video, Audio)	
	VIDEO2 INPUT	SCART terminal (Video, Audio)	
	VIDEO3 INPUT	Component video3 RCA terminals Y: 1 V _{p-p} /75 Ω PB/CB: 0.7 V _{p-p} /75 Ω PR/CR: 0.7 V _{p-p} /75 Ω	
	VIDEO4 INPUT	HDMI terminal (HDMI type A connector)	
	VIDEO5 INPUT	HDMI terminal (HDMI type A connector)	
PC input terminal	RGB1 input	mD-sub, 3 rows, 15-pin Picture signal: 0.7 V _{p-p} /75 Ω Synchronization signal:TTL level	
Audio terminals		2 audio input pin jacks (L/R) (2 lines) 500 mV _{rms} /at least 22 kΩ	
External speaker output terminal		Max. output: 10 W + 10 W, 6Ω	
Operating conditions		Temperature: 0 to 40 °C / 32 to 104 °F Humidity: 20 to 80 %	
Accessories		Safety Precautions, This manual, Remote control, AA batterie (2), Power cable, Spacer (4), Small ferrite core (2), Large ferrite core	

Regulation

- CE Safety: EN60065
- EMC: EN55013 (CISPR13)
- EN55020 (CISPR20)
- EN55022 (CISPR22)
- EN55024 (CISPR24)
- EN61000-3-2
- EN61000-3-3

Note

- Specifications and external appearance may be change for the sake of improvement.
- Viewing the screen constantly for extended periods can strain your eyes. Be sure to stay at a proper distance (at least 1.6 m or 5.2 feet for 42"/at least 1.9 m or 6.2 feet for 50") from the screen and to look occasionally away while working.
- **Plasmavision™** is a worldwide trademark of Fujitsu General Limited and is a registered trademark in Japan, the U.S.A. and other countries or areas.

CLEANING AND MAINTENANCE

Precautions

Be sure to remove the power plug from the receptacle before cleaning the display.

Be sure not to clean the display using a cloth dampened with volatile solvents, such as benzene or thinner. Such solvents can harm the display's cabinet, the filter at the screen front, and the remote control. They can also cause paint to come off these sections.

Cleaning the Screen

Clean the screen gently with a soft cloth.

The screen surface is fragile. Never attempt to clean it with a hard material, press on it forcefully, or tap it.

Cleaning the Cabinet and Remote Control

Use a soft cloth for cleaning.

If the cabinet or remote control is heavily stained, soak a soft cloth in a mixture of water and detergent and squeeze it dry before wiping off the stains. Use a soft, dry cloth for final cleaning.

Cleaning the ventilation grille

Remove dust from the ventilation grille in the rear of the main unit periodically with a vacuum cleaner as the accumulated dust can increase the internal temperature of the main unit causing machine failure or fire hazard.

BEFORE OBTAINING SERVICE

In the event of problems with the display, check the following explanations before contacting your dealer for servicing.

Problem	Action
• Power does not turn ON.	• Check whether the power plug is securely inserted into the receptacle.
• No pictures are displayed.	• Check cables for disconnection. • Check whether the power for all input equipment is ON. • Check for connection to wrong terminals or for wrong input mode. • Check whether the input mode display is colored pink. Special setup may have been made. Return to original setup or initialize the User adjustment value.
• Remote control does not function properly.	• Check for incorrect battery orientation. • Check for dead batteries. • Check for distance from the display. • Check whether you are pointing the remote control transmitter properly at the display's receiver. • Check for any obstacle between the remote control and the display.
• The display makes a snapping sound.	• This sound is produced when the cabinet expands or contracts due to variations in temperature. This sound does not indicate that the display has a problem.
• The display makes a buzzing sound.	• The display has fans to maintain the temperature of internal components at a constant level. This sound is produced by the fan as it rotates. (Applies to models equipped with a fan)
• There are spots on the screen.	• Check whether your AV equipment is affected by interference from automobiles, trains, high-voltage transmission lines, neon signs or other potential sources of interference.
• Degraded colors/tints	• Check whether all picture adjustments have been properly made. (See "Adjusting Pictures" on P. E-20-E-21.)
• Improper screen position/size	• Check whether screen position and size have been properly adjusted. (See "Adjusting Screen Position and Size" on P. E-22.)
• No audio	• Check cables for disconnection. • Check whether the proper audio input has been selected. (See "Audio Input" on P. E-27.)
• If "Out of range" appears, the display is receiving a signal whose picture or signal cannot be reproduced by the display. • The screen turns to black and white.	• Signals that are not supported by this display have been input. Check which signals are supported. (See "MAIN SUPPORTED SIGNALS" on P. E-31.)
• If "Error message Condition 1" appears, the fan is defective.	• Remove the power plug from the receptacle, and contact your dealer for repairs. (Applies to models equipped with a fan)
• If "Error message Condition 2" appears, the display's internal components are extremely hot.	• Remove the power plug from the receptacle. (You can turn the power back ON again when the components have cooled sufficiently.) If the message appears again when you turn the power back on, remove the power plug from the receptacle, and contact your dealer for a repairs.
• If "Change refresh rate to 60Hz" appears.	• The picture may get blurred with vertical frequency of other than 48.3-51.8 or 58.4-61.4 (Hz). Change the setting of your PC, etc.
• If the power indicator lamp flashes red or green.	• Remove the power plug from the receptacle, and inform your dealer about how the lamp flashed. The power indicator lamp flashes differently depending on the type of problem.

Note

- Functions may not be available with some models and some device options.

Free Manuals Download Website

<http://myh66.com>

<http://usermanuals.us>

<http://www.somanuals.com>

<http://www.4manuals.cc>

<http://www.manual-lib.com>

<http://www.404manual.com>

<http://www.luxmanual.com>

<http://aubethermostatmanual.com>

Golf course search by state

<http://golfingnear.com>

Email search by domain

<http://emailbydomain.com>

Auto manuals search

<http://auto.somanuals.com>

TV manuals search

<http://tv.somanuals.com>