

## USER'S MANUAL

### 63" WIDE PLASMA DISPLAY

# Plasmavision™ W

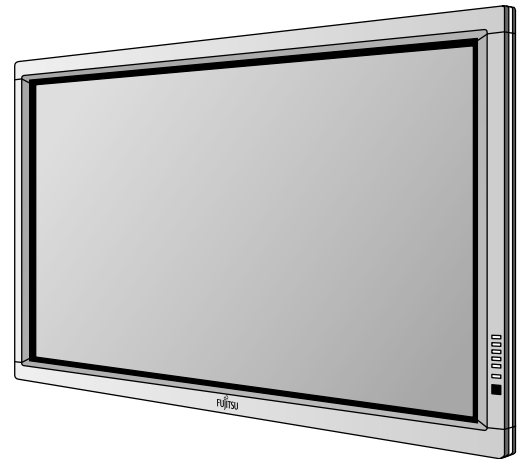

P63XHA30E

### Contents

	Page
<b>Before Use</b>	
• Safety Precautions .....	E-2-E-3
• Accessories .....	E-4
• Handy Tips .....	E-4
• Installation .....	E-5
<b>Others</b>	
• Options .....	E-6
• Specification .....	E-7

\* **Plasmavision™** is a worldwide trademark of Fujitsu General Limited and is a registered trademark in Japan, the U.S.A. and other countries or areas.

*Before using the display, read this manual carefully so that you know how to use the display correctly. Refer to this manual whenever questions or problems about operation arise. Be sure to read and observe the safety precautions.*

*Keep this manual where the user can see it easily.*

*\* Installation and removal require special expertise. Consult your product dealer for details.*

# SAFETY PRECAUTIONS

## IMPORTANT INFORMATION

### IMPORTANT



The lightning flash with arrowhead symbol, within an equilateral triangle, is intended to alert the user to the presence of uninsulated "dangerous voltage" within the product's enclosure that may be of sufficient magnitude to constitute a risk of electric shock to persons.



**CAUTION:**  
TO PREVENT THE RISK OF ELECTRIC SHOCK, DO NOT REMOVE COVER (OR BACK). NO USER-SERVICEABLE PARTS INSIDE. REFER SERVICING TO QUALIFIED SERVICE PERSONNEL.



The exclamation point within an equilateral triangle is intended to alert the user to the presence of important operating and maintenance (servicing) instructions in the literature accompanying the appliance.

**WARNING:** This is a Class A and Class B product. In a domestic environment this product may cause radio interference in which case the user may be required to take adequate measures.

**WARNING:** TO REDUCE THE RISK OF FIRE AND ELECTRIC SHOCK, DO NOT EXPOSE THIS PRODUCT TO RAIN OR MOISTURE.

## FCC NOTICE

### • A Class A digital device

This equipment has been tested and found to comply with the limits for a Class A digital device, pursuant to Part 15 of the FCC Rules. These limits are designed to provide reasonable protection against harmful interference when the equipment is operated in a commercial environment. This equipment generates, uses, and can radiate radio frequency energy and, if not installed and used in accordance with the instruction manual, may cause harmful interference to radio communications. Operation of this equipment in a residential area is likely to cause harmful interference in which case the user will be required to correct the interference at his own expense.

### • A Class B digital device

This equipment has been tested and found to comply with the limits for a Class B digital device, pursuant to Part 15 of the FCC Rules. These limits are designed to provide reasonable protection against harmful interference in a residential installation. This equipment generates, uses and can radiate radio frequency energy and, if not installed and used in accordance with the instructions, may cause harmful interference to radio communications. However, there is no guarantee that interference will not occur in a particular installation. If this equipment does cause harmful interference to radio or television reception, which can be determined by turning the equipment off and on, the user is encouraged to try to correct the interference by one or more of the following measures:

- Reorient or relocate the receiving antenna.
- Increase the separation between the equipment and receiver.
- Connect the equipment into an outlet on a circuit different from that to which the receiver is connected.
- Consult the dealer or an experienced radio/TV technician for help.

## IMPORTANT SAFETY INSTRUCTIONS

Electrical energy can perform many useful functions. This unit has been engineered and manufactured to assure your personal safety. But **IMPROPER USE CAN RESULT IN POTENTIAL ELECTRICAL SHOCK OR FIRE HAZARD.** In order not to defeat the safeguards incorporated into this product, observe the following basic rules for its installation, use and service. Please read these "Important Safeguards" carefully before use.

- 1) Read these instructions.
- 2) Keep these instructions.
- 3) Heed all warnings.
- 4) Follow all instructions.
- 5) Do not use this apparatus near water.
- 6) Clean only with dry cloth.
- 7) Do not block any ventilation openings. Install in accordance with the manufacturer's instructions.
- 8) Do not install near any heat sources such as radiators, heat registers, stoves, or other apparatus (including amplifier's) that produce heat.
- 9) Do not defeat the safety purpose of the polarized or grounding-type plug. A polarized plug has two blades with one wider than the other. A grounding type plug has two blades and a third grounding prong. The wide blade or the third prong are provided for your safety. If the provided plug does not fit into your outlet, consult an electrician for replacement of the obsolete outlet.
- 10) Protect the power cord from being walked on or pinched particularly at plugs, convenience receptacles, and the point where they exit from the apparatus.
- 11) Only use attachments/accessories specified by the manufacturer.

- 12) Use only with the cart, stand, tripod, bracket, or table specified by the manufacturer, or sold with the apparatus.

When a cart is used, use caution when moving the cart/apparatus combination to avoid injury from tip-over.

- 13) Unplug this apparatus during lightning storms or when unused for long periods of time.

- 14) Refer all servicing to qualified service personnel. Servicing is required when the apparatus has been damaged in any way, such as power-supply cord or plug is damaged, liquid has been spilled or objects have fallen into the apparatus, the apparatus has been exposed to rain or moisture, does not operate normally, or has been dropped.



- Unplug this product from the wall outlet before cleaning. Do not use liquid cleaners or aerosol cleaners. Use a damp cloth for cleaning.
- Do not use attachments not recommended by the product manufacturer as they may cause hazards.
- Do not use immediately after moving from a low temperature to high temperature, as this causes condensation, which may result in fire, electric shock, or other hazards.
- The apparatus shall not be exposed to dripping or splashing.
- No objects filled with liquids, such as vases, shall be placed on the apparatus.
- Do not place this product on an unstable cart, stand, or table. The product may fall, causing serious injury to a child or adult, and serious damage to the product. The product should be mounted according to the manufacturer's instructions, and should use a mount recommended by the manufacturer.
- When the product is used on a cart, care should be taken to avoid quick stops, excessive force, and uneven surfaces which may cause the product and cart to overturn, damaging equipment or causing possible injury to the operator.
- Slots and openings in the cabinet are provided for ventilation. These ensure reliable operation of the product and protect it from overheating. These openings must not be blocked or covered. (The openings should never be blocked by placing the product on bed, sofa, rug, or other similar surface. It should not be placed in a built-in installation such as a bookcase or rack unless proper ventilation is provided and the manufacturer's instructions have been adhered to.)

For proper ventilation, separate the product from other equipment, which may prevent ventilation, and keep distance more than 10 cm.

- This product should be operated only from the type of power source indicated on the label. If you are not sure of the type of power supply of your home, consult your product dealer or local power company.
- This product is equipped with a three-wire plug. This plug will fit only into a grounded power outlet. If you are unable to insert the plug into the outlet, contact your electrician to install the proper outlet. Do not defeat the safety purpose of the grounded plug.
- Power-supply cords should be routed so that they are not likely to be walked on or pinched by items placed upon or against them. Pay particular attention to cords at doors, plugs, receptacles, and the point where they exit from the product.
- For added protection for this product during a lightning storm, or when it is left unattended and unused for long periods of time, unplug it from the wall outlet and disconnect the cable system. This will prevent damage to the product due to lightning and power line surges.
- Do not overload wall outlets, extension cords, or convenience receptacles on other equipment as this can result in a risk of fire or electric shock.
- Never push objects of any kind into this product through openings as they may touch dangerous voltage points or short out parts that could result in a fire or electric shock. Never spill liquid of any kind on the product.
- Do not attempt to service this product yourself as opening or removing covers may expose you to dangerous voltages and other hazards. Refer all service to qualified service personnel.
- Unplug this product from the wall outlet and refer service to qualified service personnel if the product does not operate normally by following the operating instructions. Adjust only those controls that are covered by the Operation Manual, as an improper adjustment of other controls may result in damage and will often require extensive work by a qualified technician to restore the product to its normal operation.
- When replacement parts are required, be sure the service technician has used replacement parts specified by the manufacturer or with same characteristics as the original part. Unauthorized substitutions may result in fire, electric shock, or other hazards.
- Upon completion of any service or repairs to this product, ask the service technician to perform safety checks to determine that the product is in proper operating condition.
- The product should be placed more than one foot away from heat sources such as radiators, heat registers, stoves, and other products (including amplifiers) that produce heat.
- When connecting other products such as VCR's, and personal computers, you should turn off the power of this product for protection against electric shock.
- Do not place combustibles behind the cooling fan. For example, cloth, paper, matches, aerosol cans or gas lighters that present special hazards when overheated.
- Use only the accessory cord designed for this product to prevent shock.

The power supply voltage rating of this product is AC110–240 V and the power cord attached conforms to the following power supply voltage. Use only the power cord designated by our dealer to ensure Safety and EMC.

When it is used with other power supply voltage, the power cable must be changed.

Use the standard power plug and cord set of the specified country.

Consult your product dealer.



Power supply voltage:

AC 100–125 V

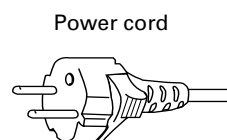

AC 200–240 V

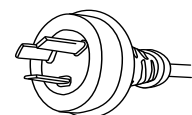

AC 240 V (SAA TYPE)

# ACCESSORIES

## CHECKING ACCESSORIES

One remote control



Two AA batteries

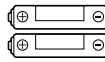

One user's manual



One power cable

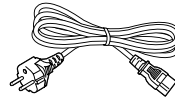

Two big ferrite cores

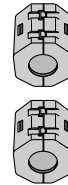

Two small ferrite cores

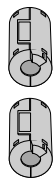

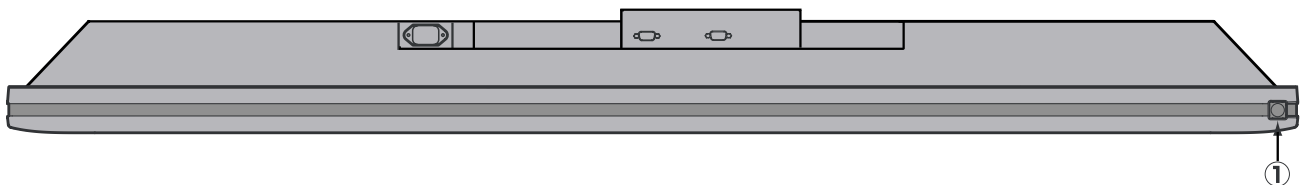

## HANDY TIPS

- Have the display inspected and cleaned by your dealer at regular intervals.
- Pictures may become “burnt” into the screen phosphors if the screen is left on for extended periods. To ensure that the display has a prolonged service life, be sure to use a screen orbiter, white screen. This will ensure the same picture or pattern is not constantly displayed for long periods.
- The plasma display panel, which is built for maximum precision, provides more than 99.99% effective pixels. You may find, however, that some pixels constantly remain lit or dimmed.
- The display has a fan to prevent its internal temperature from rising.
- Be careful with the air delivered by the fan. It may be very hot.
- Contact your dealer if you find that the display does not seem to function properly when used with other audio-visual equipment.  
You may need to move your display if it produces degraded pictures or noise due to electromagnetic radiation, or if the infrared remote control does not function properly.
- Pictures may not be displayed properly if you connect a non-standard PC to the RGB input terminal. In this case, contact your dealer for more information.
- The protective circuit, built into the display, automatically turns off the power if the display has a problem. In this case, you will see that the power indicator lamp flashes red or green.



### ① power switch

- When pressed while in the “OFF” state, the power indicator lamp lights and the display is placed in the “ON ” state, and the power can be turned “ON” or “OFF” by the remote control or on the control panel of the display. When pressed while in the “ON ” state, the power indicator lamp goes out and the display is placed in the “OFF” state where power is still partly supplied.

## Warning

If the power indicator lamp flashes red or green, this signifies that the display has developed a problem. When this happens, be sure to remove the power plug from the receptacle to prevent fire or electric shock. Then contact your dealer.

### Information

Cables for connecting the display to external equipment are not supplied. Contact your dealer for more information on these products.

# INSTALLATION

To prevent the display's internal components from overheating, make sure that the display is installed in a well-ventilated location. Be sure to use the optional stand, wall-mounting unit or the other unit when installing the display. Also, be also sure that your dealer performs the installation.

See the appropriate instruction manual for more information on the installation hardware you select.

To prevent an accident and ensure safety in the event of an earthquake, fix the display securely into position as described below.

To ensure proper heat radiation, provide at least as much space around the display as shown below.

- \* Make sure that the display is installed in a location where the temperature can be maintained between 0°C and 40°C.
- \* Never attempt to tilt the display sideways or backward.
- \* To prevent the power and other cables from being accidentally pulled, make sure that they run along the wall or through corners.
- \* The display can be installed with either of its sides facing down.

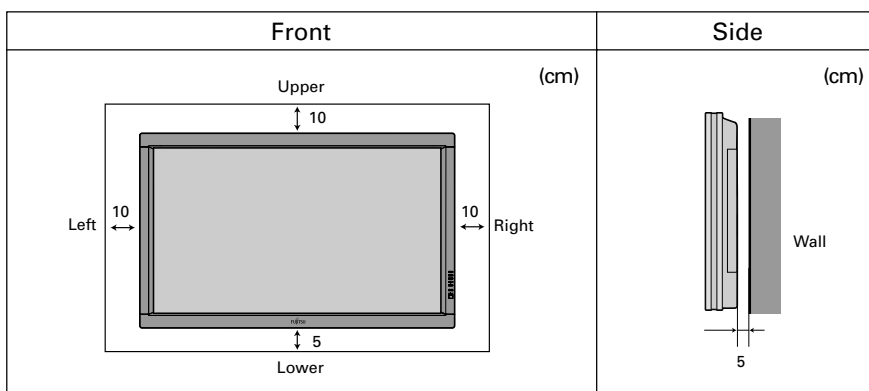

## Note

The display is a highly precise piece of equipment and therefore must be packed properly before transportation. Be sure to use only those packing materials originally supplied with the display when repacking it.

## Reference

See P. E-6 for more information on options.

# OPTIONS

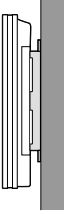
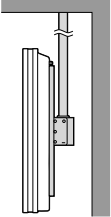
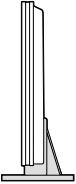
Wall-mounting Bracket	0° to 15° mounting angle	P-WB6300	
Ceiling unit	0° to 15° mounting angle	P-CT6300	
Desktop Stand unit		P-TT6300	

- \* When installing an option, make sure that all installation requirements for that option (as given in the relevant instruction manual) are met.
- \* The colours of options do not match the display colours perfectly.
- \* To improve the function and performance of optional accessories, specifications and part names may change. Consult your local dealer before purchasing.

## Warning

To prevent injury, fire, and electric shock, arrange for options to be initially installed (or installed at a different location) by your dealer.

**CAUTION:** This display (P63XHA30E) is for use only with Fujitsu General Limited's option (P-WB6300, P-CT6300, P-TT6300).  
Using this display with other option can cause instability resulting in possible injury.

# SPECIFICATION

Model	P63XHA30E
Screen size	63" wide screen: 139.3 cm (W) x 78.3 cm (H) (159.8 cm diagonal) 54.8 inch (W) x 30.8 inch (H) (62.9 inch diagonal)
Aspect ratio	16:9 (wide)
Weight	72 kg / 159 lbs
Outer dimensions	150.6 (W) x 89.6 (H) x 12.3 (D) cm 59.3 (W) x 35.3 (H) x 4.8 (D) inch (does not include outer projections)
Power supply	110–240 VAC 50/60 Hz
Current rating	7.9–3.0 A
Number of pixels	1366 (H) x 768 (V)
Operating conditions	Temperature: 0 to 40 °C / 32 to 104 °F Humidity: 20 to 80 %
Accessories	1 remote control, 2AA batteries, 1 instruction manual, 1 power cable, 2 big ferrite cores, 2 small ferrite cores

## Regulation

- UL, CSA Safety: UL6500, C-UL  
EMC: FCC Part 15 Class B, ICES-003 Class B
- CE Safety: EN60065  
EMC: EN55022 1998, Class B  
EN61000-3-2 1995  
EN61000-3-3 1995  
EN55024 1998  
EN61000-4-2 1995  
EN61000-4-3 1996  
EN61000-4-4 1995  
EN61000-4-5 1995  
EN61000-4-6 1996  
EN61000-4-8 1993  
EN61000-4-11 1994
- AS Safety: IEC60065  
EMC: AS/NZS 3548

- Specifications and external appearance may be change for the sake of improvement.
- Viewing the screen constantly for extended periods can strain your eyes. Be sure to stay at a proper distance (at least 2.4 m or 7.9 feet) from the screen and to look occasionally away while working.
- **Plasmavision** is a worldwide trademark of Fujitsu General Limited and is a registered trademark in Japan, the U.S.A. and other countries or areas.

## Free Manuals Download Website

<http://myh66.com>

<http://usermanuals.us>

<http://www.somanuals.com>

<http://www.4manuals.cc>

<http://www.manual-lib.com>

<http://www.404manual.com>

<http://www.luxmanual.com>

<http://aubethermostatmanual.com>

Golf course search by state

<http://golfingnear.com>

Email search by domain

<http://emailbydomain.com>

Auto manuals search

<http://auto.somanuals.com>

TV manuals search

<http://tv.somanuals.com>