



# USER'S MANUAL

## 42" WIDE PLASMA DISPLAY

PDS4221W-H/PDS4221W-S/

PDS4222W-H/PDS4222W-S

# Plasmavision™

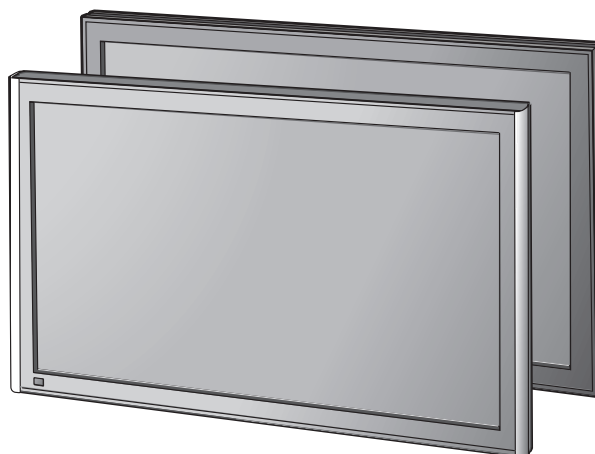

### Contents

	Page		Page
<b>Before Use</b>		<b>Adjustments</b>	
• Safety Precautions .....	E-2–E-3	• Adjusting Images (PICTURE Menu) .....	E-28–E-29
• Features .....	E-4	• Adjusting Screen Position and Size (POSITION/SIZE Menu) .....	E-30–E-31
• Handy Tips .....	E-5	• Adjusting Sound (SOUND Menu) .....	E-32–E-33
• Cleaning and Maintenance .....	E-6	• Other Adjustments (OTHERS Menu) .....	E-34–E-36
• Installation .....	E-7	• Extended Features (Extended menu) .....	E-37–E-41
• Safety Measures .....	E-8	<b>Others</b>	
• Accessories .....	E-9	• Specification .....	E-42
<b>Usage</b>		• Regulation .....	E-43
• Part Names and Functions .....	E-10–E-14	• Options .....	E-44
• Using the Remote Control .....	E-15		
• Connecting the Display to External Equipment .....	E-16–E-17		
• Basic Operations .....	E-18		
• Selecting Input Mode .....	E-19		
• Watching Images on the Wide Screen .....	E-20–E-21		
• How to Use Menus .....	E-22–E-27		

*Before using the display, read this manual carefully so that you know how to use the display correctly. Refer to this manual whenever questions or problems about operation arise. Be sure to read and observe the safety precautions.*

*Keep this manual where the user can see it easily.*

*\* Installation and removal require special expertise. Consult your product dealer for details.*



## DECLARATION OF CONFORMITY

according to EN45014

We

Fujitsu General (Euro) GmbH

of

Werftstraße 20, D-40549 Düsseldorf, F. R. Germany

Manufacturer: Shinjyo Fujitsu General Limited  
702-3 Kanazawa Shinjyo-shi  
Yamagata Japan

*declares under our sole responsibility that the product,*

Type: 42" PLASMA DISPLAY

Model Name: PDS4221W-H / PDS4221W-S

*to which this declaration relates are in conformity with the following standards;*

**European Standards:**

- EMC: a. EN55022 1994/A1:1995/A2:1997 Class A  
b. EN61000-3-2 1995  
c. EN61000-3-3 1995  
d. EN55024 1998  
(EN61000-4-2 1995 / EN 61000-4-3 1996)  
(EN61000-4-4 1995 / EN 61000-4-5 1995 / EN61000-4-6 1996)  
(EN61000-4-8 1993 / EN 61000-4-11 1994)
- Safety: e. EN60950 1992/A1:1993/A2:1993/A3:1995/A4:1997

*By conformance with the standard referenced, the product follows  
the provisions of the directives listed below.*

- a. EC Council Directive 89/336/EEC of 3rd, May 1989  
b. EC Council Directive 92/31/EEC of 28th, April 1992  
c. EC Council Directive 93/68/EEC of 22nd, July 1993  
d. EC Council Directive 73/23/EEC of 19th, February 1973

Place of Issue: Germany

Date of Issue: Sep. 1999

Signature: \_\_\_\_\_

H. Hirosaki, Managing Director  
Fujitsu General (Euro) GmbH

Declaration reference: Fujitsu General (Euro) GmbH

Werftstraße 20, D-40549 Düsseldorf, F. R. Germany

Tel: 0211-50098-0 Fax: 0211-50098-50



## DECLARATION OF CONFORMITY

according to EN45014

We

Fujitsu General (Euro) GmbH

of

Werftstraße 20, D-40549 Düsseldorf, F. R. Germany

Manufacturer: Shinjyo Fujitsu General Limited  
702-3 Kanazawa Shinjyo-shi  
Yamagata Japan

*declares under our sole responsibility that the product,*

Type: 42" PLASMA DISPLAY

Model Name: PDS4222W-H / PDS4222W-S

*to which this declaration relates are in conformity with the following standards;*

European Standards:

- EMC: a. EN55022 1994/A1:1995/A2:1997 Class B  
b. EN61000-3-2 1995  
c. EN61000-3-3 1995  
d. EN55024 1998  
(EN61000-4-2 1995 / EN 61000-4-3 1996)  
(EN61000-4-4 1995 / EN 61000-4-5 1995 / EN61000-4-6 1996)  
(EN61000-4-8 1993 / EN 61000-4-11 1994)
- Safety: e. EN60950 1992/A1:1993/A2:1993/A3:1995/A4:1997

*By conformance with the standard referenced, the product follows  
the provisions of the directives listed below.*

- a. EC Council Directive 89/336/EEC of 3rd, May 1989  
b. EC Council Directive 92/31/EEC of 28th, April 1992  
c. EC Council Directive 93/68/EEC of 22nd, July 1993  
d. EC Council Directive 73/23/EEC of 19th, February 1973

Place of Issue: Germany

Date of Issue: Sep. 1999

Signature: \_\_\_\_\_

H. Hirosaki, Managing Director  
Fujitsu General (Euro) GmbH

Declaration reference: Fujitsu General (Euro) GmbH

Werftstraße 20, D-40549 Düsseldorf, F. R. Germany

Tel: 0211-50098-0 Fax: 0211-50098-50

# SAFETY PRECAUTIONS

## FCC NOTICE

- PDS4221W-H/PDS4221W-S: A Class A digital device

This equipment has been tested and found to comply with the limits for a Class A digital device, pursuant to Part 15 of the FCC Rules. These limits are designed to provide reasonable protection against harmful interference when the equipment is operated in a commercial environment. This equipment generates, uses, and can radiate radio frequency energy and, if not installed and used in accordance with the instruction manual, may cause harmful interference to radio communications. Operation of this equipment in a residential area is likely to cause harmful interference in which case the user will be required to correct the interference at his own expense.

- PDS4222W-H/PDS4222W-S: A Class B digital device

This equipment has been tested and found to comply with the limits for a Class B digital device, pursuant to Part 15 of the FCC Rules. These limits are designed to provide reasonable protection against harmful interference in a residential installation. This equipment generates, uses and can radiate radio frequency energy and, if not installed and used in accordance with the instructions, may cause harmful interference to radio communications. However, there is no guarantee that interference will not occur in a particular installation. If this equipment does cause harmful interference to radio or television reception, which can be determined by turning the equipment off and on, the user is encouraged to try to correct the interference by one or more of the following measures:

- Reorient or relocate the receiving antenna.
- Increase the separation between the equipment and receiver.
- Connect the equipment into an outlet on a circuit different from that to which the receiver is connected.
- Consult the dealer or an experienced radio/TV technician for help.

## IMPORTANT INFORMATION

**WARNING:** This is Class A and Class B product. In a domestic environment this product may cause radio interference in which case the user may be required to take adequate measures.

**WARNING:** TO REDUCE THE RISK OF FIRE AND ELECTRIC SHOCK, DO NOT EXPOSE THIS PRODUCT TO RAIN OR MOISTURE.

## IMPORTANT SAFEGUARDS

Electrical energy can perform many useful functions. This unit has been engineered and manufactured to assure your personal safety. But **IMPR OPERUSECANRESUL TINPO TENTIAELECTRICALSHOCKORFIREHAZARD**. In order not to defeat the safeguards incorporated into this product, observe the following basic rules for its installation, use and service. Please read these “Important Safeguards” carefully before use.

- All the safety and operating instructions should be read before the product is operated.
- The safety and operating instructions should be retained for future reference.
- All warnings on the product and in the operating instructions should be adhered to.
- All operating instructions should be followed.
- Unplug this product from the wall outlet before cleaning. Do not use liquid cleaners or aerosol cleaners. Use a damp cloth for cleaning.
- Do not use attachments not recommended by the product manufacturer as they may cause hazards.
- Do not use this product near water. Do not use immediately after moving from a low temperature to high temperature, as this causes condensation, which may result in fire, electric shock, or other hazards.
- Do not place this product on an unstable cart, stand, or table. The product may fall, causing serious injury to a child or adult, and serious damage to the product. The product should be mounted according to the manufacturer’s instructions, and should use a mount recommended by the manufacturer.

- When the product is used on a cart, care should be taken to avoid quick stops, excessive force, and uneven surfaces which may cause the product and cart to overturn, damaging equipment or causing possible injury to the operator.
- The product should be mounted to a wall or ceiling only as recommended by the manufacturer.



- Slots and openings in the cabinet are provided for ventilation. These ensure reliable operation of the product and protect it from overheating. These openings must not be blocked or covered. (The openings should never be blocked by placing the product on bed, sofa, rug, or other similar surface. It should not be placed in a built-in installation such as a bookcase or rack unless proper ventilation is provided or the manufacturer's instructions have been adhered to.)

For proper ventilation, separate the product from other equipment, which may prevent ventilation and keep distance more than 10 cm.

- This product should be operated only from the type of power source indicated on the label. If you are not sure of the type of power supply to your home, consult your product dealer or local power company.
- This product is equipped with a three-wire plug. This plug will fit only into a grounded power outlet. If you are unable to insert the plug into the outlet, contact your electrician to install the proper outlet. Do not defeat the safety purpose of the grounded plug.
- Power-supply cords should be routed so that they are not likely to be walked on or pinched by items placed upon or against them. Pay particular attention to cords at doors, plugs, receptacles, and the point where they exit from the product.
- For added protection for this product during a lightning storm, or when it is left unattended and unused for long periods of time, unplug it from the wall outlet and disconnect the cable system. This will prevent damage to the product due to lightning and power line surges.
- Do not overload wall outlets, extension cords, or convenience receptacles on other equipment as this can result in a risk of fire or electric shock.
- Never push objects of any kind into this product through openings as they may touch dangerous voltage points or short out parts that could result in a fire or electric shock. Never spill liquid of any kind on the product.
- Do not attempt to service this product yourself as opening or removing covers may expose you to dangerous voltages or other hazards. Refer all service to qualified service personnel.
- Unplug this product from the wall outlet and refer service to qualified service personnel under the following conditions:
  - a) When the power supply cord or plug is damaged.
  - b) If liquid has been spilled, or objects have fallen on the product.
  - c) If the product has been exposed to rain or water.
  - d) If the product does not operate normally by following the operating instructions. Adjust only those controls that are covered by the Operation Manual, as an improper adjustment of other controls may result in damage and will often require extensive work by a qualified technician to restore the product to its normal operation.
  - e) If the product has been dropped or damaged in any way.
  - f) When the product exhibits a distinct change in performance—this indicates a need for service.
- When replacement parts are required, be sure the service technician has used replacement parts specified by the manufacturer or with same characteristics as the original part. Unauthorized substitutions may result in fire, electric shock, or other hazards.
- Upon completion of any service or repairs to this product, ask the service technician to perform safety checks to determine that the product is in proper operating condition.
- The product should be placed more than one foot away from heat sources such as radiators, heat registers, stoves, and other products (including amplifiers) that produce heat.
- When connecting other products such as VCR's, and personal computers, you should turn off the power of this product for protection against electric shock.
- Do not place combustibles behind the cooling fan. For example, cloth, paper, matches, aerosol cans or gas lighters that present special hazards when over heated.
- Use only the accessory cord designed for this product to prevent shock.

The power supply voltage rating of this product is AC100–240 V, the power cord attached conforms to the following power supply voltage. Use only the power cord designated by our dealer to ensure Safety and EMC.

When it is used by other power supply voltage, power cable must be changed.

Consult your product dealer.

Power cord



Power supply voltage: AC 100–125 V

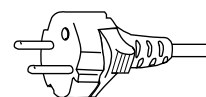

AC 200–240 V

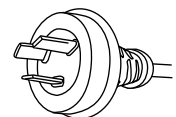

AC 240 V (SAA TYPE)

# FEATURES

This display has a plasma display panel and is only 8.5 cm deep. With its high image quality and performance, it is perfectly suited to multimedia applications.

## Can receive a variety of input signals

- In addition to video, S-video, and RGB1 (mD-sub Connector), RGB2 (BNC x 5 connector) signals, this display supports input of high-quality video signals such as DVD and HDTV.
- The display is applicable to the following color television systems used worldwide: NTSC, PAL, SECAM, N-PAL, M-PAL, 4.43NTSC.
- The display has a component video input terminal to receive signals from the DVD player and HDTV equipment as well as digital broadcasting signals (color difference signals).
- The display has an RGB input terminal to receive signals, including wide RGB signals, VGA, SVGA, and XGA.
- The display supports the following digital broadcasting signals: 525i, 625i, 480p, 720p, 1080i.

## High-definition images in 1024 x 1024 dots

- Provides high resolution in XGA (1024 x 768 dots) and displays high-definition HDTV and digital broadcasting images.

## Higher brightness (500 cd/cm<sup>2</sup>)

- Higher brightness has been realized.

## 5 screen sizes (video input mode) and 3 screen sizes (RGB input mode)

- This display offers a total of five different screen sizes in video input mode: Wide1, Wide2, Zoom1, and Zoom2. A Normal mode is also available, for display of normal-size (4:3 aspect ratio) images.
- Three different screen sizes in RGB input mode (Normal, Wide, and Zoom) are also available.

## Install the display lengthwise

- The display can be installed lengthwise, enabling advertising to be displayed. In this case, you can set up the display so that on-screen information, such as input modes and menus, is displayed properly.

## Power management function

- The display features a DPMS (Display Power Management Signaling) function that ensures automatic power saving capability. (This function is enabled when the preset amount of time elapses if the display stops receiving input signals.)

## Flexible enough to be used as part of a system

- You can operate the display by remote control using the RS-232C interface.
- If you have two or more displays, you can assign a unique number to each of them so that you can select which one you want to use.

## Others

- You can specify the color temperature.
- Two-line sound input, 1 W + 1 W built-in speaker, and 7 W + 7 W external speaker outputs are available.
- The white screen and screen saver functions are available to minimize phosphor burn-in.

- Images may become “burnt” into the screen phosphors if the screen is left on for extended periods. To ensure that the display has a prolonged service life, be sure to use a screen saver. This will ensure the same image or pattern is not constantly displayed for long periods. (See P. E-40–E-41.)
- The display’s plasma display panel, which is built for maximum precision, provides more than 99.99% effective pixels. You may find, however, that some pixels constantly remain lit or dimmed.
- The display has a fan to prevent its internal temperature from rising.  
Be careful with the air delivered by the fan. It may be very hot.
- A fire may result if the internal temperature rises due to vent holes plugged with dust. Check and clean the vent holes at regular intervals.
- Contact your dealer if you find that the display does not seem to function properly when used with other audio-visual equipment.  
You may need to move your display if it produces degraded images or noise due to electromagnetic radiation, or if the infrared remote control does not function properly.
- If certain types of personal computers are connected to the RGB input terminal, images will not be displayed properly.
- Develop control application software for remote-control applications using RS-232C. Contact your dealer for more information.

## Warning

The protective circuit built into the display automatically turns the power to OFF if the display has an internal problem. At this time, the power indicator blinks red, indicating that the display is somehow faulty. If you continue using the display as is, fire or electric shock may result. Be sure to first remove the power plug from the receptacle and to contact your dealer immediately.

- If the message “Error message Condition 1” appears, the fan is faulty. Turn the main power switch to OFF, remove the power plug from the receptacle, and contact your dealer.
- If the message “Error message Condition 2” appears, the internal temperature is inordinately high. Turn the main power switch to OFF. (If the interior of the display cools down, the power can be turned to ON again.)

If the error message persists after the main power switch has been turned to ON again, turn the power switch to OFF, remove the power plug from the receptacle, and contact your dealer.

- The following Power-indicator blinking patterns indicate various problems:

Continuously: The Power supply voltage is inappropriate. Once: The fan is faulty. Twice: The temperature is abnormal. Three times or more: There is another problems.

Contact your dealer of the manner in which the power indicator is blinking.

Turn the main power switch to OFF and remove the power plug from the receptacle.

The manner in which the power indicator blinks identifies the location of the problem.

- The packing material for this unit is for one-time use only. Repeated use could result in a damaged panel.
- Viewing the screen constantly for extended periods can strain your eyes. Be sure to stay at a proper distance (at least 1.5 m or 5 feet) from the screen and to look occasionally away it while working.
- Have the display inspected and cleaned by your dealer at regular intervals.



# CLEANING AND MAINTENANCE

## Precautions

Be sure to remove the power plug from the receptacle before cleaning the display.

Be sure not to clean the display using a cloth dampened with volatile solvents, such as benzene or thinner. Such solvents can harm the display's cabinet, the filter at the screen front, and the remote control. They can also cause paint to come off these sections.

## Cleaning the Cabinet and Remote Control

Use a soft cloth for cleaning.

If the cabinet or remote control is heavily stained, soak a soft cloth in a mixture of water and detergent and squeeze it dry before wiping off the stains. Use a soft, dry cloth for final cleaning.

## Cleaning the Screen

Clean the screen gently with a soft cloth.

The screen surface is fragile. Never attempt to clean it with a hard material, press on it forcefully, or tap it.

## HANDY TIPS

In the event of problems with the display, check the following explanations before contacting your dealer for servicing.

Problem	Action
• Power does not turn ON.	• Check whether the main power switch is turned to ON.
• No images are displayed.	• Check cables for disconnection. • Check whether the power for all input equipment is ON. • Check for connection to wrong terminals or for wrong input mode.
• Remote control does not function properly.	• Check whether the remote control is being operated within the reception range of the display shown on page E-15. • Check for any obstacle between the remote control and the display.
• There are spots on the screen.	• Check whether your AV equipment is affected by interference from automobiles, trains, high-voltage transmission lines, neon signs or other potential sources of interference.
• Degraded colors/tints	• Check whether all image adjustments have been properly made. (See "Adjusting Images" on P. E-28-E-29.)
• Improper screen position/size	• Check whether screen position and size have been properly adjusted. (See "Adjusting Screen Position and Size" on P. E-32-E-33.)
• No sound from the built-in speakers	• Check whether you have set the display for use of internal speakers. (See "Adjusting Sound" on P. E-30-E-31.)
• No sound from external speakers	• Check cables for disconnection. • Check whether you have set the display for use of external speakers. (See "Adjusting Sound" on P. E-30-E-31.)
• No sound	• Check whether you have selected "No audio" for the "Audio input" setting. (See "Extended Features" on P. E-37-E-41.)
• If "Invalid operation" appears.	• Check whether you have selected "Input priority". (See "Extended Features" on P. E-37-E-41.)
• If "Out of range" appears, the display is receiving a signal whose image or signal cannot be reproduced by the display.	• Input proper signals. Make sure that the vertical frequency of the input signal is 60 Hz both for SVGA and XGA.
• The display makes a snapping sound.	• This sound is produced when the cabinet expands or contracts due to variations in temperature. This sound does not indicate that the display has a problem.
• The display makes a buzzing sound.	• The display has a fan to maintain the temperature of internal components at a constant level. This sound is produced by the fan as it rotates.



# INSTALLATION

To prevent the display's internal components from overheating, make sure that the display is installed in a well-ventilated location.

Be sure to use the (optionally available) stand, wall-mounting unit or the other unit when installing the display. Also, be also sure that your dealer performs the actual installation.

See the appropriate instruction manual for more information on the installation hardware you select.

To ensure proper heat radiation, provide at least as much space around the display as shown below.

- \* Make sure that the display is installed in a location where the temperature can be maintained between 0°C and 40°C.
- \* Never attempt to tilt the display sideways or backward.
- \* To prevent the power and other cables from being accidentally pulled, make sure that they run along the wall or through corners.
- \* The display can be installed with either of its sides facing down.

When using the stand

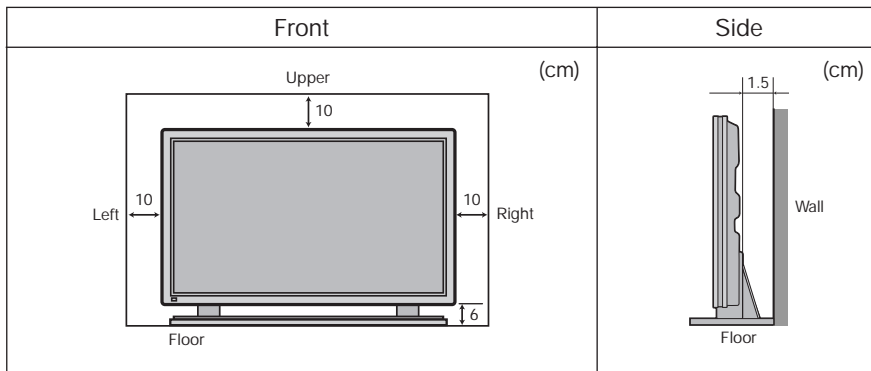

When using the wall-mounting unit (horizontal type)

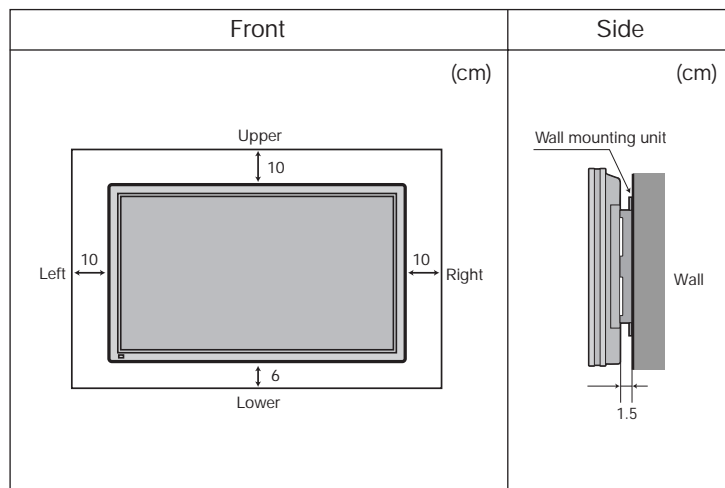

When using the wall-mounting unit (vertical type)

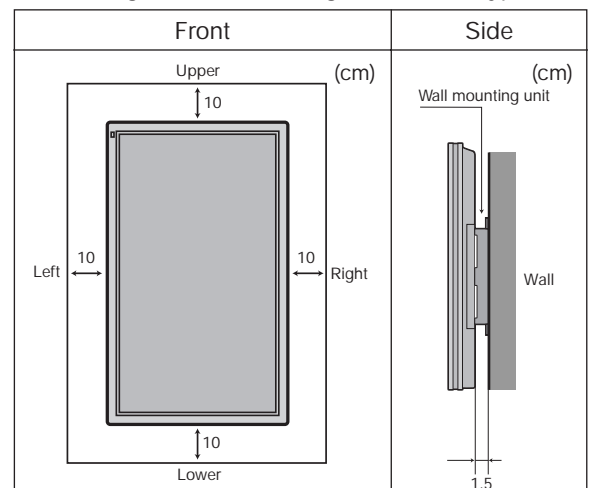

\* When you install the display lengthwise (rather than in its normal position), you need to adjust the display so that characters will appear properly. (See P. E-38-E-41 for extended features.)

## Note

Grounding work is necessary if the receptacle is intended for exclusive use in the two-wire circuit.

## Reference

See P. E-44 for more information on options.

# SAFETY MEASURES

To prevent accident and ensure safety in the event of an earthquake, fix the display securely into position as described below.

## FIXING THE DISPLAY TO A WALL OR PILLAR

You need two strong cords.

- ① Attach a bracket to each hole at the rear of the display  
To do this, use screw A (10 mm long) to attach safety bracket A, supplied with the display, to the hole at the rear of the display.
- ② Attach two brackets to the wall  
To do this, use screws B (20 mm long) to attach safety brackets B, supplied with the display, to the wall.  
\* To make sure that the display is stable, attach wall brackets at the same height as (or slightly lower than) the display brackets.
- ③ Tie brackets A and B together  
To do this, use strong cords to fix the display securely to the wall.

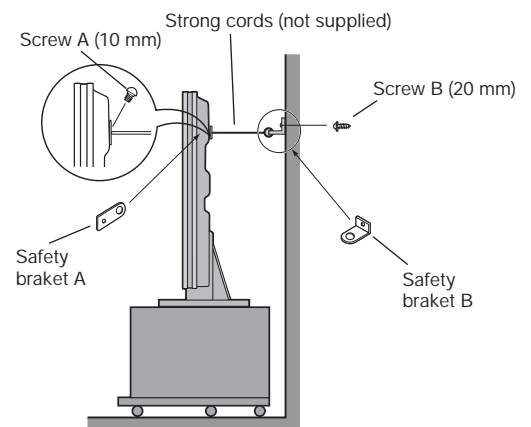
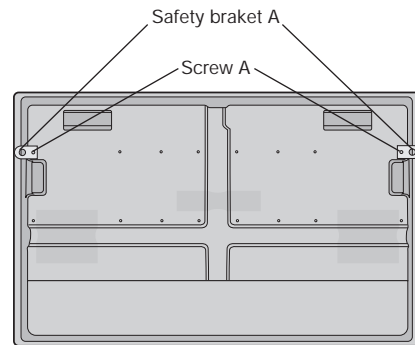

## FIXING THE DISPLAY TO THE STAND

Use two screws, supplied with the stand, to fix the display using the holes provided at the rear of the stand.

See the instruction manual for the stand (P-42TT11 type) for more information.

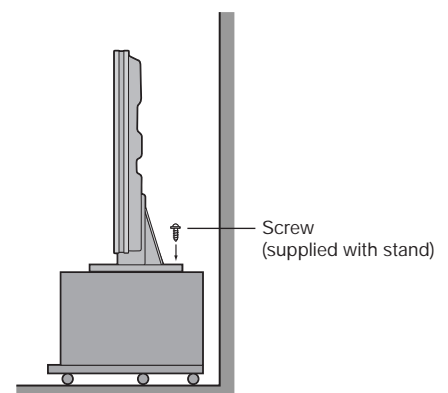

# ACCESSORIES

## CHECKING ACCESSORIES

One connector cover

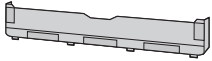

One remote control



One strap  
(for remote control)



Two AA batteries  
(for remote control)

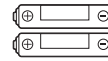

One user's manual



Four safety brackets  
(types A x 2, type B x 2)

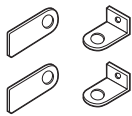

Four screws  
(screw A x 2, screw B x 2,  
for brackets that prevent  
the unit from falling over)

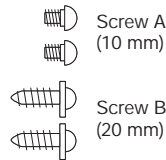

Two ferrite cores  
(with wire clampers)

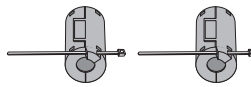

Two cable clampers



Three power cables



## HOW TO USE ACCESSORIES

### Cable clampers

Use the supplied cable clampers to bind the display's signal or power cables. Use them as shown in the figure when mounting the display on the wall, using the wall-mounting unit, or hanging it from the ceiling using the hanging unit.

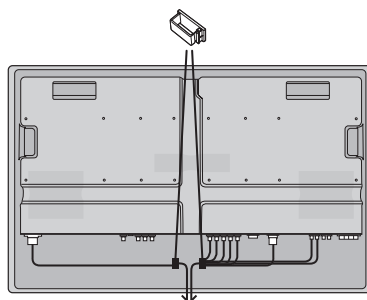

When you run signal cables downwards

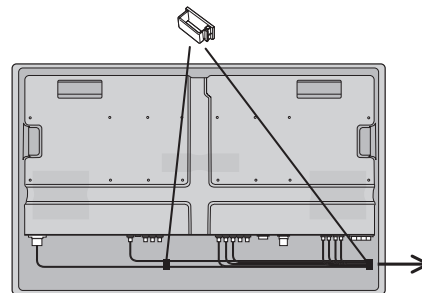

When you run signal cables to the right

### Connector cover

When you finish binding the cables using the cable clampers, you need to attach the connector cover to the display.

To do this, use nippers to cut out a section of the connector cover such that the cables can be pulled out through that section. Then attach the cover to the display.

When attaching the connector cover, make sure that the upper and lower projections on the cover fit properly into the corresponding sections on the display.

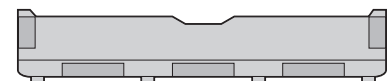

Projections (to be fit into corresponding sections on the display)

### Information

Cables for connecting the display to external equipment are not supplied. Contact your dealer for more information on these products.

# PART NAMES AND FUNCTIONS

## Front

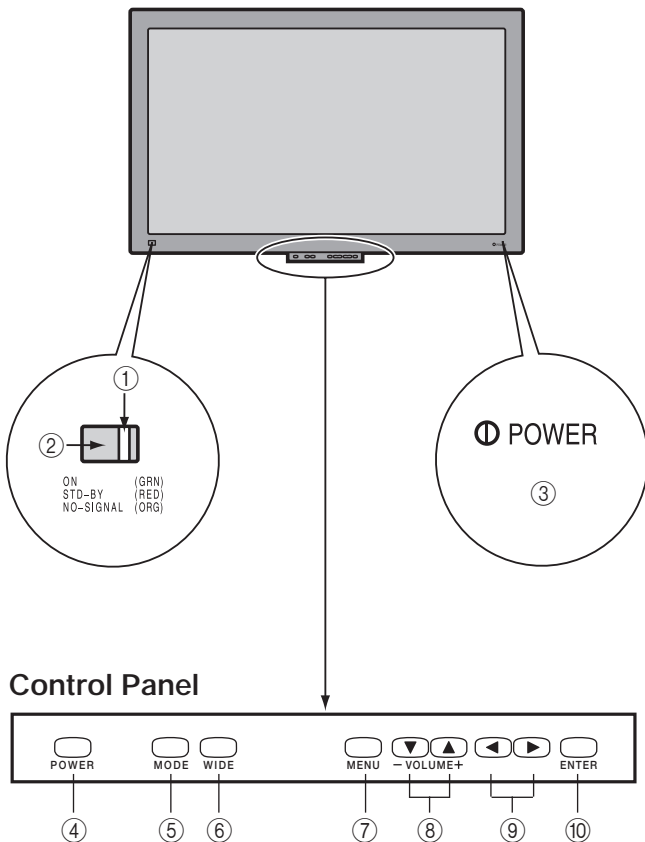

The control panel opens when you press the lower center of the display.

If you press the display again, the control panel closes.

### ① Power indicator lamp

This lamp shows whether the main power is ON or OFF, as follows:

Lit (red): Standby

Lit (green): Power ON

Lit (orange): Power saving (DPMS: Power saving function) mode ON

Flashing (red): Malfunction (Flashes differently depending on the type of malfunction. See P. E-6 for more information.)

### ② Remote control signal receiver

Receives signals from the remote control.

### ③ Main Power Switch Indicator

Indicates the location of the Main Power switch, at the bottom of the display.

### ④ Power button [POWER]

Turns the power ON or OFF when the main power switch, provided at the bottom of the display, is ON.

### ⑤ Input mode selector button [MODE]

Switches between image input modes.

### ⑥ Wide screen selector button [WIDE]

Switches the screen over to a desired wide screen.

### ⑦ Menu button [MENU]

Displays image and sound adjustment menus.

### ⑧ Volume adjustment buttons [VOLUME +/-]

Adjust the volume.

Note: The [▼/▲] buttons can also be used to scroll through the options when a menu is displayed.

### ⑨ Adjustment buttons [◀/▶]

The [◀/▶] buttons can also be used to scroll through options in a menu, or to change values.

### ⑩ Set button [ENTER]

Press this button to finalize the selection of a desired option in a menu.

## Warning

The protective circuit built into the display automatically turns the power to OFF if the display has an internal problem. At this time, the power indicator blinks red, indicating that the display is somehow faulty. If you continue using the display as is, fire or electric shock may result. Be sure to first remove the power plug from the receptacle and to contact your dealer immediately.

## Bottom

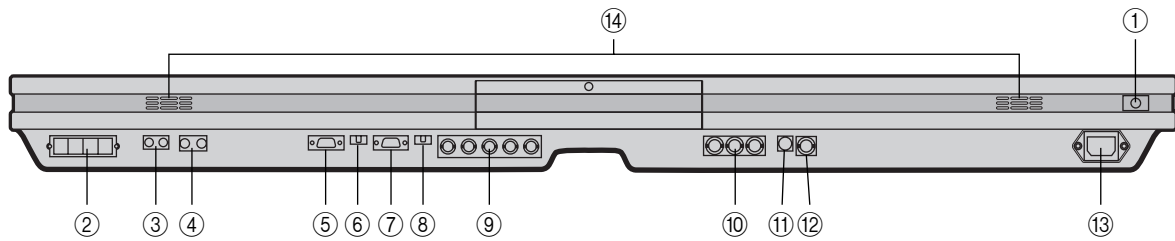

① **Main power switch**

Press this switch when the power is OFF to turn it ON. When you do so, the power indicator lamp will become red, indicating that you can turn ON or OFF the power to the display using either the remote control or the display's control panel.

Press this switch when the power is ON to turn it OFF.

② **External speaker output terminal (EXT SP)**

Connect this terminal to the optionally available speaker. (Use a speaker with 4 to 16  $\Omega$ .)

When connecting cables, attach ferrite cores to both the R and L cables. (See P. E-16.)

\* See the speaker instruction manual for more information.

③ **Sound1 input terminal (AUDIO 1 INPUT)**

Connect this terminal to the sound output terminal of your VCR, PC, etc.

④ **Sound2 input terminal (AUDIO2 INPUT)**

Connect this terminal to the sound output terminal of your VCR, PC, etc.

⑤ **RS-232C terminal (RS-232C)**

This terminal is provided for you to control the display from the PC. Connect it to the RS-232C terminal on the PC.

\* No RS-232C cable is supplied with the display. The type of cable to be used varies depending on the PC model. Contact your dealer for more information.

\* When using an RS-232C cable, be sure to use a straight cable.

⑥ **RGB1 synchronization switch (SYNC SW1 TTL/ANALOG (75  $\Omega$ ))**

This switch is used to terminate pins 13 and 14 of the RGB1 terminal with 75  $\Omega$  respectively for receiving horizontal (H) and vertical (V) synchronization signals.

TTL: Used when sending RGB signals from the PC to the RGB1 terminal

ANALOG (75  $\Omega$ ): Used when sending analog synchronization signals to the RGB1 terminal

⑦ **RGB1 input terminal (RGB1 INPUT/mD-sub)**

Connect this terminal to the PC's display (analog RGB) output terminal.

\* No RGB cable is supplied with the display. The type of cable to be used varies depending on the PC model. Contact your dealer for more information.

⑧ **RGB2 synchronization switch (SYNC SW2 TTL/ANALOG (75  $\Omega$ ))**

This switch is used to terminate the RGB2 terminal with 75  $\Omega$  for receiving horizontal (H) and vertical (V) synchronization signals.

TTL: Used when sending RGB signals from the PC to the RGB2 terminal

ANALOG (75  $\Omega$ ): Used when sending analog synchronization signals to the RGB2 terminal

⑨ **RGB2 input terminal (RGB2 INPUT/BNC x 5)**

Connect this terminal to the PC's display (analog RGB) output terminal.

\* No RGB cable is supplied with the display. The type of cable to be used varies depending on the PC model. Contact your dealer for more information.

# PART NAMES AND FUNCTIONS (Continued)

⑩ **Component video input terminal (COMPONENT VIDEO INPUT)**

Connect this terminal to the component video output (color difference output) terminal of your HDTV unit or DVD player.

⑪ **S-video input terminal (S-VIDEO INPUT)**

Connect this terminal to the S-video output terminal of your VCR or video disk player.

⑫ **Video input terminal (VIDEO INPUT)**

Connect this terminal to the video output terminal of your VCR or video disk player.

⑬ **Power input terminal**

Connect this terminal to the power cable supplied with the display.

⑭ **Built-in speaker**

Produces sound received through the sound input terminal.

## Description of Input Terminals

RGB1 input terminal (RGB1 INPUT/mD-sub)

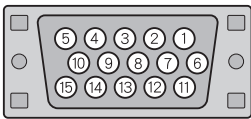

Pin No.	Input signal	Pin No.	Input signal
1	Red	9	—
2	Green	10	Ground
3	Blue	11	—
4	—	12	—
5	Ground	13	Horizontal (H) synchronization
6	Ground	14	Vertical (V) synchronization
7	Ground	15	—
8	Ground	Frame	Ground

\* Use the RGB1 synchronization switch to switch between TTL and ANALOG depending on the types of horizontal (H) and vertical (V) synchronization signals received through pins 13 and 14, respectively.

RS-232C terminal (RS-232C)

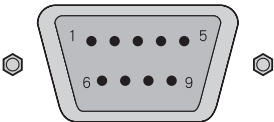

Pin No.	Signal
1	DCD (Data Carrier Detect)
2	RD (Received Data)
3	TD (Transmit Data)
4	DTR (Data Terminal ready)
5	GND (Ground)
6	DSR (Data Set Ready)
7	RTS (Request To send)
8	CTS (Clear To Send)
9	RI (Ring Indication)

## Setting signals

This display can store parameter settings for eight additional signals for both RGB1 and RGB2.

To do this, select a desired signal and follow the instructions in “Adjusting Screen Position and Size” on P. E-30–E-31 to adjust the parameters. When you finish, the settings will be automatically stored. Thus, when the display receives that signal, images will be displayed in accordance with the settings you most recently selected.

This display has been factory-set to provide screen setting values for seven different signals (see Table below).

Factory-set signals (RGB1, RGB2 modes)

Display (dots x lines)	Horizontal frequency (kHz)	Vertical frequency (Hz)	Signal
852 x 480	31.72	59.97	When a dedicated graphics card is used
640 x 480	31.47	59.94	VGA
640 x 400	37.88	60.32	SVGA 60 Hz
1024 x 768	48.36	60.00	XGA 60 Hz
848 x 480	31.02	60.00	
640 x 480	15.73	59.94	60 fields
640 x 480	15.63	50.00	50 fields
User setting (eight varieties each for the RGB1 and RGB2 modes)	15.63 to 80.00*	50.00 to 120.00*	

\* With some input signals, “Out of range” may appear even when the horizontal and vertical frequencies are within their permissible ranges. Images may become blurred, and the message “Change refresh rate to 60 Hz” may appear if the vertical frequency is outside the 48.3 to 51.8 or 58.4 to 61.4 Hz ranges. In this case, change your PC settings.

In the Comp.video and Video/S-video modes, the display has been factory-set as follows for different input signals:

Factory-set signals (Comp.video mode)

Horizontal frequency (kHz)	Vertical frequency (Hz)	Signal
15.73	59.94	SDTV 525i
15.63	50.00	SDTV 625i
31.47	59.94	SDTV 480p
45.00	60.00	HDTV 720p
44.96	59.94	HDTV 720p
33.75	60.00	HDTV 1080i
33.72	59.94	HDTV 1080i

Factory-set signals (Video, S-video mode)

Horizontal frequency (kHz)	Vertical frequency (Hz)	Signal
15.73	59.94	NTSC
15.63	50.00	PAL
15.63	50.00	SECAM
15.73	59.97	4.43NTSC
15.73	59.97	M-PAL
15.63	50.00	N-PAL

- “The applicable frequency range” appears if the display receives a signal whose characteristic does not fall within the display’s permissible range.
- You can check input signals through “Status” on the OTHERS Menu screen. (See P. E-34–E-36.)
- All terms (i.e., company and product names) used in this document are trademarks or registered trademarks.



# PART NAMES AND FUNCTIONS (Continued)

## Remote Control

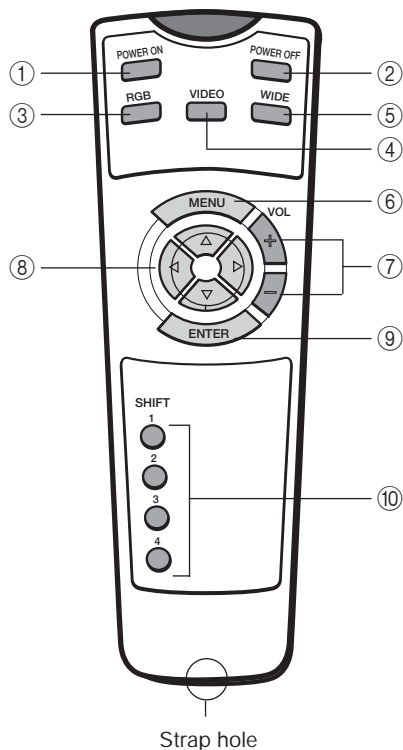

- ① **Power ON button [POWER ON]** → (See P. E-18.)  
Turns the power ON.
- ② **Power OFF button [POWER OFF]** → (See P. E-18.)  
Turns the power OFF.
- ③ **RGB input mode selector button [RGB]** → (See P. E-19.)  
Switches between RGB input modes.
- ④ **Video input mode selector button [VIDEO]** → (See P. E-19.)  
Switches between video input modes.
- ⑤ **Wide screen selector button [WIDE]** → (See P. E-20-E-21.)  
Switches the screen over to a desired wide screen.
- ⑥ **Menu button [MENU]** → (See P. E-22-E-41.)  
Use this button to display a desired menu for adjusting the image and sound.
- ⑦ **Volume adjustment buttons [VOL +/-]** → (See P. E-18.)  
Adjust the volume.  
Press the + button to increase the volume.  
Press the - button to reduce the volume.
- ⑧ **Adjustment buttons [◀ / ▶ / ▲ / ▼]** → (See P. E-22-E-41.)  
Use these buttons to scroll through options in a menu and change values.
- ⑨ **Enter button [ENTER]** → (See P. E-22-E-41.)  
Press this button to finalize the selection of a desired menu or option within a menu.
- ⑩ **Display selector buttons [SHIFT 1-4]** → (See P. E-37-E-41.)  
When you use two or more displays, you can use these buttons to control up to four displays by assigning a unique number to each of the displays.

## PUTTING BATTERIES IN THE REMOTE CONTROL

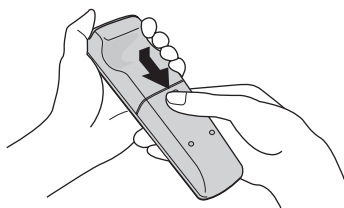

- ① To remove the cover, slide it outwards while pressing it down.

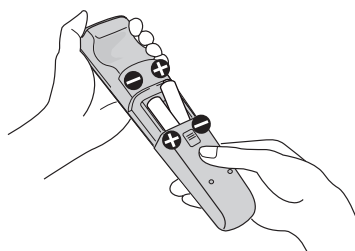

- ② Put two AA batteries in the remote control. Make sure that the batteries are properly oriented.

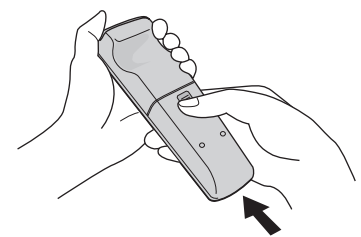

- ③ Close the cover until it snaps into place.

### Note

The remote control will not function properly if the batteries are dead. Be sure to replace them as needed. Make sure that you use replace the batteries with new ones; also, be sure to use replacement batteries of the same type as the original ones.

# USING THE REMOTE CONTROL

## PRECAUTIONS

To prevent malfunction, be sure not to apply any form of severe shock to the remote control.

To prevent malfunction or deformation, be sure not to allow the remote control to become wet; also, keep it away from hot locations or heating equipment.

Be sure not to clean the remote control using a cloth dampened in any volatile solvent, such as benzene or thinner.

## EFFECTIVE RANGE FOR THE REMOTE CONTROL

Point the remote control at the display's signal receiver when using it.

Make sure that there are no obstacles between the remote control and the display's signal receiver.

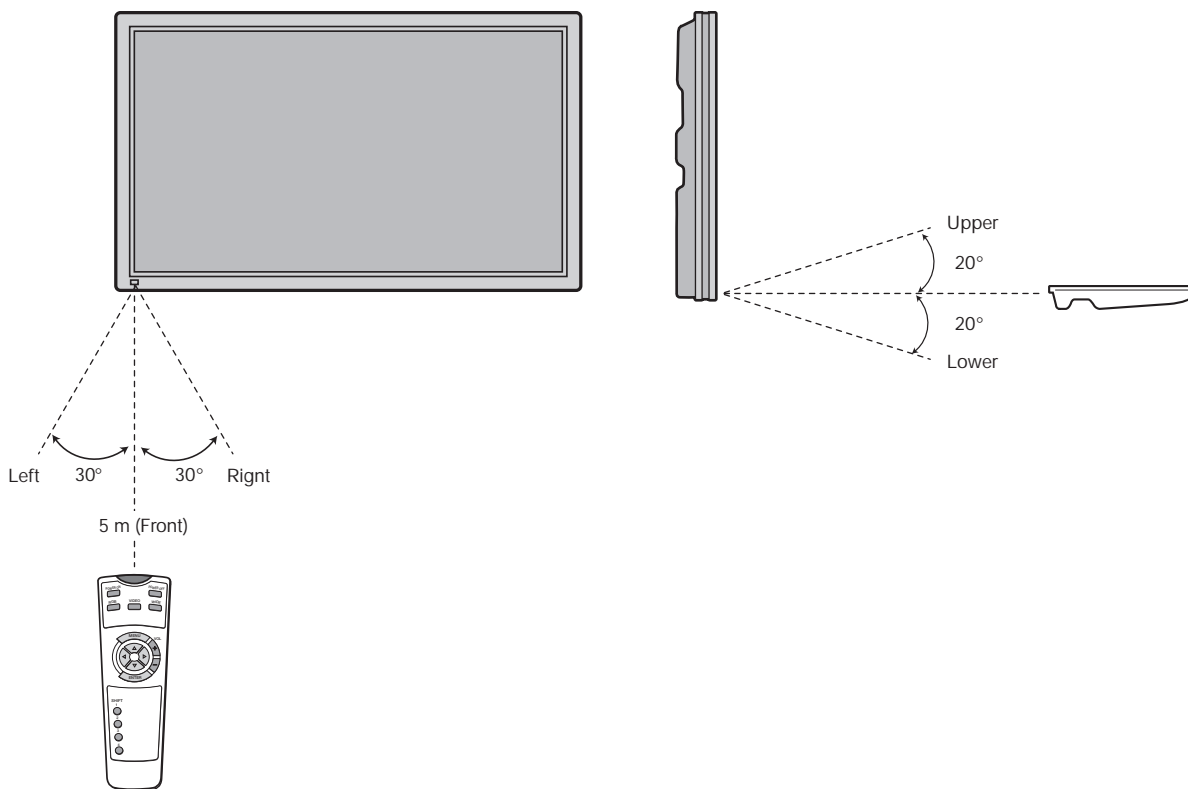

### Information

The remote control may not function properly if you use a high-frequency fluorescent lamp. If you experience problems, move the lamp or use the remote control from a different position.

# CONNECTING THE DISPLAY TO EXTERNAL EQUIPMENT

Be sure to turn OFF the power to the display and external equipment before making any connections.

**No cables are supplied with the display for connection to external equipment.** The type of cable to be used varies depending on the PC model. Contact your dealer for more information.

## RECEPTACLE

Make sure that the power cable's grounding wire is grounded.

The display comes with a 3-prong power plug; one prong is connected to the grounding wire. If you have only a 2-hole receptacle, **you will need to have it replaced.** Contact your dealer for more information.

## CONNECTING THE DISPLAY TO EXTERNAL EQUIPMENT

Carefully check the terminals for position and type before making any connections.

Loose connectors can result in image or color problems. Make sure that all connectors are securely inserted into their terminals.

When you complete connection, route the cable and secure it with the cable clumper. Then, reinstall the connector cover.

Terminal	Connector
VIDEO INPUT	BNC
S-VIDEO INPUT	S terminal
COMPONENT VIDEO INPUT	BNC x 3
RGB INPUT	mD-sub 15-pin BNC x 5
AUDIO INPUT	Pin jack
RS-232C	D-sub 9-pin

### Two ferrite cores (with wire clampers)

These ferrite cores with wire clampers are used to attenuate undesired signals.

When connecting a cable to the external speaker output terminal, attach one of these ferrite cores to the cable near the terminal.

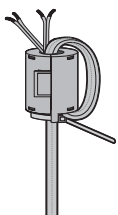

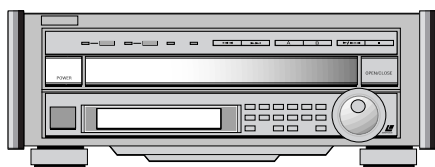
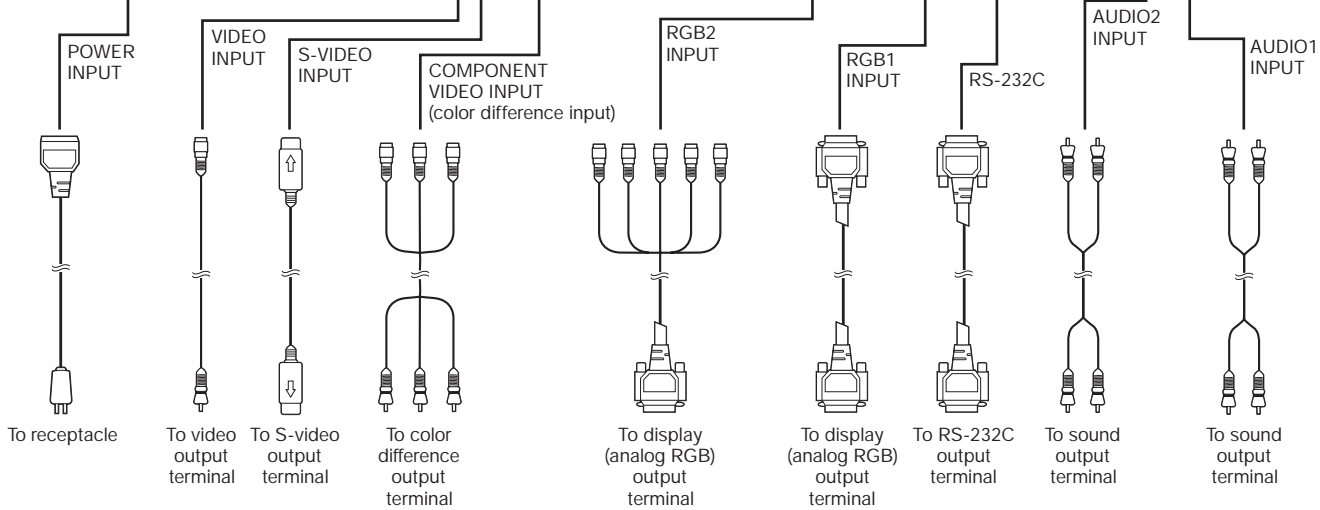
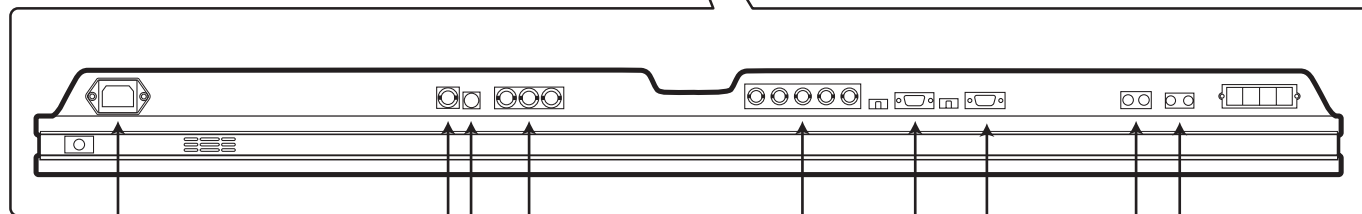
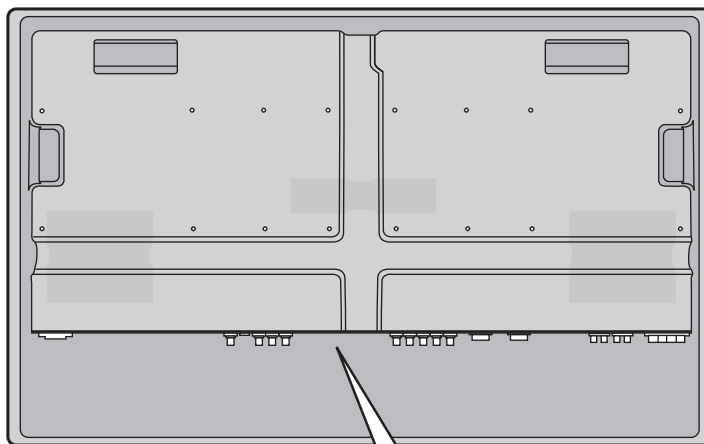

Connection to AV equipment

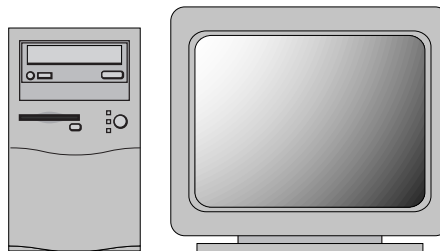

Connection to PC

# BASIC OPERATIONS

## TURNING ON THE POWER

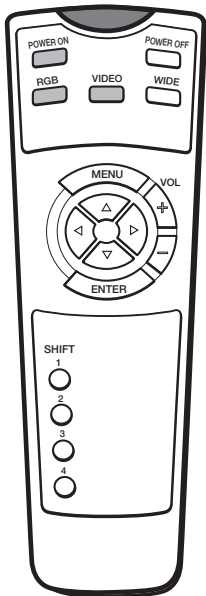



- 1** Press the main power switch at the bottom of the display.

When you do so, the main power turns ON and the power indicator lamp turns red.

- 2** Press  on the remote control.

When you do so, the power indicator lamp turns green.

- 3** Press  or  to select a desired input mode.

\* You can also use the switches on the display's control panel to accomplish these steps.

## TURNING OFF THE POWER

Press  when the power is ON.



The power indicator lamp turns red.

## ADJUSTING THE VOLUME

Press  to increase the volume.

Press  to reduce the volume.

Any value between 0 and 40 can be selected.

\* "Speaker off" appears if you press  or  after you have selected "No audio" for "Audio input". (See P. E-37-E-41.)

\* Note that the volume level remains stored even when you turn OFF the power.

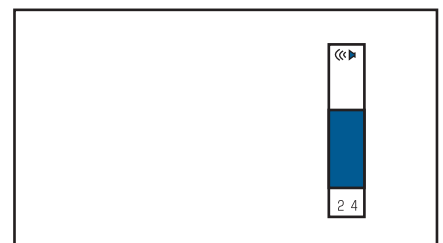

When the volume adjustment button is pressed

# SELECTING INPUT MODE

## VIDEO INPUT MODE

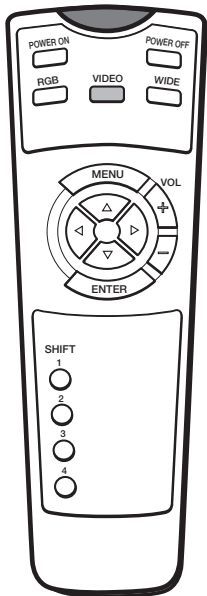

**1** Press  to select a desired input mode.

Each time you press , a different input mode appears. The sequence is as follows:

▶ Video → S-video → Comp.video ◀

**Video:** Displays images from equipment connected to the Video terminal.

**S-video:** Displays images from equipment connected to the S-video terminal.

**Comp.video:** Displays images from equipment connected to the component video input terminal.

\* You can switch between video input modes while you are in RGB input mode.

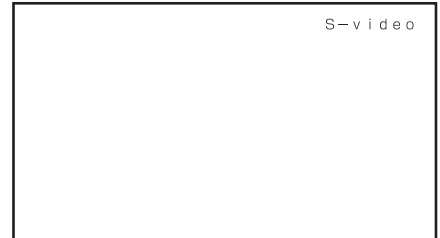

S-video mode



Comp.video mode

\* You can also use the switches on the display's control panel to accomplish these steps.

## RGB INPUT MODE

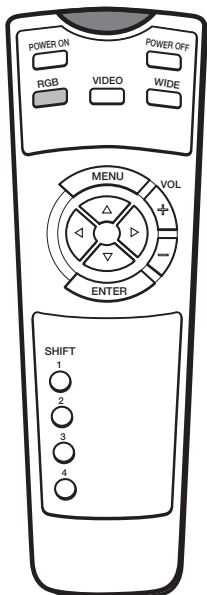

**1** Press  to select a desired input mode.

Each time you press , a different input mode appears as follows:

▶ RGB1 → RGB2 ◀

**RGB1:** Displays images from equipment connected to the RGB1 (mD-sub) terminal.

**RGB2:** Displays images from equipment connected to the RGB2 (BNC x 5) terminal.

\* You can switch between RGB input modes while you are in a video input mode.



RGB1 mode



RGB2 mode

\* You can also use the switches on the display's control panel to accomplish these steps.

# WATCHING IMAGES ON THE WIDE SCREEN

## SWITCHING BETWEEN SCREEN SIZES

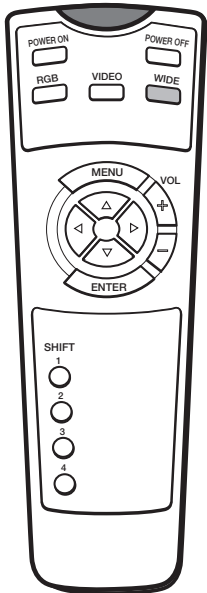

**1** Press .

The currently selected mode will appear.

**2** Press  to select a desired image mode.

Each time you press , a different image mode appears. The sequences used are as follows:

When you are in a video input mode

➔ Normal ➔ Auto ➔ Wide1 ➔ Wide2  
Zoom2 ← Zoom1 ←

When you are in an RGB input mode

➔ Normal ➔ Wide ➔ Zoom

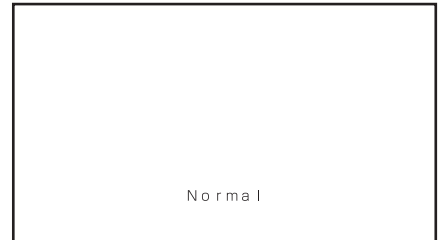

Normal mode



Wide1 mode

\* You can also use the switches on the display's control panel to accomplish these steps.

### Information

- You cannot select Auto mode when you are in Comp.video mode (video input mode).
- You may not be able to watch images clearly in Auto mode, depending on the contents of the image software you use. If you experience problems, use  to switch to a mode that provides the optimum screen size.
  - \* With some games, the zoom screen (with upper and lower unviewable areas) may be selected.
  - \* With some images of standard size (i.e., 4 (frame width) x 3 (frame height)), the zoom screen may be selected if the upper and lower sections of the image in a scene are extremely dark.
  - \* Some images are designed such that the zoom screen is automatically selected as necessary. With some of these images, however, the screen size may not be immediately switched over to the zoom screen if the first scene contains an extremely dark image.

### Note

- A variety of image modes are available with this display. Remember that if you select a mode with an aspect ratio (ratio of frame width to frame height) different from that of the TV program or video media, the images will appear differently than if you had selected a mode having the same aspect ratio.
- Showing a movie or similar premium event at a different aspect ratio from its original one at any event site, restaurant, or bar for profit-making purposes or for a public audience may constitute a copyright infringement.  
For films, try to select a mode having the same aspect ratio as the original image; this enables the director's original intentions to be preserved.

### Reference

See P. E-30–E-31 for how to adjust the image size and position.



## SCREEN SIZE

### Normal

Displays images of normal size (i.e., a 4:3 aspect ratio).

### Auto (Video Input Mode)

The screen size changes automatically in accordance with the contents of image software you use.

\* You cannot select this mode if you have selected the Comp.video mode for input mode.

### Wide1 (Video Input Mode)

Displays natural-looking images of standard size on the wide screen.

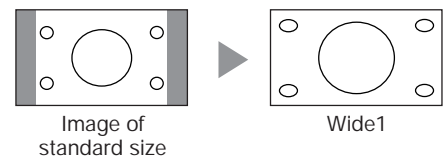

### Wide2 (Video Input Mode)/Wide (RGB Input Mode)

Reduces the aspect ratio of images from 16:9 to 4:3.

Ideal for displaying vertically extended images such as squeezed images and recorded HDTV programs.

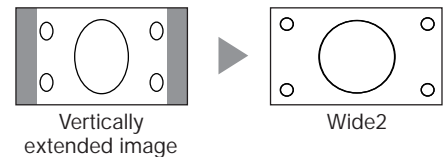

### Zoom1 (Video Input Mode)/Zoom (RGB Input Mode)

Enlarges horizontally extended images equally in all directions to maintain the aspect ratio constant.

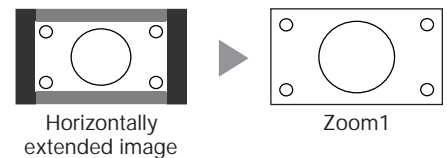

### Zoom2 (Video Input Mode)

Reduces the height of horizontally extended images with captions, without eliminating the caption. Only the height of images is reduced, not the height of the caption.

(Captions may not be easy to read, however, depending on the image.)

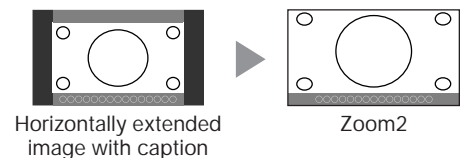

## ASPECT RATIO

The following aspect ratios are available.

4:3 aspect ratio  
(VHF/UHF broadcasting, BS broadcasting)

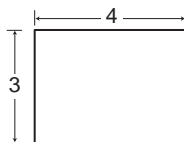

16:9 aspect ratio  
(HDTV broadcasting, EDTV II  
(enhanced definition television II))

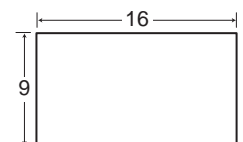

1.85:1 aspect ratio  
(Vista Vision size)

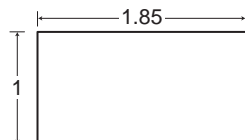

2.35:1 aspect ratio  
(Cinema Vision size)

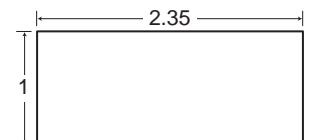

### Information

You may find dark areas on top and at the bottom of the screen if you select one of the Zoom modes for media while using the Vista Vision or Cinema Vision size i.e., the sizes used frequently for image software.

# HOW TO USE MENUS



## SELECTING OPTIONS IN A MENU

Use the [MODE] button on the display or  and  on the remote control to select a desired input mode.

**1** Press .

The main menu screen will appear.

**2** Press  or  to switch between subordinate menus.

Each time you press  or , one of the available menus appears.

**3** Press  or .

The corresponding menu screen will appear.

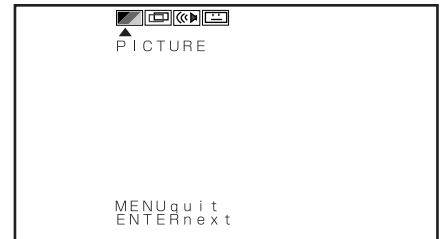

Ex.: "PICTURE" selected in the main menu screen

A total of four different menus (PICTURE, POSITION/SIZE, SOUND, OTHERS) are available.

You can easily distinguish between these menus as shown below.



PICTURE



POSITION/SIZE



SOUND

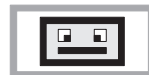

OTHERS

\* Do not change input signals when any of the menus is displayed.

## USING THE PICTURE MENU



When you finish selecting a desired option in the PICTURE menu screen, press **ENTER** or **↵**.

At this time, the adjustment/setup screen for that option will appear.

You can use **←** or **→** to change the value for the option. (See P. E-28–E-29.)

Changes you make will be stored only for the selected mode.

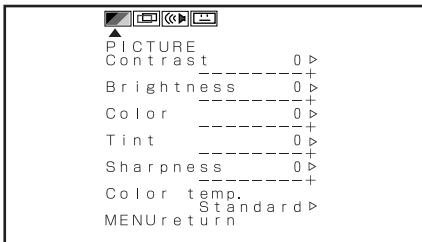

PICTURE Menu screen (Video Input Mode)

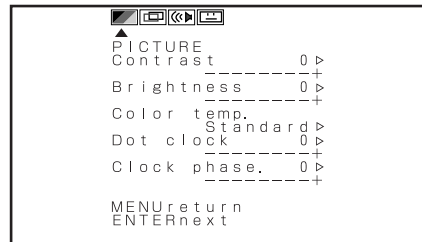

PICTURE Menu screen (RGB Input Mode)

Option	Function	Operation	Range
(1) Contrast	Adjusts image contrast.	↵: Higher contrast ↵: Lower contrast	-30 to +30
(2) Brightness	Adjusts screen brightness.	↵: Brighter screen ↵: Darker screen	-60 to +60
(3) Color	Adjusts color darkness.	↵: Darker colors ↵: Lighter colors	-60 to +60
(4) Tint (for Video, S-video, Comp.video)	Adjusts tint.	↵: More green-tinged colors ↵: More purple-tinged colors	-30 to +30 (Video, S-video) -60 to +60 (Comp.video)
(5) Sharpness (for Video, S-video, Comp.video)	Adjusts image sharpness.	↵: Sharper images ↵: Less sharp images	-30 to +30 (Video, S-video) -3 to +3 (Comp.video)
(6) Color temp.	Adjusts color temperature.	Use <b>←</b> or <b>→</b> for switching.	Warm/Standard/Cool
(7) Dot clock (for RGB1, RGB2)	Adjusts the dot clock.	Eliminates blur when the optimum value is selected with <b>←</b> or <b>→</b> .	-60 to +60
(8) Clock phase (for RGB1, RGB2)	Adjusts clock phase.	Eliminates blur when the optimum value is selected with <b>←</b> or <b>→</b> .	0 to 15

# HOW TO USE MENUS (Continued)

## USING THE POSITION/SIZE MENU



When you finish selecting a desired option in the POSITION/SIZE menu screen, press or .

When you do so, the adjustment screen for that option appears.

You can use , , , and to change the value for the option. (See P. E-30–E-31.)

Changes you make will be stored only for the selected mode.

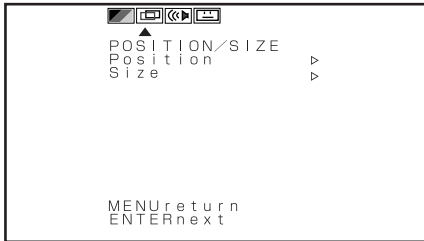

POSITION/SIZE Menu screen

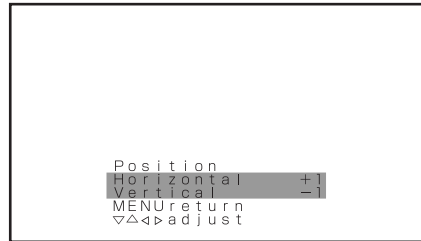

"Position" adjustment screen

Option	Function	Operation	Range
(1) Position	Adjusts screen position.		Video, S-video Horizontal: -30 to +30 Vertical Zoom: -15 to +15 Others: -7 to +7 Comp.video: -16 to +16 RGB1, RGB2: -150 to +150
Horizontal	Adjusts horizontal position.	: Moves screen to the right. : Moves screen to the left.	
Vertical	Adjusts vertical position.	: Moves screen up. : Moves screen down.	
(2) Size	Adjusts screen size.		Video, S-video: -7 to +7 Comp.video: -4 to +4 RGB1, RGB2: -25 to +50
Width	Adjusts width.	: Increases width. : Reduces width.	
Height	Adjusts height.	: Increases height. : Reduces height.	

## USING THE SOUND MENU



When you finish selecting a desired option in the SOUND menu screen, use or to change the value for that option. (See P. E-32–E-33.)

Changes you make will be stored only for the selected mode.

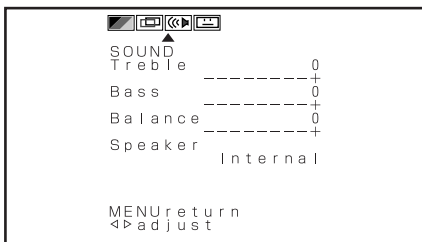

SOUND Menu screen

Option	Function	Operation	Range
(1) Treble	Adjusts treble.	: Stronger treble : Weaker treble	-6 to +6
(2) Bass	Adjusts bass.	: Stronger bass : Weaker bass	-6 to +6
(3) Balance	Adjusts volume balance.	: Higher volume from right-hand speaker : Higher volume from left-hand speaker	-10 to +10
(4) Speaker	Selects built-in or external speakers.	Use  or  for switching.	Internal (built-in speakers) External (external speakers)

# HOW TO USE MENUS (Continued)

## USING THE OTHERS AND EXTENDED MENUS



### • Options with “▷” on the right

When you select an option with “▷”, press or . The adjustment/setup screen for that option appears.

You can use or on this screen to make selections or changes.

### • Options with no “▷” on the right

When you select an option with no “▷”, press or to make selections or changes. (See P. E-34–E-41.)

Changes you make will be stored only for the selected mode.

## OTHERS Menu

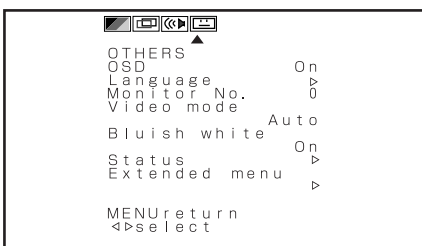

OTHERS Menu screen (Video Input Mode)

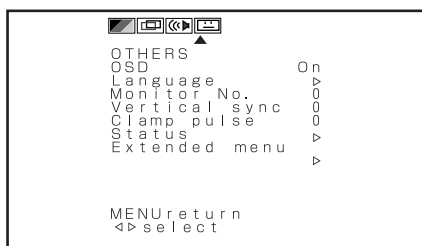

OTHERS Menu screen (RGB Input Mode)

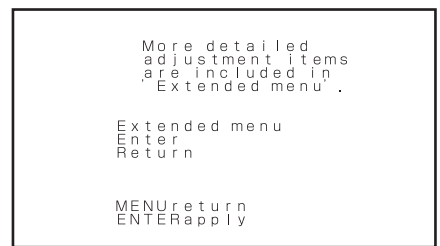

Extended menu message screen

Option	Function	Operation	Range
(1) OSD	Selects whether to display information other than menus.	Use  or  for switching.	On (displayed) Off (not displayed)
(2) Language	Selects language used for menus.	Display the “Language” selection screen and use  or  to select a language. Press  to display menus in the selected language.	English Deutsch (German) Español (Spanish) Français (French) Italiano (Italian) Português (Portuguese)
(3) Monitor No.	Selects display number.	Use  or  for switching.	0 (no setup) 1/2/3/4
(4) Video mode (for Video, S-video)	Selects video mode.	Use  or  for switching.	Auto/NTSC/PAL/SECAM/ N-PAL/M-PAL/4.43NTSC
(5) Vertical sync (for Comp.video, RGB1, RGB2)	Corrects vertical synchronization signal.	Use  or  to select the optimum value for eliminating flicker.	-2 to +1
(6) Clamp pulse (for Comp.video, RGB1, RGB2)	Adjusts clamp pulse.	Use  or  for switching.	0 to 8
(7) Bluish white (for Video, S-video)	Makes white areas appear even whiter.	Use  or  for switching.	On (enabled) Off (disabled)
(8) Status	Displays system operation status.	Displays the “Status” information screen. Press  to update the status.	Display only
(9) Extended menu	Extended features (Extended menu)	Displays a message screen. Enter: Displays Extended menu screen. Return: Returns to OTHERS Menu screen.	

## Extended menu

```

Extended menu
OSD rotate Normal
DPMS Off
White screen Off
Screensaver Off
Input priority >
Audio input Off
3D Y/C On
Studio mode Off
MENUreturn
<>select
  
```

Extended menu screen (Video Input Mode)































```

Extended menu
OSD rotate 1/2
DPMS Normal
White screen Off
Screensaver Off
Input priority >
Audio input Off
more>
MENUreturn
<>select
  
```

Extended menu screen (RGB Input Mode)

```

Extended menu
2/2
prev. Off
Studio mode Off
White peak level
calibration >
Sharpness 0
Gamma mode Still
VGA mode VGA
Freq. scan Auto
MENUreturn
<>select
  
```

Option	Function	Operation	Range
(1) OSD rotate	Rotates on-screen text.	Use  or  for switching.	-90 Deg. (counterclockwise)/ Normal/ +90 Deg. (clockwise)
(2) DPMS	Specifies time before DPMS starts.	Use  or  for switching.	Off (disabled) 1 min./3 min./5 min./10 min./ 30 min.
(3) White screen	Selects whether to display white over the entire screen.	Use  or  for switching.	Off (disabled) Link DPMS/On
(4) Screen saver	Sets up screen saver.	Display the "Screen saver" adjustment screen and use  or  to select an option. Use  or  to switch between available choices for the selected option.	Function Off (disabled) Time (every 1 hr) Mode (every time mode is switched) Moving area Narrow (moves in small range) Standard (moves in moderate range) Wide (moves in wide range)
(5) Input priority	Specifies input mode of highest priority.	Use  or  for switching.	Off/Video/S-video/ Comp.video/RGB1/RGB2
(6) Audio Input	Select sound input terminals.	Display the "Audio input" selection screen and use  or  to select an option. Use  or  to switch between available choices for the selected option.	Audio 1/Audio 2/No audio
(7) 3D Y/C (for Video (3.58NTSC))	Selects whether to enable the 3D Y/C circuit.	Use  or  for switching.	On (3D Y/C circuit) Off (3-line)
(8) Studio mode	Selects color temperature.	Use  or  for switching.	On (for broadcasting stations) Off (for general users)
(9) White peak level calibration (for RGB1, RGB2)	Adjusts brightness.	Display the "White peak level calibration" adjustment screen and use  or  to select an option.	Execute (execute) Original (factory setting) Cancel (cancel)
(10) Sharpness (for RGB1, RGB2)	Adjusts sharpness.	 : Sharper images  : Less sharp images	-3 to +3
(11) Gamma (for RGB1, RGB2)	Makes gamma correction.	Use  or  for switching.	Motion (motion picture) Still (still picture)
(12) VGA mode (for RGB1, RGB2)	Selects VGA mode	Use  or  for switching.	VGA/Wide VGA
(13) Freq. scan (for RGB1, RGB2)	Selects whether to enable auto frequency scanning.	Use  or  for switching.	Auto (scanning) Fix (fixed)



# ADJUSTING IMAGES (PICTURE MENU)

## BASIC OPERATIONS [EX.: ADJUSTING TINT (Tint)]

You can make changes to all image adjustment options in the PICTURE Menu.

The changes you make will be stored for the selected input mode. Therefore, you need to select a desired input mode before making any changes.

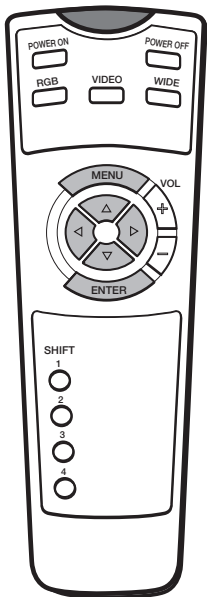

\* You can also use the switches on the display's control panel to accomplish these steps.

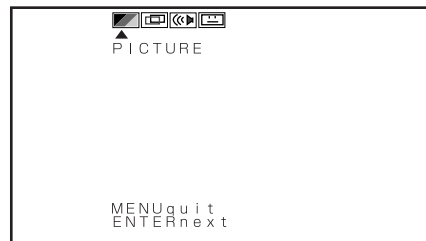

**1** Press .

The main menu screen will appear.



"PICTURE" selected in the main menu screen

**2** Press  or  to select "PICTURE".

Each time you press  or , one of the available menus appears in the following sequence:



PICTURE ↔ POSITION/SIZE ↔ SOUND ↔ OTHERS

**3** Press  or .

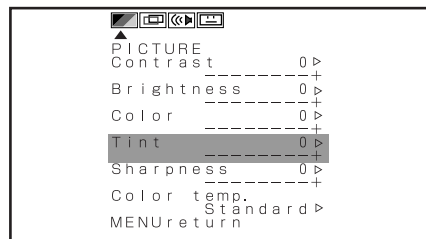
The PICTURE Menu screen will appear.



"Tint" selected in the PICTURE Menu screen (Video Input Mode)

**4** Press  or  to select "Tint".

**5** Press  or .

The "Tint" adjustment screen will appear.

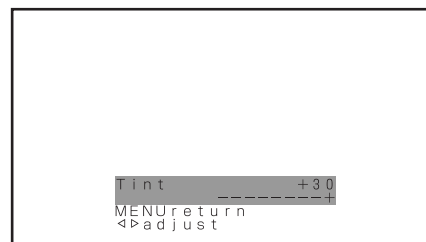

"Tint" adjustment screen

**6** Press  or  to change tint values.

: More green-tinged colors

: More purple-tinged colors

Press  several times when you finish.

\* Repeat steps 4, 5, and 6 when you wish to make changes to other options.



## Adjusting Contrast (Contrast)

[V] [S] [C] [R1] [R2]

Any value between -30 and +30 can be selected.

↔: Higher contrast

↔: Lower contrast

## Adjusting Screen Brightness (Brightness)

[V] [S] [C] [R1] [R2]

Any value between -60 and +60 can be selected.

↔: Brighter screen

↔: Darker screen

## Adjusting Color Darkness (Color)

[V] [S] [C]

Any value between -60 and +60 can be selected.

↔: Darker colors

↔: Lighter colors

## Adjusting Tint (Tint)

[V] [S] [C]

Any value between -30 and +30 for [V][S], and -60 and +60 for [C] can be selected.

↔: More green-tinged colors

↔: More purple-tinged colors

## Adjusting Image Sharpness (Sharpness)

[V] [S] [C]

Any value between -30 and +30 for [V][S], and -3 and +3 for [C] can be selected.

↔: Sharper images

↔: Less sharp images

## Adjusting Color Temperature (Color temp.)

[V] [S] [C] [R1] [R2]

Use ↔ or ↔ to specify a desired color temperature. Each time you press ↔ or ↔, one of the available choices appears in the following sequence:



Warm: More red-tinged colors

Standard: Standard color temperature

Cool: More blue-tinged colors

\* You can adjust color temperature once you have selected “Off” for “Studio mode” in the OTHERS Menu. You cannot adjust color temperature if you have selected “On” for “Studio mode.” (See P. E-37–E-41.)

## Adjusting Dot Clock (Dot clock)

[R1] [R2]

You may find that images blur, depending on the clock frequency of your PC’s processor. If you experience blurring, you can obtain a clearer image by adjusting the “Dot clock”.

Use ↔ or ↔ to select a value between -60 and +60.

## Adjusting Clock Phase (Clock phase)

[R1] [R2]

You may find that images blur, depending on the clock phase of your PC’s processor. If you experience blurring, you can obtain a clearer image by adjusting the “Clock phase”.

Use ↔ or ↔ to select a value between 0 and 15.

### Note

Use  to switch over to the normal mode before adjusting the “Dot clock” or “Clock phase”.

### Information

\* On-screen information disappears if you do not take any action for 60 seconds.

\* The following abbreviations used in this document represent input modes in which you can make adjustments:

[V]: Video mode, [S]: S-video mode, [C]: Comp.video mode, [R1]: RGB1 mode, [R2]: RGB2 mode

# ADJUSTING SCREEN POSITION AND SIZE (POSITION/SIZE MENU)

## BASIC OPERATION [EX.: ADJUSTING SCREEN POSITION]

You can make changes to all screen adjustment options in the POSITION/SIZE Menu.

The changes you make will be stored for the selected input mode. Therefore, you need to select a desired input mode before making any changes.

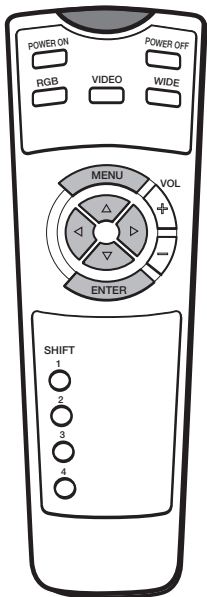



\* You can also use the switches on the display's control panel to accomplish these steps.

**1** Press .

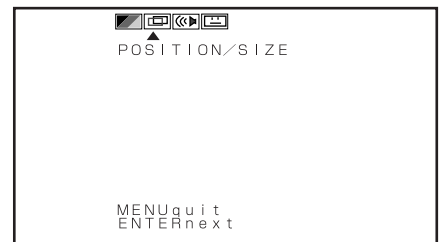
The main menu screen will appear.



**2** Press  or  to select "POSITION/SIZE".

Each time you press  or , one of the available menus appears in the following sequence:

PICTURE  $\longleftrightarrow$  POSITION/SIZE  $\longleftrightarrow$  SOUND  $\longleftrightarrow$  OTHERS

"POSITION/SIZE" selected from the main menu screen

**3** Press  or .

The POSITION/SIZE Menu screen will appear.



**4** Press  or  to select "Position".

"Position" selected in the POSITION/SIZE Menu screen

**5** Press  or .

The "Position" adjustment screen will appear.

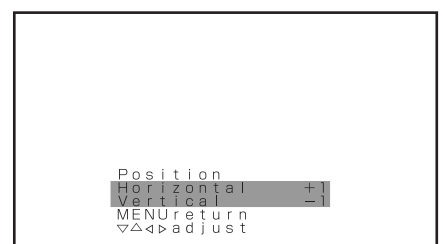

"Position" adjustment screen

**6** Press , , , or  to change position values.

: Moves screen up.

: Moves screen down.

: Moves screen to the right.

: Moves screen to the left.

Press  several times when you finish.

\* Repeat steps 4, 5, and 6 when you wish to make changes to other options.



## Adjusting Screen Position (Position)

[V] [S] [C] [R1] [R2]

Horizontal position (Horizontal)

: Moves screen to the right.



: Moves screen to the left.

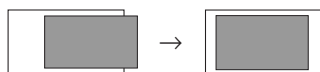

Vertical position (Vertical)

: Moves screen up.



: Moves screen down.

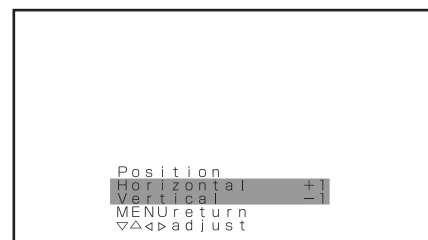
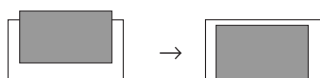

"Position" adjustment screen

## Adjusting Screen Size (Size)

[V] [S] [C] [R1] [R2]

Screen width (Width)

: Increases width.



: Reduces width.

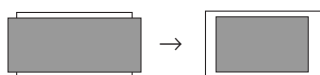

Screen height (Height)

: Increases height.



: Reduces height.

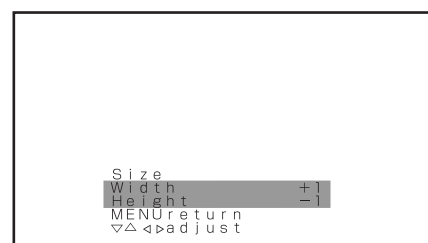
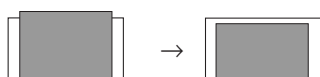

"Size" adjustment screen

## Setting Range

	Video, S-video mode	Comp.video mode	RGB1, RGB2 mode
Position	Horizontal: -30 to +30 Vertical Zoom: -15 to +15 Others: -7 to +7	-16 to +16	-150 to +150
Size	-7 to +7	-4 to +4	-25 to +50

\* On-screen information disappears if you do not take any action for 60 seconds.

\* The following abbreviations used in this document represent input modes in which you can make adjustments:

[V]: Video mode, [S]: S-video mode, [C]: Comp.video mode, [R1]: RGB1 mode, [R2]: RGB2 mode

# ADJUSTING SOUND (SOUND MENU)

## BASIC OPERATION [EX.: ADJUSTING VOLUME BALANCE (Balance)]

You can make changes to all sound adjustment options in the SOUND Menu.

The changes you make will be stored for the selected input mode. Therefore, you need to select a desired input mode before making any changes.

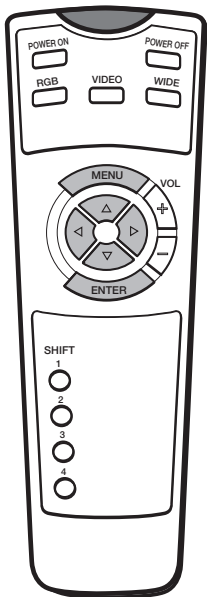

\* You can also use the switches on the display's control panel to accomplish these steps.

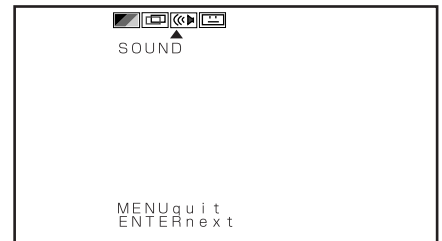

**1** Press .

The main menu screen will appear.



"SOUND" selected in the main menu screen

**2** Press  or  to select "SOUND".

Each time you press  or , one of the available menus appears in the following sequence:



PICTURE ↔ POSITION/SIZE ↔ SOUND ↔ OTHERS

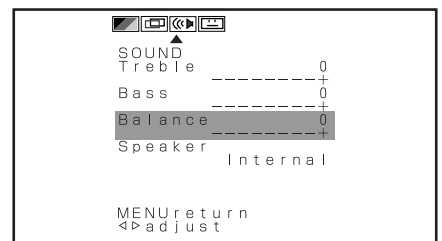

**3** Press  or .

The SOUND Menu screen will appear.



"Balance" selected in the SOUND Menu screen

**4** Press  or  to select "Balance".

**5** Press  or  to adjust the balance.

: Higher volume from the right-hand speaker

: Higher volume from the left-hand speaker

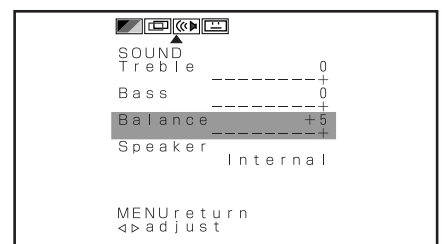

"Balance" adjustment screen

Press  several times when you finish.

\* Repeat steps 4 and 5 when you wish to make changes to other options.



### Adjusting Treble (Treble)

Any value between -6 and +6 can be selected.

↔: Stronger treble

↔: Weaker treble

[V] [S] [C] [R1] [R2]

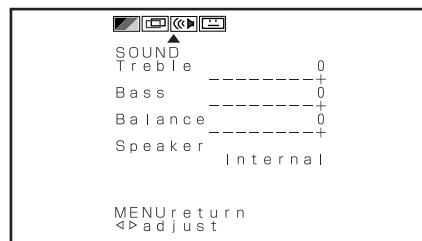

SOUND Menu screen

### Adjusting Bass (Bass)

Any value between -6 and +6 can be selected.

↔: Stronger bass

↔: Weaker bass

[V] [S] [C] [R1] [R2]

### Adjusting Volume Balance (Balance)

Any value between -10 and +10 can be selected.

↔: Higher volume from the right-hand speaker

↔: Higher volume from the left-hand speaker

[V] [S] [C] [R1] [R2]

### Selecting Speakers (Speaker)

Use ↔ or ↔ to select speakers.

Each time you press ↔ or ↔, one of the available choices appears in the following sequence:

Internal ↔ External

Internal: Internal speakers

External: External speakers (not supplied)

[V] [S] [C] [R1] [R2]

\* On-screen information disappears if you do not take any action for 60 seconds.

\* The following abbreviations used in this document represent input modes in which you can make adjustments:

[V]: Video mode, [S]: S-video mode, [C]: Comp.video mode, [R1]: RGB1 mode, [R2]: RGB2 mode

# OTHER ADJUSTMENTS (OTHERS MENU)

## BASIC OPERATION [EX.: SELECTING LANGUAGE (Language)]

You can make the following changes in the OTHERS Menu.

Note that changes you make to on-screen information (OSD), language (Language), and monitor number (Monitor No.) will be shared in all input modes.

The changes you make to other options in this menu will be stored for the selected input mode. Therefore, you need to select a desired input mode before making any changes.

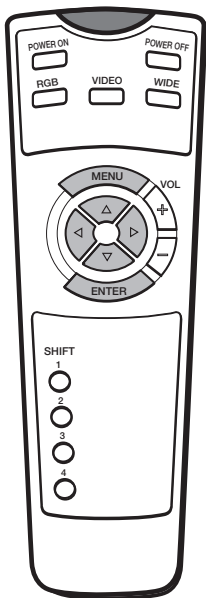



\* You can also use the switches on the display's control panel to accomplish these steps.

**1** Press .

The main menu screen will appear.

**2** Press  or  to select "OTHERS".

Each time you press  or , one of the available menus appears in the following sequence:

PICTURE ↔ POSITION/SIZE ↔ SOUND ↔ OTHERS



**3** Press  or .



The OTHERS Menu screen will appear.

**4** Press  or  to select "Language".

**5** Press  or .

The "Language" selection screen will appear.

- When "▷" appears to the right of an option, you can display the adjustment screen for that option by selecting the option and pressing  or . You can then make changes or selections on that adjustment screen.

**6** Press  or  to select the language.

**7** Press .

The menu is displayed in the selected language.

Press  several times when you finish.

- \* Repeat steps 4 and 5 when you wish to make changes to other options.

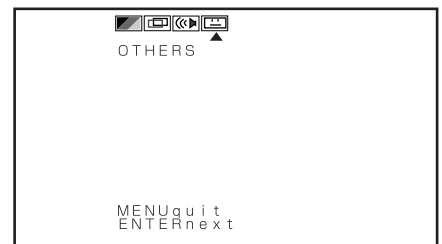

"OTHERS" selected in the main menu screen

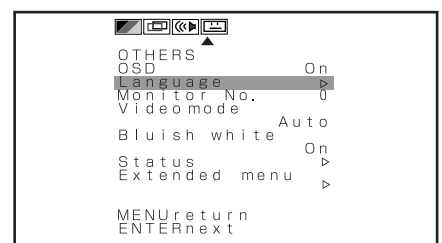

"Language" selected in the OTHERS Menu screen (Video Input Mode)



"Language" selection screen



## Setting Display Information (OSD)

All modes

You can use this option to select whether to display information other than menus. (Error messages are displayed regardless of what choice you make for this option.)

Each time you press or , one of the available choices appears in the following sequence:

On Off

On: Displays all information.

Off: Displays only menus and error messages.

## Selecting Language (Language)

All modes

You can use this option to select the language displayed on the screen.

(1) Select “Language” and press or .

The “Language” selection screen will appear.

(2) Press or to select your desired language.

English  
 Deutsch (German)  
 Español (Spanish)  
 Français (French)  
 Italiano (Italian)  
 Português (Portuguese)

(3) Press .

The menu is displayed in the selected language.

(4) Press when you finish to return to the OTHERS Menu screen.

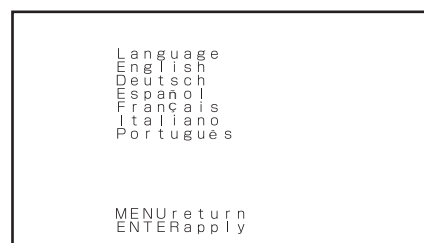

“Language” selection screen

## Assigning Numbers to Displays (Monitor No.)

All modes

When you use two or more displays, you can use a single remote control to control individual displays by assigning a unique number to each of the displays.

Each time you press or , one of the available numbers appears in the following sequence:

0 1 2 3 4

0: You can normally control displays.

You cannot control displays if you press any of [SHIFT 1] through [SHIFT 4].

1–4: Allows you to control a desired display by pressing the corresponding button (one of [SHIFT 1] through [SHIFT 4]).

When you do not press any of the SHIFT buttons, you can control all displays.

\* You can check the “Monitor No.” on the Status screen. (See P. E-36.)

## Selecting Video Mode (Video mode)

You can use this option to select the desired video mode of images it will receive.

Each time you press or , one of the available modes appears in the following sequence:

Auto NTSC PAL SECAM N-PAL M-PAL 4.43NTSC

Auto: Automatically selects the video system.

Other than Auto: You need to select a system appropriate to the input signal.

\* On-screen information disappears if you do not take any action for 60 seconds.

\* The following abbreviations used in this document represent input modes in which you can make adjustments:

: Video mode, : S-video mode, : Comp.video mode, : RGB1 mode, : RGB2 mode





# OTHER ADJUSTMENTS (OTHERS MENU) (Continued)

## Eliminating Flicker (Vertical sync)

[C] [R1] [R2]

Corrects the vertical synchronization signal timing to eliminate vertical flicker.



Use  or  to specify a value between -2 and +1.

## Adjusting Clamp Pulse (Clamp pulse)

[C] [R1] [R2]

Adjusts clamp pulse in accordance with the input signal received from connected equipment.



Clamp pulse is automatically set at the optimal level when you do not use this option.

Use  or  to specify a value between 0 and 8.

## Making White Areas Appear Even Whiter (Bluish white)

[V] [S]

Makes on-screen white areas appear even whiter.

Each time you press  or , one of the available choices appears in the following sequence:

On  Off

On: Enables this function.

Off: Disables this function.

## Displaying System Status (Status)

[V] [S] [C] [R1] [R2]

Displays system operation status.

(1) Select "Status" and press  or .

The "Status" information screen will appear.

(2) Check the status. Press  when you wish to update the status.

(3) Press  to return to the OTHERS Menu screen.

Mode: Input mode appears at the upper right corner of the screen.

Monitor No.: Monitor number

Frequency: Frequency and polarity (fH, fV) ([C], [R1], [R2])

Speaker: Speaker type

Freq. scan: Frequency scanning ([R1], [R2])

Video mode: Video mode ([V], [S] only)

Input signal: Signal type

Preset No.: RGB parameter number ([R1], [R2] only)

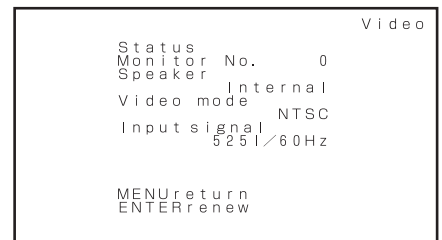

"Status" information screen (Video Input Mode)

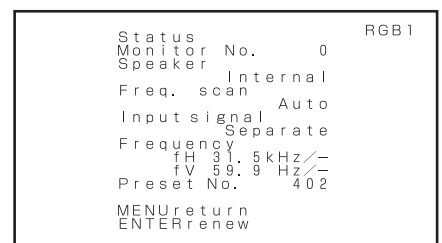

"Status" information screen (RGB Input Mode)

\* On-screen information disappears if you do not take any action for 60 seconds.

\* The following abbreviations used in this document represent input modes in which you can make adjustments:

[V]: Video mode, [S]: S-video mode, [C]: Comp.video mode, [R1]: RGB1 mode, [R2]: RGB2 mode

# EXTENDED FEATURES (Extended menu)

## BASIC OPERATION [EX.: SETTING UP POWER SAVING FUNCTION (DPMS)]

You can use this menu to make adjustments for all extended features.

You can use the "Extended menu" screen to make detailed adjustments.

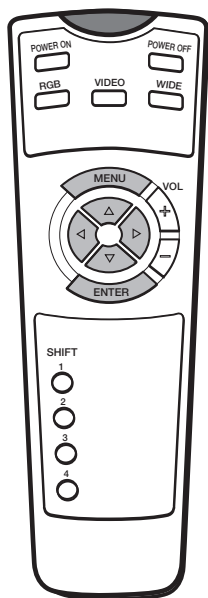

\* You can also use the switches on the display's control panel to accomplish these steps.

**1** Use or on the OTHERS Menu screen to select "Extended menu".

**2** Press or .

The message screen will appear.

**3** Press or to select "Enter" and press .

The "Extended menu" screen will appear.

**4** Press or to select "DPMS".

• When "▷" appears to the right of an option, you can display the adjustment screen for that option by selecting the option and pressing or . You can then make changes or selections on that adjustment screen.

**5** Press or to set up the DPMS.

Each time you press or , one of the available choices appears in the following sequence:

▷ Off ◀◀ 1 min. ◀◀ 3 min. ◀◀ 5 min. ◀◀ 10 min. ◀◀ 30 min. ◀

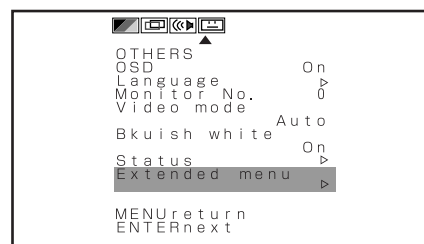

"Extended menu" selected in the OTHERS Menu screen (Video Input Mode)

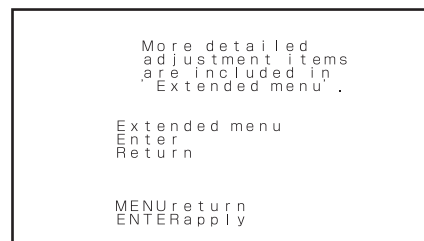

Message screen

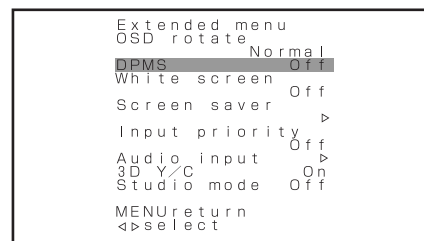

"DPMS" selected in the Extended menu screen (Video Input Mode)

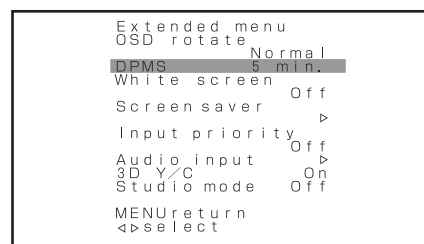

DPMS setting screen (Video Input Mode)

Press several times when you finish.

\* Repeat steps 4 and 5 when you wish to make changes to other options.

### Information

DPMS (which stands for "display power management signaling") allows the display to maintain an automatic power saving function. This function causes on-screen information to disappear until the next input operation, if the power is ON and the display has not received any signals for the predetermined period of time. When DPMS is active, the power indicator lamp turns orange.

# EXTENDED FEATURES (Extended menu) (Continued)

The following classifies options in the extended menu by application or purpose:

```
Extended menu
OSD rotate Normal
DPMS Off
White screen Off
Screensaver Off
Input priority >
Audio input Off
3D Y/C On
Studio mode Off
MENUreturn
<>select
```

Extended menu screen (Video Input Mode)

```
Extended menu
OSD rotate 1/2
DPMS Normal
White screen Off
Screensaver Off
Input priority >
Audio input Off
more v
MENUreturn
<>select
```

Extended menu screen (RGB Input Mode)

```
Extended menu
2/2
prev.
Studio mode Off
White peak level
calibration >
Sharpness 0
Gamma Still
VGA mode VGA
Freq. scan Auto
MENUreturn
<>select
```

## ADJUSTMENTS RELATED TO YOUR PC

### When images are brighter (darker) with a new PC

#### • Adjusting brightness (White peak level calibration) [R1] [R2]

Select the optimum dynamic range for images.

To do this, you need to create a totally white screen [input 255 to each of R, G, and B] using the PC's paint program. Then, display that screen and perform a white peak level calibration. Follow the steps below.

- 1 Select "White peak level calibration" and press or .

The "White peak level calibration" adjustment screen will appear.

- 2 Press or to select one of the following:  
Execute: Performs white peak level calibration.

Original: Restores factory settings.

Cancel: Cancels calibration and maintains current setting.

- 3 Press .
- 4 Press to return to the "Extended menu" screen.

```
White peak level
calibration
Execute
Original
Cancel
MENUreturn
ENTERapply
```

"White peak level calibration" adjustment screen

### When improving image quality (from PC)

#### • Adjusting image sharpness (Sharpness) [R1] [R2]

Any value between -3 and +3 can be selected.

: Sharper images

: Less sharp images

#### • Making gamma correction (Gamma) [R1] [R2]

You can use this option to make a dynamic gamma correction suitable for still or motion pictures.

Each time you press or , one of the available choices appears in the following sequence:

Motion Still

Motion: Suitable for watching a motion picture.

Still: Suitable for watching a still picture.

#### • VGA mode setting (VGA mode) [R1] [R2]

You can use this option to change VGA mode settings for input signals. (Settings are normally changed automatically.)

Each time you click on or , one of the available choices appears in the following sequence:

VGA Wide VGA

VGA: 640 dots (Horizontal)

Wide VGA: Over 640 dots (Horizontal)

### • Frequency scanning (Freq. scan) [R1] [R2]

You can use this option to perform automatic frequency scanning to ensure optimum image quality.

Each time you press  or , one of the available choices appears in the following sequence:

Auto  $\longleftrightarrow$  Fix

Auto: Performs automatic frequency scanning at all times for optimum image quality.

Fix: Maintains the current frequency constant.

## SCREEN PROTECTION AND POWER SAVING

The screen protection functions minimize phosphor burn-in but cannot completely eliminate it.

### • Selecting time before DPMS starts (DPMS) All modes

You can use this option to select the amount of time before the DPMS function starts.

DPMS (which stands for “display power management signaling”) allows the display to maintain an automatic power saving function. (This function is enabled when the preset amount of time elapses if the display stops receiving input signals.)

This function causes on-screen information to disappear until the next input operation, if the power is ON and the display has not received any signals for the predetermined period of time. When DPMS is active, the power indicator lamp turns orange.

Each time you press  or , one of the available choices appears in the following sequence:

$\rightarrow$  Off  $\longleftrightarrow$  1 min.  $\longleftrightarrow$  3 min.  $\longleftrightarrow$  5 min.  $\longleftrightarrow$  10 min.  $\longleftrightarrow$  30 min.  $\leftarrow$

Off: Disables DPMS

Number: Time before DPMS starts. (Unit: minutes)

\* The power indicator lamp turns orange while the DPMS is ON.

\* The power turns ON automatically when the display receives a signal.

### • Displaying white over entire screen (White screen) All modes

You can use this option to display white over the entire screen, so that brightness adjustments can be performed to minimize phosphor burn-in.

Each time you press  or , one of the available choices appears in the following sequence:

$\rightarrow$  Off  $\longleftrightarrow$  Link DPMS  $\longleftrightarrow$  On  $\leftarrow$

Off: Does not display white.

Link DPMS: Displays white approx. 20 seconds after the display stops receiving signals and turns OFF the power once the predetermined amount of time specified for DPMS elapses.

\* This function does not work when DPMS has not been specified.

On: Displays a white screen immediately. Disables this function when you turn the power OFF.

\* On-screen information disappears if you do not take any action for 60 seconds.

\* The following abbreviations used in this document represent input modes in which you can make adjustments:

[V]: Video mode, [S]: S-video mode, [C]: Comp.video mode, [R1]: RGB1 mode, [R2]: RGB2 mode

# EXTENDED FEATURES (Extended menu) (Continued)

## • Minimizing phosphor burn-in (Screen saver)

All modes

You can use this option to move the screen position to minimize phosphor-induced “burning”.

Follow the steps below.

- ① Select “Screen saver” and press or .

The “Screen saver” setting screen will appear.

- ② Press or to select “Function”.
- ③ Select a desired pattern.

Each time you press or , one of the available choices appears in the following sequence:

➤ Off ↔ Time ↔ Mode ←

Off: Disables screen saver.

Time: Moves the pattern every one hour.

Mode: Moves the pattern when the power is turned ON or when you switch between modes.

- ④ Press or to select “Moving area”.
- ⑤ Press or to select the range for moving the pattern.

Each time you press or , one of the available choices appears in the following sequence:

➤ Narrow ↔ Standard ↔ Wide ←

Narrow: Pattern moves in small range.

Standard: Pattern moves in moderate range.

Wide: Pattern moves in wide range.

- ⑥ Press when you finish to return to the “Extended menu” screen.

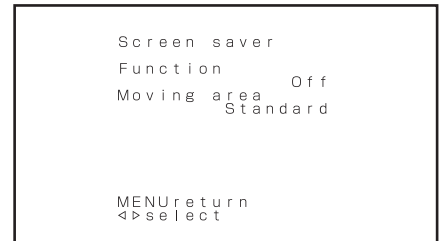

“Screen saver” setting screen

## Using screen protection functions (examples)

When using the display occasionally	When using the display continuously
<ol style="list-style-type: none"> <li>① Select “Link DPMS” for “White screen”.</li> <li>② Select a desired amount of time for “DPMS”. Thus, when the display does not receive a signal, it will automatically display white over the entire screen. When the predetermined time elapses, the power will turn OFF.</li> </ol>	<p><b>When switching between RGB and video input modes only occasionally</b></p> <ol style="list-style-type: none"> <li>① Select “Time” for “Function” with “Screen saver”.</li> <li>② Select a desired range for “Moving area” with “Screen saver”. This causes the screen saver pattern to move in the same range at regular intervals.</li> </ol> <p><b>When switching between RGB and video input modes frequently</b></p> <ol style="list-style-type: none"> <li>① Select “Mode” for “Function” with “Screen saver”.</li> <li>② Select a desired range for “Moving area” with “Screen saver”. This causes the information displayed to move when you switch between modes.</li> </ol>

## OTHERS

### When displaying images for shooting in studio

#### • Adjusting color temperature for reshooting (for broadcasting stations) (Studio mode)

You can use this option to reduce the color temperature to a level suitable for studio use.

Each time you press or , one of the available choices appears in the following sequence:

On ↔ Off

On: Adjusts color temperature so that it is appropriate for reshooting.

Off: Specifies the normal color temperature.

When you select “On” for this option, the choice made for “Color temp.” (color temperature) in the PICTURE Menu will be ignored.

\* See P. E-28–E-29 for information on how to specify color temperature.





## When rotating text (for installing the display with one of its sides facing down)

### • Rotating text (OSD rotate)

All modes

You can use this option to rotate the text.

Each time you press  or , one of the available choices appears in the following sequence:

 -90 Deg.  Normal  +90 Deg. 

-90 Deg.: Displays text from left to right when the display is installed with the power indicator lamp at the top.

Normal: Displays text normally.

+90 Deg.: Displays text from left to right when the display is installed with the power indicator lamp at the bottom.

## When selecting automatic switching to desired mode

### • Input mode of priority (Input priority)

All modes

You can use this option to switch between modes only when a signal is received through the selected input mode terminal. You cannot switch the input mode.

Each time you press  or , one of the available choices appears in the following sequence:

 Off  Video  S-video  Comp.video  RGB1  RGB2 

Off: Switches between modes normally.

Other modes: Displays images when a signal is received through the selected input mode terminal.

\* You cannot switch between RGB1 and RGB2.

You cannot select the currently selected mode.



You cannot switch between input modes when you have selected a mode with this option.

## When changing sound input



### • Selecting input terminals (Audio input)

All modes

You can use this option to select one of the two available terminals to receive sound from input equipment.





① Select "Audio input" and press  or .

The "Audio input" selection screen will appear.

② Press  or  to select input equipment.

③ Select a desired input terminal.

Each time you press  or , one of the available choices appears in the following sequence:

 Audio 1  Audio 2  No audio 

Audio 1, Audio 2: Selects Audio 1 or 2 for receiving sound in the corresponding mode.

No audio: No sound in the corresponding mode.

\* Repeat steps 2 and 3 for each piece of input equipment.

④ Press  when you finish to return to the Extended menu screen.

### • Enabling 3D Y/C Circuit (3D Y/C)



Selects whether to use the 3D Y/C circuit.

Each time you press  or , one of the available choices appears in the following sequence:

On  Off

On: Enables the 3D Y/C circuit.

You can make this selection only for 3.58NTSC signal.

Off: Enables 3-line.



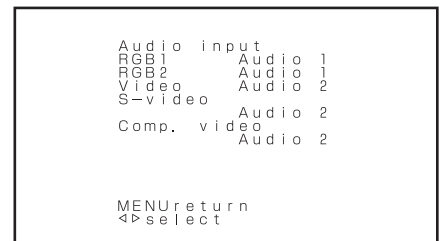

\* You cannot select this option (3D Y/C) for PAL or SECAM signals.



"Audio input" selection screen

\* On-screen information disappears if you do not take any action for 60 seconds.

\* The following abbreviations used in this document represent input modes in which you can make adjustments:

: Video mode, : S-video mode, : Comp.video mode, : RGB1 mode, : RGB2 mode

# SPECIFICATION

Model	PDS4221W-H/PDS4221W-S/PDS4222W-H/PDS4222W-S		
Screen size	42" wide screen (92.0 cm (W) x 51.8 cm (H) x 105.6 cm (Diagonal))		
Aspect ratio	16:9 (wide)		
Weight	31.5 kg		
Outer dimensions	103.5 (W) x 64.0 (H) x 8.5 (D) cm		
Power supply	100–240 VAC 50/60 Hz		
Power consumption	4.3 A		
Screen dimensions	92.2 (W) x 52.2 (H) cm		
Number of pixels	1024 (H) x 1024 (V)		
Display modes	Video, S-video input:	Normal/Auto/Wide1/Wide2/Zoom1/Zoom2	
	Component video input:	Normal /Wide1/Wide2/Zoom1/Zoom2	
	RGB input:	Normal/Wide/Zoom	
Colors	16.77 million		
Sound output	1 W + 1 W (EIAJ)		
Speakers	2 built-in speakers		
External equipment terminals			
Video input terminals	Video image input	1 BNC terminal	1 Vp-p/75 Ω
	S-video image input	1 S terminal	Y: 1 Vp-p/75 Ω C: 0.3 Vp-p/75 Ω
	Component video input (color difference input)	3 BNC terminals	Y: 1 Vp-p/75 Ω Pb/B-Y: 0.7 Vp-p/75 Ω Pr/R-Y: 0.7 Vp-p/75 Ω
Applicable systems	NTSC/PAL/SECAM/N-PAL/M-PAL/4.43NTSC		
PC input terminal	RGB1 input terminal	mD-sub, 3 rows, 15-pin Image signal: 0.7 Vp-p/75 Ω Synchronization signal: TTL level or 0.3 Vp-p/75 Ω	
	RGB2 input terminal	BNC terminal x 5 R: 0.7 Vp-p/75 Ω G: 0.7 Vp-p/75 Ω B: 0.7 Vp-p/75 Ω H: TTL level or 0.3 Vp-p/75 Ω V: TTL level or 0.3 Vp-p/75 Ω	
Sound terminals	2 sound input pin jacks (L/R) (2 lines) 500 mVrms/at least 22 kΩ		
Control terminal	1 RS-232C connector (D-sub 9-pin)		
External speaker output terminal	Lever terminal, 1 line (L/R) Effective max. output: 7 W + 7 W (EIAJ), 8 Ω		
Operating conditions	Temperature: 0 to 40°C Humidity: 20 to 90%		
Accessories	1 connector cover, 1 remote control, 1 strap (for remote control), 2 AA batteries, 1 instruction manual, 2 safety brackets of each type (2 types), 2 screws of each type (2 types), 2 ferrite cores (with wire clampers), 2 cable clampers, 3 power cables		

- Specifications and external appearance may be change for the sake of improvement.
- **Plasmavision** is a worldwide trademark of Fujitsu General Limited and is a registered trademark in Japan, the U.S.A. and other countries or areas.

## Regulation ... PDS4221W-H/PDS4221W-S



- UL, CSA ..... Safety: UL1950/CSA C22.2 No.950  
EMC: FCC Part 15 Class A, ICES-003 Class A
- CE ..... Safety: EN60950 1992, A1: 1993, A2: 1993, A3: 1995, A4: 1997  
EMC: EN55022 1994, A1: 1995, A2: 1997, Class A  
EN61000-3-2 1995, A1: 1997, A2: 1998  
EN61000-3-3 1995  
EN55024 1998  
EN61000-4-2 1995  
EN61000-4-3 1996  
EN61000-4-4 1995  
EN61000-4-5 1995  
EN61000-4-6 1996  
EN61000-4-8 1993  
EN61000-4-11 1994
- AS ..... Safety: IEC60950 A1/A2/A3/A4  
EMC: AS/NZS 3548

## Regulation ... PDS4222W-H/PDS4222W-S

- UL, CSA ..... Safety: UL1950/CSA C22.2 No.950  
EMC: FCC Part 15 Class B, ICES-003 Class B
- CE ..... Safety: EN60950 1992, A1: 1993, A2: 1993, A3: 1995, A4: 1997  
EMC: EN55022 1994, A1: 1995, A2: 1997, Class B  
EN61000-3-2 1995, A1: 1997, A2: 1998  
EN61000-3-3 1995  
EN55024 1998  
EN61000-4-2 1995  
EN61000-4-3 1996  
EN61000-4-4 1995  
EN61000-4-5 1995  
EN61000-4-6 1996  
EN61000-4-8 1993  
EN61000-4-11 1994
- AS ..... Safety: IEC60950 A1/A2/A3/A4  
EMC: AS/NZS 3548

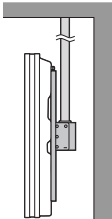
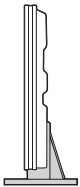
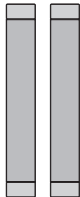

# OPTIONS

<p>Wall-mounting unit (for both vertical and horizontal)</p>	<p>Vertical: 0° to 5° mounting angle Horizontal: 0° to 15° mounting angle</p>	<p>P-42WB11</p>	
<p>Hanging unit</p>	<p>0° to 15° mounting angle (variable) The pipe is not supplied with the ceiling-hanging unit, so consult your produce dealer.</p>	<p>P-42CT11</p>	
<p>Stand</p>		<p>P-42TT11</p>	
<p>Speaker</p>		<p>P-42SP11 (1 set of 2 speakers)</p>	
<p>Speaker stand</p>		<p>P-42ST11 (1 set of 2 speakers stands)</p>	

\* When installing an option, make sure that all installation requirements for that option—as given in the relevant instruction manual—are met.

\* The colors of options do not match the display colors perfectly.

## Warning

To prevent injury, fire, and electric shock, arrange for options to be initially installed (or installed at a different location) by your dealer.

## Free Manuals Download Website

<http://myh66.com>

<http://usermanuals.us>

<http://www.somanuals.com>

<http://www.4manuals.cc>

<http://www.manual-lib.com>

<http://www.404manual.com>

<http://www.luxmanual.com>

<http://aubethermostatmanual.com>

Golf course search by state

<http://golfingnear.com>

Email search by domain

<http://emailbydomain.com>

Auto manuals search

<http://auto.somanuals.com>

TV manuals search

<http://tv.somanuals.com>