

(Specification and Part Names)

WIDE PLASMA DISPLAY

P42VHA40W/P42HHA40W/P50XHA40W/P55XHA40W/
P63XHA40W

P42VHA40U/P42HHA40U/P50XHA40U/P55XHA40U/
P63XHA40U

P42VHA40A/P42HHA40A/P50XHA40A/P55XHA40A/
P63XHA40A

P42VHA40R/P63XHA40R



PlasmaVision™



Contents

	Page
Before Use	
• CHECKING ACCESSORIES	E-2
• INSTALLATION	E-3
Usage	
• PART NAMES AND FUNCTIONS	E-4
Others	
• OPTIONS.....	E-9
• MAIN SUPPORTED SIGNALS.....	E-10
• SPECIFICATION	E-12

Before using the display, read the User's manual (1/2) and the User's manual (2/2) carefully so that you know how to use the display correctly.

Refer to this manual whenever questions or problems about operation arise. Be sure to read and observe the safety precautions (see the separate "Safety Precautions" manual).

Keep this manual where the user can see it easily.

* Installation and removal require special expertise. Consult your product dealer for details.

* When "English" is selected at "Language" of the on-screen display, "colour" will be displayed in the case of the R model and "color" will be displayed for all other models.

The notation used in this users' manual is "color".

* All operation items of A model are the same as W model.

Please read the description part of "W model" for "A model" in User's manual (2/2).

* The residential warranty for "A model" is enclosed in accessories.

* The last digit of MODEL NO. (10 digit alphanumeric characters) indicated on the product means the body color indication alphabet or the management number.

* The illustration of external appearance is for 42" model.

Please acknowledge some differences in the actual product of other models.

CHECKING ACCESSORIES

One power cable

Two small ferrite cores



No.:ZCAT1518-0730
Mfr.:TDK

Two big ferrite cores

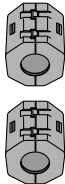

No.:SFT-72SN
Mfr.:TKK

Three user's manuals

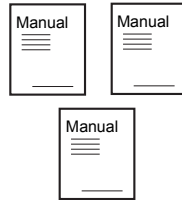

One remote control
(for the W/A/R models)



One remote control
(for the U model)



Two AA batteries



One residential
warranty
(for the A model)



CONNECTING THE DISPLAY TO EXTERNAL EQUIPMENT

Carefully check the terminals for position and type before making any connections.

Loose connectors can result in picture or color problems. Make sure that all connectors are securely inserted into their terminals.

Ferrite cores

These ferrite cores are used to attenuate undesired signals.

Two big ferrite cores

When connecting a cable to the power input terminal, video input terminal, attach one of these ferrite cores to the cable near the terminal.

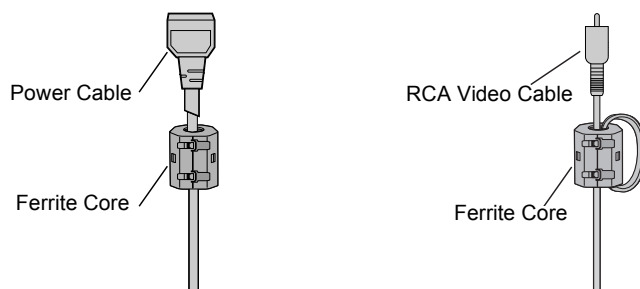

Two small ferrite cores

When connecting a cable to the external speaker output terminal attach one of these ferrite cores to the cable near the terminal.



To prevent the display's internal components from overheating, make sure that the display is installed in a well-ventilated location.

Be sure to use the optional stand, wall-mounting unit or the other unit when installing the display. Also, be also sure that your dealer performs the installation.

See the appropriate instruction manual for more information on the installation hardware you select.

To prevent an accident and ensure safety in the event of an earthquake, fix the display securely into position as described below.

To ensure proper heat radiation, provide at least as much space around the display as shown below.

- * Make sure that the display is installed in a location where the temperature can be maintained between 0°C and 40°C.
- * Never attempt to tilt the display sideways or backward.
- * To prevent the power and other cables from being accidentally pulled, make sure that they run along the wall or through corners.
- * To prevent accidents and ensure safety in the event of an earthquake, secure the display to prevent it from tipping over.

Display Section

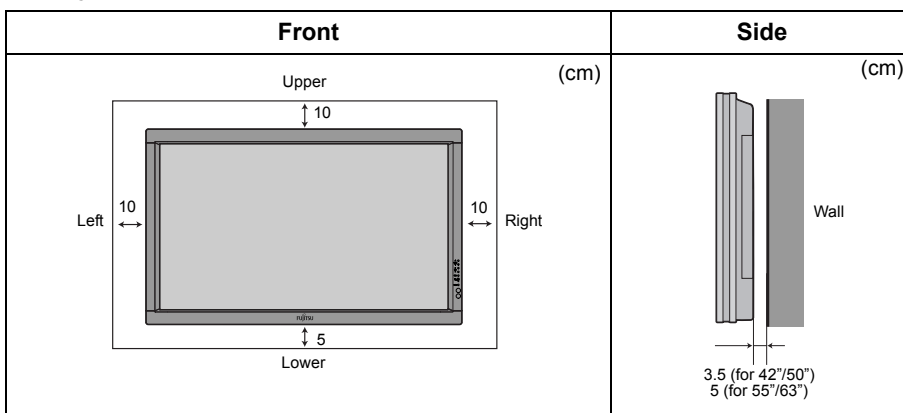

Note

The display is a highly precise piece of equipment and therefore must be packed properly before transportation. Be sure to use only those packing materials originally supplied with the display when repacking it.

Reference

See P. E-9 for more information on options.

PART NAMES AND FUNCTIONS

DISPLAY SECTION – FRONT

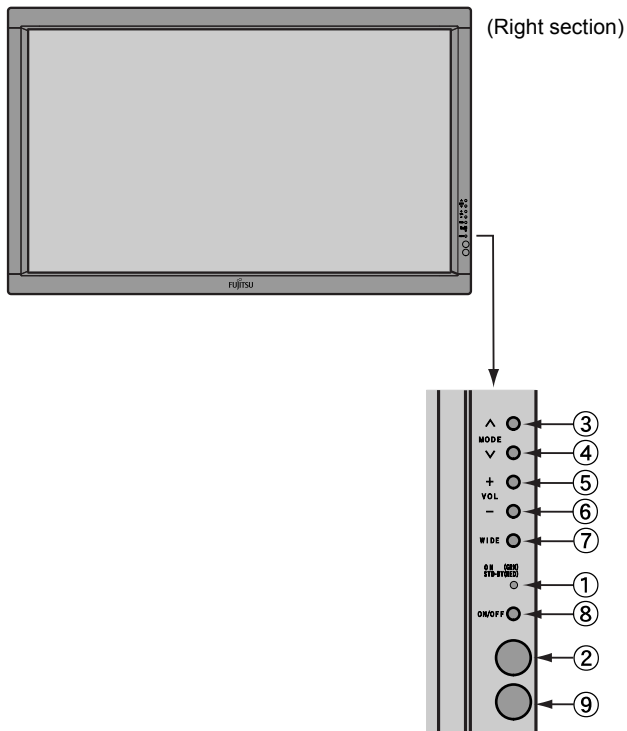

① Power indicator lamp

This lamp shows the state of the power supply.

Lit (red): Stand-by state

Lit (green): Power ON state

Flashing (red or green): Malfunction (Flashes differently depending on the type of malfunction.)

② Remote control signal receiver

Receives signals from the remote control.

③ Input mode selector button ▲ [MODE]

④ Input mode selector button ▼ [MODE]

Switches between picture input modes.

⑤ VOL + button

⑥ VOL - button

Adjusts the audio volume.

⑦ Wide screen selector button [WIDE]

Switches the screen over to a desired wide screen.

⑧ ON/OFF button

Turns the power "ON" and "OFF (standby state)".

⑨ Ambient Sensor

Detects the brightness of external light.

Do not obstruct it.

Warning

If the power indicator lamp flashes red or green, this signifies that the display has developed a problem. When this happens, be sure to remove the power plug from the receptacle and contact your dealer. Leaving the display power ON can result in fire or electric shock.

DISPLAY SECTION – BACK AND BOTTOM PART

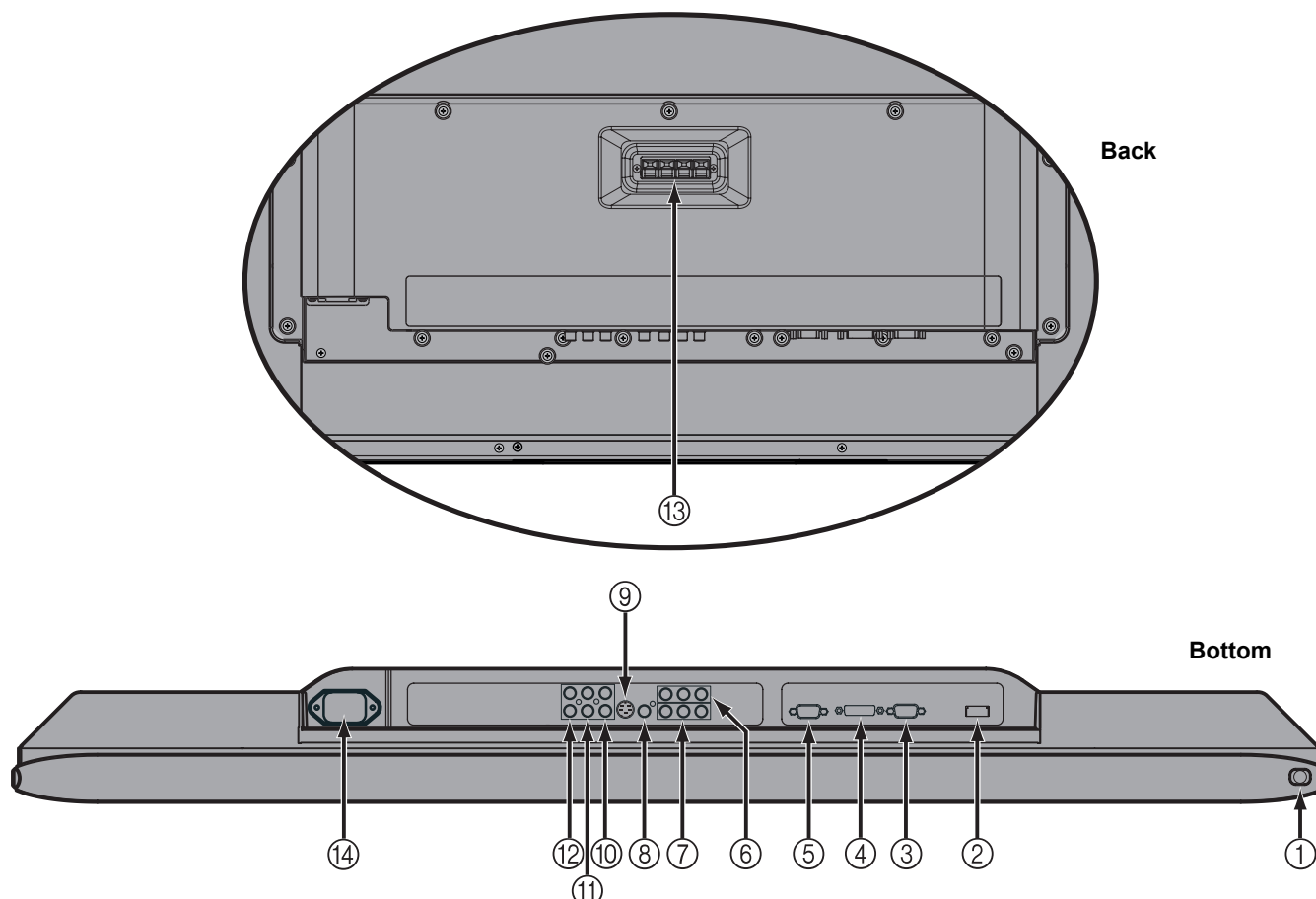

① / I power switch

If this button is pressed when the power indicator lamp is off, the indicator lamp will light.

The power can be turned on and the standby mode selected by using the remote control or the control panel of the display.

If this button is pressed when the power indicator lamp is lit, the indicator lamp will go out.

*Power is still supplied to parts of the display even if the indicator lamp is off.

② HDMI input terminal (VIDEO5 INPUT/HDMI) for the U model

Connect this terminal to the HDMI output terminal for DVD, etc.

③ RS-232C terminal (RS-232C)

This terminal is provided for you to control the display from the PC. Connect it to the RS-232C terminal on the PC.

④ RGB1 input terminal (RGB1 INPUT/DVI-D) for the W/U/A models

Connect this terminal to the PC's display (digital RGB) output terminal.

*The connection cable No.88741-8000 made by **molex Inc.** is recommended.

Note

- The illustration of external appearance is for 42" model. Please acknowledge some differences in the actual product of other models.

PART NAMES AND FUNCTIONS (Continued)

- ⑤ **RGB2 input terminal (RGB2 INPUT/mD-sub) for the W/U/A models /
RGB1 input terminal (RGB1 INPUT/mD-sub) for the R model**

Connect this terminal to the PC's display (analog RGB) output terminal or decoder (digital broadcast tuner, etc.) output terminal.

- ⑥ **Component video input terminal (VIDEO3 INPUT)**

- ⑦ **Component video input terminal (VIDEO4 INPUT)**

Connect this terminal to the component video output (color difference output) terminal of your HDTV unit or DVD player.

- ⑧ **Video input terminal (VIDEO1 INPUT)**

Connect this terminal to the video output terminal of your VCR.

When connecting a cable, attach a ferrite core to the cable. (See P. E-2.)

- ⑨ **S-Video input terminal (VIDEO2 INPUT)**

Connect this terminal to the S-video output terminal of your VCR.

- ⑩ **Audio3 input terminal (AUDIO3 INPUT)**

- ⑪ **Audio2 input terminal (AUDIO2 INPUT)**

- ⑫ **Audio1 input terminal (AUDIO1 INPUT)**

Connect this terminal to the audio output terminal of your VCR, etc. (See the User's manual (2/2) for the selection of audio input for video input.)

- ⑬ **External speaker output terminal (EXT SP)**

Connect this terminal to the optionally available speaker.

When connecting a cable, attach a ferrite core to the cable. (See P. E-2.)

* See the speaker instruction manual for more information.

- ⑭ **Power input terminal**

Connect this terminal to the power cable supplied with the display.

When connecting a cable, attach a ferrite core to the cable. (See P. E-2.)

DESCRIPTION OF INPUT TERMINALS

DVI-D terminal (RGB1 INPUT/DVI-D)
for the W/U/A models

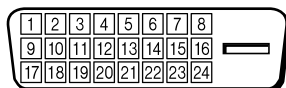

Pin No.	Signal	Pin No.	Signal	Pin No.	Signal
1	T.M.D.S. Data2-	9	T.M.D.S. Data1-	17	T.M.D.S. Data0-
2	T.M.D.S. Data2+	10	T.M.D.S. Data1+	18	T.M.D.S. Data0+
3	T.M.D.S. Data2 Shield	11	T.M.D.S. Data1 Shield	19	T.M.D.S. Data0 Shield
4	—	12	—	20	—
5	—	13	—	21	—
6	DDC Clock	14	+5V Power	22	T.M.D.S. Clock Shield
7	DDC Data	15	Ground (for +5V)	23	T.M.D.S. Clock+
8	—	16	Hot Ploug Detect	24	T.M.D.S. Clock-

mD-sub input terminal
(RGB2 INPUT/mD-sub) for the W/U/A models
(RGB1 INPUT/mD-sub) for the R model

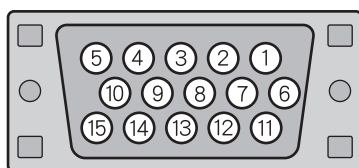

Pin No.	Input signal	Pin No.	Input signal
1	Red	9	—
2	Green	10	Ground
3	Blue	11	—
4	—	12	—
5	Ground	13	Horizontal synchronization
6	Ground	14	Vertical synchronization
7	Ground	15	—
8	Ground	Frame	Ground

RS-232C terminal (RS-232C)

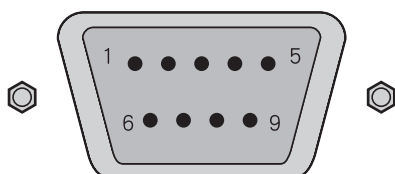

Pin No.	Signal
1	DCD (Data Carrier Detect)
2	RD (Received Data)
3	TD (Transmit Data)
4	DTR (Data Terminal ready)
5	GND (Ground)
6	DSR (Data Set Ready)
7	RTS (Request To send)
8	CTS (Clear To Send)
9	RI (Ring Indication)

PART NAMES AND FUNCTIONS (Continued)

HDMI input terminal (VIDEO5 INPUT/HDMI)
for the U model

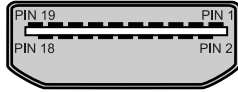



Pin No.	Input signal	Pin No.	Input signal
1	T.M.D.S. Data2+	11	T.M.D.S. Clock Shield
2	T.M.D.S. Data2 Shield	12	T.M.D.S. Clock-
3	T.M.D.S. Data2-	13	CEC
4	T.M.D.S. Data1+	14	Reserve
5	T.M.D.S. Data1 Shield	15	DDC Clock
6	T.M.D.S. Data1-	16	DDC Data
7	T.M.D.S. Data0+	17	Ground (for +5V)
8	T.M.D.S. Data0 Shield	18	+5V Power
9	T.M.D.S. Data0-	19	Hot Plug Detect
10	T.M.D.S. Clock+	Frame	FG

HDMI™
HIGH DEFINITION MULTIMEDIA INTERFACE

HDMI (High-Definition Multimedia Interface)

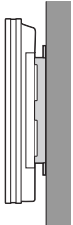
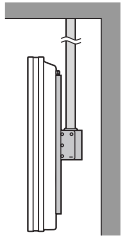
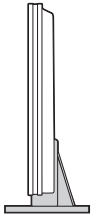
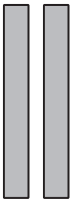
HDMI is a standard for home digital interfaces, which can transmit images as well as multichannel audio signals and control signals through one cable.

Wall-mounting Bracket	0° to 15° mounting angle	P-WB4201 (for 42" model/50" model) P-WB6300 (for 55" model/63" model)	
Ceiling unit	0° to 15° mounting angle	P-CT4200 (for 42" model/50" model) P-CT6300 (for 55" model/63" model)	
Desktop Stand unit		P-TT4202 (for 42" model/50" model/55" model) P-TT6300 (for 63" model)	
Speaker (1 set of 2 speakers)		P-SP1000 (for attaching to the display) for 42" model/50" model P-SP5010 (for attaching to the display) for 55" model P-SP6300 (for attaching to the display) for 63" model P-SP4200 (for mounting on the speaker stands) for 42" model P-SP5010 (for mounting on the speaker stands) for 50" model/55" model	
Desktop Speaker Stand (1 set of 2 speaker stands)		P-ST4200 (for P-SP4200) P-ST5000 (for P-SP5010)	

- * When installing an option, make sure that all installation requirements for that option (as given in the relevant instruction manual) are met.
- * The colors of options do not match the display colors perfectly.
- * To improve the function and performance of optional accessories, specifications and part names may change. Consult your local dealer before purchasing.

Warning

To prevent injury, fire, and electric shock, arrange for options to be initially installed (or installed at a different location) by your dealer.

CAUTION

This display (P42VHA40/P42HHA40/P50XHA40) is for use only with Fujitsu General Limited's option (P-WB4201, P-CT4200, P-TT4202).
This display (P55XHA40) is for use only with Fujitsu General Limited's option (P-WB6300, P-CT6300, P-TT4202).
This display (P63XHA40) is for use only with Fujitsu General Limited's option (P-WB6300, P-CT6300, P-TT6300).
Using this display with other option can cause instability resulting in possible injury.

MAIN SUPPORTED SIGNALS

This display can store the latest four types of signals for RGB adjustment value. The fifth input signal will replace the adjustment value of the first input signal.

To do this, select a desired signal and follow the instructions in “Adjusting Screen Position and Size” on the User’s manual (2/2) to adjust the parameters.

When you finish, the settings will be automatically stored. Thus, when the display receives that signal, pictures will be displayed in accordance with the settings you most recently selected.

Main corresponding signals (RGB mode)

Display (dots x lines)	Horizontal frequency (kHz)	Vertical frequency (Hz)	Signal	DVI-D
640 x 480	31.47	59.94	VGA	○
640 x 480	37.50	75.00	VGA 75 Hz	
640 x 480	43.27	85.01	VGA 85 Hz	
720 x 400	31.47	70.09	400 lines	○
800 x 600	37.88	60.32	SVGA 60 Hz	○
800 x 600	46.88	75.00	SVGA 75 Hz	
800 x 600	53.67	85.06	SVGA 85 Hz	
1024 x 768	48.36	60.00	XGA 60 Hz	○
1024 x 768	60.02	75.03	XGA 75 Hz	
1024 x 768	68.68	84.99	XGA 85 Hz	
1280 x 1024	63.98	60.02	SXGA 60 Hz	
1280 x 1024	79.98	75.03	SXGA 75 Hz	
848 x 480	31.02	60.00		○
852 x 480	31.72	59.97		
1360 x 768	47.71	60.01		○※
720 x 485	15.73	59.94	60 fields	
720 x 575	15.63	50.00	50 fields	

※It doesn't support the model with 42" display (displayed pixels 852 x 480 dots x lines).

* In the DVI-D mode, the input signal can be restricted partly.

In the Comp.video and Video/S-video, the display has been factory-set as follows for different input signals:

Main corresponding signals (Comp.video mode)

Horizontal frequency (kHz)	Vertical frequency (Hz)	Signal	HDMI
15.73	59.94	SDTV 480i	○
15.63	50.00	SDTV 576i	○
31.47	59.94	SDTV 480p	○
31.25	50.00	SDTV 576p	○
45.00	60.00	HDTV 720p	○
37.50	50.00	HDTV 720p	○
33.75	60.00	HDTV 1080i	○
28.13	50.00	HDTV 1080i	○

Main corresponding signals (Video, S-video mode)

Horizontal frequency (kHz)	Vertical frequency (Hz)	Signal
15.73	59.94	NTSC
15.63	50.00	PAL
15.63	50.00	SECAM
15.63	59.52	PAL60
15.63	50.00	N-PAL
15.73	59.95	M-PAL
15.73	59.94	4.43NTSC

Note

- Depending on the input signal, the display may show pictures of reduced size due to size reduction and interpolation.
- With some input signals, "Out of range" may appear even when the horizontal and vertical frequencies are within their permissible ranges. In this event, match the input signals to another frequency rather than those listed above.
- You can check input signals through "Information" on the FEATURES Menu screen. (See User's Manual (2/2))
- In order to facilitate the explanations, pictures and diagrams in this manual may differ slightly from the actual items.
- All terms (i.e., company and product names) used in this document are trademarks or registered trademarks.

SPECIFICATION

WIDE PLASMA DISPLAY

Model	P42VHA40W/A	P42HHA40W/A	P50XHA40W/A	P55XHA40W/A	P63XHA40W/A
Screen size	42" wide screen: 92.1 cm (W) x 51.8 cm (H) (105.7 cm diagonal) 36.3 inch (W) x 20.4 inch (H) (41.6 inch diagonal)	42" wide screen: 92.2 cm (W) x 52.2 cm (H) (106.0 cm diagonal) 36.3 inch (W) x 20.6 inch (H) (41.7 inch diagonal)	50" wide screen: 110.6 cm (W) x 62.2 cm (H) (126.9 cm diagonal) 43.5 inch (W) x 24.5 inch (H) (50 inch diagonal)	55" wide screen: 122.9 cm (W) x 69.1 cm (H) (140.0 cm diagonal) 48.4 inch (W) x 27.2 inch (H) (55.1 inch diagonal)	63" wide screen: 139.3 cm (W) x 78.3 cm (H) (159.8 cm diagonal) 54.8 inch (W) x 30.8 inch (H) (62.9 inch diagonal)
Aspect ratio	16:9 (wide)				
Number of pixels	852 (H) x 480 (V)	1024 (H) x 1024 (V)	1366 (H) x 768 (V)		
Weight	31.5 kg / 69 lbs		45 kg / 99 lbs	55 kg / 121 lbs	72 kg / 159 lbs
Outer dimensions	103.9 (W) x 64.0 (H) x 8.7 (D) cm 40.9 (W) x 25.2 (H) x 3.4 (D) inch (does not include outer projections)		121.6 (W) x 72.6 (H) x 10.0 (D) cm 47.9 (W) x 28.6 (H) x 3.9 (D) inch (does not include outer projections)	138.0 (W) x 80.8 (H) x 12.5 (D) cm 54.3 (W) x 31.8 (H) x 4.9 (D) inch (does not include outer projections)	150.4 (W) x 89.4 (H) x 12.3 (D) cm 59.2 (W) x 35.2 (H) x 4.8 (D) inch (does not include outer projections)
Power supply	110-240 VAC 50/60 Hz				
Current rating	3.2-1.35 A	4.2-1.8 A	4.4-1.9 A	5.8-2.3 A	6.8-2.6 A
External equipment terminals					
Video input terminals	VIDEO1 INPUT (Video input)		RCA terminal	1 V _{p-p} /75 Ω	
	VIDEO2 INPUT (S-video input)		S terminal	Y: 1 V _{p-p} /75 Ω C: 0.286 V _{p-p} /75 Ω	
	VIDEO3/VIDEO4 INPUT (Component video input)		3 RCA terminals	Y: 1 V _{p-p} /75 Ω P _B /C _B : 0.7 V _{p-p} /75 Ω P _R /C _R : 0.7 V _{p-p} /75 Ω	
PC input terminal	RGB1 input RGB2 input	DVI-D terminal (EIA/CEA-861B Compliant) mD-sub, 3 rows, 15-pin Picture signal: 0.7 V _{p-p} /75 Ω Synchronization signal: TTL level			
Audio terminals	2 audio input pin jacks (L/R) (3 lines) 500 mV _{rms} /at least 22 kΩ				
Control terminal	RS-232C connector (D-sub 9-pin)				
External speaker output terminal	Max. output: 10 W + 10 W, 6 Ω				
Operating conditions	Temperature: 0 to 40 °C / 32 to 104 °F Humidity: 20 to 80 %				
Accessories	3 user's manuals, 1 power cable, 2 small ferrite cores, 2 big ferrite cores, 1 remote control, 2 AA batteries, 1 residential warranty (for the A model)				

Regulation

- UL, CSA Safety: UL6500, C-UL
EMC: FCC Part 15 Class B, ICES-003 Class B
- CE Safety: EN60065
EMC: EN55022 1998, Class B
EN61000-3-2 1995
EN61000-3-3 1995
EN55024 1998
EN61000-4-2 1995
EN61000-4-3 1996
EN61000-4-4 1995
EN61000-4-5 1995
EN61000-4-6 1996
EN61000-4-8 1993
EN61000-4-11 1994
- AS Safety: IEC60065
EMC: AS/NZS 3548

WIDE PLASMA DISPLAY

Model	P42VHA40U	P42HHA40U	P50XHA40U	P55XHA40U	P63XHA40U
Screen size	42" wide screen: 92.1 cm (W) x 51.8 cm (H) (105.7 cm diagonal) 36.3 inch (W) x 20.4 inch (H) (41.6 inch diagonal)	42" wide screen: 92.2 cm (W) x 52.2 cm (H) (106.0 cm diagonal) 36.3 inch (W) x 20.6 inch (H) (41.7 inch diagonal)	50" wide screen: 110.6 cm (W) x 62.2 cm (H) (126.9 cm diagonal) 43.5 inch (W) x 24.5 inch (H) (50 inch diagonal)	55" wide screen: 122.9 cm (W) x 69.1 cm (H) (140.0 cm diagonal) 48.4 inch (W) x 27.2 inch (H) (55.1 inch diagonal)	63" wide screen: 139.3 cm (W) x 78.3 cm (H) (159.8 cm diagonal) 54.8 inch (W) x 30.8 inch (H) (62.9 inch diagonal)
Aspect ratio	16:9 (wide)				
Number of pixels	852 (H) x 480 (V)	1024 (H) x 1024 (V)	1366 (H) x 768 (V)		
Weight	31.5 kg / 69 lbs		45 kg / 99 lbs	55 kg / 121 lbs	72 kg / 159 lbs
Outer dimensions	103.9 (W) x 64.0 (H) x 8.7 (D) cm 40.9 (W) x 25.2 (H) x 3.4 (D) inch (does not include outer projections)		121.6 (W) x 72.6 (H) x 10.0 (D) cm 47.9 (W) x 28.6 (H) x 3.9 (D) inch (does not include outer projections)	138.0 (W) x 80.8 (H) x 12.5 (D) cm 54.3 (W) x 31.8 (H) x 4.9 (D) inch (does not include outer projections)	150.4 (W) x 89.4 (H) x 12.3 (D) cm 59.2 (W) x 35.2 (H) x 4.8 (D) inch (does not include outer projections)
Power supply	110-240 VAC 50/60 Hz				
Current rating	3.2-1.35 A	4.2-1.8 A	4.4-1.9 A	5.8-2.3 A	6.8-2.6 A
External equipment terminals					
Video input terminals	VIDEO1 INPUT (Video input)		RCA terminal	1 V _{p-p} /75 Ω	
	VIDEO2 INPUT (S-video input)		S terminal	Y: 1 V _{p-p} /75 Ω C: 0.286 V _{p-p} /75 Ω	
	VIDEO3/VIDEO4 INPUT (Component video input)		3 RCA terminals	Y: 1 V _{p-p} /75 Ω P _B /C _B : 0.7 V _{p-p} /75 Ω P _R /C _R : 0.7 V _{p-p} /75 Ω	
	VIDEO5 INPUT		HDMI terminal (HDMI type A connector)		
PC input terminal	RGB1 input RGB2 input	DVI-D terminal (EIA/CEA-861B Compliant) mD-sub, 3 rows, 15-pin Picture signal: 0.7 V _{p-p} /75 Ω Synchronization signal: TTL level			
Audio terminals	2 audio input pin jacks (L/R) (3 lines) 500 mV _{rms} /at least 22 kΩ				
Control terminal	RS-232C connector (D-sub 9-pin)				
External speaker output terminal	Max. output: 10 W + 10 W, 6 Ω				
Operating conditions	Temperature: 0 to 40 °C / 32 to 104 °F Humidity: 20 to 80 %				
Accessories	3 user's manuals, 1 power cable, 2 small ferrite cores, 2 big ferrite cores, 1 remote control, 2 AA batteries				

Regulation

- UL, CSA Safety: UL6500, C-UL
EMC: FCC Part 15 Class B, ICES-003 Class B
- CE Safety: EN60065
EMC: EN55022 1998, Class B
EN61000-3-2 1995
EN61000-3-3 1995
EN55024 1998
EN61000-4-2 1995
EN61000-4-3 1996
EN61000-4-4 1995
EN61000-4-5 1995
EN61000-4-6 1996
EN61000-4-8 1993
EN61000-4-11 1994
- AS Safety: IEC60065
EMC: AS/NZS 3548

Note

- Specifications and external appearance may be change for the sake of improvement.
- Viewing the screen constantly for extended periods can strain your eyes. Be sure to stay at a proper distance (at least 1.6 m or 5.2 feet for 42" / at least 1.9 m or 6.2 feet for 50" / at least 2.1 m or 6.9 feet for 55" / at least 2.4 m or 7.9 feet for 63") from the screen and to look occasionally away while working.
- **Plasmavision**™ is a worldwide trademark of Fujitsu General Limited and is a registered trademark in Japan, the U.S.A. and other countries or areas.

SPECIFICATION (Continued)

WIDE PLASMA DISPLAY

Model	P42VHA40R	P63XHA40R
Screen size	42" wide screen: 92.1 cm (W) x 51.8 cm (H) (105.7 cm diagonal) 36.3 inch (W) x 20.4 inch (H) (41.6 inch diagonal)	63" wide screen: 139.3 cm (W) x 78.3 cm (H) (159.8 cm diagonal) 54.8 inch (W) x 30.8 inch (H) (62.9 inch diagonal)
Aspect ratio	16:9 (wide)	
Number of pixels	852 (H) x 480 (V)	1366 (H) x 768 (V)
Weight	31.5 kg / 69 lbs	72 kg / 159 lbs
Outer dimensions	103.9 (W) x 64.0 (H) x 8.7 (D) cm 40.9 (W) x 25.2 (H) x 3.4 (D) inch (does not include outer projections)	150.4 (W) x 89.4 (H) x 12.3 (D) cm 59.2 (W) x 35.2 (H) x 4.8 (D) inch (does not include outer projections)
Power supply	110-240 VAC 50/60 Hz	
Current rating	4.2-1.7 A	6.8-2.6 A
External equipment terminals		
Video input terminals	VIDEO1 INPUT (Video input)	RCA terminal 1 Vp-p/75 Ω
	VIDEO2 INPUT (S-video input)	S terminal Y: 1 Vp-p/75 Ω C: 0.286 Vp-p/75 Ω
	VIDEO3/VIDEO4 INPUT (Component video input)	3 RCA terminals Y: 1 Vp-p/75 Ω PB/CB: 0.7 Vp-p/75 Ω PR/CR: 0.7 Vp-p/75 Ω
PC input terminal	RGB1 input mD-sub, 3 rows, 15-pin Picture signal: 0.7 Vp-p/75 Ω Synchronization signal:TTL level	
Audio terminals	2 audio input pin jacks (L/R) (3 lines) 500 mVrms/at least 22 kΩ	
Control terminal	RS-232C connector (D-sub 9-pin)	
External speaker output terminal	Max. output: 10 W + 10 W, 6 Ω	
Operating conditions	Temperature: 0 to 40 °C / 32 to 104 °F Humidity: 20 to 80 %	
Accessories	3 user's manuals, 1 power cable, 2 small ferrite cores, 2 big ferrite cores, 1 remote control, 2 AA batteries	

Regulation

- CE Safety: EN60065
 - EMC: EN55022 1998, Class B
 - EN61000-3-2 1995
 - EN61000-3-3 1995
 - EN55024 1998
 - EN61000-4-2 1995
 - EN61000-4-3 1996
 - EN61000-4-4 1995
 - EN61000-4-5 1995
 - EN61000-4-6 1996
 - EN61000-4-8 1993
 - EN61000-4-11 1994
- AS Safety: IEC60065
 - EMC: AS/NZS 3548

Note

- Specifications and external appearance may be change for the sake of improvement.
- Viewing the screen constantly for extended periods can strain your eyes. Be sure to stay at a proper distance (at least 1.6 m or 5.2 feet for 42" / at least 1.9 m or 6.2 feet for 50" / at least 2.1 m or 6.9 feet for 55" / at least 2.4 m or 7.9 feet for 63") from the screen and to look occasionally away while working.
- **Plasmavision**™ is a worldwide trademark of Fujitsu General Limited and is a registered trademark in Japan, the U.S.A. and other countries or areas.



Plasmavision™

Contents

	Page	Page
Before Use		
• INFORMATION	E-2	
		• OTHER ADJUSTMENTS
		E-29
		• INITIALIZATION OF USER ADJUSTMENT VALUE ..
		E-35
Usage		Others
• USING THE REMOTE CONTROL	E-3	• CLEANING AND MAINTENANCE
• CONNECTING THE DISPLAY TO EXTERNAL EQUIPMENT	E-7	E-36
• BASIC OPERATIONS	E-12	
• SELECTING INPUT MODE	E-14	
• OTHER BASIC OPERATIONS	E-16	
• WATCHING PICTURES ON THE WIDE SCREEN....	E-17	
Adjustments		
• ADJUSTMENT MENU	E-19	
• BASIC PROCEDURE OF ADJUSTMENT MENU OPERATIONS	E-20	
• ADJUSTING THE PICTURE	E-21	
• ADJUSTING SCREEN POSITION AND SIZE	E-27	
• ADJUSTING AUDIO	E-28	

Before using the display, read the User's manual (1/2) and the User's manual (2/2) carefully so that you know how to use the display correctly.

Refer to this manual whenever questions or problems about operation arise. Be sure to read and observe the safety precautions (see the separate "Safety Precautions" manual).

Keep this manual where the user can see it easily.

* Installation and removal require special expertise. Consult your product dealer for details.

* When "English" is selected at "Language" of the on-screen display, "colour" will be displayed in the case of the R model and "color" will be displayed for all other models.

The notation used in this users' manual is "color".

INFORMATION

- Receptacle

Make sure that the power cable's grounding wire is grounded.

The display comes with a 3-prong power plug; one prong is connected to the grounding wire. If you have only a 2-hole receptacle, you will need to have it replaced. Contact your dealer for more information.

- Have the display inspected and cleaned by your dealer at regular intervals.
- Pictures may become "burnt" into the screen phosphors if the screen is left on for extended periods. To ensure that the display has a prolonged service life, be sure to use a screen orbiter, white screen. This will ensure the same picture or pattern is not constantly displayed for long periods. (See P. E-33.)
- Extremely high-precision technology has been used in the manufacture of the plasma display panel, with the effective pixel elements exceeding 99.99%. Please be aware, however, that fewer than 0.01% of the pixels may be missing or remain constantly lit.
- Some models are fitted with a radiator fan to prevent the display's internal temperature from rising during operation. Be careful of the air emitted by the radiator fan, as it may be hot.
- Contact your dealer if you find that the display does not seem to function properly when used with other audio-visual equipment.
You may need to move your display if it produces degraded pictures or noise due to electromagnetic radiation, or if the infrared remote control does not function properly.
- Pictures may not be displayed properly if you connect a non-standard PC to the RGB input terminal. In this case, contact your dealer for more information.
- The protective circuit, built into the display, automatically turns off the power if the display has a problem. In this case, you will see that the power indicator lamp flashes red or green.

Warning

If the power indicator lamp flashes red or green, this signifies that the display has developed a problem. When this happens, be sure to remove the power plug from the receptacle to prevent fire or electric shock. Then contact your dealer.

- Install the display in a location close to a main power supply outlet, and where the emergency stop button can be easily reached.

Note









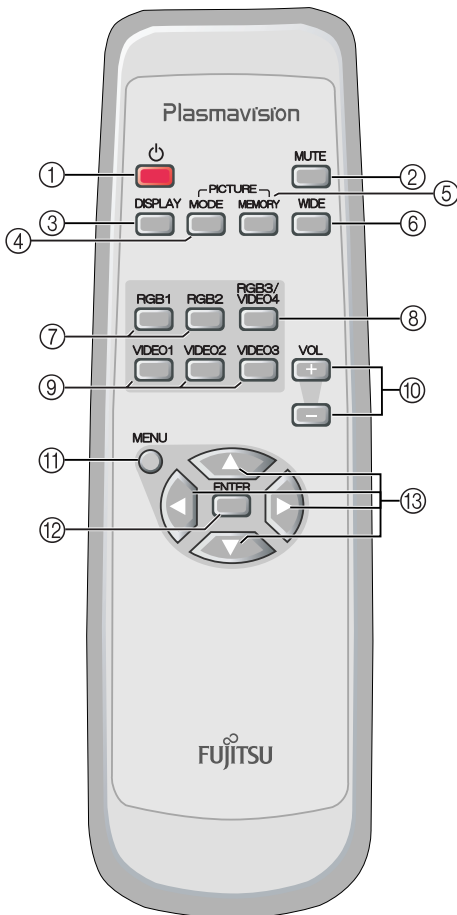











- Cables for connecting the display to external equipment are not supplied. Contact your dealer for more information on these products.
- In order to facilitate the explanations, pictures and diagrams in this manual may differ slightly from the actual items.

USING THE REMOTE CONTROL

REMOTE CONTROL (for the W/R models)

For details, see page →.



- ①  **button → E-12**
Switches between Power On and Standby.
- ②  **(MUTE button) → E-13**
Temporarily mutes the audio.
To return the audio to normal, press this button once again, or press the  does the  work also.
- ③  **(DISPLAY button) → E-16**
Press this button to display the input mode, and screen size status.
The status is displayed for about five seconds.
- ④  **(PICTURE MODE button) → E-16**
Use this button to switch the Picture Mode.
- ⑤  **(PICTURE MEMORY button) → E-16**
Press this button to recall a Picture Memory.
- ⑥  **(WIDE button) → E-17**
Switches the screen size.
- ⑦  -  **(RGB input mode selector button) → E-15**
Selects RGB1 - 2.
- ⑧  **(RGB3/VIDEO4 input mode selector button) → E-14**
Selects VIDEO4.
- ⑨  -  **(Video input mode selector button) → E-14**
Selects VIDEO1 - 3.
- ⑩   **(Volume adjustment buttons) → E-13**
Press these buttons to adjust the volume.
- ⑪  **(MENU button) → E-19-E-35**
Press this button to display the menu screen for adjusting the picture and/or the audio.
- ⑫  **(ENTER button) → E-19-E-35**
Press this button to fix the entry in the ADJUSTMENT MENU.
- ⑬     **(Adjustment buttons) → E-19-E-35**
Use these buttons to select the item or adjust the value in the menu screen.

Note

- Functions may not be available with some models and some device options.

USING THE REMOTE CONTROL (Continued)

REMOTE CONTROL (for the U model)

For details, see page →.

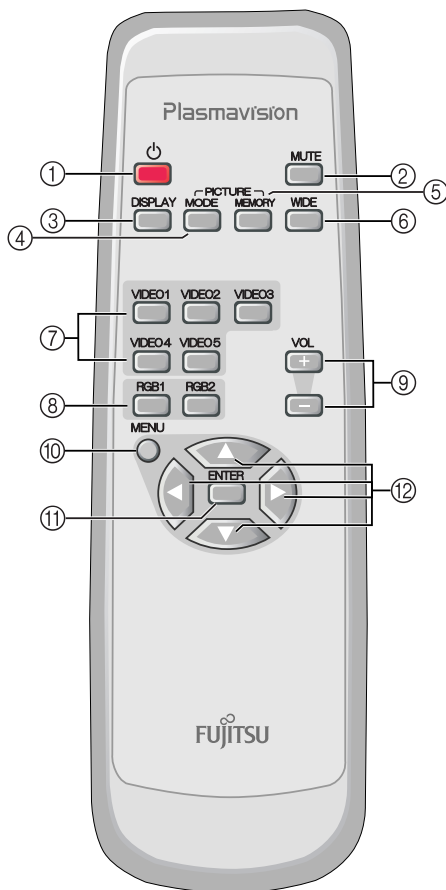

- ① **button → E-12**
Switches between Power On and Standby.
- ② **(MUTE button) → E-13**
Temporarily mutes the audio.
To return the audio to normal, press this button once again, or press the does the work also.
- ③ **(DISPLAY button) → E-16**
Press this button to display the input mode, and screen size status.
The status is displayed for about five seconds.
- ④ **(PICTURE MODE button) → E-16**
Use this button to switch the Picture Mode.
- ⑤ **(PICTURE MEMORY button) → E-16**
Press this button to recall a Picture Memory.
- ⑥ **(WIDE button) → E-17**
Switches the screen size.
- ⑦ - **(Video input mode selector button) → E-14**
Selects VIDEO1 - 5.
- ⑧ - **(RGB input mode selector button) → E-15**
Selects RGB1 - 2.
- ⑨ **(Volume adjustment buttons) → E-13**
Press these buttons to adjust the volume.
- ⑩ **(MENU button) → E-19-E-35**
Press this button to display the menu screen for adjusting the picture and/or the audio.
- ⑪ **(ENTER button) → E-19-E-35**
Press this button to fix the entry in the ADJUSTMENT MENU.
- ⑫ **(Adjustment buttons) → E-19-E-35**
Use these buttons to select the item or adjust the value in the menu screen.

Note

- Functions may not be available with some models and some device options.

PUTTING BATTERIES IN THE REMOTE CONTROL



(1) To remove the cover, slide it outwards while pressing it down.

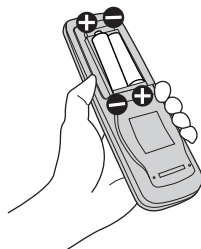

(2) Place two AA batteries in the remote control. Make sure that the batteries are properly oriented.



(3) Close the cover until it snaps into place.

PRECAUTIONS

To prevent malfunction, be sure not to apply any form of severe shock to the remote control.

To prevent malfunction or deformation, be sure not to allow the remote control to become wet; also, keep it away from hot locations or heating equipment.

Be sure not to clean the remote control using a cloth dampened in any volatile solvent, such as benzene or thinner.

CAUTION

Be sure to use replacement batteries of the same type as the original ones.

When disposing of used batteries, please comply with governmental regulations or environmental public institution's rules that apply in your country/area.

Note

The remote control will not function properly if the batteries are dead. Be sure to replace them as needed.

Do not use rechargeable batteries (Ni-Cd, etc.).

USING THE REMOTE CONTROL (Continued)

EFFECTIVE RANGE FOR THE REMOTE CONTROL

Point the remote control at the display's signal receiver when using it.

Make sure that there are no obstacles between the remote control and the display's signal receiver.

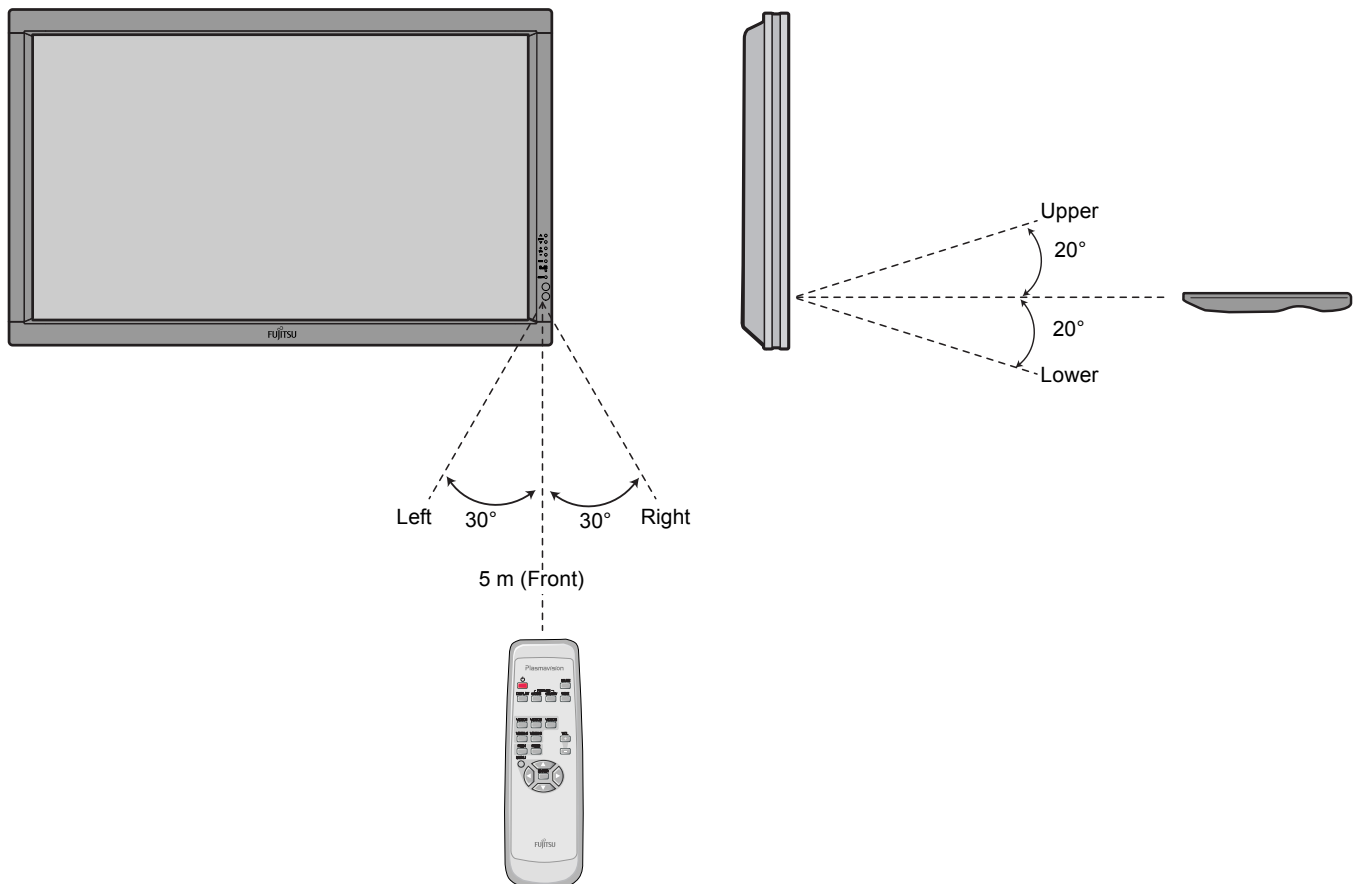

Note

The remote control may not function properly if you use a high-frequency fluorescent lamp. If you experience problems, move the lamp or use the remote control from a different position.

CONNECTING THE DISPLAY TO EXTERNAL EQUIPMENT

EXAMPLE OF CONNECTION TO EXTERNAL COMPONENTS

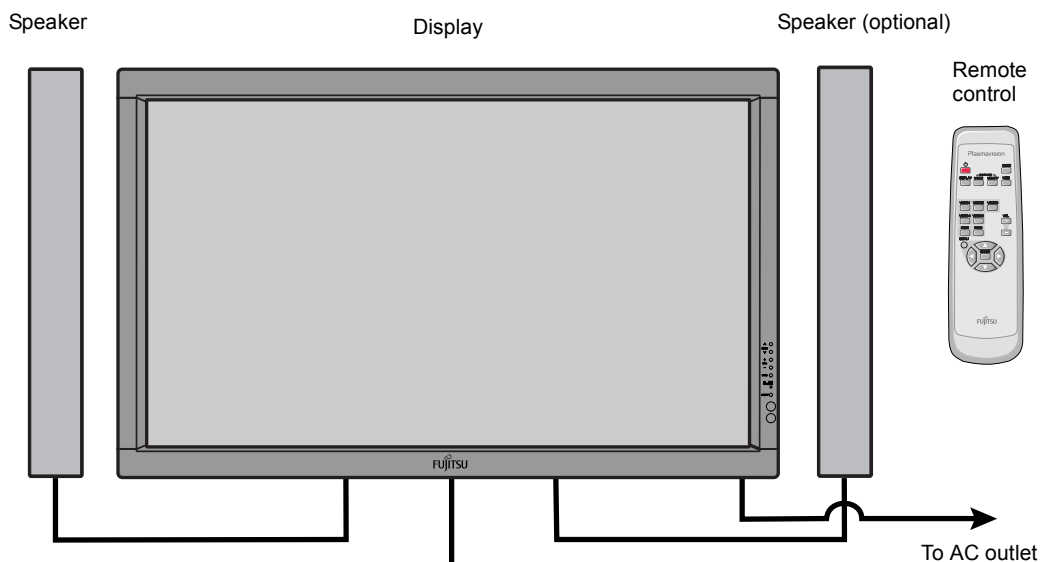

VCR or other external components See P. →

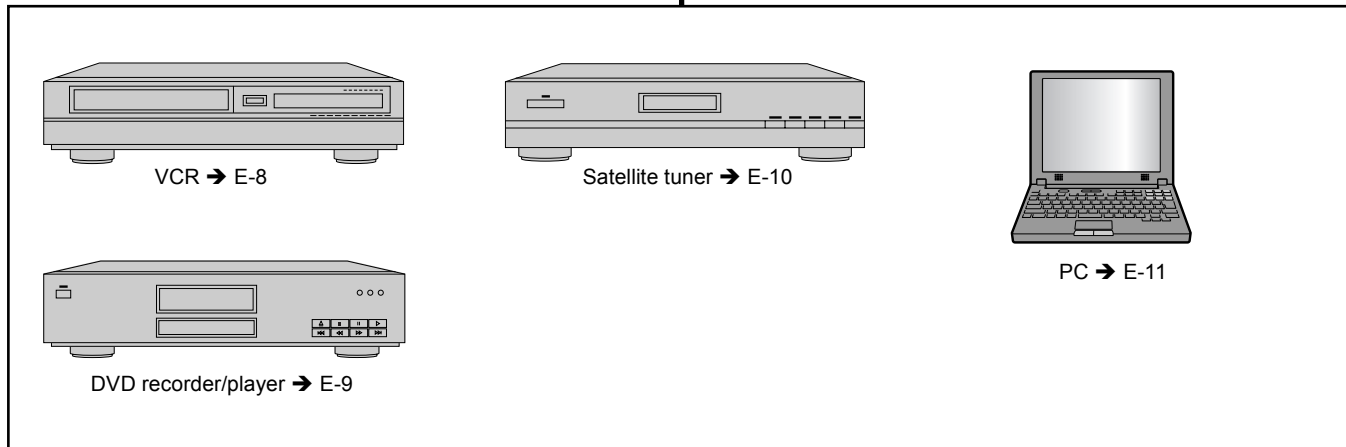

CONNECTING THE DISPLAY TO EXTERNAL EQUIPMENT (Continued)

VCR

- Connect the video signal cable to either the S-video input terminal or the video input terminal.
- If the unit to be connected is equipped with S-video output terminal, it is recommended to connect to the S-video terminal.

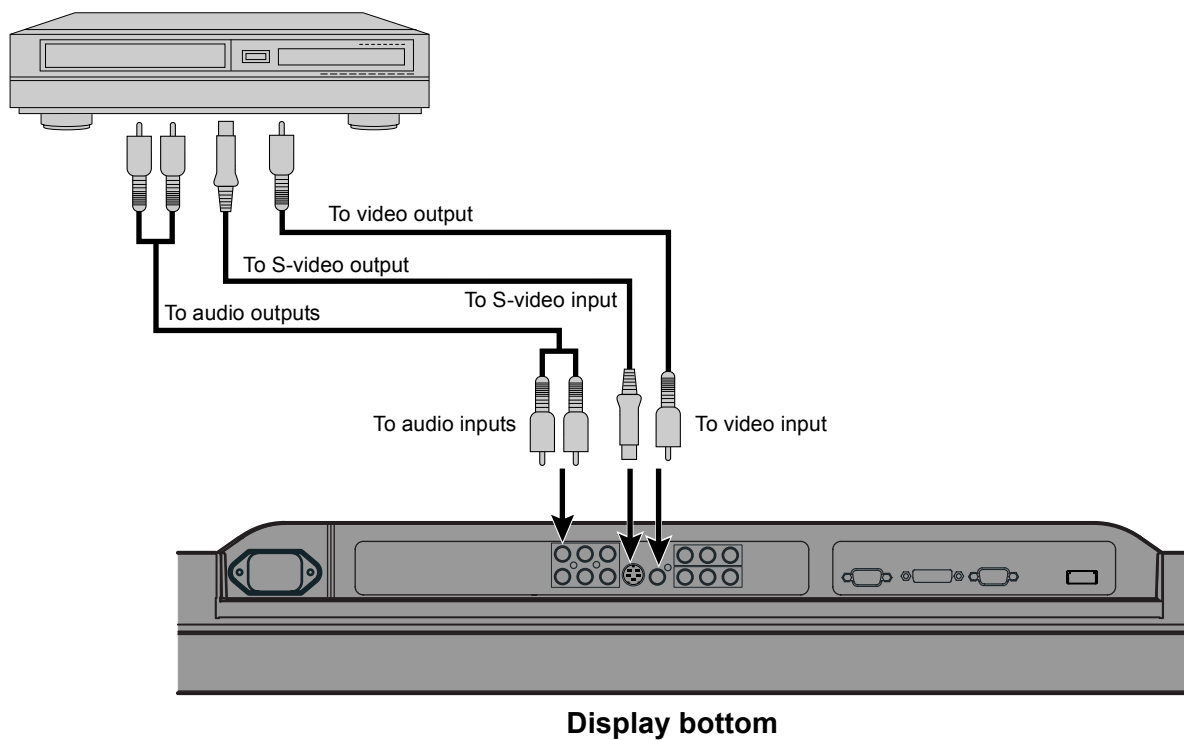

DVD RECORDER/PLAYER

- Connect the video signal cable to the HDMI input terminal, component video input terminal, S-video input terminal, or the video input terminal.
- If the component to be connected is equipped with HDMI output terminal, component video output terminal, it is recommended to connect to the component video terminal.

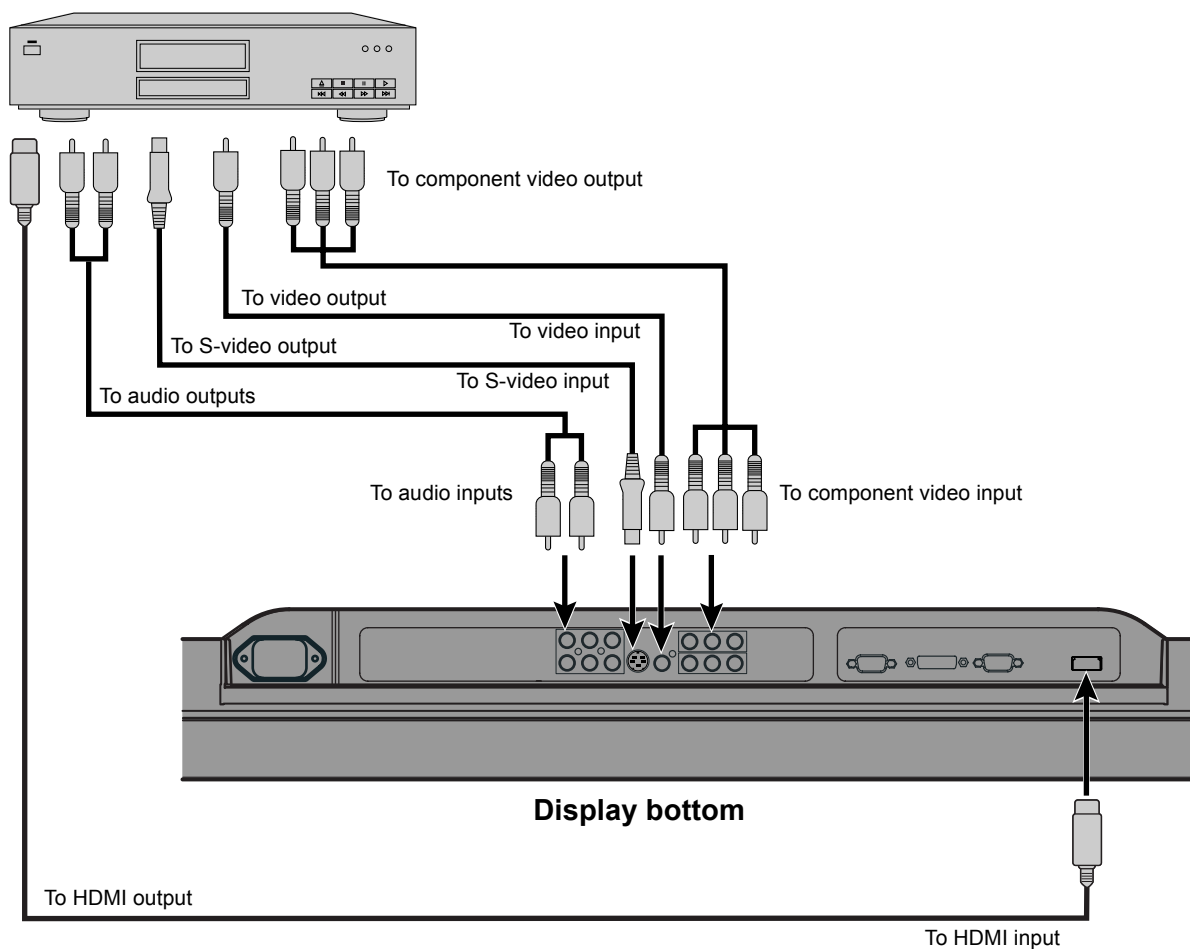

Note

- Unplug the power cord from the AC outlet before you connect external components.
- Also refer to the instructions for the component to be connected.
- When inputting audio, connect to the terminals corresponding to the used video input or RGB input.
- Terminal layout may differ and functions may not be available with some models and some device options.

CONNECTING THE DISPLAY TO EXTERNAL EQUIPMENT (Continued)

SATELLITE TUNER

- Connect the video signal cable to the HDMI input terminal, component video input terminal, S-video input terminal, or the video input terminal.
- If the component to be connected is equipped with HDMI output terminal, component video output terminal, it is recommended to connect to the component video terminal.

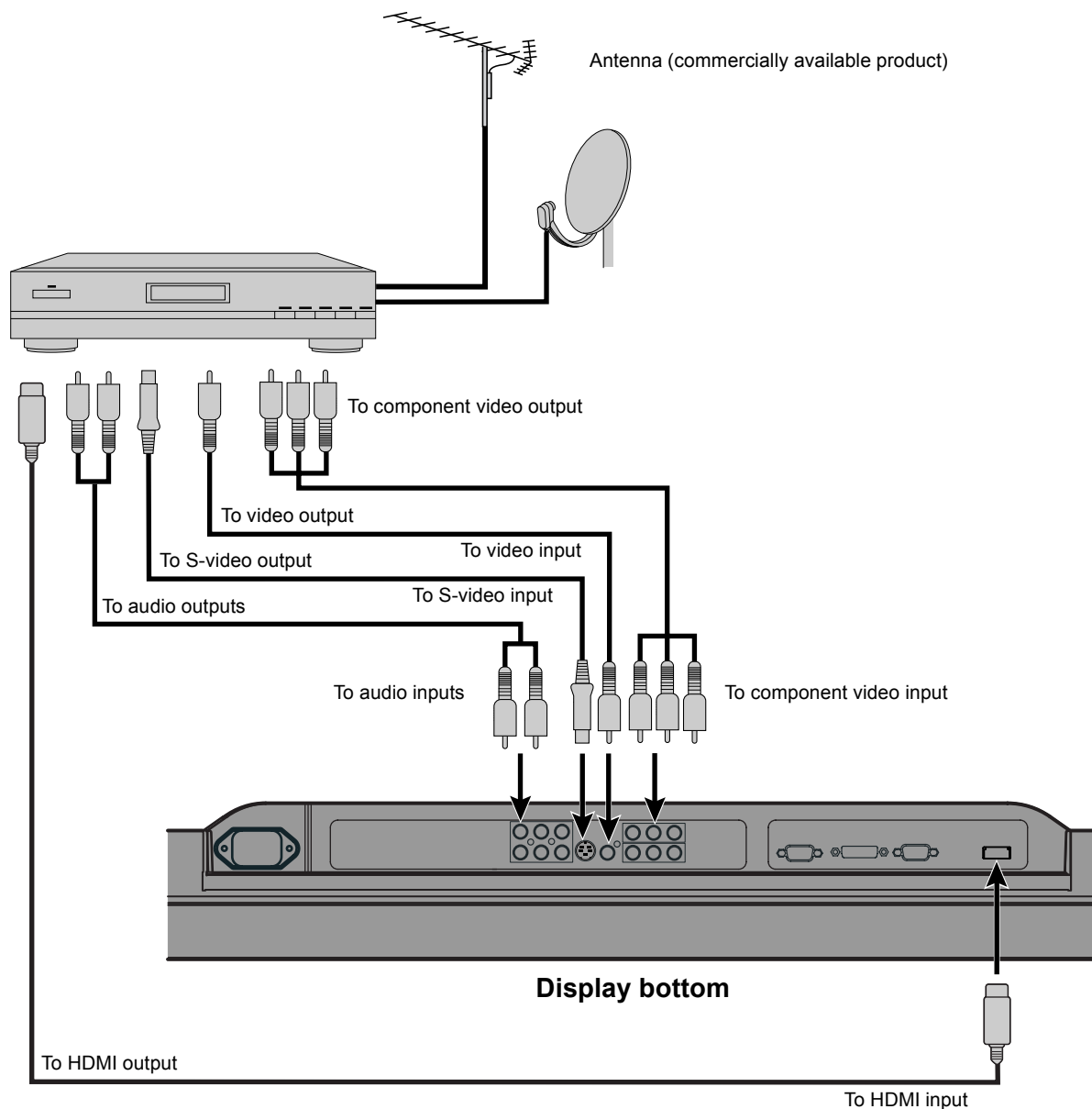

PC

- As the cable for connecting a PC differs with the PC model, please consult your dealer for information on the right cable to purchase.

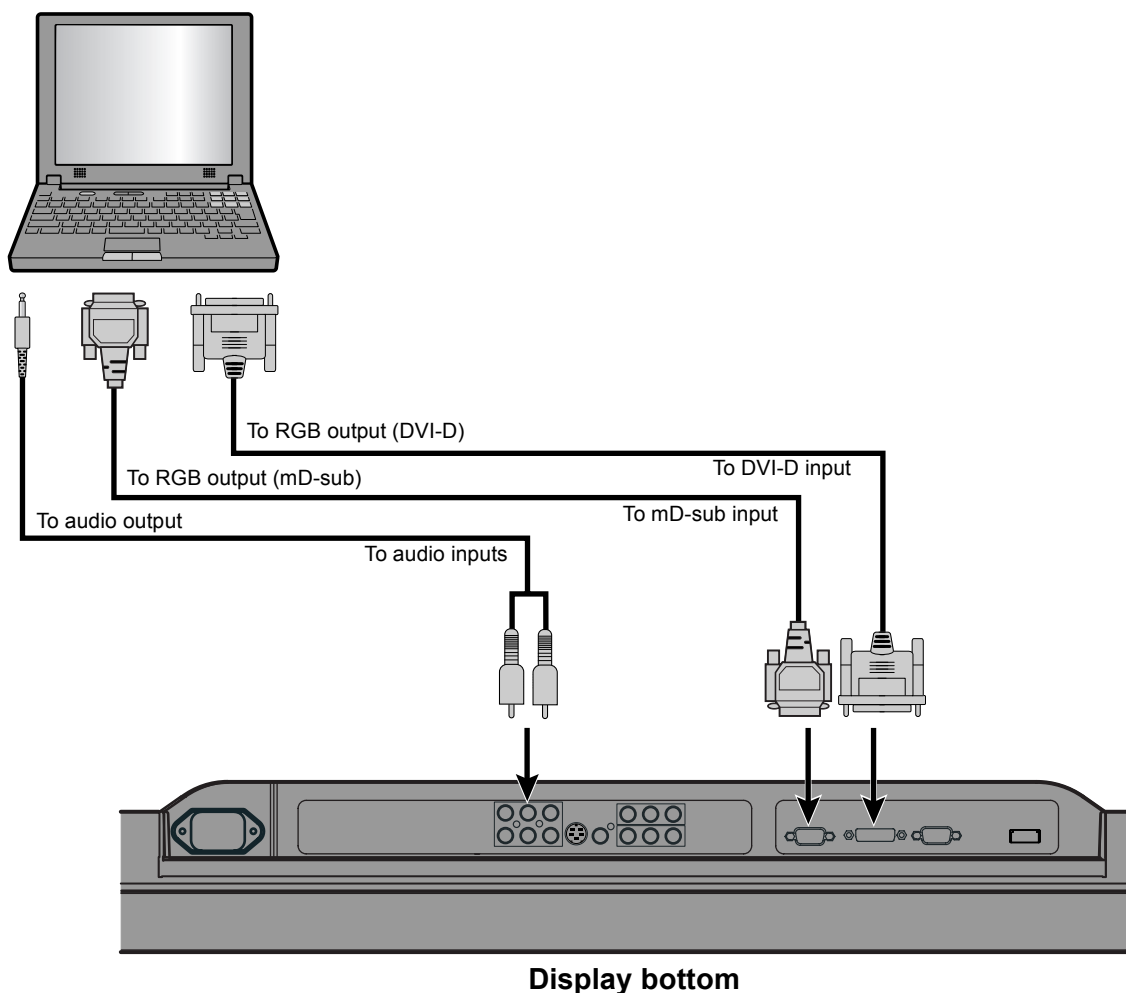

**Note**

- Unplug the power cord from the AC outlet before you connect external components.
- Also refer to the instructions for the component to be connected.
- When inputting audio, connect to the terminals corresponding to the used video input or RGB input.
- Terminal layout may differ and functions may not be available with some models and some device options.

BASIC OPERATIONS

TURNING THE POWER ON AND STAND-BY







- 1** Press  to the left at the bottom of the display to the ON  state.

The power lamp lights up.

- 2** Press  on the remote control.

The color of the power lamp changes from "Red" to "Green".

- 3** Press  -  or  - .

Select the video mode to input.

- 4** Press  when the power is ON.

The color of the power lamp changes from "Green" to "Red" and the power turns "OFF (Stand-by state)".

* You can also use the buttons on the display's control panel to perform these steps.
(for the W/R models)





* You can also use the buttons on the display's control panel to perform these steps.
(for the U model)

ADJUSTING THE VOLUME



Adjusting the volume

Press  to increase the volume.

Press  to reduce the volume.

* Note that the volume level remains stored even when you turn OFF the power.

Muting the audio

Press .

The audio is removed.

Press again to restore the audio to the original level.

The mute mode can also be released by pressing the volume buttons.

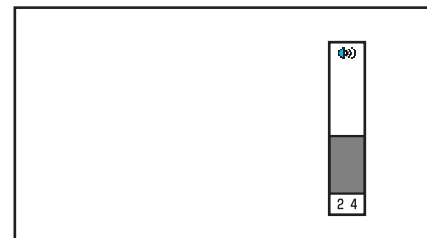

When the volume adjustment button is pressed

* You can also use the buttons on the display's control panel to perform these steps.

(Ex. the W model)

Note

- Functions may not be available with some models and some device options.

SELECTING INPUT MODE

VIDEO INPUT MODE (for the W/R models)



1 Press  -  to select the input mode.

You can select from VIDEO1 mode to VIDEO4 mode.

The video modes corresponding to each input terminal are as follows.

- VIDEO1: Video
- VIDEO2: S-video
- VIDEO3: Component video
- VIDEO4: Component video

* For selection of the input terminal, see “SETTING THE INPUT TERMINALS” on P. E-31.



Video1 mode

* You can also use the buttons on the display's control panel to perform these steps.

VIDEO INPUT MODE (for the U model)



1 Press  -  to select the input mode.

You can select from VIDEO1 mode to VIDEO5 mode.

The video modes corresponding to each input terminal are as follows.

- VIDEO1: Video
- VIDEO2: S-video
- VIDEO3: Component video
- VIDEO4: Component video
- VIDEO5: HDMI

* For selection of the input terminal, see “SETTING THE INPUT TERMINALS” on P. E-31.



Video1 mode

* You can also use the buttons on the display's control panel to perform these steps.

RGB INPUT MODE



1 Press - to select the input mode.

You can select between the modes from RGB1 to RGB2.

The input terminal of each RGB mode is as follows.

[for the W/U models]

- RGB1: DVI-D
- RGB2: mD-sub

[for the R model]

- RGB1: mD-sub

* For selection of the input terminal, see
“SETTING THE INPUT TERMINALS” on
P. E-31.



RGB1 mode

* You can also use the buttons on the display's control panel to perform these steps.
(Ex. the U model)

OTHER BASIC OPERATIONS

CONVENIENT FUNCTIONS



(Ex. the W/R models)

On-screen information

Press  .

The mode is indicated on the screen for 5 seconds.

Picture Mode

Press  .

This button can be used to switch the picture mode.

In the picture mode, you can switch between the set status and the fine mode.

* For the picture mode settings, see “Setting Picture Mode (P. E-22)”.

Picture Memory

Press  .

This button can be used to recall the settings of the picture memories 1 – 8. Each time this button is pressed, the setting changes as follows.

→Memory1→Memory2→Memory3→Memory4→Memory5→Memory6→Memory7→Memory8→

* For the picture memory settings, see “Setting Picture Memory (P. E-22)”.

Note

- Functions may not be available with some models and some device options.

SWITCHING BETWEEN SCREEN SIZES



1 Press  .
The currently selected mode will appear.

2 Press  to select a desired Screen Size.

Each time you press  , a different Screen Size appears. The sequences used are as follows:

When you are in a Video input mode

→Normal→Wide1→Wide2
Zoom2 ← Zoom1 ←

When you are in an RGB input mode

→Normal→Wide→Zoom

* Depending on the type of signal, some aspects may not be selected.

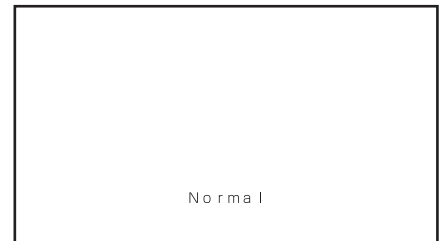

Normal mode



Wide1 mode

* You can also use the buttons on the display's control panel to perform these steps.
(Ex. the W/R models)

Note

- Displaying a picture in a Normal mode for extended periods of time may cause phosphor burn-in.
- A variety of Screen Sizes are available with this display. Remember that if you select a mode with an aspect ratio (ratio of frame width to frame height) different from that of the TV program or video media, the pictures will appear differently than if you had selected a mode having the same aspect ratio.
- Showing a movie or similar premium event at a different aspect ratio from its original one at any event site, restaurant, or bar for profit-making purposes or for a public audience may constitute a copyright infringement.
For films, try to select a mode having the same aspect ratio as the original picture; this enables the director's original intentions to be preserved.
- See P. E-27 for how to adjust the picture size and position.

WATCHING PICTURES ON THE WIDE SCREEN (Continued)

SCREEN SIZE

Normal (Video/RGB)

Displays pictures of normal size (i.e., a 4:3 aspect ratio).

Wide1 (Video)

Displays natural-looking pictures of standard size on the wide screen.

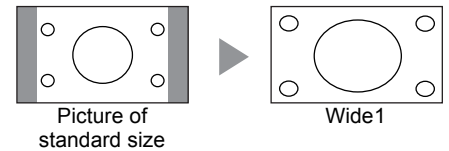

Wide2 (Video)/Wide (RGB)

Ideal for displaying vertically extended pictures such as squeezed pictures.

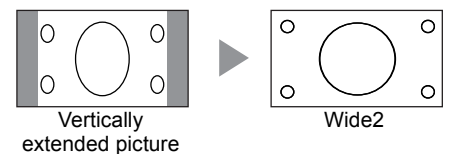

Zoom1 (Video)/Zoom (RGB)

Enlarges horizontally extended pictures equally in all directions to maintain the aspect ratio constant.

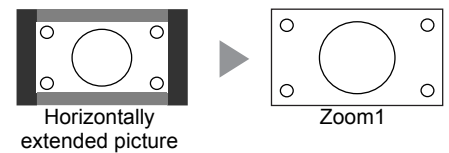

Zoom2 (Video)

Reduces the height of horizontally extended pictures with captions, without eliminating the caption. Only the height of pictures is reduced, not the height of the caption.

(Captions may not be easy to read, however, depending on the picture.)

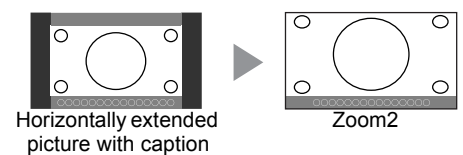

ASPECT RATIO

The following aspect ratios are available.

4:3 aspect ratio
(VHF/UHF broadcasting, BS broadcasting)

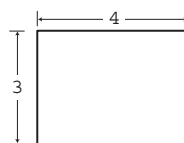

16:9 aspect ratio
(HDTV broadcasting)

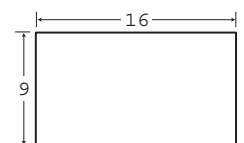

1.85:1 aspect ratio
(Vista Vision size)

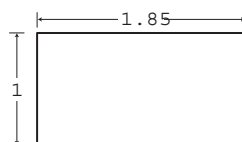

2.35:1 aspect ratio
(Cinema Vision size)

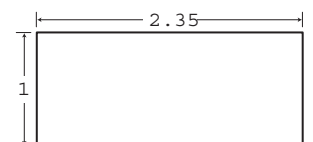

Note

You may find dark areas on top and at the bottom of the screen if you select one of the Zoom modes for media while using the Vista Vision or Cinema Vision size i.e., the sizes used frequently for picture software.

- Functions may not be available with some models and some device options.

ADJUSTMENT MENU

The numbers in parentheses () indicate the reference page numbers.

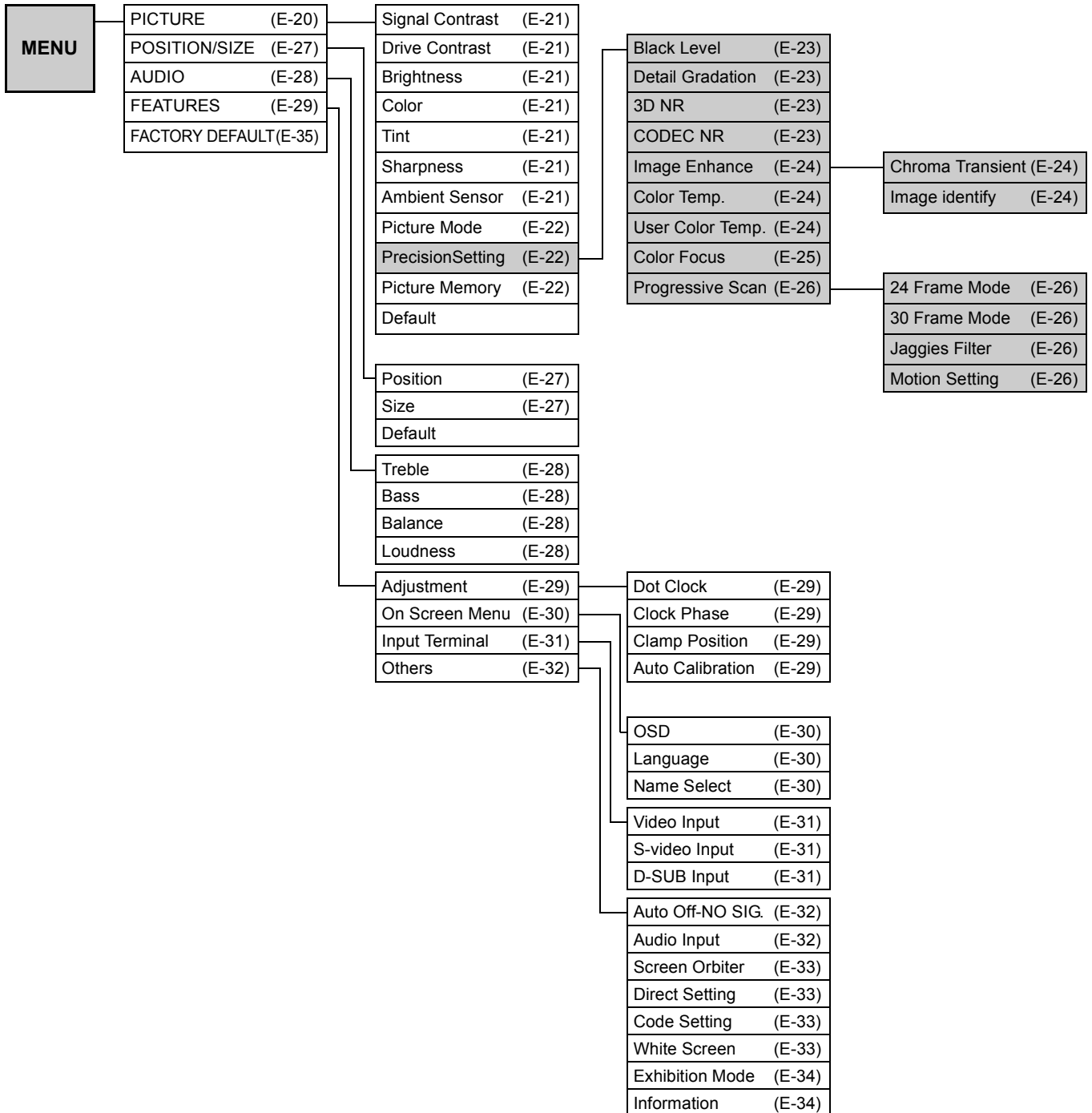

Note

- The shaded menu items are applied to the U model only.
- Some type of signal can not be selected.

BASIC PROCEDURE OF ADJUSTMENT MENU OPERATIONS

- Below is shown the basic procedure to make changes to the options in the ADJUSTMENT MENU. (Ex.: adjusting tint setting (Tint))



(Ex. the W/R models)

1 Press .
The main menu screen will appear.

2 Press or to select "PICTURE".

Each time you press or , one of the available menus appears in the following sequence:

PICTURE ↔ POSITION/SIZE ↔ AUDIO ↔ FEATURES ↔ FACTORY DEFAULT

The PICTURE Menu screen will appear.

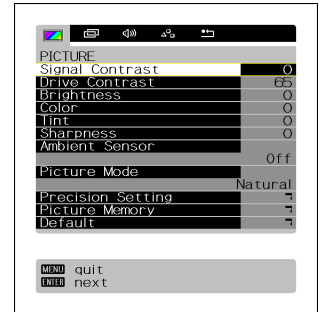

"PICTURE" selected in the main menu screen

3 Press or to select "Tint".

4 Press .
The "Tint" adjustment screen will appear.

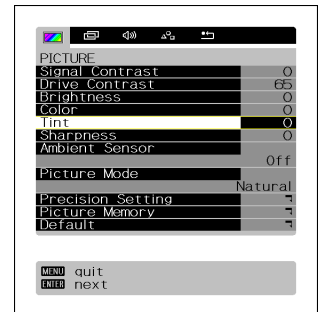

"Tint" selected in the PICTURE Menu screen

5 Press or to change tint values.

: More greenish colors

: More purplish colors

6 Press to store.

7 Press when you finish.

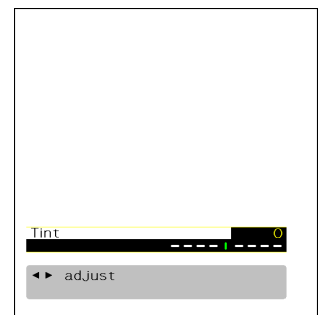

"Tint" adjustment screen

* Repeat steps 3, 4, 5 and 6 when you wish to make changes to other options.

* When is pressed after you have selected "Default", the settings are returned to those that were valid when you purchased the set.

* Press to halt the operation in progress.

Note

- On-screen information disappears if you do not take any action for about 60 seconds.
- Functions may not be available with some models and some device options.
- The adjustment range varies with the display signal. You can adjust the display quality to the value you want within the adjustable range.

- Picture-related items can be set and adjusted in the Picture Adjustment Screen. See BASIC PROCEDURE OF ADJUSTMENT MENU OPERATIONS on page E-20 for the basic operation procedures.

Adjusting the Signal Contrast

Press  to increase the input signal contrast.

Press  to reduce the input signal contrast.

Press  to store.

Adjusting the Drive Contrast

Press  to raise the display's luminance level, and increase the contrast.

Press  to lower the display's luminance level, and reduce the contrast.

Press  to store.

Adjusting the Brightness

Press  to increase the brightness.

Press  to reduce the brightness.

Press  to store.

Adjusting Color

Press  to darken the color.

Press  to lighten the color.

Press  to store.

Adjusting the Tint

Press  to change the tint to a more greenish color.

Press  to change the tint to a more purplish color.

Press  to store.

Adjusting the Sharpness



Press  to sharpen the Sharpness.

Press  to soften the Sharpness.

Press  to store.

Adjusting the Ambient Sensor

Automatically adjusts the Sharpness to an optimized level that matches the brightness of the surrounding area.

Each time  or  is pressed, the setting is switched.

On ↔ Off

Press  to store.

Note

- The screen display disappears if there is no operation within approximately 60 seconds.
- Depending on the model or the optional devices, some of the functions may not be available.
- The adjustment range varies according to the display signals. Make adjustments to your preferred Sharpness within the adjustment range.
- Depending on the type of signal, it may not be possible to make some of the settings or adjustments.

ADJUSTING THE PICTURE (Continued)

Setting Picture Mode

Each time you press \leftarrow or \rightarrow , the available choices appear in the following sequence.

\rightarrow Natural \leftrightarrow Fine \leftrightarrow Effective \leftrightarrow Conventional \leftrightarrow Still \leftarrow

[Natural]: Enables you to watch pictures with natural color tones and high picture clarity. This mode is suitable for watching a normal motion picture.

[Fine]: Suitable for watching a dark picture such as a movie.

[Effective]: Displays a screen with detailed contrast.

[Conventional]: Displays a screen approximating that of a conventional TV screen.

[Still]: Suitable for viewing a still picture.

Press ENTER to store.

Precision Setting (for the U model)

Enables advanced Sharpness adjustments.

See page E-23 for details.

Setting Picture Memory

The adjustment status of eight groups of picture adjustment settings can be stored, enabling you to quickly switch to your desired group of settings for the picture you are planning to watch.

[Save]: Use \leftarrow or \rightarrow to select Memory 1 - 8. If ENTER is pressed, the current picture adjustment values are stored to the selected Memory.

[Load]: Use \leftarrow or \rightarrow to select Memory 1 - 8. When ENTER is pressed, the values becomes the picture adjustment values stored in the selected Memory.

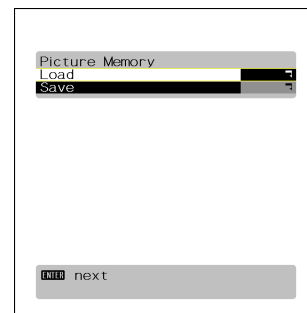

Picture Memory Selection Screen

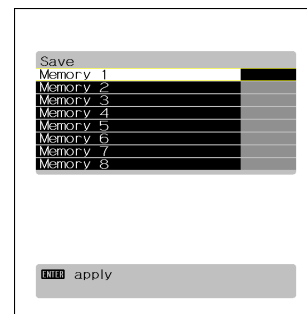

"Save" Selection Screen

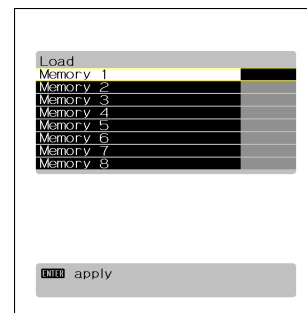

"Load" Selection Screen

PRECISION SETTING (for the U model)

- See BASIC PROCEDURE OF ADJUSTMENT MENU OPERATIONS on page E-20.

Even more advanced Sharpness adjustments can be made as required.

Adjusting the Black Level

Press \leftarrow to strengthen the reproduction of black. (Provides a picture quality with deep blacks.)

Press \rightarrow to weaken the reproduction of black.

Press ENTER to store.

Setting Detail Gradation

Corrects the gradation of the light and dark areas of the picture.

Each time \leftarrow or \rightarrow is pressed, the setting is switched.

On \leftrightarrow Off

Press ENTER to store.

Setting 3D NR

This enables noise reduction processing with respect to the input signal noise level (reduces screen flicker for more comfortable viewing).

Each time you press \leftarrow or \rightarrow , the available choices appear in the following sequence.

\rightarrow Off \leftrightarrow Min. \leftrightarrow Std. \leftrightarrow Max. \leftarrow

Press ENTER to store.

Setting CODEC NR

This enables noise reduction processing of mosquito noise or block noise generated when digital picture signals are recorded or replayed.

Each time you press \leftarrow or \rightarrow , the available choices appear in the following sequence.

\rightarrow Off \leftrightarrow Min. \leftrightarrow Std. \leftrightarrow Max. \leftarrow

Press ENTER to store.

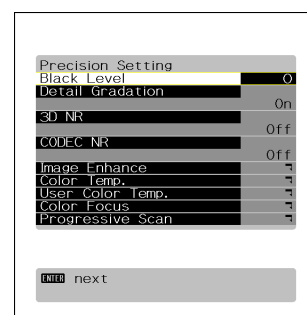

Precision Setting Selection Screen

Note

- The screen display disappears if there is no operation within approximately 60 seconds.
- Depending on the model or the optional devices, some of the functions may not be available.
- The adjustment range varies according to the display signals. Make adjustments to your preferred Sharpness within the adjustment range.
- Depending on the type of signal, it may not be possible to make some of the settings or adjustments.



ADJUSTING THE PICTURE (Continued)

Setting Image Enhance

This performs detailed image quality settings.

- **Chroma Transient**

This function corrects the color contours.



Each time  or  is pressed, the setting is switched.

On ↔ Off

Press  to store.

- **Image Identify**





This function discerns between the natural image display section and the text display section, and performs correction to enable an optimized display for each.







Each time  or  is pressed, the setting is switched.

On ↔ Off

Press  to store.

Adjusting the Color Temp.

Use  or  to specify a desired color temperature. Each time you press  or , one of the available choices appears in the following sequence:

 -3500  ...  Standard  ...  +3500  User 

[-3500]: More reddish colors

[+3500]: More bluish colors

[User]: User Color Temp. setup

Press  to store.

Setting User Color Temp.

Use  or  to select Red, Green, or Blue, and adjust the color temp. for each.

Press : to strengthen the selected color.

Press : to weaken the selected color.

Press  to store.

Setting the Color Focus

This enables correction with respect to specific color hues within the image.

Independent correction of the hue of skin colors, blue skies, and so on, enables a more brilliant display.

- **[Reddish color]**

With red at the center, performs the following corrections with respect to the range from magenta to yellow.

[Tint]: Use \leftarrow and \rightarrow to adjust the hue.

[Color]: Use \leftarrow and \rightarrow to adjust the color depth.

[Red]: Use \leftarrow and \rightarrow to adjust the strength of the red color range.

[Green]: Use \leftarrow and \rightarrow to adjust the strength of the green color range.

[Blue]: Use \leftarrow and \rightarrow to adjust the strength of the blue color range.

Press ENTER to store.

Adjustments can be made in the same way for:

- **[Greenish color]: (With green at the center, performs corrections with respect to the range from yellow to cyan.)**
- **[Bluish color]: (With blue at the center, performs corrections with respect to the range from cyan to magenta.)**

- **[Targeting Red]**

This function corrects the hue and color depth with respect to Red.

[Tint]: Use \leftarrow and \rightarrow to adjust the hue.

[Color]: Use \leftarrow and \rightarrow to adjust the color depth.

Press ENTER to store.

Adjustments can be made in the same way for:

- **[Targeting Yellow] (Performs correction with respect to Yellow.)**
- **[Targeting Green] (Performs correction with respect to Green.)**
- **[Targeting Cyan] (Performs correction with respect to Cyan.)**
- **[Targeting Blue] (Performs correction with respect to Blue.)**
- **[Targeting Magenta] (Performs correction with respect to Magenta.)**

- **[Targeting White]**

Corrects red, green, and blue with respect to white.

[Red]: Use \leftarrow and \rightarrow to adjust Red.

[Green]: Use \leftarrow and \rightarrow to adjust Green.

[Blue]: Use \leftarrow and \rightarrow to adjust Blue.

Press ENTER to store.

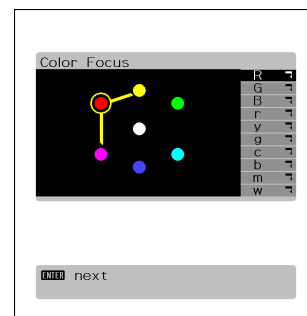

Color Focus (Reddish color)
Settings Screen

Note

- The screen display disappears if there is no operation within approximately 60 seconds.
- Depending on the model or the optional devices, some of the functions may not be available.
- The adjustment range varies according to the display signals. Make adjustments to your preferred Sharpness within the adjustment range.
- Depending on the type of signal, it may not be possible to make some of the settings or adjustments.



ADJUSTING THE PICTURE (Continued)

Making the Progressive Scan Settings

This sets the conversion processing of interlace signals to block receive signals.

• 24 Frame Mode

This function enables the optimized display of movies, etc. with 24 frames/second signals.



Each time  or  is pressed, the setting is switched.

Auto ↔ Off

Press  to store.

• 30 Frame Mode

This function enables the optimized display of movies, etc. with 30 frames/second signals.



Each time  or  is pressed, the setting is switched.

Auto ↔ Off

Press  to store.

• Jaggies Filter

This function alleviates the phenomenon where jagged diagonal lines can be seen when interlace signals are input, thus enabling a smoother motion picture display.

Each time  or  is pressed, the setting is switched.

Auto ↔ Off

Press  to store.

• Motion Setting

The detecting sensitivity for motion picture is set.

The response of the picture processing is valued in the motion picture priority setting.

Press : to specify still picture priority.

Press : to specify motion picture priority.

Press  to store.

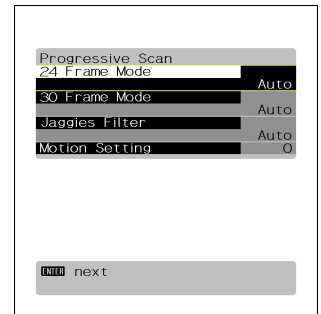

Progressive Scan Settings Screen

Note

- The screen display disappears if there is no operation within approximately 60 seconds.
- Depending on the model or the optional devices, some of the functions may not be available.
- The adjustment range varies according to the display signals. Make adjustments to your preferred Sharpness within the adjustment range.
- Depending on the type of signal, it may not be possible to make some of the settings or adjustments.

ADJUSTING SCREEN POSITION AND SIZE

- You can make changes to all screen adjustment options in the POSITION/SIZE Menu. See Page E-20 for the basic operation procedures.
- The changes you make will be stored for the selected input mode. Therefore, you need to select a desired input mode before making any changes.

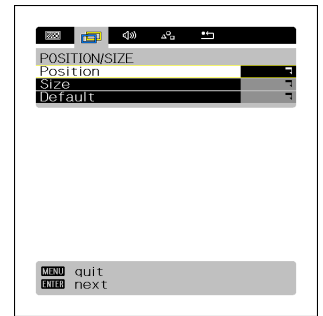

POSITION/SIZE Menu screen

Adjusting Screen Position (Position)

Horizontal position (Horizontal)

◁: Moves screen to the right.



▷: Moves screen to the left.

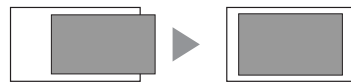

Vertical position (Vertical)

⬆: Moves screen up.



⬇: Moves screen down.



Press **ENTER** to store.

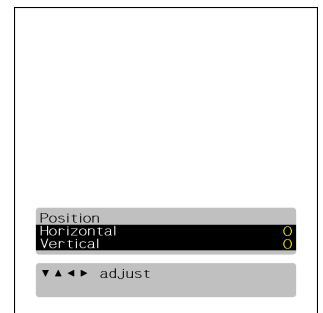

"Position" adjustment screen

Adjusting Screen Size (Size)

Screen width (Width)

◁: Increases width.



▷: Reduces width.



Screen height (Height)

⬆: Increases height.



⬇: Reduces height.



Press **ENTER** to store.

*You cannot adjust screen size in DVI-D mode.

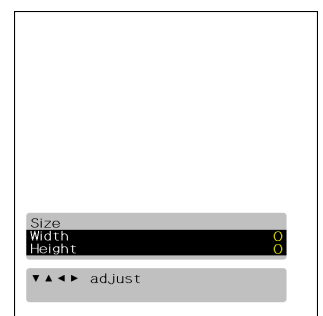



"Size" adjustment screen

ADJUSTING AUDIO

- You can make changes to all audio adjustment options in the AUDIO Menu. See Page E-20 for the basic operation procedures.
- The changes you make will be stored for the selected input mode. Therefore, you need to select a desired input mode before making any changes.

Adjusting Treble (Treble)



Press   to make adjustments.

: Stronger treble

: Weaker treble

Press  to store.

Adjusting Bass (Bass)



Press   to make adjustments.

: Stronger bass

: Weaker bass

Press  to store.

Adjusting Volume Balance (Balance)

Press   to make adjustments.



: Shifts the volume balance towards the right.

: Shifts the volume balance towards the left.

Press  to store.

Setting Loudness (Loudness)

Corrects the balance between bass and treble for easy listening even with weak volume.

Each time you press  or , one of the available choices appears in the following sequence:

On ↔ Off

Press  to store.

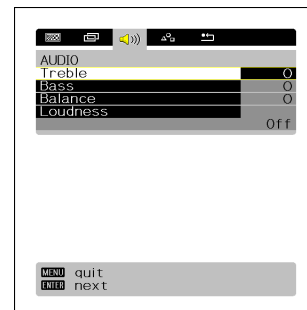

AUDIO Menu screen

Note

- The screen display disappears if there is no operation within approximately 60 seconds.
- Depending on the model or the optional devices, some of the functions may not be available.
- The adjustment range varies according to the display signals. Make adjustments to your preferred Sharpness within the adjustment range.
- Depending on the type of signal, it may not be possible to make some of the settings or adjustments.
- Audio Input menu will not be displayed when "No Audio" is selected. (See P. E-36.)

- **FEATURES setup screen has the following 4 options.**

See Page E-20 for the basic operation procedures.

[Adjustment]: Can make a fine adjustment of pictures such as Dot Clock, Clamp Position.

[On Screen Menu]: Can make a display setting such as OSD, Language. (See P. E-30.)









[Input Terminal]: Can make an input terminal setting such as Video Input. (See P. E-31.)

[Others]: Used to make Screen Orbiter and other settings. (See P. E-32–E-34.)

ADJUSTMENT

Dot Clock, Clock Phase, Clamp Position, and Auto Calibration are adjusted as shown in the following chart.

Select the item with   , and then adjust with   . Finally, press  to implement the adjustments.

Adjustment Item	Contents of Adjustments	Operation
Dot Clock (mD-sub)	You may find the vertically-striped pattern in pictures, depending on the clock frequency of your PC's processor. If you experience blurring, you can obtain a clearer picture by adjusting the "Dot Clock".	Use   to adjust to minimize vertically-striped pattern in pictures.
Clock Phase (mD-sub)	Pictures and the outline of letters may blur or flicker as the clock phase of your PC may be different. In this case, adjust the clock phase manually. Normally, the automatic setting ensures the optimal value.	Use   to adjust to minimize pictures blur.
Clamp Position (mD-sub, Comp. video)	Adjusts the extremely dark or bright pictures. Normally, the automatic setting ensures the optimal value.	Use   to adjust pictures optimally.
Auto Calibration (mD-sub)	Adjusts the dynamic range of images to the optimum. Performed while a white screen signal is received.	Display the Auto Calibration screen and select Execute, and then use   to select the item.

OTHER ADJUSTMENTS (Continued)

ON SCREEN MENU

• Setting Display Information (OSD)

You can use this option to select whether to display information other than menus. (Error messages are displayed regardless of what choice you make for this option.)

Each time you press \leftarrow or \rightarrow , one of the available choices appears in the following sequence:

\rightarrow On(OSD:bright) \leftrightarrow On(OSD:dark) \leftrightarrow Off \leftarrow

[On (OSD:bright)]: On-screen information shown in light color.

[On (OSD:dark)]: On-screen information shown in dark color.

[Off]: Except for menus and error messages, on-screen information is not displayed.

Press ENTER to store.

* When the screen is white [On (OSD:dark)], some of the information may be difficult to read.

• Selecting Language (Language)

You can use this option to select the language displayed on the screen.

(1) Select "Language" and press ENTER .

The "Language" selection screen will appear.

(2) Press \leftarrow or \rightarrow to select your desired language.

English

Español (Spanish)

Français (French)

Português (Portuguese)

Русский (Russian) for the R model

(3) Press ENTER .

The menu is displayed in the selected language.

• Selection of indications (Name Select)

You can change the settings for indications for video inputs and RGB inputs.

Video input

You can change the settings for indications for the VIDEO inputs.

Select the desired indication in accordance with the connected equipment.

Each time \leftarrow \rightarrow is pressed, the setting is switched. (In the case of VIDEO1)

\rightarrow Video1 \leftrightarrow DVD1 \leftrightarrow DVD2 \leftrightarrow VCR1 \leftrightarrow VCR2 \leftrightarrow GAME \leftrightarrow Camcorder \leftrightarrow STB \leftrightarrow Satellite \leftrightarrow Cable TV \leftarrow

Press ENTER to store.

RGB input

You can change the settings for indications for the RGB inputs.

Select the desired indication in accordance with the connected equipment.

Each time \leftarrow \rightarrow is pressed, the setting is switched. (In the case of RGB 1)

\rightarrow RGB1 \leftrightarrow PC1 \leftrightarrow PC2 \leftrightarrow DVD1 \leftrightarrow DVD2 \leftrightarrow STB \leftrightarrow Satellite \leftrightarrow Cable TV \leftarrow

Press ENTER to store.

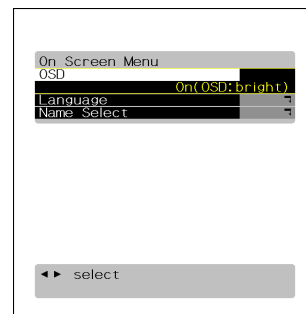

OSD selection screen

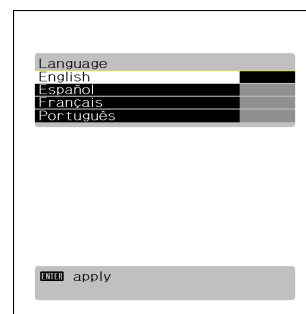

"Language" selection screen
(In the case of the W/U model)

SETTING THE INPUT TERMINALS

• Selecting the settings of Video/S-video Input terminal

You can use this option to select the color format appropriate for the input signal.

Each time you press \leftarrow or \rightarrow , one of the available modes appears in the following sequence:

\rightarrow Auto1 \leftrightarrow Auto2 \leftrightarrow NTSC \leftrightarrow PAL \leftrightarrow SECAM \leftrightarrow PAL60 \leftrightarrow N-PAL \leftrightarrow M-PAL \leftrightarrow 4.43NTSC \leftarrow

[Auto1]: Automatically selects NTSC, PAL and SECAM.

[Auto2]: Automatically selects NTSC and M-PAL.

[Other than Auto]: You need to select a system appropriate to the input signal.

Press ENTER to store.

• Selecting the settings of D-SUB Input terminal

You can use this option to select the signal system it will receive to D-SUB Input terminal.

(1) Select D-SUB Input and press ENTER .

D-SUB Input screen appears.

(2) Select the signal system to receive.

Each time you press \leftarrow or \rightarrow , one of the available choices appears in the following sequence:

RGB-PC \leftrightarrow Decoder

[RGB-PC]: For using RGB for PC

[Decoder]: For using digital broadcast tuner

(3) Press ENTER to store.

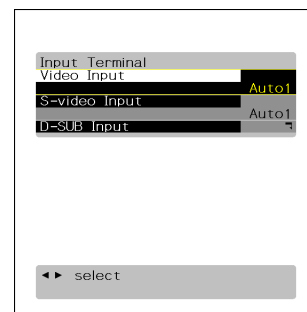

Input Terminal Settings Screen

Note

- The screen display disappears if there is no operation within approximately 60 seconds.
- Depending on the model or the optional devices, some of the functions may not be available.
- The adjustment range varies according to the display signals. Make adjustments to your preferred Sharpness within the adjustment range.
- Depending on the type of signal, it may not be possible to make some of the settings or adjustments.

OTHER ADJUSTMENTS (Continued)

OTHER SETTINGS

Auto Off-NO SIG.

You can make to the standby state automatically when the no signal state continued during set up time.

Press to select the "Time".

Press to select the amount of time before the standby state starts.

Off 1 min. 15 min. 45 min. 60 min.

Press to store.

* The numerical value is the approximate amount of time before the standby state starts.

You can assign the black or white color for the background color at the no signal state.

Press to select the "Background".

Press to select the displayed background displayed.

Black White

Press to store.

* The background color changes to assigned color state after approximate 20 seconds at the no signal state.

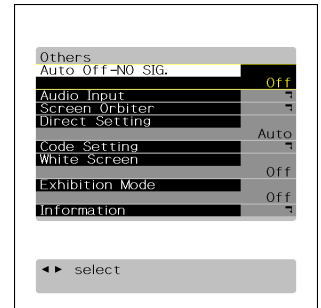

Auto Off-NO SIG. settings screen

•Selecting input terminals (Audio Input)

You can use this option to select the available terminals to receive the audio from input equipment.

(1) Select "Audio Input" and press .

The "Audio Input" selection screen will appear.

(2) Press or to select video input terminal.

(3) Select a related audio input terminal.

Each time you press or , one of the available choices appears in the following sequence:

No Audio Audio 1 Audio 2 Audio 3 Audio 4

[No audio]: No audio in the corresponding mode.

[Audio 1-3]: Selects Audio 1 through 3 for receiving audio in the corresponding mode.

[Audio 4]: HDMI(for the U model)

* Repeat steps (2) and (3) for each piece of input equipment.

(4) Press to store.

* Audio Input menu will not be displayed when "No Audio" is selected.

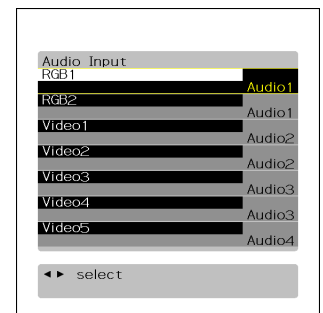

"Audio Input" selection screen (In the case of the U model)

• Minimizing phosphor burn-in (Screen Orbiter)

for RGB

You can use this option to move the screen position to minimize phosphor-induced “burn-in”.

Follow the steps below.

- (1) Select “Screen Orbiter” and press **ENTER**.

The “Screen Orbiter” setting screen will appear.

- (2) Press **↶** or **↷** to select “Mode/Time”.

- (3) Select a desired pattern.

Each time you press **↶** or **↷**, one of the available choices appears in the following sequence:

➔ Off ↔ Time ↔ Mode ➔

[Off]: Disables Screen Orbiter.

[Time]: Moves the pattern approximately every one hour.

[Mode]: Moves the pattern when the power is turned ON or when you switch between modes.

- (4) Press **↶** or **↷** to select “Moving Area”.

- (5) Press **↶** or **↷** to select the range for moving the pattern.

Each time you press **↶** or **↷**, one of the available choices appears in the following sequence:

➔ Min. ↔ Std. ↔ Max. ➔

[Min.]: Pattern moves in small range. (About 5 pixels)

[Std.]: Pattern moves in moderate range. (About 10 pixels)

[Max.]: Pattern moves in wide range. (About 15 pixels)

- (6) Press **ENTER** to store.

* When the Screen Orbiter function is operated, some letters at the top, bottom, right or left of the screen may be missed.

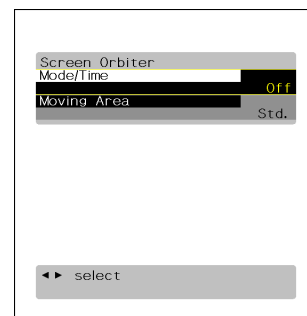

“Screen Orbiter” setting screen

• Setting RGB Input Signal Compulsorily (Direct Setting)

for RGB

You can use this option to switch the setting for RGB input signal.

Each time you press **↶** or **↷**, one of the available choices appears in the following sequence:

➔ Auto ↔ VGA ↔ WVGA ↔ 480P ↔ XGA ↔ WXGA ↔ SXGA ↔ SXGA+ ➔

[Auto]: The optimum display is obtained automatically for input signals.

[Others]: The optimum resolution setting is fixed for each signal.

Press **ENTER** to store.

* In Auto mode, the resolution of VGA, WVGA, 480P, XGA, WXGA, SXGA and SXGA+ may not be automatically distinguished. Switch to the fixed display when the image is not displayed properly.

* Signals that are not applicable depending on the model or input terminals may not be displayed.

• Specifying RGB Input Signal (Code Setting)

for mD-sub input

Normally, use this option in Auto mode.

• Displaying white over entire screen (White Screen)

You can use this option to display white over the entire screen to minimize phosphor burn-in.

Each time you press **↶** or **↷**, one of the available choices appears in the following sequence:

On ↔ Off

Press **ENTER** to store.

Note

- The screen display disappears if there is no operation within approximately 60 seconds.
- Depending on the model or the optional devices, some of the functions may not be available.
- The adjustment range varies according to the display signals. Make adjustments to your preferred Sharpness within the adjustment range.
- Depending on the type of signal, it may not be possible to make some of the settings or adjustments.

OTHER ADJUSTMENTS (Continued)

• Setting Exhibition Mode (Exhibition Mode)

You can use this option to display the enhanced contrast, which is most suitable for the use by unspecified persons.

Each time you press \leftarrow or \rightarrow , one of the available choices appears in the following sequence:

On \leftrightarrow Off

Press ENTER to store.

* In Exhibition mode, the display returns to the original setting in about 5 minutes even if the adjustment is changed.

* The setup will be cancelled when removing the power plug from the receptacle.

• Displaying System Status (Information)

Displays system operation status.

Select "Information" and press ENTER .

The "Information" screen will appear.

[Mode]: Input mode appears at the upper right corner of the screen

[Freq. Scan Mode]: Frequency scanning

[Input Signal]: Video mode

[Input Sync.]: Signal type

[Freq.]: Synchronized signal frequency, polarity

[Preset No.]: RGB code number

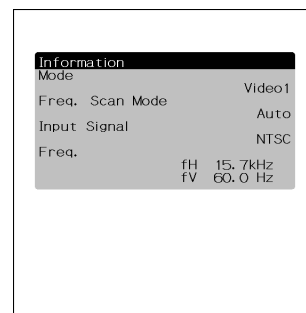

Information screen (Video Mode)

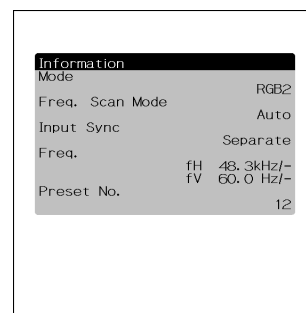

Information screen (RGB Mode)

Note

- The screen display disappears if there is no operation within approximately 60 seconds.
- Depending on the model or the optional devices, some of the functions may not be available.
- The adjustment range varies according to the display signals. Make adjustments to your preferred Sharpness within the adjustment range.
- Depending on the type of signal, it may not be possible to make some of the settings or adjustments.

INITIALIZATION OF USER ADJUSTMENT VALUE

You can restore the values of the adjustment/setting made in the MENU to factory settings.





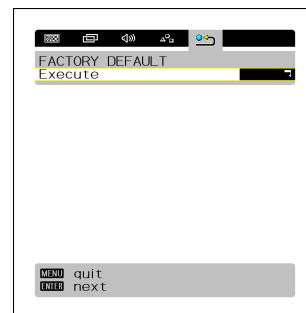

(Ex. the W/R models)

1 Press  .
The main menu screen will appear.



"FACTORY DEFAULT" selected in the main menu screen

2 Press  or  to select "FACTORY DEFAULT".

Each time you press  or , one of the available menus appears in the following sequence:

PICTURE ↔ POSITION/SIZE ↔ AUDIO ↔ FEATURES ↔
FACTORY DEFAULT

The FACTORY DEFAULT Menu screen will appear.

3 Press  .

- Displays the message of whether to proceed with the initialization.

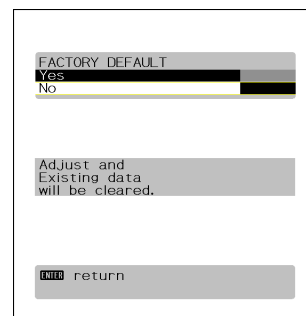

Displays the message of whether to proceed the initialization

4 Press  or  to select the Yes.

5 Press  .

- The message of having completed the initialization will be displayed after initializing.

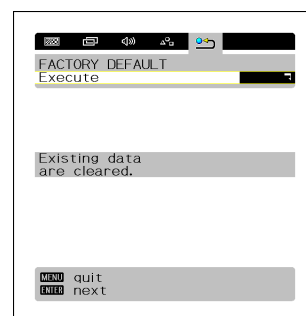

Displays the message of having completed the initialization

6 Press  when you finish.

CLEANING AND MAINTENANCE

Precautions

Be sure to remove the power plug from the receptacle before cleaning the display.

Be sure not to clean the display using a cloth dampened with volatile solvents, such as benzene or thinner. Such solvents can harm the display's cabinet, the filter at the screen front, and the remote control. They can also cause paint to come off these sections.

Cleaning the Screen

Clean the screen gently with a soft cloth.

The screen surface is fragile. Never attempt to clean it with a hard material, press on it forcefully, or tap it.

Cleaning the Cabinet and Remote Control

Use a soft cloth for cleaning.

If the cabinet or remote control is heavily stained, soak a soft cloth in a mixture of water and detergent and squeeze it dry before wiping off the stains. Use a soft, dry cloth for final cleaning.

Cleaning the ventilation grille

Remove dust from the ventilation grille in the rear of the main unit periodically with a vacuum cleaner as the accumulated dust can increase the internal temperature of the main unit causing machine failure or fire hazard.

BEFORE OBTAINING SERVICE

In the event of problems with the display, check the following explanations before contacting your dealer for servicing.

Problem	Action
<ul style="list-style-type: none"> • Power does not turn ON. 	<ul style="list-style-type: none"> • Check whether the power plug is securely inserted into the receptacle.
<ul style="list-style-type: none"> • No pictures are displayed. 	<ul style="list-style-type: none"> • Check cables for disconnection. • Check whether the power for all input equipment is ON. • Check for connection to wrong terminals or for wrong input mode. • Check whether the input mode display is colored pink. Special setup may have been made. Return to original setup or initialize the User adjustment value.
<ul style="list-style-type: none"> • Remote control does not function properly. 	<ul style="list-style-type: none"> • Check for incorrect battery orientation. • Check for dead batteries. • Check for distance from the display. • Check whether you are pointing the remote control transmitter properly at the display's receiver. • Check for any obstacle between the remote control and the display.
<ul style="list-style-type: none"> • The display makes a snapping sound. 	<ul style="list-style-type: none"> • This sound is produced when the cabinet expands or contracts due to variations in temperature. This sound does not indicate that the display has a problem.
<ul style="list-style-type: none"> • The display makes a buzzing sound. 	<ul style="list-style-type: none"> • The display has fans to maintain the temperature of internal components at a constant level. This sound is produced by the fan as it rotates. (Applies to models equipped with a fan)
<ul style="list-style-type: none"> • There are spots on the screen. 	<ul style="list-style-type: none"> • Check whether your AV equipment is affected by interference from automobiles, trains, high-voltage transmission lines, neon signs or other potential sources of interference.
<ul style="list-style-type: none"> • Degraded colors/tints 	<ul style="list-style-type: none"> • Check whether all picture adjustments have been properly made. (See "Adjusting Pictures" on P. E-21–E-26.)
<ul style="list-style-type: none"> • Improper screen position/size 	<ul style="list-style-type: none"> • Check whether screen position and size have been properly adjusted. (See "Adjusting Screen Position and Size" on P. E-27.)
<ul style="list-style-type: none"> • No audio 	<ul style="list-style-type: none"> • Check cables for disconnection. • Check whether the proper audio input has been selected. (See "Audio Input" on P. E-32.)
<ul style="list-style-type: none"> • If "Out of range" appears, the display is receiving a signal whose picture or signal cannot be reproduced by the display. • The screen turns to black and white. 	<ul style="list-style-type: none"> • Signals that are not supported by this display have been input. Check which signals are supported. (See the user's manual (1/2).)
<ul style="list-style-type: none"> • If "Error message Condition 1" appears, the fan is defective. 	<ul style="list-style-type: none"> • Remove the power plug from the receptacle, and contact your dealer for repairs. (Applies to models equipped with a fan)
<ul style="list-style-type: none"> • If "Error message Condition 2" appears, the display's internal components are extremely hot. 	<ul style="list-style-type: none"> • Remove the power plug from the receptacle. (You can turn the power back ON again when the components have cooled sufficiently.) If the message appears again when you turn the power back on, remove the power plug from the receptacle, and contact your dealer for a repairs.
<ul style="list-style-type: none"> • If "Change refresh rate to 60Hz" appears, 	<ul style="list-style-type: none"> • The picture may get blurred with vertical frequency of other than 48.3-51.8 or 58.4-61.4 (Hz). Change the setting of your PC, etc.
<ul style="list-style-type: none"> • If the power indicator lamp flashes red or green. 	<ul style="list-style-type: none"> • Remove the power plug from the receptacle, and inform your dealer about how the lamp flashed. The power indicator lamp flashes differently depending on the type of problem.

Note

- Functions may not be available with some models and some device options.

Free Manuals Download Website

<http://myh66.com>

<http://usermanuals.us>

<http://www.somanuals.com>

<http://www.4manuals.cc>

<http://www.manual-lib.com>

<http://www.404manual.com>

<http://www.luxmanual.com>

<http://aubethermostatmanual.com>

Golf course search by state

<http://golfingnear.com>

Email search by domain

<http://emailbydomain.com>

Auto manuals search

<http://auto.somanuals.com>

TV manuals search

<http://tv.somanuals.com>