

Fujitsu Mobile Color Scanner User's Manual

Fujitsu endeavours to ensure that the information in this document is correct, but accepts no liability for any error or omission in the same. Any procedures described in this document for operating Fujitsu products should be read and understood by the operator before such products are used. To ensure that Fujitsu products function without risk to safety and health, such procedures should be strictly observed by the operator. The development of Fujitsu products and services is continuous and published information may not be up to date. Any particular issue of a product may contain facilities not described herein. It is important to check the current position with Fujitsu. Specifications and statements as to performance in this document are Fujitsu estimates intended for general guidance. They may require adjustment in particular circumstances and should therefore not be taken as formal offers or commitments.

Microsoft, Windows, Windows 98, Windows Me and Windows 2000 Professional are registered trademarks of Microsoft Corporation in the United States and other countries. Microsoft Internet Explorer is the name of a product of Microsoft Corporation of the U.S. Other company and product names mentioned in this manual are the trademarks or registered trademarks of their respective owners.

All Rights Reserved, Copyright© 2001 FUJITSU LIMITED

No part of this publication may be copied, reproduced, or translated without the prior written consent of Fujitsu Limited. No part of this publication may be stored or transmitted in any electronic form without the written consent of Fujitsu Limited.

Website: www.fujitsu-pc-asia.com

i

Safe Operation

About this User's Manual

This user's manual contains important information on the safe use of the Mobile Color Scanner. Before attempting to use the scanner, read this guide thoroughly, paying particular attention to the "Notes on Safety."

Be sure to keep this guide handy in a safe and convenient location for quick reference during use.

About VCCI requirements

This equipment is class B information technology equipment that complies with the standard of the Voluntary Control Council for Interference by Information Technology Equipment (VCCI). Although the equipment is intended for use in residential environments, it may create interference if placed near a radio or television. Handle the equipment in accordance with this User's Manual.

Using this product in mission-critical situations

This product is designed and manufactured for general use in applications such as office automation equipment, personal devices, and household appliances. It is not intended for mission-critical use.

Customers considering the use of these products for mission-critical applications must have safety-assurance measures in place beforehand.

"Mission-critical" uses are special applications, such as those listed below, where particularly high reliability requirements exist. If the pertinent levels of safety are not guaranteed, a failure or operational error could threaten lives or cause physical injury.

- Atomic energy control systems, aeronautic or space systems, mass transportation control systems, medical devices for life support, or weapons firing controls

Preface

Thank you for purchasing the Fujitsu Mobile Color Scanner. The scanner can scan high-resolution color images. Follow the instructions written in this user's manual so that you will use the scanner properly.

Abbreviations used in this guide

The product names in this manual are abbreviated as follows:

Product name	Name used in this manual	
Microsoft® Windows® Millennium Edition	Windows Me	Windows
Windows Microsoft® Windows® 98 operating system	Windows 98	
Microsoft® Windows® 2000 Professional	Windows 2000	
Fujitsu Mobile Color Scanner	unit or scanner	

Symbols used in the text

The following symbols are used in the text of this manual.

- Ⓢ **Notes** Indicates precautions and prohibited items regarding the use of the scanner. Be sure to read the information.
- ⓐ **Guide** Indicates items related to operation.

Prohibition of reproduction

The act of scanning certain items or reproducing certain items with a scanner may be punishable by law. Give special attention to the following items when using a scanner:

[Acts prohibited by law]

- The reproduction of bills, coins, government securities and bonds, local bonds, and others is prohibited. Even if any of the above is stamped with the word "sample," reproduction thereof is still prohibited. (Law against forging currency and securities, law regulating securities similar to bills)
- The reproduction of bills, coins, securities, and others circulating in foreign countries is also prohibited. (Law against forging and counterfeiting coins, bills, bank bills, and securities circulating in foreign countries)
- The reproduction of unused postage stamps, postal cards, and others without government permission is prohibited. (Law against forging postal stamps and others)
- The reproduction of government stamps, certificates regulated by the Liquor Tax Act and Commodity Tax Act, and others is also prohibited. (Regulation of Stamps Counterfeit Act)

[Acts requiring caution]

- Under government guidelines, business companies are warned against reproducing anything beyond their minimum required number of private securities (such as stock certificates, bills, and checks), commutation tickets, coupon tickets, and others.
- Also prohibited is the unauthorized reproduction of passports issued by the government, licenses and ID cards issued by public institutions and private organizations, and passes, meal coupons, and other tickets.



[Items protected by copyright]

- The reproduction of publications, music, pictures, paints, maps, drawings, movies, photographs, and others that are protected by copyright is prohibited except on a limited basis for personal use, use within one's home, or equivalent use.



Warning Labels

This manual uses the following conventions to indicate the warning messages. These markings are intended to prevent users and bystanders from being injured or from suffering damage to their property. A warning signal consists of a warning symbol and a signal word or just a signal word.

The following are the warning levels and their meanings:

Icon	Meaning
 WARNING	This indicates a hazardous situation that could result in death or serious personal injury if the user does not perform the procedure correctly.
 CAUTION	This indicates a hazardous situation that could result in personal injury if the user does not perform the procedure correctly. This warning signal also indicates that damage to the product or other property, may occur if the user does not perform the procedure correctly.

Examples of warning labels and their meanings

Symbols	Meaning
	A symbol indicated with a Δ indicates that there is something about which a warning or caution should be given. Each symbol is accompanied by a drawing indicating a specific warning. (The picture on the left is a caution regarding electric shocks.)
	A symbol indicated with a $\text{\textcircled{X}}$ indicates acts (prohibited acts) that must not be committed. A picture indicating acts that must not be committed is specifically drawn inside or next to the symbol. (The picture on the left indicates that disassembly is prohibited.)
	A symbol indicated with a \bullet indicates an action that must be complied with. The image in the symbol provides more specific information. (The picture on the left indicates that the plug should be disconnected from the outlet).

Notes on Safety

Precautions to Follow when Installing or Moving the Scanner

⚠ CAUTION



Do not place the device in locations exposed to high temperatures, humidity, or dust, or with poor ventilation.

Otherwise, it could lead to electric shock or fire.

Do not install the scanner near a heating source such as a stove or heater, or near flammable materials such as volatile substances or a curtain.

Otherwise, it could lead to fire.



Do not place the scanner on an unstable surface such as one subject to strong shock or vibration or one that is uneven.

Otherwise, the scanner may fall or tip over, resulting in injuries.

Do not leave the device for a long time in locations where the temperature may rise sharply or in locations where the device is exposed to direct sunlight (e.g., in a car with the windows closed on a sunny day).

Otherwise, the cover may overheat, deform, or melt or the scanner may overheat, resulting in a fire.



Do not use the device in locations where water can be splashed such as bathrooms and shower rooms.

Otherwise, it could lead to electric shock or fire.

Precautions to Follow when Using the Scanner

⚠ WARNING



Do not place on or near the device vessels containing water, such as “vases, flowerpots, and cups” or metallic objects such as clips and pins. Otherwise, it could lead to electric shock or fire.

Do not splash water on the device or moisten it with water. Otherwise, it could lead to electric shock or fire.



If you drop the scanner or the cover is damaged, contact the store where you purchased the scanner or Fujitsu service representative related to Fujitsu products. Continuing to use the scanner may cause a fire or electric shock.



Never open any panel or cover secured with screws. High voltage inside the scanner may cause an electric shock.

Do not modify the scanner or replace any part. Otherwise, it could lead to fire.

⚠ CAUTION



Do not use a highly flammable spray near the scanner. Otherwise, it could lead to fire.



Read this guide carefully to ensure that the cable is correctly connected.

If you use the scanner with the cable incorrectly connected, the scanner or peripheral device may be damaged.

Contents

Safe Operation	ii
Preface	iii
Notes on Safety	v
Handling Precautions	vii
Contents	viii
Features of the Mobile Color Scanner	x
Checking the Packing Contents	1
Names and Functions of Parts on the Top of the Scanner	2
Names and Functions of Parts on the Bottom of the Scanner	2
Mounting the core for electromagnetic interference	2
Work Flow	3
Installing the Scanner Driver	4
Preparations	5
Using the Mobile Color Scanner	13
Setting Operation Performed when Pressing the Scan Button	15
FUJITSU Launch	15
Coordinating Processing with FUJITSU Launch	16
Screens Displayed during Use of the Scanner	18
Conditions for Originals the Scanner Can Scan	21
Scanning an Original	21
Scanning an Original	22
Original Sizes the Scanner Can Scan	22
Scanning start position	23
Scanning a Large Original	28
Checking Whether the Scanner Can Scan the Original You Want to Scan	28
Before Scanning an Original	28
Scanning a Large Original	31
Images of an original cannot be stitched successfully	33
Maintenance	34
Cleaning the Surfaces	34
Cleaning the Optical Unit	35
Cleaning the Rollers	35
Disconnecting the Scanner from the Computer	35
Carrying or Storing the Scanner	35
Performing Calibration	35

Uninstalling Software 36
 Reinstallation 36
 Uninstalling the Scanner Driver 36
 Uninstalling Software Supplied with the Scanner 37

Troubleshooting 38
 Checking the Connection 38
 Error Messages 41
 Submessages 44
 Before Assuming that the Scanner is Faulty 45
 Problems after scanning 48

Specifications 50
 Hardware Specifications 50

Operating Environment 51
 Scanner Driver Operating Environment 51
 Use Environmental Requirements 51
 Before Making Inquiries 52

Glossary 53

Features of the Mobile Color Scanner

The Mobile Color Scanner has the following features:

Compact and lightweight

The scanner is compact and lightweight - measuring 142 mm wide, 30 mm high, and 30 mm deep, and weighing only about 100 g.

High scan resolution

The basic scan resolution is 600 x 600 dpi at maximum. You can select output resolution from 100 to 600 dpi using software. The scanner can provide optimum image data to suit the output device such as a printer.

Character image stitching/photograph image stitching

The image stitching function can read with ease a large original which cannot be scanned at one time as one image.

Character image stitching

To stitch character images, an overlapping area of two or three lines is required.

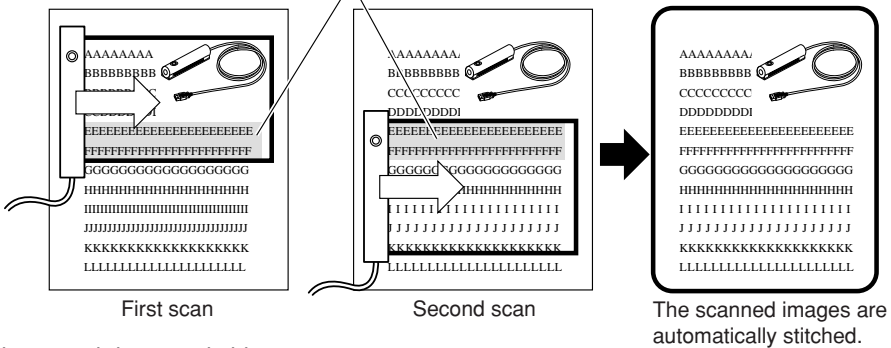

Photograph image stitching

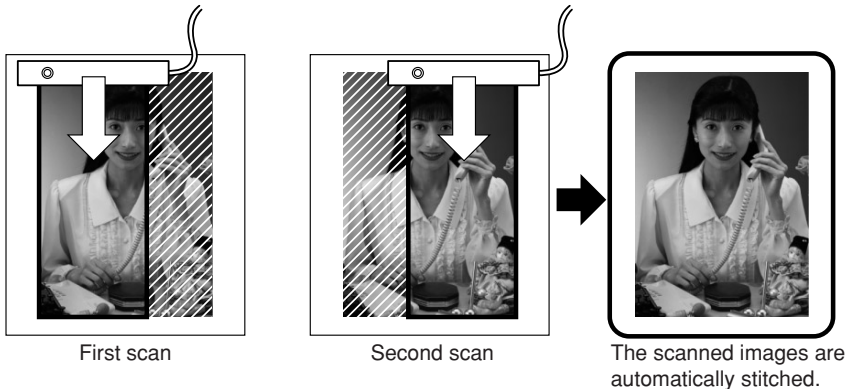

Correction of orientation

The automatic skew correction function automatically corrects the result of scanning an original on the skew, sideways, or upside down to place the result in position.

If an original is scanned on the skew

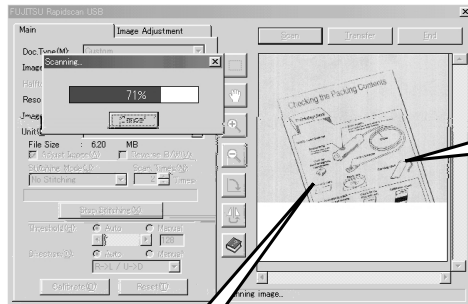

If an original is scanned sideways

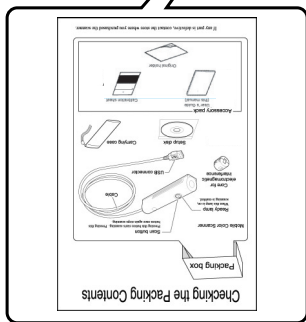
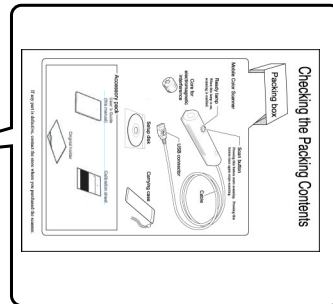

If an original is scanned upside down.

Scan result The scan result has been placed in position.

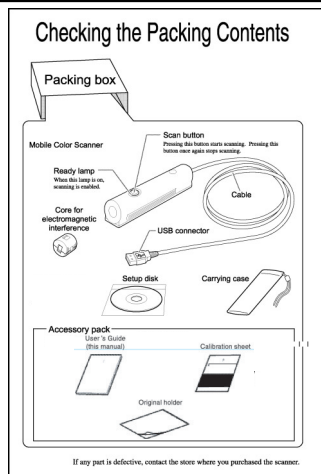

Scanning an image independently of the scanning speed

This scanner uses the automatic resolution adjustment function to scan a fine image without distortion or dropouts independently of the scanner operation speed.

Scanning facilitated by linking the scan button to FUJITSU launch

After you install the scanner driver, FUJITSU launch automatically appears on the taskbar at the lower right of the screen each time you start the computer. When you press the scanner button in this status, the screen for scanning appears, allowing you to start scanning an original right away.

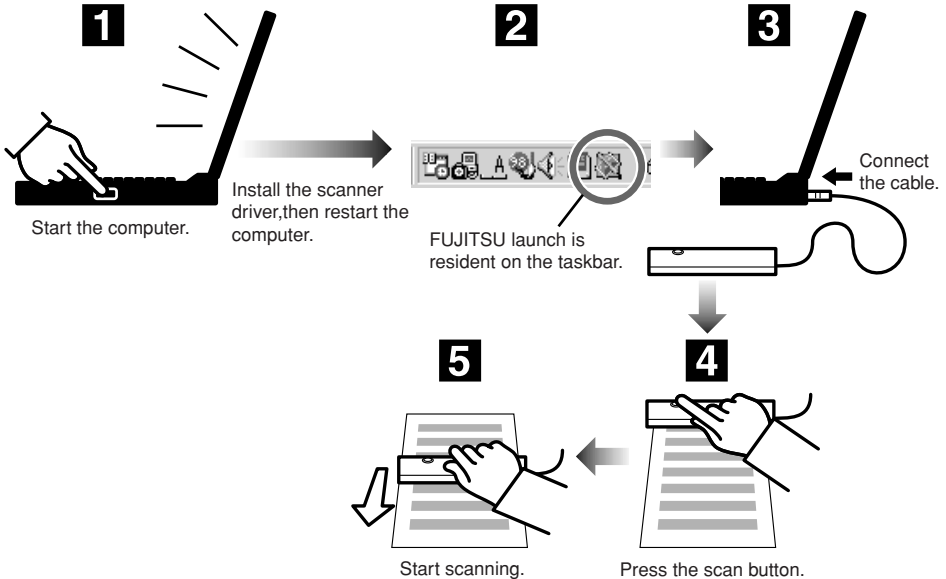

Conformance with TWAIN

The scanner conforms to TWAIN, which is a standard for scanner drivers, and can directly scan images from numerous applications. (For details of TWAIN, see “scanner driver” in the Glossary.)

Checking the Packing Contents

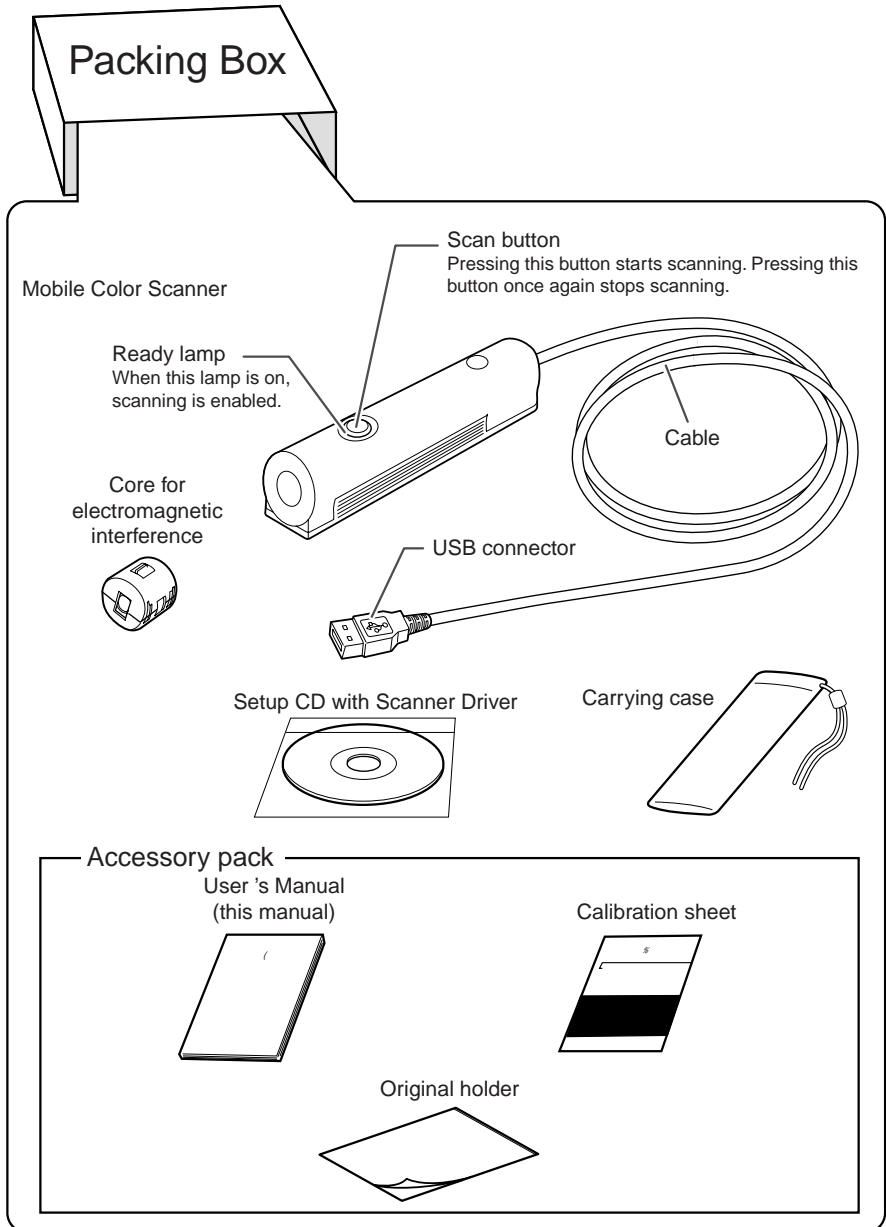

If any part is defective, contact the store where you purchased the scanner.

Names and Functions of Parts on the Top of the Scanner

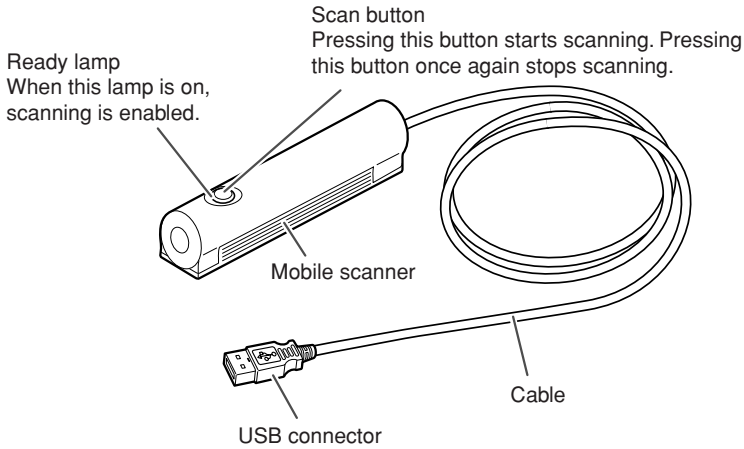

Names and Functions of Parts on the Bottom of the Scanner

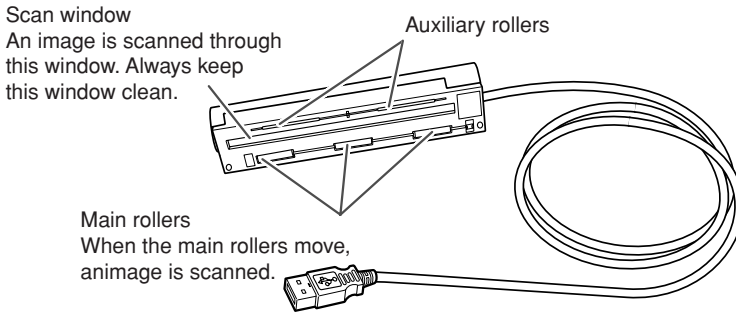

Mounting the core for electromagnetic interference

First mount the core for electromagnetic interference by following the procedure below:

(1) Form a small loop in the cable near the USB connector as shown in the figure below and fit the loop into the groove in the core.

(2) Close the core and press it until it snaps in place.

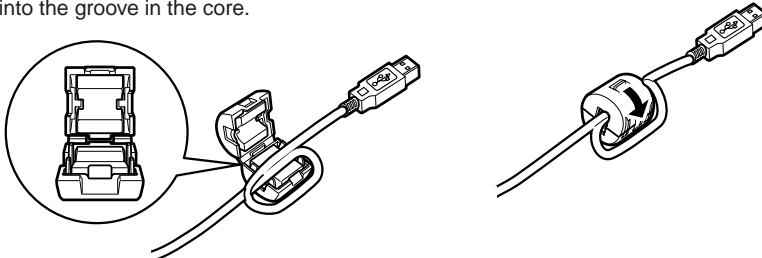

Work Flow

1

Check the packing contents.

Open the packing box and check the contents.



2

Insert the driver setup CD into CD-ROM drive.

Turn the power to the computer on and insert the setup disk in the disk drive.



3

Proceed in accordance with the messages displayed on the screen and restart the computer.

4

Connect the scanner to the computer.

Connect the scanner to the computer.



5

Perform calibration.

To use the scanner, first perform calibration operation (to determine the white and black level values). Use the calibration sheet supplied with the scanner.



***Preparations are now complete.
The scanner is now ready for use.***



Installing the Scanner Driver

When you insert the setup disk into the CD-ROM drive, the following screen automatically appears.

This start screen for installation is called the “main menu” of the installation utility.

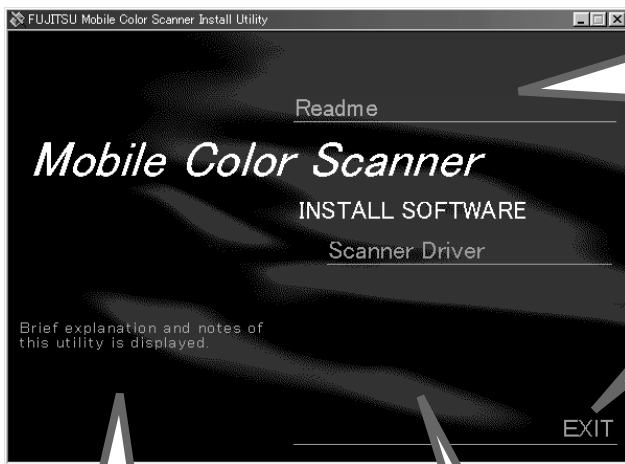

Readme

Displays easy-to-understand explanations and notes on installation when executing installation using the main menu.

EXIT

Terminates the main menu.

This area displays an explanation of the item at the cursor under “INSTALL SOFTWARE.”

INSTALL SOFTWARE

Displays the software for operating the scanner. Click the name of the software to be installed. Installation starts.

- Scanner Driver
Program required to use the scanner

⦿ Guide

If the main menu does not appear after you insert the setup disk in the disk drive, start Explorer and double-click Instmenu.exe on the setup disk.

Preparations

The following details each item introduced in “Work Flow.” Proceed with preparation by following the procedural sequence below.

Turn on the computer.

© **Notes**

If you have connected the scanner, disconnect the scanner, then install the scanner driver and connect the scanner by following the procedure below.

Insert the Scanner Driver CD into CD-ROM drive.

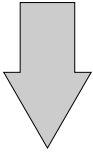

Click on Scanner Driver.

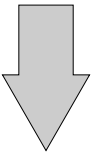

Click Next.

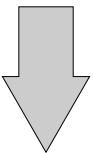
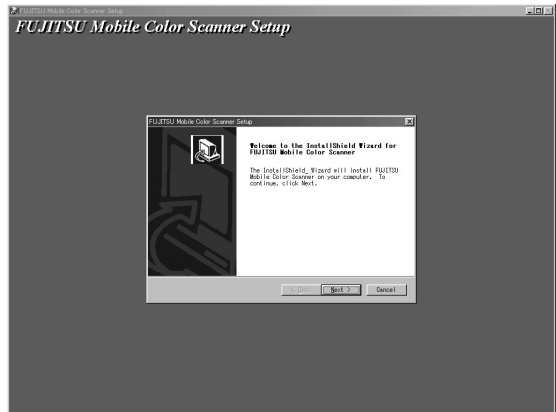

Click Next.



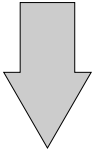

Wait until the files have been copied.

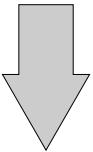
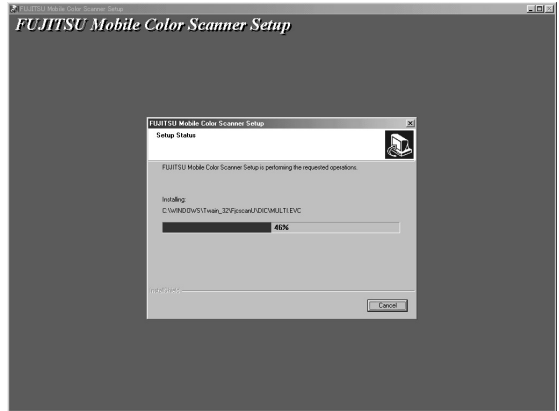

Click on EXIT.

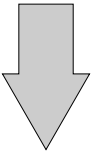

Click Start > Shut Down Windows.

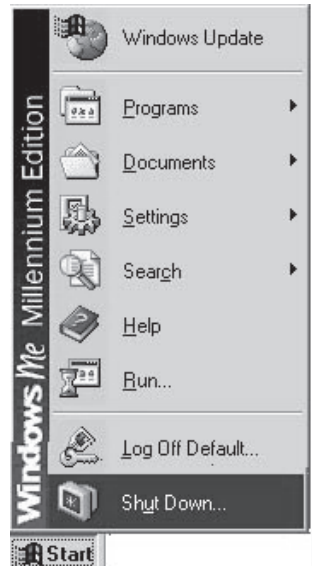

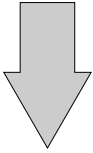

Click Restart > OK.

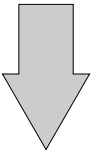
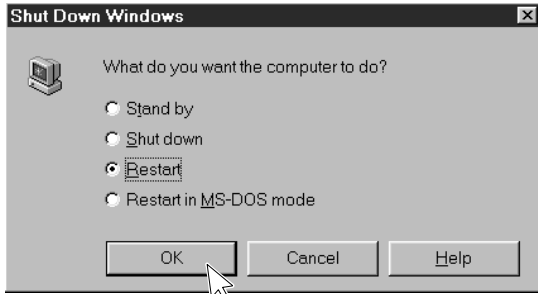

After the computer restarts, connect the scanner to the computer.

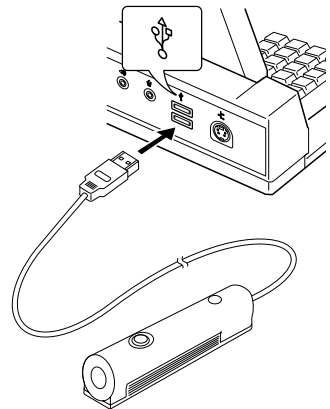

⊙ **Notes**

Connect the scanner for the first time at this step.

⊙ **Guide**

If you have inadvertently connected the scanner to the computer before installing the scanner driver, check the connection, referring to “Checking the Connection”.

Ⓒ Caution

In a Windows 2000 environment, when you connect the scanner to the computer, the following screen appears:



Click Yes.

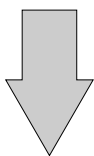

Press the scan button.

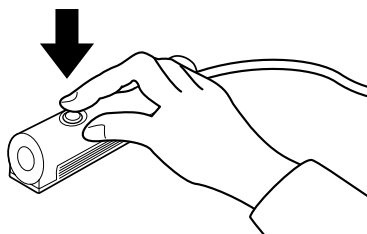
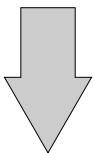

The following screen appears:



Ⓒ Guide

If the above screen does not appear, check the connection, referring to “Checking the Connection”.

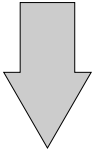

Place the scanner on the white area of the calibration sheet, then click OK.

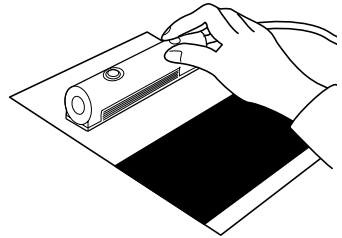

© Notes

Be sure not to move the scanner while the following screen is being displayed.

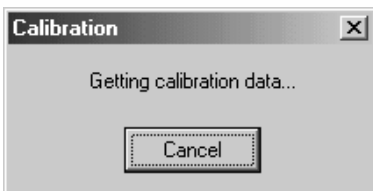
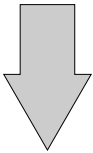
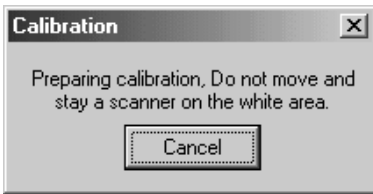
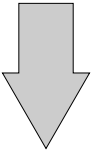

When the above screen appears, **slowly** move the scanner from the white area to the black area.

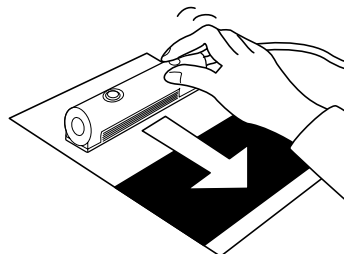

© Guide

Move the scanner while ensuring that it does not become separated from the sheet.

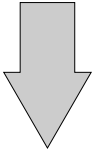

When this screen appears, click OK.

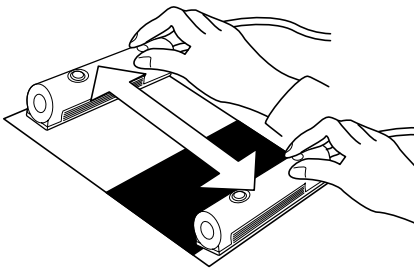
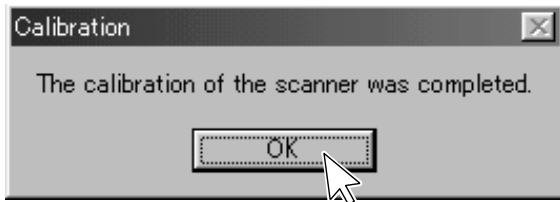

⦿ **Guide**

If the calibration termination screen does not appear after you move the scanner to the bottom, move the scanner to the top again. Continue scanning the sheet until the termination screen appears.

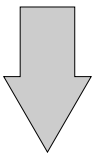

Scanning is complete.



Caution

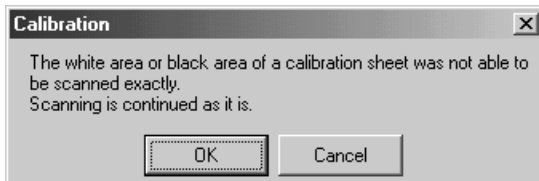

If this error message is displayed, click OK, slowly move the scanner from the black area to the white area of the calibration sheet again. When the scanner reaches the end of the sheet, continue scanning by moving the scanner in the opposite direction on the sheet.

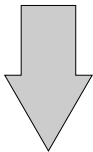

The following screen appears:

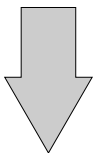
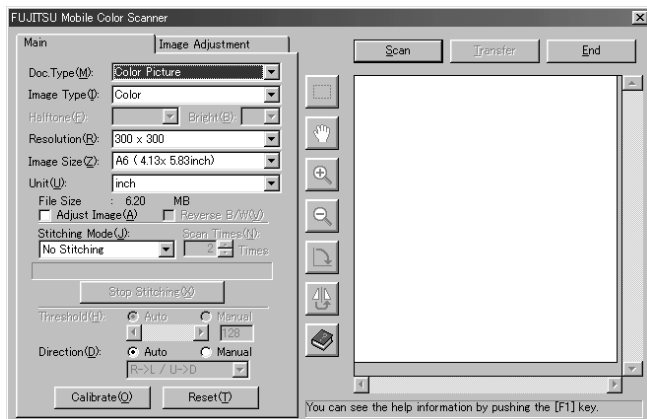

You can now use the scanner.

Using the Mobile Color Scanner

Have ready the original of the material you want to scan.

For details of the scanning range of this scanner, see "Original Sizes the Scanner Can Scan".

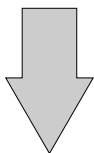
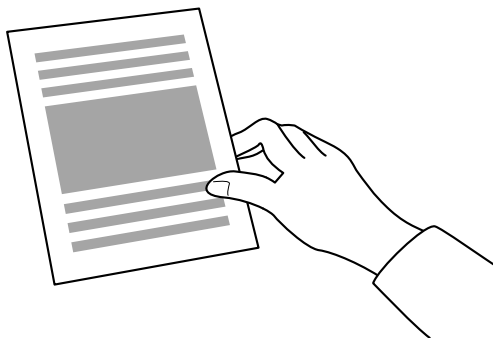

Place the scanner on the original.

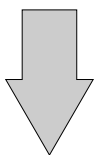
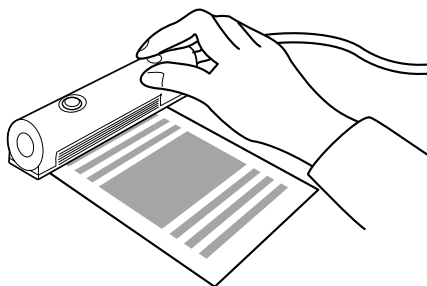

Press the scan button.

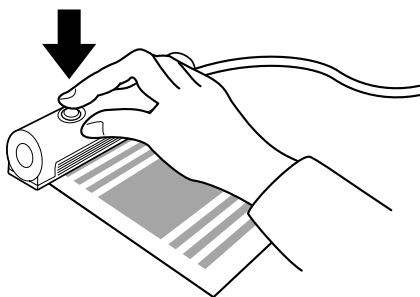

When the light around the scan button becomes green, **slowly** move the scanner to scan the original material.

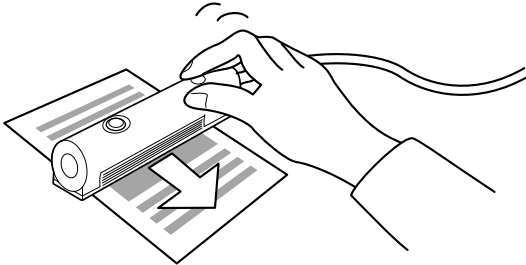

Move the scanner while ensuring that it does not become separated from the sheet.

Press the scan button again at the position you want to stop scanning.

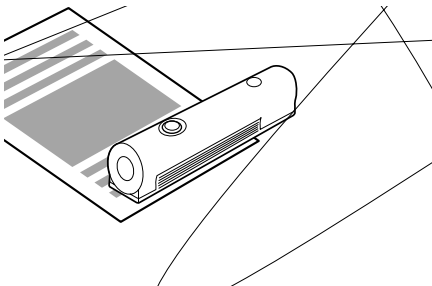

The scanned image is automatically saved on the screen of your computer under the following icon:

To change the data save destination, see “Coordinating Processing with FUJITSU Launch”.

Setting Operation Performed when Pressing the Scan Button

You can use FUJITSU launch to set the operation performed when the scan button of this scanner is pressed. FUJITSU launch is a resident icon on the taskbar after installation of the scanner driver.

FUJITSU Launch

When you install the scanner driver, FUJITSU launch is automatically displayed on the taskbar at the lower right of the screen of the computer as the following icon:



FUJITSU launch periodically monitors the status of this scanner to check such items as whether the scanner is scanning. After the scanner scans an original, data is saved as a file or copied onto the Clipboard and software is started in accordance with the settings made using FUJITSU launch.

Click the right mouse button on the icon on the taskbar. The following menu appears. In this menu, select Save to.... The next menu appears.

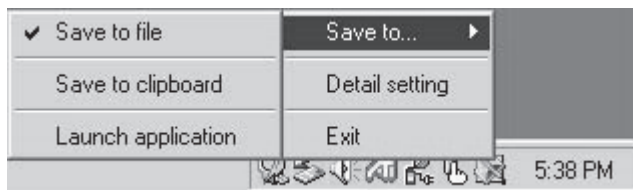

The icon is always displayed unless you click the right mouse button on the icon and select Exit.

Coordinating Processing with FUJITSU Launch

Specify how processing is performed when clicking the Transfer button on the driver screen or which software program is to be started after an image is scanned. (See “Screens Displayed during the Use of the Scanner”.)

Select Save to... from the FUJITSU launch menu and click a desired option. Save to file is selected as the initial setting.

Save to... options

Save to file	Saves the scanned image to the file specified for Save folder in the Detailed setting dialog box.
Save to Clipboard	Copies the scanned image onto the Clipboard.
Launch application	Saves the scanned image to the file specified for Save folder in the Detailed setting dialog box and automatically starts the application specified for Application in the dialog box.
	Delete the file in the specified folder if it is not required.

Detailed setting

This option is used to set the folder used when you select Save to file for Save to... and the application to be started when you select Launch application for it. Click Detailed setting in the menu.

The following dialog box appears:

On Windows 98/Me

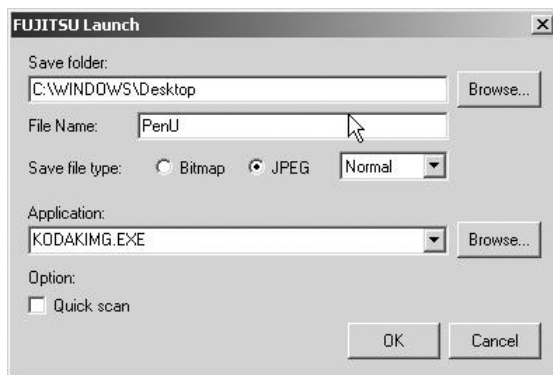

For Application, you can select from up to 16 applications that were set.

On Windows 2000

The Application field is left blank.

Click the Browse button. A dialog box appears. In this dialog box, you can specify the destination folder and application.

Specify the file type with which an image is to be scanned and data is to be saved, for Save file type. When specifying saving in JPEG, you can select Normal or Fine.

Click the Quick scan check box to turn it on to start scanning using the settings made in the dialog box.

Exit

This option terminates FUJITSU launch.

To start FUJITSU launch again, select Start > Programs > FUJITSU Mobile Color Scanner and click FUJITSU launch.

Screens Displayed during Use of the Scanner

The following outlines the names and functions of the items on the scanner driver screen. For details, see Online Help of the scanner driver.

Main Tab

This screen is displayed on the left when the scanner driver starts.

🕒 Guide

You can bring up the screen by pressing the scanner button.

Doc. Type

Selects the type of original to be scanned.

Image Type

Sets the type of scanned image.

Halftone

Selects the halftone pattern to be used for halftone processing.

File Size

Displays the size of the file for the scanned image in MB.

Adjust Image check box

When turned on, does not immediately transfer the image to the application, but transfers it when the Transfer button on the preview screen is clicked.

Direction

Specifies whether to automatically recognize the direction of the scanned image or manually set the scanning direction.

Bright

Adjusts the brightness of halftones.

Resolution

Specifies the number of pixels (dots) per inch.

Image Size (scan length)

Selects the size of the original to be scanned.

Unit

Selects the unit to be used in the preview window.

Reverse B/W check box

Turn this check box on to invert the scanned image.

Stitching Mode

Select this mode to scan a large document or image original that cannot be scanned at one time.

Threshold

Specifies the threshold to be used as the reference value for distinguishing white from black.

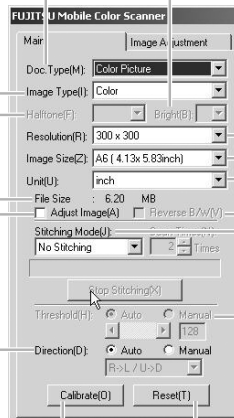

Calibrate button

Scans the calibration sheet to update white and black level values.

Reset button

Returns the settings to those at installation.

Image Adjustment tab

Original screen

Displays the image scanned using the settings previously saved.

Undo button

Returns the settings on the Image Adjustment page to those previously saved.

Automatic check box

When turned on, automatically sets each adjustment item.

Shadow

Adjusts the image shadow.

Tone

Adjusts the tone of each of R (red), G (green), and B (blue).

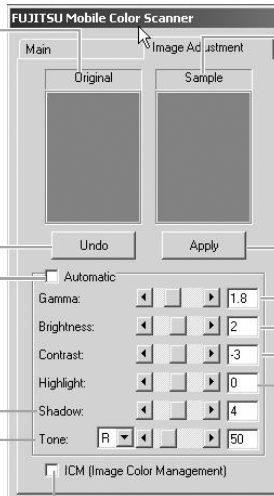

Sample screen

Displays the image on which the settings on the Image Adjustment page are reflected.

Apply button

Reflects image processing for the Sample image in the preview window.

Gamma

Adjusts the density curve for the entire screen.

Brightness

Adjusts the brightness of the entire screen.

Contrast

Adjusts the image contrast.

Highlight

Adjusts the image highlight.

ICM (Image Color Management) check box
When turned on, adjusts colors using the Windows color management system.

Preview Screen

The preview screen, which is displayed on the right of the screen regardless of whether the Main or Image Adjustment tab is selected, displays the scanned image in the preview window.

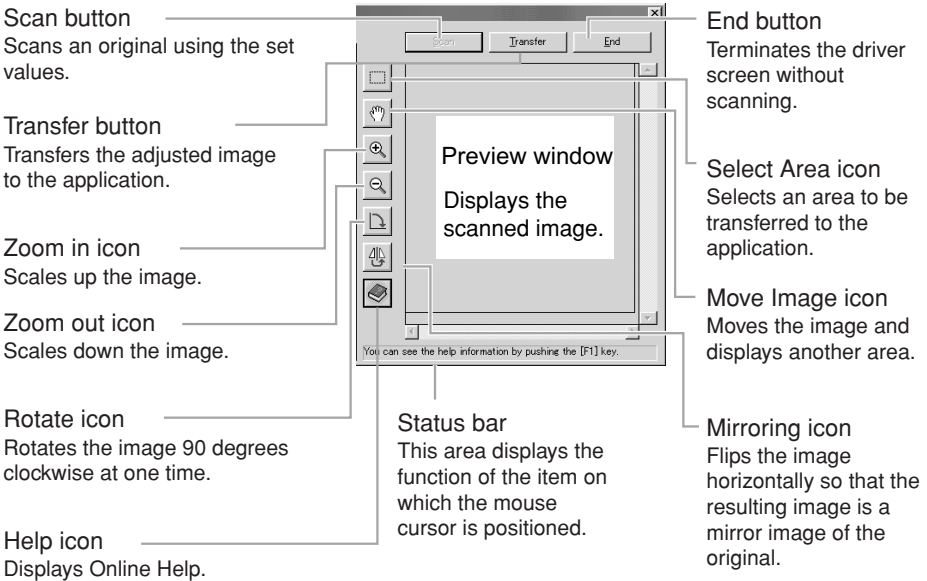

Scanning an Original

This scanner can scan an original with a smooth surface such as a photograph or printed matter. Check the conditions and sizes of originals the scanner can scan before scanning an original. To scan a large original, see “Scanning a Large Original”.

Conditions for Originals the Scanner Can Scan

This scanner may not successfully scan certain types of original. Note the following:

© Notes

- Use an original with a smooth surface.
- If an original with uneven thickness such as one with a sticker or label affixed to it is scanned, a line may appear at the boundary where different surface levels converge or the sticker or label may come off.
- This scanner cannot scan transparent originals such as photographic film. It can, however, scan an OHP film original that is clearly visible when placed on white paper.
- If a thin original is scanned when placed on top of another form, the image on that other form may also end up being scanned together with the original image.
- Always remove clips and staples because they cause scanner failures.
- If ink on an original has not dried, be sure to wait until the ink is completely dry before attempting to scan it.
- Do not use the following originals:
 - Wet original
 - Original with surface treatment or special coating applied
 - Original made of a material other than paper, such as cloth or metallic sheet
 - Original whose surface to be scanned is sticky
- Do not directly scan an original written in pencil because the rollers and sensor may become dirty. To scan an original written in pencil, first place the original in the original holder.

Original Sizes the Scanner Can Scan

The following table lists the original sizes this scanner can scan.

Size	Width (mm) ^(*1)	Length (mm)
A6	105	148
Two A6-size sheets in portrait orientation	105	297
A4 in portrait orientation	210	297
Business card	91	55
Postcard	100	148
Photograph	88	127
Free	Up to 105	Up to 364 ^(*2)
Custom	13~105	13~364 ^(*2)

⦿ Guide

*1 The width (mm) in the above table indicates the value including margins. To use the photograph image stitching function, an area of at least 20 mm must be scanned twice. For this reason, the maximum width for stitching is 190 mm.

*2 When scanning at 600 dpi, the maximum length of an original the scanner can scan is 346 mm.

Scanning an Original

To scan an original, use software that supports TWAIN.

For information on the conditions and sizes of originals to be scanned, see “Conditions for Originals the Scanner Can Scan” and “Original Sizes the Scanner Can Scan”.

For information on the driver screen, see “Screens Displayed during Use of the Scanner”.



1 Make sure that the power to the computer is on and set this scanner on an original.

Make sure that the original area to be scanned is within the scanning range of the scanner and the beginning of the original is at the scanning start position. The following figure shows the scanning range.

Scanning start position

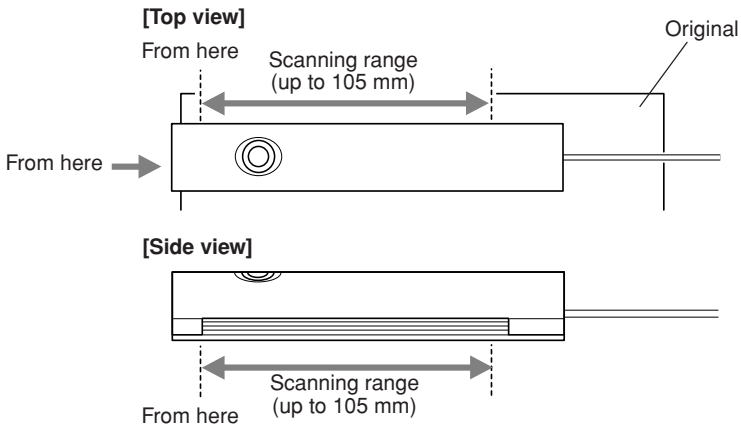

During scanning from the edge of an original, the edge may come into contact with the scanning window or a main roller for scanning may slip off from the original. In this case, use the original holder supplied with the scanner or change the scanning direction and scan the original. When scanning a small original such as a business card, a thin original, an original that tears easily, or an original you do not want to soil, scan the original after inserting it in the original holder.

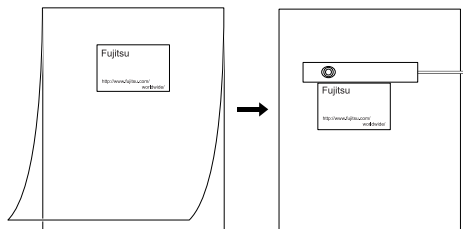

2 Start scanning the original.

Follow the procedure below to scan the original. Perform steps 2) and 3) only when you use the scanner with the software for the first time.

Guide

For information on how to start the scanner from software, see the manual for the software you are using.

- 1) Start software supporting TWAIN.
- 2) Click Select TWAIN Source... or another item in the File menu.
- 3) Select FUJITSU Mobile Color Scanner from the Source list in the displayed dialog and click the Select button.
- 4) Click Acquire ... or another item in the File menu.
- 5) The driver screen appears. Set the items required for scanning. If you want to adjust scanned image before transferring it to the software, turn the Adjust image check box on.

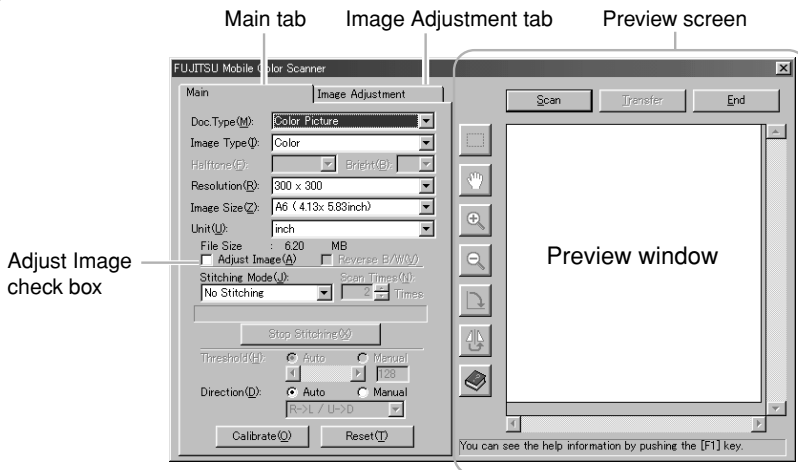

- 6) Click the Scan button or press the scan button of this scanner to start scanning.

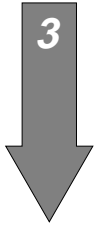

3 Move the scanner as follows.

- **When Auto is checked under Direction on the driver screen**

The scanner automatically recognizes orientation of scanned characters and converts them into right orientation. You can scan the original without considering the scanning direction.

If either of the following settings is made, the scanner cannot detect the scanning direction:

- Resolution: 150 dpi or less
- Image Type: Halftone

- ⊙ **Guide**

The scanner may not be able to convert scanned characters depending on the character size, design, or contained image data. In this case, check Manual under Direction and scan the original again.

- **When Manual is checked under Direction on the driver screen**

Scan the original as follows:

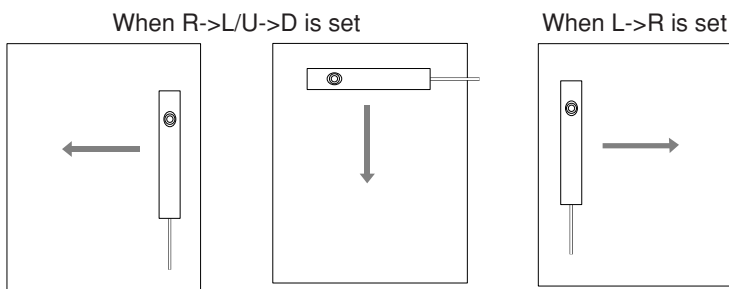

If you move the scanner in the direction opposite to the direction indicated by the above arrow, the scanning result is flipped vertically or horizontally.

- ⊙ **Guide**

When scanning, move the scanner using something square as the guide for fine scanning.

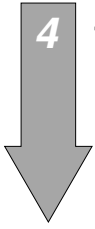

4 Terminate scanning.

When the scanner scans the specified size of the original, it automatically terminates scanning.

When the Adjust Image check box is off, scanning is now complete. The scanned image is displayed on the software.

When the Adjust Image check box is on, a reduced image is displayed in the preview window. Go to step 5.

To stop scanning in progress

Press the scan button of this scanner. Data that has been scanned is saved.

To cancel scanning in progress

Click the Cancel button in the Scanning dialog. Data that has been scanned is not saved.

⊙ **Guide**

If you move the scanner too quickly, the scanner cannot normally scan the original. To properly scan the original, move the scanner at an appropriate speed.

If the scanned image shrinks

If the speed at which the scanner moves is fast, this scanner automatically adjusts the scanned resolution so that the scanned image does not shrink. If the speed is excessively fast, the scanner may not be able to adjust the resolution and the scanned image may shrink. If the scanned image shrinks, scan the original again by moving the scanner more slowly.

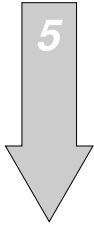

Click the Image Adjustment tab. On the Image Adjustment page, adjust the image, and rotate, horizontally flip, and cut the image on the preview screen if required.

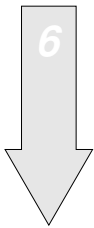

Click the Transfer button on the driver screen to transfer the image to the software.

⦿ **Guide**

During scanning or calibration of this scanner, do not place the computer in the suspend, not operating, or standby state.

- If you scan a document on the skew, black dots and others may be displayed on a stitching boundary. In this case, remove them using image processing software.
- If you scan a document containing a drawing or photograph, the drawing or photograph in the stitching result may be misaligned. Scan a document so that a drawing or photograph is scanned at one time.
- Only images scanned from the top to bottom (document orientation) can be stitched. In horizontal line orientation, scan a document horizontally (solid line) and move the pen scanner vertically (dotted line). In vertical line orientation, scan a document vertically (solid line) and move the pen scanner horizontally (dotted line).

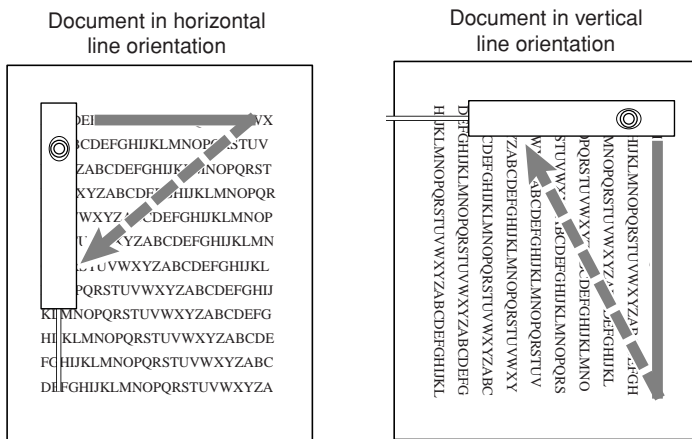

- Do not scan a document in horizontal line orientation together with that in vertical line orientation.
- Scan two documents to be stitched by aligning the beginning of the lines.

Images which can be stitched

Image 1



Image 2

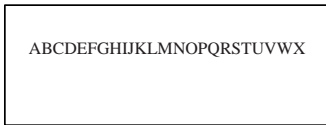

Images which cannot be stitched

Image 1



Image 2

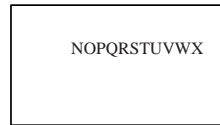

For photograph image stitching

Scan a photograph or picture image original so that an area of at least 20 mm must be scanned twice.

⦿ Guide

Scan an original from the top to the bottom. Scan the left side of the original for the first pass, and then scan the right side for the second pass.

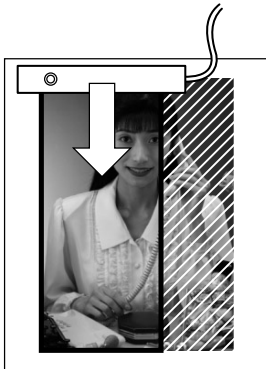

First scan

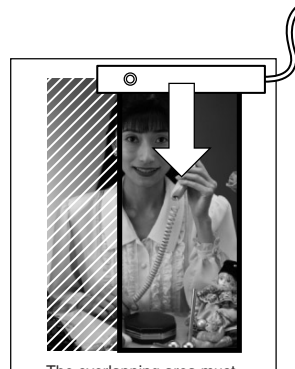

The overlapping area must be at least 20 mm.

Second scan

Scanning a Large Original

For a large original, select Character Image for Stitching Mode and scan the original several times. For a photograph or picture image original, select Photograph Image.

The following explains how to make settings on the driver screen. For details of the driver screen, see “Screens Displayed during Use of the Scanner”.

1

Set the desired stitching mode on the driver screen.

⊙ **Guide**

If one of the following settings is made, the scanner cannot scan the original and displays an error message. Scan the original after changing the setting.

For character image stitching

- Resolution: 150 dpi
- Image Type: Halftone
- Direction: Manual

For photograph image stitching

- Image Type: Halftone
- Direction: Manual

2

Specify a size for Image Size.

Select one of the following image sizes for Image Size:

A4 Portrait (*1), A4 Landscape, B4 Portrait, B4 Landscape, Letter Portrait, Letter Landscape, and Free (*2)

*1 Initial value for character image stitching

*2 Initial value for photograph image stitching



3

Specify a value for Scan Times.

For character image stitching

Specify 2 to 6 for Scan Times as the number of times the original is to be scanned.

For photograph image stitching

2 is fixed for Scan Times.



4

Start scanning.

Press the scan button of this scanner or click the Scan button on the driver screen to start scanning. When scanning is complete, the reduced image that was scanned is displayed in the preview window.

When the first image has been scanned successfully, the message "1 scan complete" is displayed on the bar indicating the scanning progress.



5

Scan the second and subsequent images.

Using the same method as that followed in scanning the first image, to start scanning, press the scan button of the pen scanner or click the Scan button on the driver screen.

When the second or subsequent image has been scanned, the image is stitched to the previous image.

When stitching is successfully completed

The following message is displayed under Scan Times:

"X scan complete, stitching succeeded." X: Number of scanned images

Continue with scanning.

When stitching is not successfully completed

A dialog appears that asks you whether to scan the image again.

Click the Yes button. The following message is displayed under Scan Times. Scan the same portion of the original again.

"X scan failed, rescan"



6

Terminate stitching.

When the specified number of images have been scanned and stitched, scanning terminates, the driver screen is closed, and the image of the stitching result is displayed on the software.

If you want to terminate scanning before the specified number of images have been scanned, click the Stop Stitching button. The images that have been scanned and stitched are displayed on the software.

Images of an original cannot be stitched successfully

- If the scanner moving speed is too fast, images may shrink and not be stitched successfully. Move this scanner at an appropriate speed to scan the original.
- Scan characters straight instead of on the skew.
- If a stitched portion contains, in addition to characters, noncharacters such as tables, drawings, or pictures, images may not be stitched successfully if the number of characters in such stitched portion is small. Scan the original so that the stitched portion contains numerous characters.
- For photograph image stitching, if a stitched portion contains no objects (such as a person, mountains, trees, etc.) or the original is blurred and unclear, images may not be successfully stitched. Scan the original so that the stitched portion contains contrasting images.

Maintenance

To keep the scanner in good condition, clean the scanner about once a month.



Burns

Electric shock

- Before cleaning the scanner, always disconnect the pen scanner from the computer.
- Cleaning the scanner without disconnecting it from the computer may result in burns or electric shock.

© Notes

Note the following points when cleaning the scanner:

- Use only water or neutral detergent. Use of a such volatile liquids such as benzene or thinner may result in the discoloration or deformation of the cover.
- You need not apply oil. Do not lubricate.

Cleaning the Surfaces

Wipe any dirt on the surface of the scanner with a cloth dampened with water or watered down neutral detergent and squeezed dry. Then, wipe the surface with a soft dry cloth.

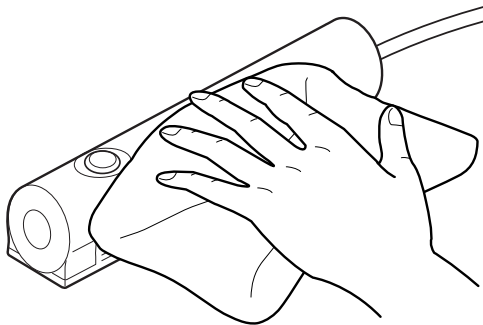

Cleaning the Optical Unit

A dirty optical unit may cause images to be distorted. Wipe the optical unit with a soft dry cloth.

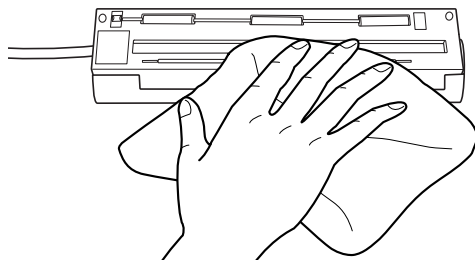

© Notes

Use a soft dry cloth to clean the optical unit. Do not use water or neutral detergent.

Cleaning the Rollers

To remove paper dust from the rollers, move the scanner on a commercially available adhesive sheet for cleaning printers.

Disconnecting the Scanner from the Computer

Disconnect this scanner from the USB connector of the computer.

Carrying or Storing the Scanner

Put the scanner in the carrying case supplied with it when carrying or storing it.

Performing Calibration

If the scanner is unable to scan images in detail, is connected to another computer, or the scanner driver is reinstalled, perform calibration.

Press the scan button or perform scanning from an application to display the driver screen.

Click the Calibrate button and scan the calibration sheet.

Uninstalling Software

The following explains how to uninstall the scanner driver and software supplied with the scanner.

To uninstall software in a Windows 2000 environment, you must log on as Administrator.

Reinstallation

Before reinstalling the scanner driver, first delete the existing files.

Uninstalling the Scanner Driver

Before reinstalling or upgrading the scanner driver for the purpose of using it properly, first uninstall the currently installed scanner driver.

1

Select Settings from the Start menu and click Control Panel.

The Control Panel dialog appears.

2

Double-click Add/Remove Programs.

The Add/Remove Programs Properties dialog appears.

3

On Windows 98/Me, select FUJITSU Mobile Color Scanner from the list on the Install/Uninstall page and click the Add/Remove button.

On Windows 2000, Click the Change/Remove Programs button, select FUJITSU Mobile Color Scanner from the displayed list, and click Change/Remove button.

A confirmation dialog appears. Click Yes.

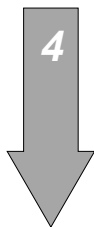

4 Restart the computer.

After completion of uninstallation, restart the computer.
The scanner driver is now uninstalled.

Uninstalling Software Supplied with the Scanner



1 Select Settings from the Start menu and click Control Panel.

The Control Panel dialog appears.



2 Double-click Add/Remove Programs.

The Add/Remove Programs Properties dialog appears.

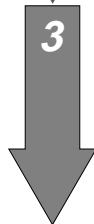

3 On Windows 98/Me, select a software program to be uninstalled from the list on the Install/Uninstall page and click the Add/Remove button.

On Windows 2000, Click the Change/Remove Programs button, select a software program to be uninstalled from the displayed list, and click Change/Remove button.

A confirmation dialog appears. Click Yes.

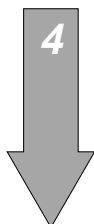

4 Restart the computer.

After completion of uninstallation of the software program, restart the computer.
The software program is now uninstalled.

Troubleshooting

Read the following if an error message is displayed or you cannot operate the scanner as expected while using the scanner.

Checking the Connection

After connecting this scanner to the computer, check whether the scanner driver has been installed successfully, following the procedure below:

1

Select Settings from the Start menu and click Control Panel.

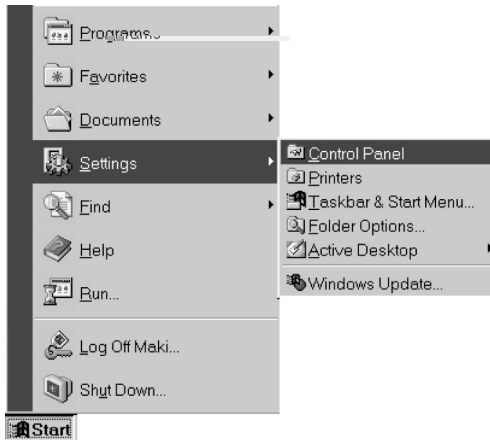

2

Double-click System in the Control Panel.



3

On Windows 98/Me:

Click the Device Manager tab in the System Properties dialog.

On Windows 2000:

Click the Device Manager button on the Hardware tab in the System Properties dialog.

Verify that FUJITSU Mobile Color Scanner has been created under Imaging Devices in the displayed Device Manager page.

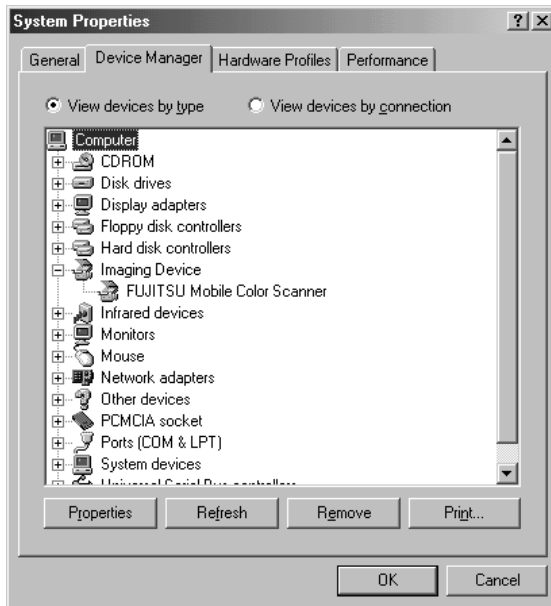

This completes the checking procedure.

If FUJITSU Mobile Color Scanner has not been created and USB Device is displayed under Other Devices or USB Device under Imaging Devices is marked with an exclamation mark (!) on Windows 98/Me/2000, the scanner driver has not been installed successfully.

Reinstall the scanner driver by following the procedure below:

- **When you have not installed the scanner driver**

On Windows 98/Me, select USB Device under Other Devices by clicking the left mouse button and click the Remove button to uninstall it. (See “Uninstalling Software”.)

On Windows 2000, click the right mouse button on FUJITSU Mobile Color Scanner in the Device Manager dialog box. A menu appears. Click Remove to uninstall FUJITSU Mobile Color Scanner. (See “Uninstalling Software”.)

After completion of uninstallation, disconnect the scanner if connected, install the scanner driver, and then connect the scanner to the computer. (See “Preparations”.)

- **When you have installed the scanner driver**

Uninstall the device (USB Device) following the procedure described in “When you have not installed the scanner driver” above. Then, disconnect the scanner if connected and connect the scanner to the computer again.

For details on how to uninstall a device, see “Uninstalling Software”.

Error Messages

If an error message is displayed during the use of this scanner, scan the original again and check whether the error recurs before assuming that the scanner is faulty.

If the error recurs, take appropriate action in accordance with the explanations given below. If the error still occurs after you take action following the procedure described above, contact a Fujitsu service representative in charge of Fujitsu personal computers and peripheral products.

Error message	Explanation and action to be taken
The default value data file has an incorrect value. A standard value has been set.	A value outside the range or an inappropriate character was found in an item in the initial value data file. (Item XXXXX indicated by Entry=XXXXX) If the file has been rewritten intentionally, the setting may be invalid for the item. If it has not been rewritten, the file may have been destroyed for some reason. In this case, the value itself is set to the default. Periodically check the hard disk (chkdsk/scandisk) and viruses.
An error occurred during scanning.	– Check whether the scanner driver has been installed. – Check whether this scanner is selected for the software. If it is not selected, select FUJITSU Mobile Color Scanner, referring to the software manual.

Error message	Explanation and action to be taken
The specified scanner is being used.	<ul style="list-style-type: none"> – Check whether this scanner is being used by another software program. – Check whether the scanner driver has been started twice. – Terminate all software programs, then start them and perform scanning.
An input-output error occurred in the scanner.	<p>A failure occurred during a scan operation using this scanner. The failure may have occurred in the image scanner.</p> <p>Turn off the power to all devices once. Then, turn on the power to the computer and then turn the power on to other devices.</p> <p>Then, try scanning again.</p>
The memory is insufficient.	<p>Memory used for scanning is insufficient.</p> <p>Memory may be insufficient due to the number of programs operating in the background and registered device drivers, or because of a software program such as a photopaint program for which a large capacity of GDI memory is allocated by setting.</p> <p>Change the software setting, cancel the registration of device drivers having no direct bearing on scanning, or stop operating background programs.</p>
<ul style="list-style-type: none"> – Parameter error (internal) – The calling procedure is invalid (internal). – A range specification is invalid (internal). – The calculation result exceeded the value that can be expressed (internal). – A user definition is not registered (internal). 	<p>This program error occurs during exchange of a command between the scanner driver and this scanner.</p> <p>Restart the computer and retry.</p>
General fault related to response to MSG_XXXXXX	<p>This program error occurs during transmission of an internal message.</p> <p>A submessage shown on page 44 is also displayed.</p>
General fault related to response to DAT_XXXXXX	<p>This program error occurs during transmission of an internal message.</p>

Error message	Explanation and action to be taken
Because the scanner was stopped, scan operation was aborted.	This message is displayed when at least 2 minutes have elapsed after start of scanning. Scan an original within 1 minute at a time.
You cannot select "Automatic" in "Direction" if "Halftone" is selected in "Image Type." Select "Manual" in "Direction," or select a setting other than "Halftone" in "Image Type."	Uncheck Auto for Direction or set an item other than Halftone Image Type, then make the setting again.
Image data was missed.	Image data transfer could not catch up with the scanning speed of this scanner because the system processing speed was low, and image data dropouts occurred. Terminate running software programs to improve system performance or slowly move the scanner for scanning.
The USB scanner device cannot be found.	Check whether the scanner is connected properly. Check whether the scanner is properly selected for the application.
Character images could not be stitched. Do you want to scan them again?	Check whether the scanning direction and speed are proper. Refer to "Scanning a Large Original".
Photograph images could not be stitched. Do you want to scan them again?	Check whether the scanning direction and speed are proper. Refer to "Scanning a Large Original".
Photograph image stitching stopped because its preprocessing could not be performed successfully.	Memory may be insufficient. Terminate other applications. (Recommendation: Have available at least 128 MB of extended memory). Alternatively, the scanned image is too short. Scan at least 30 mm of an image.

Submessages

Error message	Explanation and action to be taken
<ul style="list-style-type: none"><li data-bbox="84 280 574 308">– Undefined error<li data-bbox="84 308 574 365">– Processing cannot be continued because memory is insufficient.<li data-bbox="84 365 574 393">– The data source could not be found.<li data-bbox="84 393 574 449">– The maximum allowed number of connections was exceeded.<li data-bbox="84 449 574 477">– An operator error occurred.<li data-bbox="84 477 574 505">– An invalid function was specified.<li data-bbox="84 505 574 532">– Invalid MSG DG DAT combination<li data-bbox="84 532 574 560">– An invalid value was specified.<li data-bbox="84 560 574 617">– An invalid DG DAT MSG procedure was specified.	Submessages following error messages “General fault related to response to MSG_XXXXXX (internal)” and “General fault related to response to DAT_XXXXXX (internal)” These submessages indicate the details of individual program errors occurring during message/data processing.

Before Assuming that the Scanner is Faulty

If you cannot operate the scanner as expected or an error occurs, check the following items before assuming that the scanner is faulty.

Problems are divided into the following two types in accordance with their nature here:

- Problems related to operation
- Problems after scanning

Problems related to operation

The scanner does not operate when you press the scan button.

- Check whether the scanner driver has been installed properly, referring to “Checking the Connection” in the User’s Manual.
- If you press the scan button of the scanner after establishing a dial-up connection for Internet or mail communication, but the scanner does not operate, start FUJITSU launch and correct the error by following the procedure below:



1 Click the right mouse button on the icon at the lower right of the screen. A menu appears. On the menu, click Exit.



2 Click Start > Programs > FUJITSU Mobile Color Scanner > FUJITSU launch.

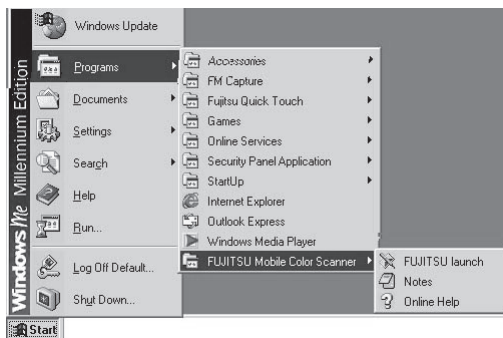

- The scanner normally operates only when Windows is restarted and the scanner is connected to the computer as described in “Preparations” in the User’s Manual. Perform the operation below before connecting the scanner to the computer. (See “Checking the Connection”.)

1

Select Settings from the Start menu and click Control Panel.



2

Double-click System in the Control Panel dialog.



3

On Windows 98/Me, click the Device Manager tab in the System Properties dialog.

On Windows 2000, click the Device Manager button on the Hardware page in the System Properties dialog.

4

Check that USB Device is displayed under Other Devices on the Device Manager page.

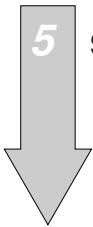
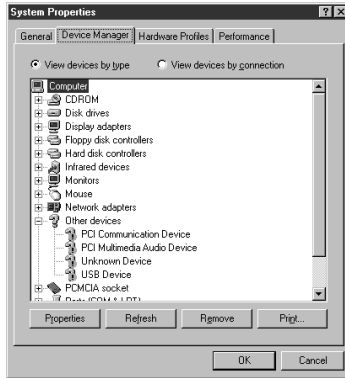

5 Select USB Device and click the Remove button.

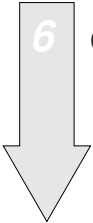

6 Connect the scanner to the computer.

Although the setup disk is inserted, the main menu does not appear.

Start Explorer and double-click Instmenu.exe on the setup disk.

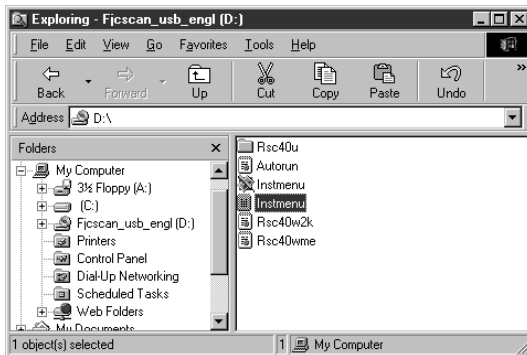

Problems after scanning

The scanned image contains streaks.

- The optical unit of the scanner may be dirty or there may be foreign matter on the unit. Clean the optical unit. (Refer to “Maintenance” and “Cleaning the Optical Unit”.)
- Perform calibration again. This problem may be solved. (See “Preparations” in the User’s Manual and “calibration” in the Glossary.)

The scanned image is blurred or distorted or colors run.

- The original may not have been scanned straight. Scan the original again straight with using a ruler as a guide.
- Check whether the original satisfies the conditions described in “Conditions for Originals the Scanner Can Scan” and “Original Sizes the Scanner Can Scan”. If the original does not satisfy any condition, the scanned image may be affected.
- Check the original for wrinkles and creases.

The scanned image is dark.

- The optical unit of the scanner may be dirty. Clean the optical unit. (Refer to “Cleaning the Optical Unit”.)
- Perform calibration. (See “Preparations”.)

A commercial software program cannot read scanned images.

- Check whether the software program supports this scanner. If the software program does not support this scanner, but supports TWAIN, it may be possible to use this scanner. In this case, however, some functions of this scanner may be unavailable.
- Check whether the correct scanner model is selected for the software program. If the selected model is incorrect, select a correct scanner model, referring to the software manual.

Aliasing in the image is noticeable.

- If the scanning resolution is low, aliasing may become noticeable depending on the image. Specify a higher resolution and scan the original again.
- Although an original is scanned at high resolution, aliasing may become noticeable when the image is scaled up. Make an enlarged copy of the original itself and scan the copy.

The margins of the original are not white.

- Areas which look white differ in the degree of whiteness in fact. For this reason, a white area may be scanned as data with a specific degree of whiteness. In this case, set a high value for Brightness on the Image Adjustment page on the driver screen. (Refer to “Screens Displayed during the Use of the Scanner”.)
- For an original consisting of monochrome text, set a low value for Threshold on the Main page on the driver screen. (Refer to “Screens Displayed during the Use of the Scanner”.)

It takes time to scan an image.

When an original is scanned at high resolution, the computer’s response may become slow. In this case, scan the image at low resolution.

The scanner cannot be used when operation is resumed.

If the scanner is connected to a USB hub such as a liquid crystal display, connect it to the computer.

Specifications

Hardware Specifications

Scanning method	Hand-held
Resolution	600 x 600 dpi
Scanning device	Contact image-sensor
Scanning speed	3.9 ms/line (at 600 dpi)
Interface	USB
Original	Maximum scanning size without stitching 105 mm wide x 364 mm long with stitching 420 mm wide x 364 mm long Minimum scanning size 13 mm wide x 13 mm long
Specified form sizes	A6, two A6-size sheets in portrait orientation, business cards, postcards, photographs, free, and custom In Stitching mode A4 Portrait, A4 Landscape, B4 Portrait, B4 Landscape, Letter Portrait, Letter Landscape, and Free
Scanned image	Color (16,770,000 colors), gray scale (256 shades of gray), halftone (dither matrix mode, 64 shades of gray), and black & white
Dimensions	142 mm wide x 30 mm deep x 30 mm high
Weight	About 100 g
Input power	Via the USB cable
Power consumption	2.5 W

Operating Environment

Scanner Driver Operating Environment

Compatible operating systems	Windows 98/Me, Windows 2000 Professional
CPU	Recommended: Pentium/266 MHz or higher
Memory ^(*)	At least 64 MB (Windows 98/Me) Recommended: At least 128 MB (scanning at 600 dpi on Windows 2000)
Hard disk	At least 5 MB of available space
Connection port	USB Port

*1: Stitching images of a large original requires at least 64 MB of memory.

Environmental Requirements

Dust	Environment equivalent to an ordinary office or home Avoid using the scanner in an environment where there is excessive dust.
Illumination	Avoid using the scanner in a location exposed to direct sunlight or an external light source.
Ambient temperature	Operating: 5 to 35°C Not operating: 0 to 50°C
Ambient humidity	Operating: 20 to 80% RH Not operating: 10 to 80% RH

⦿ Guide

Connect the scanner to a USB hub with an internal power supply (hub to which power is supplied from the power cable or AC adapter) and use up to a two-stage serial connection when required.

Before Making Inquiries

If you want to consult Fujitsu about the scanner or have any inquiries thereon, check the following items and contact a Fujitsu service representative.

The information in the list below will allow us to respond to you more quickly.

Model name of the connected computer	:	Manufacturer name ()
	:	Model name ()
Type of operating system in use	:	<input type="checkbox"/> Windows 98 <input type="checkbox"/> Windows Me <input type="checkbox"/> Windows 2000
Built-in memory capacity	:	MB
Hard disk capacity	:	MB
Version of scanner software	:	
Application and its version	:	
Settings for scanning	:	

Connection	:	<input type="checkbox"/> Directly connected to a computer <input type="checkbox"/> Network (Write as many details as possible.)
------------	---	--

Connection cable in use	:	Manufacturer name () Model name ()
-------------------------	---	---

Error message or details of the inquiry

Glossary

Terms that may be unfamiliar to beginners are described below.

Calibration

Operation for determining the reference values for black and white areas, so that the computer can accurately identify each information item in an image scanned by the scanner. For the Mobile Color Scanner, use the calibration sheet supplied with it for calibration. Be sure to perform calibration before using this scanner for the first time.

Install

To incorporate software and hardware information into a computer and make the information ready.

To use this scanner, software called the scanner driver must be installed. The scanner cannot scan images just by connecting it to a computer with the cable.

Resolution

Resolution is expressed as the number of pixels (dots) per inch (dpi). If the resolution is higher, the image can be read in greater detail, but the memory requirement also increases. Select a suitable resolution for the digitized image.

Scanner driver

Program for making this Mobile Color Scanner available for software compatible with scanners. This scanner driver conforms to TWAIN, which is a standard for interfaces between an image input-output device such as a scanner and digital cameras and software.

Stitching Mode

Select this mode to scan a large document or image original that cannot be scanned at one time. This driver automatically stitches adjoining images while reading the printed document and sends one image to the application.

TWAIN

The standard for interfaces between an image input-output device such as a scanner and digital cameras and software.

Free Manuals Download Website

<http://myh66.com>

<http://usermanuals.us>

<http://www.somanuals.com>

<http://www.4manuals.cc>

<http://www.manual-lib.com>

<http://www.404manual.com>

<http://www.luxmanual.com>

<http://aubethermostatmanual.com>

Golf course search by state

<http://golfingnear.com>

Email search by domain

<http://emailbydomain.com>

Auto manuals search

<http://auto.somanuals.com>

TV manuals search

<http://tv.somanuals.com>