

Owner's Manual

PHILCO

Please read before using this unit.

DVD/CD Player

DP100HH8

INSTRUCCIONES EN ESPAÑOL INCLUIDAS.

Contents

Supplied Accessories

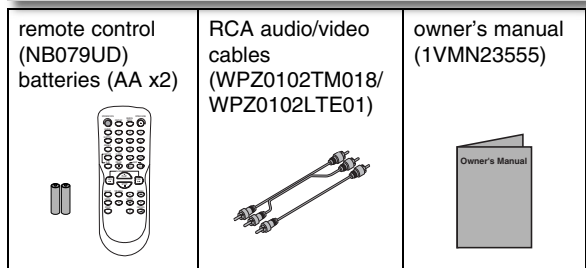

Connecting to RF Modulator (Not Supplied)

If your TV has antenna in jack only, it is still possible to connect this unit to your TV by using an RF modulator. In this case, follow the instructions below.

- 1) Disconnect the power cords of the devices from the AC outlet.
- 2) Make the connection as illustrated below.
- 3) **Set your RF modulator's channel 3/4 switch to either 3 or 4**, whichever the TV channel is least used in your area. If your RF modulator has a modulator/antenna switch, set it according to the manual supplied with the RF modulator.
- 4) Plug in the power cords of the devices to the AC outlet.
- 5) **Turn on your TV and choose the same channel as you set the RF modulator's channel 3/4 switch to.** For more details, follow the manual supplied with the RF modulator.

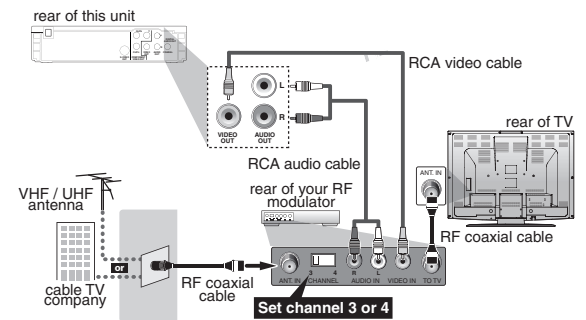

Note:

- RF modulator is not supplied with this unit. You need to purchase it at your local store.
- The quality of picture may become poor if this unit is connected to an RF modulator.

If you need additional operating assistance after reading this owner's manual, please call
TOLL FREE : 1-800-317-6062
 or visit our web site at
<http://www.funai-corp.com>

© 2007 Funai Electric Co., Ltd.

PRECAUTIONS

Laser Safety	2
■ Important Safeguards	3
Location and Handling	4
Avoid the Hazards of Electrical Shock and Fire	4
Moisture Condensation Warning	4
About Copyright	4
Notice for Progressive Scan Outputs	4
Symbols Used in this Manual	4
Maintenance	4
■ About the Discs	5
Playable Discs	5
Unplayable Discs	5

SETUP

■ Connections	6
Connection to a TV	6
Connection to an Audio System	7
Rear Terminals	7
■ About the Remote Control	8
Remote Control	8
Installing the Batteries for the Remote Control	8

DVD FUNCTIONS

■ Playback	9
■ MP3 Playback	10
■ Search Functions	10
Using Track Search	10
Using Title / Chapter Search	10
Using Time Search	10
■ On-Screen Display	11
■ Repeat / Random / Programmed Playback	12
Repeat Playback	12
Repeat A-B Playback	12
Random Playback	12
Programmed Playback	12
■ Special Settings	13
Subtitle Language	13
Audio Language	13
Camera Angles	13
Black Level Setting	13
Stereo Sound Mode	13
Virtual Surround	13
■ DVD Setting	14
LANGUAGE Setting	14
DISPLAY Setting	15
AUDIO Setting	15
PARENTAL Setting	16
OTHERS Setting	16
Reset to the Default Setting (Except for PARENTAL Setting)	17

INFORMATION

■ Troubleshooting Guide	17
■ Specifications	18
■ Limited Warranty	18
■ Español	19
■ Quick Use Guide	Back Cover

PRECAUTIONS
SETUP
INFORMATION
DVD FUNCTIONS
Español

PRECAUTIONS

WARNING: TO REDUCE THE RISK OF FIRE OR ELECTRIC SHOCK, DO NOT EXPOSE THIS APPLIANCE TO RAIN OR MOISTURE.



CAUTION
RISK OF ELECTRIC SHOCK
DO NOT OPEN



The lightning flash with arrowhead symbol, within an equilateral triangle, is intended to alert the user to the presence of uninsulated "dangerous voltage" within the product's enclosure that may be of sufficient magnitude to constitute a risk of electric shock to persons.



The exclamation point within an equilateral triangle is intended to alert the user to the presence of important operating and maintenance (servicing) instructions in the literature accompanying the appliance.

CAUTION:

TO REDUCE THE RISK OF ELECTRIC SHOCK, DO NOT REMOVE COVER (OR BACK). NO USER SERVICEABLE PARTS INSIDE. REFER SERVICING TO QUALIFIED SERVICE PERSONNEL.

The caution marking is located on the rear of the cabinet.

Laser Safety

This unit employs a laser. Only a qualified service person should remove the cover or attempt to service this device, due to possible eye injury.

CAUTION: USE OF CONTROLS OR ADJUSTMENTS OR PERFORMANCE OF PROCEDURES OTHER THAN THOSE SPECIFIED HEREIN MAY RESULT IN HAZARDOUS RADIATION EXPOSURE.

CAUTION: VISIBLE AND INVISIBLE LASER RADIATION WHEN OPEN AND INTERLOCK DEFEATED. DO NOT STARE INTO BEAM.

LOCATION: INSIDE, NEAR THE DECK MECHANISM.

FCC WARNING- This equipment may generate or use radio frequency energy. Changes or modifications to this equipment may cause harmful interference unless the modifications are expressly approved in the manual. The user could lose the authority to operate this equipment if an unauthorized change or modification is made.

RADIO-TV INTERFERENCE

This equipment has been tested and found to comply with the limits for a Class B digital device, pursuant to Part 15 of the FCC Rules. These limits are designed to provide reasonable protection against harmful interference in a residential installation. This equipment generates, uses, and can radiate radio frequency energy and, if not installed and used in accordance with the instructions, may cause harmful interference to radio communications. However, there is no guarantee that interference will not occur in a particular installation. If this equipment does cause harmful interference to radio or television reception, which can be determined by turning the equipment off and on, the user is encouraged to try to correct the interference by one or more of the following measures:

- 1) Reorient or relocate the receiving antenna.
- 2) Increase the separation between the equipment and receiver.
- 3) Connect the equipment into an outlet on a circuit different from that to which the receiver is connected.
- 4) Consult the dealer or an experienced radio/TV technician for help.

This Class B digital apparatus complies with Canadian ICES-003.

Cet appareil numérique de la classe B est conforme à la norme NMB-003 du Canada.

CAUTION: TO PREVENT ELECTRIC SHOCK, MATCH WIDE BLADE OF PLUG TO WIDE SLOT, FULLY INSERT.

ATTENTION: POUR ÉVITER LES CHOCS ÉLECTRIQUES, INTRODUIRE LA LAME LA PLUS LARGE DE LA FICHE DANS LA BORNE CORRESPONDANTE DE LA PRISE ET POUSSER JUSQU'AU FOND.

A NOTE ABOUT RECYCLING

This product's packaging materials are recyclable and can be reused. Please dispose of any materials in accordance with your local recycling regulations.

Batteries should never be thrown away or incinerated but disposed of in accordance with your local regulations concerning chemical wastes.

Make your contribution to the environment!!!

- Used up batteries do not belong in the dust bin.
- You can dispose of them at a collection point for used up batteries or special wastes. Contact your council for details.



For Customer Use:

Read carefully the information located at the bottom of this unit and enter below the Model No. and the Serial No. Retain this information for future reference.

Model No. _____

Serial No. _____

Important Safeguards

- 1) Read Instructions - All the safety and operating instructions should be read before the product is operated.
- 2) Retain Instructions - The safety and operating instructions should be retained for future reference.
- 3) Heed Warnings - All warnings on the product and in the operating instructions should be adhered to.
- 4) Follow Instructions - All operating and use instructions should be followed.
- 5) Cleaning - Unplug this product from the wall outlet before cleaning. Do not use liquid cleaners or aerosol cleaners. Use a damp cloth for cleaning.
- 6) Attachments - Do not use attachments not recommended by the product manufacturer as they may cause hazards.
- 7) Water and Moisture - Do not use this product near water - for example, near a bath tub, wash bowl, kitchen sink, or laundry tub; in a wet basement; or near a swimming pool; and the like.
- 8) Accessories - Do not place this product on an unstable cart, stand, tripod, bracket, or table. The product may fall, causing serious injury to a child or adult, and serious damage to the product. Use only with a cart, stand, tripod, bracket, or table recommended by the manufacturer, or sold with the product. Any mounting of the product should follow the manufacturer's instructions, and should use a mounting accessory recommended by the manufacturer.
- 9) A product and cart combination should be moved with care. Quick stops, excessive force, and uneven surfaces may cause the product and cart combination to overturn.
- 10) Ventilation - Slots and openings in the cabinet are provided for ventilation and to ensure reliable operation of the product and to protect it from overheating, and these openings must not be blocked or covered. The openings should never be blocked by placing the product on a bed, sofa, rug, or other similar surface. This product should not be placed in a built-in installation such as a bookcase or rack unless proper ventilation is provided or the manufacturer's instructions have been adhered to.
- 11) Power Sources - This product should be operated only from the type of power source indicated on the marking label. If you are not sure of the type of power supply to your home, consult your product dealer or local power company. For products intended to operate from battery power, or other sources, refer to the operating instructions.
- 12) Grounding or Polarization - This product may be equipped with a polarized alternating-current line plug (a plug having one blade wider than the other). This plug will fit into the power outlet only one way. This is a safety feature. If you are unable to insert the plug fully into the outlet, try reversing the plug. If the plug should still fail to fit, contact your electrician to replace your obsolete outlet. Do not defeat the safety purpose of the polarized plug.
- 13) Power-Cord Protection - Power-supply cords should be routed so that they are not likely to be walked on or pinched by items placed upon or against them, paying particular attention to cords at plugs, convenience receptacles, and the point where they exit from the product.
- 14) Lightning - For added protection for this product during a lightning storm, or when it is left unattended and unused for long periods of time, unplug it from the wall outlet. This will prevent damage to the product due to lightning and power-line surges.
- 15) Power lines - An outside antenna system should not be located in the vicinity of overhead power lines or other electric light or power circuits, or where it can fall into such power lines or circuits. When installing an outside antenna system, extreme care should be taken to keep from touching such power lines or circuits as contact with them might be fatal.
- 16) Overloading - Do not overload wall outlets, extension cords, or integral convenience receptacles as this can result in a risk of fire or electric shock.
- 17) Object and Liquid Entry - Never push objects of any kind into this product through openings as they may touch dangerous voltage points or short-out parts that could result in a fire or electric shock. Never spill liquid of any kind on the product.
- 18) Servicing - Do not attempt to service this product yourself as opening or removing covers may expose you to dangerous voltage or other hazards. Refer all servicing to qualified service personnel.
- 19) Damage Requiring Service - Unplug this product from the wall outlet and refer servicing to qualified service personnel under the following conditions:
 - a) When the power-supply cord or plug is damaged.
 - b) If liquid has been spilled, or objects have fallen into the product.
 - c) If the product has been exposed to rain or water.
 - d) If the product does not operate normally by following the operating instructions. Adjust only those controls that are covered by the operating instructions as an improper adjustment of other controls may result in damage and will often require extensive work by a qualified technician to restore the product to its normal operation.
 - e) If the product has been dropped or damaged in any way.
 - f) When the product exhibits a distinct change in performance - this indicates a need for service.
- 20) Replacement Parts - When replacement parts are required, be sure the service technician has used replacement parts specified by the manufacturer or have the same characteristics as the original part. Unauthorized substitutions may result in fire, electric shock, or other hazards.
- 21) Safety Check - Upon completion of any service or repairs to this product, ask the service technician to perform safety checks to determine that the product is in proper operating condition.
- 22) Heat - The product should be situated away from heat sources such as radiators, heat registers, stoves, or other products (including amplifiers) that produce heat.

PORTABLE CART WARNING
(Symbol provided by RETAC)



Location and Handling

- Do not stand this unit up vertically. Install this unit in a horizontal and stable position. Do not place anything directly on top of this unit. Do not place this unit directly on top of the TV.
- Depending on the TV, noise or disturbance of the picture and/or sound may be generated if this unit is placed too close to your TV. In this case, please ensure enough space between your TV and this unit.
- Do not cover or place this unit in enclosed spaces to prevent excessive temperature build up.
- Do not place this unit in direct sunlight, or near heat sources.
- Depending on the environment, the temperature of this unit may increase slightly. This is not a malfunction.
- Keep this unit away from strong magnetic objects.
- Do not place any object containing water or other liquids on this unit. In the event that liquid should enter the cabinet, unplug this unit and contact the retailer or an Authorized Service Center immediately.
- Do not remove this unit cabinet. Touching parts inside the cabinet could result in electric shock and/or damage to this unit. For service and adjustment inside the cabinet, call a qualified dealer or an Authorized Service Center.
- Be sure to remove disc and unplug the AC power cord from the output before carrying this unit.

Avoid the Hazards of Electrical Shock and Fire

- Do not handle the power cord with wet hands.
- Do not pull on the power cord when disconnecting it from AC wall outlet. Grasp it by the plug.
- If, by accident, water is spilled on this unit, unplug the power cord immediately and take the unit to our Authorized Service Center for servicing.

Moisture Condensation Warning

Moisture may form inside this unit under the following conditions:

- Immediately after a heater is turned on.
- In a steamy or humid room.
- When this unit is suddenly moved from a cold to warm environment.

If moisture forms inside this unit, it may not operate properly or damage the disc. In such case, do not use this unit for at least 2 hours until its inside gets dry.

About Copyright

Unauthorized copying, broadcasting, public performance and lending of discs are prohibited.

This product incorporates copyright protection technology that is protected by U.S. patents and other intellectual property rights. Use of this copyright protection technology must be authorized by Macrovision, and is intended for home and other limited viewing uses only unless otherwise authorized by Macrovision. Reverse engineering or disassembly is prohibited.

Notice for Progressive Scan Outputs

Consumers should note that not all high definition television sets are fully compatible with this product and may cause artifacts to be displayed in the picture. In case of picture problems with 525 progressive scan output, it is recommended that the user switch the connection to the 'standard definition' output. If there are questions regarding your TV set compatibility with this 525p DVD player, please contact our customer service center.

Symbols Used in this Manual

The following symbols appear in some headings in this manual.

 **DVD**: Description refers to DVD-video.

 **CD**: Description refers to audio CD.

 **MP3**: Description refers to CD-RW/-R with MP3 files.

Maintenance

Servicing

- Please refer to relevant topics on the "Troubleshooting Guide" on page 17 before returning the unit.
- If this unit becomes inoperative, do not try to correct the problem by yourself. There are no user-serviceable parts inside. Turn off, unplug the power plug, and please call our help line mentioned on the front page to locate an Authorized Service Center.

Cleaning the Cabinet

- Use a soft cloth slightly moistened with a mild detergent solution. Do not use a solution containing alcohol, spirits, ammonia or abrasive.

Cleaning Discs

- When a disc becomes dirty, clean it with a cleaning cloth. Wipe the disc from the center to out. Do not wipe in a circular motion.
- Do not use solvents such as benzine, thinner, commercially available cleaners, detergent, abrasive cleaning agents or antistatic spray intended for analog records.

Cleaning the Disc Lens

- If this unit still does not perform properly although you refer to the relevant sections and to "Troubleshooting Guide" in this owner's manual, the laser optical pickup unit may be dirty. Consult your dealer or an Authorized Service Center for inspection and cleaning of the laser optical pickup unit.

Disc Handling

- When you handle a disc hold it by its edge and try not to touch the surface of the disc.
- Always store a disc in its protective case when it is not used.

© 2007 Funai Electric Co., Ltd.

All rights reserved. No part of this manual may be reproduced, copied, transmitted, disseminated, transcribed, downloaded or stored in any storage medium, in any form or for any purpose without the express prior written consent of Funai. Furthermore, any unauthorized commercial distribution of this manual or any revision hereto is strictly prohibited.

Information in this document is subject to change without notice. Funai reserves the right to change the content herein without the obligation to notify any person or organization of such changes.

FUNAI with the  design is a registered trademark of Funai Electric Co., Ltd and may not be used in any way without the express written consent of Funai. All other trademarks used herein remain the exclusive property of their respective owners. Nothing contained in this manual should be construed as granting, by implication or otherwise, any license or right to use any of the trademarks displayed herein. Misuse of any trademarks or any other content in this manual is strictly prohibited. Funai shall aggressively enforce its intellectual property rights to the fullest extent of the law.



Manufactured under license from Dolby Laboratories. "Dolby" and the double-D symbol are trademarks of Dolby Laboratories.



Product that have earned ENERGY STAR® are designed to protect the environment through superior energy efficiency.

About the Discs

Playable Discs

Type of media	Mark (logo)	Region code	Recorded signals	Disc size	Disc types
DVD-video *1, 2, 4, 6, 9		or	digital video (MPEG2)	5 inches (12 cm) or 3 inches (8 cm)	 e.g.) title 1 title 2 chapter 1 chapter 2 chapter 3 chapter 4 chapter 1 chapter 2
DVD-RW DVD-R *1, 3, 4, 5, 6, 7, 8, 9	 	—			
DVD+RW DVD+R *1, 4, 5, 6, 8, 9	 	—			
audio CD *4, 6, 9		—	digital audio	5 inches (12 cm) or 3 inches (8 cm)	 audio CD e.g.) track 1 track 2 track 3 track 4 track 5 track 6
CD-RW CD-R *4, 5, 6, 8, 9	 	—	digital audio or MP3		 MP3 e.g.) folder 1 folder 2 file 1 file 2 file 3 file 4 file 1 file 2

DVD is a trademark of DVD Format/Logo Licensing Corporation.

If you cannot play back a disc which bears one of the marks above, check the following notes.

- *1: This unit conforms to the NTSC color system. Discs recorded in other color systems such as PAL cannot be played back.
- *2: Certain DVD-video do not operate as described in this manual due to the intentions of the disc's producers.
- *3: Discs recorded in the VR (Video Recording) format cannot be played back.
- *4: Scratched or stained discs may not be played back.
- *5: Some discs cannot be played back because of incompatible recording conditions, characteristics of the recorder or special properties of discs.
- *6: You can play back discs which bear the marks above. If you use non-standardized discs, this unit may not play them back. Even if they are played back, the sound or video quality will be compromised.
- *7: Only the discs recorded in the video format and finalized can be played back. Unfinalized discs cannot be played back. Depending on the recording status of a disc, the disc may not be played back at all. The picture or sound may not be smooth, etc.
- *8: If the recorded portion of the disc is too small (smaller than 2-3/16 inches (55mm) across), it may not be played back.
- *9: Do not glue paper or put stickers on to the disc. These may damage the disc, and the unit may not read it correctly.

Unplayable Discs

NEVER play back the following discs as malfunction may result!

DVD-RAM / DVD-audio / CD-i / photo CD / video CD / DVD with region codes other than 1 or ALL / DTS-CD / DVD-ROM for personal computers / CD-ROM for personal computers

On the following disc, the sound MAY NOT be heard.

super audio CD

Any other discs without compatibility indications

Note:

- Only the sound recorded on the normal CD layer can be delivered. The sound recorded on the high density super audio CD layer cannot be delivered.

SETUP

Connections

Connection to a TV

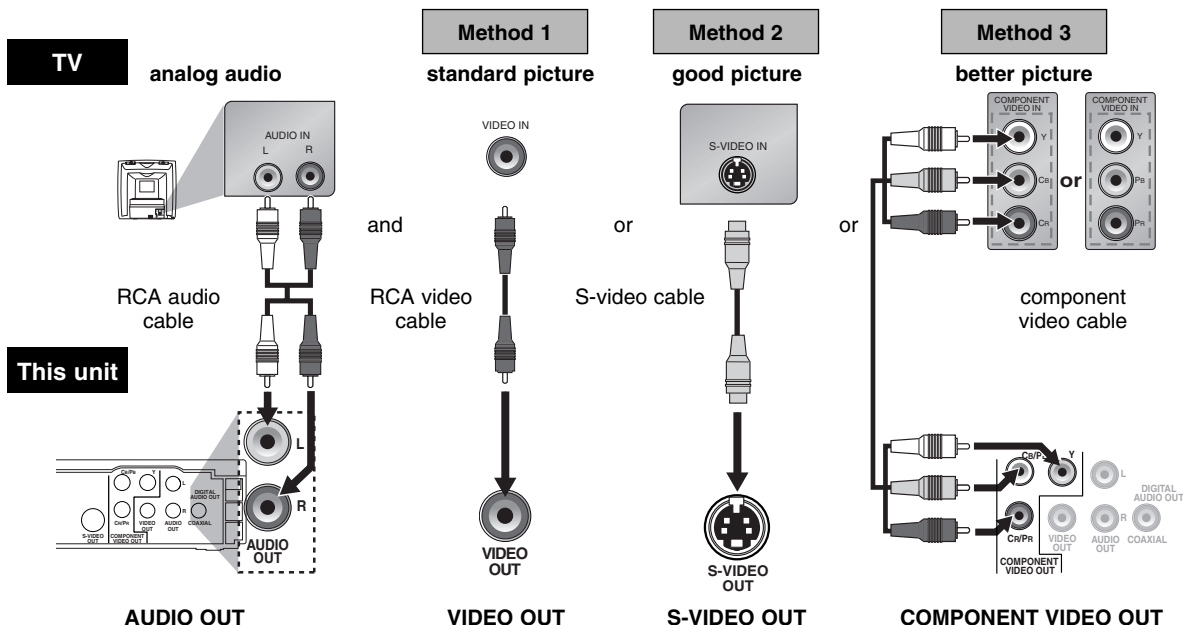

Supplied cables used in this connection are as follows:

- RCA audio cable (L/R) x 1
- RCA video cable x 1

Please purchase the rest of the necessary cables at your local store.

Note:

- Connect this unit directly to the TV. If RCA audio/video cables are connected to a VCR, pictures may be distorted due to the copy protection system.

If your TV is compatible with 525 progressive scanning and you want to enjoy that high quality picture;

You must select the connection Method 3 above and progressive scanning mode. To set the mode, set "PROGRESSIVE" to "ON" in "DISPLAY" menu, so that the P-SCAN indicator on the front panel lights up. Refer to pages 14-15 for more details.

- When "PROGRESSIVE" is "ON", video signals from the unit's VIDEO OUT and S-VIDEO OUT jacks will be distorted or not be output at all.

If your TV is not compatible with progressive scanning;

Use this unit in interlace mode and set "PROGRESSIVE" to "OFF" either in "DISPLAY" menu or by pressing and holding [PLAY ►] on the front of the unit for more than 5 seconds, so that the P-SCAN indicator on the front panel turns off.

After connecting to your TV:

You will need to switch to video input on your TV. This is usually marked TV/VIDEO, INPUT or AUX. Please refer to your TV's manual for details.

INPUT MODES FOR COMMON TV BRANDS

Listed below are inputs for common brand name TV's.

Admiral:	AUX	Panasonic:	TV/VIDEO
Curtis Mathis:	LINE1, LINE2, 00, 90, 91, 92, 93	RCA:	INPUT, TV/VCR, 00, 90, 91, 92, 93
GE:	INPUT, TV/VCR, 00, 90, 91, 92, 93	Samsung:	TV/VIDEO
Hitachi:	INPUT, AUX	Sanyo:	VIDEO
JVC:	VIDEO, VIDEO1, VIDEO2, VIDEO3	Sharp:	00
Kenwood:	AUX	Sony:	VIDEO1, VIDEO2, VIDEO3
LXI-Series:	00	Toshiba:	TV/GAME
Magnavox:	AUX CHANNEL	Zenith:	00

Connection to an Audio System

Analog Audio Connection

Digital Audio Connection

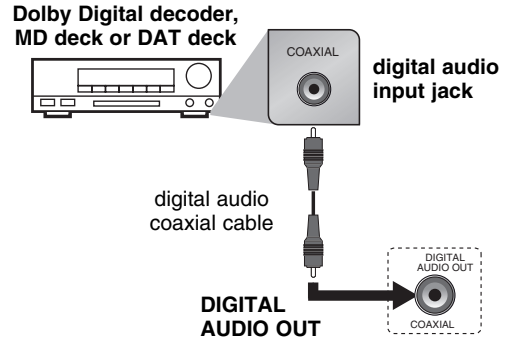
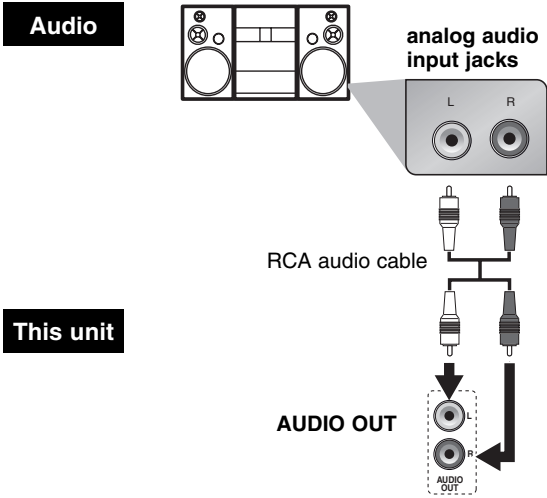

Connection	Setting	SETUP > AUDIO > DOLBY DIGITAL
Connecting to a Dolby Digital decoder for Dolby Digital audio output.		BITSTREAM
Connecting to the other device (an MD deck or DAT deck etc.) without Dolby Digital decoder.		PCM

* To complete these settings, refer to pages 14-15.

Note:

- The audio source on a disc in a Dolby Digital multi-channel surround format cannot be recorded as digital sound by an MD or DAT deck.
- By hooking this unit up to a Dolby Digital decoder, you can enjoy high-quality Dolby Digital multi-channel surround sound as heard in the movie theaters.
- Playing back a DVD using incorrect settings may generate noise distortion and may also damage the speakers.

Supplied cables used in this connection are as follows:

- RCA audio cable (L/R) x 1
- Please purchase the rest of the necessary cables at your local store.

Rear Terminals

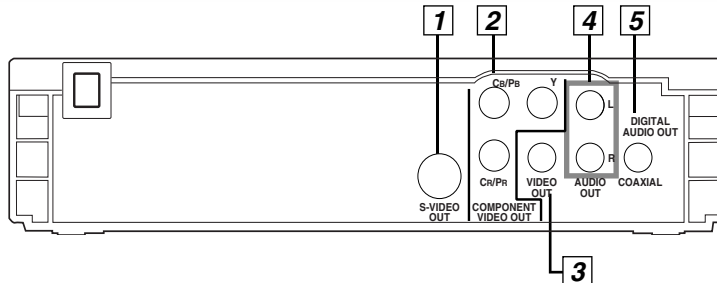

- S-VIDEO OUT jack**
Connect an optional S-video cable here through the S-video in jack of a television.
- COMPONENT VIDEO OUT jacks**
Connect optional component video cable here through the component video in jacks of a television.
- VIDEO OUT jack**
Connect a yellow video cable here through the video in jack of a television.
- AUDIO OUT jacks**
Connect an audio cable here through the audio in jacks of a television or other audio device.
- DIGITAL AUDIO OUT COAXIAL jack**
Connect a digital audio coaxial cable here through the digital audio coaxial in jack of a decoder or audio receiver.

Note:

- Please purchase the necessary cables at your local store. (Refer to pages 6-7.)

About the Remote Control

Remote Control

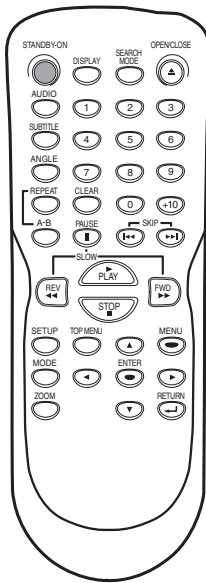

Installing the Batteries for the Remote Control

Install batteries (AA x2) matching the polarity indicated inside battery compartment of the remote control.



Keep in mind the following when using the remote control:

- Make sure that there are no obstacles between the remote control and the remote sensor on the unit.
- The maximum operable ranges from the unit are as follows.

-Line of sight:

approx. 23 feet (7m)

-Either side of the center:

approx. 16 feet (5m) within 30°

-Above: approx. 16 feet (5m) within 15°

-Below: approx. 10 feet (3m) within 30°

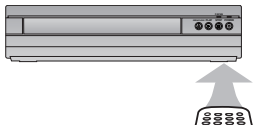

Note:

- Do not mix alkaline and manganese batteries.
- Do not mix old and new batteries.
- Always remove batteries from remote control if they are dead or if the remote control is not to be used for an extended period of time. This will prevent battery acid from leaking into the battery compartment.

Media	DVD	CD MP3
Button (Alphabetical order)		
1 2 3 4 5 6 7 8 9 0	• To select chapter or title directly.	• To select track directly. (CD) • To select folder/file directly. (MP3)
ENTER	• To move the cursor and determine its position.	• To move the cursor and determine its position.
A-B	• To repeat between your chosen point of A and B.	• To repeat between your chosen point of A and B.
ANGLE	• To select camera angles on a disc.	—
AUDIO	• To select audio language on a disc.	• To select "STEREO", "L-ch" or "R-ch". (CD)
CLEAR	• To remove status number in program input. • To clear the numbers entered incorrectly. • To cancel the point for A-B repeat.	• To remove status number in program input. • To clear the numbers entered incorrectly. • To cancel the point for A-B repeat.
DISPLAY	• To display the current disc mode.	• To display the current disc mode.
REV FWD	• To search forward/backward through a disc. • To begin slow forward playback in the pause mode.	• To search forward/backward through a disc.
MENU	• To call up the menu on a disc.	—
MODE	• To arrange the playing order or play randomly. • To set black level on/off. • To set virtual surround on/off.	• To arrange the playing order or play randomly. • To set virtual surround on/off.
OPEN/CLOSE	• To open or close the disc tray. • To turn on the unit.	• To open or close the disc tray. • To turn on the unit.
PAUSE	• To pause disc playback. • To advance playback one frame at a time.	• To pause disc playback.
PLAY	• To begin disc playback. • To turn on the unit.	• To begin disc playback. • To turn on the unit.
REPEAT	• To play back a chapter or title repeatedly.	• To play back a track or disc repeatedly. (CD) • To play back a file, folder or disc repeatedly. (MP3)
RETURN	• To return to the previous operation in menu.	• To return to the previous operation in menu.
SEARCH MODE	• To search chapter, title or time.	• To search tracks. • To search time. (CD) • To search folders. (MP3)
SETUP	• To call up the setup menu.	• To call up the setup menu.
SKIP	• To skip chapters or titles.	• To skip tracks. (CD) • To skip folders or files. (MP3)
STANDBY-ON	• To turn the unit on/off.	• To turn the unit on/off.
STOP	• To stop playback.	• To stop playback.
SUBTITLE	• To select subtitles on a disc.	—
TOP MENU	• To call up the top menu on a disc.	—
ZOOM	• To magnify part of a picture. (x2 / x3 / x4 / x1/2)	—

DVD FUNCTIONS

Please note : most instructions in this manual refer to remote control use.

Playback

Before:

Turn on the TV, amplifier and any other devices which are connected to this unit. Make sure the TV and audio receiver are set to the correct channel.

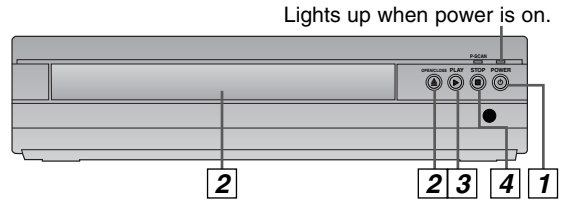
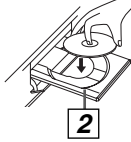

- 1 Press [STANDBY-ON] to turn on this unit.
- 2 Press [OPEN / CLOSE ▲] and insert a disc with label facing up.
- 3 Press [PLAY ►] to start playback.
- 4 Press [STOP ■] to stop playback.

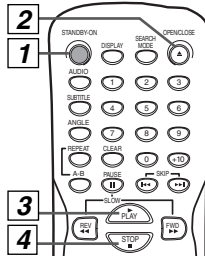

Note:

- When you play back a CD-RW/-R with MP3 files, details on page 10.
- A "⊘" may appear at the top-right on the TV screen when the operation is prohibited by the disc or this unit.
- Some DVD may start playback from title 2 or 3 due to specific programs.
- During the playback of a 2-layered disc, pictures may stop for a moment. This happens while the 1st layer is being switched to the 2nd layer. This is not a malfunction.
- You can change the on-screen language in "PLAYER MENU" setting. (Refer to page 14.)

Disc Menu



Some discs contain menus which allow you to customize DVD playback. Use [▲ / ▼ / ◀ / ▶] to select an item, then press [ENTER] (or [PLAY ►]).

Calling Up a Menu Screen during Playback



- Press [MENU] to call up the disc menu.
- Press [TOP MENU] to call up the title menu.

Note:

- Menu operations may vary depending on the disc. Refer to the manual accompanying the disc for more details.

Resume Playback



Press [STOP ■] during playback. Resume icon will appear at the top-left on the TV screen. Press [PLAY ►], playback will resume from the point at which playback was stopped.



Note:

- To cancel resume, press [STOP ■] one more time in the stop mode.
- The resume information will be kept even when unit is in standby mode.
- For MP3, playback will resume from the beginning of the track at which playback was stopped.

Paused and Step-by-Step Playback



Press [PAUSE II] during playback. To continue playback, press [PLAY ►].



The disc goes forward by one frame each time [PAUSE II] is pressed in the pause mode. To continue playback, press [PLAY ►].

Note:

- Set "STILL MODE" to "FIELD" in "DISPLAY" menu if pictures in the pause mode are blurred. (Refer to pages 14-15.)

Fast Forward / Reverse Search



Use [FWD ►►] or [REV ◀◀] repeatedly during playback to select the required forward or reverse speed. To continue playback, press [PLAY ►].



Note:

- Fast forward or reverse search speed is different depending on the disc. Approximate speed is 1(x2), 2(x4), 3(x8), 4(x16) and 5(x32).

Slow Forward Search



Press [FWD ►►] repeatedly in the pause mode to select the required forward speed. To continue playback, press [PLAY ►].



Note:

- Slow forward speed is different depending on the disc. Approximate speed is 1(1/32), 2(1/16), 3(1/8), 4(1/4) and 5(1/2).
- Set "STILL MODE" to "FIELD" in "DISPLAY" menu if pictures in the slow playback mode are blurred. (Refer to pages 14-15.)
- The reverse of slow playback is not available.

Zoom



1) Press [ZOOM] repeatedly during playback to select the required zoom factor: x2, x3, x4, x1/2 or off.



2) Use [▲ / ▼ / ◀ / ▶] to slide the zoomed picture across the screen.

3) To exit zoom function, press [ZOOM] repeatedly to select OFF.

Note:

- Zooming function does not work while the disc menu is displayed.
- Some part of the picture may not be zoomed depending on the disc or playback status.

MP3 Playback

MP3 is a method of compressing files. You can copy MP3 files on CD-RW/R from the computer and play back the files on this unit.



Insert a CD-RW/R with MP3 files, then the file list will automatically appear on the TV screen.

1 Select the desired folder from the list on the left side in the file list.

Press [ENTER] or [PLAY ▶].

2 Select the desired file from the list on the right side in the file list.

Press [ENTER] or [PLAY ▶].

Note:

- Some selections may take a while to be recognized.
- Folders are known as groups; files are known as tracks.
- MP3 files are accompanied by icon.
- Folders are accompanied by icon.
- Refer to "On-Screen Display" on page 11 for more details.
- If you record data over 20 times, it may not be played back correctly.

This unit recommends the files recorded under the following circumstances:

- Sampling frequency: 44.1kHz or 48kHz.
- Constant bit rate: 32kbps ~ 320kbps.

3 Refer to "Resume Playback" on page 9.



Search Functions

Using Track Search Using Title / Chapter Search Using Time Search



Using [SEARCH MODE]

1 e.g.) CD

2 Enter the desired track number within 5 seconds.

3 Press [ENTER].

- To play back a double-digit track, press the track number directly for CD (e.g. for track 3, press [3] and [ENTER]).
- To play back a triple-digit track, press the track number directly for MP3. (e.g. for track 3, press [3] and [ENTER], and for track 26, press [2], [6] and [ENTER]).

Using [SKIP] [◀◀], [▶▶]

1 Current Track

Note:

- For audio CD, track search is not available for programmed or random playback.



Using [SEARCH MODE]

1 or Press [SEARCH MODE] once for the title search. For the chapter search, press cursor [▶] to highlight .

2 Enter the desired title or chapter number within 5 seconds.

3 Press [ENTER].

Using [SKIP] [◀◀], [▶▶]

1 Current Chapter

Note:

- Depending on the disc being played back, this function can also be performed by directly entering the desired chapter number with [the Number buttons]. Refer to the manual accompanying the disc.
- For DVD, title/chapter search is not available for programmed or random playback.



Using [SEARCH MODE]

1 e.g.) DVD

Press cursor [▶] to highlight .

CD: once
DVD: twice

2 Enter the desired time within 5 seconds.

e.g.) DVD

3 Press [ENTER].

Note:

- To play time 0:15:00, press [1], [5], [0], [0] of [the Number buttons].
- Press [CLEAR] to erase the incorrect input at step 2.
- For DVD and audio CD, time search is not available for programmed or random playback.

DVD FUNCTIONS

On-Screen Display

You can check the information about the current disc by pressing **[DISPLAY]** on the remote control.

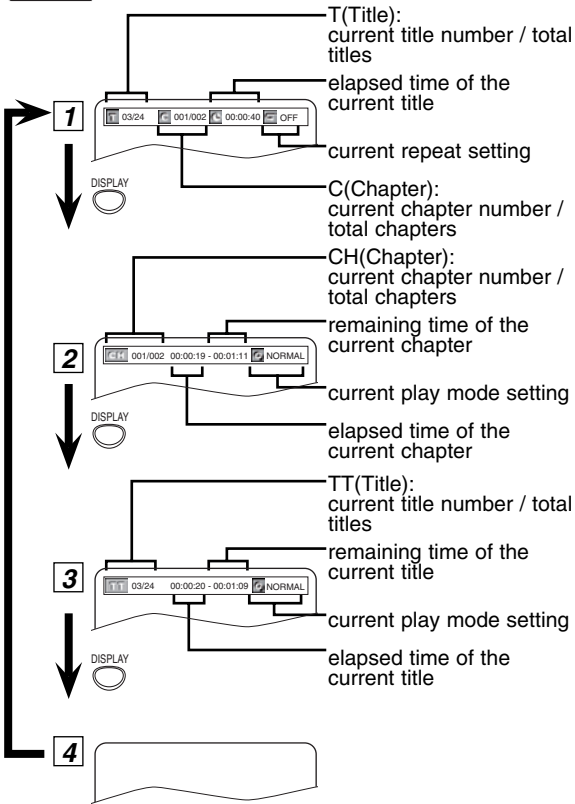

Note:

- Some DVD will not allow you to set chapter playback correctly.

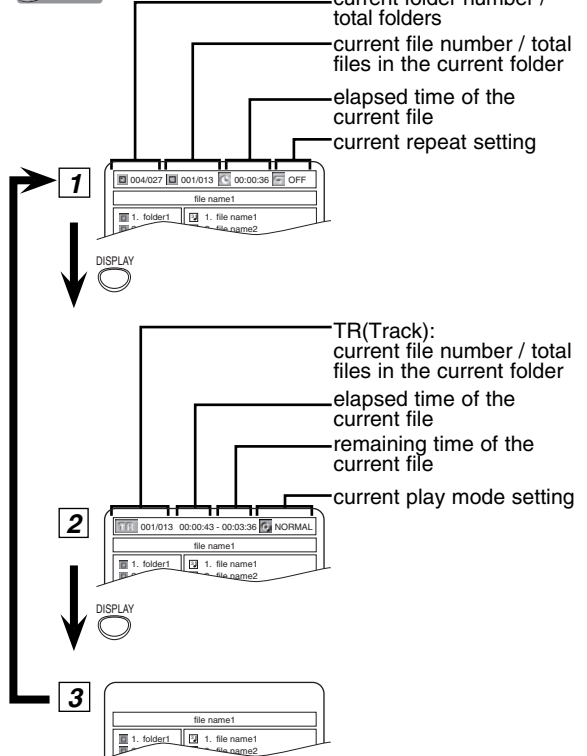
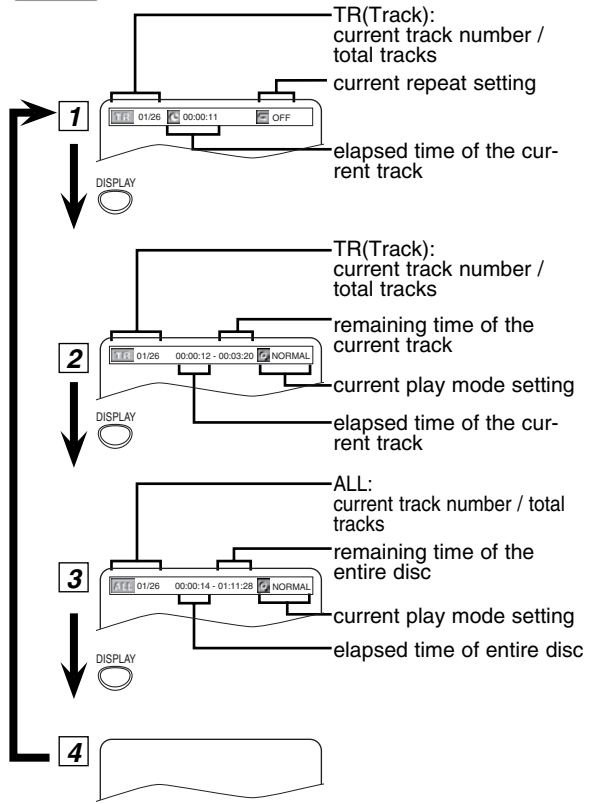

DVD FUNCTIONS

Repeat / Random / Programmed Playback

Repeat Playback



Repeat function is available only during playback.

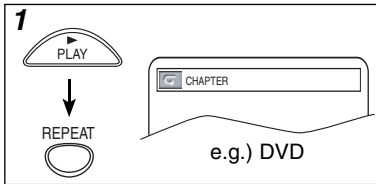

Each time you press [REPEAT], repeat function changes as example below.

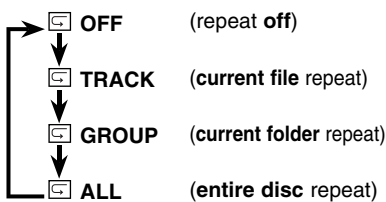
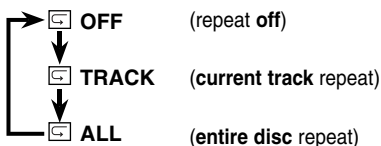
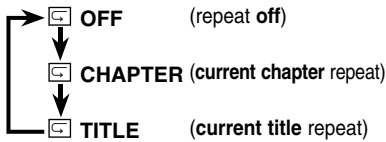

Note:

- Repeat setting (except "ALL") will be cleared when moving to another title, chapter, track/file or folder.
- This function is not available with some discs or during repeat A-B playback.

Repeat A-B Playback

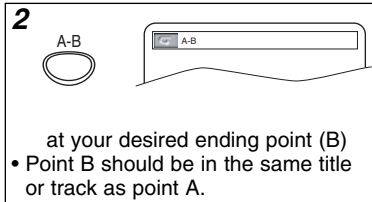
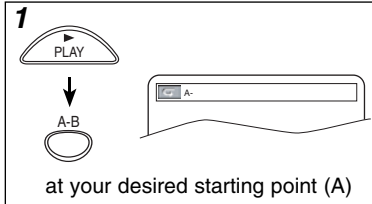

Note:

- To exit the sequence, press [A-B] so that "OFF" appears.
- To cancel point A, press [CLEAR] at step 1.
- This function does not work in the other repeat modes.

Random Playback



This function shuffles the playing order of chapters or tracks instead of playback in the sequence.

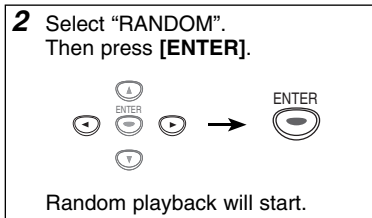
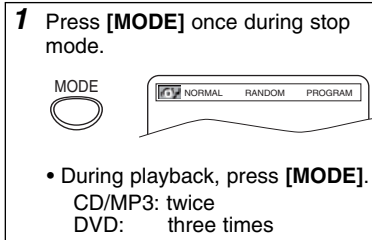

Note:

- During random playback, you cannot go back to the previous track, using [SKIP >>>] allows you to search chapters or tracks randomly.
- During DVD random playback, you can play back chapters in the current title randomly.
- Some DVD will not allow you to set random playback.

Programmed Playback



You may determine the order in which chapters or tracks will play back.

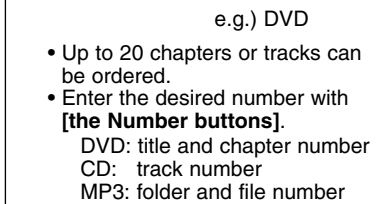
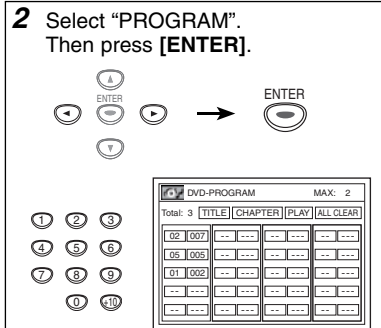
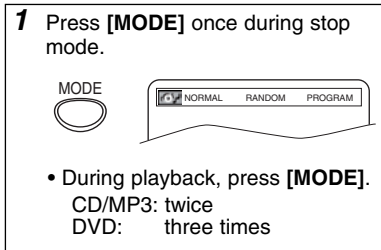

Note:

- To erase all program at once, select "ALL CLEAR" and press [ENTER] or press [CLEAR] at step 2.
- If the title, chapter, track number is incorrect, the programmed number you entered will be skipped during programmed playback.
- While a program is being played back, [STOP] works as follows: Press [STOP] and [PLAY] next, so that the programmed playback restarts. Press [STOP] twice and [PLAY] next, so that playback restarts from the first track in the original order. However, your programmed playback can be restarted when you follow the above steps. (Your programs are still stored until either the disc is removed or power is turned off.)
- Some DVD will not allow you to set programmed playback.
- During programmed playback, you cannot setup "TITLE" (DVD), "GROUP" (MP3).

Special Settings

Subtitle Language



This unit allows you to select a subtitle language (if available) during DVD playback.

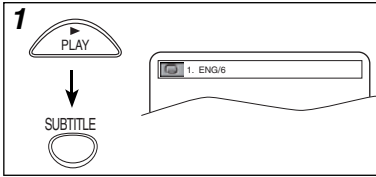

Each time you press [SUBTITLE], subtitle language changes as example below.

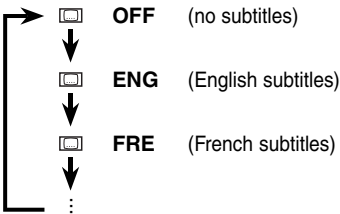

To set subtitle ON/OFF

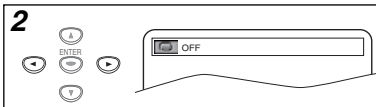
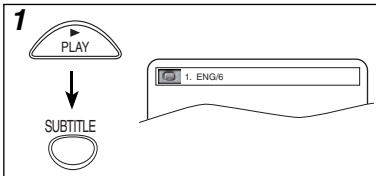

Note:

- If your language is not shown after pressing [SUBTITLE] several times, the disc may not have that language. However, some discs allow subtitle language setting on the disc menu. (Operation varies depending on the disc, so refer to the manual along with the disc.)
- When “” appears on the TV screen, it means no subtitle is recorded on the scene.
- Some discs will only allow you to change the subtitle from the disc menu. Refer to the manual accompanying the discs for details.

Audio Language



This unit allows you to select an audio language (if multiple languages are available on disc) during DVD playback.

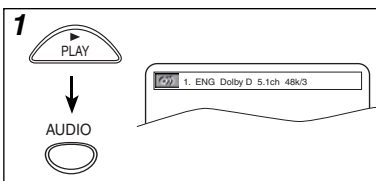

Each time you press [AUDIO] or [◀/▶], audio language changes as example below.

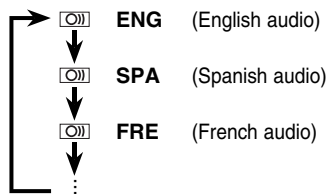

Note:

- Some discs will only allow you to change the audio setting from the disc menu. Refer to the manual accompanying the discs for details.
- If your language is not shown after pressing [AUDIO] several times, the disc may not have that language. However, some discs allow audio language setting on the disc menu. (Operation varies depending on the disc, so refer to the manual along with the disc.)

Camera Angles



Some DVD may contain scenes which have been shot simultaneously from various angles. You can change the camera angle if appears on the screen. If the “ANGLE ICON” setting is “OFF” in “OTHERS” menu, will not appear. (Refer to pages 14-16.)

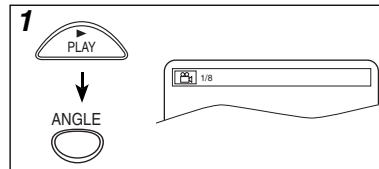

Each time you press [ANGLE] or [◀/▶], camera angle changes.

Black Level Setting



Adjust the black level to make the dark areas of the TV picture brighter.

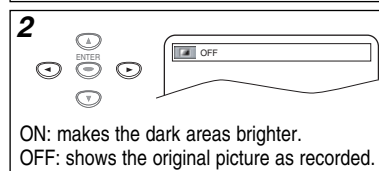
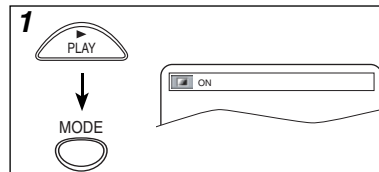

ON: makes the dark areas brighter.

OFF: shows the original picture as recorded.

Stereo Sound Mode



This unit allows you to select a sound mode during CD playback.

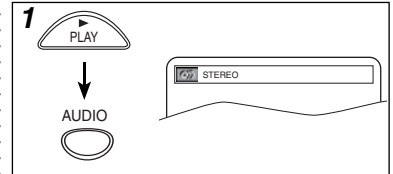

Each time you press [AUDIO] or [◀/▶], sound mode changes as example below.

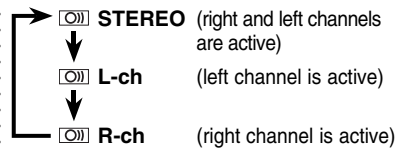

Virtual Surround



You can enjoy stereophonic virtual world on your existing 2 channel stereo system.

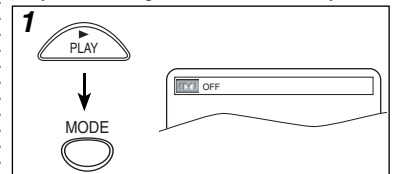

Press twice.
(once for CD and MP3)

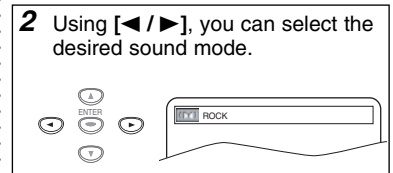

- 3D: sound mode suitable for setting stereophonic audio.
 JAZZ: sound mode suitable for jazz music
 ROCK: sound mode suitable for rock music
 POP: sound mode suitable for pop music
 CLASSIC: sound mode suitable for classic music
 OFF: no effects (original sound)



Note:

- Virtual surround is available only when the DVD player is connected to a TV or stereo using the red and white AUDIO OUT jacks on the DVD player. Also, select the “SETUP” menu to use Dolby Digital connection (COAXIAL), and setting in PCM mode.

DVD Setting

You can change the settings of the unit.

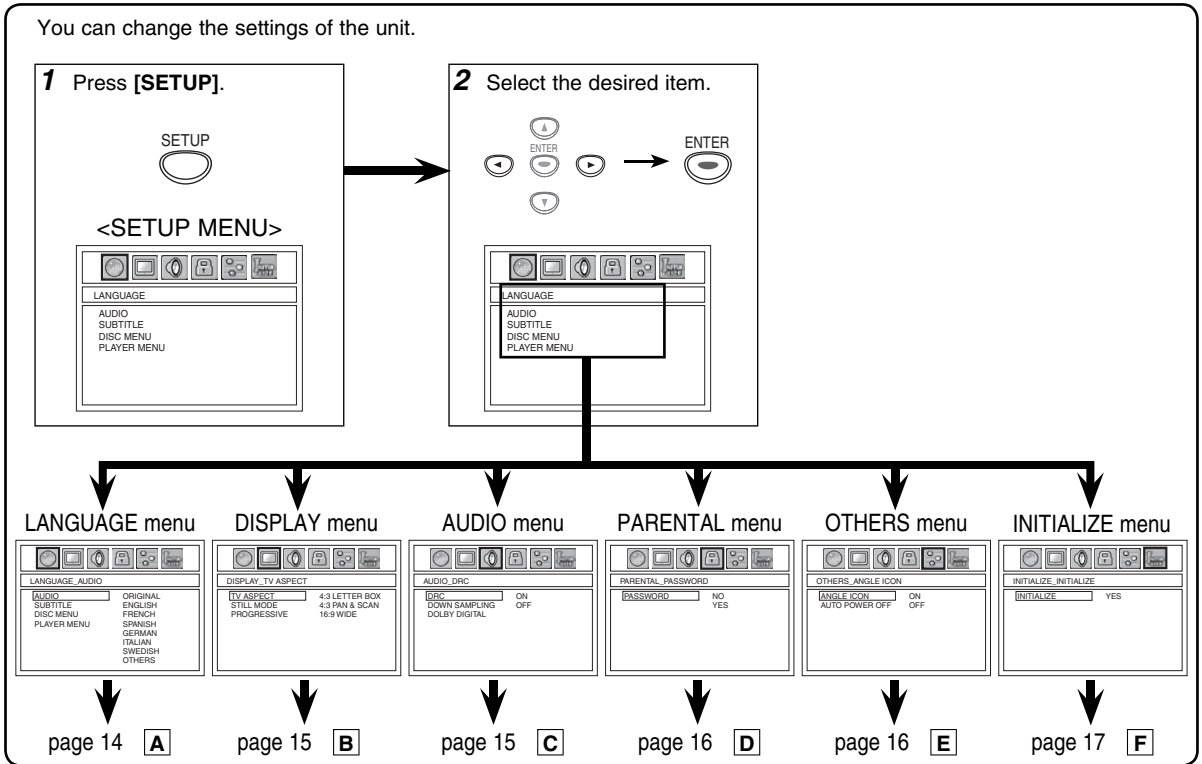

DVD FUNCTIONS

A LANGUAGE Setting

Follow steps 1 to 2 above.

3 Select the desired item.

4 Select the desired language.

5 To exit the menu

Note:

- *1 Language options are not available with some discs.
- *2 If "OTHERS" is selected in the "AUDIO", "SUBTITLE" or "DISC MENU" screen, select the desired language using [▲/▼/◀/▶]. Press [ENTER].

• Only the languages supported by the disc can be selected.

*2 "LANGUAGE" setting for "AUDIO" and "SUBTITLE" are not available with some discs. Then press [AUDIO] and [SUBTITLE]. Details are on page 13.

LANGUAGE AUDIO

▶ DUTCH	▶ RUSSIAN	▶ CHINESE
▶ JAPANESE	▶ KOREAN	▶ DANISH
▶ FINNISH	▶ NORWEGIAN	▶ ICELANDIC
▶ ROMANIAN	▶ TURKISH	▶ GREEK
▶ IRISH	▶ PORTUGUESE	▶ POLISH
▶ CZECH	▶ HUNGARIAN	

LANGUAGE AUDIO

AUDIO	ORIGINAL
SUBTITLE	ENGLISH
DISC MENU	FRENCH
PLAYER MENU	SPANISH
	GERMAN
	ITALIAN
	SWEDISH
	OTHERS

LANGUAGE SUBTITLE

AUDIO	OFF
SUBTITLE	ENGLISH
DISC MENU	FRENCH
PLAYER MENU	SPANISH
	GERMAN
	ITALIAN
	SWEDISH
	OTHERS

LANGUAGE DISC MENU

AUDIO	ENGLISH
SUBTITLE	FRENCH
DISC MENU	SPANISH
PLAYER MENU	GERMAN
	ITALIAN
	SWEDISH
	DUTCH
	OTHERS

LANGUAGE PLAYER MENU

AUDIO	ENGLISH
SUBTITLE	FRANCAIS
DISC MENU	ESPAÑOL
PLAYER MENU	

B DISPLAY Setting

You can change the display functions. Follow steps 1 to 2 on page 14.

3 Select the desired item.

DISPLAY menu

DISPLAY TV ASPECT

TV ASPECT 4:3 LETTER BOX
STILL MODE 4:3 PAN & SCAN
PROGRESSIVE 16:9 WIDE

4

TV ASPECT: (Default: 4:3 LETTER BOX)
See note on the left.

STILL MODE: (Default: AUTO)
See note on the left.

PROGRESSIVE: (Default: OFF)
See note on the right.

If there is no picture or you do not press any buttons for 15 seconds, "PROGRESSIVE" will switch to "OFF" and it will exit the "SETUP" menu.

5 To exit "TV ASPECT" or "STILL MODE" menu

SETUP

To complete "PROGRESSIVE" setting

ENTER

Note:

TV ASPECT:

- Select "4:3 LETTER BOX", so that black bars may appear on the top and bottom of the screen.
- Select "4:3 PAN & SCAN" for a full height picture with both sides adjusted.
- Select "16:9 WIDE" if a wide-screen TV is connected to this unit.

STILL MODE:

- Select "AUTO" usually.
- If you select "AUTO", it automatically selects the best resolution setting ("FRAME" or "FIELD") based on the data characteristics of the pictures. (default)
- If you select "FIELD", the picture in the still mode will be stabilized.
- If you select "FRAME", the picture in the still mode will be highly defined.
- An individual picture on TV screen is called a "frame", which consists of two separate images called as "field".
- Some pictures may be blurred if you select "AUTO" in the still mode due to their data characteristics.

Note:

PROGRESSIVE:

- You can set "PROGRESSIVE" to "OFF" in "DISPLAY" menu or press and hold [PLAY ►] on the front of the unit for more than 5 seconds during playback, so that the P-SCAN indicator on the front panel turns off.
- When "PROGRESSIVE" is "ON", video signals from the unit's VIDEO OUT and S-VIDEO OUT jacks will be distorted or not be output at all.

C AUDIO Setting

Choose the appropriate audio settings for your device. It only affects during the playback of DVD. Follow steps 1 to 2 on page 14.

3 Select the desired item.

AUDIO menu

AUDIO_DRC

DRC ON
DOWN SAMPLING OFF
DOLBY DIGITAL

4

DRC (Dynamic Range Control): (Default: ON)
Set to "ON" to compress the range between soft and loud sounds.

DOWN SAMPLING: (Default: ON)
Set to "ON" when outputting in 48kHz.
Set to "OFF" when outputting the original sound.

DOLBY DIGITAL: (Default: BITSTREAM)
Set to "BITSTREAM" when the unit is connected to a Dolby Digital decoder.

- BITSTREAM: outputs a Dolby Digital signals.
- PCM: convert the Dolby Digital into PCM (2 channel).

5 To exit the menu

SETUP

Note:

DRC:

- This function is available only on the discs which are re-recorded in the Dolby Digital format.

DOWN SAMPLING:

- When playing back disc with copyright protection, the sound will be down sampled at 48kHz, even if you set to "OFF".

D PARENTAL Setting

Parental control limits the disc viewing that exceed your settings. (An incorrect password will not be acceptable.) This feature prevents your children from viewing inappropriate materials.

Parental Levels

Parental level allows you to set the rating levels of your DVD. Playback will stop if the ratings exceed the levels you set. Follow steps 1 to 2 on page 14.

3 Press [ENTER], and then select "YES".

If the password has not been set yet.

PARENTAL menu

If the password has been set already, enter the current 4-digit password.

PARENTAL menu

If you do not need parental lock, choose "NO". Press [ENTER].

4 Enter your desired 4-digit password.

Enter a new password again.

5 Select "LEVEL".

6 Select the desired level, and press [ENTER].

TIPS FOR LEVELS

- 8 [ADULT]: DVD software of any grades (adult/general/children) can be played back.
- 7 [NC-17]: no one under 17 admitted
- 6 [R]: restricted; under 17 requires accompanying parent or adult guardian
- 5 [PGR]: parental guidance recommended
- 4 [PG13]: unsuitable for children under 13
- 3 [PG]: parental guidance suggested
- 2 [G]: general audience
- 1 [KID SAFE]: suitable for children

7 To exit the menu

Note:

- The resume information will be cleared if you change the parental level when the resume information is on.

To Change the Password for Parental Controls

You can change your password for parental controls. Follow steps 1 to 2 on page 14.

6 Select "CHANGE" at step 5 above.

PARENTAL menu

7 Enter your desired 4-digit password.

Enter new password

8 Enter your new 4-digit password again.

Re-enter password

9 To exit the menu

Note:

- Record the password in case you forget it.
- If you forget the password, press [4], [7], [3], [7] at step 3 above, then enter your new password. Password will be cleared and parental levels will be set to "8 [ADULT]".

E OTHERS Setting

You can change the other functions. Follow steps 1 to 2 on page 14.

3 Select the desired item.

OTHERS menu

4

ANGLE ICON: (Default: ON)
Set to "ON" to display when multiple camera angles are available during DVD playback.

AUTO POWER OFF: (Default: ON)
Set to "ON" to turn this unit off automatically after 30 minutes of no use.

5 To exit the menu

F Reset to the Default Setting (Except for PARENTAL Setting)

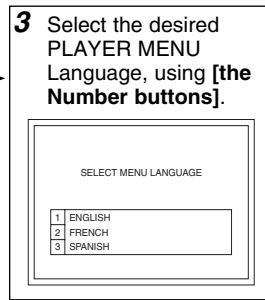
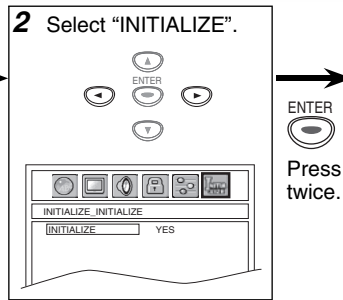
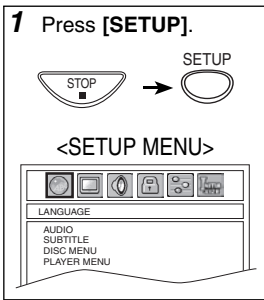

Note:

- When you do not wish to initialize, press [SETUP] to exit the menu at step 2.

INFORMATION

Troubleshooting Guide

If the unit does not perform properly when operated as instructed in this owner's manual, refer to the following.

Problem	Corrective action
No power	<ul style="list-style-type: none"> -Check if the AC power cord is properly connected. -Unplug the outlet once, and wait for 5-10 seconds and then plug it in again.
No sound or picture	<ul style="list-style-type: none"> -Check if the TV is switched on. -Check the video connection. -Check the audio/video cable connections to the TV. (Refer to page 6.)
Distorted picture	<ul style="list-style-type: none"> -Sometimes a small amount of picture distortion may appear. This is not a malfunction. -Connect the unit directly to the TV. -Set "PROGRESSIVE" correctly in "DISPLAY" menu. Turn it on only if your TV has progressive scan and you are using the component video connections between the unit and the TV. Disable progressive scan for all other connections. (Refer to page 6.)
Completely distorted picture or black/white picture with DVD	<ul style="list-style-type: none"> -Connect this unit directly to the TV. -Make sure the disc is compatible with the unit.
No sound or distorted sound	<ul style="list-style-type: none"> -Adjust the volume. -Check that the speakers are connected correctly.
No audio at digital output	<ul style="list-style-type: none"> -Check the digital connections. -Check if the audio format of the selected audio language matches your receiver capabilities.
No DTS audio is output.	<ul style="list-style-type: none"> -This unit does not support DTS audio. This is not a malfunction.
Picture freezes momentarily during playback.	<ul style="list-style-type: none"> -Check the disc for fingerprints/dirty and clean with a soft cloth wiping from center to edge.
Disc cannot be played back.	<ul style="list-style-type: none"> -Clean the disc. -Ensure the disc is inserted in correct direction. -Check if the disc is defective by trying another disc. -Cancel the parental lock or change the control level. -Insert a correct disc that plays back on this unit. -Handle a disc with special care so that it does not have fingerprints, scratches, or dusts on its surface.
No return to start-up screen when disc is removed.	<ul style="list-style-type: none"> -Reset the unit by switching off the unit, then on again.
The unit does not respond to the remote control.	<ul style="list-style-type: none"> -Aim the remote control directly at the sensor on the front panel. -Reduce the distance to the unit. -Replace the batteries in the remote control. -Re-insert the batteries with their polarities (+/- signs) as indicated. -Tune your radio to an empty AM station so that you hear a lot of noises. Then, turn up the volume. If you hear some signal sound from the radio by pressing buttons on the remote control, the remote control is working. -Press and hold any button on remote control toward a digital camera. The remote control is working if you confirm infrared light through the digital camera.
Buttons do not work or the unit stops responding.	<ul style="list-style-type: none"> -To completely reset the unit, unplug the AC cord from the AC outlet for 5-10 seconds.
The unit does not respond to some operating commands during playback.	<ul style="list-style-type: none"> -Operations may not be permitted by the disc. Refer to the instructions of the disc.
The unit cannot read CD / DVD.	<ul style="list-style-type: none"> -Use a commonly available cleaning CD / DVD to clean the lens before sending the unit for repair.
Angle does not switch.	<ul style="list-style-type: none"> -The angle cannot be switched for DVD which do not contain multiple angles. In some cases multiple angles are only recorded for specific scenes.
Playback does not start when the title is selected.	<ul style="list-style-type: none"> -Check the "PARENTAL" setting.
The password for rating level has been forgotten.	<ul style="list-style-type: none"> -Enter the default password "4737", then your forgotten password will be cleared.

- Some functions are not available in specific modes, but this is not a malfunction. Read the description in this owner's manual for more details on correct operations.
- Playback from a desired track and random playback are not available during programmed playback.
- Some functions are prohibited on some discs.

Specifications

Output signal format :
NTSC color

Power source :

120V AC +/- 10%, 60Hz +/- 0.5%

Power consumption :

10W (standby : 0.9W)

Operating temperature :
41°F (5°C) to 104°F (40°C)

Dimensions :

W : 8.3" (210mm)

H : 2.0" (50mm)

D : 9.1" (245mm)

Weight :

Approx 1.8lbs. (0.8kg)

- Designs and specifications are subject to change without notice.
- If there is a discrepancy between languages, the default language will be English.

PHILCO LIMITED WARRANTY

FUNAI CORP. will repair this product, free of charge in the USA in the event of defect in materials or workmanship as follows:

DURATION:

PARTS: FUNAI CORP. will provide parts to replace defective parts without charge for one (1) year from the date of original retail purchase. Certain parts are excluded from this warranty.

LABOR: FUNAI CORP. will provide the labor without charge for a period of ninety (90) days from the date of original retail purchase.

LIMITS AND EXCLUSIONS:

This warranty is extended only to the original retail purchaser. A purchase receipt or other proof of original retail purchase will be required together with the product to obtain service under this warranty.

This warranty shall not be extended to any other person or transferee.

This warranty is void and of no effect if any serial numbers on the product are altered, replaced, defaced, missing or if service was attempted by an unauthorized service center. This limited warranty does not apply to any product not purchased and used in the United States.

This product is produced for home use and this warranty only covers failures due to defects in material or workmanship which occurs during normal use. It does not cover damage which occurs in shipment, or failures which are caused by repairs, alterations or product not supplied by FUNAI CORP., or damage which results from accident, misuse, abuse, mishandling, misapplication, alteration, faulty installation, improper maintenance, commercial use such as hotel, rental or office use of this product or damage which results from fire, flood, lightning or other acts of God.

THIS WARRANTY DOES NOT COVER PACKING MATERIALS, ANY ACCESSORIES (EXCEPT REMOTE CONTROL), ANY COSMETIC PARTS, COMPLETE ASSEMBLY PARTS, DEMO OR FLOOR MODELS. FUNAI CORP. AND ITS REPRESENTATIVES OR AGENTS SHALL IN NO EVENT BE LIABLE FOR ANY GENERAL, INDIRECT OR CONSEQUENTIAL DAMAGES ARISING OUT OF OR OCCASIONED BY THE USE OF OR THE IN-

ABILITY TO USE THIS PRODUCT. THIS WARRANTY IS MADE IN LIEU OF ALL OTHER WARRANTIES, EXPRESS OR IMPLIED, AND OF ALL OTHER LIABILITIES ON THE PART OF FUNAI, ALL OTHER WARRANTIES INCLUDING THE WARRANTY OF MERCHANTABILITY, AND FITNESS FOR A PARTICULAR PURPOSE, ARE HEREBY DISCLAIMED BY FUNAI AND ITS REPRESENTATIVES IN THE UNITED STATES. ALL WARRANTY INSPECTIONS AND REPAIRS MUST BE PERFORMED BY AN AUTHORIZED SERVICE CENTER. THIS WARRANTY IS VALID WHEN THE UNIT IS CARRIED-IN TO AN AUTHORIZED SERVICE CENTER.

IMPORTANT:

THIS LIMITED WARRANTY GIVES YOU SPECIFIC LEGAL RIGHTS. YOU MAY HAVE OTHER RIGHTS THAT VARY FROM STATE TO STATE. IF, AT ANY TIME DURING THE WARRANTY PERIOD, YOU ARE UNABLE TO OBTAIN SATISFACTION WITH THE REPAIR OF THIS PRODUCT, PLEASE CONTACT FUNAI CORP.

ATTENTION:

FUNAI CORP. RESERVES THE RIGHT TO MODIFY ANY DESIGN OF THIS PRODUCT WITHOUT PRIOR NOTICE.

WARRANTY STATEMENT REGARDING NON AUTHORIZED REPAIRS:

To obtain warranty service, you must take the product, or deliver the product freight prepaid, in either its original packaging or packaging affording an equal degree of protection, to any AUTHORIZED SERVICE CENTER. FUNAI CORP. will not reimburse you for any service done by unauthorized service providers without prior written approval.

To locate your nearest AUTHORIZED SERVICE CENTER or for general service inquiries, please contact us at:

FUNAI CORPORATION
Customer Service

Tel : 1-800-317-6062

<http://www.funai-corp.com>

19900 Van Ness Avenue, Torrance, CA 90501

1 Conexiones

Si su televisor tiene entradas de AUDIO/VIDEO vea la sección "Connection to a TV" en la página 6 en el manual de manejo. En caso contrario, vea la sección "Connecting to RF Modulator (Not Supplied)" en la página del frente en el manual de manejo.

2 Instalación de las pilas en el control remoto

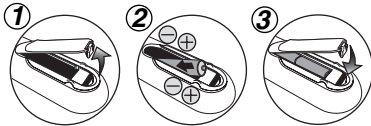

3 Para cambiar el idioma en la pantalla

1 Confirme que ha seleccionado "LANGUAGE".



2 Seleccione "PLAYER MENU".



3 Seleccione el idioma deseado para las indicaciones en la pantalla.



4 Para salir del menú

4 Reproducción

Antes.
¡Encienda el televisor, amplificador y otros equipos conectados a esta unidad. Asegúrese que el televisor y el sintonizador de audio están en el canal correcto.

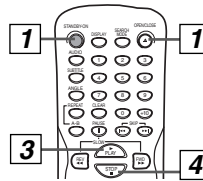

1 Para abrir o cerrar la bandeja del disco	2 Ponga un disco con la etiqueta hacia arriba.
3 Para empezar la reproducción	4 Para parar la reproducción

5 Control remoto

Botón (Orden alfabético)	DVD	CD MP3
1 2 3 4 5 6 7 8 9 0	• Para seleccionar directamente el capítulo o título.	• Para seleccionar directamente la canción. (CD) • Para seleccionar directamente el grupo/canción. (MP3)
ENTER ← →	• Para mover el cursor y determinar la posición.	• Para mover el cursor y determinar la posición.
A-B	• Para repetir entre su punto A y B seleccionado.	• Para repetir entre su punto A y B seleccionado.
ANGLE	• Para seleccionar los ángulos de la cámara en un disco.	—
AUDIO	• Para seleccionar idiomas de audio en un disco.	• Para seleccionar "ESTÉREO", "L-ch" o "R-ch". (CD)
CLEAR	• Para eliminar el N° de estado en la entrada de programa. • Para borrar los números mal entrados. • Para borrar el punto para la repetición A-B.	• Para eliminar el N° de estado en la entrada de programa. • Para borrar los números mal entrados. • Para borrar el punto para la repetición A-B.
DISPLAY	• Para mostrar el modo de disco actual.	• Para mostrar el modo de disco actual.
REV FWD	• Para buscar en avance/retroceso por un disco. • Para empezar la reproducción en avance lento durante el modo de pausa.	• Para buscar en avance/retroceso por un disco.
MENU	• Para llamar el menú en un disco.	—
MODE	• Para disponer el orden de reproducción o la reproducción aleatoria. • Para activar/desactivar el nivel del negro. • Para activar/desactivar el ambiental virtual.	• Para disponer el orden de reproducción o la reproducción aleatoria. • Para activar/desactivar el ambiental virtual.
OPEN/CLOSE	• Para abrir o cerrar la bandeja del disco. • Para encender la unidad.	• Para abrir o cerrar la bandeja del disco. • Para encender la unidad.
PAUSE	• Para hacer una pausa en la reproducción. • Para avanzar la reproducción un cuadro cada vez.	• Para hacer una pausa en la reproducción del disco.
PLAY	• Para empezar la reproducción del disco. • Para encender la unidad.	• Para empezar la reproducción del disco. • Para encender la unidad.
REPEAT	• Para reproducir repetidamente un capítulo o título.	• Para reproducir repetidamente una canción o disco. (CD) • Para reproducir repetidamente una canción, grupo o disco. (MP3)
RETURN	• Para volver a la operación anterior en el menú.	• Para volver a la operación anterior en el menú.
SEARCH MODE	• Para buscar un capítulo, título o tiempo.	• Para buscar una canción. • Para buscar el tiempo. (CD) • Para buscar los grupos. (MP3)
SETUP	• Para llamar el menú de ajustes de DVD.	• Para llamar el menú de ajustes de DVD.
SKIP	• Para saltar capítulos o título.	• Para saltar canciones. (CD) • Para saltar los grupos o canciones. (MP3)
STANDBY-ON	• Para encender o apagar la unidad.	• Para encender o apagar la unidad.
STOP	• Para parar la reproducción.	• Para parar la reproducción.
SUBTITLE	• Para seleccionar subtítulos en un disco.	—
TOP MENU	• Para llamar el menú inicial en un disco.	—
ZOOM	• Para ampliar la imagen de vídeo en DVD. (x2 / x3 / x4 / x1/2)	—

Quick Use Guide

1 Connections

If your TV has AUDIO/VIDEO input jacks, see the section "Connection to a TV" on page 6 of the owner's manual. If not, see the section "Connecting to RF Modulator (Not Supplied)" on the front page of the owner's manual.

2 Installing the Batteries for the Remote Control



3 To Change the On-Screen Language

1 Confirm that "LANGUAGE" is selected.

2 Select "PLAYER MENU".

3 Select the desired language for the on-screen language.

4 To exit the menu

4 Playback

Before:
Turn on the TV, amplifier and any other devices which are connected to this unit. Make sure the TV and audio receiver are set to the correct channel.

1 To open the disc tray

2 Insert a disc with label facing up.

3 To start playback

4 To stop playback

5 Remote Control

Button (Alphabetical order)	Media	DVD	CD MP3
1 2 3 4 5 6 7 8 9 0		• To select chapter or title directly.	• To select track directly. (CD) • To select folder/file directly. (MP3)
▲ ENTER ▼		• To move the cursor and determine its position.	• To move the cursor and determine its position.
A-B		• To repeat between your chosen point of A and B.	• To repeat between your chosen point of A and B.
ANGLE		• To select camera angles on a disc.	—
AUDIO		• To select audio language on a disc.	• To select "STEREO", "L-ch" or "R-ch". (CD)
CLEAR		• To remove status number in program input. • To clear the numbers entered incorrectly. • To cancel the point for A-B repeat.	• To remove status number in program input. • To clear the numbers entered incorrectly. • To cancel the point for A-B repeat.
DISPLAY		• To display the current disc mode.	• To display the current disc mode.
REV FWD		• To search forward/backward through a disc. • To begin slow forward playback in the pause mode.	• To search forward/backward through a disc.
MENU		• To call up the menu on a disc.	—
MODE		• To arrange the playing order or play randomly. • To set black level on/off. • To set virtual surround on/off.	• To arrange the playing order or play randomly. • To set virtual surround on/off.
OPEN/CLOSE		• To open or close the disc tray. • To turn on the unit.	• To open or close the disc tray. • To turn on the unit.
PAUSE		• To pause disc playback. • To advance playback one frame at a time.	• To pause disc playback.
PLAY		• To begin disc playback. • To turn on the unit.	• To begin disc playback. • To turn on the unit.
REPEAT		• To play back a chapter or title repeatedly.	• To play back a track or disc repeatedly. (CD) • To play back a file, folder or disc repeatedly. (MP3)
RETURN		• To return to the previous operation in menu.	• To return to the previous operation in menu.
SEARCH MODE		• To search chapter, title or time.	• To search tracks. • To search time. (CD) • To search folders. (MP3)
SETUP		• To call up the setup menu.	• To call up the setup menu.
SKIP		• To skip chapters or titles.	• To skip tracks. (CD) • To skip folders or files. (MP3)
STANDBY-ON		• To turn the unit on/off.	• To turn the unit on/off.
STOP		• To stop playback.	• To stop playback.
SUBTITLE		• To select subtitles on a disc.	—
TOP MENU		• To call up the top menu on a disc.	—
ZOOM		• To magnify part of a picture. (x2 / x3 / x4 / x1/2)	—

Free Manuals Download Website

<http://myh66.com>

<http://usermanuals.us>

<http://www.somanuals.com>

<http://www.4manuals.cc>

<http://www.manual-lib.com>

<http://www.404manual.com>

<http://www.luxmanual.com>

<http://aubethermostatmanual.com>

Golf course search by state

<http://golfingnear.com>

Email search by domain

<http://emailbydomain.com>

Auto manuals search

<http://auto.somanuals.com>

TV manuals search

<http://tv.somanuals.com>