

SYLVANIA

PLASMA DISPLAY

Owner's Manual 6842PE

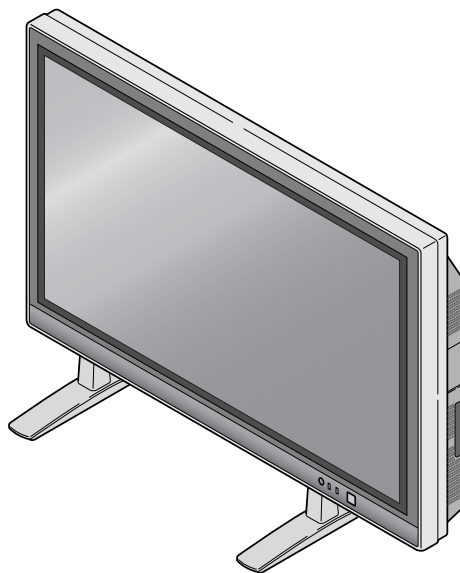

Before you can view a picture on the plasma display, you must first connect the unit to an external video source. See page 18 of the owner's manual.

**IF YOU NEED ADDITIONAL ASSISTANCE FOR SET-UP
OR OPERATING AFTER READING OWNER'S MANUAL,
PLEASE CALL TOLL FREE
1-800-605-8453, OR VISIT OUR
WEB SITE AT <http://www.funai-corp.com>**

WARNING:

TO REDUCE THE RISK OF FIRE OR ELECTRIC SHOCK, DO NOT EXPOSE THIS APPLIANCE TO RAIN OR MOISTURE.



CAUTION
RISK OF ELECTRIC SHOCK
DO NOT OPEN



CAUTION:

TO REDUCE THE RISK OF ELECTRIC SHOCK, DO NOT REMOVE COVER (OR BACK) NO USER SERVICEABLE PARTS INSIDE. REFER SERVICING TO QUALIFIED SERVICE PERSONNEL.



THIS SYMBOL INDICATES THAT DANGEROUS VOLTAGE CONSTITUTING A RISK OF ELECTRIC SHOCK IS PRESENT WITHIN THIS UNIT.



THIS SYMBOL INDICATES THAT THERE ARE IMPORTANT OPERATING AND MAINTENANCE INSTRUCTIONS IN THE LITERATURE ACCOMPANYING THE APPLIANCE.

The important note is located on the rear of the cabinet.

IMPORTANT SAFETY INSTRUCTIONS

1. Read these instructions.
2. Keep these instructions.
3. Heed all warnings.
4. Follow all instructions.
5. Do not use this apparatus near water.
6. Clean only with dry cloth.
7. Do not block any ventilation openings. Install in accordance with the manufacturer's instructions.
8. Do not install near any heat sources such as radiators, heat registers, stoves, or other apparatus (including amplifiers) that produce heat.
9. Do not defeat the safety purpose of the polarized or grounding-type plug. A polarized plug has two blades with one wider than the other. A grounding-type plug has two blades and a third grounding prong. The wide blade or the third prong are provided for your safety. If the provided plug does not fit into your outlet, consult an electrician for replacement of the obsolete outlet.
10. Protect the power cord from being walked on or pinched particularly at plugs, convenience receptacles, and the point where they exit from the apparatus.
11. Only use attachments/accessories specified by the manufacturer.
12. Use only with the cart, stand, tripod, bracket, or table specified by the manufacturer, or sold with the apparatus. When a cart is used, use caution when moving the cart/apparatus combination to avoid injury from tip-over.
13. Unplug this apparatus during lightning storms or when unused for long periods of time.
14. Refer all servicing to qualified service personnel. Servicing is required when the apparatus has been damaged in any way, such as power-supply cord or plug is damaged, liquid has been spilled or objects have fallen into the apparatus, the apparatus has been exposed to rain or moisture, does not operate normally, or has been dropped.
15. Apparatus shall not be exposed to dripping or splashing and no objects filled with liquids, such as vases, shall be placed on the apparatus.
To reduce the risk of fire or electric shock, do not expose this appliance to rain or moisture.



RADIO-TV INTERFERENCE

This equipment has been tested and found to comply with the limits for a Class B digital device, pursuant to Part 15 of the FCC Rules. These limits are designed to provide reasonable protection against harmful interference in a residential installation. This equipment generates, uses, and can radiate radio frequency energy and, if not installed and used in accordance with the instructions, may cause harmful interference to radio communications. However, there is no guarantee that interference will not occur in a particular installation. If this equipment does cause harmful interference to radio or television reception, which can be determined by turning the equipment off and on, the user is encouraged to try to correct the interference by one or more of the following measures:

- 1) Reorient or relocate the receiving antenna.
- 2) Increase the separation between the equipment and receiver.
- 3) Connect the equipment into an outlet on a circuit different from that to which the receiver is connected.
- 4) Consult the dealer or an experienced radio/TV technician for help.

This Class B digital apparatus complies with Canadian ICES-003.

Cet appareil numérique de la classe B est conforme à la norme NMB-003 du Canada.

FCC WARNING- This equipment may generate or use radio frequency energy. Changes or modifications to this equipment may cause harmful interference unless the modifications are expressly approved in the instruction manual. The user could lose the authority to operate this equipment if an unauthorized change or modification is made.

The serial number of this product may be found on the back of this unit. No others have the same serial number as yours. You should record the number and other vital information here and retain this book as a permanent record of your purchase to aid identification in case of theft.

Date of Purchase		Dealer Phone No.	
Dealer		Model No.	
Dealer Address		Serial No.	

Thank you for purchasing this plasma display.

Please make sure to read this manual before using the plasma display and pay particular attention to the Safety Instructions enclosed within.

When you have finished reading this manual, store it in a safe place for easy access in the future.

When moving the plasma display _____

Due to the weight of this plasma display, two people should be used when moving it. Both people should make sure to grasp the top of the display with one hand and the base of the display with the other hand, as in the following illustration.

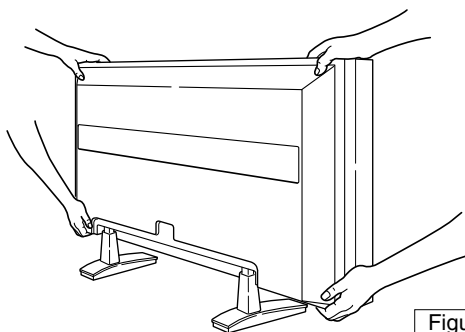

Figure 1

Regarding This Manual _____

- Product and company names appearing within this manual are trademarks or registered trademarks of their respective owners.
- Although special care has been taken to ensure that all information contained within this manual is correct at time of writing, the information is subject to change without notice.
- Make sure to read the manual carefully and follow all instructions contained within. We will not be held responsible for any damages caused by improper use or handling of this product.
- Reproducing this manual by any means, in whole or in part, is prohibited.

Optional Accessories _____

To mount the plasma display on a wall, the following accessory is available:

VISIONMOUNT™ Flat Panel TV Wall Mount from SANUS SYSTEMS, for large flat panel televisions (32" to 60"). Refer to page 21 for mounting the plasma display.

NOTE:

The wall mounts are not supplied with the plasma display.

⚠ CAUTION

- This PDP 6842PE is for use only with the Sanus Systems Model VMPL. Wall Mount. Use with other wall mounts is capable of resulting in instability, causing possible injury.
- When mounting the plasma display with the Sanus Systems wall mount, make sure to mount it on the wood studs inside the wall, as failure to do so may result in instability, causing possible injury.
- Refer to the instruction manual included with the wall mount for details when securing the plasma display to the wall.

CONTENTS

IMPORTANT SAFETY INSTRUCTIONS	2
SUPPLIED ACCESSORIES	5
INSERTING THE REMOTE CONTROL BATTERIES	5
REMOTE CONTROL RANGE	5
COMPONENT NAMES	6
MAIN UNIT	6
REMOTE CONTROL	7
OPERATING THE PLASMA DISPLAY	8
BASIC OPERATIONS	8
SELECTING THE INPUT SIGNAL	9
CHANGING THE ASPECT RATIO (SCREEN MODE)	10
STILL	11
SLEEP	11
NAVIGATING THE SET UP MENU	12
Layout of the Setup Menu	12
ENTERING THE MAIN MENU	13
PICTURE SELECT	13
Automatically Adjusting the Picture Settings	14
Manually Adjusting the Picture Settings	14
Initializing the Adjustments	14
WINDOW SETTING	15
SWITCHING THE DISPLAY LANGUAGE	15
SETTING THE SCREEN SAVER AND THE BACKGROUND COLOR	16
Setting the Screen Saver	16
Setting the Background Color	16
EXTERNAL INPUT TERMINALS	17
CONNECTING DEVICES TO THE AV INPUT TERMINALS	18
VIDEO Signal Connection (Basic Signal Transfer)	18
S-VIDEO Signal Connection (Better Signal Transfer)	18
CONNECTING DEVICES TO THE COMPONENT INPUT TERMINALS	19
Component 1 Signal (Y, Cb, Cr) Connection (Best Signal Transfer)	19
Component 2 Signal (Y, Pb, Pr) Connection (Best Signal Transfer)	19
CONNECTING PLASMA DISPLAY TO AUDIO SYSTEM	20
AUDIO Signal Connection	20
CONNECTING THE POWER CABLE	20
ATTACHING A WALL MOUNT BRACKET (SOLD SEPARATELY)	21
MAINTENANCE	22
CLEANING THE PLASMA DISPLAY	22
WARNING	22
TROUBLESHOOTING GUIDE	23
SPECIFICATIONS	25
REFERENCIA RÁPIDA EN ESPAÑOL	26
INSTALACIÓN DE LAS PILAS EN EL CONTROL REMOTO	26
NOMBRES DE LOS COMPONENTES	27
UNIDAD PRINCIPAL	27
CONTROL REMOTO	27

SUPPLIED ACCESSORIES

This product comes with the following accessories:
Please confirm that they are included.

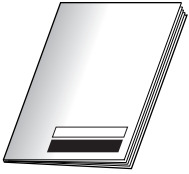

Owner's Manual
(1EMN20088)



Remote Control
(NE801UD)

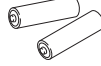

AA batteries x 2

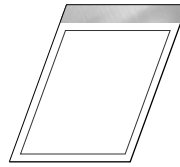

Set Up Guide
(1EMN20118)



Power cable
(WBC0202H0001)

NOTE:

If any of these accessories are missing, please contact your dealer.

INSERTING THE REMOTE CONTROL BATTERIES

- 1** Remove the back cover of the remote control while pressing the tab on the back cover down with your finger.

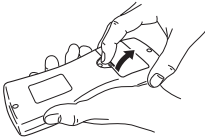

- 2** Insert two AA size batteries, making sure that the polarities of the batteries match the symbols inside the remote control.

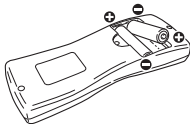

- 3** Replace the back cover of the remote control.

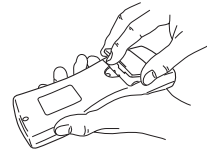

NOTE:

- Do not insert a mix of old and new batteries.
- Do not insert a mix of different brands of batteries or different types of batteries.
- Always use new, fresh batteries as replacement.
- Never attempt to charge, heat, burn or take apart batteries.

REMOTE CONTROL RANGE

Operate the remote control within a 30 degree angle on both sides of the infrared sensor on the main unit. You can operate the remote control from a distance of several yards away from the main unit.

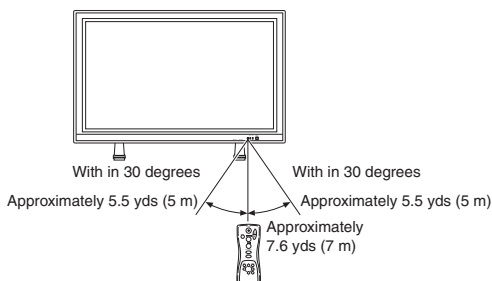

NOTE:

Other devices which use infrared beams, sunlight, fluorescent lights, etc., may affect the range and effectiveness of the remote control. Make sure the plasma display is positioned in a place which minimizes interference from them.

COMPONENT NAMES

MAIN UNIT

Front

Figure 2

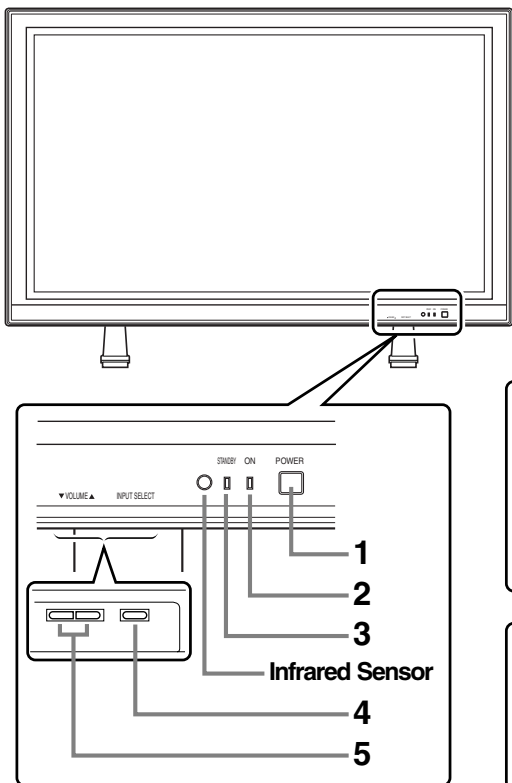

Rear

Figure 3

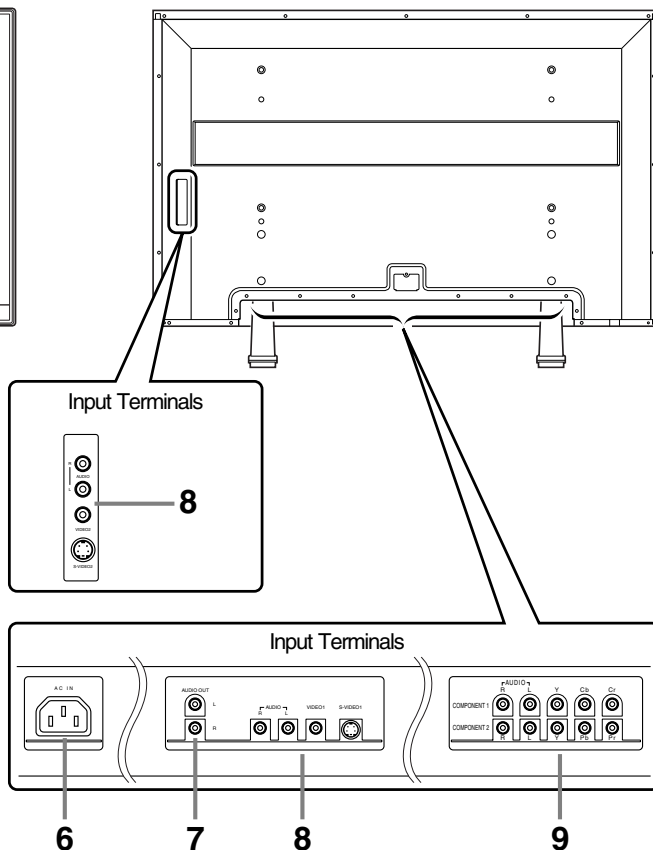

- 1 POWER button:** Turns the power ON or in STANDBY.
- 2 ON indicator:** Lights up when the power is ON.
- 3 STANDBY indicator:** Lights up when the power is in the standby mode. Disappears when the power is ON.
- 4 INPUT SELECT button:** Selects input terminals.
- 5 VOLUME ▲(up) / ▼(down) button:** Increases or decreases the volume.
- 6 AC IN terminal:** Connect the supplied power cable for a standard AC outlet.
- 7 AUDIO OUT:** Output terminals for audio.

- 8 AUDIO/VIDEO/S-VIDEO:** Input terminals for an audio and video signal. You can select either VIDEO or S-VIDEO.
- 9 COMPONENT:** Input terminals for a component signal. You can make a Y-Cb-Cr interlaced connection to component 1 or Y-Pb-Pr progressive or interlaced connection to component 2.

REMOTE CONTROL

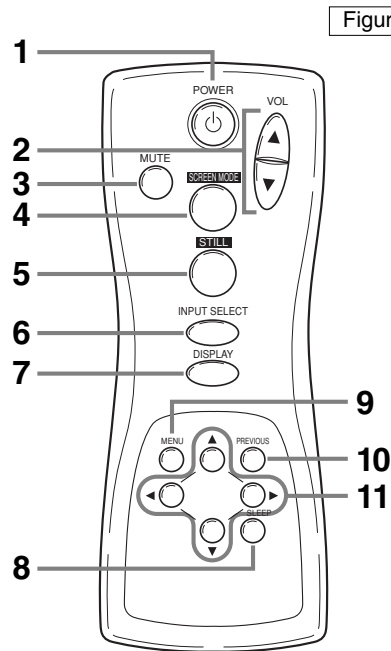

1 POWER button: Turns the main power ON or in STANDBY.

2 VOL ▲(up) / ▼(down) button: Increases or decreases the volume.

3 MUTE button: Turns the audio off or on.

4 SCREEN MODE button: Selects aspect ratios available for the screen.

5 STILL button: Pauses the image shown on the screen.

6 INPUT SELECT button: Selects input terminals.

7 DISPLAY button: Displays the name of the selected input terminal on the screen.

8 SLEEP button: Sets the sleep timer.

9 MENU button: Accesses the setup menu, allowing you to access various settings.

10 PREVIOUS button: Moves up one level in the setup menu.

11 ▲(up) / ▼(down) button: Selects the various modes in the setup menu.

◀(left) / ▶(right) button: Selects and adjusts levels for the various settings.

▶(enter) button: Also used as the enter button.

OPERATING THE PLASMA DISPLAY

BASIC OPERATIONS

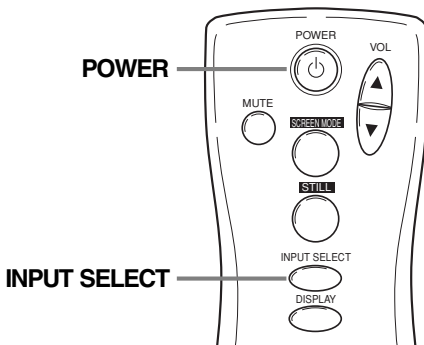

The following is a simple explanation of the procedure for turning the power of the display ON or in STANDBY, and the procedure for selecting the input signal.

The procedure described here is for the remote control, however the **POWER**, **INPUT SELECT** and **VOLUME** buttons on the plasma display can also be used in the same way.

1 Press the **POWER** button.

Confirm that the STANDBY indicator is lit before pressing the **POWER** button. The power turns ON and the ON indicator on the main unit lights up. The STANDBY indicator on the main unit disappears.

NOTE:

- It takes approximately 8 seconds for the screen to display after turning the power ON, but this is not a malfunction.

2 Select the input signal by pressing the **INPUT SELECT** button.

Each time you switch the input, the name of the selected input terminal is displayed on the screen for approximately 4 seconds.

NOTE:

- "No signal" is displayed on the screen if there is no input from the selected terminal and there is no message currently displayed on the screen for volume adjustment or the setup menu, etc.
- If there is no video signal and there has been no operation from the remote control or the buttons on the main unit for more than 15 minutes, the auto shut-off function activates and the display switches to standby mode.

3 Adjust the volume and screen size according to your requirements.

Perform adjustments to the volume (**VOL ▲ / ▼** button), screen aspect ratio (**SCREEN MODE** button), and picture settings (**MENU** button)

NOTE:

- When you adjust the volume with the **VOL ▲ / ▼** button, a message such as the following is displayed on the screen. This message disappears approximately 4 seconds after performing adjustments.



- If you turn the audio mute on, a message slowly flashes on the screen. At this time, if you press another button, this flashing stops.



- To turn the audio mute off, either press the **MUTE** button again or press the **VOL ▲ / ▼** button.
- If you press either the **PREVIOUS**, **▲**, **▼**, **▶** or **◀** button in a mode apart from the image adjustment mode. A message such as the following is displayed.

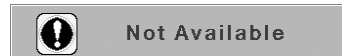

4 Press the **POWER** button to turn the power STANDBY.

The ON indicator on the main unit disappears and the STANDBY indicator lights up.

NOTE:

- You cannot turn the power ON for approximately 3 seconds after the power enters the standby mode. Do not turn the power STANDBY and then ON again in a short time interval.
- Even if the power is turned STANDBY, the main unit is in the standby mode. In order to shut the main power of the display OFF, it is necessary to remove the AC cord from the power outlet.

SELECTING THE INPUT SIGNAL

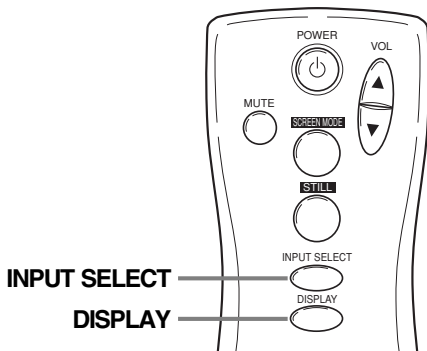

The procedure for selecting the input signal described here is for use with the remote control. However, the **INPUT SELECT** button on the plasma display can also be used in the same way.

Displaying the Current Input Signal

- 1 Press the **DISPLAY** button.

The name of the current input terminal is displayed on the screen.

Video 1

- 2 To clear the name of the current input terminal, press the **DISPLAY** button again or wait for approximately 4 seconds.

NOTE:

- To redisplay the name of the input terminal, press the **DISPLAY** button again.

Selecting the Input Signal

- 1 Press the **INPUT SELECT** button to select the input signal.

Each time you switch the input signal, the name of the selected input terminal is displayed on the display for approximately 4 seconds.

The **INPUT SELECT** button cycles through the input terminals in the following pattern:

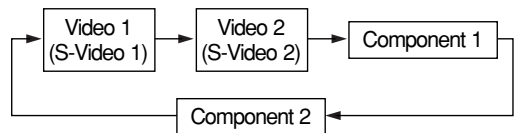

NOTE:

- When switching the input signal, audio mute turns ON temporarily.
- S-VIDEO1 takes preference over the VIDEO 1 jack, as does S-VIDEO 2 over the VIDEO 2 jack. Therefore, if there is input to the VIDEO and S-VIDEO terminals at the same time, the S-VIDEO signal is displayed on the screen. If the S-VIDEO cable is not connected to the plasma display, the VIDEO signal will be displayed on the screen.
- 480i (interlaced) signals can be connected to the COMPONENT 1 and 2 terminals. Any of the following display formats: 480i, 480p (progressive), 1080i and 720p (progressive) signals can be connected to the COMPONENT 2 terminal. If one of these video signals is detected, the format of the current input signal is displayed after the name of the current input terminal, as in the following manner.

Component 2
480i

- A "No signal" message appears if there is no video signal and there is no message currently displayed on the screen for volume adjustment or the setup menu, etc. If there continues to be no video signal for more than 10 seconds, "No signal" slowly moves around the screen.
- If there is no video signal and there has been no operation from the remote control or the buttons on the main unit for more than 15 minutes, the auto shut-off function activates and the display switches to standby mode.

OPERATING THE PLASMA DISPLAY

CHANGING THE ASPECT RATIO (SCREEN MODE)

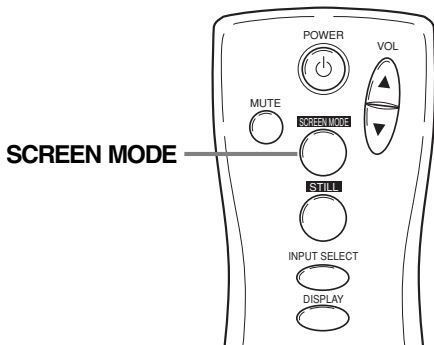

By changing the aspect ratio of the screen you can select the manner in which you wish to view the picture.

- 1** Press the **SCREEN MODE** button to display the current screen mode.
- 2** Press the **SCREEN MODE** button a second time to change the screen mode.

Each time you change the screen mode, the name of the selected mode is displayed on the screen for approximately 4 seconds. The **SCREEN MODE** button switches between the screen modes in the following pattern.

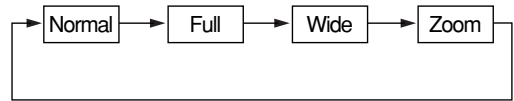

NOTE:

- When switching the input signal, the audio mute turns ON temporarily.
- You can only select the "Normal" and "Zoom" screen modes for 1080i and 720p video signals connected to the COMPONENT 2 terminal.

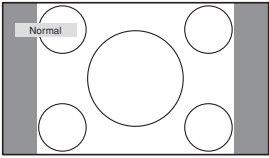
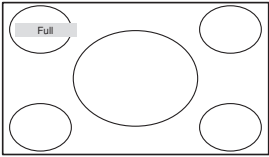
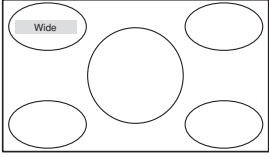
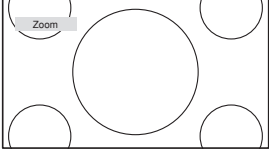
Mode	Picture	Explanation
Normal		Normal will display a 4:3 picture at its standard 4:3 size. For 1080i and 720p video signals, a picture will be displayed at 16:9 size.
Full		Full will display a 4:3 picture at a 16:9 size, with horizontal elongation necessary to fill the screen.
Wide		Wide will display a 4:3 picture at a 16:9 size, with less horizontal elongation necessary to fill the screen because a little bit of the top and bottom will be cut off.
Zoom		Zoom will magnify the entire 4:3 picture to fill the screen, with no horizontal elongation to fill the screen, as more of the top and bottom are cut off. Use this mode to view letterboxed 4:3 picture content to get a widescreen picture. A 16:9 picture will be magnified similarly, but to a lesser extent.

STILL

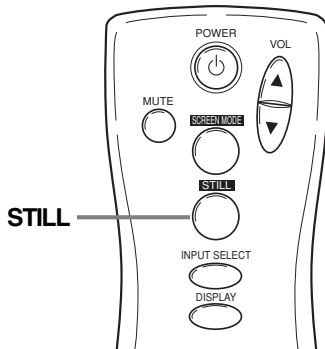

You can freeze the image displayed on the screen.

1 Press the **STILL** button.

The still mode turns on, and the image displayed on the screen is frozen.

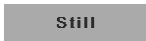

NOTE:

- When the still mode is on, the message "Still" slowly flashes on the screen.
- When the still mode is on, the audio is muted.
- You cannot turn the still mode on when there is no video signal or when switching between video signals.

2 Press the **STILL** button again to turn the still mode off.

NOTE:

- You can also press the **INPUT SELECT**, **DISPLAY**, **SLEEP**, **VOL ▲(up) / ▼(down)**, **MUTE**, **SCREEN MODE** or **MENU** buttons to turn the still mode off.

SLEEP

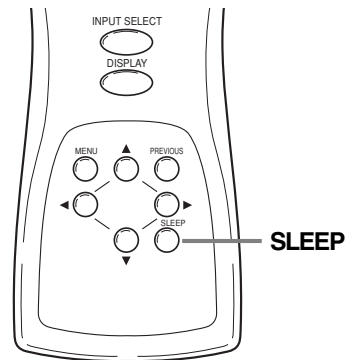

You can select the sleep timer.

1 Press the **SLEEP** button.

The sleep timer is displayed on the screen.



NOTE:

- If the sleep timer is activated, the remaining time is displayed on the screen.
- If not activated, "0 minutes" is displayed.

2 Press the **SLEEP** button to set the time.

The **SLEEP** button switches between the times.

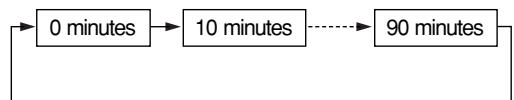

The timer starts counting down after the message displaying the set time disappears (after approximately 4 seconds).

NOTE:

- The remaining time displayed for the sleep timer changes in steps of 1 minute.
- To change the set time, repeat the above procedure.

OPERATING THE PLASMA DISPLAY

NAVIGATING THE SET UP MENU

In the setup menu, you can specify settings for picture adjustment, picture position, language, screen saver and background.

NOTE:

- If you do not press any buttons for approximately 20 seconds, the display automatically exits the menu mode.
- We recommend to set to the initialized setting of "Manual" in the picture mode.

Layout of the Setup Menu

The various functions in the setup menu are outlined below:

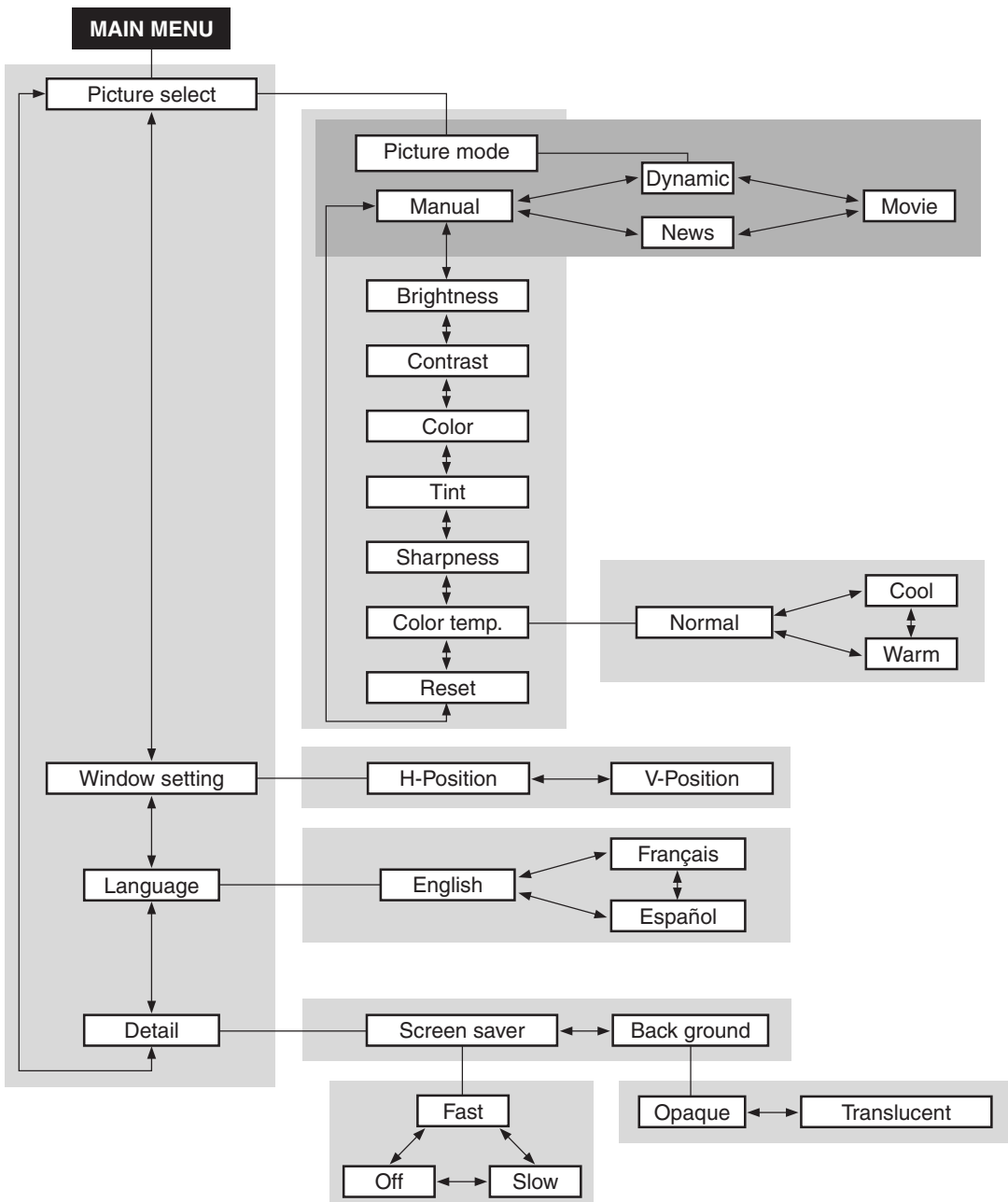

ENTERING THE MAIN MENU

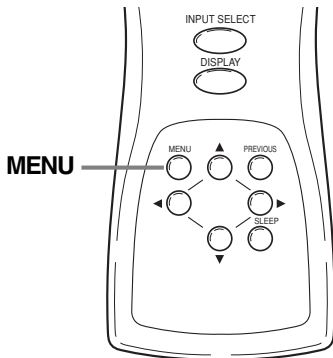

1 Press the **MENU** button.

The display enters the main menu and the MAIN MENU is displayed on the screen.

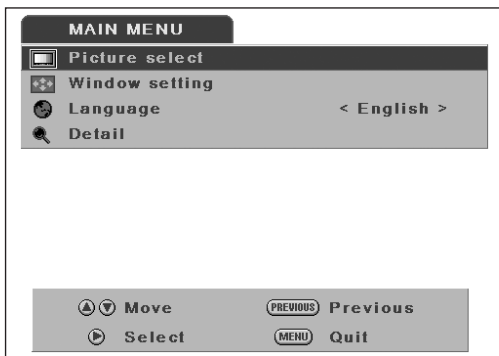

NOTE:

- If you press the **PREVIOUS** button or the **MENU** button on the MAIN MENU, the menu is cancelled.
- For procedures which use the **ENTER** button, use the **▶** button as the **ENTER** button.

PICTURE SELECT

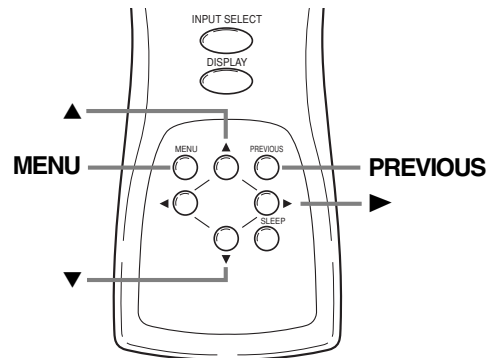

1 Enter the main menu with the **MENU** button.

“Picture select” is selected on the MAIN MENU.

2 Press the **▶ (ENTER)** button.

The PICTURE SELECT menu is displayed on the screen.

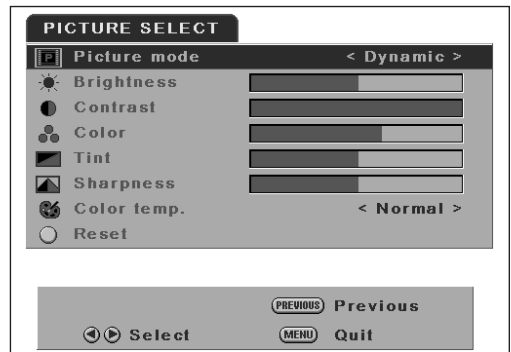

NOTE:

- Press the **PREVIOUS** button to return to the MAIN MENU. Pressing the **MENU** button cancels the menu.
- Picture select display will disappear from the TV screen automatically after about 20 seconds if you do not press any buttons.

OPERATING THE PLASMA DISPLAY

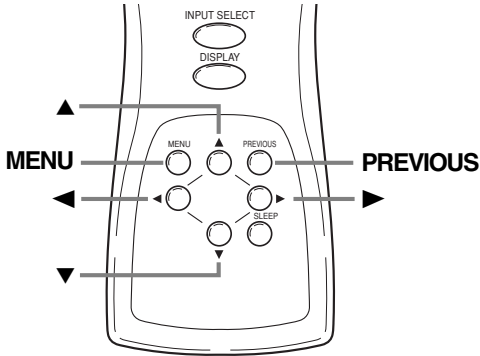

Automatically Adjusting the Picture Settings

- 1 Select "Picture mode" on the PICTURE SELECT screen with the ▲ / ▼ buttons.
- 2 Select the automatic adjustment mode according to the type of picture displayed on the screen with the ◀ / ▶ buttons.

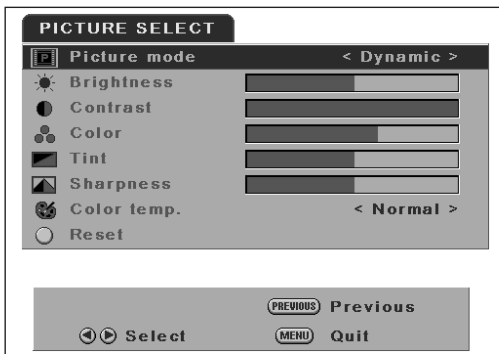

NOTE:

- There are 3 modes for automatically adjusting the picture settings; "News", "Movie" and "Dynamic".
- MANUAL refers to manual picture settings adjustment.

- 3 Press the **PREVIOUS** button to return to the MAIN MENU.

NOTE:

- Pressing the **MENU** button cancels the menu.

Manually Adjusting the Picture Settings

- 1 Select "Picture mode" on the PICTURE SELECT screen with the ▲ / ▼ buttons.
- 2 Select "Manual" with the ◀ / ▶ buttons.
The display enters the manual mode, and you can specify individual adjustments.
- 3 Select the mode to adjust with the ▲ / ▼ buttons.
The modes rotate in the following order: "Picture mode" - "Brightness" - "Contrast" - ... - "Reset" - "Picture mode"
- 4 Adjust the selected mode using the ◀ / ▶ buttons.

NOTE:

- If you have selected Brightness, Contrast, Color, Tint, or Sharpness, the menu display disappears, and a bar for adjusting the selected mode appears in the center of the bottom of the screen.
- You can select "Color temp." from among three modes: "Normal", "Warm" and "Cool".
- If you select "Reset" and press the ► (**ENTER**) button, the adjusted values return to their initial settings.

- 5 To adjust a different mode, repeat steps 3 and 4.
- 6 Press the **PREVIOUS** button to return to the Picture mode.

NOTE:

- Pressing the **MENU** button cancels the menu.

Initializing the Adjustments

- 1 Select "Reset" on the PICTURE SELECT screen with the ▲ / ▼ buttons.
- 2 Press the ► (**ENTER**) button.
The settings you specified individually are initialized.

NOTE:

- The initialized setting of "Manual" are as follows:

BRIGHTNESS:	50/100
CONTRAST:	70/100
COLOR:	50/100
TINT:	50/100
SHARPNESS:	1/2
COLOR TEMP.:	Normal

WINDOW SETTING

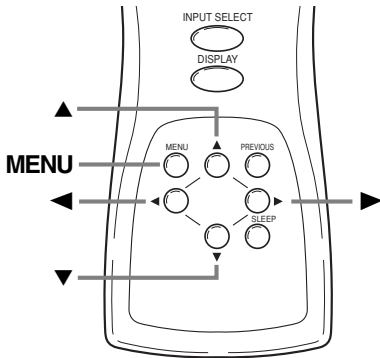

You can move the picture displayed on the screen up, down, left or right.

1 Enter the main menu with the **MENU** button.

2 Select "Window setting" on the MAIN MENU screen with the ▲ / ▼ buttons.

If there is no input from a video signal, "Window setting" is grayed out and you cannot select it.

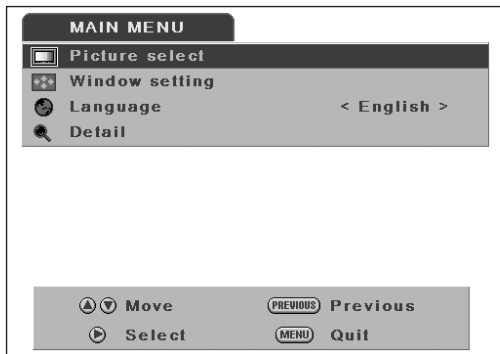

3 Press the ► (**ENTER**) button.

The "WINDOW SETTING" menu is displayed on the screen.

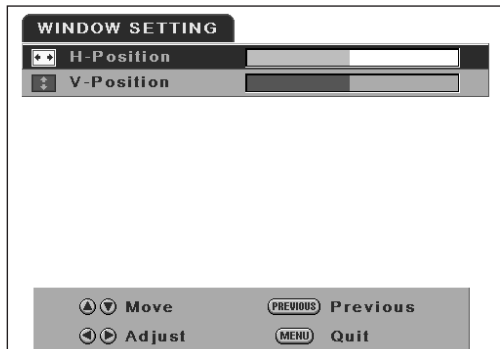

4 Select the mode to adjust with the ▲ / ▼ button.

Select "H-Position" to move the picture horizontally (left or right) and select "V-Position" to move the screen vertically (up or down).

5 Adjust with the ◀ / ▶ buttons.

The ◀ / ▶ buttons are also used for moving the picture vertically.

6 Press the **PREVIOUS** button to return to the MAIN MENU.

NOTE:

- Pressing the **MENU** button cancels the menu.

SWITCHING THE DISPLAY LANGUAGE

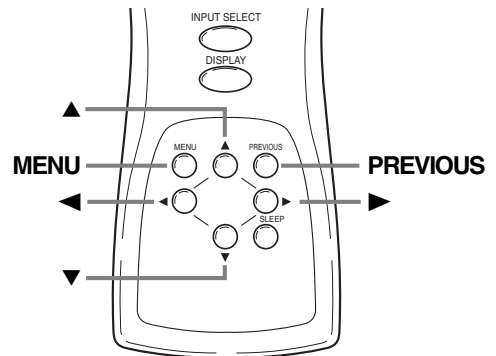

You can select the language displayed on the screen from English, French and Spanish.

1 Enter the main menu with the **MENU** button.

2 Select "Language" on the MAIN MENU screen with the ▲ / ▼ buttons.

3 Select the language with the ◀ / ▶ buttons.

4 Press the **PREVIOUS** button to return to the MAIN MENU.

NOTE:

- Pressing the **MENU** button cancels the menu.

SETTING THE SCREEN SAVER AND THE BACKGROUND COLOR

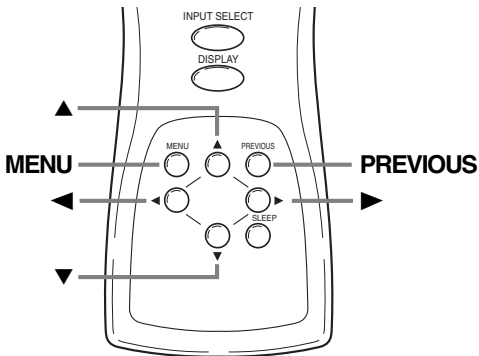

You can specify settings for the screen saver and the background color.

1 Enter the main menu with the **MENU** button.

2 Select "Detail" on the MAIN MENU screen with the ▲ / ▼ buttons.

3 Press the ► (**ENTER**) button.

The "DETAIL" menu is displayed on the screen.

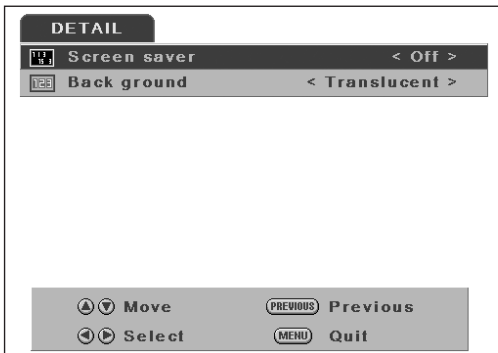

NOTE:

- Press the **PREVIOUS** button to return to the MAIN MENU. Pressing the **MENU** button cancels the menu.

Setting the Screen Saver

1 Select "Screen saver" on the DETAIL screen with the ▲ / ▼ buttons.

2 Select the mode with the ◀ / ▶ buttons.

NOTE:

- There are 3 modes for the screen saver; "Off", "Slow", and "Fast". "Slow" moves 1 pixel every 30 minutes and "Fast" moves 1 pixel every 10 minutes. This prevents images burning into the screen.
- When a 480i or 1080i input signal connected to the COMPONENT 2 terminal is displayed, the vertical movement is different. "Slow" moves 2 pixels every 60 minutes and "Fast" moves 2 pixels every 20 minutes.

3 Press the **PREVIOUS** button to return to the MAIN MENU screen.

NOTE:

- Pressing the **MENU** button cancels the menu.

Setting the Background Color

1 Select "Background" on the DETAIL screen with the ▲ / ▼ buttons.

2 Select the mode with the ◀ / ▶ buttons.
Select "Opaque" or "Translucent" for the background color.

3 Press the **PREVIOUS** button to return to the MAIN MENU screen.

NOTE:

- Pressing the **MENU** button cancels the menu.

EXTERNAL INPUT TERMINALS

The following input terminals are available.

In order to view television, it is necessary to connect a tuner device (example: cable box, satellite box, DTV, etc.) to the plasma display.

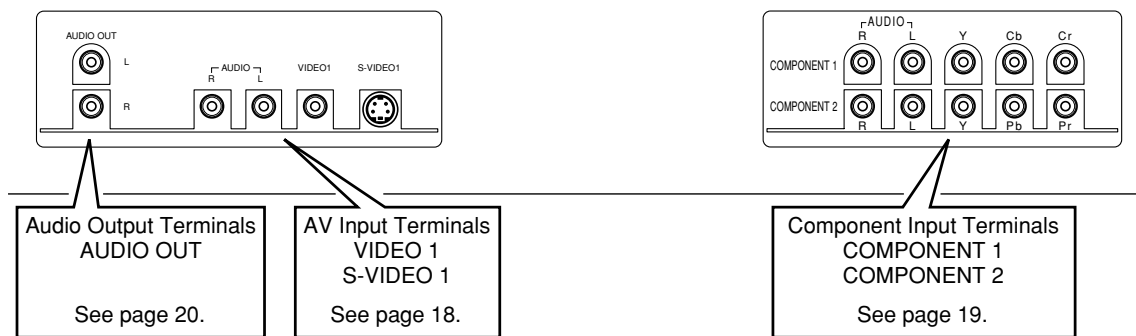
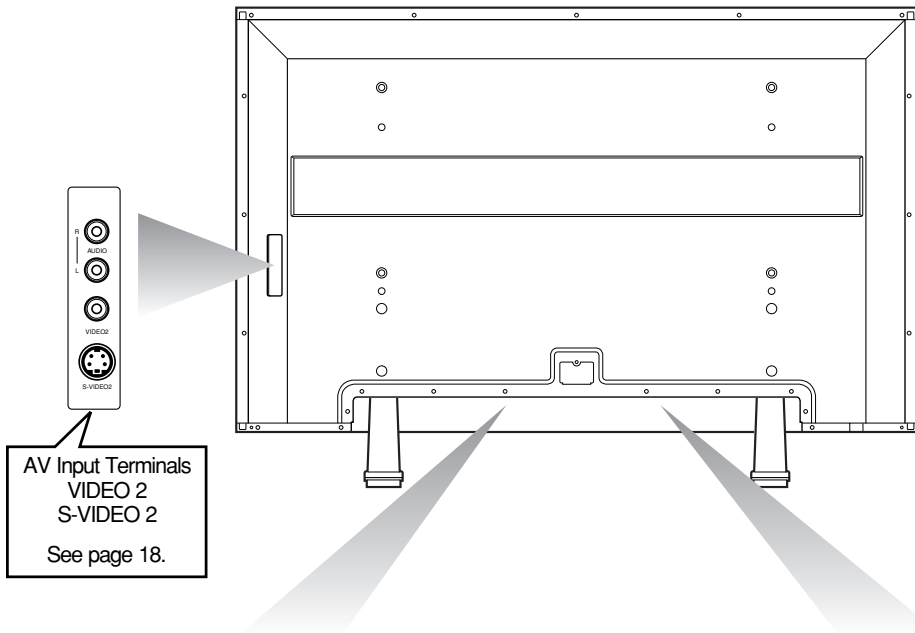

EXTERNAL INPUT TERMINALS

CONNECTING DEVICES TO THE AV INPUT TERMINALS

Connect the output of the device to the input terminals of plasma display as shown in the following illustrations.

NOTE:

- You will select TV channels with the VCRs or Cable/Satellite set top box that will be viewed on the plasma display.
- Cables shown here are not included with the plasma display.

VIDEO Signal Connection (Basic Signal Transfer)

Example of input signal source

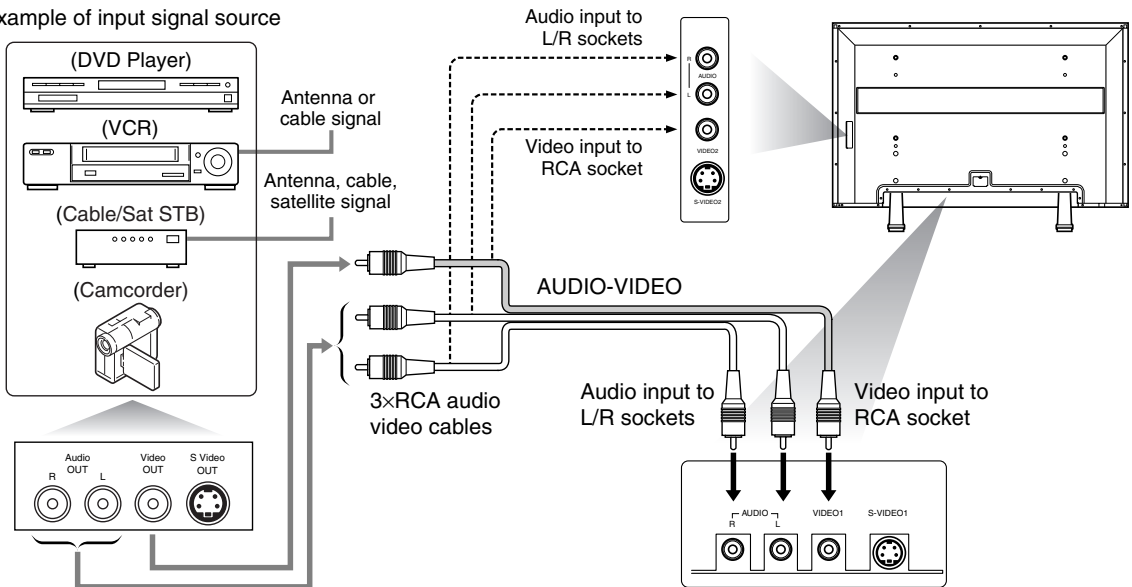

S-VIDEO Signal Connection (Better Signal Transfer)

Example of input signal source

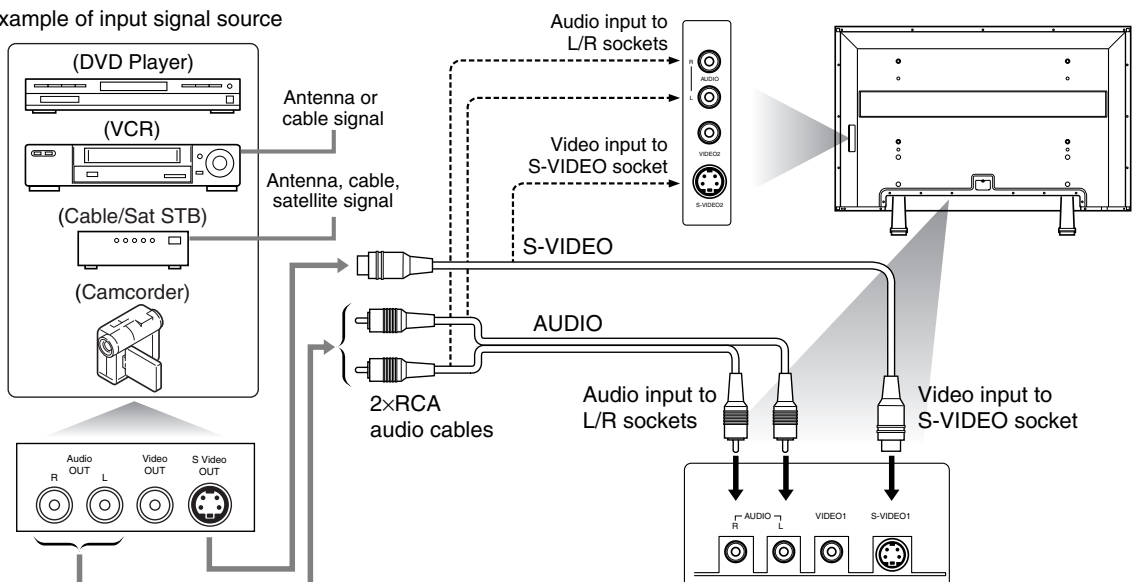

CONNECTING DEVICES TO THE COMPONENT INPUT TERMINALS

Connect the output of the device to the input terminals of the plasma display as shown in the following illustrations.

NOTE:

- When connecting a 480i input signal, connect it to COMPONENT 1.
- Cables shown here are not included with the plasma display.
- You can use COMPONENT 2 for 480i, 1080i (interlaced), 480p, 720p (progressive) video signals.

Component 1 Signal (Y, Cb, Cr) Connection (Best Signal Transfer)

480i (interlaced) signals can be connected to Component 1.

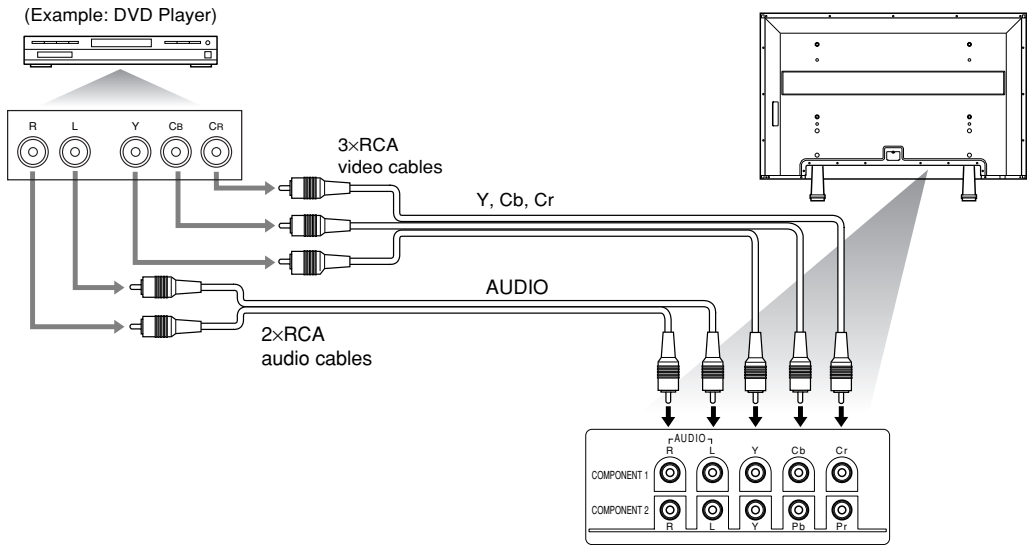

Component 2 Signal (Y, Pb, Pr) Connection (Best Signal Transfer)

480i, 480p (progressive), 1080i and 720p (progressive) signals can be connected to Component 2.

NOTE:

You will select TV channels with the box that will be seen on the plasma display.

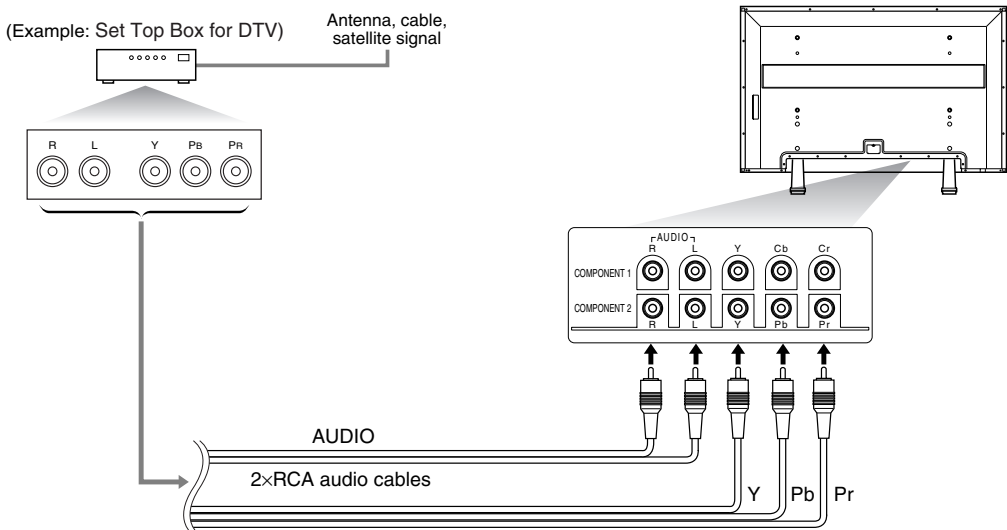

EXTERNAL INPUT TERMINALS

CONNECTING PLASMA DISPLAY TO AUDIO SYSTEM

NOTE:

Cables shown here are not included with the plasma display.

AUDIO Signal Connection

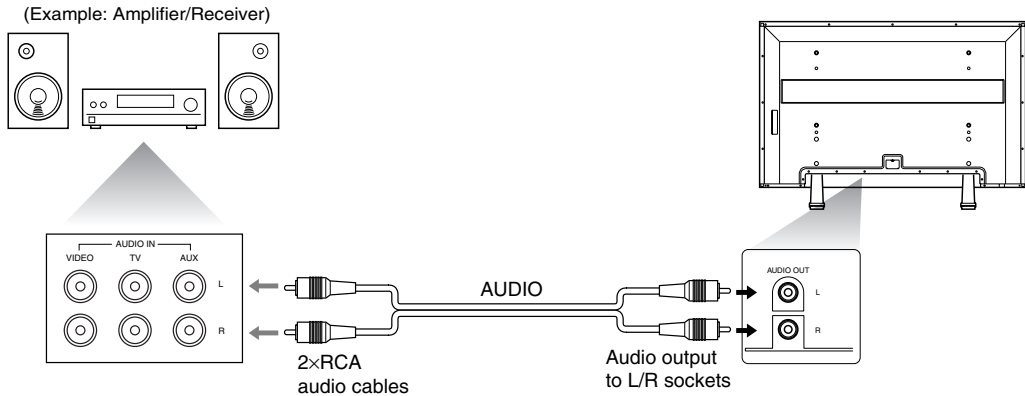

CONNECTING THE POWER CABLE

Connect the power cable to the plasma display after connecting the input terminals.

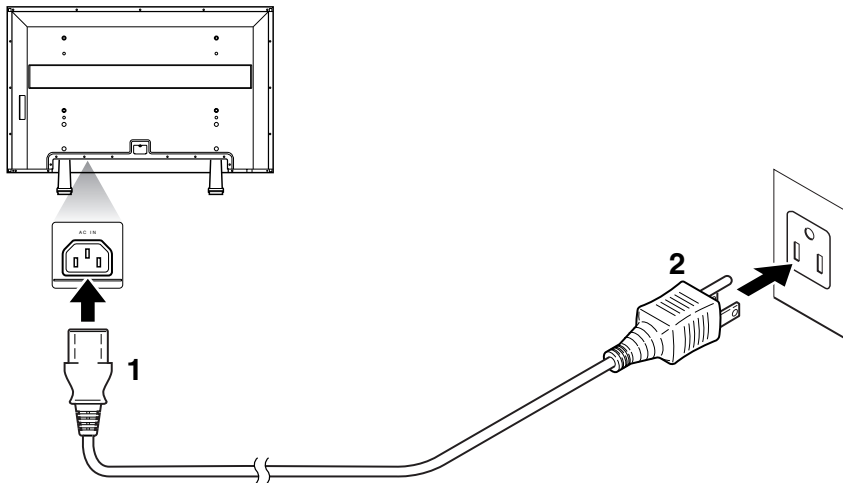

1 Connect the power cable to the plasma display first.

2 Connect the power cable to an AC outlet.

⚠ CAUTION

- Do not connect the power cable to a power supply outside the indicated voltage of the plasma display (AC 120V). Connecting the power cable to a power supply outside of this range may result in fire or electrical shocks.
- Always use the power cable included with the plasma display. Do not use any other cable. For safety, make sure to always connect the power cable to a three pronged AC outlet.

ATTACHING A WALL MOUNT BRACKET (SOLD SEPARATELY)

The following is a description of the method for attaching a wall mount to the plasma display. When performing this operation, refer to the instruction manual included with the wall mount kit.

⚠ CAUTION

- Any damage caused by incorrectly attempting to mount the plasma display is not covered under the terms of the manufacturers warranty.

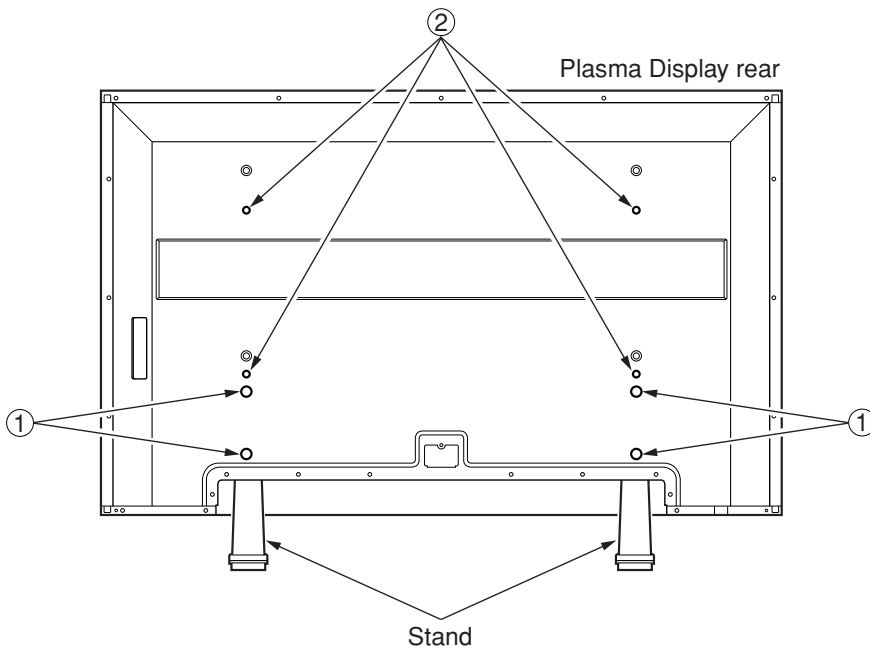

- 1** Turn the plasma display over and place it screen-first onto a table which has a soft cloth draped over it.

Place the plasma display in a way so that the stands hang over the edge of the table.

NOTE:

- Make sure to use a table which can support the weight of the plasma display and is larger than the plasma display.
- Make sure the table is in a stable location.

- 2** Remove the stands from the plasma display. Unscrew the M5 screws indicated by ①, and remove the left and right stands.

NOTE:

- The screws and stands you have removed are necessary for reattachment at a later date. Make sure to keep them in a safe place.

- 3** Attach the left and right TV rails to the plasma display using the M8 screws included with the wall mount kit.

② indicates the position of the screw holes on the plasma display

NOTE:

- Only use the screw holes indicated by ② for mounting the plasma display.
- For instructions on how to attach the TV rails, refer to the instruction manual included with the mount wall kit.

- 4** Attach the plasma display to the wall.

NOTE:

- Refer to the instruction manual included with the wall mount when securing the plasma display to the wall.

MAINTENANCE

CLEANING THE PLASMA DISPLAY

Always unplug the plasma display from the AC outlet before cleaning.

Clean the case of the plasma display with a soft cloth which has been wet and wrung dry.

If the screen of the plasma display is dirty or dusty, wipe it clean with a soft cloth.

NOTE:

Never use a solvent, alcohol or any other abrasive liquid to clean the plasma display.

Always make sure the area around vents on the plasma display is clear and clean. Failure to do this may result in fire or cause the plasma display to fail prematurely.





WARNING

Preventing Image Burn on the plasma display

Fixed images displayed on the plasma display for an extended period of several hours may cause uneven pixel aging causing damage to the plasma display. The screensaver mode helps reduce this phenomenon, but in general you should try avoid displaying fixed images for extended periods on the plasma display.

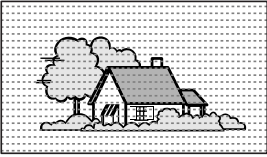
Images of high luminance displayed on the plasma display for more than 60 seconds may cause lingering images to remain on the screen. These images will automatically disappear, but may take time depending on the luminance of the images and how long they were displayed on the screen.

TROUBLESHOOTING GUIDE

	<p>•IGNITION NOISE: Black spots or horizontal streaks may appear, picture may flutter or drift. Usually caused by interference from automobile ignition systems, neon lamps, electrical drills and other electrical appliances.</p>
	<p>•GHOSTS: Ghosts are caused by the television signal following two paths. One is the direct path and the other is reflected from tall buildings, hills or some other objects. Changing the direction or position of the antenna may improve reception. Ghosting may also be caused by defects in the antenna system such as unshielded leads or connecting several sets to the same antenna without using multiple antenna couplers. Ghosting occurring when the plasma display is connected to a cable TV system may indicate a bad cable wire or loose connection. Confirm that the cable wire is properly connected.</p>
	<p>•SNOW: If your receiver is located in the fringe area of a television station where the signal is weak, your picture may be marred by the appearance of small dots. When the signal is extremely weak, it may be necessary to install a special antenna to improve the picture. Snowing occurring when the plasma display is connected to a cable TV system may indicate a bad cable wire or loose connection. Confirm that the cable wire is properly connected.</p>
	<p>•RADIO FREQUENCY INTERFERENCE: The interference produces moving ripples or diagonal streaks, and in some cases, causes loss of contrast in the picture.</p> <p>•PREVENTION OF AN OBSTACLE TO RADIO RECEIVERS This monitor has been designed pursuant to the FCC class B Rules. This is to prevent a problem to Radio receivers. If this monitor causes a problem to Radio receivers, then take the following steps:</p> <ul style="list-style-type: none"> - Keep the monitor away from Radio. - Adjust Radio antennas in order for the monitor not to receive interference. - The antenna cable of Radio should be kept away from the monitor. - Use a coaxial cable for antenna. <p>You can check if this monitor influences Radio receivers by turning off all other equipment other than the monitor. If you find a problem receiving Radio when using the monitor, check the instructions mentioned above.</p>
<p>Vertical stripes appear, depending on the screen contents.</p>	<p>•The plasma display panel is lighting the phosphors by the discharge of internal radiation. Depending on the screen contents, in rare cases this may cause vertical stripes to appear because of failure to light. Please note that this is not a malfunction.</p>

TROUBLESHOOTING GUIDE

CHECK THESE ITEMS AND TRY THESE CORRECTIONS	SYMPTOM										
	Remote control does not work	No picture, no sound	Sound OK, picture poor	Picture OK, sound poor	Picture blurred	Weak Picture	Lines or streaks in picture	Picture rolls vertically	No color	Poor picture	Irregular dots on the screen
Be sure external connections are correct.		X	X	X	X	X			X	X	
Be sure power cable is plugged in.	X	X									
Be sure PANEL is power switched "ON"	X										
Check for local interference			X	X	X		X	X			
Adjust Contrast control			X			X					
Adjust Bright control			X								
Adjust Color control									X	X	
Adjust Tint control										X	
Adjust Volume control				X							
Check batteries in Remote control	X										
It is a characteristic of a Plasma Display.											X

About Interference to Infrared Devices _____

Please note in advance that using other infrared devices (such as infrared cordless headphones) near the plasma display may cause infrared interference to occur.

About Pixel Defects _____

A plasma display is created by using a collection of miniature pixels. It is possible to display more than 99.99% of valid pixels, however a small fraction of pixels over the life of the product may not illuminate or may constantly be illuminated.

This is not to be considered a defect in the plasma panel.

SPECIFICATIONS

Display Features

Type	Plasma panel
Screen Size	42 in. Wide VGA panel
Pixel Resolution	852 (H) x 480 (V)
Output Colors	16.7 million
Screen Aspect Ratio	16:9
Viewing Angle	160 degrees
Contrast Ratio	1000:1
Brightness	470 cd/m ² (PEAK)
Comb Filter Type	3-Dimensional Y/C Separation
Available Input Format	720p/1080i/480p/480i (720p/1080i/480p: Component 2 only)

Audio Features

Sound Output	5W + 5W, 10% THD
Speaker	2.8 in x 1.6 in Oval Type x 2

Additional Features

Screen Saver	Off/Slow/Fast
Trilingual OSD	English/Spanish/French
Color Temperature Select	Cool/Normal/Warm
AV Memory	Dynamic/Manual/News/Movie
Widescreen Modes	4:3 Standard, Full, Wide, Zoom
Sleep Timer	90 minutes
Wall Mount Kit Ready	For VMPLs, SANUS SYSTEMS

Connectors

Component AV Input (1)	SD component video/Y, Cb, Cr (RCA x 3) - rear audio L/R (RCA x 2) - rear
Component AV Input (2)	HD component video/Y, Pb, Pr (RCA x 3) - rear audio L/R (RCA x 2) - rear
Composite AV Input (1) S-Video (1)	Composite video (RCA x 1) - rear S-Video (4 pin DIN) - rear audio L/R (RCA x 2) - rear
Composite AV Input (2) S-Video (2)	Composite video (RCA x 1) - side S-Video (4 pin DIN) - side audio L/R (RCA x 2) - side
Analog Audio output	audio L/R (RCA x 2) - rear

General

Power In	120V ±10%, 60Hz/AC
Power Consumption	350 W (Standby: 0.8W)
Exterior Color	Silver & Black
Dimension (Incl. stand) (Width x Height x Depth)	41 1/2 x 28 3/4 x 13 in. (1054 x 730 x 330 mm)
Weight	94.8 lbs (43 kg)

NOTE:

The specifications and design of this product are subject to change without notice.



As an ENERGY STAR® Partner, our company has determined that this product meets the ENERGY STAR® guidelines for energy efficiency. ENERGY STAR® is a U.S. registered mark.

REFERENCIA RÁPIDA EN ESPAÑOL

Traslado de la unidad principal

Debido al considerable peso de la pantalla de plasma, se necesitan dos personas para trasladarla. Ambas personas deben sujetar o sostener la parte superior de la pantalla con una mano y la base de la pantalla con la otra mano.

Vea la Figura 1 en la página 3.

INSTALACIÓN DE LAS PILAS EN EL CONTROL REMOTO

1 Para retirar la tapa trasera del control remoto, presione la lengüeta hacia abajo con un dedo.

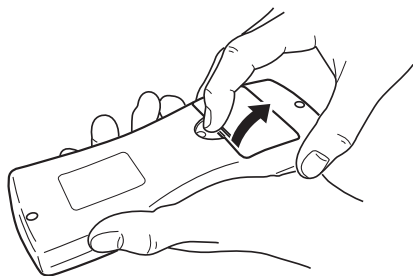

3 Instale la tapa trasera en el control remoto.

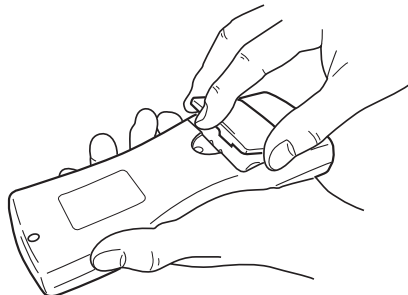

2 Instale dos pilas tamaño AA, asegurándose de que la polaridad de las pilas coincida con los símbolos impresos en el interior del control remoto.

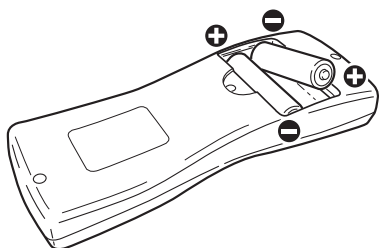

NOMBRES DE LOS COMPONENTES

UNIDAD PRINCIPAL

Vea las Figura 2 y Figura 3 en la página 6.

- 1 Botón POWER:** Para encender (ON) o dejar en modo de espera (STANDBY).
- 2 Indicador ON:** Se ilumina cuando la alimentación está encendida.
- 3 Indicador STANDBY:** Se ilumina cuando la pantalla se encuentra en modo de espera. Se apaga cuando se enciende la alimentación.
- 4 Botón INPUT SELECT:** Para seleccionar los terminales de entrada.
- 5 Botón VOLUME ▲(aumento) / ▼(disminución):** Para aumentar o disminuir el nivel de volumen.
- 6 Terminal AC IN:** Conecte el cable de alimentación suministrado entre este terminal y una toma de corriente de CA estándar.
- 7 AUDIO OUT:** Terminal de salida para audio.
- 8 AUDIO/VIDEO/S-VIDEO:** Terminal de entrada para señales de audio y video. Se puede seleccionar VIDEO o S-VIDEO.
- 9 COMPONENT:** Terminal de entrada para señales de componente. Es posible realizar una conexión entrelazada para componente 1 o Y-Pb-Pr progresivo o una conexión entrelazada para componente 2.

CONTROL REMOTO

Vea la Figura 4 en la página 7.

- 1 Botón POWER:** Para encender (ON) o dejar en modo de espera (STANDBY).
- 2 Botón VOL ▲(aumento) / ▼(disminución):** Para aumentar o disminuir el nivel de volumen.
- 3 Botón MUTE:** Para activar o desactivar la función de silenciamiento de audio.
- 4 Botón SCREEN MODE:** Se utiliza para seleccionar uno de los formatos disponibles para la pantalla.
- 5 Botón STILL:** Para congelar la imagen mostrada en la pantalla.
- 6 Botón INPUT SELECT:** Para seleccionar los terminales de entrada.
- 7 Botón DISPLAY:** Muestra el nombre del terminal de entrada seleccionado en la pantalla.
- 8 Botón SLEEP:** Para programar el temporizador de apagado automático.
- 9 Botón MENU:** Para acceder al menú de configuración, donde se pueden hacer diversos ajustes.
- 10 Botón PREVIOUS:** Para subir un nivel en el menú de configuración.
- 11 Botón ▲(arriba) / ▼(abajo):** Para seleccionar diversos modos en el menú de configuración.
Botón ◀(izquierda) / ▶(derecha): Para seleccionar y ajustar niveles para las diversas opciones de ajuste.
Botón ▶(introducción): También se utiliza como botón de introducción.

SYLVANIA LIMITED WARRANTY

FUNAI CORP. will repair this SYLVANIA product, free of charge in the USA in the event of defect in materials or workmanship as follows:

DURATION:

PARTS:

FUNAI CORP. will provide parts to replace defective parts without charge for one (1) year from the date of original retail purchase. Three (3) years for Plasma Panel. Certain parts and Plasma image burn-in are not covered under this warranty.

LABOR:

FUNAI CORP. will provide the labor without charge for a period of ninety (90) days from the date of original retail purchase.

LIMITS AND EXCLUSIONS:

THIS WARRANTY IS EXTENDED ONLY TO THE ORIGINAL RETAIL PURCHASER. A PURCHASE RECEIPT OR OTHER PROOF OF ORIGINAL RETAIL PURCHASE WILL BE REQUIRED TOGETHER WITH THE PRODUCT TO OBTAIN SERVICE UNDER THIS WARRANTY.

This warranty shall not be extended to any other person or transferee.

This warranty is void and of no effect if any serial numbers on the product are altered, replaced, defaced, missing or if service was attempted by an unauthorized service center. This SYLVANIA Limited warranty does not apply to any the product not purchased and used in the United States.

This warranty only covers failures due to defects in material or workmanship which occurs during normal use. It does not cover damage which occurs in shipment, or failures which are caused by repairs, alterations or product not supplied by FUNAI CORP., or damage which results from accident, misuse, abuse, mishandling, misapplication, alteration, faulty installation, improper maintenance, commercial use such as hotel, rental or office use of this product or damage which results from fire, flood, lightning or other acts of God.

THIS WARRANTY DOES NOT COVER PACKING MATERIALS, ANY ACCESSORIES (EXCEPT REMOTE CONTROL), ANY COSMETIC PARTS, COMPLETE ASSEMBLY PARTS, DEMO OR FLOOR MODELS.

FUNAI CORP. AND ITS REPRESENTATIVES OR AGENTS SHALL IN NO EVENT BE LIABLE FOR ANY GENERAL, INDIRECT OR CONSEQUENTIAL DAMAGES ARISING OUT OF OR OCCASIONED BY THE USE OF OR THE INABILITY TO USE THIS PRODUCT. THIS WARRANTY IS MADE IN LIEU OF ALL OTHER WARRANTIES, EXPRESS OR IMPLIED, AND OF ALL OTHER LIABILITIES ON THE PART OF FUNAI, ALL OTHER WARRANTIES INCLUDING THE WARRANTY OF MERCHANTABILITY AND FITNESS FOR A PARTICULAR PURPOSE, ARE HEREBY DISCLAIMED BY FUNAI AND ITS REPRESENTATIVES IN THE UNITED STATES.

ALL WARRANTY INSPECTIONS AND REPAIRS MUST BE PERFORMED BY A FUNAI AUTHORIZED SERVICE CENTER. THIS WARRANTY IS ONLY VALID WHEN THE UNIT IS CARRIED-IN TO A FUNAI AUTHORIZED SERVICE FACILITY.

THE PRODUCT MUST BE ACCOMPANIED BY A COPY OF THE ORIGINAL RETAIL PURCHASE RECEIPT. IF NO PROOF OF PURCHASE IS ATTACHED, THE WARRANTY WILL NOT BE HONORED AND REPAIRS COSTS WILL BE CHARGED.

IMPORTANT:

THIS LIMITED WARRANTY GIVES YOU SPECIFIC LEGAL RIGHTS. YOU MAY HAVE OTHER RIGHTS THAT VARY FROM STATE TO STATE. IF, AT ANY TIME DURING THE WARRANTY PERIOD, YOU ARE UNABLE TO OBTAIN SATISFACTION WITH THE REPAIR OF THIS PRODUCT, PLEASE CONTACT FUNAI CORP.

ATTENTION:

FUNAI CORP. RESERVES THE RIGHT TO MODIFY ANY DESIGN OF THIS PRODUCT WITHOUT PRIOR NOTICE.

To locate your nearest SYLVANIA Authorized Service Center or general service procedure, please call 1-800-605-8453 or write to the following:

FUNAI CORPORATION, INC.
SERVICE CENTER
1990 Van Ness Avenue, Torrance, CA 90501
Tel :1-800-605-8453
<http://www.funai-corp.com>

Head Office: 100 North Street, Teterboro, NJ 07608

PLEASE DO NOT SHIP YOUR UNIT TO THE TETERBORO ADDRESS.

Free Manuals Download Website

<http://myh66.com>

<http://usermanuals.us>

<http://www.somanuals.com>

<http://www.4manuals.cc>

<http://www.manual-lib.com>

<http://www.404manual.com>

<http://www.luxmanual.com>

<http://aubethermostatmanual.com>

Golf course search by state

<http://golfingnear.com>

Email search by domain

<http://emailbydomain.com>

Auto manuals search

<http://auto.somanuals.com>

TV manuals search

<http://tv.somanuals.com>