



26" Digital / Analog LCD TV

Owner's Manual

V07LCD26



**TO RECEIVE DIGITAL/ANALOG SIGNAL,
YOU MUST CONNECT ANTENNA.**

WARNING: TO REDUCE THE RISK OF FIRE OR ELECTRIC SHOCK, DO NOT EXPOSE THIS APPLIANCE TO RAIN OR MOISTURE.



CAUTION
RISK OF ELECTRIC SHOCK
DO NOT OPEN



CAUTION: TO REDUCE THE RISK OF ELECTRIC SHOCK, DO NOT REMOVE COVER (OR BACK). NO USER SERVICEABLE PARTS INSIDE. REFER SERVICING TO QUALIFIED SERVICE PERSONNEL.



THIS SYMBOL INDICATES THAT DANGEROUS VOLTAGE CONSTITUTING A RISK OF ELECTRIC SHOCK IS PRESENT WITHIN THIS UNIT.



THIS SYMBOL INDICATES THAT THERE ARE IMPORTANT OPERATING AND MAINTENANCE INSTRUCTIONS IN THE LITERATURE ACCOMPANYING THE APPLIANCE.

The important note is located on the rear of the cabinet.

Important Safeguards

- 1. READ INSTRUCTIONS** - All the safety and operating instructions should be read before the appliance is operated.
- 2. RETAIN INSTRUCTIONS** - The safety and operating instructions should be retained for future reference.
- 3. HEED WARNINGS** - All warnings on the appliance and in the operating instructions should be adhered to.
- 4. FOLLOW INSTRUCTIONS** - All operating and use instructions should be followed.
- 5. CLEANING** - Unplug TV from the wall outlet before cleaning. Do not use liquid cleaners or aerosol cleaners. Use a damp cloth for cleaning.
EXCEPTION: A product that is meant for uninterrupted service and, that for some specific reason, such as the possibility of the loss of an authorization code for a CATV converter, is not intended to be unplugged by the user for cleaning or any other purpose, may exclude the reference to unplugging the appliance in the cleaning description otherwise required in item 5.
- 6. ATTACHMENTS** - Do not use attachments not recommended by the TV manufacturer as they may cause hazards.
- 7. WATER AND MOISTURE** - Do not use this TV near water, for example, near a bath tub, wash bowl, kitchen sink, or laundry tub, in a wet basement, or near a swimming pool, and the like.
- 8. ACCESSORIES** - Do not place this TV on an unstable cart, stand, tripod, bracket, or table. The TV may fall, causing serious injury to someone, and serious damage to the appliance. Use only with a cart, stand, tripod, bracket, or table recommended by the manufacturer, or sold with the TV.
Any mounting of the appliance should follow the manufacturer's instructions and should use a mounting accessory recommended by the manufacturer. An appliance and cart combination should be moved with care. Quick stops, excessive force, and uneven surfaces may cause the appliance and cart combination to overturn.
AMEUBLES - Cet appareil ne doit être placé que sur un meuble (avec ou sans roulettes) recommandé par le fabricant. Si vous l'installez sur un meuble à roulettes, déplacez les deux ensembles avec précaution. Un arrêt brusque, l'utilisation d'une force excessive et des surfaces irrégulières risquent de déstabiliser l'ensemble et de le renverser.
- 9. VENTILATION** - Slots and openings in the cabinet and the back or bottom are provided for ventilation and to ensure reliable operation of the TV and to protect it from overheating, these openings must not be blocked or covered. The openings should never be blocked by placing the TV on a bed, sofa, rug, or other similar surface. This TV should never be placed near or over a radiator or heat register. This TV should not be placed in a built-in installation such as a bookcase or rack unless proper ventilation is provided or the manufacturer's instructions have been adhered to.
- 10. POWER SOURCES** - This TV should be operated only from the type of power source indicated on the marking label. If you are not sure of the type of power supply to your home, consult your appliance dealer or local power company. For TVs intended to operate from battery power, or other sources, refer to the operating instructions.



- 11. GROUNDING OR POLARIZATION** - This TV is equipped with a polarized alternating-current line plug (a plug having one blade wider than the other). This plug will fit into the power outlet only one way. This is a safety feature. If you are unable to insert the plug fully into the outlet, try reversing the plug. If the plug should still fail to fit, contact your electrician to replace your obsolete outlet. Do not defeat the safety purpose of the polarized plug.
- 12. POWER-CORD PROTECTION** - Power-supply cords should be routed so that they are not likely to be walked on or pinched by items placed upon or against them, paying particular attention to cords at plugs, convenience receptacles, and the point where they exit from the appliance.
- 13. OUTDOOR ANTENNA GROUNDING** - If an outside antenna or cable system is connected to the TV, be sure the antenna or cable system is grounded so as to provide some protection against voltage surges and built-up static charges. Article 810 of the National Electrical Code, ANSI/NFPA No. 70, provides information with respect to proper grounding of the mast and supporting structure, grounding of the lead-in wire to an antenna discharge unit, size of grounding conductors, location of antenna-discharge unit, connection to grounding electrodes, and requirements for the grounding electrode. (Fig. A)

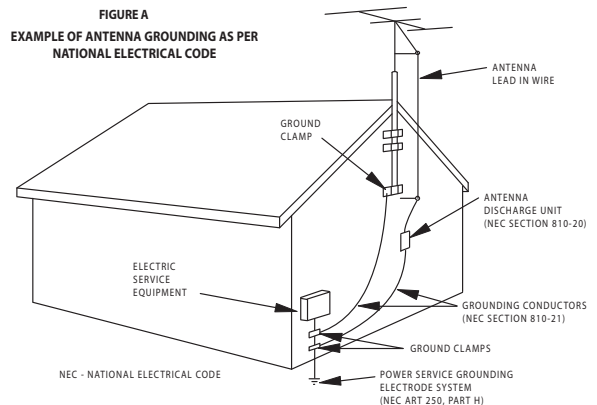

- 14. LIGHTNING** - For added protection for this TV receiver during a lightning storm, or when it is left unattended and unused for long periods of time, unplug it from the wall outlet and disconnect the antenna or cable system. This will prevent damage to the TV due to lightning and power-line surges.
- 15. POWER LINES** - An outside antenna system should not be located in the vicinity of overhead power lines or other electric light of power circuits, or where it can fall into such power lines or circuits. When installing an outside antenna system, extreme care should be taken to keep from touching such power lines or circuits as contact with them might be fatal.
- 16. OVERLOADING** - Do not overload wall outlets and extension cords as this can result in a risk of fire or electric shock.

- 17. OBJECT AND LIQUID ENTRY** - Never push objects of any kind into this TV through openings as they may touch dangerous voltage points or short out parts that could result in a fire or electric shock. Never spill liquid of any kind on the TV.
- 18. SERVICING** - Do not attempt to service this TV yourself as opening or removing covers may expose you to dangerous voltage or other hazards. Refer all servicing to qualified service personnel.
- 19. DAMAGE REQUIRING SERVICE** - Unplug this TV from the wall outlet and refer servicing to qualified service personnel under the following conditions:
- When the power supply cord or plug is damaged or frayed.
 - If liquid has been spilled, or objects have fallen into the TV.
 - If the TV has been exposed to rain or water.
 - If the TV does not operate normally by following the operating instructions. Adjust only those controls that are covered by the operating instructions, as improper adjustment of other controls may result in damage and will often require extensive work by a qualified technician to restore the TV to its normal operation.
- If the TV has been dropped or damaged in any way.
 - When the TV exhibits a distinct change in performance, this indicates a need for service.
- 20. REPLACEMENT PARTS** - When replacement parts are required, be sure the service technician uses replacement parts specified by the manufacturer that have the same characteristics as the original part. Unauthorized substitutions may result in fire, electric shock, injury to persons or other hazards.
- 21. SAFETY CHECK** - Upon completion of any service or repairs to this TV, ask the service technician to perform routine safety checks to determine that the TV is in proper operating condition.
- 22. HEAT** - This TV product should be situated away from heat sources such as radiators, heat registers, stoves, or other products (including amplifiers) that produce heat.

✓ Precautions

(Hg) LAMP IN LCD CONTAINS MERCURY, DISPOSE ACCORDING TO LOCAL, STATE OR FEDERAL LAW.

CAUTION: TO PREVENT ELECTRIC SHOCK, MATCH WIDE BLADE OF PLUG TO WIDE SLOT, FULLY INSERT.
ATTENTION: POUR ÉVITER LES CHOCS ÉLECTRIQUES, INTRODUIRE LA LAME LA PLUS LARGE DE LA FICHE DANS LA BORNE CORRESPONDANTE DE LA PRISE ET POUSSER JUSQU'AU FOND.

FCC WARNING This equipment may generate or use radio frequency energy. Changes or modifications to this equipment may cause harmful interference unless the modifications are expressly approved in the manual. The user could lose the authority to operate this equipment if an unauthorized change or modification is made.

RADIO-TV INTERFERENCE

This equipment has been tested and found to comply with the limits for a Class B digital device, pursuant to Part 15 of the FCC Rules. These limits are designed to provide reasonable protection against harmful interference in a residential installation. This equipment generates, uses, and can radiate radio frequency energy and, if not installed and used in accordance with the instructions, may cause harmful interference to radio communications. However, there is no guarantee that interference will not occur in a particular installation. If this equipment does cause harmful interference to radio or television reception, which can be determined by turning the equipment off and on, the user is encouraged to try to correct the interference by one or more of the following measures:

- 1) Reorient or relocate the receiving antenna.
- 2) Increase the separation between the equipment and receiver.
- 3) Connect the equipment into an outlet on a circuit different from that to which the receiver is connected.
- 4) Consult the dealer or an experienced radio/TV technician for help.

This Class B digital apparatus complies with Canadian ICES-003.

Cet appareil numérique de la classe B est conforme à la norme NMB-003 du Canada.

Note to CATV system installer:

This reminder is provided to call the CATV system installer's attention to Article 820-40 of the NEC that provides guidelines for proper grounding and, in particular, specifies that the cable ground should be connected to the grounding system of the building as close to the point of cable entry as practical.



"HDMI, the HDMI logo and High-Definition Multimedia Interface are trademarks or registered trademarks of HDMI Licensing LLC."



Manufactured under license from Dolby Laboratories. "Dolby" and the double-D symbol are trademarks of Dolby Laboratories.

LOCATION

For safe operation and satisfactory performance of the unit, keep the following in mind when selecting a place for its installation:

- Shield it from direct sunlight and keep it away from sources of intense heat.
- Avoid dusty or humid places.
- Avoid places with insufficient ventilation for proper heat dissipation. Do not block the ventilation holes at the top and bottom of the unit. Do not place the unit on a carpet because this will block the ventilation holes.
- Install the unit in an upright position.
- Avoid locations subject to strong vibration.
- Do not place the unit near strong magnetic fields.
- Avoid moving the unit to locations where temperature differences are extreme.
- Be sure to unplug the AC power cord from the outlet before carrying the unit.

TO AVOID THE HAZARDS OF ELECTRICAL SHOCK AND FIRE

- Do not handle the power cord with wet hands.
- Do not pull on the power cord when disconnecting it from an AC outlet. Grasp it by the plug.
- If, by accident, water is spilled on the unit, unplug the power cord immediately and take the unit to our authorized service center for servicing.
- Do not place anything directly on top of the unit.

The serial number of this product may be found on the back of the unit. No others have the same serial number as yours. You should record the number and other vital information here and retain this book as a permanent record of your purchase to aid identification in case of theft.

date of purchase	dealer phone No.	serial No
dealer purchase from	model No.	dealer address

Note about recycling:

This product's packaging materials are recyclable and can be reused. Please dispose of any materials in accordance with your local recycling regulations.

Batteries should never be thrown away or incinerated but disposed of in accordance with your local regulations concerning chemical wastes.

✓ Supplied Accessories

owner's manual
(1EMN22315)



remote control
(NF024UD)



batteries
(AA x 2)

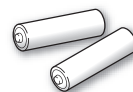

- If you need to replace these accessories, please refer to the part No. with the illustrations and call our toll free customer support line found on the cover of this manual.
- Depending on your antenna system, you may need different types of combiners (mixers) or separators (splitters). Contact your local electronics store for these items.

✓ Symbols Used in this Manual

The following is the description for the symbols used in this manual.
Description refers to:

DTV : Digital TV operation

TV : Analog TV operation

- If neither symbol appears under the function heading, operation is applicable to both.

✓ Features

- **DTV/TV/CATV**
 - You can use your remote control to select channels which are broadcast in digital format and conventional analog format. Also, cable subscribers can access their cable TV channels.
- **Information Display (DTV only)**
 - You can display the title, contents and other information of the current DTV program on the TV screen.
- **Auto Channel Scan**
 - This unit automatically scans and memorizes channels available in your area, eliminating difficult setup procedures.
- **V-chip**
 - This feature allows you to block children's access to inappropriate programs.
- **Closed Caption Decoder**
 - Built-in closed caption decoder displays text for closed caption supported programming.
- **MTS/SAP Tuner**
 - Audio can be selected from the remote control.
- **Auto Shut Off Function**
 - If there is no signal input from the antenna terminal and no operation for 15 minutes, the unit will turn off automatically.
- **Sleep Timer**
 - This feature will automatically turned off the power of the unit at a specific time.
- **Choices for On-screen Language**
 - Select your on-screen language: English, Spanish or French.
- **Stereo Sound Function**
- **PLL Frequency Synthesized Tuning**
 - Provides free and easy channel selection and lets you tune directly to any channel using the channel number buttons on the remote control.
- **Resume**
 - This unit automatically memorizes settings if a power failure occurs.
- **HDMI Input**
- **Component Video Input**
- **S-video Input**
- **AV Input**
- **Digital Audio Coaxial Output**

✓ Contents

INTRODUCTION

Precautions	3
Supplied Accessories	4
Symbols Used in this Manual	4
Features	5
Remote Control Function	6
Installing the Batteries	6
Control Panel	7
Rear Panel	7

CONNECTION

Basic Connection	8
External Device Connection	9

INITIAL SETTING

Initial Setup	12
Main Menu	13
Auto Channel Scan	13
Language Selection	14

WATCHING TV

Channel Selection	15
Volume Adjustment	15
Still Mode	16
Switching Each Mode	16
Switching Audio Mode	17
Screen Information	18
TV Screen Display Mode	19
Sleep Timer	20

OPTIONAL SETTING

Channel List	21
Manual Register	21
Antenna Confirmation	22
Picture Adjustment	23
Closed Caption	24
DTV Closed Caption	25
CC Style	26
V-chip	28
HDMI Audio	31

TROUBLESHOOTING

Troubleshooting Guide	32
-----------------------------	----

INFORMATION

Glossary	34
Maintenance	34
Cable Channel Designations	35
General Specifications	35
Electrical Specification	35
Other Specifications	35
Limited Warranty	Back cover

✓ Remote Control Function

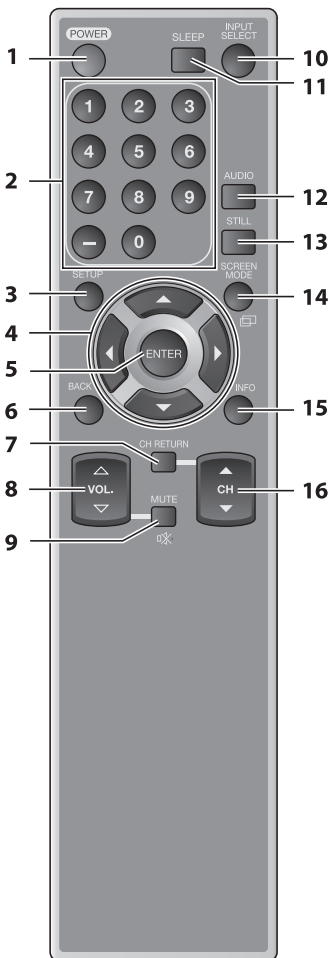

1. **POWER button** (p12)
Press to turn the unit on and off.
2. **Number buttons** (p15)
 - Press to select channels.
 - **— button**
 - Press to shift the minor channel from the major channel.
3. **SETUP button** (p13)
Press to display the main menu.
4. **◀/▶/▲/▼ buttons** (p12)
Press to move left/ right/ up/ down through the items.
5. **ENTER button** (p12)
Press to execute selected command in the menu.
6. **BACK button** (p18)
Press to return to previous menu operation.
7. **CH RETURN button** (p15)
Press to return to previous channel.
8. **VOL. ▲/▼ buttons** (p15)
Press to adjust the volume.
9. **MUTE button** (p15)
Press to turn the sound on and off.
10. **INPUT SELECT button** (p16)
Press to access connected external device like a DVD player or VCR.
11. **SLEEP button** (p20)
Press to activate the sleep timer.
12. **AUDIO button** (p17)
 - Digital Mode (DTV)**
Press to select the audio language.
 - Analog Mode (TV)**
Press to select the audio mode.
13. **STILL button** (p16)
Press to pause screen image.
14. **SCREEN MODE button** (p19)
Press to select aspect ratio available for the TV screen.
15. **INFO button** (p18)
 - Digital Mode (DTV)**
 - Press to display the channel information, signal type and TV setting.
 - Analog Mode (TV)**
 - Press to display the channel number, signal type and TV setting.
 - External Input Mode**
 - Press to display the external input mode, signal type and TV setting.
16. **CH ▲/▼ buttons** (p15)
Press to select channels and the external input mode.

✓ Installing the Batteries

Install the batteries (AA x 2) matching the polarity indicated inside battery compartment of the remote control.

1

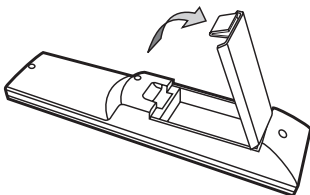

2

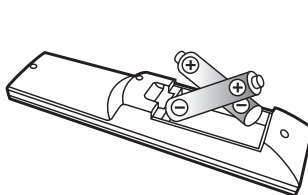

3

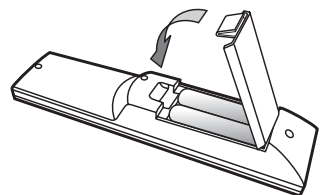

Battery Precautions:

- Be sure to follow the correct polarity as indicated in the battery compartment. Reversed batteries may cause damage to the device.
- Do not mix different types of batteries together (e.g., Alkaline and Carbon-Zinc) or old batteries with fresh ones.
- If the device is not to be used for a long period of time, remove the batteries to prevent damage or injury from possible battery leakage.
- Do not try to recharge batteries; they can overheat and rupture.

✓ Control Panel

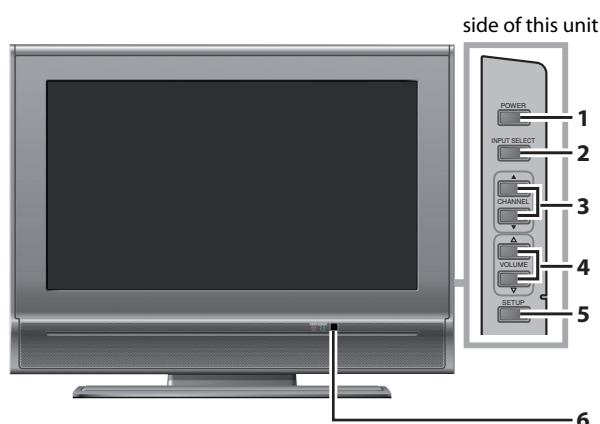

1. **POWER button** (p12)
Press to turn the unit on and off.
2. **INPUT SELECT button** (p16)
 - Press to access connected an external device like a DVD player or VCR.
 - Press to decide the command of setting when the menu is displayed.
3. **CHANNEL ▲/▼ buttons** (p15)
Press to select channels or move up/down through the main menu items.
4. **VOLUME ▲/▼ buttons** (p15)
Press to adjust the volume or move right (▲)/left (▼) through the main menu items.
5. **SETUP button** (p13)
Press to display the main menu.
6. **Infrared Sensor Window**
Receives infrared rays transmitted from the remote control.

✓ Rear Panel

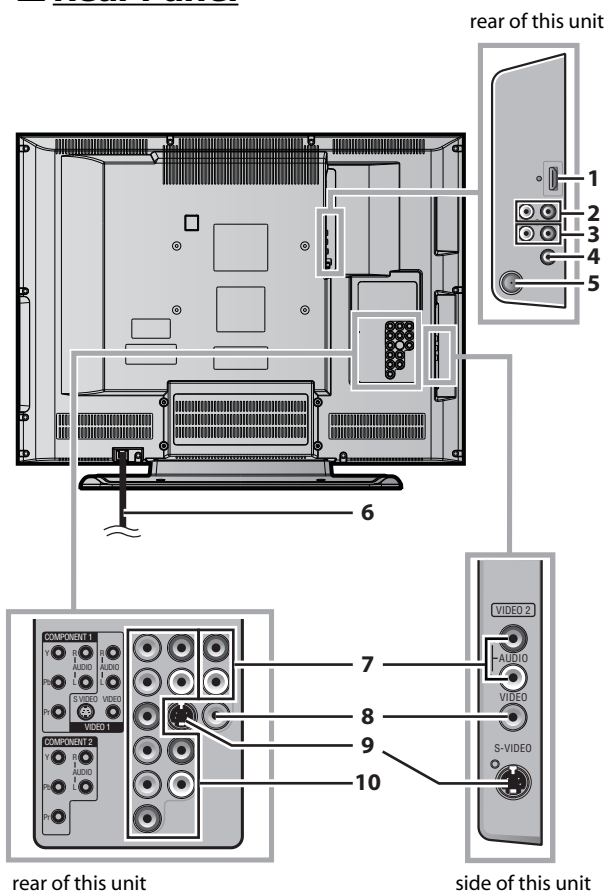

1. **HDMI IN jack** (p9)
HDMI connection for an HDMI device.
2. **AUDIO IN jacks** (p9)
RCA audio cable connection for a DVI device. (For HDMI IN jack only)
3. **AUDIO OUT jacks** (p11)
RCA audio cable connection for an external device. Use analog audio input jacks of an external device.
4. **DIGITAL AUDIO OUT (COAXIAL) jack** (p11)
Digital audio coaxial cable connection for a decoder or an audio receiver. Use digital audio input jack of an external device.
5. **ANT. IN jack** (p8)
RF coaxial cable connection for your antenna or cable/satellite box.
6. **AC power cord**
Connect to a standard AC outlet to supply power to this unit.
7. **AUDIO input jacks** (p10)
RCA audio cable connection for an external device.
8. **VIDEO input jack** (p11)
RCA video cable connection for an external device.
9. **S-VIDEO input jack** (p10)
S-video cable connection for an external device.
10. **COMPONENT and AUDIO input jacks** (p10)
Component video cable and RCA audio cable connection for an external device. Use component video and audio output jacks of an external device.

Cables not included.

Must be purchased separately.

✓ Basic Connection

This section describes how to connect the unit to an antenna, cable/satellite box, etc.

Note:

- Be sure your antenna or other device is connected properly before plugging in the power cord.

[Antenna Cable Connection]

When connecting the unit to an antenna or cable TV company (without cable/satellite box)

Connect the RF coaxial cable on your home outlet to the antenna input jack of this unit.

e.g.)

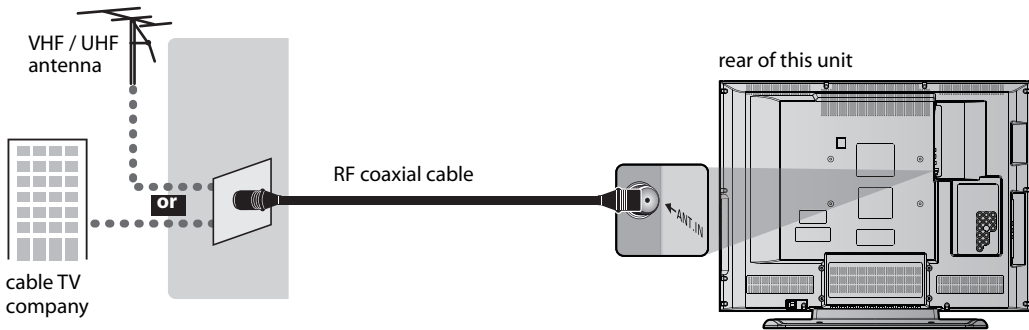

- * Once connections are completed, turn on the unit and begin initial setup. Channel scanning is necessary for the unit to memorize all available channels in your area. (Refer to "Initial Setup" on page 12.)

Note:

- For your safety and to avoid damage to device, please unplug the RF coaxial cable from the antenna input jack before moving the unit.
- If you use an antenna to receive analog TV, it should also work for DTV reception. Outdoor or attic antennas will be more effective than setup versions.
- To easily switch your reception source between antenna and cable, install an antenna selector.
- If you connect to the cable system directly, contact the CATV installer.

[Connection to Cable Box or Satellite Box]

Connect the RF coaxial cable on your home outlet to the input jack of the cable/satellite box.

Use another RF coaxial cable to connect the antenna input jack of the unit to the output jack of the cable/satellite box.

e.g.)

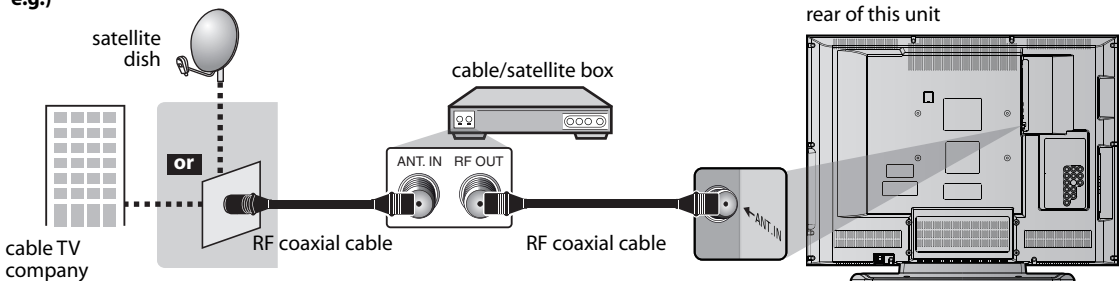

- * Required cables and connecting methods differ depending on the cable/satellite box. For more information, please contact your cable/satellite provider.

Cables not included.

Must be purchased separately.

External Device Connection**[HDMI Connection]**

HDMI (High Definition Multimedia Interface) transports high definition video and multi-channel digital audio through a single cable. It ensures that the content sent from the source to TV is of the highest possible resolution.

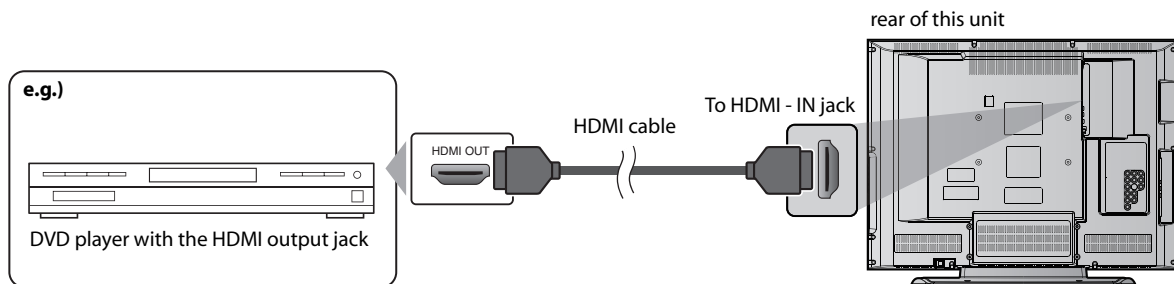
**Note:**

- This unit accepts 480i / 480p / 720p / 1080i video signals, and 32kHz / 44.1kHz / 48kHz audio signals.
- This unit accepts only 2 channel audio signal (LPCM).
- You need to select "PCM" for the digital audio output of the device connected or the HDMI audio setting. There may be no audio output if you select "Bitstream", etc.
- This TV only accepts signals compliant with EIA861.

[HDMI-DVI Connection]

If your video device has a DVI output jack, connect using a HDMI-DVI conversion cable.

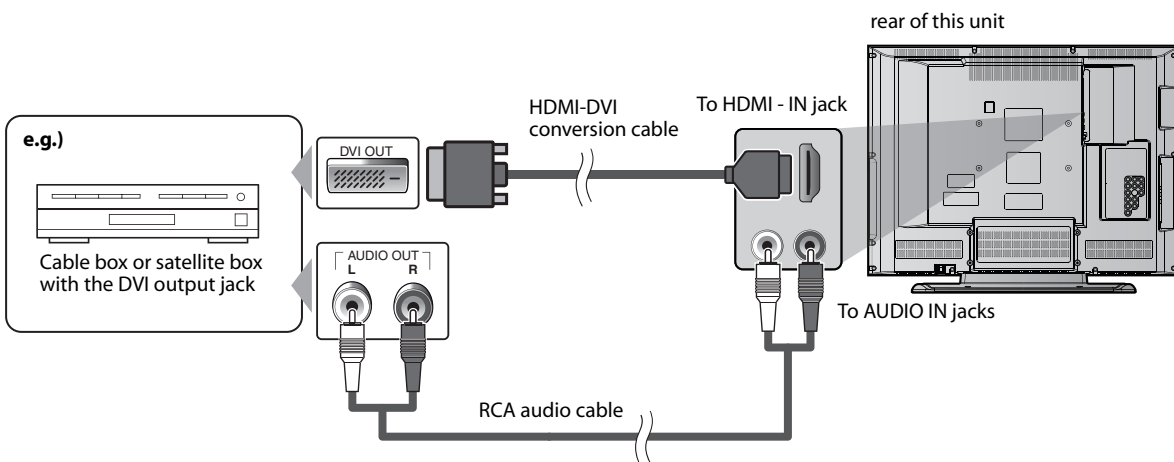
**Note:**

- This unit accepts 480i / 480p / 720p / 1080i video signals.
- An HDMI-DVI conversion cable requires a separate audio cable connection as well.
- Audio signals are converted from digital to analog for this connection.
- DVI does not display 480i image that is not compliant with EIA/CEA-861/861B.

Cables not included.

Must be purchased separately.

[Component Video Cable Connection]

Component video connection offers better picture quality for video devices connected to the unit.

Use a component video cable to connect the unit to external video devices equipped with component video output jacks.

If you connect to the unit's COMPONENT 1 video input jack, connect RCA audio cables to the audio L/R jacks of COMPONENT 1.

If you connect to the unit's COMPONENT 2 video input jack, connect RCA audio cables to the audio L/R jacks of COMPONENT 2.

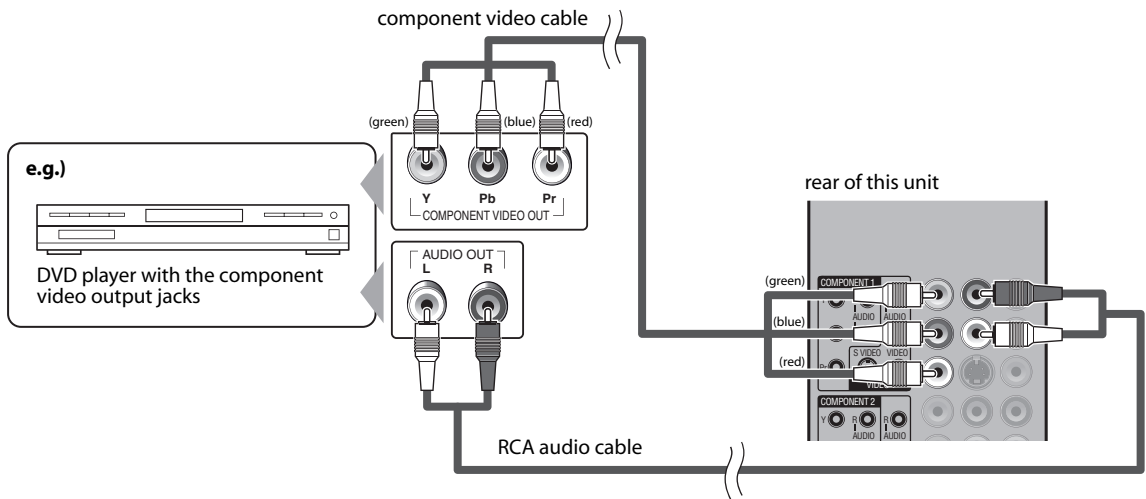

Note:

- This unit accepts 480i / 480p / 720p / 1080i video signals.

[S-video Cable Connection]

S-video connection offers good picture quality for video devices connected to the unit.

Use an S-video cable to connect the unit to external video devices equipped with S-video output jack.

If you connect to the unit's VIDEO 1 S-video input jack, connect RCA audio cables to the audio L/R jacks of VIDEO 1.

If you connect to the unit's VIDEO 2 S-video input jack, connect RCA audio cables to the audio L/R jacks of VIDEO 2.

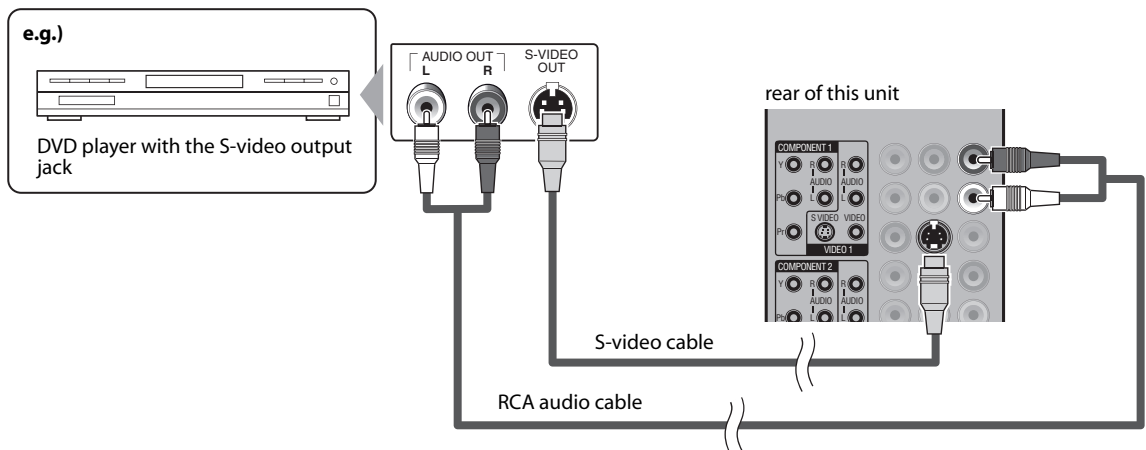

Note:

- If you connect to the S-video jack and the video jack at the same time, the S-video connection will have priority.

Cables not included.

Must be purchased separately.

[Video Connection]

Video connection offers standard picture quality for video devices connected to the unit.

If you connect to the unit's VIDEO 1 video input jack, connect RCA audio cables to the audio L/R jacks of VIDEO 1.

If you connect to the unit's VIDEO 2 video input jack, connect RCA audio cables to the audio L/R jacks of VIDEO 2.

When the audio jack of the video device is monaural, connect the RCA audio cable to the audio L input jack.

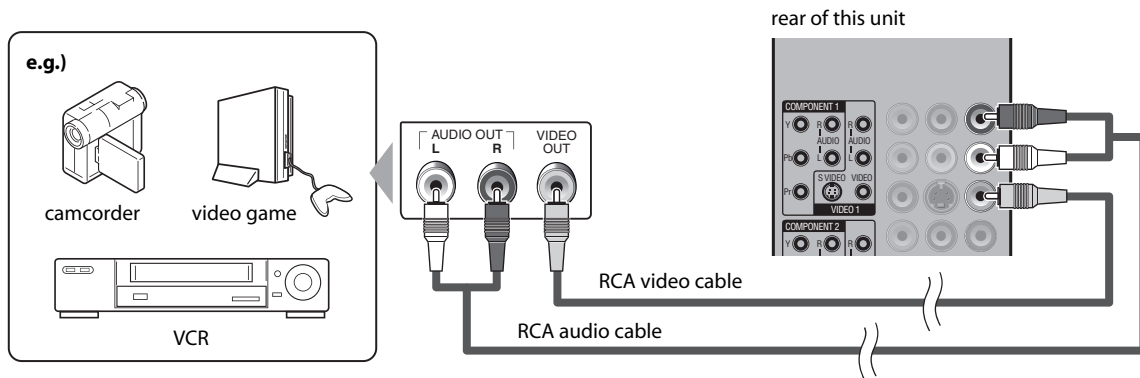
**Note:**

- If you connect to the S-video jack and the video jack at the same time, the S-video connection will have priority.

[Audio Output Connection]**[Digital (for digital broadcasting only)]**

If you connect this unit to an external digital audio device, you can enjoy multi-channel audio like 5.1ch digital broadcasting sound.

[Analog]

If you connect this unit to an external analog audio device, you can enjoy stereo (2 channel) audio.

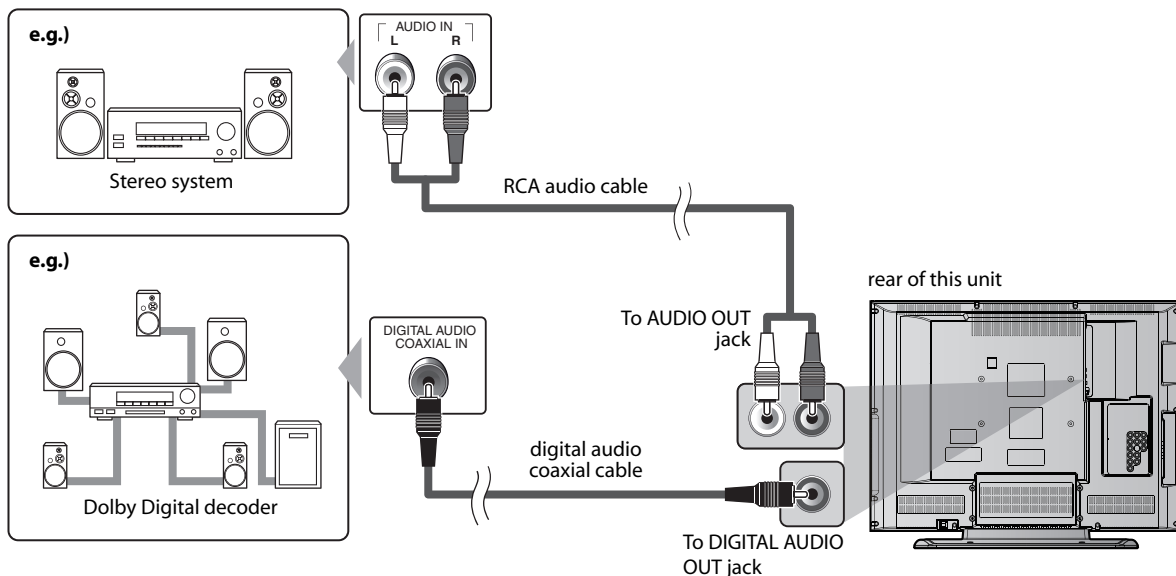

These operations are accessible by remote control. Some may also be accessible by controls on the main unit.

✓ Initial Setup

This section will guide you through the unit's initial setting which includes selecting a language for your on-screen menu and auto channel scan, which automatically scans and memorizes viewable channels.

Before you begin:

Make sure if the unit is connected to antenna or cable.

- 1 After making all the necessary connections, press **[POWER]** to turn on the unit.



- This operation may take a few moments.

- 2 Use **[Cursor ▲/▼]** to select the on-screen language from the choices on the right side of the TV screen. (English / Español / Français)



- "Initial Setup" menu on step 3 will be displayed in the selected language after you press **[ENTER]**.

- 3 Use **[Cursor ▲/▼]** to select "Air" for TV channels or "Cable" for CATV channels, then press **[ENTER]**.

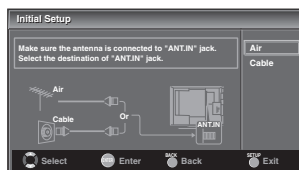

- Scanning and memorizing of channels start automatically.

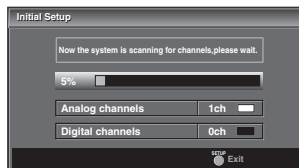

- When the scanning and memorizing are completed, the lowest memorized channel in the broadcasting will be displayed.

Note:

- If you connect the cable system directly, contact the CATV installer.
- If you press **[POWER]** or **[SETUP]** during auto channel scan, this setting will be canceled.
- The initial auto channel scan function can be executed for either "Air" or "Cable" only once. When you change the connection (Air/Cable), set auto channel scan again. (Refer to page 13.)
- You can cancel or exit the initial auto channel scan menu by pressing **[SETUP]**.
- If there is no signal input from the antenna terminal and no operation for several seconds after you turn on the unit, "Helpful Hints" appears. Follow the instructions listed on the TV screen.

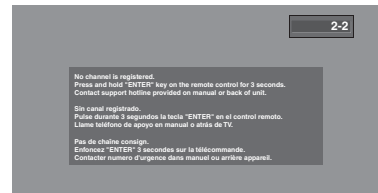

✓ Main Menu

This section describes the overview of the main menu displayed when you press [SETUP]. For more details, see the reference page for each item. The main menu consists of the function setting items below.

Press [SETUP].

SETUP



- **EXIT**

To exit settings.

- **PICTURE**

You can adjust the picture quality.
(Refer to "Picture Adjustment" on page 23.)

- **CHANNEL**

You can automatically scan the viewable channels and remove those that are undesired.
(Refer to "Auto Channel Scan" on page 13.)

- **DETAIL**

You can change the display format for closed caption, which displays the dialogue of a TV program or other information across the TV screen.
(Refer to "Closed Caption" on page 24.)

Set the viewing limitations.

(Refer to "V-chip" on page 28.)

And select the sound input for the HDMI jack if your TV is connected to a HDMI device.

(Refer to "HDMI Audio" on page 31.)

- **LANGUAGE**

You can change the language (English, Spanish, French) displayed on the main menu.

(Refer to "Language Selection" on page 14.)

✓ Auto Channel Scan

If you switch wires (e.g., between antenna and CATV) or if you move the unit to a different area after the initial setting, or if you restore the DTV channel you deleted, you will need to perform auto channel scan.

Before you begin:

Make sure if the unit is connected to antenna or cable.

1 Press [SETUP] to display the main menu.

SETUP



2 Use [Cursor ▲/▼] to select "CHANNEL", then press [ENTER].



or



3 Use [Cursor ▲/▼] to select "Autoscan", then press [ENTER].



or

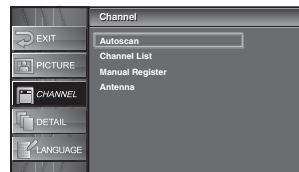

Use [Cursor ▲/▼] to select an appropriate option, then press [ENTER].



or

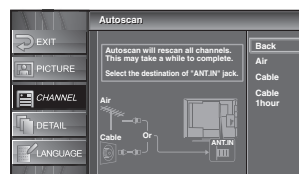

- When aerial antenna is connected, select "Air".
- When connected to CATV, select "Cable".
- Scanning and memorizing of channels start automatically.

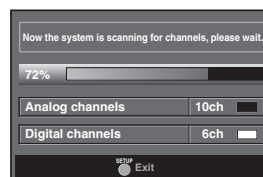

- When the scanning and memorizing are completed, the lowest memorized channel will be displayed.

Note:

- If you connect the cable system directly, contact the CATV installer.
- If you press **[POWER]** or **[SETUP]** during auto channel scan, the setting will be canceled.
- Channel settings will be saved even if the power fails.
- If you need the English menus instead of the Spanish or French menus you are having, press **[SETUP]**. Use **[Cursor ▲/▼]** to select "IDIOMA" or "LANGUE", then press **[ENTER]**. Use **[Cursor ▲/▼]** to select "English", then press **[ENTER]**. Press **[SETUP]** to exit the main menu.
- With regard only to the digital channel, even after the scanning is complete if you unplug the AC power cord before turning off the unit by pressing **[POWER]**, the channel setting may be lost.

✓ Language Selection

You can choose English, Spanish, or French as your on-screen language.

1 Press **[SETUP]** to display the main menu.



2 Use **[Cursor ▲/▼]** to select "LANGUAGE", then press **[ENTER]**.

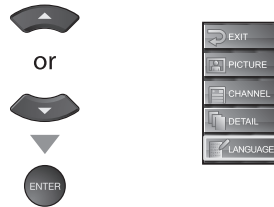

3 Use **[Cursor ▲/▼]** to select "English", "Español" or "Français", then press **[ENTER]**.



4 Press **[SETUP]** to exit.



✓ Channel Selection

Select channels by pressing [CH ▲/▼] or [the Number buttons].

- To select the memorized channels, use [CH ▲/▼] or [the Number buttons].
- To select the non-memorized channels, use [the Number buttons].

To Use [the Number buttons]

TV

- When selecting analog channel 12



DTV

- When selecting digital channel 12-1
Be sure to press [-] before entering the minor channel number.



- Press [CH RETURN] to return to the previously viewed channel.

About digital TV broadcasting:

With its high definition broadcast, digital broadcasting far surpasses analog broadcasting in both its picture and sound quality.

What is the minor channel?

By using high compression technology, digital broadcasting offers a service that enables multiple signals to send simultaneously. Therefore, you can select more than one program per major channel since digital broadcasting technology distinguishes between multiple channels broadcast by a single network.

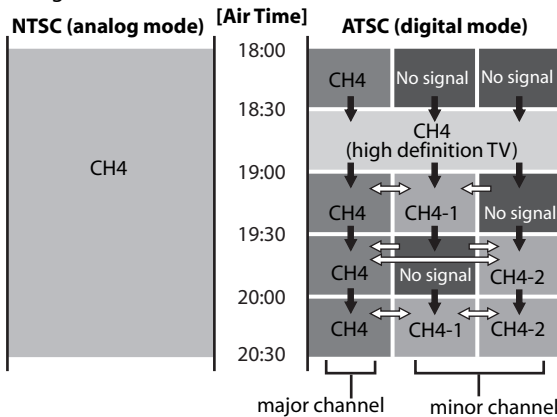

➡ : change automatically

⇔ : change manually by using [CH ▲/▼]

Note:

- "No Signal" will appear on the TV screen after the minor channel broadcast is over.

✓ Volume Adjustment

This section describes how to adjust the volume. The mute function, which turns the sound off and on, is also described.

Use [VOL. ▲/▼] to adjust the audio volume.



- The volume bar will be displayed at the bottom of the TV screen when adjusting the volume.
- The volume bar display will automatically disappear in a few seconds.

Press [MUTE] to turn off and on the sound.



- "Mute" is displayed on the TV screen for a few seconds.

Press [MUTE] again or [VOL. ▲/▼] to recover the original volume.

☑ Still Mode

You can freeze the image shown on the TV screen.

Press **[STILL]** to pause the image shown on the screen.



- The sound output will not be paused.
- If no signal is detected or protected signal is received during still mode, the image remains paused and the sound output will be muted.
- The still function will be released after 5 minutes.

To cancel still mode, press any button except **[POWER]**.

☑ Switching Each Mode

You can easily switch with the remote control to the DTV (ATSC) and TV (NTSC) or to access an external device when they are connected to the unit.

Press **[INPUT SELECT]** or **[CH ▲]** repeatedly to cycle through the input modes.

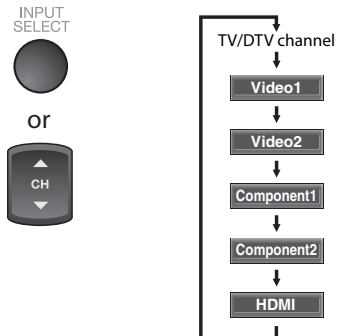

- Pressing **[CH ▼]** reverses the direction of the mode.
- To use the video or S-video input jack of VIDEO 1 on the unit, select "Video1".
- To use the video or S-video input jack of VIDEO 2 on the unit, select "Video2".
- To use the component video input jack of COMPONENT 1 on the unit, select "Component1".
- To use the component video input jack of COMPONENT 2 on the unit, select "Component2".
- To use the HDMI - IN jack on the unit, select "HDMI".

✓ Switching Audio Mode

This section describes how to switch the audio language.

TV

- 1 Press **[AUDIO]** to display the currently selected audio mode. While receiving an MTS broadcast, press repeatedly to cycle through the available audio channel.



When all audio are available



When stereo and monaural audio are available



When SAP and monaural audio are available



When only monaural audio is available



STEREO : Outputs stereo-audio
SAP : Outputs second audio program
MONO : Outputs mono-audio

- The information display will automatically disappear in a few seconds.

DTV

- 1 Press **[AUDIO]** to display the currently selected language and the number of available languages.



- 2 Press **[AUDIO]** repeatedly to cycle through the available audio languages.



- Available languages differ depending on the broadcast. "Other" is displayed when the audio language cannot be acquired, or the acquired languages are other than English, Spanish or French.
- The information display will automatically disappear in a few seconds.

Note:

- Pressing **[AUDIO]** does not control external audio device.

✓ **Screen Information**

You can display the currently selected channel or other information such as the audio mode on the TV screen.

TV

In the analog mode, the current channel number and the audio mode are displayed.

Press **[INFO]**.



- The current channel number, audio mode, type of resolutions for video signal, TV aspect ratio, CC and TV rating are displayed at the top-right corner of the TV screen.

To clear the display, press **[INFO]** again.

You can also press **[BACK]**.

DTV

In the digital mode, the detailed broadcasting information for the current channel such as program title, program guides are displayed.

Press **[INFO]** to display the details of the currently selected program.



[Broadcasting Information]

- The following information is displayed.
 - 1 program title
 - 2 broadcast station
 - 3 program guide
(The program guide added to broadcasting information is displayed. Maximum display of 4 lines.)
 - 4 channel number
 - 5 audio language
(Refer to "Switching Audio Mode" on page 17.)
 - 6 effective scanning lines and scan mode
 - 7 program format
 - 8 program aspect ratio
 - 9 program rating
 - 10 CC (not available if CC is set to "Off")

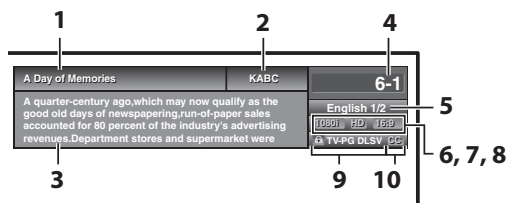

Note:

- When the program guide consists of more than 4 lines, use **[Cursor ▲/▼]** to scroll.
- "No description provided" is displayed when the program guide is not provided.
- While the program guide is displayed, the closed caption function is interrupted.
- In external input mode, the following screen is displayed; e.g.) When an external device is connected to VIDEO 1 input jack.



- The information display will automatically disappear in 1 minute.

☑ TV Screen Display Mode

4 types of display modes can be selected when the broadcasting station is sending 4:3 or 16:9 video signal.

Press **[SCREEN MODE]** repeatedly to switch the TV aspect ratio.



For 4:3 video signal

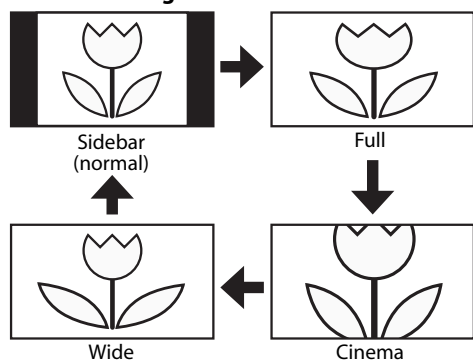

[Sidebar]

Display a 4:3 picture at its original size. Sidebars appear on both edges of the screen.

[Full]

Display a 4:3 picture at a 16:9 size; the picture is stretched horizontally to fill the screen.

[Cinema]

Display a 4:3 picture at a 16:9 size; the picture is stretched horizontally and vertically to fill the screen. This crops out the top and bottom of the picture.

[Wide]

Display the picture with its center at the original size and the edges stretched horizontally.

For 16:9 video signal

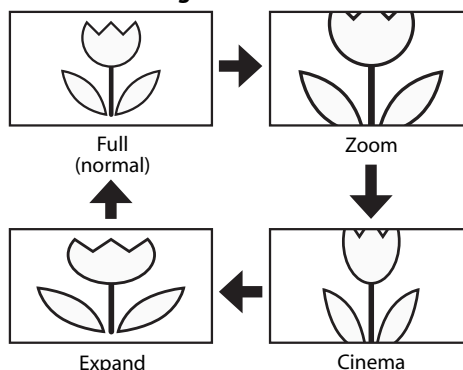

[Full]

Display a 16:9 picture at its original size.

[Zoom]

Display a 16:9 picture at its maximum size without changing its horizontal and vertical ratio.

[Cinema]

Display a vertically stretched picture.

[Expand]

Display a horizontally stretched picture.

Note:

- You may not switch the display mode depending on the program.

✓ Sleep Timer

The sleep timer can be set to automatically turn off the unit after an incremental period of time.

1 Press [**SLEEP**] to set the sleep timer.



- Sleep timer display appears on the TV screen.

2 Press [**SLEEP**] repeatedly to change the amount of time until shut off.



- You can set your unit to turn off after a set period of time (from 30 to 120 minutes).
- Each press of [**SLEEP**] will increase the time by 30 minutes.
- After set up, the sleep timer display can be called up for checking by pressing [**SLEEP**].

To Cancel the Sleep Timer

Press [**SLEEP**] repeatedly until "Sleep Off" is displayed on the TV screen.

Note:

- The sleep timer setting display will automatically disappear in a few seconds.
- When you disconnect the unit from the AC outlet or when a power failure occurs, the sleep timer setting will be canceled.

✓ Channel List

The channel list function lets you remove undesired channels from the channel registration list.

1 Press **[SETUP]** to display the main menu.



2 Use **[Cursor ▲/▼]** to select "CHANNEL", then press **[ENTER]**.

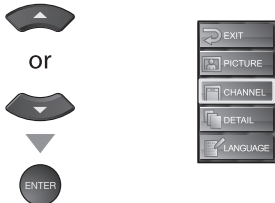

3 Use **[Cursor ▲/▼]** to select "Channel List", then press **[ENTER]**.

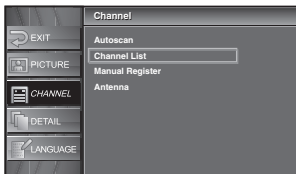

4 Use **[Cursor ▲/▼]** to select the channel you want to remove, then press **[ENTER]**.



- The channel display for the removed channel darkens. You will not be able to select the channel again using **[CH ▲/▼]**.
- To reactivate a removed channel, highlight it using **[Cursor ▲/▼]** and press **[ENTER]**. The channel display lightens.
- When you remove a major channel, its minor channels are removed as well.

Note:

- The channel with the "DTV" indicated on the display is ATSC. Otherwise the channel is NTSC.

5 Press **[SETUP]** to exit.



✓ Manual Register

The manual register function lets you add the channels that were not added by the auto channel scan due to the reception condition at the initial setting.

1 Press **[SETUP]** to display the main menu.



2 Use **[Cursor ▲/▼]** to select "CHANNEL", then press **[ENTER]**.

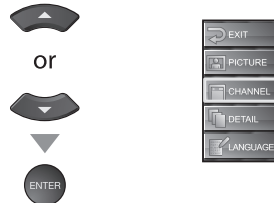

3 Use **[Cursor ▲/▼]** to select "Manual Register", then press **[ENTER]**.

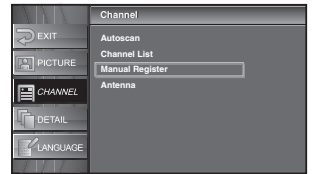

4 Use **[the Number buttons]** to enter the number of the channel you want to add, then press **[ENTER]**.

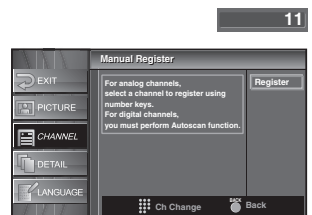
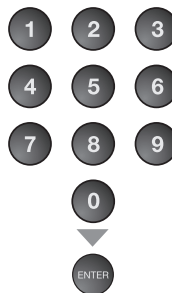

5 Press **[SETUP]** to exit.



Note:

- If set up completes successfully, "Registered to the Channel List" is displayed.
- If external input is used, it is not possible to register the channel and "Unavailable" will be displayed on the TV screen.

☑ Antenna Confirmation

This function lets you check the signal strength of each channel.

1 Press **[SETUP]** to display the main menu.



2 Use **[Cursor ▲/▼]** to select "CHANNEL", then press **[ENTER]**.

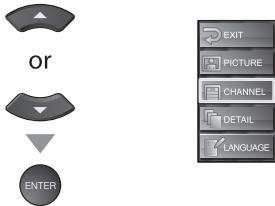

3 Use **[Cursor ▲/▼]** to select "Antenna", then press **[ENTER]**.

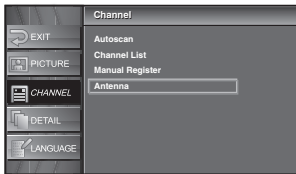

4 Use **[the Number buttons]** or **[CH ▲/▼]** to select the channel for which you want to check the signal strength.

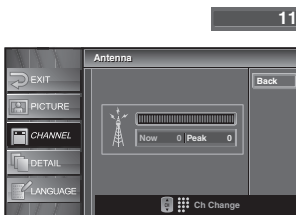
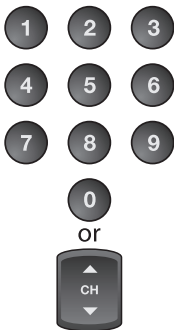

- If the channel is set to external input, you cannot confirm the antenna condition.

Video1

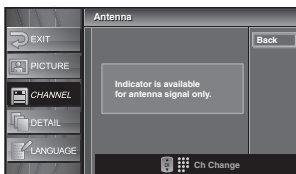

5 Press **[SETUP]** to exit.



✓ Picture Adjustment

You can adjust brightness, contrast, color, tint and sharpness.

- 1 Press **[SETUP]** to display the main menu.



- 2 Use **[Cursor ▲/▼]** to select "PICTURE", then press **[ENTER]**.



or



- 3 Use **[Cursor ▲/▼]** to select the item you want to adjust, then press **[ENTER]**.



or

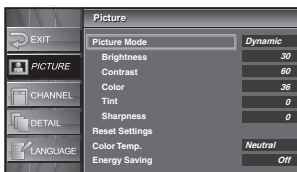

- 4 Adjust the picture quality.

Picture Mode

Use **[Cursor ▲/▼]** to select the desired setting, then press **[ENTER]**. (**Standard**, **Dynamic**, **Movie** and **News**)



or

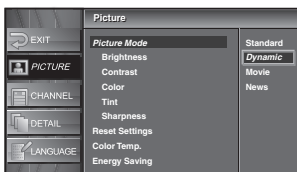

Brightness, Contrast, Color, Tint, Sharpness

Use **[Cursor ◀/▶]** to adjust.



	Cursor ◀	Cursor ▶
Brightness 	to decrease brightness	to increase brightness
Contrast 	to decrease contrast	to increase contrast
Color 	to decrease color	to brighten color
Tint 	to add red	to add green
Sharpness 	to make soft	to make clear

Reset Settings

Use **[Cursor ▲/▼]** to select "Reset", then press **[ENTER]** to restore the "Picture Mode" setting to default.



OR

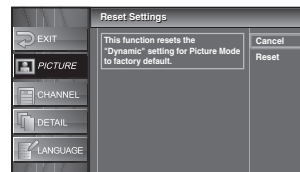

Color Temp.

Use **[Cursor ▲/▼]** to select the desired setting, then press **[ENTER]**. (**Cool**, **Neutral** and **Warm**)



OR

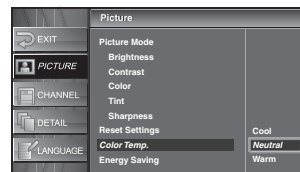

Energy Saving

Use **[Cursor ◀/▶]** to adjust the brightness of the backlight.



:To brighten

OR



:To darken



Note:

- To cancel picture adjustment, press **[SETUP]**.

- 5 Press **[SETUP]** to exit.

SETUP



✓ Closed Caption

You can view closed captioning (cc) for TV programs, movies and news. Closed caption refer to text of dialogue or descriptions displayed on-screen for the hearing impaired.

1 Press **[SETUP]** to display the main menu.



2 Use **[Cursor ▲/▼]** to select "DETAIL", then press **[ENTER]**.



3 Use **[Cursor ▲/▼]** to select "Closed Caption", then press **[ENTER]**.

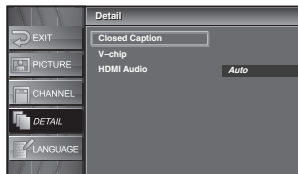

4 Use **[Cursor ▲/▼]** to select "Conventional CC", then press **[ENTER]**.

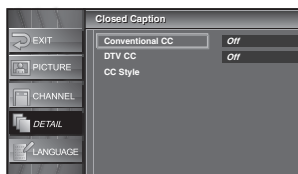

5 Use **[Cursor ▲/▼]** to select the desired closed caption, then press **[ENTER]**.

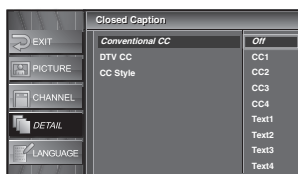

[Caption Mode]

CC1 and Text1;

are the primary caption and text services.

The captioning or text is displayed in the same language as the program's dialogue (up to 4 lines of script on the TV screen, where it does not obstruct relevant parts of the picture).

CC2 and Text2;

serve as the preferred data channels.

The captioning or text is often a secondary language.

CC3, CC4, Text2 and Text4;

are rarely available and broadcasters use them only in special conditions, such as when "CC1" and "CC3" or "Text1" and "Text3" are not available.

- There are 3 display modes according to programs:

Paint-on mode:

Displays input characters on the TV screen immediately.

Pop-on mode:

Once characters are stored in memory, they are displayed all at once.

Roll-up mode:

Displays the characters continuously by scrolling (max. 4 lines).

6 Press **[SETUP]** to exit.



Note:

- To show the closed caption on your TV screen, broadcast signal must contain the closed caption data.
- Not all TV programs and commercials have the closed caption or all types of the closed caption.
- Captions and texts may not match the TV voice exactly.
- Changing channels may delay the closed caption for a few seconds.
- Adjusting or muting the volume may delay the closed caption for a few seconds.
- Abbreviations, symbols and other grammatical shortcuts may be used in order to keep pace with the on-screen action. This is not a problem with the unit.
- The caption or text characters will not be displayed while the main menu or functions display is shown.
- If a black box appears on the TV screen, this means that the closed caption is set to the text mode. To clear the box, select "CC1", "CC2", "CC3", "CC4" or "Off".
- If the unit receives poor quality television signals, the captions may contain errors, or there might be no captions at all. Some possible causes of poor quality signals are:
 - Automobile ignition noise
 - Electric motor noise
 - Weak signal reception
 - Multiplex signal reception (ghosts or screen flutter)
- The unit retains the closed caption setting if the power fails.
- Closed caption will not be displayed when you are using an HDMI connection.
- When the unit receives a special effects playback signal (i.e., Search, Slow and Still) from a VCR's video output channel (CH3 or CH4), the unit may not display the correct caption or text.

✔ DTV Closed Caption

DTV

In addition to the basic closed caption described on page 24, DTV has its own closed caption called DTV CC. Use this menu to change the settings for DTV CC.

- 1 Press **[SETUP]** to display the main menu.



- 2 Use **[Cursor ▲/▼]** to select "DETAIL", then press **[ENTER]**.



- 3 Use **[Cursor ▲/▼]** to select "Closed Caption", then press **[ENTER]**.

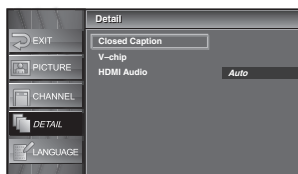

- 4 Use **[Cursor ▲/▼]** to select "DTV CC", then press **[ENTER]**.

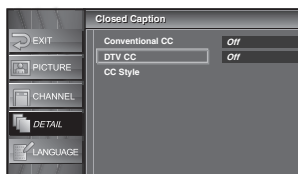

- 5 Use **[Cursor ▲/▼]** to select the desired DTV closed caption, then press **[ENTER]**.

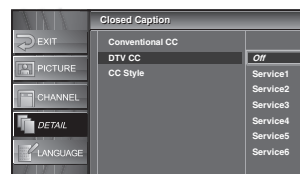

DTV CC	Off	Select if you do not want DTV CC. This is the default.
	Service1~6	Select one of these before changing any other item in "Closed Caption" menu. Choose "Service1" under normal circumstances.

- 6 Press **[SETUP]** to exit.



Note:

- "DTV CC" that you can switch differs depending on the broadcast description.

☑ CC Style

You can change the style of CC such as font, color or size, etc.

1 Press **[SETUP]** to display the main menu.



2 Use **[Cursor ▲/▼]** to select "DETAIL", then press **[ENTER]**.



3 Use **[Cursor ▲/▼]** to select "Closed Caption", then press **[ENTER]**.

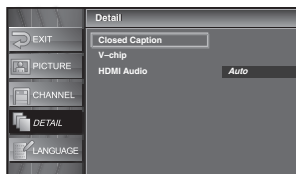

4 Use **[Cursor ▲/▼]** to select "CC Style", then press **[ENTER]**.

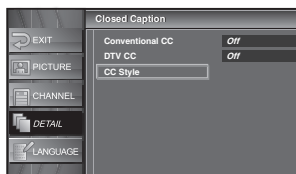

5 Use **[Cursor ▲/▼]** to select "User Setting", then press **[ENTER]**.

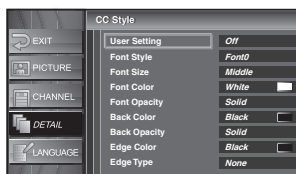

6 Use **[Cursor ▲/▼]** to select "On", then press **[ENTER]**.

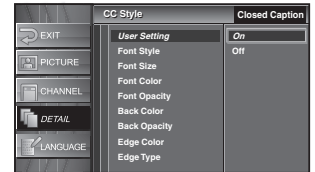

7 Use **[Cursor ▲/▼]** to select an item, then press **[ENTER]**. Then use **[Cursor ▲/▼]** to select the desired setting and press **[ENTER]**.

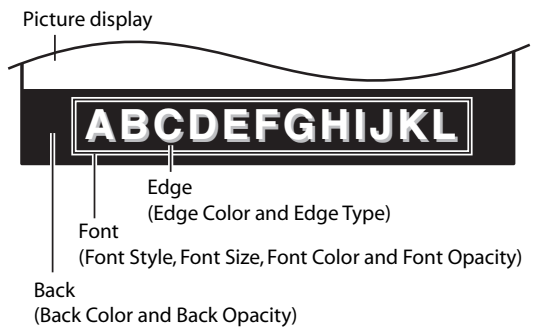

• The setting description for each item is shown below.

[Font Style]

Closed Captioning font style can be changed as below.

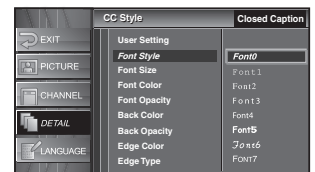

[Font Size]

Font size of the displayed caption can be switched as below.

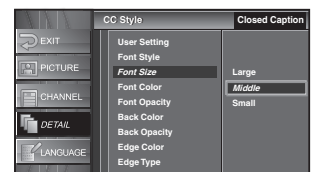

[Font Color]

Font color of the displayed caption can be switched as below.

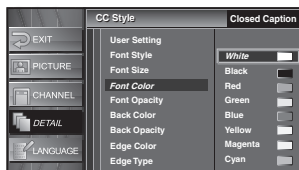
**[Edge Type]**

Edge type of the displayed caption can be switched as below.

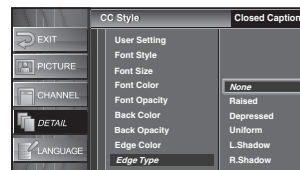
**[Font Opacity]**

Font opacity of the displayed caption can be switched as below.

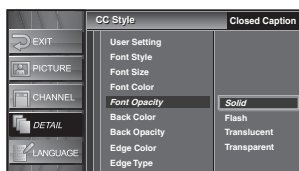

8 Press **[SETUP]** to exit.

SETUP

**[Back Color]**

Background color of the displayed caption can be switched as below.

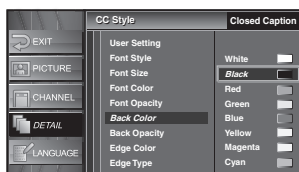
**[Back Opacity]**

Background opacity of the displayed caption can be switched as below.

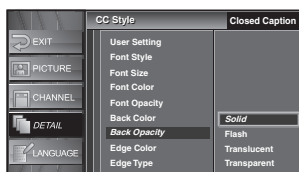
**[Edge Color]**

Edge color of the displayed caption can be switched as below.

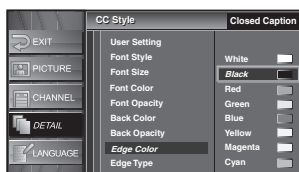

✓ V-chip

V-chip reads the ratings for programs, then denies access to the programs which exceed the rating level you set. With this function, you can block certain programming inappropriate for children.

1 Press **[SETUP]** to display the main menu.



2 Use **[Cursor ▲/▼]** to select "DETAIL", then press **[ENTER]**.



3 Use **[Cursor ▲/▼]** to select "V-chip", then press **[ENTER]**.

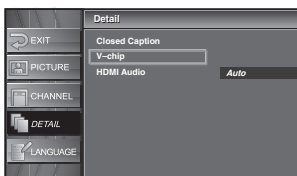

4 Use **[the Number buttons]** to enter the 4-digit numbers for your password.

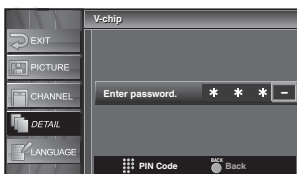
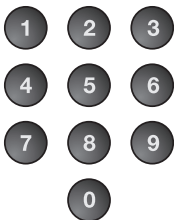

- When you have not set up your password, enter 0000.
- When the password is correct, the "V-chip" menu is displayed.

See the following description for setting each item.

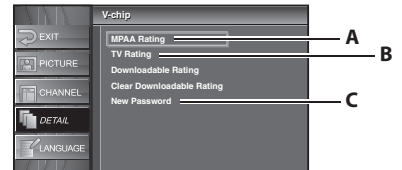

A--"A. MPA A Rating" ⇨ page 29

B--"B. TV Rating" ⇨ page 29

C--"C. New Password" ⇨ page 30

Note:

- When you select a rating and set it to "Block", the higher ratings will be blocked automatically. The lower ratings will be available for viewing.
- When you set the highest rating to "View", all ratings turn to "View" automatically.
- To block any inappropriate programming, set your limits in "MPAA Rating", "TV Rating" and "Downloadable Rating".
- The V-chip setting will be retained after a power failure (except the access code reverts to 0000).
- If the rating is blocked,  will appear.
- "Downloadable Rating" will be available when the unit receives a digital broadcast using the new rating system.
- If the broadcasting signal does not have the downloadable rating information, "Downloadable Rating is currently not available." will appear. This message will also appear when you try to access "Downloadable Rating" after you have cleared the downloadable rating information, and the new information has not been downloaded since.
- To clear the downloadable rating information and its setting, select "Clear Downloadable Rating".

A. MPAA Rating

MPAA Rating is the rating system created by MPAA (Motion Picture Association of America).

- Use [Cursor ▲/▼] to select "MPAA Rating", then press [ENTER].

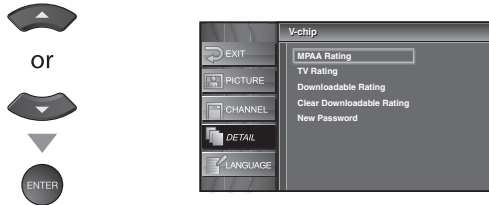

- Use [Cursor ▲/▼] to select the desired rating, then press [ENTER] repeatedly to switch between "View" and "Block".

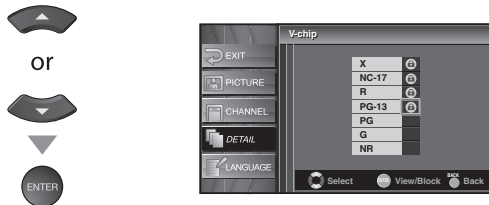

Rating	Category
X	Mature audience only
NC-17	No one under 17 admitted
R	Restricted; under 17 requires accompanying parent or adult guardian
PG-13	Unsuitable for children under 13
PG	Parental guidance suggested
G	General audience
NR	No rating

- Press [SETUP] to exit.



Note:

- Changing the category to "Block" or "View" automatically changes all its sub ratings to the same ("Block" or "View").

B. TV Rating

- Use [Cursor ▲/▼] to select "TV Rating", then press [ENTER].

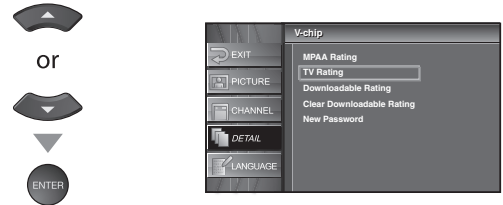

- Use [Cursor ▲/▼/◀/▶] to select the desired rating, then press [ENTER] repeatedly to switch between "View" and "Block".

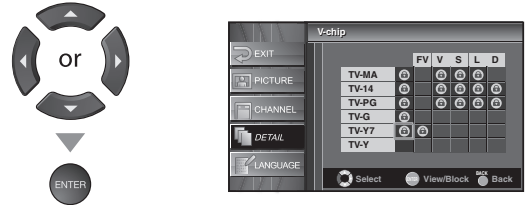

- Press [SETUP] to exit.



[To Set the Sub Ratings]

As for TV-MA, TV-14, TV-PG, or TV-Y7, you can further set the sub ratings to block specific elements of programming. To set the sub ratings, follow the step below.

Use [Cursor ▲/▼/◀/▶] to select the desired rating, then press [ENTER] repeatedly to switch between "View" and "Block".

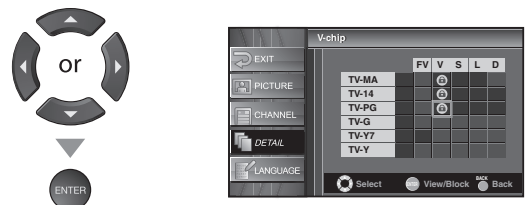

C. New Password

Although the default code "0000" is supplied with the unit, you can set your own password.

Rating	Category	
TV-MA	Mature audience only	higher  lower
TV-14	Unsuitable for children under 14	
TV-PG	Parental guidance suggested	
TV-G	General audience	
TV-Y7	Appropriate for all children 7 and older	
TV-Y	Appropriate for all children	lower

Sub Rating	Category	Rating
FV	Fantasy Violence	TV-Y7
V	Violence	TV-PG
S	Sexual Situation	TV-14
L	Coarse Language	TV-MA
D	Suggestive Dialogue	TV-PG, TV-14

Note:

- Blocked sub rating will appear beside the main rating category in "TV Rating" menu.
- You cannot block a sub rating (D, L, S or V) if the main rating is set to "View".
- Changing the category to "Block" or "View" automatically changes all its sub ratings to the same ("Block" or "View").

5 Use [Cursor ▲/▼] to select "New Password", then press [ENTER].

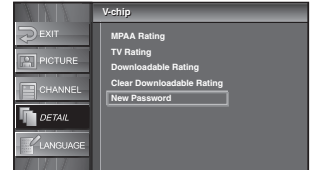

6 Press [the Number buttons] to enter the new 4-digit password.

- Enter password again in "Confirm password." entry field.

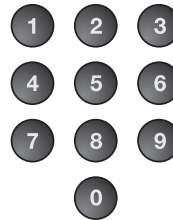

7 Press [SETUP] to exit.



Note:

- Make sure new password and confirm password must be exactly the same. If they are different, the space is cleared for reentering.
- Your password will be erased and return to the default (0000) when a power failure occurs. If you forget the password, unplug the power cord for 10 seconds to restore the password to 0000.

✓ HDMI Audio

You can set the method of sound input for the HDMI - IN jack.

- 1 Press **[SETUP]** to display the main menu.



- 2 Use **[Cursor ▲/▼]** to select "DETAIL", then press **[ENTER]**.



or



ENTER



- 3 Use **[Cursor ▲/▼]** to select "HDMI Audio", then press **[ENTER]**.



or



ENTER

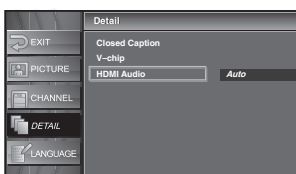

- 4 Use **[Cursor ▲/▼]** to select the desired sound input, then press **[ENTER]**.



or



ENTER

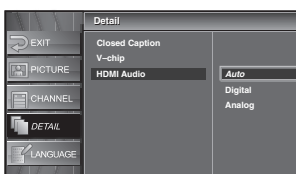

HDMI Audio	Auto	Select if you have connected both digital device to the HDMI - IN jack and analog device to the audio sources. Digital audio input signal will have priority.
	Digital	Select if you have connected digital device to the HDMI - IN jack for digital audio input signal.
	Analog	Select if you have connected analog device to the analog audio jacks for analog audio input signal.

- 5 Press **[SETUP]** to exit.



✓ Troubleshooting Guide

If the unit does not perform properly when operated as instructed in this owner's manual, check the following chart once before calling for service.

Symptom	Remedy
No power	<ul style="list-style-type: none"> • Be sure the power cord is plugged in. • If a power failure occurs, unplug the power cord for 30 minutes to allow the unit to reset itself.
No picture or sound	<ul style="list-style-type: none"> • Check if the power is on. • Check the outlet connection. • Check the antenna or cable connection to the main unit. • When the outside antenna is used, check the wire condition and connection. • View other TV channels. The problem might be limited to the broadcasting station. • Turn off the power and wait for about 1 minute, then turn it on again.
No color	<ul style="list-style-type: none"> • Check the antenna or cable connection to the main unit. • When the outside antenna is used, check the wire condition and connection. • View other TV channels. The problem might be limited to the broadcasting station. • Adjust the "Color" in the main menu.
Sound OK, picture poor	<ul style="list-style-type: none"> • Check the antenna or cable connection to the main unit. • When the outside antenna is used, check the wire condition and connection. • Electrical interference from nearby appliances may affect picture quality. • Adjust "Contrast" and "Brightness" in the main menu. • View other TV channels. The problem might be limited to the broadcasting station.
Picture distorted	<ul style="list-style-type: none"> • When the outside antenna is used, check the wire condition and connection. • View other TV channels. The problem might be limited to the broadcasting station.
Weak picture	<ul style="list-style-type: none"> • Check the antenna or cable connection to the main unit. • When the outside antenna is used, check the wire condition and connection. • Adjust "Contrast" and "Brightness" in the main menu. • View other TV channels. The problem might be limited to the broadcasting station.
Lines or streaks in picture	<ul style="list-style-type: none"> • When the outside antenna is used, check the wire condition and connection. • Electrical interference from nearby appliances may affect picture quality. • View other TV channels. The problem might be limited to the broadcasting station.
Picture blurred	<ul style="list-style-type: none"> • When the outside antenna is used, check the wire condition and connection. • View other TV channels. The problem might be limited to the broadcasting station.
Ghosts in picture	<ul style="list-style-type: none"> • Check the antenna or cable connection to the main unit. • When the outside antenna is used, check the wire condition and connection. • Electrical interference from nearby appliances may affect picture quality. • View other TV channels. The problem might be limited to the broadcasting station.
Bars on screen	<ul style="list-style-type: none"> • When the outside antenna is used, check the wire condition and connection. • Electrical interference from nearby appliances may affect picture quality.
Picture rolls vertically	<ul style="list-style-type: none"> • When the outside antenna is used, check the wire condition and connection. • Electrical interference from nearby appliances may affect picture quality. • View other TV channels. The problem might be limited to the broadcasting station.
Different color marks on screen	<ul style="list-style-type: none"> • Move the unit away from nearby electric appliances. Turn off the power and wait 30 minutes before turning it back on. • View other TV channels. The problem might be limited to the broadcasting station.
Poor reception on some channels	<ul style="list-style-type: none"> • Check the antenna or cable connection to the main unit. • When the outside antenna is used, check the wire condition and connection. • Electrical interference from nearby appliances may affect picture quality. • View other TV channels. The problem might be limited to the broadcasting station.
Picture OK, sound poor	<ul style="list-style-type: none"> • View other TV channels. The problem might be limited to the broadcasting station.
No reception of digital signals	<ul style="list-style-type: none"> • Make sure auto channel scan has been completed. (Refer to "Auto Channel Scan" on page 13.) Auto channel scan must be completed when you set up the unit for the first time or move it to a location where previously unavailable channels are broadcast. • The selected channel may not be broadcasting. • When auto channel scan is interrupted and not completed, some channels will not be received. Make sure to complete. (Refer to "Auto Channel Scan" on page 13.)

Symptom	Remedy
The entered channel number changes automatically	<ul style="list-style-type: none"> • Many digital channels have alternate channel numbers. The unit changes the numbers automatically to the ones signifying the broadcasting stations. These are the numbers used for analog broadcasts.
Remote control does not work	<ul style="list-style-type: none"> • Check the antenna or cable connection to the main unit. • Check the batteries of the remote control. • Check if there is an obstacle between the infrared sensor window and the remote control. • Test the signal output. If OK, then possible infrared sensor trouble. (Refer to "IR Signal Check" on page 34.) • Aim the remote control directly at the infrared sensor window on the front of the unit. • Reduce the distance to the unit. • Re-insert the batteries with their polarities (+/- signs) as indicated. • When there is an infrared-equipped device such as PC near this unit, it may interrupt the remote control signal of this unit. Move the infrared-equipped device away from this unit, change the angle of the infrared sensor or turn off the infrared communication function.
Problems with Closed Caption Feature	
Misspelled captions are displayed.	<ul style="list-style-type: none"> • Closed captioning production companies may broadcast programs without correcting the misspelling in a live broadcast.
Captions are not entirely displayed, or captions are delayed behind the dialogue.	<ul style="list-style-type: none"> • Captions that are delayed a few seconds behind the actual dialogue are common for live broadcasts. Most captioning production companies can display a dialogue to a maximum of 220 words per minute. If a dialogue exceeds that rate, selective editing is used to insure that the captions remain up-to-date with the current TV screen dialogue.
Captions are displayed as a white box. No caption is displayed in the closed caption-supported program.	<ul style="list-style-type: none"> • Interference from buildings or weather conditions may cause captioning to be incomplete. • Broadcasting station may shorten the program to insert advertisement. The closed caption decoder cannot read the information of the shortened program.
No caption is displayed when playing the videotape containing captions.	<ul style="list-style-type: none"> • The videotape may be illegally copied, or the caption signal might not have been read during copying.
Black box is displayed in the TV screen.	<ul style="list-style-type: none"> • The text mode is selected for caption. Select "CC1", "CC2", "CC3", "CC4" or "Off".

Note:

- The LCD panel is manufactured to provide many years of useful life. Occasionally a few non active pixels may appear as a fixed point of blue, green or red. This is not to be considered a defect in the LCD screen.
- Some functions are not available in specific modes, but this is not a malfunction. Read the description in this owner's manual for more details on correct operations.

✓ Glossary

NTSC

Acronym that stands for Advanced Television Systems Committee and the name of the digital broadcasting standards.

Aspect Ratio

The width of a TV screen relative to its height. Conventional TVs are 4:3 (in other words, the TV screen is almost square); widescreen models are 16:9 (the TV screen is almost twice as wide as its height).

Component Video

This is a video signal format that conveys each of 3 principal colors of light (red, blue and green) through different signal lines. This allows the viewers to experience picture colors as original as it is. There are several signal formats, including Y / Pb / Pr and Y / Cb / Cr.

Dolby Digital

The system developed by Dolby Laboratories to compress digital sound. It offers stereo sound (2ch) or multi-channel audio.

HDMI (high-definition multimedia interface)

Interface that supports all uncompressed, digital audio/video formats including set-top box, DVD player or digital television, over a single cable.

HDTV (high definition TV)

Ultimate digital format that produces high resolution and high picture quality.

NTSC

Acronym that stands for National Television Systems Committee and the name of the current analog broadcasting standards.

Password

A stored 4-digit number that allows access to parental control features.

SAP (secondary audio program)

Second-audio channel delivered separately from main-audio channel. This audio channel is used as an alternate in bilingual broadcasting.

SDTV (standard definition TV)

Standard digital format that is similar to the NTSC picture quality.

S-video

Offers higher quality images by delivering each signal, color (c) and luminance (y) independently of each other through separate cables.

✓ Maintenance

Cabinet Cleaning

- Wipe the front panel and other exterior surfaces of the unit with a soft cloth immersed in lukewarm water and wrung dry.
- Never use a solvent or alcohol. Do not spray insecticide liquid near the unit. Such chemicals may cause damage and discoloration to the exposed surfaces.

Panel Cleaning

Wipe the panel of the unit with a soft cloth. Before cleaning the panel, disconnect the power cord.

Servicing

Should your unit become inoperative, do not try to correct the problem yourself. There are no user serviceable parts inside. Turn off the unit, unplug the power cord and call our toll free customer support line found on the cover of this manual to locate an authorized service center.

IR Signal Check

If the remote control is not working properly, you can use an AM radio or digital camera (including a cellular phone with built-in camera) to see if it is sending out an infrared signal.

- With an AM radio:

Tune the AM radio station to a non-broadcasting frequency. Point the remote control towards it, push any button and listen. If the sound from the radio flutters, it is receiving the remote control's infrared signal.

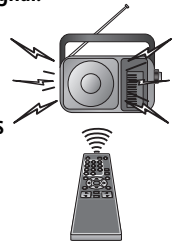

- With a digital camera



(including built-in cell phone cameras): Point a digital camera towards the remote control. Push any button on the remote control and look through the digital camera. If the infrared light appears through the camera, the remote control is working.

✓ Cable Channel Designations

If you subscribe to cable TV, the channels are displayed as 1-135. Cable companies often designate channels with letters or letter-number combinations. Please check with your local cable company. The following is a chart of common cable channel designations.

CATV channel	5A	2	3	4	5	6	7	8	9	10	11	12	13	A	B	C	D	E	F	G	H
TV Display	1	2	3	4	5	6	7	8	9	10	11	12	13	14	15	16	17	18	19	20	21
CATV channel	I	J	K	L	M	N	O	P	Q	R	S	T	U	V	W	W+1	W+2	W+3	W+4	W+5	W+6
TV Display	22	23	24	25	26	27	28	29	30	31	32	33	34	35	36	37	38	39	40	41	42
CATV channel	W+7	W+8	W+9	W+10	W+11	W+12	W+13	W+14	W+15	W+16	W+17	W+18	W+19	W+20	W+21	W+22	W+23	W+24	W+25	W+26	W+27
TV Display	43	44	45	46	47	48	49	50	51	52	53	54	55	56	57	58	59	60	61	62	63
CATV channel	W+28	W+29	W+30	W+31	W+32	W+33	W+34	W+35	W+36	W+37	W+38	W+39	W+40	W+41	W+42	W+43	W+44	W+45	W+46	W+47	W+48
TV Display	64	65	66	67	68	69	70	71	72	73	74	75	76	77	78	79	80	81	82	83	84
CATV channel	W+49	W+50	W+51	W+52	W+53	W+54	W+55	W+56	W+57	W+58	A-5	A-4	A-3	A-2	A-1	W+59	W+60	W+61	W+62	W+63	W+64
TV Display	85	86	87	88	89	90	91	92	93	94	95	96	97	98	99	100	101	102	103	104	105
CATV channel	W+65	W+66	W+67	W+68	W+69	W+70	W+71	W+72	W+73	W+74	W+75	W+76	W+77	W+78	W+79	W+80	W+81	W+82	W+83	W+84	W+85
TV Display	106	107	108	109	110	111	112	113	114	115	116	117	118	119	120	121	122	123	124	125	126
CATV channel	W+86	W+87	W+88	W+89	W+90	W+91	W+92	W+93	W+94												
TV Display	127	128	129	130	131	132	133	134	135												

✓ General Specifications

TV format: ATSC / NTSC-M TV standard

Closed caption system:

\$15.122/FCC (digital CC) \$15.119/FCC (analog CC)

Channel coverage (ATSC/NTSC):

Terrestrial VHF: 2~13 **UHF:** 14~69

CATV 2~13, A~W, W+1~W+94 (analog W+1~W+84),
A-5~A-1, 5A

Tuning system: Channel frequency synthesized tuning system

Channel access: Direct access keyboard,

Programmable scan, and up/down

✓ Electrical Specification

Sound output: 5W, 16Ω x 2

✓ Other Specifications

Terminals:

Antenna input: VHF/UHF/CATV 75Ω unbalanced (F-type)

S-video input: Mini DIN 4-pin jack x 2 **Y:** 1Vp-p (75Ω)

C: 286mVp-p (75Ω)

Video input: RCA jack x 2 **1Vp-p (75Ω)**

Audio input: RCA jack (L/R) x 10 **2V rms**

Component video input:
RCA jack x 6

Y: 1Vp-p (75Ω)

Pb: 700mVp-p (75Ω)

Pr: 700mVp-p (75Ω)

HDMI input: HDMI 19pin x 1

Coaxial digital audio output:

RCA jack x1 500mVp-p (75Ω)

Analog audio output:
RCA jack x2

Remote control: Digital encoded infrared light system

Operating temperature:

41°F (5°C) to 104°F (40°C)

Power requirements:

120V AC +/- 10%, 60Hz +/- 0.5%

Power consumption (maximum):

155W

LCD: 26 inches wide XGA panel

Dimensions: <Without stand>

H: 20.3 inches (515mm)

W: 27.4 inches (696mm)

D: 5.0 inches (126.5mm)

<With stand>

H: 21.9 inches (555mm)

W: 27.4 inches (696mm)

D: 10.3 inches (260mm)

Weight: 28.7 lbs. (13.0kg)

- Designs and specifications are subject to change without notice and without our legal obligation.
- If there is a discrepancy between languages, the default language will be English.



LIMITED WARRANTY

This form describes the protection You will have under this Limited Warranty.

LIMITED WARRANTY PERIOD:

This Limited Warranty begins on the date of purchase of the Covered Product and continues for a period of six months.

WHAT IS COVERED:

Meijer will pay the cost of labor and repair or replacement parts in the event Your Covered Product fails to operate as a result of a mechanical or electrical failure caused by defects in workmanship and/or materials. A mechanical or electrical failure caused by a direct result of a power surge is also covered. Parts will be replaced with those of like kind and quality, and may be new or remanufactured. If the Covered Product cannot be repaired, if the cost of the repair exceeds the original purchase price or if parts are not available due to the age of the Covered Product or discontinued by the manufacturer, the Covered Product will be replaced with a product of similar features.

WHERE YOU ARE COVERED:

Coverage under this Limited Warranty is limited to the United States of America, including the District of Columbia. It does not include any Canadian or U.S. Territories including Guam, Puerto Rico, or U.S. Virgin Islands.

WHAT IS NOT COVERED:

- PRODUCTS NOT ORIGINALLY COVERED BY A MANUFACTURER'S WARRANTY;
- ITEMS THAT ARE STILL COVERED BY THE MANUFACTURER'S WARRANTY, REGARDLESS OF WHETHER THE MANUFACTURER HONORS SUCH WARRANTY;
- PERIODIC CHECKUPS AND/OR PREVENTIVE MAINTENANCE AS DIRECTED BY THE MANUFACTURER EXCEPT AS PROVIDED HEREIN;
- INHERENT PRODUCT DEFECTS THAT ARE THE RESPONSIBILITY OF THE MANUFACTURER OR PARTS FAILURE DUE TO A MANUFACTURER'S RECALL;
- ANY AND ALL PRE-EXISTING CONDITIONS THAT OCCUR PRIOR TO THE EFFECTIVE DATE OF THIS LIMITED WARRANTY AND/OR ANY COSTS TO REPAIR ANY PRODUCT SOLD "AS-IS" INCLUDING BUT NOT LIMITED TO FLOOR MODELS, DEMONSTRATION MODELS, ETC;
- PARTS OR REPAIRS DUE TO NORMAL WEAR AND TEAR AND ITEMS NORMALLY DESIGNED TO BE PERIODICALLY REPLACED BY THE PURCHASER DURING THE COVERED PRODUCT'S LIFE, INCLUDING BUT NOT LIMITED TO BATTERIES, LIGHT BULBS, ETC.;
- DAMAGE FROM ACCIDENT, ABUSE, MISUSE, MISHANDLING, INTRODUCTION OF FOREIGN OBJECTS INTO THE COVERED PRODUCT, UNAUTHORIZED MODIFICATIONS OR ALTERATIONS TO A COVERED PRODUCT, FAILURE TO FOLLOW THE MANUFACTURER'S INSTRUCTIONS, AND EXTERNAL CAUSES INCLUDING THIRD PARTY ACTIONS, FIRE, THEFT, INSECTS, ANIMALS, EXPOSURE TO WEATHER CONDITIONS, WINDSTORM, SAND, DIRT, HAIL, EARTHQUAKE, FLOOD, WATER, ACTS OF GOD OR CONSEQUENTIAL LOSS OF ANY NATURE;
- LOSS OR DAMAGE CAUSED BY WAR, INVASION OR ACT OF FOREIGN ENEMY, HOSTILITIES, CIVIL WAR, REBELLION, RIOT, STRIKE, LABOR DISTURBANCE, LOCKOUT, OR CIVIL COMMOTION;
- INCIDENTAL, CONSEQUENTIAL OR SECONDARY DAMAGES OR DELAY IN RENDERING SERVICE UNDER THIS LIMITED WARRANTY, OR LOSS OF USE DURING THE PERIOD THAT THE COVERED PRODUCT IS AT AN AUTHORIZED SERVICE CENTER OR OTHERWISE AWAITING PARTS;
- ANY PRODUCT USED IN A COMMERCIAL SETTING OR RENTAL BASIS;
- FAILURES THAT OCCUR OUTSIDE OF THE 50 STATES OF THE UNITED STATES OF AMERICA, INCLUDING THE DISTRICT OF COLUMBIA;
- NONFUNCTIONAL OR AESTHETIC PARTS INCLUDING BUT NOT LIMITED TO PLASTIC PARTS, KNOBS, ROLLERS, BASKETS, SCRATCHES, PEELING AND DENTS;
- UNAUTHORIZED REPAIRS AND/OR PARTS;
- COST OF INSTALLATION, SET-UP, DIAGNOSTIC CHARGES, REMOVAL OR REINSTALLATION OF THE COVERED PRODUCT, EXCEPT AS PROVIDED HEREIN;
- ACCESSORIES USED IN CONJUNCTION WITH A COVERED PRODUCT;
- ANY LOSS OTHER THAN A COVERED BREAKDOWN OF THE COVERED PRODUCT;
- SERVICE WHERE NO PROBLEM CAN BE FOUND;
- BREAKDOWNS WHICH ARE NOT REPORTED WITHIN THE TERM OF THIS LIMITED WARRANTY;
- IMPROPER INSTALLATION OF COMPONENTS OR PERIPHERALS;
- CORRUPTION OF ANY RECORDING MEDIA, INCLUDING ANY PROGRAM, DATA OR SETUP INFORMATION RESIDENT ON ANY HARD DRIVES AND INTERNAL OR EXTERNAL REMOVABLE STORAGE DEVICES, AS A RESULT OF THE MALFUNCTIONING OR DAMAGE OF AN OPERATING PART, OR AS A RESULT OF ANY REPAIRS OR REPLACEMENT UNDER THIS LIMITED WARRANTY;
- DAMAGE TO CLOTHING;
- COLOR FADING OF PICTURE FOR ANY TELEVISION;
- BURNED-IN PHOSPHOR (INCLUDING IMAGE GHOSTING), PIXEL BURNOUT NOT IN ACCORDANCE WITH THE MANUFACTURER'S SPECIFICATIONS.

WHAT TO DO WHEN YOUR PRODUCT FAILS TO OPERATE:

- Call the 24-hour customer service toll-free number at (866) 845-9436.

Many oversights, which are not covered under this Limited Warranty, can be due to simple circumstances such as the Covered Product not being switched on, being unplugged, or a fuse blown at the junction box. For a Covered Product that uses batteries as the primary power supply, or a remote control unit, please check that the batteries do not need replacing or recharging.

SERVICE DELIVERABLES:

There is no deductible required to obtain service for Your Covered Product.

OTHER PROVISIONS:

Limit of Liability:

The limit of liability under this Limited Warranty is the least of the cost of (1) the purchase price of the Covered Product excluding tax and delivery costs or (2) authorized repairs not to exceed the purchase price of the Covered Product or (3) replacement of the Covered Product with similar features or (4) reimbursement for authorized repairs or replacement. Upon replacement, there is no longer any obligation for the replaced product under this Limited Warranty.

Limitations of Implied Warranty:

All Implied Warranties which may arise under state law, including all Implied Warranties of Merchantability or Fitness for a particular purpose, are limited to the duration of this Warranty and do not cover incidental or consequential damages. Some states do not allow limitations on how long an Implied Warranty lasts or the exclusion of incidental or consequential damages, so the above limitations or exclusions may not apply to You. This Warranty gives You specific legal rights, and You may also have other rights which vary from state to state.

Transferability and Renewals:

This Limited Warranty is not transferable or renewable.

Subrogation:

If We pay for a loss, We may require You to assign Us Your rights of recovery against others. We will not pay for a loss if You impair these rights to recover. Your rights to recover from others may not be waived.

Arbitration:

In the event of a disagreement between You and Us concerning costs, either of us may make a written demand for arbitration. This must be done within sixty (60) days after the day You filed Your claim. Each of us will select an arbitrator. The two arbitrators will select an umpire. Each of us will pay the expenses of the arbitrator We select. The expenses of the umpire will be shared equally. Unless both of us agree otherwise, arbitration will take place in the county and state in which You live. Local rules apply. A majority decision will be binding.

Dist. by Wholesale Merchandisers, Inc., 2929 Walker, N.W., Grand Rapids, MI 49544

Free Manuals Download Website

<http://myh66.com>

<http://usermanuals.us>

<http://www.somanuals.com>

<http://www.4manuals.cc>

<http://www.manual-lib.com>

<http://www.404manual.com>

<http://www.luxmanual.com>

<http://aubethermostatmanual.com>

Golf course search by state

<http://golfingnear.com>

Email search by domain

<http://emailbydomain.com>

Auto manuals search

<http://auto.somanuals.com>

TV manuals search

<http://tv.somanuals.com>