

OWNER'S MANUAL



VIDEO CASSETTE PLAYER FP206G

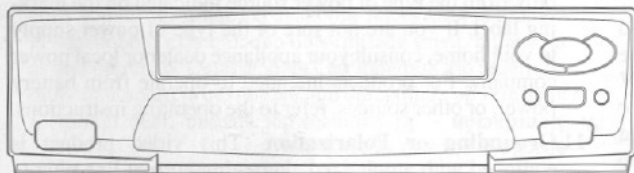

TABLE OF CONTENTS

IMPORTANT SAFEGUARDS	2
PRECAUTIONS.....	4
FEATURES	5
SUPPLIED ACCESSORIES.....	5
OPERATING CONTROLS & FUNCTIONS.....	6
PREPARATION FOR USE.....	8
CABLE CONNECTIONS.....	8
SETTING A VIDEO CHANNEL	9
INSTALLING THE BATTERIES.....	9
A/V TERMINALS	9
PLUG THE POWER CORD.....	10
USING THE POWER CORD	10
USING THE DC CABLE	10
VIDEO CASSETTE TAPE INFORMATION	11
PRECAUTIONS.....	11
THREE DIFFERENT TAPE SPEEDS.....	11
INSERTING A CASSETTE.....	11
REMOVING A CASSETTE.....	11
PLAYBACK	12
NORMAL PLAYBACK	12
SPECIAL PLAYBACK.....	14
REPEAT PLAY	14
RENTAL SELECTOR	14
COPYING A VIDEO TAPE.....	15
TO MONITOR THE RECORDING.....	15
TROUBLESHOOTING GUIDE.....	16
MAINTENANCE	16
SERVICING.....	16
CABINET CLEANING.....	16
AUTO HEAD CLEANING.....	16
SPECIFICATIONS.....	17
WARRANTY.....	18

If you need additional assistance for set-up or operating
after reading owner's manual, please call
TOLL FREE : 1-800-242-7158 (Eastern time 9:00AM-4:30PM / Monday - Friday).

VHS

Please read before using this equipment.

WARNING:

TO REDUCE THE RISK OF FIRE OR ELECTRIC SHOCK, DO NOT EXPOSE THIS APPLIANCE TO RAIN OR MOISTURE.



CAUTION

RISK OF ELECTRIC SHOCK
DO NOT OPEN



CAUTION: TO REDUCE THE RISK OF ELECTRIC SHOCK, DO NOT REMOVE COVER (OR BACK). NO USER SERVICEABLE PARTS INSIDE. REFER SERVICING TO QUALIFIED SERVICE PERSONNEL.



THIS SYMBOL INDICATES THAT DANGEROUS VOLTAGE CONSTITUTING A RISK OF ELECTRIC SHOCK IS PRESENT WITHIN THIS UNIT.



THIS SYMBOL INDICATES THAT THERE ARE IMPORTANT OPERATING AND MAINTENANCE INSTRUCTIONS IN THE LITERATURE ACCOMPANYING THE APPLIANCE.

The caution marking is located on the rear of the cabinet.

IMPORTANT SAFEGUARDS

- 1. Read instructions**-All the safety and operating instructions should be read before the appliance is operated.
- 2. Retain Instructions**-The safety and operating instructions should be retained for future reference.
- 3. Heed Warnings**-All warnings on the appliance and in the operating instructions should be adhered to.
- 4. Follow Instructions**-All operating and use instructions should be followed.

5. Cleaning-Unplug this video product from the wall outlet before cleaning. Do not use liquid cleaners or aerosol cleaners. Use a damp cloth for cleaning.

EXCEPTION: A product that is meant for uninterrupted service and, that for some specific reason, such as the possibility of the loss of an authorization code for a CATV converter, is not intended to be unplugged by the user for cleaning or any other purpose, may exclude the reference to unplugging the appliance in the cleaning description otherwise required in item 5.

6. Attachments-Do not use attachments not recommended by the video product manufacturer as they may cause hazards.

7. Water and Moisture-Do not use this video product near water, for example, near a bath tub, wash bowl, kitchen sink, or laundry tub, in a wet basement, or near a swimming pool, and the like.

8. Accessories-Do not place this video product on an unstable cart, stand, tripod, bracket, or table. The video product may fall, causing serious injury to a child or adult, and serious damage to the appliance. Use only with a cart, stand, tripod, bracket, or table recommended by the manufacturer, or sold with the video product. Any mounting of the appliance should follow the manufacturer's instructions and should use a mounting accessory recommended by the manufacturer. An appliance and cart combination should be moved with care. Quick stops, excessive force, and uneven surfaces may cause the ap-

PORTABLE CART WARNING
(Symbol provided by RETAC)



S3125A

pliance and cart combination to overturn.

- 9. Ventilation**-Slots and openings in the cabinet are provided for ventilation and to ensure reliable operation of the video product and to protect it from overheating, and these openings must not be blocked or covered. The openings should never be blocked by placing the video product on a bed, sofa, rug, or other similar surface. This video product should not be placed in a built-in installation such as a bookcase or rack unless proper ventilation is provided or the manufacturer's instructions have been adhered to.
- 10. Power Sources**-This video product should be operated only from the type of power source indicated on the marking label. If you are not sure of the type of power supply to your home, consult your appliance dealer or local power company. For products intended to operate from battery power, or other sources, refer to the operating instructions.
- 11. Grounding or Polarization**- This video product is equipped with a polarized alternating-current line plug (a plug having one blade wider than the other). This plug will fit into the power outlet only one way. This is a safety feature. If you are unable to insert the plug fully into the outlet, try reversing the plug. If the plug should still fail to fit, contact your electrician to replace your obsolete outlet. Do not defeat the safety purpose of the polarized plug.
- 12. Power Cord Protection**-Power supply cords should be routed so that they are not likely to be walked on or pinched by items placed upon or against them, paying particular attention to cords at plugs, convenience receptacles, and the point where they exit from the appliance.
- 13. Outdoor Antenna Grounding**-If an outside antenna or cable system is connected to the video product, be sure the antenna or cable system is grounded so as to provide some protection against voltage surges and built-up static charges. Article 810 of the National Electrical Code, ANSI/NFPA No. 70, provides information with regard to proper grounding of the mast and supporting structure, grounding of the lead-in wire to an antenna discharge unit, size of grounding conductors, location of antenna-discharge unit, connection to grounding electrodes, and requirements for the grounding electrode. (Fig. A)

FIGURE A

EXAMPLE OF ANTENNA GROUNDING AS PER NATIONAL ELECTRICAL CODE

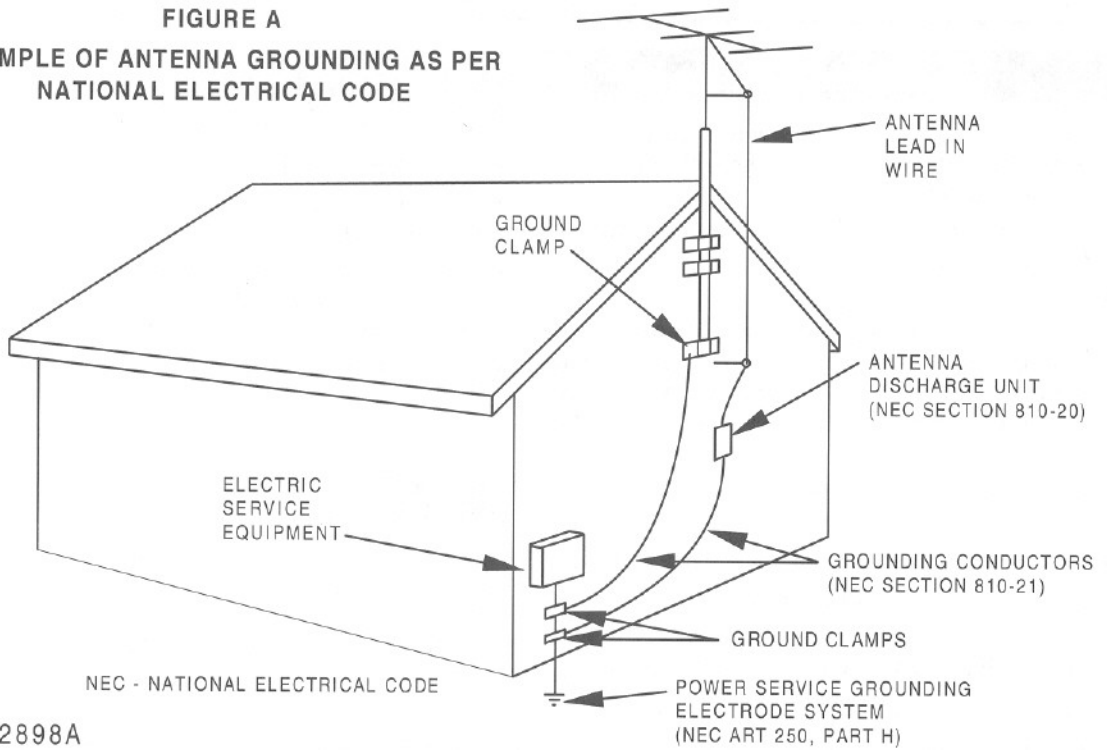

S2898A

14. Lightning-For added protection for this video product during a lightning storm, or when it is left unattended and unused for long periods of time, unplug it from the wall outlet and disconnect the antenna or cable system. This will prevent damage to the video product due to lightning and power-line surges.

15. Power Lines-An outside antenna system should not be located in the vicinity of overhead power lines or other electric light or power circuits, or where it can fall into such power lines or circuits. When installing an outside antenna system, extreme care should be taken to keep from touching such power lines or circuits as contact with them might be fatal.

16. Overloading-Do not overload wall outlets and extension cords as this can result in a risk of fire or electric shock.

17. Object and Liquid Entry-Never push objects of any kind into this video product through any openings as they may touch dangerous voltage points or short-out parts that could result in a fire or electric shock. Never spill liquid of any kind on the video product.

18. Servicing-Do not attempt to service this video product yourself as opening or removing covers may expose you to dangerous voltage or other hazards. Refer all servicing to qualified service personnel.

19. Damage Requiring Service-Unplug this video product from the wall outlet and refer servicing to qualified service personnel under the following conditions:

- a. When the power-supply cord or plug is damaged.
- b. If liquid has been spilled, or objects have fallen into the video product.
- c. If the video product has been exposed to rain or water.

- d. If the video product does not operate normally by following the operating instructions. Adjust only those controls that are covered by the operating instructions as an improper adjustment of other controls may result in damage and will often require extensive work by a qualified technician to restore the video product to its normal operation.
- e. If the video product has been dropped or damaged in any way.
- f. When the video product exhibits a distinct change in performance-this indicates a need for service.

20. Replacement Parts-When replacement parts are required, be sure the service technician has used replacement parts specified by the manufacturer or have the same characteristics as the original part. Unauthorized substitutions may result in fire, electric shock or other hazards.

21. Safety Check-Upon completion of any service or repairs to this video product, ask the service technician to perform safety checks to determine that the video product is in proper operating condition.

22. Heat-This video product should be situated away from heat sources such as radiators, heat registers, stoves, or other products (including amplifiers) that produce heat.

PRECAUTIONS

LOCATION

For safe operation and satisfactory performance of the VCP, keep the following in mind when selecting a place for its installation:

- Shield it from direct sunlight and keep it away from sources of intense heat.
- Avoid dusty or humid places.
- Avoid places with insufficient ventilation for proper heat dissipation. Do not block the ventilation holes at the top and bottom of the VCP. Do not place the unit on a carpet because this will block the ventilation holes.
- Install unit in a horizontal position.
- Avoid locations subject to strong vibration.
- Do not place the VCP near strong magnetic fields.
- Do not move the unit from a cold to a hot place or vice versa.
- Do not place the VCP directly on top of the TV.

AVOID THE HAZARDS OF ELECTRICAL SHOCK AND FIRE

- Do not handle the power cord with wet hands.
- Do not pull on the power cord when disconnecting it from AC wall outlet. Grasp it by the plug.
- If, by accident, water is spilled on the VCP, unplug the power cord immediately and take the unit to a Funai Authorized Service Center for servicing.
- Do not put your fingers or objects into the cassette holder.
- Do not place anything directly on top of the VCP.

DEW WARNING

Moisture condensation may occur inside the unit when it is moved from a cold place to a warm place, or after heating a cold room or under conditions of high humidity. In this case, the POWER indicator flashes. Do not use the VCP at least for 2 hours until its inside is dry.

FCC WARNING- This equipment may generate or use radio frequency energy. Changes or modifications to this equipment may cause harmful interference unless the modifications are expressly approved in the instruction manual. The user could lose the authority to operate this equipment if an unauthorized change or modification is made.

The serial number of this product may be found on the back of the VCP. No others have the same serial number as yours. You should record the number and other vital information here and retain this book as a permanent record of your purchase to aid identification in case of theft.

Date of Purchase	
Dealer Purchase from	
Dealer Address	
Dealer Phone No.	
Model No.	
Serial No.	

FEATURES

- **Dew sensor**– Indicates that moisture condensation may occur inside the VCP.
- **Two-way power**– Allows you to power the VCP with a standard household AC outlet or your vehicle's cigarette-lighter socket using the supplied DC cable.
- **Auto power on and off system**– Automatically turns the VCP on as you insert the cassette, turns off after auto-rewind, and ejects when the beginning of the tape is reached.
- **Auto play**– When you insert a pre-recorded tape, the VCP starts playback automatically.
- **Auto repeat**– Allows you to repeat a tape indefinitely without pressing the PLAY button.
- **Digital auto tracking** – Adjusts the tracking automatically for each tape you play.
- **Auto head cleaner**– Automatically clean heads as you insert or remove a cassette.
- **Rental play mode**– Improves playback picture quality of worn tapes, especially rental tapes.
- **2 Step picture search operation**– You can view a video program at a high speed or super high speed in either a forward or reverse direction in LP and SLP mode.
- **Still**– "Freeze" the picture at any time, for close viewing of a particular scene. Only tapes recorded in SLP mode will show a fairly clear picture.
- **Three different tape speeds : SP/LP/SLP**

SUPPLIED ACCESSORIES

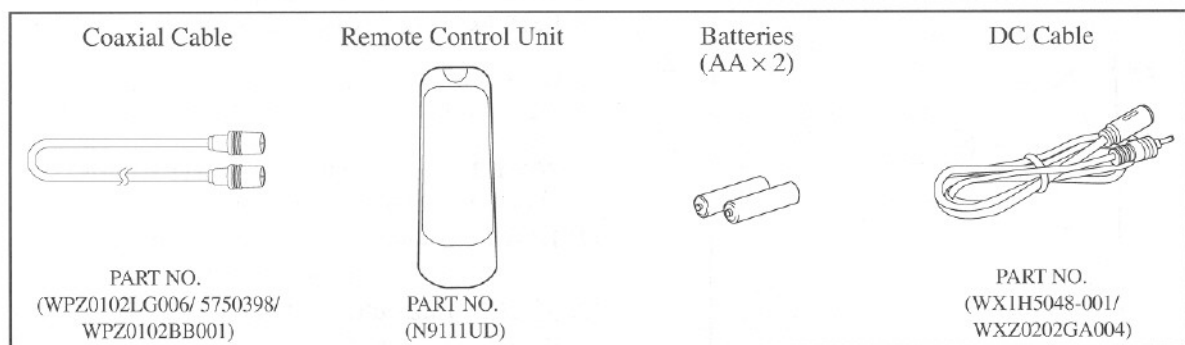

- If you need to replace these accessories, please refer to the PART NO. under the illustrations and contact the Funai parts department for ordering.

OPERATING CONTROLS & FUNCTIONS

—FRONT VIEW—

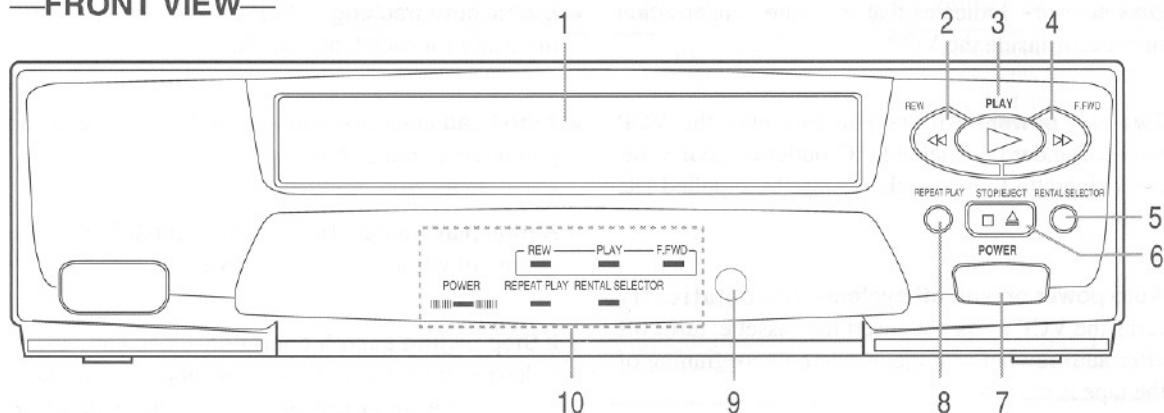

—REMOTE CONTROL VIEW—

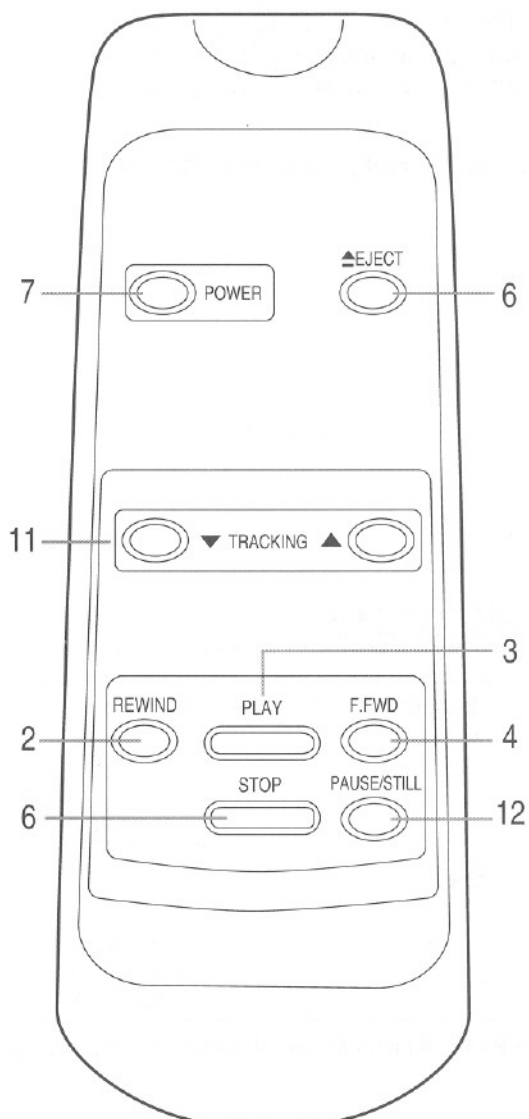

1. Cassette Compartment

2. REWIND button— Press to rewind the tape, or to view the picture rapidly in reverse during the playback mode. (Rewind Search)

3. PLAY button— Press to begin playback.

4. F.FWD button— Press to rapidly advance the tape, or view the picture rapidly in forward during playback. (Forward Search)

5. RENTAL SELECTOR button— Press to improve the playback picture quality of rental tapes.

6. STOP button— Press to stop the tape motion.

EJECT button— Press to remove a tape from the VCP.

7. POWER button— Press to turn VCP on and off.

8. REPEAT PLAY button— Press to repeat playback automatically.

9. Remote sensor window— Receives the infrared signals from the remote control.

10. INDICATORS

- **F.FWD**— Lights on during fast forwarding a tape.
- **PLAY**— Lights on during playback.
- **RENTAL SELECTOR**— Lights on when the Rental Selector is activated.
- **REW**— Lights on during rewinding a tape.
- **REPEAT PLAY**— Lights on when the Repeat Playback is activated.
- **POWER**— Indicates that the power is turned on. Flashes when the dew sensor works.

11. TRACKING buttons— Press to minimize video noise (lines or dots on screen) during playback.

12. PAUSE/STILL button— Press to temporarily view a still picture during playback.

REAR VIEW

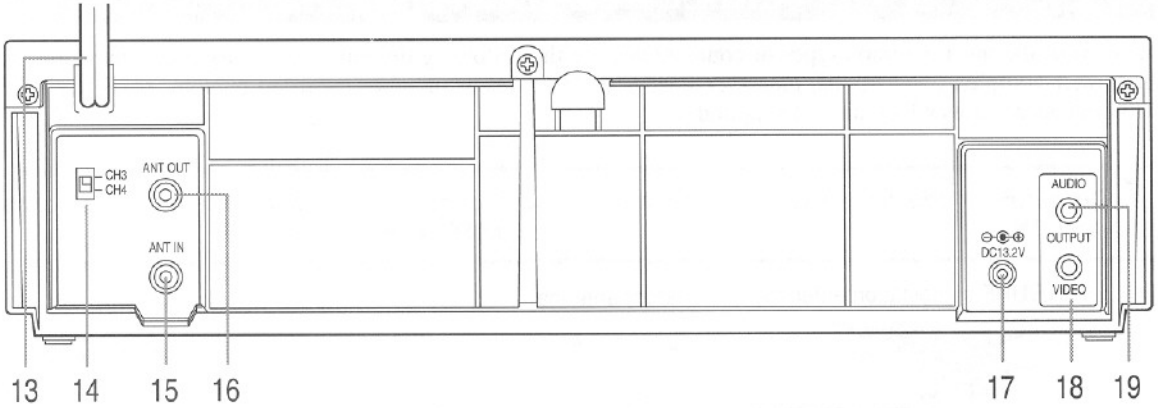

- 13. Power cord**– Connect to a standard AC outlet (120V/60Hz).
- 14. CH3/CH4 selector switch**– Use to select a video output channel (3 or 4) for playback from the VCP.
- 15. ANT IN terminal**– Connect to an antenna or CATV.
- 16. ANT OUT terminal**– Connect to an antenna input terminal of your TV.
- 17. DC 13.2V jack**– Connect to your vehicle's cigarette-lighter socket.
- 18. VIDEO OUTPUT jack**– Connect to a video input jack of your TV, video camera or a VCR.
- 19. AUDIO OUTPUT jack**– Connect to the audio input jack of your TV, audio equipment or a VCR.

PREPARATION FOR USE

CABLE CONNECTIONS

For some of the most common types of connections, see the following drawings. Use only one connection. For any further complex connections, please contact your local dealer or other qualified persons. (You may need additional accessories which are not supplied).

- 1 Disconnect the antenna or cable from your TV.
- 2 Connect the antenna or cable to the ANT.IN jack of the VCP.

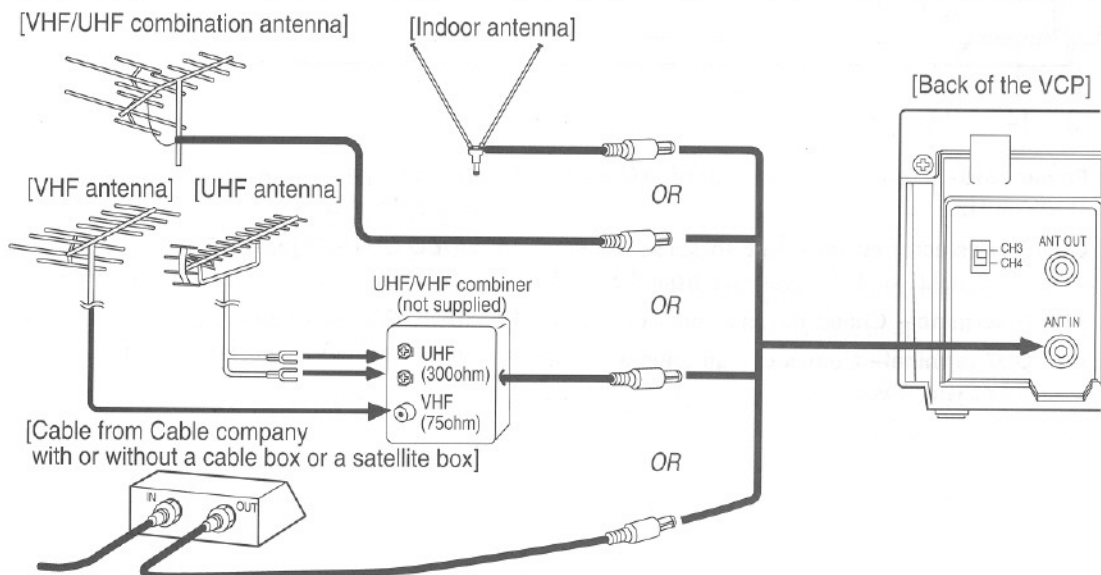

- 3 Connect one end of the coaxial cable (supplied) to the ANT.OUT jack of the VCP.
- 4 Connect the other end of the coaxial cable (supplied) to the UHF/VHF antenna jacks.

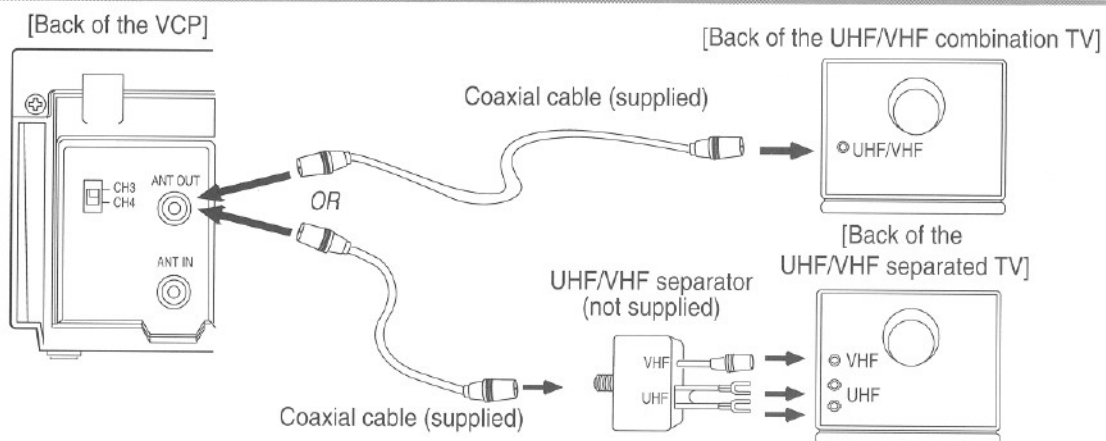

Note to CATV system installer

This reminder is provided to call the CATV system installer's attention to Article 820-40 of the NEC that provides guidelines for proper grounding and, in particular, specifies that the cable ground shall be connected to the grounding system of the building, as close to the point of cable entry as practical.

SETTING A VIDEO CHANNEL

If your TV does not have A/V terminals;

When the VCP is in the Playback mode, your TV will receive the signals from the VCP on either channel 3 or 4.

To use the VCP with your TV, set the selector switch to CH3 or CH4, whichever is not used or least used for normal broadcasts in your area. Then set your TV to that same channel.

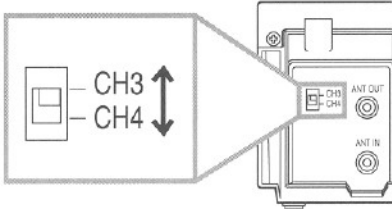

INSTALLING THE BATTERIES

- 1) Open the battery compartment cover by pressing the cover on the remote unit in the direction of the arrow.
- 2) Insert 2 "AA" penlight batteries into the battery compartment in the direction indicated by the polarity (+/-) markings.
- 3) Replace the cover.

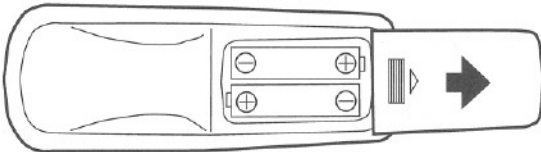

A/V TERMINALS

If your TV has A/V input jacks, you may connect the VCP's AUDIO/VIDEO OUTPUT jacks to the audio/video input jacks on back of your TV.

Direct audio/video connections usually result in a better picture and sound quality for tape playback. Please see your TV's owner's manual for A/V input connections.

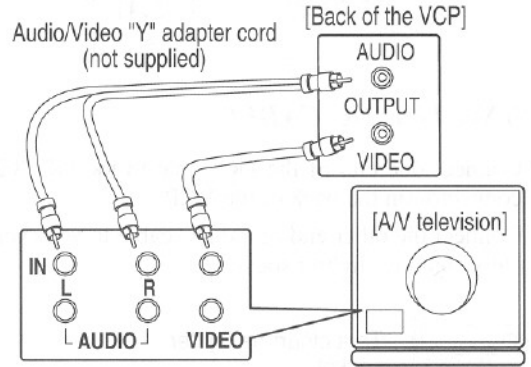

PLUG THE POWER CORD

USING THE POWER CORD

Plug the power cord into a standard AC outlet.

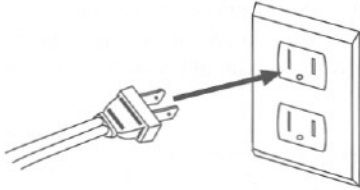

USING THE DC CABLE

- 1) Connect one end of the DC cable to the DC13.2V connector on the back of the VCP.
- 2) Connect the other end of the DC cable to your vehicle's cigarette-lighter socket.

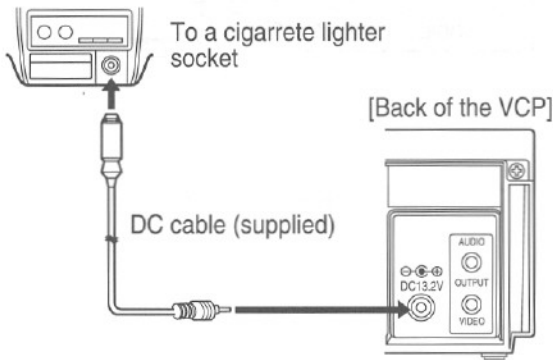

WARNING: Never watch the video program while driving.

CAUTION: After you finish using the VCP, unplug the DC cable from the cigarette-lighter socket.

NOTES:

- Be sure your vehicle has a 13.2-volt, negative-ground electrical system.
- Be sure you use only the supplied DC cable. Using another cord could damage the VCP.
- Be sure the socket is free of ashes and other debris.
- Be sure to push the DC cable's plug completely into the cigarette-lighter socket.
- Disconnect the DC cable from the cigarette-lighter socket first, before you unplug it from the VCP.
- You must disconnect the DC cable from the VCP before you can use AC power.
- Be sure to replace fuse with only the same type, 5A, 250V.

VIDEO CASSETTE TAPE INFORMATION

This VCP will operate with any cassette that has the VHS mark. For best results, we recommend the use of high-quality tapes. *Do not use poor quality or damaged tapes.*

PRECAUTIONS

- Avoid moisture. Moisture condensation may occur on the tape if it is moved from a cold place to a warm place. Before using a tape with these conditions, to avoid a damage of the tape and the VCP, wait until the tape has warmed to room temperature and the moisture has evaporated.
- Avoid extreme heat, high humidity and magnetic fields.
- Do not tamper with the cassette mechanism.
- Do not touch the tape with your fingers.

THREE DIFFERENT TAPE SPEEDS

Before recording, select the tape speed from : **SP mode** (Standard Play), **LP mode** (Long Play) or **SLP mode** (Super Long Play).

The table below shows the maximum recording/playback time using T60, T120 or T160 tapes in each mode.

Tape Speed	Recording/Playback Time			
	Type of tape	T60	T120	T160
SP mode		1 hour	2 hours	2-2/3 hours
LP mode		2 hours	4 hours	5-1/3 hours
SLP mode		3 hours	6 hours	8 hours

INSERTING A CASSETTE

Insert the cassette in the direction as shown. Push in gently, but continuously, on the center-back of the cassette until it is drawn into the VCP.

The VCP will automatically turn on.

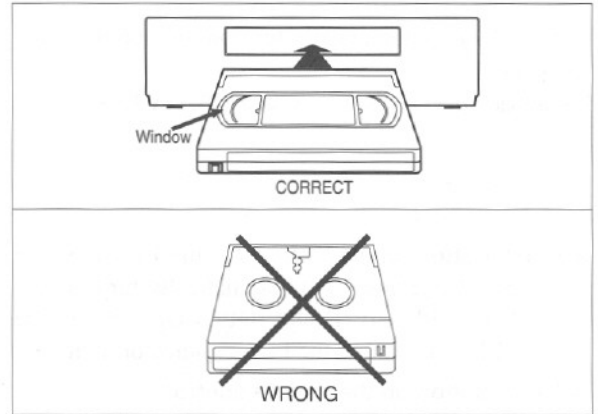

REMOVING A CASSETTE

- 1) In the Stop mode, press the **EJECT** button on the remote control or press the **STOP/EJECT** button on the VCP. The cassette will be ejected.
- 2) Pull the cassette out of the cassette compartment.
- 3) Store the cassette in its case as shown.

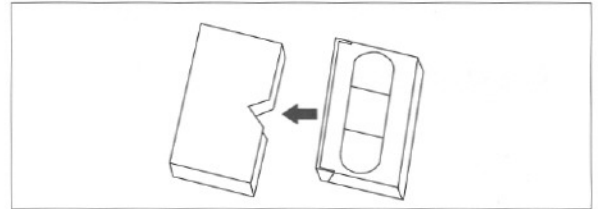

NORMAL PLAYBACK

1 Turn on the TV

Turn on the TV and set the TV channel to the same video output channel as located on the back of the the VCP. (CH 3 or 4)

2 Insert a prerecorded tape

The VCP will automatically turn on and the playback will start.

If playback does not start, press the **PLAY** button.

If a tape is already in the the VCP with power off

- **Using button on the VCP-** press the **PLAY** button on the VCP. Power will automatically turn on and playback will start (Direct Button Operation). The **POWER** indicator and the **PLAY** indicator light on.
- **Using button on the remote control-** press the **POWER** button to turn on the VCP, and then press the **PLAY** button on the remote control.

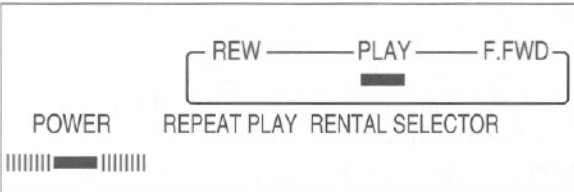

3 To stop playback

press the **STOP** button.

PICTURE SEARCH

This feature is useful in finding or skipping over a particular scene on a tape. In this mode, the sound will be muted.

- 1) You may view a video tape at a high speed in either a forward or reverse direction by pressing the **F.FWD** or **REW** button. (in the SP/LP/SLP modes)
- 2) Depress it again, the the VCP will now search in super high speed. (in the LP / SLP modes only)
- 3) Press the **PLAY** button to return to normal speed.

STILL PICTURE

You can view a still picture on the screen during playback (the Still mode). Press the **PAUSE/STILL** button during playback. Press the **PLAY** button to return to playback.

NOTES:

- Usually there will be video "noise" lines (black and white streaks or dots) on the screen. This is normal. If the tape was originally recorded in SP or LP mode, the still picture will, in addition to the "noise" lines, be black and white. **This is not a fault of the machine but merely a by-product of the technology involved in producing a the VCP with LP mode.**
- If it is left in the Still mode for more than five minutes, the the VCP will automatically switch to the Stop mode.

NOISE CANCEL (in the Still mode)

This feature allows you to reposition or reduce the noise lines of a still picture.

Press the **PAUSE/STILL** button repeatedly so that the noise lines change position on the screen and you can see the picture in its entirety without distracting noise lines.

NOTE: This feature can be activated **ONLY** when you use a tape recorded in the SLP mode.

VERTICAL HOLD CONTROL

When the picture begins to vibrate vertically, stabilize the picture by pressing the **TRACKING ▲** or **▼** button in the Still mode.

NOTES:

- If there are video noise lines on the screen, reposition or reduce them. Refer to "NOISE CANCEL".
- When the picture is distorted or rolling vertically, adjust vertical hold control on your TV.
- Some newer TV's do not have a user adjustable vertical hold control.

TRACKING ADJUSTMENT

- Tracking adjustment will be set automatically (Digital Auto Tracking function) when you start playback.
- When playing pre-recorded tapes or tapes recorded on units other than your own, noise lines (black and white streaks) may appear on the playback picture. If this occurs, you can adjust the tracking control manually by pressing the **TRACKING ▲** or **▼** button on the remote control until the streaks disappear.

To return to the Digital Auto Tracking function, stop the tape once and start playback again.

- To set center position, stop playback once and begin playback again.

AUTO REWIND

When the end of a tape is reached during playback or fast-forward, the tape will automatically rewind to the beginning. After that, the VCP will eject the tape and turn itself to off.

NOTE: This function is operative when Repeat Play is set to off.

SPECIAL PLAYBACK

REPEAT PLAY

The VCP has the auto repeat function that allows you to repeat a tape indefinitely without touching the PLAY button.

1 Turn on the TV

Turn on the TV and set the TV channel to the same video output channel as located on the back of the the VCP. (CH 3 or 4)

2 Insert a prerecorded tape

The VCP will automatically turn on and the playback will start.

If playback does not start, press the **PLAY** button.

3 To set repeat play

Press the **REPEAT PLAY** button on the VCP so that the REPEAT PLAY indicator lights on.

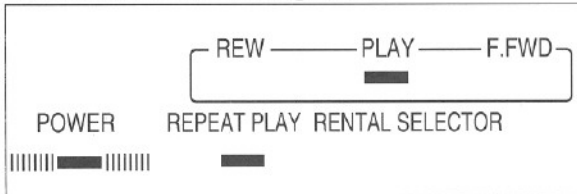

4 To stop playback

Press the **STOP** button.

5 To clear repeat play

Press the **REPEAT PLAY** button on the VCP so that the REPEAT PLAY indicator light goes off.

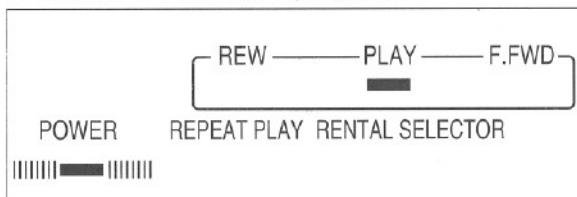

NOTE: Always turn the Repeat Play function to off when not in use.

RENTAL SELECTOR

This function enables you to improve the picture quality when playing back worn cassettes such as those rented from a video shop.

1 Turn on the TV

Turn on the TV and set the TV channel to the same video output channel as located on the back of the the VCP. (CH 3 or 4)

2 Insert a prerecorded tape

The VCP will automatically turn on and the playback will start.

If playback does not start, press the **PLAY** button.

3 To set rental selector

Press the **RENTAL SELECTOR** button on the VCP so that the RENTAL SELECTOR indicator lights on.

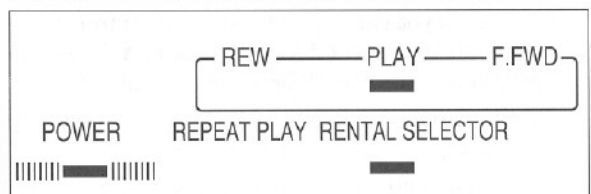

RENTAL SELECTOR indicator	Picture
Lights on	Soft
Light off	Normal

4 To stop playback

Press the **STOP** button.

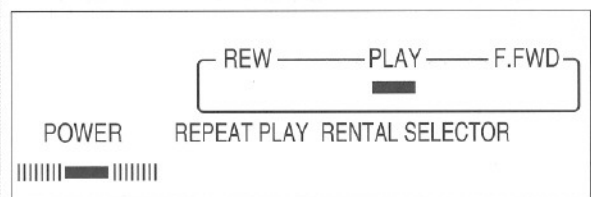

5 To clear rental selector

Press the **RENTAL SELECTOR** button on the VCP so that the RENTAL SELECTOR indicator light goes off.

NOTE: Always turn the Rental Selector function to off when not in use.

COPYING A VIDEO TAPE

You can make copies of video tapes made by friends or relatives for your enjoyment.

WARNING: Unauthorized recordings of copyrighted video tapes may be an infringement of copyright laws. Connect the editing (recording) VCR, source (playing) VCR and your TV using the following diagram.

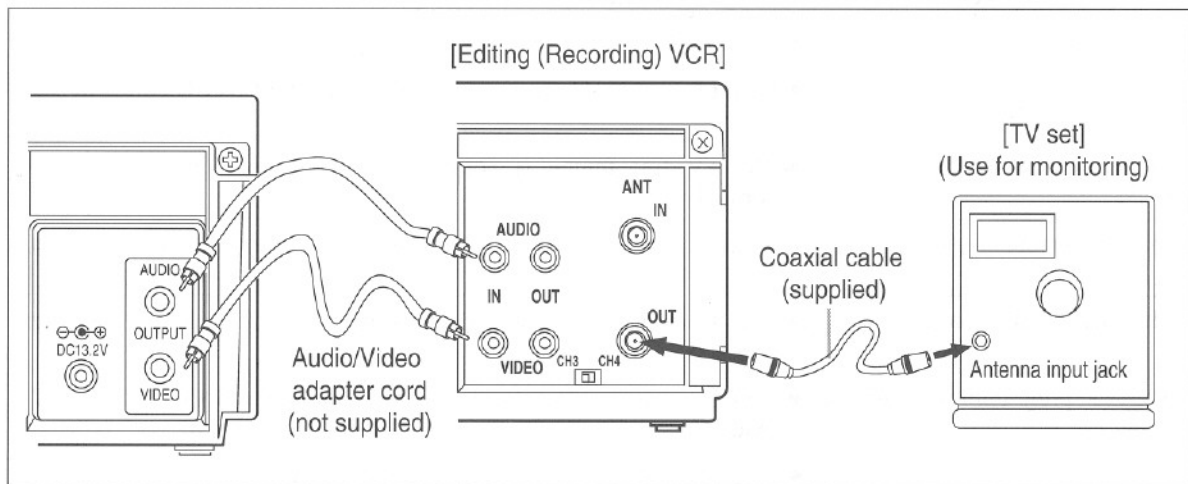

1

Insert a pre-recorded video cassette into the source(playing) VCR.

2

Insert a blank video cassette, or one you want to record over, into the editing(recording) VCR cassette compartment.

3

Press the TAPE SPEED button on the editing(recording) VCR to select the desired recording speed (SP/LP/SLP).

4

Press the RECORD button on the editing (recording) VCR.

5

Begin playback of the tape in the source(playing) VCR.

NOTES:

- For best results during dubbing, use the VCR's front panel controls whenever possible. The remote control might affect the playback VCR's operation.
- Always use video-quality shielded cables with RCA-type connectors. Standard audio cables are not recommended.

TO MONITOR THE RECORDING

- 1) Turn on the TV, and set it to the same output channel as the editing(recording) VCR channel 3 or 4.
- 2) Press TV/VCR button on the editing(recording) VCR so that the VCR position is selected.

TROUBLESHOOTING GUIDE

If you have followed the instructions contained in this manual and have difficulty in operating the VCP, locate the SYMPTOM in the left column below. Check the corresponding POSSIBLE CAUSE and CORRECTIVE ACTION columns to remedy the problem.

SYMPTOM	POSSIBLE CAUSE	CORRECTIVE ACTION
No power.	• Power cable is not connected.	• Connect power cable to AC outlet.
	• Power is turned off.	• Press the POWER button to turn on.
No picture or poor picture on playback.	• The TV fine tuning is not set correctly.	• Fine tune your TV.
Noise in picture on playback.	• Video heads are dirty.	• Head cleaning is necessary, consult the service center.
Playback picture is partially noisy.	• The Tracking control is not set correctly.	• Adjust Tracking control for better picture.
The TV programmes cannot be seen.	• Connections are not correctly made.	• Re-check the ANT-IN and ANT-OUT connections.
	• The VCP power is on.	• Turn off the VCP.
No operation by the remote control.	• Weak battery.	• Check the batteries of the remote control.
Power indicator flashes.	• The dew sensor is on.	• Refer to page 4 "DEW WARNING".

MAINTENANCE

SERVICING

Should the VCP become inoperative, do not try to correct the problem by yourself. There are no user-serviceable parts inside. Turn off, unplug the power cord, and take the unit to a Funai Authorized Service Center for servicing.

CABINET CLEANING

- Wipe the front panel and other exterior surfaces of the VCP with a soft cloth immersed in lukewarm water and wrung dry.
- Never use a solvent or alcohol. Do not spray insecticide liquid near the VCP. Such chemicals may cause damage and discoloration to the exposed surfaces.

AUTO HEAD CLEANING

- Automatically cleans heads as you insert or remove a cassette, so you can see the clear picture.
- Playback picture may become blurred or interrupted while the TV program reception is clear. Dirt accumulated on the video heads after long periods of use, or the usage of rental or worn tapes can cause this problem.

If a streaky or snowy picture appears during playback, the heads of the VCP may need to be cleaned.

1. Please visit your local Audio/Video store and purchase a good quality VHS Video Head Cleaner.
2. If a Video Head Cleaner does not solve the problem, consult the nearest Funai Authorized Service Center. Professional video head cleaning requires highly technical attention.

NOTES:

- Remember to read the instructions included with the head cleaner before use.
- Clean heads only when problems occur.

SPECIFICATIONS

GENERAL SPECIFICATIONS

Television system :	NTSC, TV standard
Video heads :	Rotary two-head
Tape width :	1/2inch (12.65mm)
Tape speed	
SP :	33.35mm/sec.
LP :	16.67mm/sec.
SLP :	11.12mm/sec.
RF converter :	Built-in VHF converter
Converter output :	VHF Channel 3 or 4
Operating temperature :	5°C~40°C (41°F~104°F)
Terminals	
Antenna input :	F type connector × 1
Antenna output :	F type connector × 1
Video output :	RCA connector × 1
Audio output :	RCA connector × 1
DC input :	DC Power jack × 1

ELECTRICAL SPECIFICATIONS

Video output level :	1Vp-p
Video output impedance :	75Ω
Audio output level :	-6dBv (1KΩ)
Video S/N ratio	
SP:	More than 45dB
Audio S/N ratio	
SP :	More than 40dB

OTHER SPECIFICATIONS

Power requirement :	AC 120V/60Hz DC 13.2V
Power consumption :	AC 14W DC 12W
Dimensions :	W 14-1/4" (360mm) H 3-5/8" (92mm) D 9-1/16" (230mm)
Weight :	5.95 lbs. (2.7 Kg.) (approx.)

- Designs and specifications are subject to change without notice and without our legal obligation.

FUNAI CORPORATION

LIMITED WARRANTY

FUNAI CORP. will repair this product, free of charge in the USA in the event of defect in materials or workmanship as follows:

DURATION:

PARTS: FUNAI CORP. will provide parts to replace defective parts without charge for one (1) year from the date of original retail purchase. Two (2) years for Picture Tube. Certain parts are excluded from this warranty.

LABOR: FUNAI CORP. will provide the labor without charge for a period of ninety (90) days from the date of original retail purchase.

LIMITS AND EXCLUSIONS:

This warranty is extended only to the original retail purchaser. A purchase receipt or other proof of original retail purchase will be required together with the product to obtain service under this warranty.

This warranty shall not be extended to any other person or transferee.

This warranty is void and of no effect if any serial numbers on the product are altered, replaced, defaced or missing. This FUNAI CORPORATION Limited warranty does not apply to any the product not purchased and used in the United States.

This warranty only covers failures due to defects in material or workmanship which occur during normal use. It does not cover damage which occurs in shipment, or failures which are caused by repairs, alterations or product not supplied by FUNAI CORP., or damage which results from accident, misuse, abuse, mishandling, misapplication, alteration, faulty installation, improper maintenance, commercial use such as hotel, rental or office use of this product or damage which results from fire, flood, lightning or other acts of God.

THIS WARRANTY DOES NOT COVER PACKING MATERIALS, ANY ACCESSORIES (EXCEPT REMOTE CONTROL), ANY COSMETIC PARTS, COMPLETE ASSEMBLY PARTS, DEMO OR FLOOR MODELS.

FUNAI CORP. AND ITS REPRESENTATIVES OR AGENTS SHALL IN NO EVENT BE LIABLE FOR ANY GENERAL, INDIRECT OR CONSEQUENTIAL DAMAGES ARISING OUT OF OR OCCASIONED BY THE USE OF OR THE INABILITY TO USE THIS PRODUCT. THIS WARRANTY IS MADE IN LIEU OF ALL OTHER WARRANTIES, EXPRESS OR IMPLIED, AND OF ALL OTHER LIABILITIES ON THE PART OF FUNAI, ALL OTHER WARRANTIES INCLUDING THE WARRANTY OF MERCHANTABILITY, AND FITNESS FOR A PARTICULAR PURPOSE, ARE HEREBY DISCLAIMED BY FUNAI AND ITS REPRESENTATIVES IN THE UNITED STATES. ALL WARRANTY INSPECTIONS AND REPAIRS MUST BE PERFORMED BY FUNAI AUTHORIZED SERVICE CENTER. THIS WARRANTY IS VALID WHEN THE UNIT IS CARRIED-IN TO FUNAI AUTHORIZED SERVICE FACILITY.

WHEN YOU ARE RETURNING THE PRODUCT FOR SERVICE TO THE FACTORY SERVICE CENTER, PLEASE CONTACT THE FUNAI SERVICE DEPARTMENT TO RECEIVE A R.A. (REPAIR AUTHORIZATION) NUMBER PRIOR TO SHIPPING. ANY POSTAGE, INSURANCE AND SHIPPING COST, INCURRED IN PRESENTING OR SENDING YOUR FUNAI/SYMPHONIC PRODUCT FOR SERVICE ARE SHIPPER'S RESPONSIBILITY.

CAREFULLY PACK WITH PROPER PACKING MATERIALS, PREFERABLY IN THE ORIGINAL CARTON.

ATTACH WRITTEN DOCUMENTATION DETAILING THE COMPLAINT, TO THE OUTSIDE OR INSIDE OF THE CARTON.

THE PRODUCT MUST BE ACCOMPANIED BY A COPY OF THE ORIGINAL RETAIL PURCHASE RECEIPT. IF NO PROOF OF PURCHASE IS ATTACHED, THE WARRANTY WILL NOT BE HONORED AND REPAIRS COSTS WILL BE CHARGED.

IMPORTANT:

THIS LIMITED WARRANTY GIVES YOU SPECIFIC LEGAL RIGHTS. YOU MAY HAVE OTHER RIGHTS THAT VARY FROM STATE TO STATE, IF, AT ANY TIME DURING THE WARRANTY PERIOD, YOU ARE UNABLE TO OBTAIN SATISFACTION WITH THE REPAIR OF THIS PRODUCT, PLEASE CONTACT FUNAI CORP.

ATTENTION:

FUNAI CORP. RESERVES THE RIGHT TO MODIFY ANY DESIGN OF THIS PRODUCT WITHOUT PRIOR NOTICE.

For information of your nearest FUNAI Authorized Service Center or general service procedure, please call or write to the following:

FUNAI CORPORATION
Factory Service Center
100 North Street; Teterboro, NJ 07608
Tel :1-800-242-7158
(Eastern Time 9:00 AM - 4:30 PM / Monday - Friday)

Free Manuals Download Website

<http://myh66.com>

<http://usermanuals.us>

<http://www.somanuals.com>

<http://www.4manuals.cc>

<http://www.manual-lib.com>

<http://www.404manual.com>

<http://www.luxmanual.com>

<http://aubethermostatmanual.com>

Golf course search by state

<http://golfingnear.com>

Email search by domain

<http://emailbydomain.com>

Auto manuals search

<http://auto.somanuals.com>

TV manuals search

<http://tv.somanuals.com>