

## MF/HF

MF/HF Radiotelephone



Models:  
**FS-1575** (150 W)  
**FS-2575** (250 W)  
**FS-5075** (500 W)

# Reliable MF/HF Radiotelephone for general and distress communications with integrated DSC/DSC Watch Receiver



Models: FS-1575 (150 W)  
FS-2575 (250 W)  
FS-5075 (500 W)

- ▶ MF/HF radiotelephone with DSC facility
- ▶ Fully meets GMDSS carriage requirements for SOLAS ships operating in A2, A3 and A4 sea areas
- ▶ Meets the new ITU recommendation on digital selective calling system for use in the Maritime Mobile Service, ITU-R M.493-13
- ▶ High-contrast 4.3" bright color LCD (480x272 pixels)
- ▶ Capable of distress, safety and routine communication
- ▶ Instant selection of 256 user-specified channels with a rotary knob or direct keypad input
- ▶ Quick access to DSC message composition by dedicated keys on the control unit
- ▶ Full-duplex kit available (optional supply for the FS-5075 only)
- ▶ Quick access to dedicated functions in the menu operation using numeric keypad

# High-contrast 4.3" bright color LCD

## Display Modes

### Radiotelephone display

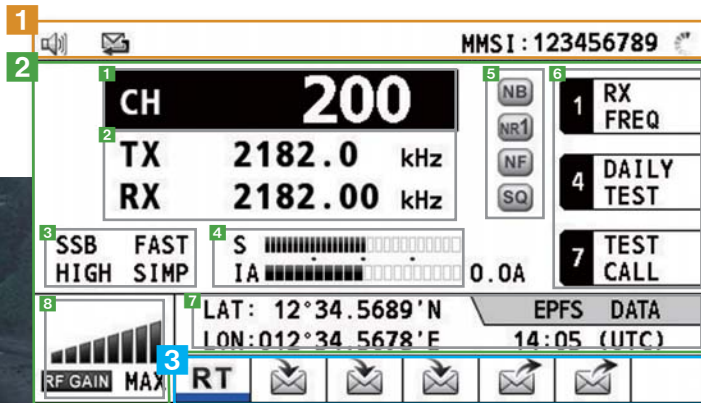

### DSC SCAN display

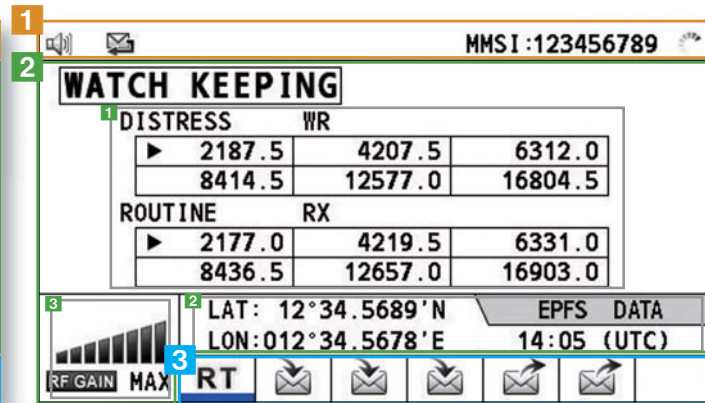

### 1 Status segment

Indicating the status of equipment, i.e., speaker ON/OFF, unread DSC message in the inbox, hardware error, etc. Also, MMSI is shown in radiotelephone and DSC scan displays.

### 2 Information segment

Displaying:

- 1 user channel selected
- 2 operating frequencies
- 3 class of emission, AGC, output power and communication mode
- 4 signal strength, meter reading (IC, VC, RF, VS and IA (antenna current))
- 5 currently activated functions, i.e., noise blanker, etc.
- 6 short-cut functions assigned for 1, 4 and 7 on the numeric keypad
- 7 own ship L/L, Time
- 8 indications of RF input attenuator ON/OFF as well as RF gain

### 2 Information segment

Displaying:

- 1 DSC watch frequencies (both distress and routine)
- 2 own ship L/L, Time
- 3 indications of RF input attenuator ON/OFF as well as RF gain

### 3 Tab segment

Up to 7 active procedures can be displayed in this segment. The procedures are for operating: radiotelephone, distress alert transmission, general DSC message transmission and general DSC message reception.

### Quick-access functions



On the menu setting, three quick-access functions can be assigned for 1, 4 and 7 on the numeric keypad, and those assigned functions are displayed on the Radiotelephone display. The list of functions assigned for quick-access includes: TX frequency setting, RX frequency setting, class of emission setting, AGC setting, output power setting, TX frequency monitoring, showing the list of test messages, showing the list of message files, execution of daily test, showing the list of log files, and intercom functions.

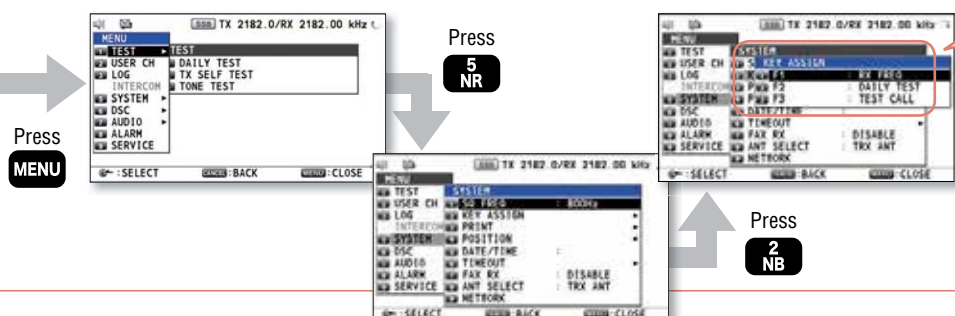



## DSC display

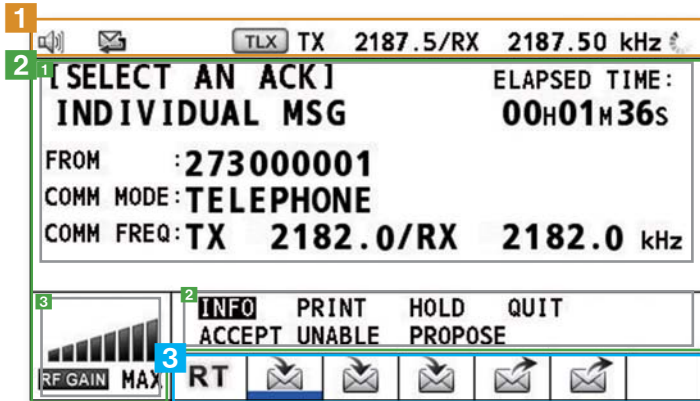

## Menu display

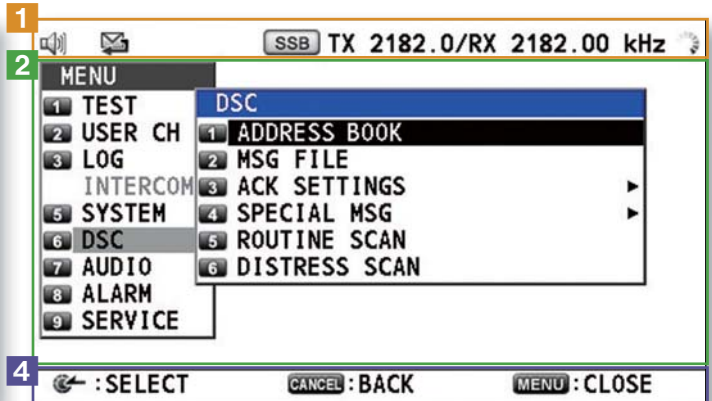

### 1 Status segment

Indicating status of equipment, i.e., speaker ON/OFF, unread DSC message in the inbox, hardware error, etc., TX/RX frequencies/class of emission for successive communication.

### 2 Information segment

Displaying:

- 1 DSC contents, status and information
- 2 a list of available operator actions
- 3 indications of RF input attenuator ON/OFF as well as RF gain

### 2 Information segment

Displaying menu tree

### 4 Guide segment

Guide to short-cut key functions is displayed.

mission, distress alert reception,

KEY ASSIGN	
1 F1	: RX FREQ
2 F2	: DAILY TEST
3 F3	: TEST CALL



F1, F2 and F3 on the menu represent the functions assigned for 1, 4 and 7 on the numeric keypad, respectively.

Press

**1**



### Night Mode

Night mode is selectable for wheelhouse operation.

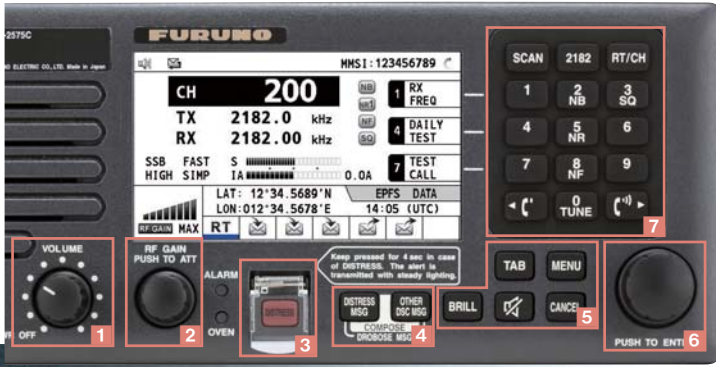

# Control Panel

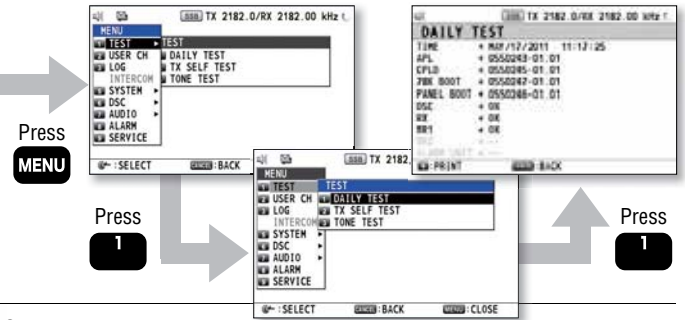

## Simplified menu operation

Numbers are assigned for each of the menu items, and the operator can access each of the menu items either by turning and pressing PUSH TO ENTER knob to select menu items or simply pressing number on the numeric keypad.



1	Volume/Power knob :	Sound volume control/Switching of Power ON/OFF
2	RF GAIN knob :	Adjustment of reception gain
	PUSH TO ATT :	Press to activate/deactivate RF attenuator
3	<b>DISTRESS</b> :	Long-press to transmit a DSC distress alert
4	<b>DISTRESS MSG</b> :	Composition of DSC message for distress alert
	<b>OTHER DSC MSG</b> :	Composition of DSC message except for distress alert and DROBOSE (DSC relay on behalf of someone*)
	Press <b>DISTRESS MSG</b> + <b>OTHER DSC MSG</b> :	Composition of DSC message for DROBOSE
5	<b>BRILL</b> :	Activation of the brilliance control dialog box
	<b>TAB</b> :	Activation of tab segment control on the screen
	<b>MENU</b> :	Opening/closing of the menu dialog box
	<b>CANCEL</b> :	Deactivates alarm/deletion of error and pop-up messages/halting of DSC message composition/exiting from the message composition dialog box/distress cancellation/returning to a previous menu level
	 :	Switching the speaker ON/OFF
6	PUSH TO ENTER knob :	Shifts the selector and pointer/adjusts the degree of parameter, i.e., brilliance and switch over the display mode
		Press to confirm the entered values
7	<b>SCAN</b> :	Switches to the DSC SCAN mode/if pressed during the DSC SCAN mode, routine scan will be halted
	<b>2182</b> :	Sets to 2182 kHz SSB
	<b>RT/CH</b> :	Switches to radiotelephone mode, and if pressed in radiotelephone mode, channel setting box will be summoned
	<b>1</b> :	Used to enter the following number and symbols (. @ - _ / : 1) as well as quick access to short cut function
	<b>2 NB</b> :	Used to enter A, B, C and 2, and to switch noise blanker setting ON/OFF
	<b>3 SQ</b> :	Used to enter D, E, F and 3, and to switch squelch setting ON/OFF
	<b>4</b> :	Used to enter G, H, I and 4 as well as quick access to short cut function
	<b>5 NR</b> :	Used to enter J, K, L and 5, and to switch noise reduction setting ON/OFF
	<b>6</b> :	Used to enter M, N, O and 6
	<b>7</b> :	Used to enter P, Q, R, S and 7 as well as quick access to short cut function
	<b>8 NF</b> :	Used to enter T, U, V and 8, and to switch notch filter ON/OFF
	<b>9</b> :	Used to enter W, X, Y, Z and 9
	 :	Used to reduce the receiver volume of the handset/to shift the pointer in channel/frequency selection dialog box
	<b>0 TUNE</b> :	Used to enter the number "0", space and the following symbols (! " # \$ % & ' ( ) * + , - . / : ; < = > ? @ [ \ ] ^ _ ` { } ~) / to tune impedance between an antenna and a transceiver
	 :	Used to raise the receiver volume of the handset/to shift the pointer in channel/frequency selection dialog box

\* composition and relay of the occurrence of a distress event obtained by non-DSC means

# SPECIFICATIONS

MODEL	FS-1575	FS-2575	FS-5075
<b>PRODUCT NAME</b>	SSB RADIOTELEPHONE		

## GENERAL CHARACTERISTICS

Rules and Regulations	ITU-R M.1082-1, ITU-R M.1173, ITU-R M.476-5, ITU-R M.490, ITU-R M.491-1, ITU-R M.492-6, ITU-R M.493-13, ITU-R M.541-9, ITU-R M.625-3, ITU-R M.821-1, IMO Res. A.694(17), IMO Res. A.806(19), IMO Res. MSC36 (63), IMO Res. MSC 68 (68), MSC/Circ. 862, IEC 61162-1 Ed. 4, IEC60945 Ed. 4, ETS 300 067 ed. 1, EN 300 338-1 V1.3.1, EN 300 338-2 V1.3.1, EN 301 033 V1.3.1, EN 300 373-1 V1.3.1		
Frequency Range	TX: RX:	1605.0kHz to 27500.0kHz 100kHz to 29999.99kHz	
Number of Channels	256 user-specified channels plus ITU, SSB/TELEX channels		
Communication Mode	Simplex/Semi-duplex		Simplex/Semi-duplex/Duplex (option)
Class of Emission	J3E, H3E, A1A, J2B		

## TRANSCIVER

RF Output Power	150 W pep	250 W pep	500 W pep (HF) / 400 W pep (MF)
Antenna	10-18 m whip or wire		
Tuning Speed	within 15 sec		
Receiver Sensitivity	less than +7 dBμV (4.0-29.99999 MHz, J3E) / less than +13 dBμV (1.6-4 MHz, J3E)		

## DSC

Receiving Frequency	General Distress and safety	All DSC frequencies in MF/HF DSC distress/safety frequencies: 2187.5 kHz, 4207.5 kHz, 6312.0 kHz, 8414.5 kHz, 12577.0 kHz, 16804.5 kHz	
Message Storage	TX: RX:	50 distress messages, plus 50 non-distress messages 50 messages, telephone no., frequencies, etc.	

## POWER SUPPLY

	24 VDC, 100/110/120/200/220/240 VAC with optional AC/DC Power Supply PR-850A (FS-2575/5075) / PR-300 (FS-1575)		
	20 A (TX), 5.0 A (RX)	40 A (TX), 5.0 A (RX)	60 A (TX), 5.0 A (RX)

## EQUIPMENT LIST

Standard	Quantity	Equipment	Quantity
1 Transceiver Unit	1	FS-1575T (FS-1575), FS-2575T (FS-2575), FS-5075T (FS-5075)	1 Unit
2 Control Unit	1	FS-2575C	1 Unit
3 Handset	1	HS-2003	1 Unit
4 Antenna Coupler	1	AT-5075 (FS-2575/5075) AT-1575 (FS-1575)	1 Unit
<b>Option</b>			
1 Printer		PP-520	
2 Printer Interface		IF-8500	
3 External Speaker		SEM-21Q	
4 Control Unit		FS-2575C	
5 NBDP Terminal Unit		IB-585	
6 BK Interface		BK-300	
7 Whip Antenna			
8 AC/DC Power Supply		PR-850A (FS-2575/5075) PR-300 (FS-1575)	
9 Full Duplex Kit (for FS-5075)		OP05-125	
10 Matching Box		ARD-1	
11 Preamp		FAX-5	
12 WR2 kit		OP05-123	

## INTERCONNECTION DIAGRAM

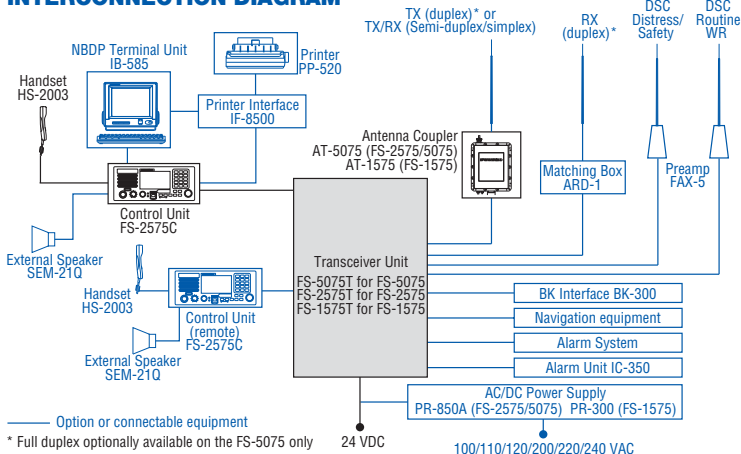

## CONTROL UNIT

### FS-2575C

1.9 kg 4.2 lb

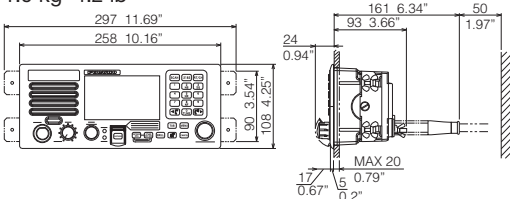

## ANTENNA COUPLER

### AT-5075

8.5 kg 18.7 lb

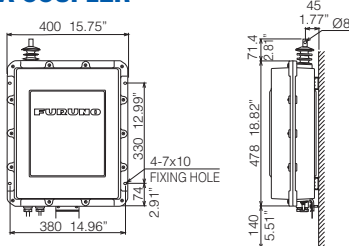

### AT-1575

2.6 kg 5.7 lb

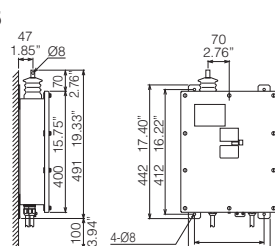

## TRANSCIVER UNIT

### FS-5075T

27 kg 59.5 lb

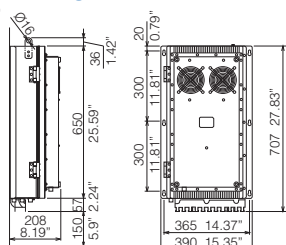

### FS-2575T

20 kg 44.1 lb

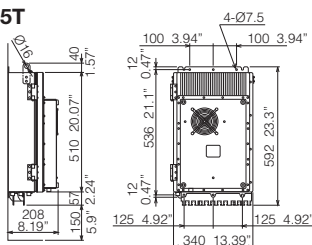

### FS-1575T

16 kg 35.3 lb

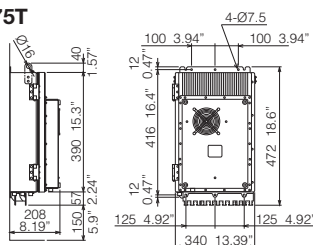

## HANDSET

### HS-2003

0.5 kg 1.2 lb

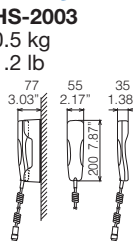

All brand and product names are registered trademarks, trademarks or service marks of their respective holders.  
SPECIFICATIONS SUBJECT TO CHANGE WITHOUT NOTICE

**FURUNO ELECTRIC CO., LTD.**  
Nishinomiya, Hyogo, Japan  
www.furuno.com

**FURUNO U.S.A., INC.**  
Camas, Washington, U.S.A.  
www.furuno.com

**FURUNO (UK) LIMITED**  
Havant, Hampshire, U.K.  
www.furuno.co.uk

**FURUNO NORGE A/S**  
Ålesund, Norway  
www.furuno.no

**FURUNO DANMARK A/S**  
Hvidovre, Denmark  
www.furuno.dk

**FURUNO SVERIGE AB**  
Västra Frölunda, Sweden  
www.furuno.se

**FURUNO FINLAND OY**  
Espoo, Finland  
www.furuno.fi

**FURUNO POLSKA Sp. z o.o.**  
Gdynia, Poland  
www.furuno.pl

**FURUNO DEUTSCHLAND GmbH**  
Rellingen, Germany  
www.furuno.de

**FURUNO FRANCE S.A.S.**  
Bordeaux-Mérignac, France  
www.furuno.fr

**FURUNO ESPAÑA S.A.**  
Madrid, Spain  
www.furuno.es

**FURUNO ITALIA S.r.l.**  
Genoa, Italy

**FURUNO HELLAS S.A.**  
Glyfada, Greece  
www.furuno.gr

**FURUNO (CYPRUS) LTD**  
Limassol, Cyprus  
www.furuno.com.cy

**FURUNO EURUS LLC**  
St. Petersburg, Russian Federation  
www.furuno.com.ru

**FURUNO SHANGHAI CO., LTD.**  
Shanghai, China

**FURUNO KOREA CO., LTD.**  
Busan, Korea

**RICO (PTE) LTD**  
Singapore  
www.rico.com.sg

14073SK Printed in Japan  
Catalogue No. S-025b

## Free Manuals Download Website

<http://myh66.com>

<http://usermanuals.us>

<http://www.somanuals.com>

<http://www.4manuals.cc>

<http://www.manual-lib.com>

<http://www.404manual.com>

<http://www.luxmanual.com>

<http://aubethermostatmanual.com>

Golf course search by state

<http://golfingnear.com>

Email search by domain

<http://emailbydomain.com>

Auto manuals search

<http://auto.somanuals.com>

TV manuals search

<http://tv.somanuals.com>